

# Design Manual

M 22-01

***English***



**Washington State Department of Transportation**  
Environmental and Engineering Service Center  
Design Office



Persons with disabilities may request this information  
be prepared and supplied in alternate forms by  
calling collect 360-664-9009;  
deaf and hearing impaired people call  
1-800-833-6388 (TTY relay service).

Washington State Department of Transportation  
Engineering Publications  
Transportation Building  
Olympia, WA 98504-7400  
Phone: 360-705-7430  
Fax: 360-705-6861  
E-mail: [lovem@wsdot.wa.gov](mailto:lovem@wsdot.wa.gov)

## **Foreword**

---

This highway *Design Manual* has been prepared as a guide for our engineering personnel. It provides policies, procedures, and methods for developing and documenting the design of improvements to the transportation network in Washington State.

The manual is to supplement the engineering analysis and judgment that must be applied to both new highway construction and reconstruction of specific features of existing highways. It is also intended to provide uniform procedures for implementing design decisions and to assure continuity of the quality of highways throughout the state. It is recognized that the practices suggested in this manual, because of fiscal limitations or other reasons, have been or will be inappropriate for some projects.

Updating the manual is a continuing process and revisions are issued periodically. Questions, observations, and recommendations are invited. The next page is provided to encourage comments and assure their prompt delivery. Use copies of it to transmit comments and attachments, such as marked copies of manual pages. For clarification of the content of the manual, contact the Design Office in the Olympia Service Center.

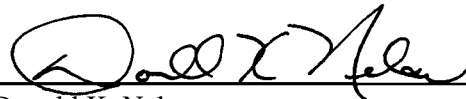

---

Donald K. Nelson  
State Design Engineer

3:P:DM

# Comment Form |

From: \_\_\_\_\_  
\_\_\_\_\_  
\_\_\_\_\_

Date: \_\_\_\_\_  
Phone: \_\_\_\_\_

To: WSDOT ([DesignManual@wsdot.wa.gov](mailto:DesignManual@wsdot.wa.gov))  
Olympia Service Center, Design Office  
Mail Stop 47329  
PO Box 47329  
Olympia, WA 98504-7329

Subject: *Design Manual* Comment

Comment (marked copies attached):

**Preserve this original for future use • Submit copies only**

# Contents

---

		<b>Date</b>
<b>Division 1</b>	<b>General Information</b>	
100	Manual Description	September 1992
	100.01 Purpose	
	100.02 Revisions	
110	Nomenclature and References	October 1993
	110.01 Abbreviations	
	110.02 References	
120	Planning	May 2000
	120.01 General	
	120.02 References	
	120.03 Definitions	
	120.04 Legislation and Policy Development	
	120.05 Planning at WSDOT	
	120.06 Linking Transportation Plans	
	120.07 Linking WSDOT Planning to Programming	
130	Systems Data and Services	June 1989
	130.01 Highway Performance Monitoring System	
	130.02 Travel Data and Traffic Analysis	
	130.03 Videologging	
	130.04 Photogrammetry Services	
140	Program Development and Federal Aid Financing	June 1989
	140.01 General	
	140.02 Federal Aid Financing	
160	General	June 1989
	160.01 Design Principles	
	160.02 Design Standards	
	160.03 Design Items	
<b>Division 2</b>	<b>Hearings, Environmental, and Permits</b>	
210	Public Involvement and Hearings	December 1998
	210.01 General	
	210.02 References	
	210.03 Definitions	
	210.04 Public Involvement	
	210.05 Hearings	
	210.06 Environmental Hearing	
	210.07 Corridor Hearing	
	210.08 Design Hearing	
	210.09 Access Hearing	
	210.10 Combined Hearings	
	210.11 Administrative Appeal Hearing	
	210.12 Documentation	

		<b>Date</b>
220	Project Environmental Documentation	June 1989
	220.01 General	
	220.02 Definitions	
	220.03 Project Classification	
	220.04 Class I, EIS	
	220.05 Class II, CE	
	220.06 Class III, EA/Checklist	
	220.07 Project Reevaluation	
	220.08 Project Reviews	
240	Permits and Approvals From Other Governmental Agencies	September 1990
	240.01 General	(240-13 and 14 June 1989)
	240.02 United States Department of the Army-Corps of Engineers	
	240.03 United States Coast Guard	
	240.04 United States Forest Service	
	240.05 Federal Aviation Administration	
	240.06 FHWA — Western Federal Lands Highway Division	
	240.07 Federal Energy Regulatory Commission	
	240.08 Environmental Protection Agency	
	240.09 Washington State Departments of Fisheries and Wildlife	
	240.10 Washington State Department of Ecology	
	240.11 Washington State Department of Natural Resources	
	240.12 Washington State Department of Labor and Industries	
	240.13 Local Agencies	
	240.14 Utility Agreements	

### **Division 3 Project Documentation**

310	Preliminary Studies	June 1989
	310.01 General	
	310.02 Legislative Studies	
	310.03 Route/Design Studies	
315	Value Engineering	August 1998
	315.01 General	
	315.02 References	
	315.03 Definitions	
	315.04 Procedure	
	315.05 Documentation	
325	Design Matrix Procedures	June 1999
	325.01 General	(325-3 August 1998)
	325.02 Terminology	(325-4 May 2000)
	325.03 Design Matrix Procedures	(325-5 through 8 August 1998)
	325.04 Selecting a Design Matrix	(325-9 through 15 May 2000)
	325.05 Project Type	
	325.06 Using a Design Matrix	

		<b>Date</b>
330	Design Documentation, Approval, and Process Review	June 1999
330.01	General	(330-1 November 1999)
330.02	References	(330-2 June 1999)
330.03	Purpose	(330-3 and 4 May 2000)
330.04	Project Development	(330-5 through 9 June 1999)
330.05	Project Definition Phase	(330-10 through 17 August 1998)
330.06	Design Documentation	
330.07	Design Approval	
330.08	Process Review	

## **Division 4 Project Design Criteria**

410	Basic Design Level	August 1998
410.01	General	
410.02	Required Safety Items of Work	
410.03	Minor Safety and Minor Preservation Work	
430	Modified Design Level	(430-1 through 5 May 2000)
430.01	General	(430-6 November 1997)
430.02	Design Speed	(430-7 April 1998)
430.03	Roadway Widths	(430-8 through 10 November 1997)
430.04	Ramp Lane Widths	
430.05	Stopping Sight Distance	
430.06	Profile Grades	
430.07	Cross Slope	
430.08	Fill Slopes and Ditch Inslopes	
430.09	Intersections	
430.10	Bridges	
430.11	Documentation	
440	Full Design Level	December 1998
440.01	General	(440-9 and 11 May 2000)
440.02	References	(440-10 November 1999)
440.03	Definitions	
440.04	Functional Classification	
440.05	Terrain Classification	
440.06	Geometric Design Data	
440.07	Design Speed	
440.08	Traffic Lanes	
440.09	Shoulders	
440.10	Medians	
440.11	Parking	
440.12	Pavement Type	
440.13	Structure Width	
440.14	Grades	

**Division 5 Soils and Paving**

510	Investigation of Soils and Surfacing Materials	November 1999
510.01	General	
510.02	References	
510.03	Materials Sources	
510.04	Geotechnical Investigation, Design, and Reporting	
510.05	Use of Geotechnical Consultants	
510.06	Geotechnical Work by Others	
510.07	Surfacing Report	
510.08	Documentation	
520	Design of Pavement Structure	April 1998
520.01	Introduction	(520-2 and 3 November 1999)
520.02	Estimating Tables	
530	Geosynthetics	April 1998
530.01	General	(530-13 November 1999)
530.02	References	
530.03	Geosynthetic Types and Characteristics	
530.04	Geosynthetic Function Definitions and Applications	
530.05	Design Approach for Geosynthetics	
530.06	Design Responsibility	
530.07	Documentation	

**Division 6 Geometrics**

610	Highway Capacity	June 1989
610.01	General	
610.02	Definitions and Symbols	
610.03	Design	
620	Geometric Plan Elements	April 1998
620.01	General	(620-1 and 4 November 1999)
620.02	References	
620.03	Definitions	
620.04	Horizontal Alignment	
620.05	Distribution Facilities	
620.06	Number of Lanes and Arrangement	
620.07	Pavement Transitions	
620.08	Procedures	
620.09	Documentation	
630	Geometric Profile Elements	April 1998
630.01	General	(630-2 May 2000)
630.02	References	
630.03	Vertical Alignment	
630.04	Coordination of Vertical and Horizontal Alignments	
630.05	Airport Clearance	
630.06	Railroad Crossings	
630.07	Procedures	
630.08	Documentation	



		<b>Date</b>
640	Geometric Cross Section	December 1998
640.01	General	(640-3 and 6 May 2000)
640.02	References	(640-17, 25, 35 through 37, and 39 May 2000)
640.03	Definitions	(640-22, 28, 29, 31, and 32 June 1999)
640.04	Roadways	(640-30, 33, and 34 November 1999)
640.05	Superelevation	
640.06	Medians and Outer Separations	
640.07	Roadsides	
640.08	Roadway Sections	
640.09	Documentation	
650	Sight Distance	April 1998
650.01	General	(650-3 June 1999)
650.02	References	(650-4 November 1999)
650.03	Definitions	(650-8 and 9 May 2000)
650.04	Passing Sight Distance	
650.05	Stopping Sight Distance	
650.06	Decision Sight Distance	

## **Division 7 Roadside Safety Elements**

700	Roadside Safety	August 1997
700.01	General	(700-3 April 1998)
700.02	References	(700-8 June 1999)
700.03	Definitions	
700.04	Clear Zone	
700.05	Hazards to be Considered for Mitigation	
700.06	Median Considerations	
700.07	Other Roadside Safety Features	
700.08	Documentation	
710	Traffic Barriers	May 2000
710.01	General	
710.02	References	
710.03	Definitions	
710.04	Project Requirements	
710.05	Barrier Design	
710.06	Beam Guardrail	
710.07	Cable Barrier	
710.08	Concrete Barrier	
710.09	Special Use Barriers	
710.10	Redirectional Land Forms	
710.11	Bridge Rails	
710.12	Other Barriers	
710.13	Documentation	
720	Impact Attenuator Systems	June 1999
720.01	Impact Attenuator Systems	
720.02	Design Criteria	
720.03	Selection	
720.04	Documentation	

**Division 8 Traffic Safety Elements**

810	Construction Work Zone Traffic Control Strategy	December 1994
	810.01 General	
	810.02 References	
	810.03 Definitions	
	810.04 Construction Work Zone Traffic Control Strategy	
	810.05 Procedures	
820	Signing	November 1999
	820.01 General	
	820.02 References	
	820.03 Design Components	
	820.04 Overhead Installation	
	820.05 Mileposts	
	820.06 Guide Sign Plan	
	820.07 Documentation	
830	Delineation	May 2000
	830.01 General	
	830.02 References	
	830.03 Pavement Markings	
	830.04 Guide Posts	
	830.05 Barrier Delineation	
	830.06 Wildlife Warning Reflectors	
	830.07 Documentation	
840	Illumination	May 2000
	840.01 General	
	840.02 References	
	840.03 Definitions	
	840.04 Required Illumination	
	840.05 Additional Illumination	
	840.06 Design Criteria	
	840.07 Documentation	
850	Traffic Control Signals	June 1989
	850.01 General	(850-1 September 1990)
	850.02 Policy	(850-13, 16 through 21, 29 through 38 March 1994)
	850.03 Approval Requirements	
	850.04 Signal Design	
	850.05 Contract Preparation	
860	Intelligent Transportation Systems	November 1999
	860.01 General	
	860.02 References	
	860.03 Traffic Data Collection	
	860.04 Traffic Flow Control	
	860.05 Motorist Information	
	860.06 Documentation	

**Division 9 Interchanges and Intersections**

910	Intersections at Grade	August 1997
910.01	General	(910-1 through 3 August 1998)
910.02	References	(910-17 through 19 November 1999)
910.03	Definitions	(910-21 through 24 November 1999)
910.04	Design Considerations	(910-21 and 25 April 1998)
910.05	Design Vehicle	(910-26 December 1998)
910.06	Right-Turn Corners	(910-33, 34, and 36 November 1999)
910.07	Channelization	
910.08	Roundabouts	
910.09	U-turns	
910.10	Sight Distance at Intersections	
910.11	Traffic Control at Intersections	
910.12	Interchange Ramp Terminals	
910.13	Procedures	
910.14	Documentation	
920	Road Approaches	April 1998
920.01	General	(920-5, 6, 8, and 9 November 1999)
920.02	References	
920.03	Definitions	
920.04	Design Considerations	
920.05	Road Approach Connection Category	
920.06	Road Approach Design Template	
920.07	Sight Distance	
920.08	Road Approach Spacing and Corner Clearance	
920.09	Drainage Requirements	
920.10	Procedures	
920.11	Documentation	
930	Railroad Grade Crossings	June 1989
930.01	General	(930-4, 6 through 12 March 1994)
930.02	References	
930.03	Plans	
930.04	Traffic Control Systems	
930.05	Stopping Lanes	
930.06	Types of Crossing Surfaces	
930.07	Crossing Closure	
930.08	Traffic Controls During Construction and Maintenance	
930.09	Railroad Grade Crossing Orders	
930.10	Longitudinal Easements From Railroad	

		<b>Date</b>
940	Traffic Interchanges	June 1999
940.01	General	(940-5 through 7 May 2000)
940.02	References	(940-10 November 1999)
940.03	Definitions	(940-15, 17 through 20 May 2000)
940.04	Interchange Design	(940-23 through 32 May 2000)
940.05	Ramps	
940.06	Interchange Connections	
940.07	Ramp Terminal Intersections at Crossroads	
940.08	Interchanges on Two-Lane Highways	
940.09	Interchange Plans	
940.10	Documentation	
960	Median Crossovers	August 1997
960.01	General	
960.02	Analysis	
960.03	Design	
960.04	Approval	
960.05	Documentation	

## **Division 10 Auxiliary Facilities**

1010	Auxiliary Lanes	November 1999
1010.01	General	
1010.02	References	
1010.03	Definitions	
1010.04	Climbing Lanes	
1010.05	Passing Lanes	
1010.06	Slow Moving Vehicle Turnouts	
1010.07	Shoulder Driving for Slow Vehicles	
1010.08	Emergency Escape Ramps	
1010.09	Chain-Up Areas	
1010.10	Documentation	
1020	Facilities for Nonmotorized Transportation	June 1989
1020.01	General	(1020-6 March 1991)
1020.02	Definitions	(1020-9 and 10 October 1995)
1020.03	Bicycle Facilities	(1020-11 through 19 March 1994)
1020.04	Pedestrian Facilities (Walkways)	(1020-21 through 40 March 1994)
1020.05	Equestrian and Watercraft Facilities	
1030	Safety Rest Areas and Travel Services	June 1999
1030.01	General	(1030-3 through 5 November 1999)
1030.02	References	
1030.03	Documentation	

		<b>Date</b>
1040	Weigh Sites	May 2000
	1040.01 General	
	1040.02 Definitions	
	1040.03 Planning, Development, and Responsibilities	
	1040.04 Permanent Facilities	
	1040.05 Portable Facilities	
	1040.06 Shoulder Sites	
	1040.07 Federal Participation	
	1040.08 Procedures	
	1040.09 Documentation	
1050	High Occupancy Vehicle Priority Treatment	June 1995
	1050.01 General	
	1050.02 Definitions	
	1050.03 References	
	1050.04 Preliminary Design and Planning	
	1050.05 Operations	
	1050.06 Design Criteria	
	1050.07 Arterial HOV	
1060	Transit Benefit Facilities	December 1991
	1060.01 Introduction	(1060-14 March 1994)
	1060.02 Definitions	(1060-16 through 22 March 1994) (1060-19 November 1997)
	1060.03 Park and Ride Lots	(1060-23 and 24 July 1994)
	1060.04 Transfer/Transit Centers	(1060-25 through 34 March 1994)
	1060.05 Bus Stops and Pullouts	(1060-35 and 36 July 1994)
	1060.06 Passenger Amenities	(1060-37 and 38 March 1994)
	1060.07 Roadway and Vehicle Design Criteria Characteristics	
	1060.08 Intersection Radii	
	1060.09 Disabled Accessibility	
	1060.10 References	

## **Division 11 Structures**

1110	Site Data for Structures	April 1998
	1110.01 General	(1110-3 through 5 November 1999)
	1110.02 References	
	1110.03 Required Data for All Structures	
	1110.04 Additional Data for Waterway Crossings	
	1110.05 Additional Data for Grade Separations	
	1110.06 Additional Data for Widening	
	1110.07 Documentation	
1120	Bridges	May 2000
	1120.01 General	
	1120.02 References	
	1120.03 Bridge Location	
	1120.04 Bridge Site Design Elements	
	1120.05 Documentation	

		<b>Date</b>
1130	Retaining Walls and Steep Reinforced Slopes	December 1998
	1130.01 References	(1130-1 November 1999)
	1130.02 General	(1130-12 November 1999)
	1130.03 Design Principles	
	1130.04 Design Requirements	
	1130.05 Guidelines for Wall/Slope Selection	
	1130.06 Design Responsibility and Process	
	1130.07 Documentation	
1140	Noise Barriers	December 1998
	1140.01 General	
	1140.02 References	
	1140.03 Design	
	1140.04 Procedures	
	1140.05 Documentation	

## **Division 12 Hydraulics**

1210	Hydraulic Design	December 1998
	1210.01 General	
	1210.02 References	
	1210.03 Hydraulic Considerations	
	1210.04 Safety Considerations	
	1210.05 Design Responsibility	

## **Division 13 Roadside Development**

1300	Roadside Development and Highway Beautification	June 1999
	1300.01 General	
	1300.02 References	
	1300.03 Roadside Classification Plan	
	1300.04 Roadside Manual	
	1300.05 Design Requirements	
	1300.06 Documentation	
	1300.07 Design Recommendations	
1310	Contour Grading	June 1999
	1310.01 General	
	1310.02 References	
	1310.03 Procedures	
	1310.04 Recommendations	
1320	Vegetation	June 1999
	1320.01 General	
	1320.02 References	
	1320.03 Discussion	
	1320.04 Recommendations	
	1320.05 Design Guidelines	
	1320.06 Documentation	

	<b>Date</b>
1330 Irrigation	June 1999
1330.01 General	
1330.02 References	
1330.03 Design Considerations	
1350 Soil Bioengineering	May 2000
1350.01 General	
1350.02 References	
1350.03 Uses	
1350.04 Design Responsibilities and Considerations	
1350.05 Documentation	

## **Division 14 Right of Way and Access Control**

1410 Right of Way Considerations	June 1999
1410.01 General	
1410.02 References	
1410.03 Special Features	
1410.04 Easements and Permits	
1410.05 Programming for Funds	
1410.06 Appraisal and Acquisition	
1410.07 Transactions	
1410.08 Documentation	
1420 Access Control Design Policy	June 1989
1420.01 General	(1420-4 March 1994)
1420.02 Full Access Control Criteria	(1420-11 through 21 March 1994)
1420.03 Partial Access Control Criteria	
1420.04 Modified Access Control Criteria	
1420.05 Access Approaches	
1420.06 Approaches Between Limited Access Highways and Adjacent Railroads	
1420.07 Frontage Roads	
1420.08 Multiple Use of Right of Way for Nonhighway Purposes	
1420.09 Modifications to Established Limited Access Plans	
1425 Access Point Decision Report	May 2000
1425.01 General	
1425.02 References	
1425.03 Definitions	
1425.04 Procedures	
1425.05 Access Point Decision Report and Supporting Analyses	
1425.06 Documentation	
1430 Development of Access Control	June 1989
1430.01 General	
1430.02 Access Report	
1430.03 Access Hearing	

		<b>Date</b>
1440	Surveying and Mapping	June 1999
	1440.01 General	
	1440.02 References	
	1440.03 Procedures	
	1440.04 Datums	
	1440.05 Global Positioning System	
	1440.06 WSDOT Monument Database	
	1440.07 Geographic Information System	
	1440.08 Photogrammetric Surveys	
	1440.09 Documentation	
1450	Monumentation	October 1995
	1450.01 General	
	1450.02 References	
	1450.03 Definitions	
	1450.04 Control Monuments	
	1450.05 Alignment Monuments	
	1450.06 Property Corners	
	1450.07 Other Monuments	
	1450.08 Documentation	
	1450.09 Filing Requirements	
1460	Fencing	June 1999
	1460.01 General	
	1460.02 References	
	1460.03 Design Criteria	
	1460.04 Fencing Types	
	1460.05 Gates	
	1460.06 Procedure	
	1460.07 Documentation	
<b>Index</b>		May 2000



## Figures

<b>Figure Number</b>	<b>Title</b>	<b>Page</b>	<b>Last Date</b>
120-1	Planning Organizations	120-3	May 2000
120-2	Transportation Plan Relationships	120-17	May 2000
120-3	RTIP, MTIP, and STIP Development Process	120-18	May 2000
120-4	Planning and Programming Links	120-19	May 2000
210-1	Sequence for a Hearing	210-16	December 1998
220-1	Environmental Process Flow Chart	220-14	June 1989
240-1a	Permits and Approvals	240-11	September 1990
240-1b	Permits and Approvals	240-12	September 1990
240-2	FAA Notice Requirement Related to Highways	240-13	June 1989
240-3	DNR Area Management Units	240-14	June 1989
310-1	Legislative Study Cost Estimate	310-6	June 1989
310-2	Legislative Study Report Cover	310-7	June 1989
310-3	Legislative Study Report Title Page	310-8	June 1989
315-1	Eight-Phase Job Plan for VE Studies	315-5	August 1998
315-2	Request for Value Engineering Study	315-6	August 1998
315-3	VE Study Team Tools	315-7	August 1998
325-1	Design Matrix Selection Guide	325-4	May 2000
325-2a	NHS Highways in Washington	325-6	August 1998
325-2b	NHS Highways in Washington (continued)	325-7	August 1998
325-3a	Preservation Program	325-8	August 1998
325-3b	Improvement Program	325-9	May 2000
325-3c	Improvement Program (continued)	325-10	May 2000
325-4	Design Matrix 1 — Interstate Routes (Main Line)	325-11	May 2000
325-5	Design Matrix 2 — Interstate Interchange Areas	325-12	May 2000
325-6	Design Matrix 3 — NHS Routes (Main Line)	325-13	May 2000
325-7	Design Matrix 4 — Non-Interstate Interchange Areas	325-14	May 2000
325-8	Design Matrix 5 — Non-NHS Routes	325-15	May 2000
330-1	Design Approval Level	330-6	June 1999
330-2	Reviews and Approvals	330-7	June 1999
330-3a	Reviews and Approvals, Design	330-8	June 1999
330-3b	Reviews and Approvals, Design (continued)	330-9	June 1999
330-4	PS&E Process Approvals	330-10	August 1998
330-5a	Sample Project Analysis	330-11	August 1998
330-5b	Sample Project Analysis	330-12	August 1998
330-6	Sample Evaluate Upgrade (EU)	330-13	August 1998

<b>Figure Number</b>	<b>Title</b>	<b>Page</b>	<b>Last Date</b>
330-7a	Sample Deviation, Rural	330-14	August 1998
330-7b	Sample Deviation, Rural	330-15	August 1998
330-8a	Sample Deviation, Urban	330-16	August 1998
330-8b	Sample Deviation, Urban	330-17	August 1998
430-1	Turning Ramp Lane Widths Modified Design Level	430-1	May 2000
430-2	Design Vehicles Modified Design Level	430-3	May 2000
430-3	Modified Design Level for Multilane Highways and Bridges	430-4	May 2000
430-4	Modified Design Level for Two-Lane Highways and Bridges	430-5	May 2000
430-5	Minimum Total Roadway Widths for Two-Lane Highway Curves	430-6	November 1997
430-6	Minimum Total Roadway Widths for Two-Lane Highway Curves, $\Delta < 90^\circ$ — Modified Design Level	430-7	April 1998
430-7	Evaluation for Stopping Sight Distance for Crest Vertical Curves — Modified Design Level	430-8	November 1997
430-8	Evaluation for Stopping Sight Distance for Horizontal Curves — Modified Design Level	430-9	November 1997
430-9	Main Line Roadway Sections — Modified Design Level	430-10	November 1997
430-10	Ramp Roadway Sections — Modified Design Level	430-11	August 1998
440-1	Desirable Design Speed	440-4	December 1998
440-2	Minimum Shoulder Width	440-5	December 1998
440-3	Geometric Design Data, Interstate	440-7	December 1998
440-4a	Geometric Design Data, Principle Arterial	440-8	December 1998
440-4b	Geometric Design Data, Principle Arterial	440-9	May 2000
440-5a	Geometric Design Data, Minor Arterial	440-10	November 1999
440-5b	Geometric Design Data, Minor Arterial	440-11	May 2000
440-6a	Geometric Design Data, Collector	440-12	December 1998
440-6b	Geometric Design Data, Collector	440-13	December 1998
510-1	Material Source Development Plan	510-16	November 1999
520-1	Estimating — Miscellaneous Tables	520-2	November 1999
520-2a	Estimating — Asphalt Concrete Pavement and Asphalt Distribution Tables	520-3	November 1999
520-2b	Estimating — Asphalt Concrete Pavement and Asphalt Distribution Tables	520-4	April 1998
520-3	Estimating — Bituminous Surface Treatment	520-5	April 1998
520-4	Estimating — Base and Surfacing Typical Section Formulae and Example	520-6	April 1998
520-5a	Estimating — Base and Surfacing Quantities	520-7	April 1998
520-5b	Estimating — Base and Surfacing Quantities	520-8	April 1998
520-5c	Estimating — Base and Surfacing Quantities	520-9	April 1998
520-5d	Estimating — Base and Surfacing Quantities	520-10	April 1998
520-5e	Estimating — Base and Surfacing Quantities	520-11	April 1998
520-5f	Estimating — Base and Surfacing Quantities	520-12	April 1998
520-5g	Estimating — Base and Surfacing Quantities	520-13	April 1998
520-5h	Estimating — Base and Surfacing Quantities	520-14	April 1998

<b>Figure Number</b>	<b>Title</b>	<b>Page</b>	<b>Last Date</b>
530-1	Selection Criteria for Geotextile Class	530-3	April 1998
530-2	Maximum Sheet Flow Lengths for Silt Fences	530-8	April 1998
530-3	Maximum Contributing Area for Ditch and Swale Applications	530-8	April 1998
530-4	Design Process for Drainage and Erosion Control Geotextiles and Nonstandard Applications	530-12	April 1998
530-5	Design Process for Separation, Soil Stabilization, and Silt Fence	530-13	November 1999
530-6a	Examples of Various Geosynthetics	530-14	April 1998
530-6b	Examples of Various Geosynthetics	530-15	April 1998
530-7a	Geotextile Application Examples	530-16	April 1998
530-7b	Geotextile Application Examples	530-17	April 1998
530-7c	Geotextile Application Examples	530-18	April 1998
530-7d	Geotextile Application Examples	530-19	April 1998
530-8	Definition of Slope Length	530-20	April 1998
530-9	Definition of Ditch or Swale Storage Length and Width	530-21	April 1998
530-10	Silt Fences for Large Contributing Area	530-22	April 1998
530-11	Silt Fence End Treatment	530-23	April 1998
530-12	Gravel Check Dams for Silt Fences	530-24	April 1998
610-1	Type of Area and Appropriate Level of Service	610-3	June 1989
610-2	Adjustment Factor for Type of Multilane Highway and Development Environment, $f_E$	610-3	June 1989
610-3	Maximum ADT vs. Level of Service and Type of Terrain for Two-Lane Rural Highways	610-4	June 1989
610-4	Service Flow Rate per Lane (SFL) for Multilane Highways	610-5	June 1989
610-5	Peak-Hour Factors	610-6	June 1989
610-6	Service Flow Rates per Lane (SFL) for Freeways	610-6	June 1989
620-1a	Alignment Examples	620-6	April 1998
620-1b	Alignment Examples	620-7	April 1998
620-1c	Alignment Examples	620-8	April 1998
630-1a	Coordination of Horizontal and Vertical Alignments	630-4	April 1998
630-1b	Coordination of Horizontal and Vertical Alignments	630-5	April 1998
630-1c	Coordination of Horizontal and Vertical Alignments	630-6	April 1998
630-2	Grade Length	630-7	April 1998
630-3	Grading at Railroad Crossings	630-8	April 1998
640-1	Minimum Radius for Normal Crown Section	640-5	December 1998
640-2	Side Friction Factor	640-5	December 1998
640-3	Divided Highway Roadway Sections	640-10	December 1998
640-4	Undivided Multilane Highway Roadway Sections	640-11	December 1998
640-5	Two-Lane Highway Roadway Sections	640-12	December 1998
640-6a	Ramp Roadway Sections	640-13	December 1998
640-6b	Ramp Roadway Sections	640-14	December 1998
640-7a	Traveled Way Width for Two-Way Two-Lane Turning Roadways	640-15	December 1998

<b>Figure Number</b>	<b>Title</b>	<b>Page</b>	<b>Last Date</b>
640-7b	Traveled Way Width for Two-Way Two-Lane Turning Roadways	640-16	December 1998
640-8a	Traveled Way Width for Two-Lane One-Way Turning Roadways	640-17	May 2000
640-8b	Traveled Way Width for Two-Lane One-Way Turning Roadways	640-18	December 1998
640-9a	Traveled Way Width for One-Lane Turning Roadways	640-19	December 1998
640-9b	Traveled Way Width for One-Lane Turning Roadways	640-20	December 1998
640-9c	Traveled Way Width for One-Lane Turning Roadways	640-21	December 1998
640-10a	Shoulder Details	640-22	June 1999
640-10b	Shoulder Details	640-23	December 1998
640-11a	Superelevation Rates (10% Max)	640-24	December 1998
640-11b	Superelevation Rates (6% Max)	640-25	May 2000
640-11c	Superelevation Rates (8% Max)	640-26	December 1998
640-12	Superelevation Rates for Turning Roadways at Intersections	640-27	December 1998
640-13a	Superelevation Transitions for Highway Curves	640-28	June 1999
640-13b	Superelevation Transitions for Highway Curves	640-29	June 1999
640-13c	Superelevation Transitions for Highway Curves	640-30	November 1999
640-13d	Superelevation Transitions for Highway Curves	640-31	June 1999
640-13e	Superelevation Transitions for Highway Curves	640-32	June 1999
640-14a	Superelevation Transitions for Ramp Curves	640-33	November 1999
640-14b	Superelevation Transitions for Ramp Curves	640-34	November 1999
640-15a	Divided Highway Median Sections	640-35	May 2000
640-15b	Divided Highway Median Sections	640-36	May 2000
640-15c	Divided Highway Median Sections	640-37	May 2000
640-16a	Roadway Sections in Rock Cuts Design A	640-38	December 1998
640-16b	Roadway Sections in Rock Cuts Design B	640-39	May 2000
640-17	Roadway Sections With Stepped Slopes	640-40	December 1998
640-18a	Bridge End Slopes	640-41	December 1998
640-18b	Bridge End Slopes	640-42	December 1998
650-1	Passing Sign Distance	650-1	April 1998
650-2	Design Stopping Sight Distance	650-3	June 1999
650-3	Existing Stopping Sight Distance	650-3	June 1999
650-4	Design Stopping Sight Distance on Grades	650-3	June 1999
650-5	Decision Sight Distance	650-5	April 1998
650-6	Passing Sight Distance for Crest Vertical Curves	650-6	April 1998
650-7	Stopping Sight Distance for Crest Vertical Curves	650-7	April 1998
650-8	Stopping Sight Distance for Sag Vertical Curves	650-8	May 2000
650-9	Horizontal Stopping Sight Distance	650-9	May 2000
700-1	Design Clear Zone Distance Table	700-8	June 1999
700-2	Design Clear Zone Inventory Form	700-9	August 1997
700-3	Recovery Area	700-11	August 1997
700-4	Design Clear Zone for Ditch Sections	700-12	August 1997
700-5	Guidelines for Embankment Barrier	700-13	August 1997
700-6	Mailbox Location and Turnout Design	700-14	August 1997

<b>Figure Number</b>	<b>Title</b>	<b>Page</b>	<b>Last Date</b>
700-7	Warrants for Median Barrier	700-15	August 1997
700-8	Glare Screens	700-16	August 1997
710-1	Type 7 Bridge Rail Upgrade Criteria	710-3	May 2000
710-2	Longitudinal Barrier Deflection	710-4	May 2000
710-3	Longitudinal Barrier Flare Rates	710-5	May 2000
710-4	Guardrail Locations on Slopes	710-6	May 2000
710-5	Old Type 3 Anchor	710-8	May 2000
710-6	Guardrail Connections	710-9	May 2000
710-7	Transitions and Connections	710-10	May 2000
710-8	Concrete Barrier Shapes	710-12	May 2000
710-9	Single Slope Concrete Barrier	710-13	May 2000
710-10	Safety Shaped Concrete Bridge Rail Retrofit	710-16	May 2000
710-11a	Barrier Length of Need	710-18	May 2000
710-11b	Barrier Length of Need	710-19	May 2000
710-11c	Barrier Length of Need on Curves	710-20	May 2000
710-12	Beam Guardrail Post Installation	710-21	May 2000
710-13	Beam Guardrail Terminals	710-22	May 2000
710-14	Cable Barrier Locations on Slopes	710-23	May 2000
710-15	Thrie Beam Bridge Rail Retrofit Criteria	710-24	May 2000
720-1	Impact Attenuator Sizes	720-4	June 1999
720-2a	Impact Attenuator Systems Permanent Installations	720-6	June 1999
720-2b	Impact Attenuator Systems Permanent Installations	720-7	June 1999
720-2c	Impact Attenuator Systems Permanent Installations	720-8	June 1999
720-3	Impact Attenuator Systems Work Zone Installations	720-9	June 1999
720-4a	Impact Attenuator Systems — Older Systems	720-10	June 1999
720-4b	Impact Attenuator Systems — Older Systems	720-11	June 1999
720-5	Impact Attenuator Comparison	720-12	June 1999
820-1a	Sign Support Locations	820-5	November 1999
820-1b	Sign Support Locations	820-6	November 1999
820-2	Wood Posts	820-7	November 1999
820-3	Steel Posts	820-8	November 1999
820-4	Laminated Wood Box Posts	820-9	November 1999
830-1	Pavement Marking Material Guide	830-6	May 2000
830-2	Guide Post Placement	830-7	May 2000
830-3	Wildlife Reflectors on the Outside of the Curve	830-8	May 2000
840-1	Freeway Lighting Applications	840-11	May 2000
840-2	Freeway Lighting Applications	840-12	May 2000
840-3	Roadway Lighting Applications	840-13	May 2000
840-4	Roadway Lighting Applications	840-14	May 2000
840-5	Roadway Lighting Applications	840-15	May 2000
840-6	Light Levels and Uniformity Ratio	840-16	May 2000
840-7	Light Standard Locations	840-17	May 2000
840-8	Light Standard heights, Conductor, and Conduit Properties	840-18	May 2000
840-9	Line Loss Calculations	840-19	May 2000
840-10	Line Loss Calculations	840-20	May 2000

<b>Figure Number</b>	<b>Title</b>	<b>Page</b>	<b>Last Date</b>
840-11a	Illumination Calculation Example	840-21	May 2000
840-11b	Illumination Calculation Example	840-22	May 2000
840-11c	Illumination Calculation Example	840-23	May 2000
850-1	Responsibility for Various Types of Facilities on State Highways	850-12	June 1989
850-2 M	Example Optimum Cycle and Split Calculation	850-13	March 1994
850-3	Controller Frame Configurations	850-14	June 1989
850-4	Control Application Variations	850-15	June 1989
850-5a M	Signal Displays	850-16	March 1994
850-5b M	Signal Displays	850-17	March 1994
850-6a M	Strain Pole and Foundation Selection Procedure	850-18	March 1994
850-6b M	Strain Pole and Foundation Selection Example	850-19	March 1994
850-7 M	Conduit	850-20	March 1994
850-8 M	Example Signal Plan	850-21	March 1994
850-9	Standard Intersection Movements and Head Numbers	850-22	June 1989
850-10a	Typical Phase Sequence Diagrams	850-23	June 1989
850-10b	Typical Phase Sequence Diagrams	850-24	June 1989
850-10c	Typical Phase Sequence Diagrams	850-25	June 1989
850-10d	Typical Phase Sequence Diagrams	850-26	June 1989
850-11	Signal Sequence Chart	850-27	June 1989
850-12	Typical Wiring Schematic	850-28	June 1989
850-13 M	Typical Signal Standard Detail Chart	850-29	March 1994
850-2	Example Optimum Cycle and Split Calculation	850-31	March 1994
850-5a	Signal Displays	850-32	March 1994
850-5b	Signal Displays	850-33	March 1994
850-6a	Strain Pole and Foundation Selection Procedure	850-34	March 1994
850-6b	Strain Pole and Foundation Selection Example	850-35	March 1994
850-7	Conduit	850-36	March 1994
850-8	Example Signal Plan	850-37	March 1994
850-13	Typical Signal Standard Detail Chart	850-38	March 1994
910-1	Design Vehicle Types	910-3	August 1998
910-2	Intersection Design Vehicle	910-3	August 1998
910-3	Shy Distance for Barrier Curb	910-7	August 1997
910-4	U-Turn Spacing	910-9	August 1997
910-5	Sight Distance for Turning Vehicles	910-10	August 1997
910-6a M	Turning Path Template	910-13	August 1997
910-6b M	Turning Path Template	910-14	August 1997
910-7 M	Right-Turn Corner	910-15	August 1997
910-8 M	Left-Turn Storage Guidelines	910-16	August 1997
910-9a	Left-Turn Storage Length	910-17	November 1999
910-9b	Left-Turn Storage Length	910-18	November 1999
910-9c	Left-Turn Storage Length	910-19	November 1999
910-9d M	Additional Left-Turn Storage for Trucks	910-20	August 1997
910-10a	Channelization Widening	910-21	November 1999
910-10b	Median Channelization — Median Width 7 m to 8 m	910-22	November 1999
910-10c	Median Channelization — Median Width of More Than 8 m	910-23	November 1999

<b>Figure Number</b>	<b>Title</b>	<b>Page</b>	<b>Last Date</b>
910-10d	Minor Intersection on Divided Highway	910-24	November 1999
910-10e M	Two-Way Left-Turn Lane	910-25	April 1998
910-11 M	Right-Turn Lane Guidelines	910-26	December 1998
910-12a M	Right-Turn Pocket and Right-Turn Taper	910-27	August 1997
910-12b M	Right-Turn Lane	910-28	August 1997
910-13 M	Acceleration Lane	910-29	August 1997
910-14a M	Traffic Island Designs	910-30	August 1997
910-14b M	Traffic Island Designs	910-31	August 1997
910-14c M	Traffic Island Designs	910-32	August 1997
910-15	U-Turn Locations	910-33	November 1999
910-16a	Sight Distance for Grade Intersection With Stop Control	910-34	November 1999
910-16b	Sight Distance for Grade Intersection With Stop Control	910-35	August 1997
910-16c	Sight Distance at Intersections	910-36	November 1999
910-17	Interchange Ramp Details	910-37	August 1997
920-1	Road Approach Design Templates	920-3	April 1998
920-2	Minimum Corner Clearance	920-4	April 1998
920-3	Noncommercial Approach Design Template A	920-5	November 1999
920-4	Noncommercial Approach Design Template B and C	920-6	November 1999
920-5	Commercial Approach — Single Approach Design Template D	920-7	April 1998
920-6	Road Approach Sight Distance	920-8	November 1999
920-7	Road Approach Spacing and Corner Clearance	920-9	November 1999
930-1 M	Sight Distance at Railroad Crossing	930-4	March 1994
930-2	Guidelines for Railroad Crossing Protection	930-5	June 1989
930-3 M	Typical Pullout Lane at Railroad Crossing	930-6	March 1994
930-4 M	Railroad Crossing Plan for Washington Utilities and Transportation Commission	930-7	March 1994
930-5 M	Longitudinal Easement Cross Sections	930-8	March 1994
930-1	Sight Distance at Railroad Crossing	930-9	March 1994
930-3	Typical Pullout Lane at Railroad Crossing	930-10	March 1994
930-4	Railroad Crossing Plan for Washington Utilities and Transportation Commission	930-11	March 1994
930-5	Longitudinal Easement Cross Sections	930-12	March 1994
940-1	Ramp Design Speed	940-4	June 1999
940-2	Maximum Ramp Grade	940-5	November 1999
940-3	Ramp Widths	940-5	November 1999
940-4	Basic Interchange Patterns	940-11	June 1999
940-5	Minimum Ramp Terminal Spacing	940-12	June 1999
940-6a	Lane Balance	940-13	June 1999
940-6b	Lane Balance	940-14	June 1999
940-7	Main Line Lane Reduction Alternatives	940-15	May 2000
940-8	Acceleration Lane Length	940-16	June 1999
940-9a	On-Connection (Single-Lane, Taper Type)	940-17	May 2000
940-9b	On-Connection (Single-Lane, Parallel Type)	940-18	May 2000
940-9c	On-Connection (Two-Lane, Parallel Type)	940-19	May 2000
940-9d	On-Connection (Two-Lane, Taper Type)	940-20	May 2000
940-10	Deceleration Lane Length	940-21	June 1999
940-11	Gore Area Characteristics	940-22	June 1999

<b>Figure Number</b>	<b>Title</b>	<b>Page</b>	<b>Last Date</b>
940-12a	Off-Connection (Single Lane, Taper Type)	940-23	May 2000
940-12b	Off-Connection (Single Lane, Parallel Type)	940-24	May 2000
940-12c	Off-Connection (Single-Lane, One Lane Reduction)	940-25	May 2000
940-12d	Off-Connection (Two-Lane, Taper Type)	940-26	May 2000
940-12e	Off-Connection (Two-Lane, Parallel Type)	940-27	May 2000
940-13a	Collector Distributor (Outer Separations)	940-28	May 2000
940-13b	Collector Distributor (Off-Connections)	940-29	May 2000
940-13c	Collector Distributor (On-Connections)	940-30	May 2000
940-14	Loop Ramps Connections	940-31	May 2000
940-15	Length of Weaving Sections	940-32	May 2000
940-16	Temporary Ramps	940-33	June 1999
940-17	Interchange Plan	940-34	June 1999
1010-1	Rolling Resistance	1010-4	November 1999
1010-2a	Performance for Heavy Trucks	1010-6	November 1999
1010-2b	Speed Reduction Example	1010-7	November 1999
1010-3	Level of Service — Multilane	1010-8	November 1999
1010-4	Auxiliary Climbing Lane	1010-9	November 1999
1010-5	Warrant for Passing Lanes	1010-10	November 1999
1010-6	Auxiliary Passing Lane	1010-11	November 1999
1010-7	Slow Moving Vehicle Turnout	1010-12	November 1999
1010-8	Typical Emergency Escape Ramp	1010-13	November 1999
1010-9	Chain-Up/Chain-Off Area	1010-14	November 1999
1020-1a M	Two-Way Bike Path on Separated Right of Way	1020-11	March 1994
1020-1b M	Two-Way Bike Path Along Highway	1020-12	March 1994
1020-1c M	Bikeways on Highway Bridges	1020-13	March 1994
1020-2 M	Curve Radii & Superelevations	1020-14	March 1994
1020-3 M	Bikeway Curve Widening for Various Radii	1020-15	March 1994
1020-4 M	Stopping Sight Distance	1020-16	March 1994
1020-5 M	Sight Distances for Crest Vertical Curves	1020-17	March 1994
1020-6 M	Lateral Clearances on Horizontal Curves	1020-18	March 1994
1020-7 M	Typical Bike Lane Cross Sections	1020-19	March 1994
1020-8	Typical Bicycle/Auto Movements at Intersection of Multilane Streets	1020-20	June 1989
1020-9 M	Bike Lane Ramp Crossing	1020-21	March 1994
1020-10 M	Bike Lanes Approaching Motorists' Right-Turn-Only Lanes	1020-22	March 1994
1020-11 M	Guidelines for Hiking Trails	1020-23	March 1994
1020-12 M	Walkways on Highway Bridges	1020-24	March 1994
1020-13 M	Handicap Passing and Turning Space for Sidewalks	1020-25	March 1994
1020-1a	Two-Way Bike Path on Separated Right of Way	1020-27	March 1994
1020-1b	Two-Way Bike Path Along Highway	1020-28	March 1994
1020-1c	Bikeways on Highway Bridges	1020-29	March 1994
1020-2	Curve Radii & Superelevations	1020-30	March 1994
1020-3	Bikeway Curve Widening for Various Radii	1020-31	March 1994
1020-4	Stopping Sight Distance	1020-32	March 1994
1020-5	Sight Distances for Crest Vertical Curves	1020-33	March 1994
1020-6	Lateral Clearances on Horizontal Curves	1020-34	March 1994
1020-7	Typical Bike Lane Cross Sections	1020-35	March 1994



<b>Figure Number</b>	<b>Title</b>	<b>Page</b>	<b>Last Date</b>
1020-9	Bike Lane Ramp Crossing	1020-36	March 1994
1020-10	Bike Lanes Approaching Motorists' Right-Turn-Only Lanes	1020-37	March 1994
1020-11	Guidelines for Hiking Trails	1020-38	March 1994
1020-12	Walkways on Highway Bridges	1020-39	March 1994
1020-13	Handicap Passing and Turning Space for Sidewalks	1020-40	March 1994
1030-1	Typical Truck Storage	1030-3	November 1999
1030-2	Typical Single RV Dump Station Layout	1030-4	November 1999
1030-3	Typical Two RV Dump Station Layout	1030-5	November 1999
1040-1	Truck Weigh Site (Multilane Highway)	1040-6	May 2000
1040-2	Truck Weigh Site (Two Lane Highway)	1040-7	May 2000
1040-3	Vehicle Inspection Installation	1040-8	May 2000
1040-4	Minor Portable Scale Site	1040-9	May 2000
1040-5	Major Portable Scale Site	1040-10	May 2000
1040-6	Small shoulder Site	1040-11	May 2000
1040-7	Large Shoulder Site	1040-12	May 2000
1040-8a	Memorandum of Understanding to Vehicle Weighing and Equipment Inspection Facilities on State Highways	1040-13	May 2000
1040-8b	Memorandum of Understanding to Vehicle Weighing and Equipment Inspection Facilities on State Highways	1040-14	May 2000
1040-8c	Memorandum of Understanding to Vehicle Weighing and Equipment Inspection Facilities on State Highways	1040-15	May 2000
1040-8d	Memorandum of Understanding to Vehicle Weighing and Equipment Inspection Facilities on State Highways	1040-16	May 2000
1040-8e	Memorandum of Understanding to Vehicle Weighing and Equipment Inspection Facilities on State Highways	1040-17	May 2000
1050-1 M	Typical Concurrent Flow Lanes	1050-11	June 1995
1050-2 M	Roadway Widths for Three-Lane HOV On and Off Ramps	1050-12	June 1995
1050-3a M	Separated Roadway Single-Lane, One-Way or Reversible	1050-13	June 1995
1050-3b M	Separated Roadway Multi-Lane, One-Way or Reversible	1050-14	June 1995
1050-4a M	Single-Lane Ramp Meter With HOV Bypass	1050-15	June 1995
1050-4b M	Two-Lane Ramp Meter With HOV Bypass	1050-16	June 1995
1050-5a M	Typical HOV Flyover	1050-17	June 1995
1050-5b M	Typical Inside Lane On Ramp	1050-18	June 1995
1050-5c M	Inside Single-Lane On Ramp	1050-19	June 1995
1050-6 M	Typical Slip Ramp	1050-20	June 1995
1050-7a M	Enforcement Area (One Direction Only)	1050-21	June 1995
1050-7b M	Median Enforcement Area	1050-22	June 1995
1050-7c M	Bidirectional Observation Point	1050-23	June 1995
1050-1	Typical Concurrent Flow Lanes	1050-24	June 1995
1050-2	Roadway Widths for Three-Lane HOV On and Off Ramps	1050-25	June 1995
1050-3a	Separated Roadway Single-Lane, One-Way or Reversible	1050-26	June 1995
1050-3b	Separated Roadway Multi-Lane, One-Way or Reversible	1050-27	June 1995
1050-4a	Single-Lane Ramp Meter With HOV Bypass	1050-28	June 1995
1050-4b	Two-Lane Ramp Meter With HOV Bypass	1050-29	June 1995
1050-5a	Typical HOV Flyover	1050-30	June 1995
1050-5b	Typical Inside Lane On Ramp	1050-31	June 1995
1050-5c	Inside Single-Lane On Ramp	1050-32	June 1995
1050-6	Typical Slip Ramp	1050-33	June 1995

<b>Figure Number</b>	<b>Title</b>	<b>Page</b>	<b>Last Date</b>
1050-7a	Enforcement Area (One Direction Only)	1050-34	June 1995
1050-7b	Median Enforcement Area	1050-35	June 1995
1050-7c	Bidirectional Observation Point	1050-36	June 1995
1060-1 M	Bus Berth Design	1060-14	March 1994
1060-2	Transit Center Sawtooth Bus Berth Design Example	1060-15	December 1991
1060-3 M	Bus Turnout Transfer Center	1060-16	March 1994
1060-4 M	Off-Street Transfer Center	1060-17	March 1994
1060-5 M	Minimum Bus Zone Dimensions	1060-18	March 1994
1060-6	Bus Stop Pullouts, Arterial Streets	1060-19	November 1997
1060-7 M	Minimum Bus Zone and Pullout after Right Turn Dimensions	1060-20	March 1994
1060-8 M	Shelter Siting	1060-21	March 1994
1060-9 M	Typical Bus Shelter Design	1060-22	March 1994
1060-10 M	Design Vehicle Turning Movements	1060-23	July 1994
1060-11 M	Turning Template for Articulated Bus	1060-24	July 1994
1060-12 M	Intersection Design	1060-25	March 1994
1060-13 M	Cross-Street Width Occupied by Turning Vehicle for Various Angles of Intersection and Curb Radii	1060-26	March 1994
1060-1	Bus Berth Design	1060-27	March 1994
1060-3	Bus Turnout Transfer Center	1060-28	March 1994
1060-4	Off-Street Transfer Center	1060-29	March 1994
1060-5	Minimum Bus Zone Dimensions	1060-30	March 1994
1060-6	Bus Stop Pullouts, Arterial Streets	1060-31	March 1994
1060-7	Minimum Bus Zone and Pullout after Right Turn Dimensions	1060-32	March 1994
1060-8	Shelter Siting	1060-33	March 1994
1060-9	Typical Bus Shelter Design	1060-34	March 1994
1060-10	Design Vehicle Turning Movements	1060-35	July 1994
1060-11	Turning Template for Articulated Bus	1060-36	July 1994
1060-12	Intersection Design	1060-37	March 1994
1060-13	Cross-Street Width Occupied by Turning Vehicle for Various Angles of Intersection and Curb Radii	1060-38	March 1994
1110-1	Bridge Site Data Check List	1110-5	November 1999
1120-1a	Railroad Vertical Clearance — New Bridge Construction	1120-5	May 2000
1120-1b	Railroad Vertical Clearance — Existing Bridge Modifications	1120-6	May 2000
1130-1a	Typical Mechanically Stabilized Earth Gravity Walls	1130-22	December 1998
1130-1b	Typical Prefabricated Modular Gravity Walls	1130-23	December 1998
1130-1c	Typical Rigid Gravity, Semigravity Cantilever, Nongravity Cantilever, and Anchored Walls	1130-24	December 1998
1130-1d	Typical Rockery and Reinforced Slope	1130-25	December 1998
1130-2	MSE Wall Drainage Detail	1130-26	December 1998
1130-3	Retaining Walls With Traffic Barriers	1130-27	December 1998
1130-4a	Retaining Wall Design Process	1130-28	December 1998
1130-4b	Retaining Wall Design Process — Proprietary	1130-29	December 1998
1130-5	Retaining Wall Bearing Pressure	1130-30	December 1998
1140-1	Standard Noise Wall Types	1140-3	December 1998

<b>Figure Number</b>	<b>Title</b>	<b>Page</b>	<b>Last Date</b>
1410-1	Appraisal and Acquisition	1410-6	June 1999
1420-1a	Full Access Control Criteria	1420-10	June 1989
1420-1b M	Access Control for Typical Interchange	1420-11	March 1994
1420-1c M	Access Control at Ramp Termination	1420-12	March 1994
1420-2a	Partial Access Control Criteria	1420-13	March 1994
1420-2b M	Access Control for Intersection at Grade	1420-14	March 1994
1420-3 M	Access Control Limits at Intersections	1420-15	March 1994
1420-1b	Access Control for Typical Interchange	1420-17	March 1994
1420-1c	Access Control at Ramp Termination	1420-18	March 1994
1420-2a	Partial Access Control Criteria	1420-19	March 1994
1420-2b	Access Control for Intersection at Grade	1420-20	March 1994
1420-3	Access Control Limits at Intersections	1420-21	March 1994
1425-1a	Access Point Decision Report Content and Review Levels	1425-11	May 2000
1425-1b	Access Point Decision Report Content and Review Levels	1425-12	May 2000
1425-2	Access Point Decision Report Possibly Not Required	1425-13	May 2000
1425-3a	Access Point Decision Report Flow Chart	1425-14	May 2000
1425-3b	Access Point Decision Report Flow Chart	1425-15	May 2000
1430-1	Access Report Plan	1430-4	June 1989
1430-2	Access Hearing Plan	1430-5	June 1989
1440-1a	Interagency Agreement	1440-4	June 1999
1440-1b	Interagency Agreement	1440-5	June 1999
1450-1	Monument Documentation Summary	1450-4	October 1995
1450-2a	Application for Permit to Remove or Destroy a Survey Monument	1450-5	October 1995
1450-2b	Completion Report for Monument Removal or Destruction	1450-6	October 1995
1450-3	Record of Monuments and Accessories	1450-7	October 1995
1450-4a	Land Corner Record	1450-8	October 1995
1450-4b	Corner Record Index Diagram	1450-9	October 1995

5:P65:DP/DMM

- 100.01 Purpose
- 100.02 Revisions

**100.01 Purpose**

The department has developed the *Design Manual* to reflect policy, outline a uniformity of methods and procedures, and communicate vital information to its employees. When properly used, it will result in the development of a highway system consistent with the needs of the traveling public.

The information, guidance, and reference contained herein are not intended as a substitute for sound engineering judgment. It is recognized that some situations encountered will be beyond the scope of this presentation, as the *Design Manual* is not a comprehensive textbook on highway engineering. Some of the many sources of information otherwise available are listed in Chapter 110.

**100.02 Revisions**

The *Design Manual* of today cannot remain static. It must be updated and revised to incorporate the advanced designs of tomorrow as these designs develop. The loose-leaf form and the numbering system are intended to facilitate the revision and continual updating of the manual.

It is vital that the user of this manual (1) incorporate the revisions that are periodically provided by the state Project Development Engineer and (2) participate in the revision process by using the form provided at the front of the manual to report flaws and contribute new material so that the *Design Manual* may present the best and most up-to-date information available.

# 110

## Nomenclature and References

110.01 Abbreviations  
110.02 References

### 110.01 ABBREVIATIONS

The following abbreviations are used in this manual:

AAR	American Association of Railroads	Commission	Washington State Transportation Commission
AASHTO	American Association of State Highway and Transportation Officials	CPMS	Capital Program Management System
ACP	Asphalt Concrete Pavement	CRAB	County Road Administration Board
ADT	Average Daily Traffic	CS	Control Section
AGC	Associated General Contractors	CRGC	Columbia River Gorge Commission
AIA	American Institute of Architects	DAHP	Department of Archaeology and Historic Preservation
AISC	American Institute of Steel Constructors, Inc.	DBR	Discretionary Bridge Replacement
AMTRAK	National Rail Passenger Corporation	DDHV	Directional Design Hour Volume
ANSI	American National Standards Institute	DEIS	Draft Environmental Impact Statement
APAW	Asphalt Paving Association of Washington	Department	Washington State Department of Transportation
APWA	American Public Works Association	DHV	Design Hour Volume
ASCE	American Society of Civil Engineers	District	WSDOT District Office
ASTM	American Society for Testing and Materials	DNR	Department of Natural Resources
AWS	American Welding Society	DNS	Determination of Nonsignificance
BIA	Bureau of Indian Affairs	DOA	Department of the Army
BM	Bench Mark	DOE	Department of Ecology
BM	Bureau of Mines	DOT	Department of Transportation
BPA	Bonneville Power Administration	EA	Environmental Assessment
BR	Bridge Replacement	ECS	Environmental Classification Summary
BST	Bituminous Surface Treatment	EDM	Electronic Distance Measurers
CA	Certification Acceptance	EEO	Equal Employment Opportunity
CAB	Civil Aeronautics Board	EIS	Environmental Impact Statement
CADD	Computer Aided Drafting and Design	EPA	Environmental Protection Agency
C-D	Collector-Distributor Road	FA	Federal Aid
CE - NEPA	Categorical Exclusion	FAA	Federal Aviation Administration
CE - SEPA	Categorical Exemption	FAI	Federal Aid Interstate
CEQ	Council on Environmental Quality	FAP	Federal Aid Primary
CFR	Code of Federal Regulations	FAS	Federal Aid Secondary
		FASP	Federal Aid Safety Program
		FAU	Federal Aid Urban
		FEIS	Final Environmental Impact Statement
		FEMA	Federal Emergency Management Agency

FERC	Federal Energy Regulatory Commission	NRCC	Natural Resource Coordinating Committee
FHPM	<i>Federal-Aid Highway Program Manual</i>	PC	Point of Curvature
FHWA	Federal Highway Administration	PDO	Headquarters Project Development Office
FONSI	Finding of No Significant Impact	PE	Preliminary Engineering
FS	Forest Service	PE	Project Engineer
GSP	General Special Provisions	PM	Project Manager
Headquarters	WSDOT Headquarters in Olympia	PR&PT	Planning, Research and Public Transportation Division (WSDOT)
HOV	High Occupancy Vehicle	PS&E	Plans, Specifications and Estimate
HPA	Hydraulic Project Approval	PT	Point of Tangent
HPMS	Highway Performance Monitoring System	PTF	Public Transfer Facility
ICC	Interstate Commerce Commission	RAP	Rural Arterial Program
IDT	Interdisciplinary Team	RCW	Revised Code of Washington
IL	Instructional Letter	ROD	Record of Decision
ITE	Institute of Traffic Engineers	RR	Railroad
L & I	Washington State Department of Labor and Industries	RRR (3R)	Resurfacing, Restoration, and Rehabilitation
LOS	Level of Service	R/W	Right of Way
METRO	Municipality of Metropolitan Seattle	SA	State Aid
MFRS	Mileage and Facilities Reporting System	Secretary	Secretary of Transportation
MOU	Memorandum of Understanding	SEPA	State Environmental Policy Act
MP	Milepost	SHPO	State Historic Preservation Officer
MPO	Metropolitan Planning Organization	SR	State Route
MUTCD	<i>Manual on Uniform Traffic Control Devices</i>	TCP	Traffic Control Plan
NAAQS	National Ambient Air Quality Standards	TIA	Transportation Improvement Account
NEC	National Electrical Code	TIB	Transportation Improvement Board
NEMA	National Electrical Manufacturers' Association	TIP	Transportation Improvement Program
NEPA	National Environmental Policy Act	TOPICS	Urban Traffic Operations Programs to Improve Capacity and Safety
NG	Negative Declaration	TRB	Transportation Research Board
NGS	United States National Geodetic Survey	TSC	Traffic Safety Commission
NGVD	National Geodetic Vertical Datum (1929)	TSM	Transportation Systems Management
NOAA	National Oceanographic and Atmospheric Administration	TWLTL	Two-way Left-turn Lane
NPDES	National Pollutant Discharge Elimination System	UAB	Urban Arterial Board
NPS	National Park Service	UBC	Uniform Building Code
		UFAS	Uniform Federal Accessibility Standards

UMTA	Urban Mass Transportation Administration
UPC	Uniform Plumbing Code
USBR	United States Bureau of Reclamation
USC	United States Code
USCG	United States Coast Guard
USDOT	United States Department of Transportation
USED	United States Engineering Department (Corps of Engineers, Department of the Army)
USFS	United States Forest Service (U.S. Department of Agriculture)
USFWS	U.S. Fish and Wildlife Service
USGS	United States Geological Survey
UTC	Utilities and Transportation Commission
VPH	Vehicles Per Hour
WAC	Washington Administrative Code
WASHTO	Western Association of State Highway and Transportation Officials
WDFD	Western District Federal Division (FHWA)
WPCP	Water Pollution Control Plan
WPPSS	Washington Public Power Supply System
WSASP	Washington State Airport System Plan
WSDOF	Washington State Department of Fisheries
WSDOG	Washington State Department of Game
WSDOT	Washington State Department of Transportation
WSP	Washington State Patrol
WSTC	Washington State Transportation Commission
WSTP	Washington State Transportation Plan

## 110.02 REFERENCES

The following is a list of available research materials, portions of which may be of value in the exercise of engineering judgment.

### (1) Administration

#### (a) WSDOT

- A Program for Highway Development in the State of Washington
- Department Publications Systems (Instructional Letters and Policy Directives)
- Summary of State Highway, Ferry Terminal and Capital Plant Needs (Biennial Report)
- Merit System Rules
- Critical Path Method Schedule
- Transportation Commission Resolutions
- Identification of State Highways
- *Local Agency Guidelines*
- Memorandum of Understanding — Highways Over National Forest Lands
- Operating Procedures
- U.S. Department of Interior, Bureau of Reclamation Agreement with State of Washington as to Crossings

#### (b) AASHTO

- A Policy on Locating Police Stations and Maintenance Yards Serving Interstate Highways
- A Policy on the Reporting of Road Conditions to the General Public
- An Informational Guide for a Training Program of Right of Way Personnel
- *Manual of Uniform Highway Accounting Procedures*
- Policy on Maximum Dimensions and Weights of Motor Vehicles to be Operated Over the Highways of the United States
- Reference Book of Member Department Personnel and Committees

#### (c) FHWA

- *Federal-Aid Highway Program Manual*
- Federal Laws, Regulations
- Planning and Co-ordination with Cities and Counties Regarding Highway Locations

### (2) Bridges and Structures

#### (a) WSDOT

- General Special Provisions
- State Route Bridge List
- *Standard Specifications for Road, Bridge, and Municipal Construction*
- *Bridge Design Manual*
  - Volume 1 — Criteria
  - Volume 2 — Design Aids
- *Standard Plans for Road, Bridge, and Municipal Construction*

- (b) AASHTO
  - Standard Specifications for Structural Supports for Highway Signs, Luminaires and Traffic Signals
  - *Standard Specifications for Highway Bridges*
  - Guide for Protective Screening of Overpass Structures

### **(3) Computer**

- (a) WSDOT
  - *Washington Computer Manual*
  - *Microcomputer Applications for Highway Engineering* (M 22-75)
  - *Design Engineering Work Station (DEWS) Manual* (M 22-76)
  - *CADD Manual* (M 22-32)

### **(4) Construction**

- (a) WSDOT
  - *Standard Plans for Road, Bridge, and Municipal Construction*
  - *Construction Manual*
  - *General Special Provisions*
  - *Standard Specifications for Road and Bridge and Municipal Construction*
- (b) AASHTO
  - Guide Specifications for Highway Construction
  - *Standard Specifications for Highway Bridges*
  - *Construction Manual for Hwy. Bridges and Incidental Structures*
  - Standard Specifications for Welding

### **(5) Design (General)**

- (a) WSDOT
  - Abstract on the Preparation of Plans, Specifications and Estimates for Building Construction and/or Capital Outlay Project
  - Annual Traffic Report (year)
  - *Local Agency Guidelines*
  - Supplement to MUTCD
- (b) AASHTO
  - *Policy on Design of Urban Highways and Arterial Streets* (1973)
  - *Policy on Geometric Design of Highways and Streets* (1984)
  - Design Standards-Interstate
  - Highway Design and Operational Practices
  - *Manual on Foundation Investigations*
  - AASHTO Interim Guide for Design of Pavement Structures
  - Guide on Evaluation & Attenuation of Noise
  - Guide for Bicycle Routes

- (c) TRB
  - *Highway Capacity Manual* (1985)
- (d) FHWA
  - A Guide to Highway Safety Design and Operating Practices
  - *Manual of Uniform Traffic Control Devices for Streets and Highways*
  - *Traffic Control Devices Handbook*
- (e) ITE
  - *Traffic Engineering Handbook*
  - Traffic Engineering (Magazine)
- (f) Others
  - Man-Made America, Chaos or Control? Tunnard and Pushkarev
  - The Freeway in the City A Report to the Secretary, DOT, by the Urban Advisors to the Federal Highway Administrator

### **(6) Economics**

- (a) WSDOT
  - Land Economic Studies
- (b) AASHTO
  - Road User Benefit Analysis for Highway Improvements

### **(7) General**

- (a) WSDOT
  - Annual Accident Report
  - Department Publication Systems
  - Operating Instructions
  - Quarterly Accident Reports
- (b) State of Washington
  - Laws of the Washington State Legislature
  - Washington Administrative Code
- (c) AASHTO
  - AASHTO Highway Definitions
  - AASHTO Proceedings
  - American Highways (Magazine)
  - Numerology Map for Interstate System
- (d) FHWA
  - *Federal-Aid Highway Program Manual*
  - Public Roads (Magazine)
- (e) TRB
  - Highway Research Bulletins, Abstracts, Records and Reports
- (f) ASCE
  - Journals, Proceedings, Abstracts, etc.



## **(8) Hydraulics**

- (a) WSDOT
  - *Hydraulics Manual*
  - Hydraulic Charts for the Selection of Highway Culverts
- (b) FHWA
  - Aesthetics of Highway Drainage Design by Carl F. Izzard
  - Design Charts for Open Channel Flow
  - Design of Roadside Drainage Channels
  - Design of Bridge Waterways
- (c) USGS
  - Floods in Washington
  - Miscellaneous Reports on Design Flows and Drainage Area Data
- (d) AASHTO
  - Highway Drainage Guidelines

## **(9) Illumination**

- (a) AASHTO
  - Guide for Roadway Lighting

## **(10) Roadside Development**

- (a) WSDOT
  - Policy on Roadside Development and Highway Beautification
- (b) AASHTO
  - Guide for Hwy. Landscape & Environmental Design
  - Policy on Landscape Development — Interstate System
  - Inspection Guide for Landscape Planting
  - Guide on Safety Rest Areas — Interstate
- (c) Other
  - American Standard for Nursery Stock
  - Safety Rest Area — Planning, Location and Design (USDOT)

## **(11) Environmental**

- (a) FHWA
  - National Environmental Policy Act
  - Council on Environmental Quality Guidelines
  - *Federal Aid Highway Program Manual*
  - Federal Laws and Regulations
- (b) WSDOT
  - Policy Directives
  - EIS — Environmental Assessment Outlines
  - *Environmental Procedures Manual* (M 31-11)
- (c) State of Washington
  - State Environmental Policy Act

- Department of Ecology Permit Directory

## **(12) R/W and Access**

- (a) WSDOT
  - Limited Access Establishment
  - Relocation Assistance Program Interim Operating Procedures
  - *Right of Way Manual*
  - Road Approaches to State Highways
  - Utilities Accommodation Policy
  - *Utilities Manual*
- (b) AASHTO
  - Guide for Accommodating Utilities on Hwy. R/W
  - Info. Guide for Training R/W Personnel
  - Guide on Fencing Controlled Access Hwys.
  - Policy on Accommodation of Utilities — Freeways

## **(13) Maintenance**

- *AASHTO Bridge Maintenance Manual*
- *AASHTO Maintenance Manual*
- Maintenance Inspection of Bridges
- Informational Guide for Methods and Procedures in Contract Maintenance
- Informational Guide for Physical Maintenance

## **(14) Materials**

- (a) AASHTO
  - Standard Specifications for Highway Materials and Methods of Sampling and Testing

## **(15) Photogrammetry**

- (a) WSDOT
  - *Manual for Photogrammetry*
  - Standard Specifications for Photogrammetry

## **(16) Survey**

- (a) WSDOT
  - *Highway Engineering Field Tables*
  - *Highway Surveying Manual* (M 22-97)

## **(17) Traffic Control and Operations**

- (a) WSDOT
  - *Traffic Manual* (M 51-02)
  - Sign Fabrication Manual
  - Supplement to MUTCD
- (b) AASHTO
  - Driver Expectancy Checklist
  - Guide for Motorist Aid Systems
  - Report by the Special Freeway Study and Analysis Committee

- Specifications for Design and Construction of Structural Supports for Highway Signs
- (c) TRB and FHWA
- Increasing the Traffic Carrying Capacity of Urban Arterial Streets (Wisconsin Ave. Study)
  - *Manual of Uniform Traffic Control Devices for Streets and Highways*
  - Report No. FHWA-RD-76-73 “State of the Art on Roadway Delineation Systems”
  - *Traffic Control Devices Handbook*
- (d) ITE
- *Traffic Engineering Handbook*
  - Traffic Engineering (Magazine)
- (e) ENO Foundation
- Misc. Special Reports
  - Traffic Quarterly
- (f) Association of American Railroads
- Grade Crossing Protection Unit of Train Operation, Control and Signals
  - Railroad-Highway Grade Crossing Warning Systems-Bulletin No. 7

120.01	General
120.02	References
120.03	Definitions
120.04	Legislation and Policy Development
120.05	Planning at WSDOT
120.06	Linking Transportation Plans
120.07	Linking WSDOT Planning to Programming

### 120.01 General

Planning is a decision making process used to solve complex, interrelated problems. Transportation needs are typically identified by various transportation interests including local, regional, and state governments; businesses; and community groups. The needs are then evaluated in the framework provided by local, regional, and state land use and transportation policies and by state and federal laws. Identified transportation needs are also evaluated based on projected fiscal constraints.

The result of the statewide planning process is a list of transportation strategies (projects, activities, and services); consistent with local, regional, and state policies; and supported by the general public through the public involvement process.

Ultimately, the planning process constrains the strategies, based on projected available resources, and determines which transportation projects may be selected for programming, design, and construction. The goal is to create an integrated transportation system capable of supporting a vital economy, vibrant communities, and a sustainable environment.

### 120.02 References

Transportation Equity Act for the 21<sup>st</sup> Century (TEA-21) of 1998

*Code of Federal Regulations (CFR)*

23 CFR 450 subpart B, “Statewide Transportation Planning”

23 CFR 450 subpart C, “Metropolitan Transportation Planning and Programming”

40 CFR, “Clean Air Act,” parts 51 and 93

*United States Code (USC)* 23 USC 134, “Metropolitan planning”

23 USC 135, “Statewide planning”

*Revised Code of Washington (RCW)*

RCW 35.58.2795, “Public transportation systems — Six-year transit plans.”

RCW 35.77.010(2), “Perpetual advanced six-year plans for coordinated transportation program expenditures — Nonmotorized transportation — Railroad right-of-way”

RCW 36.70A, “Growth management — Planning by selected counties and cities”

RCW 36.81.121(2), “Perpetual advanced six-year plans for coordinated transportation program, expenditures — Nonmotorized transportation — Railroad right-of-way”

RCW 47.05, “Priority Programming for Highway Development”

RCW 47.06, “State-Wide Transportation Planning”

RCW 47.38, “Roadside Areas - Safety Rest Areas”

RCW 47.39, “Scenic and Recreational Highway Act of 1967” and changes thereto

RCW 47.50, “Highway Access Management”

RCW 47.76.220, “State rail plan - Contents”

RCW 47.80, “Regional Transportation Planning Organizations”

RCW 70.94, “Washington Clean Air Act”

*Washington Administrative Code (WAC)*

WAC 468-51 and 52, “Highway Access Management”

WAC 468-86, “RTPO Planning Standards and Guidelines”

*Roadside Manual*, M 25-30, WSDOT

## 120.03 Definitions

<b>ARB</b>	Agency Request Budget
<b>B/C</b>	Benefit/Cost
<b>CFR</b>	<i>Code of Federal Regulations</i>
<b>CLB</b>	Current Law Budget
<b>CMP</b>	<i>Corridor Management Plan</i>
<b>FAST Corridor</b>	Freight Action Strategy for the Everett-Seattle-Tacoma Corridor
<b>FGTS</b>	Freight and Goods Transportation System
<b>FHWA</b>	Federal Highway Administration
<b>FTA</b>	Federal Transit Administration
<b>GMA</b>	Growth Management Act
<b>HSP</b>	<i>State Highway System Plan</i>
<b>HSS</b>	Highways of Statewide Significance
<b>ISTEA</b>	Intermodal Surface Transportation Efficiency Act of 1991
<b>LOS</b>	Level of Service
<b>MTIP</b>	Metropolitan Transportation Improvement Program
<b>MPO</b>	Metropolitan Planning Organization
<b>OSC</b>	Olympia Service Center
<b>OUM</b>	Office of Urban Mobility
<b>PSRC</b>	Puget Sound Regional Council
<b>RCW</b>	<i>Revised Code of Washington</i>
<b>RDP</b>	<i>Route Development Plan</i>
<b>RTIP</b>	Regional Transportation Improvement Program
<b>RTPO</b>	Regional Transportation Planning Organization
<b>SEPA</b>	State Environmental Policy Act
<b>SHSP</b>	<i>State Highway System Plan</i> also known as the HSP
<b>STIP</b>	Statewide Transportation Improvement Program
<b>TDM</b>	Travel Demand Management

**TEA-21** Transportation Equity Act for the 21<sup>st</sup> Century of 1998

**TIP** Transportation Improvement Program

**TPO** Transportation Planning Office

**USC** *United States Code*

**WAC** *Washington Administrative Code*

**WSDOT** Washington State Department of Transportation

**WTP** *Washington's Transportation Plan*

## 120.04 Legislation and Policy Development

The Washington State Legislature requires the Washington State Department of Transportation (WSDOT) to plan, develop, maintain, and preserve the transportation network in accordance with all state laws and federal requirements. The Washington State Transportation Commission interprets these requirements into a set of policies that guide the process.

The Washington State Transportation Commission consists of seven members who are appointed by the Governor. This body serves as the board of directors for WSDOT and provides oversight to ensure that the department delivers a quality, multimodal transportation system that moves people and goods safely and efficiently. The Commission also develops plans and funding recommendations for Legislative approval.

The following are highlights of important federal and state legal requirements that influence or direct planning activities at WSDOT. These legal requirements must be satisfied for WSDOT to expend federal and state transportation funds.

### **(1) Federal Law: Transportation Equity Act (TEA-21)**

The Transportation Equity Act (TEA-21), passed in 1998, authorizes highway safety, transit, and other surface transportation programs through the year 2004. TEA-21 continues the trend initiated in 1991 by the Intermodal Surface Transportation Efficiency Act (ISTEA). ISTEA brought closure to the federal Interstate highway construction era and ushered in new methods of distributing federal transportation dollars.

TEA-21 gives local agencies a strong voice and reaffirms the importance of statewide and metropolitan transportation planning activities at the state and regional levels. Below is a list of important federal planning requirements.

(a) **Statewide Planning.** 23 USC 135 and 23 CFR 450 — subpart B outline the federal requirements for statewide planning by state departments of transportation.

(b) **Metropolitan Planning.** 23 USC 134 and 23 CFR 450 subpart C — outline the federal requirements for Metropolitan Planning Organizations (MPO).

Each urbanized area (population 50,000 or more) must have an MPO to receive and expend federal transportation capital or operating assistance. Presently, there are eight MPOs in Washington state. (See Figure 120-1.) They are:

- Benton-Franklin Council of Governments (BFCOG)
- Southwest Washington RTPO (SWW) (Cowlitz-Wahkiakum area)
- Puget Sound Regional Council (PSRC)
- SWW Regional Transportation Council (RTC) (Clark County area)
- Spokane Regional Transportation Council (SRTC)
- Thurston Regional Planning Council (TRPC)
- Whatcom County Council of Governments (WCCOG)
- Yakima Valley Council of Governments (YVCOG)

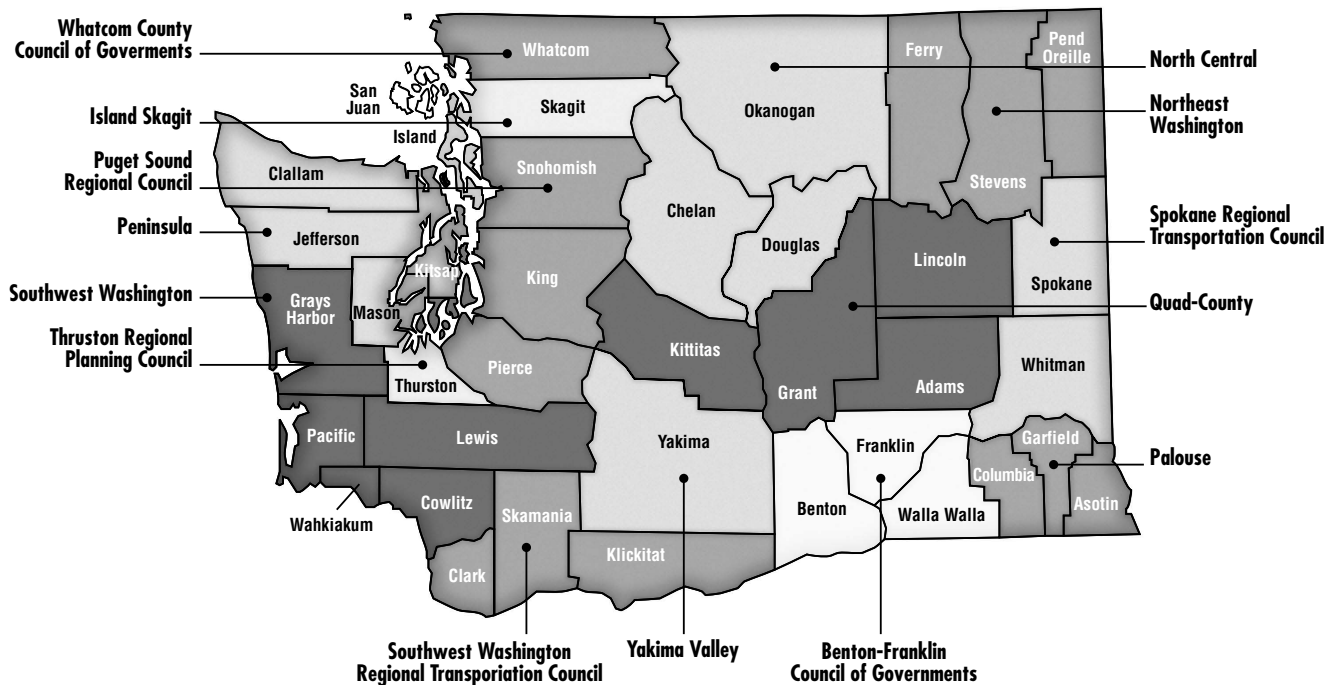

## Planning Organizations

Figure 120-1

These organizations include the metropolitan areas prescribed by federal law and also serve as the Regional Transportation Planning Organizations (RTPO) (in some cases covering a larger area). MPOs with a population over 200,000 are also designated as Transportation Management Areas.

Each MPO has a transportation policy board consisting of local elected officials from cities and counties, and representatives from ports, transit agencies, tribes, WSDOT, major employers, the general public, and other local transportation interests. Typically, each MPO also has a technical committee composed of staff from local planning and public works departments, and WSDOT regions.

The results of this transportation planning process are transportation plans and programs that are consistent with, and implement local comprehensive plans. The MPO planning process provides for:

- A forum for gaining local consensus on local transportation needs.
- The creation of a metropolitan transportation plan identifying future transportation facilities and services needed to support and implement local comprehensive plans.
- Targeted transportation studies used to develop the metropolitan transportation plan.
- A forum to decide how to allocate certain categories of transportation funds.
- The development of a three-year list of facilities and services (to be funded by member organizations) called the Metropolitan Transportation Improvement Program (MTIP).

Metropolitan transportation plans provide a main building block for the development of *Washington's Transportation Plan* created by WSDOT.

## **(2) State Laws: Planning Mandates Shape Project Selection**

The state of Washington has adopted several important laws affecting transportation planning at various levels. These laws provide the frame-

work for transportation decision making, ultimately guiding the programming, design, and construction of transportation facilities and services. The following is a list of the state laws having the most profound impact.

(a) **Statewide Transportation Planning (RCW 47.06).** This set of laws establishes that “. . . the state has an appropriate role in developing statewide transportation plans.” RCW 47.06 specifies that state owned transportation facilities and services, as well as those of state interest, must be addressed in these plans and that these plans shall guide short-term investment decisions and long range vision for transportation system development.

(b) **Washington's Transportation Plan (WTP).** The WTP provides guidance for the development, maintenance, and operation of a comprehensive and balanced multimodal transportation system. The overall direction of the WTP, prepared pursuant to RCW 47.06, is provided by the Washington State Transportation Commission. The WTP provides the direction for investment decision-making at WSDOT for all modes of transportation.

The WTP includes the following subjects concerning all major transportation modes:

- Meeting the federal requirements identified in TEA-21.
- Critical factors affecting transportation.
- Important issues concerning each mode and strategies to solve the problems.
- Plans for development and integration of the various modes of transportation.
- Major improvements in facilities and services to meet transportation needs.
- Financial resources required to implement the recommendations.

The WTP is a dynamic plan that is updated on a regular basis to address changing conditions. Information and recommendations for the plan are received from WSDOT regions and the Olympia Service Center (OSC), Metropolitan Planning Organizations, Regional Transportation

Planning Organizations, local governmental agencies, private transportation operators, and the public.

The WTP addresses transportation facilities owned and operated by the state, including state highways, Washington State Ferries, and state-owned airports. It also addresses facilities and services that the state does not own, but has interest in. These include public transportation, freight rail, intercity passenger rail, marine ports and navigation, nonmotorized transportation, and aviation.

(c) **State Highway System Plan (SHSP or HSP).** The *State Highway System Plan* is the highway component of the broader WTP. The HSP defines *Service Objectives*, *Action Strategies*, and costs to plan for, maintain, operate, preserve, and improve the state highway system for the next 20 years.

The HSP is financially constrained, meaning that some of the transportation strategies in the plan can be constructed with projected financial resources. It also includes strategies that are excluded from the constrained plan but are, nonetheless, identified as needs to be met if and when funding is available.

Because needs listed in the HSP far outstrip projected revenue, the Transportation Commission established a set of priorities for funding projects. (See the *State Highway System Plan*.) The Commission has adopted ten Service Objectives and fifty-three Action Strategies as a way to establish a logical process for identifying and categorizing projects that will receive funding in the next 20 years. These service objectives and action strategies provide the framework for defining 20-years of needs on the state highway system for the HSP. Work that does not fit within one of these 53 action strategies will not be authorized and is not considered in the development of the HSP, the Statewide Transportation Improvement Program (STIP) or any budget proposal.

The HSP is updated every two years, in coordination with local plan updates, to reflect completed work and changing transportation needs, policies, and revenues.

A conceptual solution (project) must be included in the HSP for funding to be allocated to the improvement strategy.

(d) **The Growth Management Act (RCW 36.70A).** Enacted in March 1990, the state's Growth Management Act (GMA) requires cities and counties that meet certain population or growth-rate thresholds to adopt comprehensive plans. Jurisdictions that are required to or choose to plan under the GMA must also adopt and enforce ordinances that implement the policies adopted in the comprehensive plans.

A comprehensive plan is a series of coordinated policy statements and formal plans that direct growth. Comprehensive plans articulate how a community will be developed in the future. They include elements that address housing, utilities, capital facilities, economic development, land use, and transportation.

The law requires that the transportation element be consistent with and support the land use element. In Washington, the comprehensive plan carries the force of law and must be developed with full participation by the general public.

Continuous coordination and open discussion during the development of local comprehensive plans are key to developing a valid plan for the growth of the community. Representatives from neighboring jurisdictions, special purpose districts, WSDOT, and others must be involved at the beginning of and throughout the planning process to ensure that the comprehensive plan is consistent with all other state and local plans.

Local comprehensive plans are important to WSDOT because they control how state facilities within the community will be addressed, how state highways will be impacted by local land use, and how access requirements will be met or maintained.

WSDOT seeks to work in partnership with local governments as they develop local comprehensive plans to ensure a balance between the need for mobility and access, while emphasizing design components that improve or maintain the livability of communities. WSDOT reviews and comments on local comprehensive plans and amendments whenever possible.

To avoid unnecessary conflicts and project delays, it is highly recommended that anyone involved in the design of a state facility review local comprehensive plans and initiate early contact with local governments before the design stage.

(e) **Regional Transportation Planning Organizations (RTPOs)** (RCW 47.80.020). Washington has two types of “regional” or “area wide” transportation planning organizations. One type, with populations over 50,000, the MPO, was already introduced in (1)(b) on federal laws. The other type, the Regional Transportation Planning Organization (RTPO), are voluntary organizations enabled under state law. Where MPOs existed before RTPOs were enabled, the MPOs became the RTPOs by including rural areas in their plans.

Although voluntary, all cities, counties, ports, tribes, and transit agencies are usually listed as members of an RTPO and their participation is their best way to influence local and statewide transportation planning.

RTPOs perform the same overall functions as MPOs and, like MPOs, provide a forum for information exchange and collective decision making between local governments and WSDOT. WSDOT is represented on each RTPO Policy Board and technical advisory committee.

Fourteen RTPOs exist in Washington State, covering all counties of the state except San Juan County. (See Figure 120-1.) In addition to the eight listed as including MPOs in 120.04(1)(b), there are the following six RTPOs:

- Skagit/Island RTPO
- North Central RTPO (NCRTP)
- Palouse Economic Development Council RTPO
- Peninsula RTPO
- QUADCO RTPO (central)
- Northeastern Washington RTPO (N. E. W.)

(f) **Transportation Facilities and Services of Statewide Significance** (RCW 47.06.140). The Legislature has declared certain transporta-

tion facilities and services, which promote and maintain significant statewide travel and economic development, to be of statewide significance.

Transportation facilities and services of statewide significance are considered essential state public facilities. (See RCW 36.70A.200.) Essential state public facilities cannot be precluded from operation or expansion by local comprehensive plans and development regulations. This means that the state interest in these facilities and services takes precedence over local interests in the planning process.

Therefore, planning for these transportation facilities and services must be conducted with a statewide perspective in mind. WSDOT, in consultation with others, is responsible for development of a statewide, multimodal plan for these facilities and services. The balance between providing for the free movement of people and goods and the needs of local communities is the main consideration.

Highways of Statewide Significance (HSS) are one category of transportation facilities and services of statewide significance. The HSS system was established by the Washington State Transportation Commission, and approved by the Legislature, to identify significant state-owned transportation facilities. The HSS system was also established to define the state and MPO/RTPO roles regarding planning for these facilities.

The HSS includes the Interstate highway system, interregional state principal arterials, and ferry connections that serve statewide travel.

WSDOT, in consultation with others, makes the final decision regarding the acceptable Level of Service (LOS) for highways of statewide significance. The MPOs and the RTPOs, in consultation with WSDOT, set the acceptable LOS on other state highways.

(g) **Functional Classification of Highways and Roadways** (RCW 47.05.021). Functional classification is the grouping of highways, roads, and streets that serve similar functions into distinct systems or classes within the total existing or future highway network. The



objective of functional classification is to define the appropriate role (mobility versus access) of various highways in providing service and influencing development. Generally, the higher functional classification routes provide mobility with higher travel speed and serve longer distance travel. The lower functional classification routes focus on providing access to the land. Functional classification is important in:

- Identifying routes for inclusion in the National Highway System.
- Providing the basis for administering the Surface Transportation Program.
- Determining design levels for a specific route.
- Planning.
- Determining and establishing jurisdictional responsibility.
- Establishing access control.
- Providing information for land use plans and decisions.
- Conducting needs assessments and cost allocation studies.
- Helping to determine the level of maintenance.
- Conducting the priority programming process.

All state highways are subdivided into three functional classifications. See Chapter 440, “Full Design Level,” for definitions of the collector, minor arterial, and principal arterial classifications.

(h) **Freight and Goods Transportation System (FGTS).** The FGTS is an effort caused by the increasing interest in freight mobility. The FGTS is required by RCW 47.05.021 section 4. It states:

“The transportation commission shall designate a freight and goods transportation system. This statewide system shall include state highways, county roads, and city streets. The commission, in cooperation with cities and counties, shall review and make

recommendations to the legislature regarding policies governing weight restrictions and road closures which affect transportation of freight and goods.”

The FGTS established the tonnage classifications for each state highway, county road, and city street. Ultimately, tonnage influences the funding and design of new facilities or reconstruction of existing facilities.

(i) **Access Control** (RCW 47.50, WAC 468-51, and WAC 468-52). Access control is a program that combines traffic engineering and land use regulatory techniques. Access control balances the desire for access (from adjacent properties to streets and highways) with other elements such as safety, preservation of capacity, support for alternative transportation modes, and preservation and enhancement of communities.

There are two forms of access control: limited access control and managed access control. (See Chapter 1420, “Access Control Design Policy.”) For limited access control, WSDOT purchases the right to limit access to a highway. Managed access control is a regulatory program established by a state law that requires that access to state highways in unincorporated areas be managed by WSDOT to protect the public and preserve highway functionality.

WSDOT has established plans for access control that are consulted when planning transportation improvement strategies. They are the Master Plan for Limited Access Highways and the regional Highway Access Management Classification Reports.

## 120.05 Planning at WSDOT

The role of planning at WSDOT is to identify transportation needs and facilitate the development and implementation of sound, innovative investments and strategies. Many groups within WSDOT conduct planning activities that directly or indirectly influence the design of transportation facilities.

Several modes of transportation are represented by these groups, which advocate, provide technical assistance, and fund and implement programs, projects, and services.

The following is a list of those groups, their roles, and their effect on the design of transportation facilities.

### **(1) Transportation Planning Office**

Three major responsibilities of the Transportation Planning Office (TPO), of the Planning and Programming Service Center in OSC, are to:

- Oversee the development of *Washington's Transportation Plan* (WTP).
- Coordinate planning activities and provide technical assistance to WSDOT regions, Metropolitan Planning Organizations (MPOs), and Regional Transportation Planning Organizations (RTPOs).
- Collect and process data, conduct studies, and develop travel forecasts.

#### **(a) Washington's Transportation Plan (WTP).**

The Transportation Planning Office coordinates the development of the WTP in partnership with other WSDOT organizations and the MPOs and RTPOs. See 120.04(2)(b) for a description of the WTP.

**(b) OSC Regional Planning.** The Regional Planning Branch of the Transportation Planning Office coordinates planning activities and provides technical assistance to WSDOT regions, the Office of Urban Mobility, eight MPOs, and fourteen RTPOs.

The Regional Planning Branch provides management oversight of the MPOs to ensure fulfillment of federal urban transportation planning regulations in 23 USC 134, and the RTPOs regarding state requirements in RCW 47.80, WAC 468-86, and the WSDOT Regional Planning Standards. The Regional Planning Branch also administers federal and state planning grants for these organizations

**(c) Travel Forecasting.** Travel forecasting and analysis are fundamental to planning and project development at WSDOT. These technical methods provide data for:

- Determining the location of congestion and the extent to which various strategies solve congestion problems.

- Benefit/cost analyses.
- Project design.
- Safety analyses.
- System performance.

See Chapter 130 regarding the data and services available.

### **(2) Public Transportation and Rail Division**

The Public Transportation and Rail Division works to enhance mobility options by managing, coordinating, and advocating for rail and public transportation programs throughout the state. The division's mission is to improve transportation choices, connections, coordination, and efficiency. The division promotes freight rail programs and, in cooperation with Amtrak, passenger rail programs. The division also provides planning, project oversight, financial, and technical assistance to public transportation providers in urban and rural areas. Division staff oversees the State Commute Trip Reduction Program and provides technical assistance and grants to help reduce vehicle miles traveled by commuters in urban regions of the state.

Public Transportation and Rail Division's plans and programs add value to highway and roadway design decisions by emphasizing enhancement, improvement, and coordination of intermodal connections. It is recommended that these plans and programs be referenced during the design process to ensure intermodal coordination and efficiency.

**(a) Public Transportation Office.** Programs of the Public Transportation Office support passenger transportation systems and services through grants, technical assistance, research, and planning. The office works in partnership with local communities and governments to promote, improve, and expand public transportation resources, and accessibility to those resources, for the state. The major emphases in the Public Transportation program are:

- Implement projects and strategies identified in the *Public Transportation and Intercity Rail Passenger Plan for Washington State and Washington's Transportation Plan*.

- Identify, support, coordinate, and monitor the planning, capital, and operating funding needs of small urban and rural public transportation providers.
- Improve effectiveness and efficiency of public transportation through training, technical assistance, and coordination to all agencies engaged in public transportation including nonprofit agencies, and private-for-profit bus and taxi companies.
- Establish mobility options in areas where public transportation is limited or does not exist.
- Develop, implement, and manage grant programs to enhance and sustain statewide mobility.
- Monitor compliance for safety, including the drug and alcohol programs of rural public transportation providers.

(b) **Rail Office.** Intercity passenger rail and freight rail are the focus of this office. Amtrak intercity rail service and freight rail service are an important part of our state transportation system. Moving people and goods by rail is often safer and more environmentally friendly than adding traffic to our already congested highways. Improvements to the state's rail system, whether funded by the private sector or the public sector, can help mitigate the impacts of our fast growing economy and population.

The *Intercity Rail Passenger Plan for Washington State* defines a system that links major population centers throughout the state and provides the blueprint for needed improvements to these intercity rail systems. The plan emphasizes incrementally upgrading the Amtrak passenger rail system along the Pacific Northwest Rail Corridor in western Washington. The vision is to reduce travel times and provide better passenger rail service in the Pacific Northwest. Additional activities are underway in the corridor, requiring extensive coordination among various agencies and private organizations. The corridor also serves some of the world's busiest ports. WSDOT is working with the Puget Sound Regional Council and other area agencies through the Freight Action Strategy for the

Everett-Seattle-Tacoma Corridor (FAST Corridor) project to plan for the elimination of at-grade highway/railroad crossing conflicts and to improve port access.

The *Washington State Freight Rail Plan* fulfills a Federal Railroad Administration requirement that the state establish, update, and revise a rail plan. It also fulfills the Washington State Legislative directive (RCW 47.76.220) that WSDOT prepare and periodically revise a state rail plan that identifies, evaluates, and encourages essential rail services. The plan identifies the abandonment status of various rail lines, provides analysis of the various alternatives to these proposed abandonment's, and provides recommendations that are incorporated into *Washington's Transportation Plan*.

(c) **Transportation Demand Management Office.** The Transportation Demand Management (TDM) Office advocates for, creates, and develops effective solutions to capacity constraints within the state transportation system. TDM Office staff provide support and technical assistance within WSDOT, and for external transportation organizations, so demand management programs can be implemented whenever such programs are appropriate and cost effective. Program support is provided in areas such as land use planning, TDM research, parking management, high capacity transportation planning, and policy development for the state's freeway high occupancy vehicle system.

The office also assists public and private employers, jurisdictions, and other interested parties with implementation of RCW 70.94.521 through 551. The goal of the commute trip reduction portion of this law is to reduce air pollution, traffic congestion, and the consumption of fossil fuels. Its focus is to get employees who drive to work alone to consider commute trip alternatives.

The TDM Office provides leadership through developing policies and guidelines that help direct public and private investment in the state's transportation system. A key emphasis of the TDM Office is to develop and maintain a TDM Strategic Plan for WSDOT. This plan will help ensure that *Washington's Transportation Plan* and all other internal planning processes

incorporate TDM activities. Regional and local TDM activities and planning functions are further supported by the TDM Office through coordination and implementation of statewide TDM programs, providing public information and marketing tools, and providing training opportunities. The office also administers local TDM grant programs and planning grants that facilitate high capacity transportation development in certain urban areas of the state. The TDM Office also manages the program to monitor safety and security on light rail systems in Washington State.

### **(3) Highways and Local Programs Service Center**

The Highways and Local Programs Service Center includes many important subprograms and offices. The Service Center helps Washington's local agencies develop their local transportation projects and qualify for federal and state funding to cover some of their project costs. This Service Center provides oversight, technical support, and training to help ensure effective delivery of projects being developed by cities, counties, ports, transit, tribes, Metropolitan Planning Organizations, Regional Transportation Planning Organizations, scenic byway organizations, other state and federal agencies, and private nonprofit agencies.

This Service Center coordinates the development of the *State Highway System Plan* (HSP) and the Statewide Transportation Improvement Program (STIP) in partnership with other WSDOT organizations and the MPOs and RTPOs. See discussions of the HSP at 120.04(2)(c), and the STIP at 120.06(3).

Another role of the Highways and Local Programs Service Center is to advocate for meeting highway and local roadway needs and to help to preserve, operate, and enhance Washington's roadways, walkways, and bike routes. This service center is Washington's designated state scenic byways agency.

(a) **Bicycle and Pedestrian Program Office (Nonmotorized)**. The Highways and Local Programs Service Center is responsible for

developing bicycle and pedestrian plans and programs to implement the nonmotorized objectives established by the Transportation Commission. The Bicycle and Pedestrian Program Office in the Olympia Service Center assists design engineers with mode-specific questions. To guide the actions of this office, and those working in the design offices, the Transportation Commission has adopted a *Bicycle Policy Plan* and a *Pedestrian Policy Plan*.

The *Bicycle Policy Plan* addresses four policy issues; bicycle facilities, funding, safety education and enforcement, and promoting bicycling commuting and touring. The plan also identifies the existing state roadway system as the basic network for bicycle travel. The Plan also calls for the road and bridge system to be maintained and improved to help ensure safe access by bicyclists.

WSDOT has a Bicycling Advisory Committee made up of seven citizens. Each citizen represents a region (two for the Northwest Region). The role of the committee is to advise the department on policies, issues, and needed bicycle projects and to provide insight into local bicycle issues and use around the state.

The *Pedestrian Policy Plan* focuses on local and areawide planning for pedestrians, and necessary pedestrian facility types and locations. It calls for:

- Providing pedestrian facilities that complement local business activity.
- Enhancing intermodal access (especially for those with mobility impairments).
- Maintaining the existing transportation system adequately to maximize pedestrian use.

The *State Highway System Plan* identifies four categories of bicycle and pedestrian projects:

- **Urban Bicycle Projects:** Building short sections of trails along or across state highways to complete local bicycle networks.
- **Rural Bicycle Touring Routes:** Shoulder improvements along sections of designated state routes.

- Pedestrian Accident Locations: Projects on sections of state routes that have four or more pedestrian-and-motor-vehicle collisions over a six year period.
- Pedestrian Risk Locations: Projects on sections of state routes that have a risk for pedestrian-and-motor-vehicle collisions because of pedestrian activity, traffic conditions, and roadway geometrics.

**(b) Heritage Corridors Program Office.**

The purpose of the Heritage Corridors Program is to preserve the unique scenic character along Washington's transportation corridors, and to provide travelers with a continuing opportunity to appreciate and obtain information regarding unique natural, recreational, cultural, and historical features that are near to or accessible by transportation routes.

The highways, waterways, and trails in Washington State are evaluated by diversely staffed committees to select the most significant corridors to be designated as Scenic Byways or Heritage Tour Routes. Once designated, the routes are identified on the Designated (scenic and recreational) State Highways map (available from the Heritage Corridors Program office). They then become eligible for grants and partnering efforts designed to sustain visual quality and to provide access to features of interest. Scenic Byway and Heritage Tour Route designations along with roadside classification categories (see the *Roadside Manual*) are the means to focus attention on roadside visual elements and the department's role in resource stewardship.

For designated routes, the use of Design Visualization technology is recommended (during the project definition phase) to help in the selection of roadside features such as guard-rail and retaining walls. (See Chapter 710.) If requested early enough, supplemental funding for visual enhancements might be available through the Heritage Corridors Program.

The Heritage Corridors Program office, in the Olympia Service Center, works with the regions and various external entities to develop a Corridor Management Plan (CMP) for each designated

route. Information from the CMPs is incorporated into Route Development Plans and from there the projects become part of the *State Highway System Plan*. This process implements the Transportation Commission's service objectives and action strategies related to heritage resources, thus implementing federal and state laws.

The *State Highway System Plan* includes projects designed to:

- Refurbish safety rest areas.
- Ensure public access to safety rest areas.
- Cooperatively promote and interpret heritage resources.
- Provide incentives for alternatives to outdoor advertising.
- Provide multimodal and visual access to heritage resources.
- Develop a statewide network of traveler information services.

Safety rest area information is in Chapter 610 of the *Roadside Manual*.

If a project is on a designated route that has an existing CMP, it will provide considerable information useful to highway designers including:

- Locations of hazards or poorly designed features and possible corrections.
- Plans for accommodating commercial and multimodal traffic.
- A signing plan.

The Heritage Corridors Program office also coordinates the following programs, products, and activities:

- National scenic byways grant administration and outreach.
- Visual & route assessment.
- Corridor Management Plan technical assistance.
- Safety rest area and traveler services plan.
- Route signing guidelines.
- Highway interpretative markers.

- Directional signing for the Watchable Wildlife Program.
- Alternatives to outdoor advertising
- Byway orientation panels.
- Heritage tour guides & brochures.

#### **(4) WSDOT Regions and the Office of Urban Mobility**

The roles of planning at WSDOT regions and at the Office of Urban Mobility (OUM) are similar in many ways. What follows are descriptions of the roles of planning at WSDOT regions and the OUM.

(a) **WSDOT Region Planning.** Each WSDOT region has a Planning Office that has several roles, such as:

- Conducting and overseeing special long range planning studies.
- Coordinating with other planning groups.
- Assisting in development of prioritized plans.
- Administering internal WSDOT programs.
- Exercising access control.
- Performing Developer Services.

For the Olympic and Northwest Regions, many of these planning functions are assigned to the Office of Urban Mobility.

The region Planning Office conducts long range planning studies such as for the *Route Development Plans*, Corridor Master Plans, and site-specific transportation alternatives and studies. These studies evaluate alternative solutions for both existing and projected transportation needs, initiate the long-range public involvement process, and ultimately provide the foundation for inclusion of identified improvement strategies into *Washington's Transportation Plan* (WTP) and the *State Highway System Plan* (HSP).

The region Planning Office coordinates with and assists the local Metropolitan Planning Organization (MPO) and Regional Transportation Planning Organization (RTPO). (See Figure 210-1.) In some cases, the region Planning Office provides the staff support for the local RTPO.

The region works with the Washington State Patrol to include their weigh site and other highway related needs in WSDOT projects.

Often, the region Planning Office is responsible for administering internal WSDOT programs such as traffic modeling, the Travel Demand Management program (TDM), and responding to citizen concerns about pedestrian, bicycle, and other transportation related issues.

Developer Services is the process of reviewing new developments affecting state highways, such as master planned communities, major subdivisions, and commercial projects. Developers provide mitigation for their impacts to the state highway system under the State Environmental Policy Act (SEPA).

The region's Planning Office also reviews and comments on local Comprehensive Plans so development regulations, local transportation elements, and WSDOT goals and interests can be consistent.

(b) **The Office of Urban Mobility in Seattle.** The Office of Urban Mobility (OUM), in the Planning and Programming Service Center, has a similar role to a region Planning Office yet the OUM role is more specialized. The OUM oversees long range planning efforts of WSDOT in the four-county Central Puget Sound area of King, Pierce, Snohomish, and Kitsap Counties. This is the same area covered by the MPO called the Puget Sound Regional Council (PSRC), located in Seattle. The four-county region is geographically split between WSDOT's Olympic and Northwest Regions. OUM also has the responsibility of coordinating future plans developed by Washington State Ferries with the strategies contained in the *State Highway System Plan*.

The creation of OUM was a response to challenging transportation issues in the rapidly growing Puget Sound area. As transportation challenges have required more intensive coordination in the Puget Sound area, the manner in which WSDOT approached these challenges also needed to change. OUM has greatly improved the coordination of transportation planning efforts between WSDOT, the Puget Sound Regional Council, the local cities, and the four counties.

The Office of Urban Mobility also participates in the review of documents mandated by the Growth Management Act (GMA). This includes the review of draft Comprehensive Plans as well as the Draft Environmental Impact Statements that provide supporting documentation to the Comprehensive Plans. In addition, OUM reviews Draft Environmental Impact Statements for local agency proposals that might affect the operation of state facilities.

Developer Services responsibilities remain with the Northwest and Olympic Region's Planning Offices.

### **(5) Washington State Ferries Division**

The *Long Range Ferry System Plan*, prepared by the Washington State Ferries Division, considers recent trends in ferry ridership, system costs, regional economy, and other system and site factors. It is recommended that designers contact the Washington State Ferries planning office during the design phase of any conceptual solution occurring near a ferry terminal or one that might add significant traffic to or around a ferry terminal.

### **(6) Aviation Division**

The Aviation Division is a nonregulatory agency that:

- Provides general aviation airport aid, including an award-winning lighting program.
- Provides technical assistance for airspace and incompatible land use matters.
- Coordinates all air search and rescue and air disaster relief.
- Administers pilot and aircraft registration.

This division is responsible for development of the *Washington State Airport System Plan*. The division also operates seventeen state airports strategically placed throughout the state.

## **120.06 Linking Transportation Plans**

The main concern of the traveling public is that the transportation system allows them to move from point A to point B quickly, safely, and with

the least inconvenience and expense. To fulfill the public demand, coordination of transportation planning efforts is essential to the creation of the seamless transportation system.

### **(1) Coordination of Planning Efforts**

Coordination of planning efforts between city, county, MPO, RTPO, public and private transportation provider, and state transportation plans is not only required by federal and state laws — it makes good business sense. Coordination of transportation planning is a cyclical process and begins as a bottom-up approach. Figure 120-2 is a diagram that explains the general relationships between the various transportation planning processes and organizations.

Cities and counties explore their needs and develop *comprehensive plans*. Among other components, each comprehensive plan contains a land use element and a transportation element, which must be consistent with each other. The transportation element (sometimes known as the *local transportation plan*) supports the land use element. The requirements in the Growth Management Act (see 120.04 (2)(d)) guide most of the comprehensive plans developed in the state of Washington.

MPOs and RTPOs coordinate and develop metropolitan and regional transportation plans. These plans cover multiple cities and, for RTPOs, encompass at least one county. The purpose of metropolitan transportation plans and regional transportation plans is to ensure that the policies, plans, and programs of each jurisdiction are consistent with neighboring jurisdictions.

Planning is undertaken to ensure consistent policy among all the various jurisdictions; whether state, regional, or local. It does not matter where the planning process begins because the process is both cyclic and iterative. If one component of a plan changes it may or may not affect other components. If any one plan changes significantly, it can affect each of the other plans in the cycle. Early communication and coordination of conceptual solutions are critical to ensuring project delivery.

## **(2) Transportation Improvement Programs**

Figure 120-3 shows the coordination of effort that produces consistent and comprehensive transportation plans and programs.

From these transportation plans, each town, city, county, and public transportation provider develops a detailed list of projects that will be constructed in the next three or six years. This detailed list of transportation projects is called the six year Regional Transportation Improvement Program also known as the Six-Year RTIP or the three-year Metropolitan Transportation Improvement Program (MTIP).

The six-year RTIP and the three-year MTIP must be financially constrained, meaning that the total cost of all projects cannot exceed the established revenue authority. Financially constraining the RTIP and the MTIP is one method used to ensure that the list of projects represents what the local agency intends to build in the near future to implement local transportation plans. Once each town, city, and county develops its individual TIP, the RTPO and the MPO compile these individual TIPs into a regional or metropolitan TIP.

See Figure 120-3.

Each RTPO/MPO completes a Regional or Metropolitan Improvement Program (RTIP or MTIP) at least once every two years (RCW 47.80.023). The RTIP/MTIPs must meet the requirements of both federal and state laws regarding transportation improvement programs and plans. To achieve this, the RTIP/MTIP:

- Is cooperatively developed by local government agencies, public transit agencies, and the Department of Transportation within each area.
- Includes all federally funded WSDOT Highway Construction Program projects.
- Includes all significant transportation projects, programs, and transportation demand management measures proposed to be implemented during each year of the next period.

- Identifies all significant projects, whether funded by state or federal funds.
- Includes all significant projects from the local transit development plans and comprehensive transportation programs required by RCW 35.58.2795, 35.77.010(2), and 36.81.121(2) for transit agencies, cities, towns, and counties.
- Includes all transportation projects funded by the Federal Highway Administration (FHWA) and the Federal Transit Administration (FTA).
- Includes all federally funded public lands transportation projects.
- Includes all WSDOT projects regardless of funding source and clearly designates regionally significant projects as such.
- Complies with all state (RCW 70.94) and federal (40 CFR 51 & 93) Clean Air Act requirements (where applicable).
- Includes only projects consistent with local, regional, and metropolitan transportation plans.
- Includes a financial section outlining how the RTIP/MTIP is financially constrained, showing sources and amounts of funding reasonably expected to be received for each year of the ensuing six/three-year period, and includes an explanation of all assumptions supporting the expected levels of funding.

Funding agencies give preference to jointly sponsored transportation projects. RTPOs and MPOs can develop jointly sponsored projects since they represent multiple agencies. Major projects backed by an RTPO or an MPO have an excellent chance of receiving funding.

## **(3) Development of the STIP**

An important role of the WSDOT Highways and Local Programs Service Center is to collect all RTIP, MTIP, and HSP projects and assemble all of the state and federally funded projects, and the projects of regional significance, into the (three-year) Statewide Transportation Improvement Program (STIP).



Development of a new STIP every two years is required by federal law in order to expend federal transportation dollars. The state of Washington, however, develops a new STIP each year to enhance project flexibility and to ensure project delivery.

The Governor's approval of the MTIPs; plus the Federal Highway Administration's, and the Federal Transit Administration's approval of the STIP; are required prior to expenditure of federal funds.

## 120.07 Linking WSDOT Planning to Programming

Figure 120-4 is a process flow chart describing the overall process that a conceptual solution must go through to receive funding. This chart also generally describes the links (the symbiotic relationship) between planning and program development. Project Definition is presented in Chapter 330, Design Matrices are in Chapter 325, and Environmental Documentation is in Chapter 220.

The role of WSDOT planning is to determine *what* facilities or services will be provided *where*. The role of WSDOT programming is to determine *when* the improvements will be provided. The WSDOT Program Management Office prioritizes the projects that are selected from the financially constrained *State Highway System Plan* component of *Washington's Transportation Plan*. (See 120.04(2)(b).)

See Chapter 140, "Programming," for a discussion of the programming process as a whole. Chapter 150, "Project Development," relates planning and programming to the process of developing a project.

### (1) The Role of the Program Management Office

Taking the HSP from the planning stage through the programming stage is the role of the Program Management Office of the Planning and Programming Service Center. The Program Management Office manages the statewide highway construction program including:

- Recommending subprogram funding levels.
- Developing project priorities.
- Preparing, executing, and monitoring the highway construction program.

One of the important processes the Program Management Office oversees is a process termed the *Programming Process*. The legislative authorization for this process is in RCW 47.05 under Priority Programming. The Programming Process is really the prioritization of projects that have been identified in the HSP. The Programming Process determines the order in which the needs (identified in each improvement category in the financially constrained HSP) are solved.

Subprogram categories for the service objectives and action strategies have been established, by the Transportation Commission, within WSDOT's budget to allow decision makers to determine timing and the amount of money to invest in solving transportation needs. (See the HSP for the service objectives and action strategies.) The order of the needs within each subprogram category is usually prioritized based on benefit/cost methodology; however, some subprograms do not have a prioritization methodology attached to them (such as Economic Initiatives).

The Commission may combine projects that are scheduled to be within a six-year time period to eliminate constructing projects at the same location just a few years apart.

Following completion of construction, the department evaluates the effectiveness that solving those needs had on the performance of the transportation system.

### (2) WSDOT Budgets

WSDOT uses the financially constrained *State Highway System Plan* component of the twenty-year *Washington's Transportation Plan* as the basis for prioritizing and programming to select projects for the Agency Request Budget (ARB) and Current Law Budget (CLB). To be selected, a project must already be included in the HSP and, if federally funded, the STIP.

Currently, WSDOT operates on a two-year funding cycle. This is primarily because the state Legislature appropriates state transportation funds on a biennial basis. To better implement the intent of federal and state laws influencing transportation and land use, to encourage a longer range perspective in the funding of transportation projects, and to be consistent with local and regional transportation planning processes, the Washington State Transportation Commission is developing a Six Year Plan Element. WSDOT's Six Year Plan Element will be used by the Commission to develop the two-year budget proposals.

When appropriated by the Legislature, WSDOT's two-year budget is forwarded to the appropriate RTPOs and MPOs for any needed revisions to the RTIPs and MTIPs.

### **(3) Key Points of Planning and Programming at WSDOT**

Below is a list of key points to remember about the planning and programming process:

- Commission Policy sets the direction for *Washington's Transportation Plan* (WTP).
- Federal transportation laws and state transportation and land use laws guide our solutions to the needs for transportation facilities and services.
- The WTP is developed in partnership with MPOs and RTPOs and is tied directly to the land use plans of towns, cities, and counties.
- The region's Planning Offices have the main responsibility for meeting many of the state and federal planning requirements.
- The *State Highway System Plan* is a component of the WTP.
- The *State Highway System Plan* sets forth service objectives and action strategies to implement Commission policy.
- A budget structure is developed to implement each action strategy.
- Conceptual solutions are prioritized within most budget categories based on benefit/cost analyses to obtain the greatest benefit.
- Tradeoffs between project categories are made by policy choice through a multitiered process (executives, Commission, and Legislature).
- An improvement strategy must be listed in the *State Highway System Plan* to be considered for project funding.
- If federally funded, a strategy must be listed in the Statewide Transportation Improvement Program to be considered for funding.

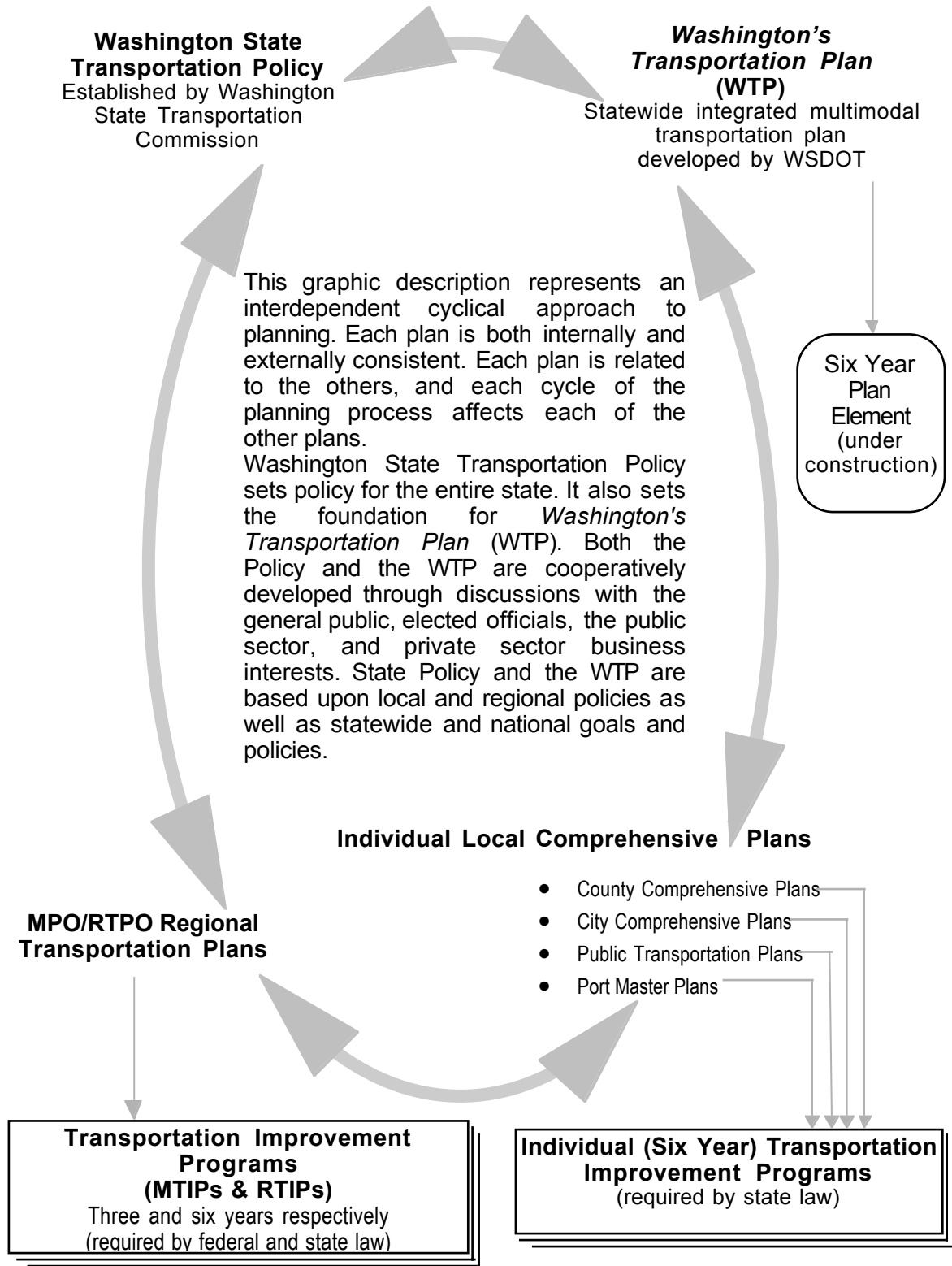

**Transportation Plan Relationships**

*Figure 120-2*

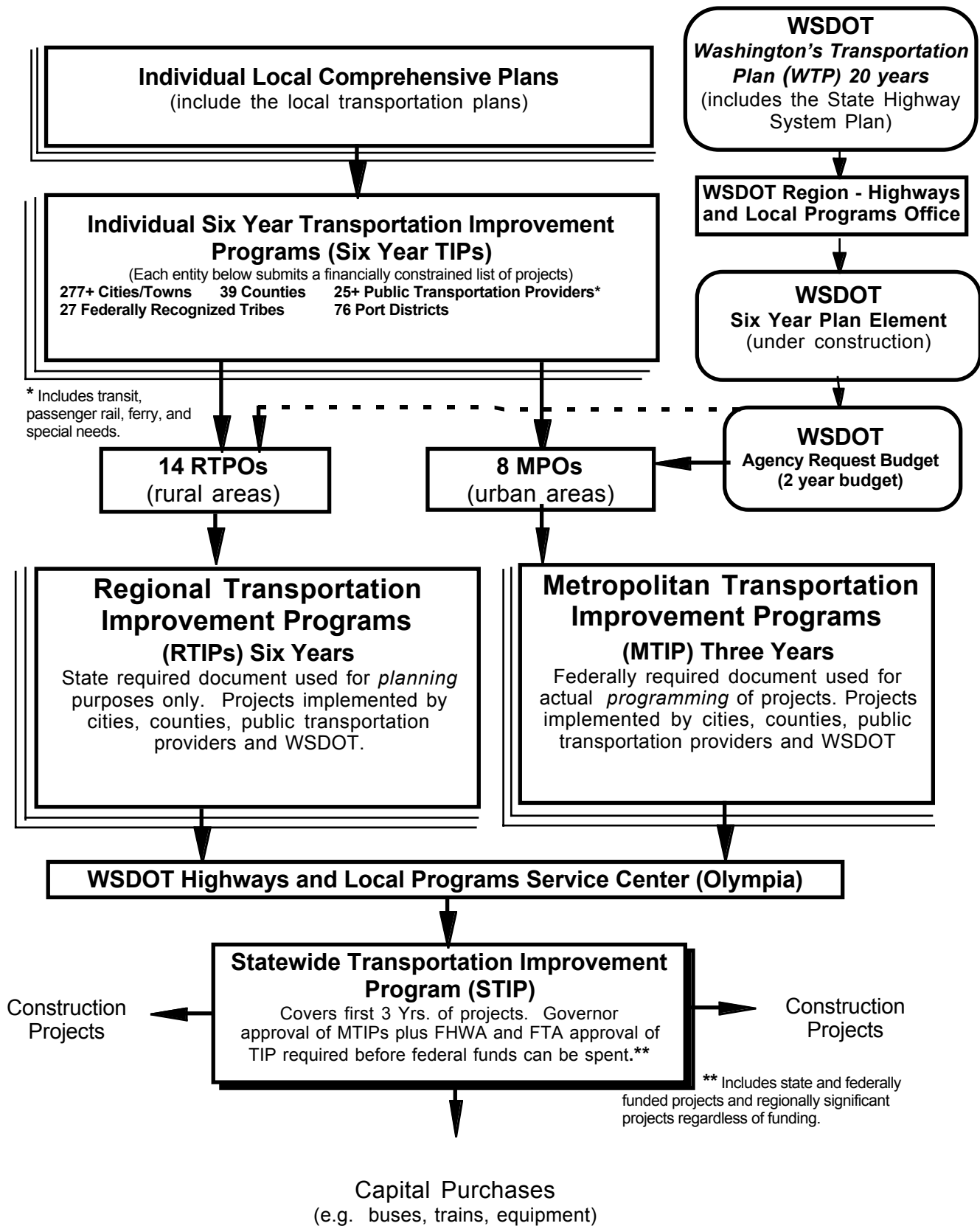

**RTIP, MTIP, and STIP Development Process**

Figure 120-3

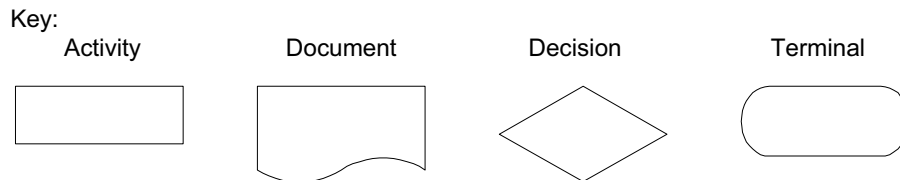
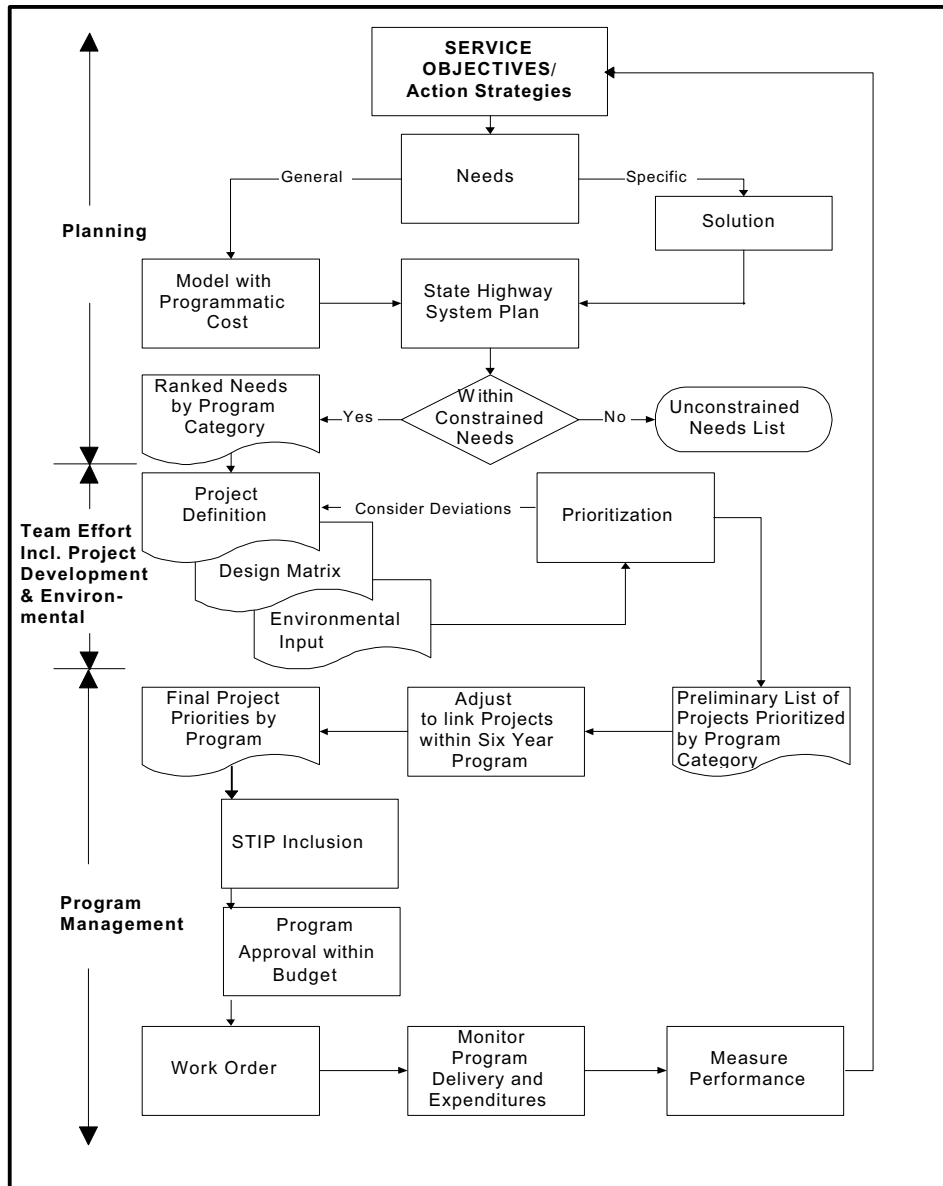

**Planning and Programming Links**  
*Figure 120-4*

# 130

## Systems Data and Services

- 130.01 Highway Performance Monitoring System
- 130.02 Travel Data and Traffic Analysis
- 130.03 Videologging
- 130.04 Photogrammetry Services

### 130.01 HIGHWAY PERFORMANCE MONITORING SYSTEM

The Highway Performance Monitoring System (HPMS) is a federal program of data collection and analysis. HPMS was started in 1978, and replaced a variety of reports, including the Mileage and Facilities Reporting System (MFRS). HPMS data furnished by the states forms the data base for a variety of analytical processes. These processes are the basis of the FHWA's report to Congress on the condition of the nation's highways. Special legislative requests and reports are also furnished using HPMS capabilities.

The Planning, Research and Public Transportation (PR&PT) Division's first responsibility to HPMS is to construct, maintain, and update the data base for the FHWA. Yearly data updates are due to the FHWA on June 15 of the following year.

The PR&PT Division is also upgrading the rate of sampling on the state highway system. This process is intended to result in valid planning information at the state and even the district level. This capability will be realized in future years.

#### (1) The HPMS, using its computerized modeling ability, can furnish the following types of information:

- (a) **Forecast of Highway System Needs.** An analysis of projected highway needs. The output is a summary of highway needs over time in the form of mileage, improvement type, and cost. Needs are defined by comparing existing conditions to minimum tolerable condition tables.
- (b) **Simulate Highway System Conditions.** The HPMS data base contains information on existing highway system conditions (the base year). The models simulate change in condition over time in the areas of pavement deterioration and volume/capacity. Improvements are simulated based upon deficiencies and the program then updates pavement condition and volume/capacity parameters. Future system conditions are then calculated, based on physical condition, safety ratings, and level of service.
- (c) **Analyze Investment Strategies.** The HPMS will estimate highway needs and predict future system condition for any given funding level. The relative

impact of different funding levels will show up in the form of changing highway condition ratings over the analysis period.

- (d) **Estimate User Costs.** User costs can be estimated for base year and future year conditions. The difference between base year and target year user costs is an indicator of efficiency trends for the highway system.
- (e) **Deficiency Analysis.** The miles of each type of deficiency can be generated for both base and target years. Deficiencies are listed for pavement condition, geometric elements (rural only), roadway cross section, and others. These deficiencies are identified by comparing existing and projected conditions to minimum tolerable condition tables. Trends can be identified by comparing base and target year deficiencies.
- (f) **Deferred Costs.** Sometimes a project that is deferred due to funding limits will be more expensive when done later. This process calculates costs that were initially selected but not simulated, and costs for a later improvement which was simulated. The difference is an indicator of the cost involved in deferring projects. Inflation is not considered.

The above types of analysis can be done for each urbanized area, the total of all urban areas, and total rural area. Results are also stratified by functional class.

#### (2) The data base for HPMS consists of three types:

- (a) **Universe Data.** A complete inventory of roadway mileage, broken down by functional classification and jurisdiction.
- (b) **Area-wide Data.** Consists of statistical data for mileage, travel, accidents, land area and population, broken out for each urbanized area, total small urban areas, and rural areas.
- (c) **Sample Section Data.** A comprehensive inventory of specific sections of highway. The sample data includes horizontal and vertical alignment, roadway geometry, annual average daily traffic, pavement condition, right of way width, access control, capital improvement costs, and others.

Sample sections are established by a random selection process based on statistical methods. The higher functional classifications require a greater degree of precision, and therefore a higher sample rate. Samples are taken only from those highways with higher functional classification than local access.

Sample sections are the basic data used by HPMS in its modeling programs. The sample sections are first analyzed, then the results are expanded to represent conditions of the total system from which the sample was drawn.

### **130.02 TRAVEL DATA AND TRAFFIC ANALYSIS**

The Travel Data Branch of PR&PT provides many types of travel data and traffic analyses for use in developing plans, programs, and projects. These data and analyses are used by WSDOT and other agencies in preparing environmental, operational, and design reports. Travel surveys are used to collect operational data not available from existing files. Traffic analyses can provide design data on present and future average daily traffic (ADT); present and future design hourly volumes (DHV); directional splits of traffic; percentages of trucks; and for air quality, noise, and other environmental studies. In addition, capacity analyses can be conducted for roadways, interchanges, ramps, structures, or intersections on existing or proposed facilities.

### **130.03 VIDEOLOGGING**

Video cassettes of the state highway system are available for viewing in each district and in the headquarters Highways Division. Three districts are videologged each year, which results in a completed cycle every two years. Only the latest video cassette version is maintained in the districts. A complete history is maintained in the Roadway Data Branch at the Planning Annex in Olympia. History tapes are available for viewing at the Annex, or if requested, may be sent to the districts for viewing.

Special projects may also be videologged by request. If the project is extensive, there may be some time required for scheduling. In addition to the video van, a portable video taping system with a self-contained power pack is also available for use in areas which may otherwise be inaccessible. Video taping is a service provided by the Roadway Data Branch. Roadway Data personnel will operate the video equipment. The equipment will not be loaned separately. Special projects may require a charge number.

### **130.04 PHOTOGRAMMETRY SERVICES**

The type and scale of mapping required for the initial planning are dictated by the terrain and land use intensity of the route corridor area. The maps must be complete, current and give full details of topography and physical features.

Mosaic reproductions or photographic prints may be used to show routes or portions of routes. The route plan should be made to the same scale as the mosaic copies. If oblique photographs are used, they should show the route in contrasting lines and be legibly annotated. The date of photography should appear on the maps.

The Program and Geographical Services Branch of PR&PT will make available to district and division offices, upon request, planimetric and topographic maps, halftone photography and strip maps, regular photography at any scale desired, and all types of photogrammetric mapping and related by-products, using the Computer Aided Drafting and Design (CADD) system.

# Program Development and Federal Aid Financing

- 140.01 General
- 140.02 Federal Aid Financing

## 140.01 GENERAL

RCW 47.05 Priority Programming for Highway Development, defines the requirements for highway construction prioritization, programming, and funding. The *Programming and Operations Manual, Highway Construction Program* (M 12-51) defines the processes that are used in the development of priorities and of construction program approval.

The following processes form the basis for the initiation of a project.

### (1) Program Approval

The Transportation Commission is responsible for approval of the six-year financial plan and for approval of the program of projects. The program is utilized as support for the request for highway construction appropriations from the legislature. The performance on each project is subject to review by each of these bodies.

The state legislature appropriates funds to implement the biennial program as presented. The appropriation identifies specific levels of state and federal funds. These levels are both maximums and objectives for construction expenditure.

The Program Development Office publishes the priority array, provides allocation of funds to the district and compiles the statewide construction program. That office also monitors district and department performance in program delivery. The computer systems supporting program development and management are enhanced by the Capital Program Management System (CPMS).

The district is responsible for proposing projects which meet the priority array and for constructing those projects according to the scope, schedule, and cost outlined in the approved program.

The headquarters Project Development Office is responsible for assuring that each project is designed in accordance with the department's design criteria and that federal criteria is utilized where needed.

### (2) Project Definition

Each project proposed by the district has a formal definition which establishes an agreement between the district and headquarters as to the work to be done, the estimated cost, work force, and project schedule. The definition documents include the project prospectus, full estimate schedule, and work force needs as defined in CPMS. CPMS provides a single data base for more responsive

and efficient operations. Accurate definition of each project is essential and delivery of these elements for each project is necessary to implement the program.

### (3) Program Review, Approval, and Monitoring

The approved program is an accumulation of the approved projects as submitted by each district. It is department policy to deliver the program as approved, with flexibility to adapt to changing conditions. The goal of initial program reviews, subsequent reviews, and project monitoring is to ensure that the approved program is delivered as committed. The Program Development Office coordinates reviews, monitors the program, and initiates reports on the performance of the program.

CPMS will facilitate these operations.

## 140.02 FEDERAL AID FINANCING

### (1) Federal-State Relationship

The present federal-state relationship in constructing federal aid highways was influenced to a great extent by legislation enacted by Congress in 1916 and 1921. This legislation established the federal aid highway program and since that time additional legislation has expanded the federal impact on transportation.

The U.S. Department of Transportation (USDOT) through the Federal Highway Administration (FHWA) provides guidance and funding to WSDOT for developing transportation facilities. WSDOT selects and initiates the projects, but FHWA is responsible for review and approval at key stages when federal aid highway funds are to be used in the financing.

FHWA has delegated to WSDOT, through Certification Acceptance (CA), the authority to approve design, PS&E and advertisement for federal aid projects except for those projects on the Interstate System, forest highway projects and public lands projects. For Category A projects headquarters has further delegated to the district the authority to approve design and PS&E.

CA does not replace or impact the other basic provisions of Title 23 U.S.C. regarding apportionments, programs, or authorization of funds.

### (2) Annual Federal Aid Program

Since the development of highway projects must be related to available funds, FHWA requires that a grouping or program of projects be prepared. The program of projects identifies those projects and their estimated cost for which federal assistance will be requested during the coming calendar year and also which phase (preliminary



engineering, right of way, or construction) will be requested for authorization.

### **(3) Rates of Federal Participation**

The basic rate of participation of the several federal programs is determined by statute. However, each state actually receives a slightly higher federal share adjusted by the ratio of the area of public lands and nontaxable Indian lands to the total area of the state.

### **(4) Project Authorization**

Following approval of the Statewide Annual Federal Aid Program, FHWA must review and approve each project phase prior to the work being started. This authorization obligates the federal funds and establishes the date of eligibility for funding preliminary engineering, right of way, and construction projects.

### **(5) Project Agreements**

The federal aid highway program is basically a reimbursement program. It is WSDOT's responsibility to fund

each project initially. Progress vouchers are submitted, requesting reimbursement for the federal share of actual expenditures. In order to be reimbursed, the costs must have been incurred in accordance with applicable federal and state laws and regulations.

The project agreement is the contractual document between FHWA and WSDOT which stipulates that WSDOT will be reimbursed. Once the project agreement is executed, changes in the project that alter the design concept or the termini must have prior approval from the Program Development Office and the headquarters Project Development Office and the consent of FHWA.

### **(6) Project Funding Procedures**

Detailed requirements and procedures for fund authorization of individual projects are available in the *Programming and Operations Manual, Highway Construction Program*, M 12-51. Guidance on processing local agency projects can be obtained from *Local Agency Guidelines*, M 36-63.

# 160

## General

- 160.01 Design Principles
- 160.02 Design Standards
- 160.03 Design Items

### 160.01 DESIGN PRINCIPLES

The major design controls within a functional class are traffic volume, character or composition of traffic, design speed, and control of access. These determine the principal geometric features of the highway. Other design controls such as topography and physical features, capacity, safety, and economics, which are of paramount importance, are reflected in the major controls indicated above.

The overall objective is to provide for the movement of the greatest number of vehicles possible at the highest speed possible consistent with state laws, economic reality, and maximum safety. The standards used in the design of any highway should allow future improvements with minimum investment loss. When funding is limited, reduce improvement length or economize on secondary design features, but do not economize on the principal geometrics or safety features. Roadway sections and surfacing can be improved and widened at reasonable cost at any future date when funding permits, but the geometric features of alignment, tied down by right of way, are expensive and often impossible to correct.

Design criteria for the application of controls are given in Division 4. The basic and secondary geometric elements of highway design are covered in Divisions 5 through 9. Miscellaneous features are covered in Divisions 10 through 14.

### 160.02 DESIGN STANDARDS

Standard plans have been and will continue to be developed for guidance in specific design situations, based on design specifications, laws, regulations, safety, strength, availability of materials, uniformity, cost, and aesthetics. Many AASHTO and FHWA design guides and recommendations have been adopted into these plans to ensure uniformity with other state systems.

The standard plans to be used for highway design in conjunction with this manual are contained in the *Standard Plans for Road, Bridge, and Municipal Construction*, M 21-01. The standard plans are the current design standards. Any deviation from these standards for an individual job must be approved by the State Project Development Engineer. If a standard plan is found to need revision, bring this fact to the attention of the State Project Development Engineer and request a change, rather than preparing special designs on individual projects. Submit recommendations for revisions to existing standard plans

and include a copy of the existing plan or specification showing all proposed changes. Submit proposals for new standard plans with a complete plan and specification.

Refer to the publications listed in Chapter 110 for additional guides to highway design.

### 160.03 DESIGN ITEMS

#### (1) References

- (a) RCW 43.19.190, State purchasing and material control director - powers and duties.
- (b) RCW 47.01.071, Commission - functions, powers and duties.
- (c) RCW 47.28.030, Contracts - State Forces - monetary limits - small contractors - rules and regulations.

#### (2) Patented or Proprietary Items

WSDOT uses competitively acquired materials that fulfill the functional requirements of an item of work except where the use of a proprietary material or item can be shown to be in the public interest. A specification for a single source (patented, trademark, or copyright) item is a proprietary specification. This does not restrict the use of replacement parts of identical nature for maintenance or refurbishing purposes.

Along with, or prior to, the submittal of the PS&E (see *Plans Preparation Manual*) or prior to processing a purchase order, the district must request approval from the State Project Development Engineer for the use of proprietary items. All pertinent facts pertaining to the reasons for using proprietary items shall be included in the request.

#### (3) WSDOT Furnished Items

The use of WSDOT furnished items in a contract is as follows:

- (a) WSDOT may furnish to contractors new or used material that will expedite relief in an emergency situation. An emergency situation must be declared by the District Administrator and the circumstances of the emergency situation warranting the furnishing of specific items to a contractor must be documented.
- (b) WSDOT may require a contractor to remove, refurbish, stockpile, or reinstall any existing item on any specific project.
- (c) WSDOT may furnish salvaged items from other projects for installation. The circumstances of furnishing salvaged items must be documented by the District Administrator.

(d) WSDOT may furnish new or used materials to expedite contract completion or use up surplus stores items. The circumstances of furnishing new or used materials must be documented by the District Administrator.

The district's PS&E submittal to the headquarters Project Development Office shall include specific information as to what, if any, items are to be removed, refurbished,

stockpiled, or reinstalled by the contractor. Any items to be furnished by WSDOT (new, used, or salvaged from other projects) must be clearly identified in the PS&E submittal and receive the State Project Development Engineer's approval except that the District Administrator may approve WSDOT furnished items for emergency situations.

210.01	General
210.02	References
210.03	Definitions
210.04	Public Involvement
210.05	Hearings
210.06	Environmental Hearing
210.07	Corridor Hearing
210.08	Design Hearing
210.09	Access Hearing
210.10	Combined Hearings
210.11	Administrative Appeal Hearing
210.12	Documentation

### 210.01 General

It is the goal of the Washington State Department of Transportation (WSDOT) that decisions be made in the best overall public interest and that other agencies and the public be involved early enough to ensure that the decisions that are made are responsive to the public's interests.

Public involvement is used to place issues before the public; to gather, and assimilate comments; and to inform the public of the final decisions, construction schedules, and project results. As part of the public involvement activities, hearings are held when major decisions are being made. Other, less formal methods are also used because they are the best way to elicit comments and communicate proposals.

Current laws and regulations provide general guidelines that allow considerable flexibility. The environmental policies and procedures (SEPA and NEPA) are intended to ensure that environmental information is available to public officials, agencies, and citizens and that public input is considered before decisions are made.

The role of local elected officials in the project development process is emphasized, and consistency with community planning goals and objectives is required.

### 210.02 References

USC Title 23 — Highways, Sec. 128 Public Hearings

USC Title 23 — Highways, Sec. 771.111 Early coordination, public involvement, and project development

RCW 47.50, Highway Access Management

RCW 47.52, Limited Access Facilities

*Design Manual* Chapter 220 for environmental references

*Improving the Effectiveness of Public Meetings and Hearings*, FHWA Guidebook

*Public Involvement Techniques for Transportation Decision-Making*, FHWA September 1996

### 210.03 Definitions

**hearing** An assembly to which the public is invited — to attend and to be heard.

**formal hearing** A hearing that is conducted by a moderator using a formal agenda, overseen by a hearing examiner, and recorded by a court reporter, as required by law.

**informal hearing** A hearing that is recorded by a court reporter, as required by law. An open format hearing is an informal hearing. The hearing examiner and formal agenda are optional.

**access hearing** A formal hearing that gives local public officials, owners of abutting property, and other interested citizens an opportunity to be heard concerning any plan that proposes the limitation of access to the highway system.

**administrative appeal hearing** A formal process whereby a property owner may appeal the department's implementation of access management legislation. The appeal is heard by an Administrative Law Judge who renders a decision. See 210.11 for the administrative appeal hearing procedures. They differ from those for the other, more public, hearings.

**combined hearing** A hearing that is held when there are public benefits to be gained by any combination of the environmental, corridor, design, and access hearings.

**corridor hearing** A formal or informal hearing that presents the corridor alternatives to the public for review and comment before a commitment is made to any one route or location.

**design hearing** A formal or informal hearing that presents the design alternatives to the public for review and comment before a commitment is made to any one alternative.

**environmental hearing** A formal or informal hearing that ensures that social, economic, and environmental impacts have been considered.

**court reporter** A person with a license to write and issue official accounts of judicial or legislative proceedings.

**findings and order** A document containing the findings and conclusions of a limited access hearing that is approved by the Assistant Secretary for the Environmental and Engineering Service Center.

**Hearing Coordinator** The Access and Hearings Specialist within the Olympia Service Center (OSC), Design Office, Access and Hearings Unit, who is assigned the responsibility for coordination of all functions relating to hearings.

**hearing examiner** An Administrative Law Judge (ALJ) from the Office of Administrative Hearings, or a WSDOT designee, appointed to moderate a hearing.

**NHS projects** Projects on the National Highway System for which FHWA has delegated approval authority for design, contract administration, and construction to WSDOT. (See Chapter 330.)

**opportunity for a hearing** An advertised offer to hold a hearing if so requested.

**resumé** An official notification of action taken by WSDOT following adoption of a findings and order.

## 210.04 Public Involvement

Developing an effective public involvement program is a strategic effort that involves selecting techniques that will meet the unique needs of a given transportation plan, program, or project. An effective public involvement program:

- Informs the public of the need or proposed action.
- Informs the public about the process that will be used to make decisions.
- Ensures that the public has ready access to relevant and understandable information.
- Identifies and resolves issues early in the process.
- Gains public support.
- Assists the project development process.

Public involvement begins during the system planning phase when the public is given opportunities to help solve short and long term transportation problems.

The public involvement effort continues into the project definition phase when a project is proposed to fulfill an identified need. When the study area for a project is identified, the region frequently notifies the public that the department is initiating a project and invites them to participate in a project definition or environmental evaluation meeting.

The region develops a public involvement plan that identifies all the methods proposed for the project. Methods are selected to ensure that public opinion is considered throughout the planning, environmental, location, and design phases of the project. Follow-up activities sometimes continue through construction, and even after completion, to provide ongoing public outreach or notifications.

For simple projects, the region develops a public involvement plan for their own use and guidance. To inform the public, communicate the decision-making process, identify the issues, and possibly resolve concerns, the region communicates with

the affected community through newspaper articles, fliers, community group presentations, open house meetings, or other methods. Public involvement on minor projects is not intended to be an open forum on the proposed design; however, public comments received during project development are evaluated and, if appropriate, included in the project.

It may become necessary to revise the public involvement plan as the project evolves, the community changes, or new issues arise.

### **(1) Public Involvement Plan**

The regions develop the public involvement plans for WSDOT projects. For projects requiring an environmental impact statement (EIS), a public involvement plan and OSC approval are required as part of the preparation of the Study Plan. (See Chapter 220.) For all other projects, the region may consult the Access and Hearings Unit for assistance or concurrence.

The public involvement plan includes:

- List of proposed activities.
- Time schedule to do each task keyed to the environmental process schedule, if applicable.
- Methods to be used in considering comments in the decision-making process, including follow-up procedures.
- Personnel, time, and funds needed to carry out the plan.
- Identification of the project stakeholders as the *public* to be involved.

The *public* to be involved (affected directly or indirectly) might include any or all of the following:

- Staff and elected officials of local governments
- Other state and federal agencies and officials
- Indian tribes
- Adjacent property owners and tenants
- Adjacent billboard owners and clients

- Community groups; clubs, civic groups, churches
- Special interest groups
- Environmental Justice stakeholders (low income and minority groups)
- Service providers; emergency, utility
- Others expressing interest
- Others known to be affected
- The general public

The department recognizes the role of local, state, and federal staff and elected officials as active sponsors of proposed projects who might effectively assist in developing and implementing the public involvement plan. Early and continued contact with these resources is a key to the success of the project.

### **(2) Public Involvement Methods**

Effective public involvement is flexible, innovative, multifaceted, and ongoing. There are many methods available to gain public participation. Any of the following methods might be appropriate to a project.

- Formal hearings (210.04(2)(a))
- Informal hearings (open format hearings) (210.04(2)(b))
- Public meetings and open house meetings (210.04(2)(c))
- Prehearing presentations
- Drop-in information centers or booths
- Advisory committee meetings
- Design workshops
- Meetings with public officials
- Individual (one-on-one) meetings
- Meetings with special interest groups
- Presentations at local group meetings
- Surveys and questionnaires/paper or electronic mail
- Hot lines
- Follow-up procedures (210.04(2)(d))

There are many communication tools available for use when announcing and holding public involvement events. See the following for lists of ideas.

- Notification techniques (210.04(2)(e))
- Handouts 210.04(2)(f)
- Graphics and Audio-Visual Aids 210.04(2)(g)

Agency representatives are conveying the department's image. They should be conscious of their roles, be well informed and confident, and communicate skillfully. When the event is well planned and the conductor is sensitive to the needs of the audience and objective about the needs of the project, meetings and hearings are usually productive efforts. See the FHWA publication *Public Involvement Techniques for Transportation Decision-Making*.

(a) **Formal Hearings.** The following are required of all formal hearings.

- Prehearing packet(210.05(5)(a))
- A hearing notice with a fixed time and date (210.05(2))
- Fixed agenda
- Hearing moderator (may be the hearing examiner)
- Hearing examiner
- Comment period
- Summary (210.05(6))

In addition to the oral comment period, people can write opinions on comment forms at the time of, or after, the hearing and submit them before the announced deadline.

See 210.06, 7, 8, and 9 for specifics related to the various types of hearings.

(b) **Informal Hearings (Open Format Hearings).**

An informal hearing must have the characteristics of a formal hearing listed in (a) above except for the fixed agenda. These events are usually scheduled for substantial portions of an afternoon or evening so people can drop in at their

convenience and fully participate. People are directed to attend a presentation, visit the exhibits, and then submit their comments.

The following items are features of an open format hearing, which is the most common format for an informal hearing.

- In areas where people work in shifts, open format hearings can be scheduled to overlap the shift changes.
- Brief presentations about the project and hearing process, at preset times, are advertised in the hearing notice. They can be live, videotape, or computerized.
- Agency or technical staff are present to answer questions and provide details of the project.
- Information is presented buffet style and participants shop for information.
- Graphics, maps, photos, models, videos, and related documents are frequently used.
- People get information informally from exhibits, presentations, and staff.
- People have a chance to clarify their comments by reviewing materials and asking questions before commenting.
- People can comment formally before a court reporter, or they can write opinions on comment forms and submit them before the announced deadline.
- People are encouraged to give opinions, comments, and preferences to the examiner in the presence of a court reporter.

(c) **Public Meetings and Open House Meetings.** Meetings are less formal than hearings. Public meetings range from large informational and workshop meetings to small groups and one-on-one meetings with individuals. The region evaluates what is desired from a meeting, and how the input will be tracked, and then plans accordingly.

- Open house meetings are very effective for introducing a project to the public and stimulating the exchange of ideas.

- Small meetings are useful for gaining information from special interest groups, neighborhood groups, and advisory committees.
- Workshop formats, where large groups are organized into small discussion groups, serve to maximize participation of all attendees while discouraging domination by a few individuals.

(d) **Follow-Up Procedures.** Effective public involvement is an on-going two-way exchange and it may be necessary to provide follow-up information several times during a large project to maintain a continuing exchange of information with the community.

At significant stages, the region responds to input with general information about the project. Follow-up information conveys, as accurately as possible, how public input was used to develop the project. Follow-up for larger projects might include newsletters, reports, individual contacts, or other activities related to the public's contribution to the project.

Follow-up measures can continue through construction and after project completion. The construction schedule is useful information and project accomplishments (such as noise abatement) are of interest.

Follow-up for smaller projects or for specific comments might simply be timely responses to individual requests.

(e) **Notification Techniques.** For hearings, see 210.05 for requirements regarding advertising for hearing interest and hearing advertisements. For other public involvement methods, develop notification techniques to attract a cross-section of the public. Provide special notices to those directly affected. Design the notifications to catch the public's attention and encourage people to attend or become involved. Consider the following techniques:

- Handouts
- News Releases — TV or newspapers
- Display ads in newspapers

- Web sites
- Electronic mail
- Faxboards
- Fact sheets
- Billboards
- Project notebooks at public places
- Project display boards at public places
- Fliers
- Newsletters
- Posters
- Local bulletin board announcements
- Personal contacts
- Radio announcements — AM, FM, CB
- On-site tours.
- Project office located close to the project

(f) **Handouts.** A well designed and informative handout can serve as an ongoing link between the department and the public.

Handouts have no set format. Make them as clear, relevant, up-to-date, easily understood, and self-explanatory as possible. Use handouts in foreign languages when appropriate. The following are handout possibilities:

- Special project newspapers
- Pamphlets
- Brochures
- Booklets (large, complicated projects)
- Charts
- Tables
- Graphs
- Project maps (aerial photographs or line drawings)
- Project development schedules
- Reports
- Right-of-way brochures (or other general information)



- Questionnaires
- Surveys

(g) **Graphics and Audio-Visual Aids.** The department normally uses slide shows or graphic exhibits to present project information. These presentations are informal and responsive to questions and concerns. Consider the following presentation techniques:

- Slide, slide-tape presentation
- Videotape
- Models
- Maps — large, simple
- Artistic renderings
- Photomontage
- Aerial photographs
- Computer visualizations

## 210.05 Hearings

Environmental documents address the social, economic, and environmental effects as described in Chapter 220. The project environmental documentation is the first step in the hearing procedures sequence. Each step of the hearing procedures is dovetailed into the environmental process and is important in achieving the appropriate project documentation. Corridor and design hearings are not normally required for Environmental Assessment, SEPA Checklist, and categorically excluded projects, but the opportunity for an environmental hearing might be required. When environmental hearings are not required, an informational meeting may serve as a useful forum for public involvement in the environmental process.

For all projects, the region reviews the requirements for a hearing or notice of opportunity for a hearing during the early stages of project development and before completion of the draft environmental documents.

If a hearing or notice of opportunity for a hearing is required, see Figure 210-1 for a summary of the event and timing requirements.

### (1) **Hearing Requirements**

A hearing or notice of opportunity for a hearing is required by federal and state law (USC Title 23 §771.111 and RCW 47.52) and by WSDOT policy if one or more of the following occurs. (When in doubt, consult the Hearing Coordinator.)

#### (a) **Corridor Hearing**

- The proposed route is on a new location.
- There will be substantial social, economic, or environmental impacts.
- There will be a significant change in the layout or function of connecting roads or streets.

#### (b) **Design Hearing**

- Acquisition of a significant amount of right of way will result in relocation of individuals, groups, or institutions.
- There will be substantial social, economic, or environmental impacts.
- There will be a significant change in the layout or function of connecting roads or streets or of the facility being improved.

#### (c) **Access Hearing**

- Access control is established or revised

#### (d) **Environmental Hearing**

- An EIS is required for the project or a hearing is requested for an EA.
- There will be substantial social, economic, or environmental impacts.
- There will be a significant adverse impact upon abutting real property.
- There is significant public interest or controversy regarding the project.
- Other agencies (Coast Guard or Corps of Engineers, for example) have hearing requirements that could be consolidated into one hearing process.

### (c) **Follow-up Hearings**

A new hearing or the opportunity for a hearing is required for any previously held hearing when any one of the following occurs. (See USC 23, §771.111.)

- Corridor or design approvals have not been requested within three years after the date the last hearing was held or the opportunity for a hearing was afforded.
- An unusually long time elapsed since the last hearing or opportunity for a hearing.
- A substantial change occurs in the area affected by the proposal (due to unanticipated development, for example).
- A substantial change occurs in a proposal for which an opportunity for a hearing was previously advertised or a hearing was held.
- A significant social, economic, or environmental effect is identified that was not considered at earlier hearings.

### (2) **Hearing Notice**

The OSC Access and Hearings Unit provides sample hearing notices to the regions upon request. These include items that are required by state and federal statutes. Some important elements of a notice are:

- To promote public understanding, the inclusion of a map or drawing is encouraged.
- For a notice of an opportunity for a hearing, include the procedures for requesting a hearing and the deadline, and note the existence of the relocation assistance program for persons or businesses displaced by the project.
- For a corridor, design, or combined corridor-design hearing or a notice of an opportunity for a hearing, announce the availability of the environmental document and where it may be obtained and/or reviewed.
- If there is involvement in wetlands, flood plains, prime and unique farmlands, Section 4(f) lands, or endangered species, include this information in the notice.

- Include information on any associated prehearing presentation (210.05(5)(d)).

Hearing notices and notices of opportunity for a hearing are advertised as described in 210.05(3) and Chapter 220. Hearing notices are also circulated as described in 210.05(5)(b)

### (3) **Advertise a Hearing or the Opportunity for a Hearing**

To advertise a legal notice of a hearing or a notice of an opportunity to request a hearing, use the following procedure:

- The region transmits the proposed notice, and a list of the newspapers in which the notice will appear, to the OSC Hearing Coordinator for concurrence prior to advertisement.
- Upon receiving concurrence, the region advertises the notice.
- Advertisement must be published in a newspaper having general circulation in the vicinity of the proposed project or the impacted population and in any newspaper having a substantial circulation in the area concerned, such as foreign language newspapers and local newspapers.
- The advertisement may be in the legal notices section or, preferably, as a paid advertisement in a prominent location.
- Additional means (such as display ads, direct mail, fliers, posters, or telephoning) may also be used to better reach interested or affected groups or individuals.
- A copy of the published hearing notice is sent to the Hearing Coordinator at the time of the publication.
- For access and environmental hearings, the notice must be published at least 15 days prior to the hearing. The timing of additional publications is optional.
- For corridor and design hearings, the first-notice publication must occur at least 30 days before the date of the hearing. The second publication must be 5 to 12 days before the date of the hearing.

- In no case shall a first notice for a corridor or design hearing be advertised prior to public availability of the draft environmental document.
- For a notice of opportunity for a hearing, the notice must be published once each week for two weeks. The deadline for requesting a hearing must be at least 21 days after the first date of publication and at least 14 days after the second date of publication.

#### **(4) No Hearing Interest**

When the region is not aware of specific hearing interest, the region can satisfy project hearing requirements by advertising a notice of opportunity for a hearing.

If no requests are received for a corridor or design hearing, the region transmits a package (which contains the notice of opportunity for a hearing, the Affidavit of Publication of the hearing notice, and a letter stating that there were no requests for a hearing) to the OSC Access and Hearings Unit.

When a notice of opportunity for a hearing is used to fulfill the requirements for a limited access hearing and there are no requests for a hearing, the region must secure waivers from every abutting property owner and affected local agency.

- The region obtains sample waiver forms from the OSC Access and Hearings Unit.
- The Project Engineer must contact every affected property owner of record (not tenant) and local agency to explain the plan and project to them. This explanation must include access features, right of way take (if any), and the right to a hearing.
- The region transmits the original signed waivers to OSC Access and Hearings Unit for processing.
- The Access and Hearings Unit prepares a package for review and approval by the State Design Engineer. This package consists of the signed waivers and Affidavit of Publication of the access hearing notice of

opportunity for a hearing along with a recommendation for approval of the right of way plan.

#### **(5) Hearing Preparation**

The Deputy State Design Engineer sets the hearing date. Final arrangements for the hearing date can be handled by telephone between the Hearing Coordinator and the region.

The region proposes a hearing date based on the following considerations:

- Convenient for community participation. Contact local community and government representatives to avoid conflict with local activities.
- When Commission members can attend if they so desire. Check with the Hearing Coordinator to avoid conflict with other commission business if possible.
- For corridor and design hearings, at least 30 days after circulation of the DEIS or the published notice of availability of any other environmental document.
- In most cases, more than 45 days after submittal of the prehearing packet.

The region makes other arrangements as follows:

- The location of the hearing hall is to be accessible from public transportation if possible, convenient for community participation, and accessible to the disabled.
- Arranges for a court reporter.
- Arranges for a the Hearing Coordinator to provide a hearing examiner for all access hearings and for other hearings if desired.
- Develops a hearing agenda for all access hearings and for other hearings if desired.
- If requested in response to the hearing notice, interpreters for the deaf, audio equipment for the hearing impaired, language interpreters, and Braille or taped information for people with visual impairments are required.

(a) **Prehearing Packet.** When it is determined that a hearing must be held, the region prepares a prehearing packet.

Include the following in the prehearing packet:

- Vicinity map
- Capsule project description
- Brief project history
- Public support or opposition to the project
- Plans for corridor and design alternatives with descriptions
- Hearing plans (access hearing only)
- News release
- Hearing notice tailored to the needs of the project. (For access hearing, indicate number of notices, plans, and Notices of Appearance needed for mailing.) See 210.05(2).
- List of legislators
- List of government agencies
- List of property owners (access hearing only)
- List of newspapers
- Hearing agenda if applicable
- Hearing arrangements, date, time, place
- Hearing format: formal or open format

Three copies of the prehearing packet are furnished to the OSC Access and Hearings Unit at least 45 days before the proposed hearing date. Concurrence with the prehearing packet takes about two weeks after receipt of the information. This assumes that all necessary information has been submitted to the Access and Hearings Unit.

(b) **Circulate Hearing Notice.** The Hearing Coordinator sends a copy of the notice of hearing to the Commission, the Attorney General's Office, the Public Affairs Office, and the FHWA (if applicable).

The region circulates copies of the hearing notice as follows:

- Send a copy of the hearing notice and a capsule description to the appropriate legislators and local officials about one week before the first publication of a hearing notice.
- Include in the cover letter to the news media a statement such as: "This material may have been released by a local legislator. If not, we will appreciate any coverage you care to give the project at any time prior to the hearing."
- Distribute the news release to all reasonable news media, as well as the newspapers that will carry the formal advertisement of the hearing notice, about 3 days before the first publication of a hearing notice.
- Advertise the hearing notice in the appropriate papers as described in 210.05(3) within a week of the mailing to the legislators.

(c) **Presentation of Material for Inspection and Copying.** The information outlined in the hearing notice, other engineering studies, and information that will be presented at the hearing is made available for inspection and copying throughout the period between the first advertisement and approval of the hearing summary or findings and order. The information need not be in final form, but must include every item that is included in the hearing presentation. The environmental document must also be available for public review.

The information presented for inspection and copying is made available in the general locality of the project. The region reviews the variables (locations of the regional office, the project office, the project site, and the interested individuals, and the probability of requests for review) and selects a mutually convenient site for the presentation of the information. The region keeps a record of who came in, when, and what data they reviewed and copied.

(d) **Hearing Briefing.** On controversial projects, the Hearing Coordinator arranges for a briefing (held before the hearing) for those interested in the project. Attendants include appropriate OSC, regional, and FHWA personnel, with special notice to the Secretary of Transportation. Regional personnel present the briefing.

(e) **Prehearing Presentations.** The region is encouraged to hold an informal presentation to the public for display and discussion of the project and plans. Holding this presentation on projects where local feeling runs high promotes rapport, brings out community reaction to the project, and identifies trouble spots prior to the hearing.

A prehearing presentation is informal, with ample opportunity for exchange of information between the department and the public. Prehearing presentations can be open house meetings, drop-in centers, workshops, or other formats that promote public participation.

The prehearing presentation is usually held approximately one week before the hearing for the more controversial projects. Other dates may be used depending on the desires of the region and the nature of the project.

Include notice of the date, time, and place in the hearing notice and ensure that the hearing notices are mailed in time to give adequate notice of the prehearing presentation.

(f) **The Hearing.** The hearing is moderated by the Regional Administrator or his designee. Normally, a hearing examiner is used when significant controversy or significant public involvement is anticipated. A hearing examiner is required for access hearings.

A word-for-word transcript of the proceedings is made by a court reporter.

Hearings are generally more informative and gain more public participation when an informal format is used so the public's views and opinions are openly sought in a casual and personal way. The open format hearing may be used for all hearings except access hearings. At least one court reporter is required to take testimony on a one-on-one basis. Use display tables and enough knowledgeable staff to answer specific questions about the project.

It is the responsibility of the hearing moderator and other department representatives to be responsive to all reasonable and appropriate questions, if possible. If a question or proposal

is presented at the access hearing, which necessitates an answer at a later date, the region reserves an exhibit to respond to the comment. The hearing moderator must not allow any person to be harassed or subjected to unreasonable cross-examination.

(g) **Hearing Agenda Items.** For all access hearings and for other hearings, as desired, the region prepares a hearing agenda to ensure that all significant items are included. A hearing agenda includes:

1. Opening Statement:
  - Highway and project name
  - Purpose of hearing
  - Introduction of elected officials
  - Federal/State/County/City relationship
  - Statutory requirements being fulfilled by the hearing
  - Status of the project with regard to NEPA/SEPA documents
  - Description of information available for inspection and copying
  - For an environmental, corridor, design, or corridor-design hearing, statement that written statements and other exhibits can be submitted during the open record period following the hearing.
  - Statement that all who want to receive written notification of the department's action as a result of the hearing may add their names to the interest list or file a Notice of Appearance for access hearings.
  - Description of how the hearing will be conducted
2. Project History. Present a brief project history, including need for the project, public involvement program, hearing opportunities afforded, and hearings held.

3. Presentation of Plans. Develop alternatives studied to comparable levels of detail and present them equally. Include the no-action alternative. Refer to any supporting studies that are publicly available.

Advise if one corridor or design is preferred by the department for more detailed development. When a preferred alternative exists, stress that it is subject to revision and re-evaluation both during and after the hearing, based on public comments, additional studies, and other information that may become available.

4. Social, Economic, and Environmental Discussion. Discuss all social, economic, and environmental effects or summarize the major impacts and refer to the environmental document.

5. Statements, Plans, or Counter-Proposals from the Public. Accept public views or statements regarding the plans presented, the alternatives to those plans, and the social, economic, and environmental effects of any plan.

6. Relocation Assistance Program. Explain the relocation assistance program and relocation assistance payments available. The Relocation Assistance brochure must be available for free distribution at all hearings. Right of way and relocation personnel should be available.

If the project does not require any relocations, the relocation assistance discussion may be omitted. Make a simple statement to the effect that relocation assistance is provided when needed but that no relocation is required by the project under discussion. The brochure and personnel should still be available to the public at the hearing.

7. Acquisition. Discuss right of way acquisition, estimated cost, and construction schedules. Discuss current schedules of critical activities that may involve or affect the public.

8. Closing. Summarize the hearing and what will follow.

9. Adjournment. Adjourn a hearing with sincere gratitude for the public's valuable participation.

## **(6) Hearing Summary Contents**

The hearing summary includes the following elements:

1. Transcript.
2. Copy of the Affidavit of Publication of the hearing notice.
3. Hearing material:
  - Copies of the letters received before and after the hearing
  - Copies or photographs of, or references to, every exhibit used in the hearing.
4. Summary and analysis of all oral and written comments. Include consideration of the social, economic, and environmental effect of these comments.

## **210.06 Environmental Hearing**

Projects requiring an EIS must use an evaluation process (called *scoping* in the NEPA and SEPA requirements) to identify the significant issues and alternatives to be studied in the DEIS and must follow the public involvement plan included in the Study Plan for the project. After the project has been thoroughly discussed within the community through the environmental evaluation process and informal public involvement methods, a hearing is held to present and gather testimony. The hearing is timed to fall within the comment period of the draft EIS for the project.

Responses to comments on the DEIS must be addressed in the FEIS. See Chapter 220 for the approval process.

The environmental hearing summary includes the items outlined in 210.05(6) above.

## **210.07 Corridor Hearing**

When a Corridor hearing is held, the region must provide enough design detail on the proposed alignment(s) within the corridor(s) so that an informed presentation can be made at the hearing. Justification must also be presented to abandon an existing corridor.

After the hearing, the region reviews the hearing transcript, responds to all questions or proposals submitted at or subsequent to the hearing, compiles a hearing summary, and transmits three copies (four copies for Interstate projects) to the Access and Hearings Unit. When appropriate, the hearing summary may be included in the final EIS.

The corridor hearing summary includes the items outlined in 210.05(6) above.

The Access and Hearings Unit prepares a package that contains the corridor summary and a formal document that identifies and describes the project, and forwards it to the Assistant Secretary for Environmental and Engineering Service Center for adoption.

Federal approval of a corridor on existing alignment is not required unless a substantial social, economic, or environmental impact is involved or unless the project substantially changes the layout or function of connecting roads or streets.

Submit the complete corridor hearing summary to the Access and Hearings Unit within approximately two months following the hearing if it is not part of an EIS.

## **210.08 Design Hearing**

When a design hearing is held for an improvement on existing alignment, and no other corridors are being considered, sufficient data must be presented to clearly document the decision to retain the existing corridor.

### **(1) Design Hearing Summary**

The design hearing summary includes the items outlined in 210.05(6) above.

Submit the complete hearing summary to the Access and Hearings Unit within approximately two months following the hearing.

If new studies or additional data are required subsequent to the hearing, the region compiles the data in coordination with the OSC Design Office.

(a) **NHS Projects.** After the hearing, the region reviews the hearing transcript, responds to all questions or proposals submitted at or subsequent

to the hearing, compiles a hearing summary, and transmits three copies (four copies for Interstate projects) to the Access and Hearings Unit. When appropriate, the design hearing summary may be included in the final environmental document. The Access and Hearings Unit prepares a formal document that identifies and describes the project and submits it to the State Design Engineer for approval. One approved copy is returned to the region. The Hearing Coordinator notifies the region that adoption has occurred.

(b) **Interstate Projects.** Following the design hearing summary approval, the Deputy State Design Engineer submits the approved design hearing summary to FHWA for approval. If possible, this submittal is timed to coincide with the submittal of the Design Decision Summary to the FHWA.

### **(2) Public Notification of Action Taken**

The region prepares a formal response to the individuals who had questions not answered at the hearing. The region keeps the public advised as to the eventual result of the hearing process (project adoption, revision to the plan, or project cancellation, for example). A region newsletter sent to those on the interest list is an effective method of notification.

## **210.09 Access Hearing**

Access hearings are required by law (RCW 47.52) whenever limited access is established or revised on new or existing highways. Decisions concerning access hearings are made on a project by project basis by the State Design Engineer based on information that includes the recommendations submitted by the region. (See Chapters 1410, 1420, 1430, and 1435.) Access hearing procedures generally follow the procedures identified in 210.05.

Prior to the access hearing as per RCW 47.52.131, conferences with the local jurisdictions shall be held on the merits of the access report and the plans.

The following supplemental information applies only to access hearings and procedures for approval of the Findings and Order.

### **(1) Hearing Examiner**

The OSC Access and Hearings Unit hires an Administrative Law Judge from the Office of Administrative Hearings to conduct the access hearing.

### **(2) Order of Hearing**

The Order of Hearing officially establishes the hearing date. The Hearing Coordinator calendars the Order of Hearing on the same calendar as the access hearing plan. The Hearing Coordinator then notifies the region, the Attorney General's Office, and the hearing examiner of the official hearing date.

### **(3) Access Hearing Information to Abutters**

The region prepares an information packet for mailing that must be mailed at least 15 days before the hearing (concurrent with advertisement of the hearing notice). If some of the access hearing packets are returned as undeliverable, the region must make every effort to locate the addressees.

The access hearing packet consists of:

- The Access Hearing Plan
- The Access Hearing Notice
- The Notice of Appearance

The region sends the access hearing packet to the following:

- The county and/or city
- The owners of property listed on the county tax rolls as abutting the section of highway, road, or street being considered at the hearing as a limited access facility.
- Local public officials and agencies who have requested a notice of hearing or who, by the nature of their function, interest, or responsibility, are interested in or affected by the proposal
- Every agency, organization, official, or individual on the interest list

And, if applicable, to the following:

- State resource, recreation, and planning agencies
- Tribal governments
- Appropriate representatives of the Department of Interior and the Department of Housing and Urban Development
- Other federal agencies
- Public advisory groups

The region prepares an Affidavit of Service by Mailing. This affidavit states that the access hearing packet was mailed at least 15 days prior to the hearing and that it will be entered into the record at the hearing.

### **(4) Access Hearing Plan**

The region prepares an Access Hearing Plan to be used as an exhibit at the formal hearing and forwards it to the OSC Plans Engineer for review and approval about 45 days before the hearing. This can be a Phase 2 or Phase 2A plan. (See Chapter 1410.) The OSC Plans Engineer puts the Access Hearing Plan on the Deputy State Design Engineer's calendar for approval.

### **(5) Access Hearing Plan Revisions**

The Access Hearing Plan cannot be revised after the Deputy State Design Engineer approves the plan without rescheduling the hearing. If significant revisions to the plan become necessary during the period between approval and the hearing, they can be made and must be entered into the record as a revised (red and green) plan at the hearing.

### **(6) Access Hearing Notice**

The hearing notice must be published at least 15 calendar days before the hearing. This is a legal requirement and the hearing must be rescheduled if the advertising deadline is not met. Publication and notice requirements are the same as those required in 210.05 except that the statutory abutter mailing must be mailed after notification of the appropriate legislators.



### **(7) Notice of Appearance**

The Hearing Coordinator transmits the Notice of Appearance to the region. Anyone wanting to receive a copy of the Findings and Order and the adopted Limited Access Plan must complete a Notice of Appearance form and return it to the department either at the hearing or by mail.

### **(8) Reproduction of Plans**

The Hearing Coordinator submits the hearing plans for reproduction at least 24 days prior to the hearing. The reproduced plans are sent to the region, at least 17 days before the hearing, for mailing to the abutters at least 15 days before the hearing. (See 210.09(3) above.)

### **(9) Access Hearing Exhibits**

The region retains the access hearing exhibits until preparation of the draft Findings and Order is complete. Then the region submits all the original hearing exhibits, and three copies, to the Access and Hearings Unit as part of the Findings and Order package (210.09(11)). Any exhibits submitted directly to OSC are sent to the region for inclusion with the region's submittal.

### **(10) Access Hearing Transcript**

The court reporter furnishes the original access hearing transcript to the region. The region forwards the transcript to the hearing examiner, or presiding authority, for signature certifying that the transcript is complete. The signed original is returned to the region for inclusion in the Findings and Order package.

### **(11) Findings and Order**

The Findings and Order is based entirely on the evidence in the hearing record. The region reviews a copy of the transcript and prepares a Findings and Order package. The package is sent to the Access and Hearings Unit.

A Findings and Order package contains:

- The draft Findings and Order
- Draft responses to comments (reserved exhibits)

- A draft Findings and Order Plan (as modified from the hearing plan)
- All access hearing exhibits (originals and 3 copies)
- The access hearing transcript (original and 3 copies)
- The Notice of Appearance forms
- A number indicating how many copies of the final Findings and Order Plan and text that the region will need for the mailing.

### **(12) Adoption of Findings and Order**

The Assistant Secretary for Environmental and Engineering Service Center adopts the Findings and Order, or refers it to the Commission for adoption, based on the evidence introduced at the hearing and on any supplemental exhibits.

Following adoption of the Findings and Order, the OSC Plans Section makes the necessary revisions to the Access Hearing Plan, which then becomes the Findings and Order Plan.

The Access and Hearings Unit arranges for reproduction of the Findings and Order Plan and the Findings and Order text and transmits them to the region.

The region mails a copy of the Findings and Order Plan and the Findings and Order text to all parties filing a Notice of Appearance and to all local governmental officials. Subsequent to this mailing, the region prepares an Affidavit of Service by Mailing and transmits it to the Access and Hearings Unit.

At the time of mailing, but before publication of the resumé, the region notifies the appropriate legislators of the department's action.

### **(13) Resumé**

The Access and Hearings Unit provides the resumé to the region. The region must publish the resumé once each week for two weeks not to begin until at least 10 days after the mailing of the Findings and Order.

## **(14) Final Establishment of Access Control**

When the Findings and Order is adopted, the Findings and Order Plan becomes a Phase 4 plan. (See Chapter 1410.) The establishment of access control becomes final 30 days from the date the Findings and Order is mailed by the region as documented by the Affidavit of Service by Mailing.

An appeal from the county or city must be in the form of a written disapproval, and request for a hearing before a board of review, submitted to the Secretary of Transportation.

An appeal from abutting property owners must be filed in the Superior Court of the state of Washington, in the county where the limited access facility is to be located, and shall affect only those specific ownerships. The plan is final for all other ownerships.

### **210.10 Combined Hearings**

When deciding whether to combine hearings, consider:

- Whether there is controversy.
- Whether alternative corridors are proposed.
- The nature of the environmental concerns.
- The benefits to the public of a combined hearing.

A combined hearing often alleviates the need to schedule separate hearings close together to cover the same material. A combined EIS-corridor-design hearing is desirable only when the timing for circulation of the draft environmental document is simultaneous with the timing for corridor and design hearings and all alternative designs are available for every alternative corridor.

### **210.11 Administrative Appeal Hearing**

When implementing access management statutes, the region is required to use the public involvement process to communicate the principles and standards of access management to the abutting property owners, business owners, and emergency services providers that might access the affected properties.

The department, as applicable, applies the Highway Access Management statutes to control access to the state highway system in order to avoid congestion and functional deterioration of the system. (See Chapters 1420 and 1430.)

After the public involvement process, if a decision has been made to restrict or delete access to a specific property, the property owner may appeal the decision by requesting a hearing.

### **(1) Hearing Procedure**

An administrative appeal hearing does not follow the hearing procedures described earlier in this chapter. The procedure is as follows:

- The department notifies the property owner, in writing, that an access management action has been taken. The letter explains the appeal process.
- The property owner may write a letter to the department requesting an administrative appeal hearing.
- OSC hires an Administrative Law Judge and sets the hearing date, time, and place.
- The department notifies the property owner of the date, time, and place (in writing).
- Testimony is given.
- The ALJ renders a decision.

### **(2) Further appeals.**

- The property owner may appeal the ALJ's decision by writing the State Design Engineer.
- The State Design Engineer reviews the appeal and renders a decision (in writing, to the property owner).
- The property owner may appeal the State Design Engineer's decision to the Superior Court of the state of Washington.

### **210.12 Documentation**

All documents generated by hearings are retained in Archives by the Office of the Secretary of State.

*P65:DM*

<b>Min. From Hearing</b>	<b>Sequence for a Hearing</b>			
	Determine need for a hearing or an opportunity for a hearing 210.05(1)			
	Develop hearing notice 210.05(2) + exhibits, develop Access Hearing Plan 210.09(4)			
45 days	Send prehearing packet 210.05(5)(a), send Access Hearing Plan 210.09(4)			
	Calendar Order of Hearing & Access Hearing Plan for access hearings 210.09(2)			
30 days	Draft EIS becomes available and its comment period begins for corridor and design hearings			
	Send notice to legislators and local officials within a week of first ad 210.05(5)(b)			
	Send letter with news release to media about 3 days before ad 210.05(5)(b)			
	<b>For Access Hearings</b>		<b>For Corridor, Design, and Environmental Hearings</b>	
24 days	Reproduction of plans 210.09(8)		30 days 15 days	Advertise a hearing * 210.05(3) Environmental hearing
15 days	Mail information packet 210.09(3) and advertise a hearing * 210.09(6)		5-12 days	Presentation of material to copy, hearing briefing, prehearing presentations 210.05(5)(c) - (e)
	Confer with local jurisdictions 210.09			Second ad 210.05(3) for corridor and design hearings
	Hearing 210.05(5)(f)			Hearing 210.05(5)(f)
	Access Hearing Transcript 210.09(10)			Address comments
	Final Access Hearing Plan 210.09(11)			Summary 210.05(6) within two months of the hearing
	Findings and Order and Resumé 210.09(11) - (13)			

\*If the advertisement is for the opportunity for a hearing, the deadline for requests must be at least 21 days after the first ad. If there are no requests, see 210.05(4).

**Sequence for a Hearing**  
*Figure 210-1*

# 220

## Project Environmental Documentation

- 220.01 General
- 220.02 Definitions
- 220.03 Project Classification
- 220.04 Class I, EIS
- 220.05 Class II, CE
- 220.06 Class III, EA/Checklist
- 220.07 Project Reevaluation
- 220.08 Project Reviews

### 220.01 GENERAL

Federal and state regulations require WSDOT to document the environmental impacts of a transportation project. When appropriate, other public and governmental agencies are involved in the decision-making process.

The project must comply with the following state legislation:

- State Environmental Policy Act (SEPA) of 1971, as supplemented in 1983, RCW 43.21C.
- SEPA Rules, Chapter 197-11 WAC.
- WSDOT Environmental Policy Act Rules, Chapter 468-12 WAC.

When the project involves only state funds or state permits, its documentation is governed only by state legislation.

When the project involves federal funds or federal permits, its environmental documentation is also governed by the:

- National Environmental Policy Act (NEPA) of 1969, 42-USC-4332.
- "Council on Environmental Quality Regulations for Implementing NEPA," 40 CFR Parts 1500-1508, November 29, 1978.
- Federal Highway Administration - Urban Mass Transportation Administration, "Environmental Impact and Related Procedures," 23 CFR Part 771, 49 CFR Part 622.

Environmental documentation starts with project classification, which is normally the initial step of project development. WSDOT requires the use of an interdisciplinary approach to assess the social, economic, and environmental impacts of the project. Activities such as budgeting, prospectus development, and legislative or feasibility studies may already have been completed. At the discretion of the district, other activities such as preliminary engineering and surveys, soil survey, or location decisions could be done in conjunction with or prior to preparing the environmental document.

A flow chart (Figure 220-1) of the environmental process is included at the end of this section.

### 220.02 DEFINITIONS

**Categorical Exclusions (CE) - NEPA or Categorical Exemptions (CE) - SEPA** Actions that do not individually or cumulatively have a significant effect on the environment.

**Commitment File** A file established by the district that identifies department commitments incorporated into the design and construction of a project.

**Determination of Nonsignificance (DNS)** The written decision by the District Administrator that a proposal will not have a significant environmental impact and no EIS is required (WAC 197-11-340).

**Determination of Significance** The written decision by the District Administrator that a proposal could have significant adverse impact and therefore require an EIS (WAC 197-11-360).

**Discipline Report** A report documenting findings concerning impacts of the project relative to an individual area of expertise. The report evaluates the impacts of the proposal and, where appropriate, includes recommendations concerning the course of action considered most desirable to fulfill the requirements of environmental laws and regulations addressed by the discipline.

**Environmental Assessment (EA)** A document prepared for federally funded, permitted, or licensed projects that are not categorical exclusions (CE) but do not appear to be of sufficient magnitude to require an EIS. The EA provides sufficient analysis and documentation to determine if an EIS or a Finding of No Significant Impact (FONSI) should be prepared.

**Environmental Checklist** A state agency document used to determine if an action will significantly impact the environment. The checklist form contained in WAC 197-11-960 is used for all actions not categorically exempt or not clearly requiring an EIS.

**Environmental Classification Summary (ECS)** A form (DOT Form 220-010 and 220-010A) used to evaluate and classify projects for the biennial budget or for later addition to the budget. The completed form is submitted by the district to the State Project Development Engineer for approval and FHWA concurrence if federal funds are involved.

**Environmental Document** A collective term used for any document that identifies the social, economic, and environmental effects of a proposed action.

**Environmental Impact Statement (EIS)** A detailed written statement of project environmental effects required by state and/or federal law. This term refers to either a draft or final environmental impact statement, or both, depending on context.

**Draft Environmental Impact Statement (DEIS)** A document identifying a course of action, alternative actions, analysis of the environmental impacts of alternates considered, and proposed mitigation of impacts. The DEIS is circulated to other agencies and the public for review and comment.

**Final Environmental Impact Statement (FEIS)** A document containing an evaluation of the course of action that WSDOT intends to follow. It contains the same information required for the DEIS, with appropriate revisions reflecting comments received from circulation of the DEIS and from public meetings.

**Finding of No Significant Impact (FONSI)** A federal lead agency document presenting the reasons why a proposal will not significantly affect the environment and therefore will not require an EIS. The FONSI includes the EA and references any other related environmental documents.

**Lead Agency** A federal or state agency taking primary responsibility for preparing an environmental document.

**Public Involvement Plan** A plan developed by the district outlining the public involvement activities to be used on a project to present information, obtain comments, and ensure consideration of public opinion.

**Record of Decision (ROD)** A document prepared by the federal lead agency after an EIS has been completed, outlining the final decision on a proposal. It identifies the decision, alternatives considered, measures to minimize harm, and a monitoring or enforcement program.

**Section 4(f) Evaluation** A document presenting the consideration, consultations, mitigative measures, and alternatives studied for the use of properties identified in Section 4(f) of the U.S. Department of Transportation Act as amended (49 USC 1653H).

**Notice of Intent** A federal notice, printed in the Federal Register, advising that an EIS will be prepared and considered for a proposal.

**Study Plan** An outline of the study process for the development of a project requiring an environmental impact statement.

## **220.03 PROJECT CLASSIFICATION**

### **(1) Programmed and Unprogrammed Projects**

At the program development stage, each project is evaluated and classified according to its magnitude and potential for significant social, economic, and environmental impact. For all projects, the district prepares an

Environmental Classification Summary (ECS) and submits it to the headquarters Project Development Office for technical review and approval.

The headquarters Project Development Office submits the approved ECS to the Federal Highway Administration (FHWA) for concurrence for NEPA projects only. If FHWA requests additional information, the headquarters Project Development Office coordinates the request between the district and FHWA. When FHWA concurs with the ECS, the headquarters Project Development Office returns the ECS, along with any comments, to the district.

### **(2) Category A, B, C Projects - NEPA/SEPA Documentation**

(a) The following categories of projects are qualified for federal aid by complying with NEPA regulations. FHWA serves as lead agency.

- All Category A and B projects meeting 3R or full design standards.
- All Category A, B, & C projects eligible for Bridge Replacement (BR) or Discretionary Bridge Replacement (DBR) funds.
- All Category C projects classed as NEPA Categorical Exclusions. When these projects require a Coast Guard permit, the headquarters Project Development Office will obtain NEPA CE concurrence from the permitting agency.

(b) For all other Category C projects which do not qualify for federal aid but do require federal permits, the department completes the SEPA document and the federal permitting agency serves as lead agency for completion of the NEPA document. Document preparation is a coordinated effort between the lead agency and the department.

### **(3) Classification**

All WSDOT projects are classified as follows:

(a) **Class I, NEPA/SEPA - Environmental Impact Statement (EIS).** Actions likely to have significant impact on the environment by altering land use, planned growth development patterns, traffic volumes, travel patterns, transportation services, or natural resources, or by creating public controversy. An EIS can be prepared without developing an Environmental Assessment. Refer to 220.04.

(b) **Class II, NEPA-Categorical Exclusion/ SEPA - Categorical Exemption (CE).** Actions that do not have a significant impact on the environment or involve substantial planning time or resources. These actions are specifically identified in 23 CFR 771.115 for federally funded or permitted projects and WAC 197-11-800 and 197-11-860 for state and locally funded projects. Unless specifically requested by other agencies or the public, these actions do not

require an EIS or Environmental Assessment. A SEPA checklist may be required if right of way or state permits are required. Refer to 220.05.

- (c) **Class III, NEPA - Environmental Assessment (EA)/SEPA - Check list.** Actions in which the significance of the impact on the environment is not clearly established. An EA or SEPA checklist is prepared to determine the extent of environmental impact and is used to determine whether an EIS need be prepared. No EIS is required when the EA supports a Finding of No Significant Impact and SEPA Determination of Nonsignificance on a project involving federal funds or permits. Similarly, a SEPA check list supports a Determination of Nonsignificance for a state project and no EIS is required.

## **220.04 CLASS I, EIS**

### **(1) Project Initiation**

The district initiates the project by submitting a Work Order Authorization (DOT Form 120-020) to the Program Development Office for review and approval.

The Program Development Office approves the Work Order Authorization and notifies the district and the headquarters Project Development Office of approval. The headquarters Project Development Office contacts the district to coordinate the project environmental and public involvement requirements.

### **(2) Notice of Intent**

For a project involving federal funds or federal permits, after the Work Order Authorization is approved, the district prepares a Notice of Intent for publication in the Federal Register, advising federal agencies that an EIS will be prepared. The contents and guidelines for preparation of the notice are found in FHWA Notice T6640.8A. The notice is submitted to the headquarters Project Development Office which submits it to the federal lead agency for placement in the Federal Register.

### **(3) Interdisciplinary Team (IDT) and Project Manager (PM)**

The district appoints an IDT, consisting of three to five various disciplines, which functions as an advisory board to the District Administrator. The district may also appoint other support disciplines to do specific expertise studies. These may be appointed from the district and headquarters. The IDT and support disciplines provide objective, in-depth studies, analyses, reports, guidance, and recommendations concerning the proposed improvement as it relates to social, economic, and environmental issues. The District Administrator delegates the administrative responsibilities of the project to a PM and provides support staff to assist in the administration of the project. Which disciplines and personnel are selected for

the IDT depends on the nature and magnitude of each project.

WSDOT personnel are assigned when available and may be supplemented by consultants, personnel from other state or local agencies, and disciplines from within the community. Assistant Secretaries, the State Project Development Engineer, the IDT, community groups, and planning agencies may suggest the assignment of additional disciplines. IDT members and support disciplines have expertise in such areas as: acoustics, air quality, archaeology, architecture, biology, botany, communications, economics, geology, hydrology, landscape architecture, meteorology, sanitary engineering, sociology, structural engineering, transportation planning, urban planning, and water quality.

Duties and responsibilities of the IDT include:

- Review and approval of a Study Plan and a Public Involvement Plan.
- Evaluation of alternative courses of action.
- Preparation of reports (data and conclusions of technical studies, views of citizens, officials, and groups).
- Submission of recommendations to the PM.

The PM, in consultation with the various disciplines, prepares a proposal, identifies the affected parties, and outlines environmental concerns and alternatives to be included in the scoping process.

### **(4) Scoping**

Scoping is a process used to identify all significant issues and alternatives for the EIS and to have them presented as early as possible. Specific scoping objectives are:

- To identify the affected public and agency concerns.
- To facilitate an efficient EIS preparation process by identifying the cooperating agencies, ascertaining which related permits and reviews need to be scheduled concurrently, and setting completion time limits.
- To define the issues and alternatives to be examined in detail in the EIS.
- To save time by ensuring that draft statements adequately address relevant issues and that a statement will not have to be rewritten or supplemented.

The beginning of the scoping process usually consists of informal meetings or open houses. Either prior to or during these sessions, the district provides to the affected agencies, Indian tribes, and any other groups, organizations or agencies known to have interest in the project, information about the proposal including a brief description, proposed alternatives, probable environmental impacts and issues, maps, drawings, and a brief explanation of the scoping procedure.

The district also holds an orientation meeting for the IDT and support disciplines providing as much project information as available including maps, profiles, possible R/W requirements for alternatives, traffic for alternatives, draft study plan, and available construction costs. The disciplines will identify any additional information they require.

The scoping process continues through the development of the DEIS. It includes telephone conversations, and written comments involving various agencies, interest groups and individuals. The PM is responsible for development, documentation, and coordination of the scoping process.

### **(5) Study Plan and Public Involvement Plan**

The headquarters Project Development Office reviews and approves the Study Plan/Public Involvement Plan. The approved Study Plan/Public Involvement Plan is then submitted to the district for implementation.

**(a) Study Plan.** A Study Plan is completed immediately after the issues and alternatives have been identified in the initial stages of the scoping process. The Study Plan, which shows the project environmental studies to be conducted, is prepared by the PM and approved by the IDT, the district, and the headquarters Project Development Office. The Study Plan is an outline of the scope and level of effort intended for identification of interdisciplinary participants, public involvement, alternatives to be studied, and social, economic, and environmental issues.

The following is the general format for the data in the Study Plan:

1. Title sheet:
  - a. Project title.
  - b. Date.
  - c. Approval date and signatures of:
    - Team Chairman
    - District Administrator
    - Assistant Secretary for Highways
2. Vicinity map.
3. Need and purpose:
  - a. Need (known deficiencies).
  - b. History (if applicable).
  - c. Purpose of project.
4. Scope of work:
  - a. Interdisciplinary approach. (Briefly describe how the team uses interdisciplinary information to reach decisions.)
  - b. Alternatives.
  - c. Public involvement summary.

- d. Brief description of areas of primary importance.
5. Studies to be prepared and areas of responsibility:
    - a. List of studies to be prepared and disciplines assigned study responsibility.
    - b. Identify IDT members, project manager and IDT chairman.
    - c. Identify education and experience record of all expertise including only the information required for an EIS.
  6. Manpower and budget requirements.
  7. Schedule.
  8. Appendix: Public Involvement Plan.

**(b) Public Involvement Plan.** The Public Involvement Plan is an integral part of the Study Plan. Its objectives are to outline the procedures by which information will be presented to the public, obtain comments, and ensure consideration of public opinion. Details of the Public Involvement Plan are contained in Chapter 210.

### **(6) Selection of Alternatives**

The PM develops preliminary alternatives. The IDT studies all proposed alternatives and determines social, economic, and environmental effects. Generally, each alternative is developed to the same level of detail so comparisons of effects can be made. Alternatives should be openly discussed with all affected groups.

The alternatives to be studied are determined by the PM and the IDT. A listing of the features to be considered for each alternative along with a comparative matrix to assess differences is shown in the WSDOT *Environmental Procedures Manual* M 31-11.

Alternatives normally include the following:

- The no-action alternative, which could include short-term minor reconstruction activities (safety improvements, etc.) that are part of an ongoing plan for continuing operation of the existing roadway.
- Improve existing facility, which could include resurfacing, restoration, and rehabilitation (3-R) plus reconstruction (4-R) types of activities, high occupancy vehicle lanes (HOV), park and ride facilities, and other minor improvements.
- Multimodal alternatives, include public transit, rail, water, and air transportation, or other modes of transportation dictated by the characteristics of the study area. These may be under the jurisdiction of other lead agencies and require early coordination.
- New transportation routes and locations.
- Multiple alternatives identified above.

## **(7) Data Collection, Inventory, and Evaluation**

The IDT develops an inventory of social, economic, environmental, and engineering data. The information is used to define the environment, predict and analyze impacts of project implementation, help select the least environmentally damaging alternative, serve as a data base for environmental documents, and provide information to other agencies, interest groups, or individuals.

The sources of data include, but are not limited to, field studies, consultation and coordination with other agencies, and the public. The *Environmental Procedures Manual* M 31-11 and FHWA Technical Advisory T6640.8A, are guides to the type of information, depth of study, and procedures used in collection, inventory, and evaluation of required environmental data. The following is a list of expertise areas considered in the development of an environmental document.

- Geology and Soils.
- Topography and Sundry Sites.
- Waterways and Hydrological Systems.
- Water Quality.
- Flood Plains.
- Wetlands.
- Farmlands.
- Vegetation.
- Wildlife and Wildlife Habitat.
- Hazardous Waste.
- Transportation.
- Air Quality.
- Noise.
- Energy.
- Visual Quality.
- Regional and Community Growth-Population Characteristics.
- Land Use.
- Disruptions, Displacements and Relocation - Changes in Community Character.
- Employment.
- Property values.
- Taxes.
- Overall Economic Activity - Output of Goods, Services, and Agricultural Products.
- Services.
- Sites of Recreational, Cultural, Historic, and Archaeological Significance.

## **(8) Reports and Recommendations**

**(a) Discipline Reports.** After data has been collected, inventories compiled, and analyses completed, each discipline prepares a report. The report documents the technical studies and investigations performed,

contains a summary of findings, and lists recommendations. The individual reports are submitted to the Project Manager for review.

Since the report communicates equally with technical and nontechnical groups, a summary of the report is written to present the significant findings of the study and the recommendations in non-technical terms. The information is presented in a form suitable for incorporation into the environmental document and for presentation at public hearings or use by management and lay groups in decision making.

The technical portion provides evidence that all the major potential areas of impact have been considered, presents information to support the findings of significance and effect, and demonstrates clearly that the study is in compliance with the requirements of environmental law. The following is a general format for a complete discipline report:

- Summary of report findings, conclusions, and recommendations.
- Background discussion.
- Study methodology.
- Coordination with other groups or agencies.
- Affected environment (existing conditions).
- Prediction of impacts of each alternative.
- Mitigation recommended for construction and operational impacts.
- Bibliography.

**(b) Preliminary Recommendations.** The Project Manager and the IDT review all discipline reports and develop preliminary recommendations after discussing the various alternative trade-offs. The district submits the preliminary recommendations to the headquarters Project Development Office for review and approval. After approval they are returned to the district.

The preliminary recommendation would normally include:

- A description of alternatives to be considered in the DEIS.
- Identification of a preferred alternative if one exists.
- Identification of significant impacts and possible mitigation.
- A discussion of controversial areas and proposed coordination to resolve.
- Identification of any changes in the proposal as originally defined in the Study Plan.

**(c) Draft Environmental Impact Statement (DEIS) and Commitment File.** The DEIS is the initial WSDOT project report. It identifies the alternative actions and presents an analysis of their impacts on the environment. It may identify a recommended



course of action but need not if one is not clearly preferred. The DEIS summarizes the early coordination process, including scoping, and identifies the key issues and pertinent information received through these efforts.

For projects requiring federal funds or federal permits, all EIS documentation must comply with the requirements of NEPA and the Council on Environmental Quality (CEQ) guidelines.

Other EIS documentation uses SEPA guidelines as the controlling authority. EIS documentation that meets NEPA requirements satisfies SEPA, but SEPA documents do not necessarily satisfy NEPA.

All EISs are written following the *Environmental Procedures Manual M 31-11*.

On projects where federal agencies have funding or permitting responsibility, one federal agency is the lead agency. WSDOT and the federal lead agency are mutually responsible for the environmental document. Any other federal agency may be involved as a cooperating agency. Projects jointly developed with a federal agency are prepared to comply with that agency's regulations and guidelines.

The headquarters Project Development Office prepares a preliminary DEIS using reports and/or data supplied by the IDT, the district, and other sources. The district prepares a commitment file consisting of proposed mitigating measures, commitments made to resource agencies or other agencies with permitting authority, and any other commitment made on behalf of the project. The commitment list is sent to the headquarters Project Development Office. Upon completion of the preliminary DEIS, the headquarters Project Development Office submits the document to the district for review and comment. See 220.08 for other commitment file requirements.

The headquarters Project Development Office coordinates reviews by various headquarters expertise, the Attorney General's office (on controversial projects), and appropriate federal agencies. Review comments are returned to the district for revision of the preliminary DEIS as appropriate. After reviewing changes made in response to comments on the preliminary DEIS, the district submits the DEIS to the Assistant Secretary for Highways who approves the DEIS by signing the title page and obtains concurrence for circulation by signature of appropriate federal official on the title page. The signed title page and approval to print the DEIS are returned to the district and the document is printed. Required copies of the document are submitted to the headquarters Project Development Office.

If the project involves federal funds or permits, the headquarters Project Development Office submits the DEIS to the federal lead agency for transmittal to the EPA for their processing and placement of a notice in the Federal Register. A comment period of not less than 45 days begins upon publication of the notice in the Federal Register. For state funded projects, the DEIS is submitted to the DOE and a comment period of not less than 30 days is established from the date DOE receives the document.

Circulation of the DEIS is a shared responsibility between the district and the headquarters Project Development Office. The headquarters Project Development Office circulates to WSDOT headquarters offices, the Attorney General, DOE, the Transportation Commission, the State Library, and FHWA. The headquarters Project Development Office requests that the DOE send the DEIS to the Washington State Conservation Commission per Memorandum of Understanding GC 7141. The district makes all other circulation, which is normally to any agency, affected Indian tribe, organization, public official, or person who expresses interest or requests the DEIS, any federal agency having jurisdiction by law or special expertise with respect to an environmental impact, any governmental agency authorized to develop and enforce environmental standards, and any governmental agency authorized to issue permits. When visual impacts are a significant issue, the DEIS should be circulated to officially designated local arts councils and, as appropriate, other organizations interested in design, art, and architecture. Generally, all copies sent out during the circulation of the DEIS are furnished free of charge. After initial circulation a fee may be charged which is not more than the cost of printing.

**(d) Draft Section 4(f) Evaluation.** When a project involves USDOT funding or USDOT permits and requires the use of any publicly owned land from a park, recreation area, wildlife or waterfowl refuge, or a cultural resource site on or eligible for the National Register of Historic Places, a Section 4(f) evaluation must be included in a separate section of the environmental document. A separate evaluation is prepared for each location within the project where the use of Section 4(f) property is being considered. The Section 4(f) evaluation must include:

- Description and need for the proposed action.
- Description of the Section 4(f) properties.
- Impacts on the resource by each alternative.
- Alternatives that avoid Section 4(f) properties and their impacts.
- Measures to minimize harm.
- Coordination with appropriate agencies.

Also refer to 220.04(10) for additional requirements of a final Section 4(f) evaluation.

The DEIS/Section 4(f) evaluation report must be circulated to the Secretary of the U.S. Department of the Interior for a 45-day review and comment period. When appropriate, the Secretary of Housing and Urban Development and the Secretary of Agriculture (federal) are also given an opportunity to review the proposal. When a Section 4(f) property is identified after the DEIS and/or FEIS has been processed, a separate Section 4(f) evaluation is prepared, circulated for comment, and finalized.

- (e) **Section 106 Preliminary Case Report.** All projects which involve the acquisition of right of way or excavation within existing right of way have potential to be surveyed and inventoried for cultural resources to determine if resources exist and if sites qualify for inclusion in National Register of Historic Places.

When cultural resources are discovered the following steps are taken (headquarters normally takes the lead in these actions):

- Send Determination of Eligibility form and cultural resource report to the State Historic Preservation Officer (SHPO).
- When eligible, send Determination of Effect form to SHPO for concurrence.
- If resource property is affected, apply the Criteria of Adverse Effect and get SHPO's concurrence.
- When there is an adverse effect, prepare a Section 106 Preliminary Case Report as per 36 CFR 800. Report generally identifies any adverse effects and actions taken to mitigate effects.
- Report sent to Advisory Council on Historic Preservation, through SHPO, requesting comments.
- Prior to FEIS preparation, participate in the development of a Memorandum of Agreement with the Advisory Council, SHPO, and FHWA that includes measures to avoid, mitigate, or accept the adverse effects on a resource.

Section 106 property also meets the requirements for Section 4(f) evaluations when the site in question is on or eligible for the National Register of Historic Places and if it has been determined that the proposed project will have an adverse effect upon the site. When this is the case, the Section 106 Preliminary Case Report and Draft Section 4(f) evaluation will be one document to satisfy the requirements of both laws.

## (9) Hearings and Notices

When the department advertises notices for corridor, design, or combined corridor-design hearings, or offers a notice of opportunity for public hearing, the notice

announces the availability of the environmental document and where it may be obtained and/or reviewed. If there is involvement in wetlands, flood plains, Section 4(f) lands, or endangered species, this information is included in the notice. Where hearings are not required by statute, an informational meeting may serve as a useful forum for public involvement in the environmental process. See Chapter 210 for further hearings requirements.

### (a) References:

- Council on Environmental Quality (CEQ) Regulations - 1506.6
- USDOT Order 5610.1C
- 23 CFR Part 771
- WAC Orders 197-11-502, 535
- WAC Order 468-12-510

### (b) SEPA.

1. **Public Hearings.** Public hearings on SEPA projects are held whenever one or more of the following situations occur:
  - a. WSDOT determines that a hearing is needed to assist in implementing the requirements of SEPA.
  - b. Fifty or more persons reside within the project area or are adversely affected by the environmental impact of the proposal and make a written request for a hearing.
  - c. Two or more agencies with jurisdiction over the proposal request a hearing.
2. **Public Notice of Availability/DEIS.** WSDOT is required to use the public notice procedures detailed in WAC 468-12-510(c) to inform the public that the DEIS is available and the procedures for requesting a public hearing. If a hearing is required to fulfill any legal requirements, include information on the availability of the DEIS in the notice. The public notice requirements include: publication of notice in a newspaper of general circulation in the county, city, or general geographic area where the proposal is located; notifying agencies with jurisdiction, affected Indian tribes, and those groups that are known to be interested in the proposal or who have commented in writing about the proposal; contacting news media and placing notices in appropriate regional, neighborhood, or ethnic periodicals. Publish the notice at least 30 days in advance of the public hearing. The available environmental document continues to be open to consideration and comment.

The DEIS Notice of Availability contains the following basic elements:

- Location of project.
- Brief description.

- Purpose of statement.
- Responsible agency.
- Where documents are available.
- Where to send comments.

3. Public Notice of Availability/FEIS. WSDOT notifies the public in the similar manner as for the DEIS excluding the last item. FEIS notification procedures are detailed in WAC 468-12-510(d).

**(c) NEPA.**

1. Public hearings are required for NEPA projects when:
  - a. Substantial environmental controversy exists,
  - b. The department has a substantial interest in holding a hearing, or
  - c. An agency with jurisdiction over the proposal (permitting agency) requests a hearing.
2. The notices of availability are similar to the SEPA notices with the inclusion of the name of the federal lead agency. If there is involvement in flood plains, wetlands, Section 4(f) land, or endangered species, this information is included in the notice. These notices are printed in the Federal Register by the lead agency at least 30 days in advance of the public hearing.

**(10) Final Reports and Approvals**

**(a) Final Recommendation.** The district reviews comments from the hearings and those received from evaluation of the DEIS and prepares a hearing summary that is submitted to the headquarters Project Development Office for review. The district then analyzes and coordinates comments on the DEIS with the IDT and the headquarters Project Development Office, and prepares a final recommendation. The final recommendation contains:

1. Description of the preferred alternative.
2. Identification of proposed measures to minimize harm.
3. Monitoring or enforcement programs required to ensure implementation of mitigation measures. The district submits this recommendation, with appropriate comments, to the headquarters Project Development Office for review and coordination within headquarters. When the headquarters Project Development Office approves the recommendation it becomes the WSDOT recommendation.

**(b) Final Environmental Impact Statement and Commitment File.** The headquarters Project Development Office prepares the FEIS and coordinates preparation and processing procedures with the district. The document contains the WSDOT final

recommendation or preferred alternative, discusses substantive comments received on the DEIS, summarizes citizen involvement, and describes procedures required to ensure that mitigation measures are implemented. The FEIS also documents compliance with environmental laws and Executive Orders.

The district also resubmits the commitment file including new commitments made since the first submittal. Details on establishing and maintaining the commitment file are located in 220.08.

CEQ regulations state that when the DEIS adequately identifies and quantifies the environmental impacts of all reasonable alternatives, and it is apparent that changes in the proposal will be minor, or only minor comments are received from circulation of the DEIS, the FEIS can consist of the DEIS and attachments containing the following:

1. Errata sheets making corrections to the DEIS.
2. A section identifying the preferred alternative and a discussion of the reasons why it was selected and others were not. If applicable, this section also contains the final Section 4(f) evaluation, wetlands findings, flood plain findings, and a list of commitments for mitigation measures.
3. Summary of comments and responses from circulation of the DEIS and public hearings.

The headquarters Project Development Office reviews the preliminary FEIS and obtains reviews by the Attorney General's office (on controversial projects) and the appropriate federal agency. Review comments are provided to the district for use in revising the FEIS. The district prepares a draft Record of Decision (ROD) and submits it to the headquarters Project Development Office along with the FEIS. The headquarters Project Development Office reviews the FEIS, the Assistant Secretary for Highways signs the title page, and approval for printing is obtained from the federal lead agency.

The district prints the FEIS and submits it to the headquarters Project Development Office, which submits the FEIS and the draft ROD to the appropriate federal agency for signature. The State Project Development Office forwards the signed title page to the district for insertion into the FEIS. For state funded projects, the FEIS is submitted to the DOE and other state agencies only for informational purposes.

Circulation, distribution, and coordination of the FEIS is a shared responsibility between the district and the headquarters Project Development Office. The headquarters Project Development Office circulates it to headquarters offices, the Attorney General,

DOE, the State Library, and FHWA if it is a federal aid project. The district circulates the FEIS to any person, organization, or agency that submitted substantive comments, any agency authorized to issue permits, and public institutions for public review.

(c) **Final Section 4(f) evaluation.** When the selected alternative involves the use of Section 4(f) property, a Section 4(f) evaluation is included as a separate section in the FEIS. The final evaluation contains:

1. All information required for a draft evaluation found in 220.04(7).
2. A discussion supporting a conclusion that there are no feasible and prudent alternatives to the use of the Section 4(f) property. The discussion must demonstrate that there are unique problems or unusual factors involved in the use of other alternatives and that the cost, environmental impact, or community disruption resulting from such other alternatives reaches extraordinary magnitudes.
3. A discussion documenting that the proposed action includes all possible planning to minimize harm to the Section 4(f) property.
4. A summary of the formal coordination with the Department of Interior, and, as appropriate, the U.S. Departments of Agriculture, and Housing and Urban Development.
- 4a. A copy of the Memorandum of Agreement with the Council on Historic Preservation. (See 220.04(8)(e).)
5. Copies of all formal coordination comments received and response to questions.
6. Concluding statement "Based upon the above considerations, it is determined that there is no feasible and prudent alternative to the use of land from the Section 4(f) property and that the proposed action includes all possible planning to minimize harm to the Section 4(f) property resulting from such use."

(d) **Record of Decision (ROD).** This document is prepared by the district in draft form and accompanies the FEIS through the review and approval process. The ROD is only required on federally involved projects and includes the information required by Section 1505.2 of the CEQ Regulations.

The headquarters Project Development Office obtains the approved ROD from the federal agency and circulates it to the State Construction Engineer, the State Operations and Maintenance Engineer, and the district, and advises that the project may advance to the design stage.

The following format is used:

1. **Decision.** Identify the selected alternative. Reference to the FEIS may be used to avoid repetition.
2. **Alternatives Considered.** Briefly describe each alternative (with reference to the FEIS, as above), explain and discuss the balancing of values underlying the decision. Values for economic, environmental, safety, traffic service, community planning, and other decision factors may be different and be given different levels of relative importance. Identify each significant value and the reasons why some values were considered more important than others. The ROD should reflect the manner in which these values were considered in arriving at the decision. Identify the environmentally preferred alternative or alternatives. In addition, if Section 4(f) property is used, the Section 4(f) evaluation is summarized.
3. **Measures to minimize harm.** Describe all measures to minimize environmental harm that have been adopted for the proposed action. State whether all practicable measures to minimize environmental harm have been incorporated into the decision and, if not, why.
4. **Monitoring or enforcement program.** Describe any monitoring or enforcement program that has been adopted for the specific mitigation measures, as outlined in the FEIS.
5. **Commitment List.** Include an item-by-item list of commitments and mitigation measures from the commitment file. The list serves as a ready reference for the design, construction and maintenance of the project.

(e) **WSDOT/FHWA Corridor.** For corridor projects, the headquarters Project Development Office requests corridor approval from FHWA and the State Transportation Commission. FHWA corridor approval is required only for interstate projects.

## **220.05 CLASS II, CE**

### **(1) Project Initiation**

The district initiates the project by submitting a Work Order Authorization to the Program Development Engineer for review and approval. Upon approval of the Work Order Authorization, the project may proceed.

### **(2) Environmental Documentation**

(a) **NEPA.** Federally funded projects are classified as Categorical Exclusions (CE) if they are included in one of the actions identified in 23 CFR 771.117.

Actions requiring no further federal environmental documentation because of blanket approval received from FHWA are identified in 23 CFR 771.117(c).

The remaining actions are approved as CE's when FHWA has approved the Environmental Classification Summary (ECS). These then require no further federal environmental documentation. If any CE project affects Section 4(f) properties a separate Section 4(f) evaluation document is required as outlined in 220.04(7). Supporting documentation must also be prepared for CE projects that may affect wetlands, farmlands, flood plains, or cultural resource properties. Supporting documentation is submitted with the ECS form.

The district identifies projects that have received prior CE concurrence when submitting the project design to the headquarters Project Development Office for approval. The design transmittal includes the date of FHWA concurrence.

Projects which are NEPA CE's having both federal and state funds, must still satisfy SEPA requirements. These projects may need environmental approval both as a NEPA CE and a SEPA Determination of Nonsignificance.

- (b) **SEPA.** Projects funded by state funds only or by a combination of state and federal funds must satisfy one of the following SEPA requirements. In all cases the required SEPA action is identified on the ECS when it is approved by the State Project Development Engineer.

Projects are approved as Categorical Exemptions (CE) when the project meets the requirements of WAC 197-11-800 (SEPA Guidelines). The ECS identifying the project as a SEPA CE is the only environmental documentation necessary. SEPA actions requiring a checklist are identified in 220.06(6)(c).

## **220.06 CLASS III, EA/CHECKLIST**

### **(1) Project Initiation**

Environmental Assessment projects are initiated by the district submitting a Work Order Authorization to the Program Development Office for review and approval. The Program Development Office then notifies the district and the headquarters Project Development Office that the Work Order Authorization is approved. As required, the headquarters Project Development Office contacts the district to coordinate project environmental and public involvement requirements.

### **(2) Appointment of Disciplines and Project Manager**

After approval of the Work Order Authorization, the district appoints various disciplines to conduct all studies necessary for EA preparation and a Project Manager (PM) to be responsible for development of the project. These projects do not require the appointment and use of

a formal IDT but use various disciplines in an interdisciplinary approach for needed investigations.

### **(3) Coordination**

As appropriate, the district coordinates with affected federal, state, and local agencies, Indian tribes, and the public in determining the scope of the action, alternatives to be considered, and significant issues to be addressed. The PM is responsible for conducting the coordination. During the early coordination process, FHWA in cooperation with WSDOT requests other agencies with involvement to become cooperating agencies. By law, federal agencies with jurisdiction must be requested to become cooperating agencies. The district makes these requests in writing and sends a copy to the headquarters Project Development Office.

### **(4) Data Collection, Inventory, and Evaluation**

The various disciplines conduct studies to assess social, economic, and environmental impacts. The depth of study varies with the magnitude and setting of the proposal. Generally, discipline studies for an EA are developed using the same method outlined for EIS projects in this section. Studies are carried out to the point where a determination can be made as to the extent of environmental impact. If significant impacts are found, the district determines whether satisfactory mitigating measures can be incorporated into the project to reduce the impacts to insignificance or to begin the EIS process.

### **(5) Public Involvement**

The district conducts public meetings, does mailings, and uses other methods appropriate to the magnitude and scope of the project to provide and obtain information to assist in developing the project. Public involvement methods are discussed in Chapter 210.

### **(6) Reports and Recommendations**

- (a) **Discipline Reports.** Refer to 220.04(8).
- (b) **Environmental Documents - NEPA.** The district prepares a preliminary Environmental Assessment (EA) in accordance with the *Environmental Procedures Manual* M 31-11. Include an area map, vicinity map, site plan, photogrammetric maps (to depict the environmental setting), discipline reports, and any agency coordination letters such as endangered species listings, prime and unique farmland determinations, archaeological/historic reports, etc. If the project involves Section 4(f) lands, a separate evaluation is required as per 220.04(7) and 220.04(10) and is included as a separate section in the EA.

The preliminary EA and Section 4(f) evaluation are submitted to the headquarters Project Development Office which circulates the documents to appropriate WSDOT headquarters offices and the federal lead

agency for review and comment. If the reviewers determine that the proposal may have significant environmental impacts, the proposal is reevaluated to determine whether the significant impacts can be appropriately mitigated or eliminated. If the impacts cannot be eliminated an EIS is required. If no significant impacts are found, the headquarters Project Development Office returns the preliminary EA, with comments, to the district for revisions. The revised EA is resubmitted to the headquarters Project Development Office for approval.

The headquarters Project Development Office then requests federal concurrence to publish a notice announcing the public availability of the EA. The public review and comment period for an EA is 30 days. If a Section 4(f) evaluation is included, a 45 day public review and comment period is required. The headquarters Project Development Office also circulates the document to the federal lead agency, SHPO, and cooperating agencies. If Section 4(f) property is involved, the district circulates the document to the Department of the Interior and to the agency with jurisdiction over the Section 4(f) property.

At the conclusion of the public availability period, the district evaluates all comments received, including comments from public hearings, meetings, and open houses. The district responds to the comments and revises the document as necessary. If comments are minor, the district may issue an addendum referencing changes in the EA. The headquarters Project Development Office submits the final EA to the federal agency requesting a Finding of No Significant Impact (FONSI). After the federal agency issues the FONSI, the headquarters Project Development Office returns the signed FONSI to the district. The headquarters Project Development Office notifies the Department of Community Development (Clearing House) via letter that a FONSI is available from WSDOT or the federal lead agency.

**(c) Environmental Documents - SEPA.**

1. If the project does not involve another agency with jurisdiction; demolition of any structure or facility not exempted by WAC 197-11-800(2)(f) or 197-11-880; or issuance of clearing or grading permits not exempted in Part Nine of SEPA rules; but does require new easements; additional right of way; widening of more than a single lane; or any other action which is not SEPA exempt; the district will:
  - a. Prepare the checklist and the DNS.
  - b. Obtain the signature of the District Administrator or his designee.
  - c. Send a copy to the headquarters Project Development Office.

- d. Submit a copy to the DOE headquarters for listing in the SEPA register.
  - e. Process is complete.
2. If the project requires approvals from other agencies with jurisdiction; the district will:
    - a. Prepare the checklist and the DNS or mitigated DNS.
    - b. Obtain the signature of the District Administrator or his designee.
    - c. Submit a copy to the headquarters Project Development Office for review and concurrence of mitigation measures before circulation.
    - d. Circulate for a 15-day review and comment period (in accordance with WAC 197-11-340(2)(b) or WAC 468-12-510(a)) to:
      - DOE headquarters.
      - DOE regional office.
      - Newspapers of general circulation in the project vicinity (indicate option to publish).
      - Agencies with jurisdiction.
      - Affected Indian tribes.
    - e. Evaluate review comments then proceed to:
      - Confirm the validity of the DNS; or
      - Prepare a mitigated DNS and revised checklist and recirculate in accordance with WAC 197-11-350 (see 2a above); or
      - Withdraw the DNS in accordance with WAC 197-11-340, prepare a Determination of Significance and proceed with an EIS.

If environmental documentation is needed to support the DNS, such as preservation of farmlands determination, archaeological/historical surveys, wetland reports, flood plain evaluations, or other expertise reports, the district requests the preparation of expertise reports and coordinates the processing of the reports to the appropriate agencies. Informational copies are also sent to the headquarters Project Development Office.

When either NEPA or SEPA proposals involve project commitments, these commitments will be recorded and completed as required for more major projects. See 220.08.

3. The NEPA-EA document can also be used to satisfy SEPA requirements. When the EA is approved, the district adopts the EA in accordance with part six of WAC 197-11 and WAC 197-11-340(1). The Adoption Notice, WAC 197-11-965, is filled out by the district and

circulated to DOE, to agencies with jurisdiction, to local agencies in which the proposal will be initiated, and to persons or organizations who have responded to the proposal in writing. An information copy is also sent to the headquarters Project Development Office.

When EAs or SEPA checklists contain commitments, commitment files will be established as per 220.08(3).

## **(7) Hearing and Notices**

EA projects require a hearing when there is substantial controversy, when WSDOT wants a hearing, or when an agency with jurisdiction requests a hearing. For additional information refer to 220.04(9) and Chapter 210.

EAs normally have less potential for environmental impacts and public controversy and, consequently, less potential for public hearings. Prepare the EA in advance of any public hearing. The public hearing notice requirements follow the format and time schedule outlined in 220.04(9) and WAC 468-12-510. The notice of the public hearing published in local newspapers announces the availability of the EA and where it can be obtained or reviewed.

When a hearing is not required, the district publishes a notice in the local newspaper (similar to a public hearing notice) advising the public that the EA is available for review and comment and where the document may be obtained. Public availability and comment periods are identified in 220.06(6). The headquarters Project Development Office sends a notice of the availability to the Department of Community Development Clearing House.

After all environmental documents have been approved and finalized, they are returned to the district and the project may advance to the design stage.

## **220.07 PROJECT REEVALUATION**

The district shall reevaluate a document any time it feels that single or cumulative conditions have changed which might cause new or more severe environmental impacts. Reevaluation is required when any one of the following conditions exist:

- An acceptable FEIS has not been submitted to FHWA within 3 years from the date of the DEIS circulation.
- Major steps to advance the project (such as approval to acquire a substantial portion of the right of way, or approval of PS&E) have not occurred within 3 years from FEIS approval.
- Any change is made to the proposed action and it is uncertain if a supplemental EIS is required. The district reevaluates the project by conducting appropriate environmental studies or, if necessary, by preparing an EA to assess the impacts of the changes.

When any of the conditions above exist, the reevaluation is submitted in written form to the headquarters Project Development Office. The headquarters Project Development Office reviews the reevaluation and forwards it for review and approval to the same federal office that approved the original EIS.

If the reevaluation identifies significant changes in the proposed action, the affected environment, the anticipated impacts, or the proposed mitigation measures, a new or supplemental document is prepared and circulated. For additional guidance on project reevaluations refer to 23 CFR 771.

## **220.08 PROJECT REVIEWS**

### **(1) References**

- NEPA Sections 1505.2 and 1505.3.
- 23 CFR 771.127.

### **(2) Procedures**

- The district ensures that decisions made in environmental documents are accomplished in design and construction of projects, and maintained or improved during the life of the project.
- The district continues to maintain the project environmental commitment file which follows the project through design, right of way acquisition, PS&E, construction and maintenance. See No. (3) below.
- When requested by commenting agencies or the public, the district develops a progress report on the project mitigation implementation program and makes it available to those initiating the request.
- As requested, WSDOT makes available results of implemented mitigation measures established in the environmental document to the public upon request.
- During construction, the district implements the mitigation measures and monitors maintenance of environmental mitigation to ensure it is satisfactorily maintained or improved. The district must request concurrence from the headquarters Project Development Office for any significant alterations in mitigation measures agreed to during the environmental process, even when changes are made during construction or maintenance.
- When unique or unusual mitigation is required, the headquarters Project Development Office conducts periodic reviews during construction and/or operation to evaluate the effectiveness of mitigation measures that were incorporated into the contract.

### **(3) Commitment File**

As an initial part of project development, the district establishes a project commitment file. Establishment of this file generally coincides with preparation of the environmental document or could be at later stages as required. The file consists of proposed mitigating

measures, commitments made to resource or other agencies with permitting authority, and other commitments made on the project. The file normally consists of design and environmental commitments. Other commitments may be added at the district's discretion, such as right of way, access, maintenance, permits, and agreements.

The district continues to maintain the commitment file as a project progresses through its development process. Whenever commitments are made, they are incorporated into project documents and transferred from one phase of the project to the next. Commitments are normally included or identified in the following documents or actions:

- Environmental documents.
- Design reports.
- Right of way plans.
- Access plans.
- Findings and order.
- Contract plans.
- Pre-construction conference.
- Change orders.
- End of project report.
- Maintenance.

To organize and track commitments made during the development and implementation of a project, a "Record of Commitment," DOT Form 220-021, is used which provides two functions:

- (a) Establishes a permanent record of the commitment in paper form.
- (b) Establishes the means of locating and summarizing commitments of a specific type through the use of a computer file.

When a commitment is made, record it on the Record of Commitment form. The form contains the detail necessary to document the commitment, including references to correspondence, agreement numbers, etc.

For easy retrieval, the information on each completed form is entered into the district computerized commitment file (and the form is then filed) according to state route, milepost, and date.

A commitment may be revised when all parties involved agree to the revision.

A computer system maintains a (statewide) summary of commitments. As each commitment is made, this Commitment Summary File receives data from the districts. Commitments can be identified according to route and milepost, district, date made, type, or responsibility.

When commitments are completed, the computer files and the forms are updated with the date the commitment was finished and appropriate comments. Records (forms) on completed commitments should be retained for at least a year after the completion date. Commitments requiring ongoing maintenance need to be retained in the files as long as the commitment is active.

When project documents reach headquarters, the headquarters Project Development Office reviews design reports and PS&E for inclusion of appropriate commitments. The headquarters Project Development Office also coordinates an annual review of selected commitments to evaluate the effectiveness of the commitment implementation process. Normally, two projects are reviewed in each district by environmental, design, construction, and maintenance personnel from headquarters and the district. The results of the evaluation, with appropriate recommendations, are furnished to the district.



**ENVIRONMENTAL PROCESS FLOW CHART**

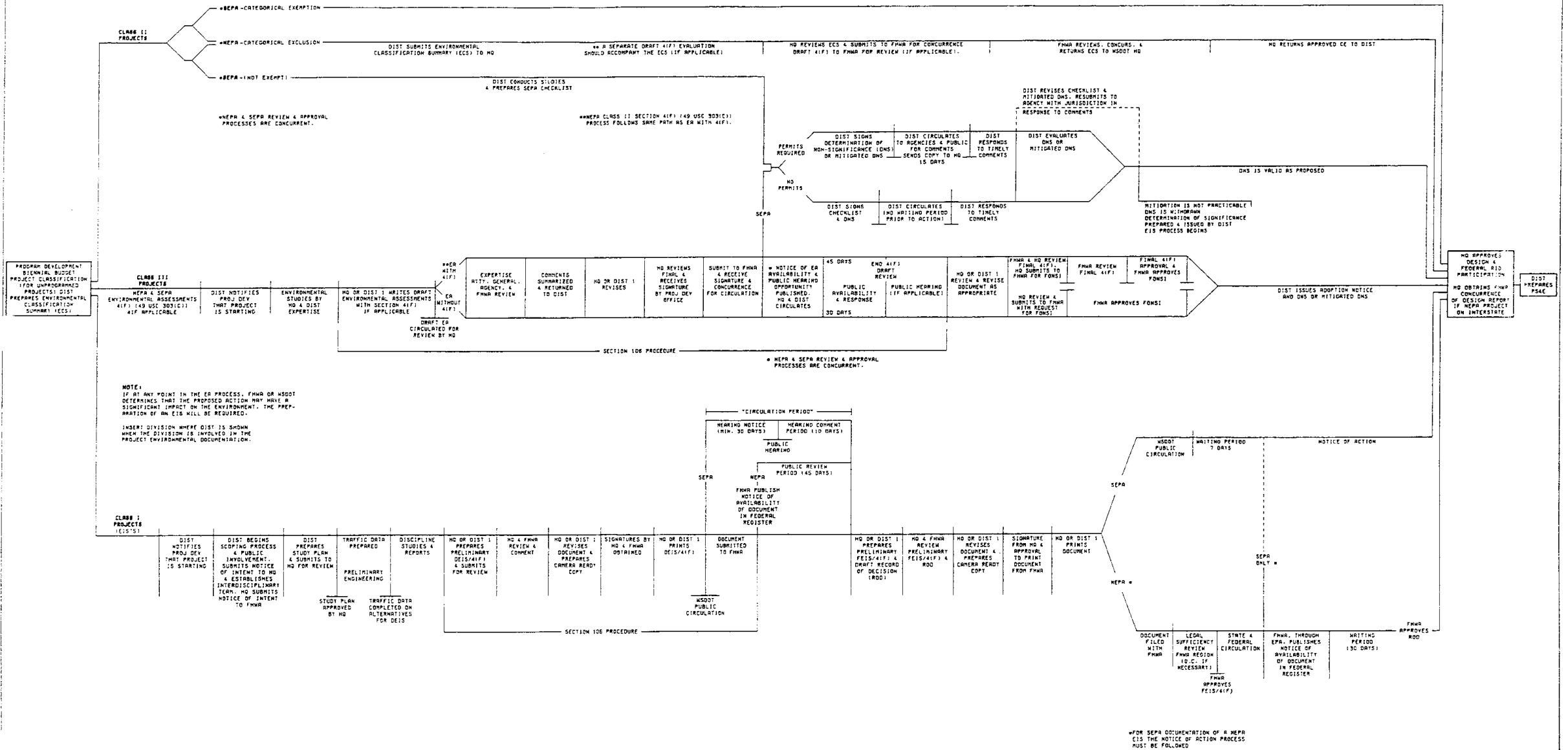

Figure 220-1

# 240

## Permits and Approvals From Other Governmental Agencies

- 240.01 General
- 240.02 United States Department of the Army-Corps of Engineers
- 240.03 United States Coast Guard
- 240.04 United States Forest Service (USFS)
- 240.05 Federal Aviation Administration (FAA)
- 240.06 FHWA - Western Federal Lands Highway Division (WFLHD)
- 240.07 Federal Energy Regulatory Commission
- 240.08 Environmental Protection Agency
- 240.09 Washington State Departments of Fisheries and Wildlife
- 240.10 Washington State Department of Ecology (DOE)
- 240.11 Washington State Department of Natural Resources (DNR)
- 240.12 Washington State Department of Labor and Industries
- 240.13 Local Agencies
- 240.14 Utility Agreements

### 240.01 GENERAL

A project may require one or more permits from federal, state, and local agencies. This section covers only permits and approvals of a regulatory nature, with a list of regulatory provisions shown in Figures 240-1a and 1b. Permits are normally obtained through an application process. Project approvals are obtained through coordination and negotiation with the approving agency.

Permits required for occupancy of public property are covered in Chapter 5 of the Utilities Manual, M 22-87.

### 240.02 UNITED STATES DEPARTMENT OF THE ARMY-CORPS OF ENGINEERS

#### (1) General

The Corps of Engineers has authority over all work in waters of the United States and their wetlands. The wetlands under the Corps' authority are defined in Directive D 22-27.

When the department prepares an environmental impact statement or assessment for a project which requires a Section 10 or Section 404 permit, conditions set forth in a Memorandum of Agreement between USDOT (FHWA) and the Corps, signed January 1983, are followed. This agreement is intended to "strengthen the early coordination between USDOT and the Corps prior to and during development of projects and environmental documentation."

#### (2) Permits

Highway construction that infringes on waters or wetlands of the United States is required to have a Section 10 permit and/or a Section 404 permit. Either permit may be in the form of a nationwide or regional general permit or an individual permit. There are no regional permits applicable to WSDOT at this time.

**(a) Section 10 Permit.** A permit required for any construction, excavation, depositing of material, or any other work in navigable water affecting the course, location, condition or capacity of such waters. The purpose of the permit is to prevent obstructions to navigation.

Navigable waters are those waters of the United States that are subject to tidal action shoreward to mean high water or are used, have been used, or are susceptible to use in interstate or foreign commerce.

Waters of the United States include all navigable waters, interstate waters, intrastate waters of which the use, degradation or destruction could affect interstate or foreign commerce, tributaries to the above, and wetlands adjacent to the above.

**(b) Section 404 Permit.** A permit required for discharge of dredged or fill material into waters of the United States. The purpose of the permit is to prevent water quality degradation. A 404 permit is not required to maintain structures or drainage ditches, but may be required to construct temporary sedimentation basins.

**(c) Nationwide Permits.** These permits apply to both Section 10 and Section 404 permits and are fully detailed in 33 CFR 330. Some apply to certain waters and others to specific activities. Provided the conditions in (d) are followed, the permits authorize the following activities:

- Fills in nontidal waters where the mean annual flow is less than 5 cubic feet per second or not tributary to interstate or navigable waters.
- The repair, rehabilitation, or replacement of a previously authorized structure or fill to its original plan and uses. Dredging is not authorized by this permit.
- Outfall structures where the effluent is covered by a National Pollutant Discharge Elimination System (NPDES) permit, provided adverse impacts of the structure are minimal.

- Structures placed within anchorage areas to facilitate moorage if established by the Coast Guard.
- Bank stabilization measures necessary for erosion prevention, that are less than 500 feet long and average less than 1 cubic yard per lineal foot within waters of the United States. Also provided that no material is placed in any wetland, flow is not impaired to or from any wetland, only clean material is used, and the activity is a single complete project.
- Minor road crossing fills of less than 200 cubic yards below ordinary high water provided the opening will pass high flows and that discharges into wetlands do not extend beyond 100 feet on either side of ordinary high water. Also provided that the activity is a single complete project crossing a nontidal water body.
- Fill placed incidental to construction of a bridge over navigable waters having a Coast Guard Section 9 permit. Approach fills are not included, nor are projects on nonnavigable waters, where the Corps of Engineers has jurisdiction.
- Fills that do not exceed 10<sup>3</sup> cubic yards as part of a single complete project provided no fill is placed in wetlands.
- Dredging no more than 10<sup>3</sup> cubic yards as part of a single complete project.
- Activities authorized or funded by a federal agency if the project is categorically excluded from NEPA documentation. The Corps has concurred with the FHWA/UMTA list of categorical exclusions in Chapter 220.

**(d) Conditions.** The following special conditions are applicable for the nationwide permits in (c) to be valid.

- Discharge will not occur near a public water supply intake.
- Discharge will not occur in areas of concentrated shellfish production.
- The activity will not jeopardize a threatened or endangered species, or adversely modify critical habitat of such species.
- The activity will not significantly disrupt movement of indigenous aquatic life.
- Discharge will be free of toxic amounts of toxins.
- Structures and fills will be properly maintained to prevent erosion and other pollution.
- The activity will not occur in a National Wild and Scenic River System.
- The activity will not cause an unacceptable interference with navigation.
- The best management practices in (e) should be followed as much as practicable.

**(e) Best Management Practices.** Practices to follow, to the maximum extent practicable, when discharging dredged or fill material are:

- Avoid waters of the United States by using other practical alternatives.
- Avoid spawning areas during spawning season.
- Avoid restricting or impeding movement of indigenous aquatic species or the passage of water.
- Minimize adverse impacts on the aquatic system caused by the accelerated or restricted flow of water due to its impoundment.
- Avoid wetlands.
- In wetlands, place heavy equipment on mats.
- Avoid breeding areas for migratory waterfowl.
- Entirely remove temporary fills.

### **(3) Procedures**

The WSDOT district coordinates proposed actions with the local Corps' district to determine which permit is required, if the project is covered by the nationwide permit or if the project must comply with other conditions established by the Division Engineer. The Corps' Division Engineers are authorized to modify nationwide permits by adding conditions or override nationwide permits by requiring individual permit applications on a case-by-case basis.

No application is required for projects authorized by the nationwide permit. For individual permits, the district makes application to the appropriate Corps of Engineers, District Engineer in Walla Walla, Seattle, or Portland. Appropriate Corps districts will hold a pre-application review with other agencies if the applicant desires. Applications for individual permits require specific details according to the instructions outlined in the pamphlet "U.S. Army Corps of Engineers Permit Program a Guide for Applicants," prepared by the Corps of Engineers. When submitting an application, also submit a signed Certification of Consistency with the Coastal Zone Management Plan, if applicable. The Corps will forward the certification, along with the Corps' public notice, to DOE for concurrence or objection.

The Corps is required to advertise by public notice for public interest whenever an acceptable application is received. The Department of Ecology (DOE), which functions as the state clearing house, circulates the public notice to and solicits comments from, all state agencies. When state agency concerns have been satisfied, the DOE responds to the Corps, indicating the state's position on issuing the permit. If the state has no objection, the DOE will issue a water quality certification and a statement of consistency with the Coastal Zone Management Plan if required. The Corp issues the permit when all objections are resolved.

## **240.03 UNITED STATES COAST GUARD**

### **(1) General**

The Coast Guard issues permits for bridges, causeways, and drawbridges in navigable waters of the United States. When WSDOT develops a bridge project requiring a Coast Guard permit, the environmental coordination and documentation is developed in accordance with the Memorandum of Understanding between the U.S. Coast Guard (USCG) and the FHWA, signed May 1981.

This memorandum is intended to improve coordination, avoid unnecessary duplication of effort, and enhance problem resolution between the USCG, FHWA and WSDOT in the preparation of NEPA environmental documents. The Coast Guard and the FHWA agree that, when a highway section requires an action by both FHWA and Coast Guard, the FHWA will normally serve as the lead agency for the preparation and processing of environmental documents. Details of document preparation and processing are in Chapter 220.

### **(2) Procedures**

The Bridge and Structures Office applies for all Coast Guard bridge permits and coordinates the permit review. The application must be documented by an analysis of the effect the project will have on the quality of the environment. The Coast Guard will issue a permit when other federal agencies have no objection and applicable state agencies notify DOE that there are no objections. When DOE notifies the Coast Guard of the state's position, it will include a "Water Quality Certification" indicating the action complies with federal and state water quality standards detailed in 240.09.

Because the DOE certification depends on the finalization of the other water oriented permits, (such as Section 404 Permit, Shoreline Substantial Development Permit, etc.) the district and the Bridge and Structures Office should coordinate permit application times. This will enable all water permits to be acted upon concurrently and avoid possible delays.

### **(3) Coast Guard Bridge Construction Progress Report**

A Coast Guard Bridge Construction Progress Report is required each month on all projects that have a Coast Guard permit. The report itemizes and identifies the location of known obstructions and their sequence of removal from the waterway. The district prepares the report and sends it to the headquarters Project Development Office, which submits the report to the Coast Guard. The Coast Guard permit also requires that they be notified when permitted portions of a project are complete. To ensure timely notification, the district will notify the headquarters Project Development Office which in turn notifies the Coast Guard that permitted construction is complete.

## **240.04 UNITED STATES FOREST SERVICE (USFS)**

### **(1) General**

Under the Department of Agriculture, the USFS is responsible for the management of National Forests.

When the project will use lands managed by the USFS, each district is responsible for coordination and negotiation with the USFS on all matters related to highway use and occupancy in national forest lands. The district contacts the headquarters Land Management Office to coordinate and negotiate matters concerning acquisition of property rights with the USFS. If the project is on WSDOT fee title lands within USFS boundaries, the USFS has no jurisdiction and need not be contacted.

The Memorandum of Understanding "Highways Over National Forest Lands," M 22-50, for highways in national forests is a general policy outlining responsibilities of WSDOT and the USFS.

### **(2) Procedures**

The Memorandum of Understanding is used for coordinating location, design, construction, maintenance, signing, access control, and other matters related to state highway and forest highway use and occupancy. Generally, the following procedures apply:

- (a) The district provides data to the Forest Supervisor, showing proposed routes of the improvement, and requests a Stage I Multiple Use Survey Report. A joint pre-survey field review is then made by the Forest Supervisor and the district.

The district forwards 2 copies of the Stage I Report to the headquarters Design Office for review. Any comments or recommendations made by Design are sent to the district for action.

- (b) Following agreement between the WSDOT and the USFS on the contents of the Stage I Report, the district develops the design report and the USFS initiates a Stage II Multiple Use Survey Report. The development of these reports should be coordinated and concurrent, to resolve any difference of treatment or conflict of use between the district and the USFS.

The district furnishes copies of the proposed design report to the USFS and arranges for joint review. If mutual agreement cannot be reached on some aspects of the design report or Stage II Report, respective viewpoints will be defined and presented in the reports from each jurisdiction. Disagreements are negotiated through the headquarters Design Office, with district participation.

Copies of the Stage II Report are submitted by the USFS to the district for review; the Stage II Multiple Use Survey Report is processed and approved in the same manner as a design report.

The FHWA and USFS have developed the following guidance when federal projects involve USFS land. This guidance was issued as an FHWA Notice, May 1973, titled "Coordination of Environmental Impact Statements with the U.S. Forest Service."

For these projects the district will request the USFS to make a determination statement that the land being proposed for highway use is or may be categorized as Section 4(f) land. The USFS will respond by one of three following ways, as noted below, prefaced by the following paragraph:

The proposed (Name) route (Location) (and the alternate routes) has been reviewed against the criteria of Section 4(f) of the USDOT Act of 1966, PL 89-670, as amended by the Federal Aid Highway Act of 1968, PL 90-495, Section 18.

Situation 1. Since this route crosses an area of Public Land under National Forest designation, as the Agency having jurisdiction of these Public Lands, we have determined that the route does not encroach on or use land from any of the types of specially designated areas in the above Public Laws.

Situation 2. Since this route crosses an area of Public Land under National Forest designation, as the Agency having jurisdiction of these Public Lands, we have determined that the route does in fact encroach on and uses land from a (type of area(s)) as specified in the above public laws and we recommend a 4(f) determination procedure be initiated.

Situation 3. Since this route crosses an area of Public Land under National Forest designation, as the Agency having jurisdiction of these Public Lands, we have determined through detailed analysis that conditions of use exist of a nature which requires a designation of the type stated in the above act. It is our intent to now proceed with such a designation. Since the project will use land from the area proposed for designation, we recommend that a 4(f) determination procedure be followed.

The district must incorporate the USFS's response into the environmental document identifying the Forest Service's designation of the land and preparing a 4(f) evaluation if required.

## **240.05 FEDERAL AVIATION ADMINISTRATION (FAA)**

### **(1) General**

Proposed highway construction in the vicinity of public-use and military airports requires an FAA Notice. The district should make contact with airport authorities as

early as possible to facilitate progress of location and design work within the required FAA regulations.

### **(2) References**

- Federal Aviation Administration regulations Part 77. Objects Affecting Navigable Airspace.
- *Federal-aid Highway Program Manual* (FHPM 6-1-1-2) Highway Improvements in the Vicinity of Airports.

### **(3) FAA Notice (Form 7460-1)**

The requirements are shown on Figure 240-2. The WSDOT district will submit the following information to the FAA Regional Office:

- (a) Map showing airport location with respect to existing highways. An 8-1/2 X 11 inch vicinity map with project and airport locations indicated is adequate.
- (b) Map and diagram to show pertinent distances and elevations between runways and the proposed highway.
- (c) Plans and profiles showing elevations of earthwork, pavement, structures, and intermediate obstructions, if any. Include the height of luminaires, bridge towers, or other tall appurtenances.
- (d) One completed set of FAA Form 7460-1, "Notice of Proposed Construction or Alteration."

Form 7460-1 must be submitted by the district at least 30 days before the date proposed construction or alteration is to begin. Form 7460-1 may require review and perhaps resubmittal if it is submitted more than 18 months in advance. The Assistant Secretary for Aeronautics should be contacted for clarification of aeronautic permits or FAA form 7460-1.

If Form 7460-1 results in studies by the FAA that may affect the proposal, the headquarters Project Development Office should be notified and included in any decisions. A record should be maintained of all contacts made with the FAA.

## **240.06 FHWA - WESTERN FEDERAL LANDS HIGHWAY DIVISION (WFLHD)**

### **(1) General**

WFLHD administers, advertises and awards projects which may include Indian Reservation Roads, National Park Roads, Forest Highways, Defense Installation Roads, etc. These projects may involve WSDOT by being on the state system or impacting the state system or local road systems.

Scheduling, planning, and programming of federal highway projects are considered in the development of other federal-aid highway programs. Representatives of WFLHD consult annually with the FHWA Division

Office, WSDOT, and land management agencies concerning long-range planning and development of annual programs.

When WSDOT and WFLHD are co-participants in the development of a project, the function of each will be defined in a project agreement and a lead agency determined.

## **(2) References**

The following should be reviewed when developing projects with WFLHD:

- Federal-aid Highway Program Manual (FHPM Volume 6, Chapter 9), Special Programs.

## **(3) Procedures**

Prior to design phase or project development, the lead agency is determined between WSDOT and WFLHD.

When WSDOT is the lead agency, normal project development procedures are followed, including submittal of the design report to the FHWA Division Office by the headquarters Project Development Office.

WFLHD coordination for local agency projects will be through the State Aid Organization.

The following procedures generally apply when WFLHD has lead responsibility:

- WFLHD sends a request for a project review to the WSDOT district, specifying which items to review. A copy of the transmittal letter is sent to the headquarters Project Development Office. The request outlines the commitments required from the state. The items to review include such things as vertical and horizontal alignment, intersection design, bridge design, right of way plans, special provisions, sundry site plans, and utility plans.
- The district reviews the items and transmits the information to the headquarters Project Development Office for review. The district then coordinates all review actions and responds to WFLHD with all comments.
- The district will normally develop all access control activities; using procedures as outlined in Chapters 1420, 1430, and the Plans Preparation Manual.
- WFLHD forwards Environmental Document, Final Access Plan, Right of Way Plan, and PS&E, thru the district to the headquarters Project Development Office for final approval. They are then returned to the district with copies of pertinent correspondence.

## **240.07 FEDERAL ENERGY REGULATORY COMMISSION**

### **(1) General**

The Federal Energy Regulatory Commission (FERC) licenses agencies to develop hydroelectric projects.

WSDOT becomes involved with the FERC, through a license, when it proposes a project that may use lands within the boundaries of a hydroelectric project. The governing regulation of FERC, 18 CFR Parts 1-149, establish requirements that the licensee (hydroelectric project owner) must follow in approving uses for a third party action within the boundaries of a hydroelectric project.

### **(2) Procedures**

To know what conditions will be required of the department, the district should initiate early coordination with the licensee. Approval to utilize lands within the hydroelectric project boundaries are granted when WSDOT resolves issues with the licensee and federal and state agencies having jurisdiction over fish, wildlife, shorelines and archaeological/historical concerns. The licensee does all necessary coordination with the FERC which can be a concurrent function with the department's other permit coordination activities.

## **240.08 ENVIRONMENTAL PROTECTION AGENCY**

### **(1) General**

When a project with federal funds affects water quality of the Spokane Valley-Rathdrum Prairie Aquifer, the Whidbey Island Aquifer or the Camano Island Aquifer the department evaluates the project in accordance with a Memorandum of Understanding between FHWA, Region 10 and EPA, Region 10, signed November 1982. This memorandum outlines basic evaluation criteria and procedures to be followed by FHWA and EPA in conducting formal project reviews.

EPA and FHWA mutually agree that, generally, only projects requiring an environmental impact statement or environmental assessment need be submitted for review. Other projects which FHWA determines may have an adverse impact on an aquifer are also subject to review.

### **(2) Procedures**

The department submits a summary of the project to FHWA. The summary includes a description of the project including termini, number of lanes or roadway width, type of construction, runoff control methods, and status of environmental document. Additional information may be requested by EPA if public controversy exists. EPA responds to project reviews within 30 calendar days unless they request an extension in writing or request additional information.

Information furnished to EPA is addressed to the Drinking Water Programs Branch in EPA's Region 10 office. Project review comments or findings by EPA are addressed to the FHWA Division office processing the project.

## **240.09 WASHINGTON STATE DEPARTMENTS OF FISHERIES AND WILDLIFE**

### **(1) General**

The Washington State Departments of Fisheries and Game (WDF & WDW) are combined herein for simplicity. The Department of Fisheries deals with food fish and shellfish. The Department of Game has jurisdiction over wild animals, wild birds, and game fish. Both departments have similar permit and approval requirements within water areas.

WSDOT must obtain Hydraulic Project Approval (HPA) from WDF & WDW whenever WSDOT operations will take place within the ordinary high water marks of any waters of the state within the jurisdiction of the WDF & WDW. The Memorandum of Understanding between WSDOT and WDF & WDW clarifies responsibilities regarding compliance with the Hydraulic Code RCW 75.20.100.

### **(2) Procedures**

The district determines which projects will affect waters under the authority of WDF & WDW and prepares an HPA application. Pre-application coordination may be desirable to adequately explain the project to the resource agency and ascertain their concerns. The application contains plans and a detailed narrative of proposed work, fish protection methods, anticipated date of proposed work, and name of WSDOT district representative.

The district submits an application to the headquarter's office of Fisheries and to the headquarter's office of Game. WDF & WDW will determine a need for the HPA. If an HPA is needed, WDF & WDW determine which of them will be the lead agency for the project and assign a field representative for field review.

The field representative contacts the district representative for coordination and review of project details. The respective agency representatives remain as project coordinators until completion of the project.

When the field review is complete and SEPA requirements have been met, the lead agency issues an HPA to WSDOT. WSDOT then incorporates provisions of the HPA into the project design. The district maintains coordination with WDF & WDW field representative to negotiate modifications to the project design documents and to the HPA if necessary.

The district also coordinates with the Bridge and Structures Office and the headquarters Project Development Office to maintain the exchange of information necessary for reviews and approvals.

The HPA issued for the project is also applicable to the construction project. Further details about an HPA application are covered in the *Construction Manual*

M 41-01, Chapter 1 regarding "Relationship with FHWA and Other Federal, State and Local Agencies."

If an emergency condition exists and there is insufficient time to secure an HPA through normal channels, WSDOT contacts the WDF & WDW for oral approval. WDF & WDW should put the approval in writing within 30 days of oral approval.

## **240.10 WASHINGTON STATE DEPARTMENT OF ECOLOGY (DOE)**

### **(1) General**

The DOE has the legal authority to manage and develop Washington's air and water resources and to conduct a coordinated program of pollution control involving these and related land resources. The district obtains approval of water appropriation and pollution control measures and coordinates as needed with DOE.

### **(2) References**

Refer to the Permits and Approvals listing at the end of this chapter (Figures 240-1a and 1b) and the specific legal references for the permit under consideration.

### **(3) Permits**

- (a) **Water Quality Certification.** Certification from DOE is required to obtain a federal permit or license for an action that may result in a discharge into navigable waters (240.02 and 240.03). The certification states that the discharge will comply with federal and state water quality standards. It may include a Short Term Modification of Water Quality Standards. (See (e) below.) An application for Water Quality Certification is not required.
- (b) **Flood Control Zone Permit.** This permit indicates that a WSDOT project within a flood-control zone will be planned, constructed, operated, and maintained so it will not adversely influence the existing system of a stream or body of water, or adversely affect the security of life, health, and property against damage by flood water. The permit may be obtained from the DOE or from a local agency if the permit has been delegated by the DOE.
- (c) **Coast Zone Management Certification.** This certification of compliance is an approval identifying the WSDOT project as consistent with the State and Federal Coastal Zone Management program. The approval may be issued in conjunction with Federal Permits (240.02 and 240.03).
- (d) **Waste Discharge Permit.** This permit is required for operations involving sand and gravel washing, borrow pit dewatering or discharges from cement and asphalt batch plants into waters of the state. The state permit is the State Waste Disposal (Discharge) Permit. The federal equivalent is a National Pollution

Discharge Elimination System (NPDES) permit. DOE issues a combined permit satisfying both state and federal requirements. This permit may include a Short Term Modification.

- (e) **Short Term Modification.** This permit is advised when the project activities may temporarily degrade water quality and a Waste Discharge Permit or Water Quality Certification is not necessary. This permit exempts WSDOT from being cited for violating water quality standards as long as the project complies with the prescribed terms and provisions.
- (f) **Appropriation of Water.** A water right permit must be obtained from DOE before surface or ground water is appropriated for beneficial use. If the use is for construction purposes, such as dust control or batch plant operation, the permit is temporary and expires when the project is complete. The contractor usually applies for a temporary water permit but, if the usage is specifically required by WSDOT, the district acquires the permit before awarding the contract. If WSDOT needs to develop a permanent water supply, such as for a rest area or maintenance facility, the district applies to the DOE regional office for a permit to develop a water source. After the source is put to use, DOE issues a certificate establishing a water right in perpetuity.

#### (4) Procedures

The district determines which permits are applicable to the project, assembles the pertinent design information, and applies to the DOE regional office for a permit. If the information is inadequate, the DOE requests further information. If the application was appropriate, the DOE acts upon the request. If other DOE permits are required, the DOE will inform the district.

The headquarters Project Development Office may be requested to assist in resolving differences with the DOE. If the DOE has not responded to a permit request within 30 days, they should be contacted to determine the cause for delay and how to expedite a response. The district sends copies of correspondence and the permit to the headquarters Project Development Office.

#### (5) Water Pollution Control Plan (WPCP)

The WPCP contains design details of water pollution control measures for a project.

- (a) **Procedures.** The district arranges a meeting with the appropriate DOE region and a headquarters Project Development Office representative at least annually to review upcoming projects that may have potential for water pollution. The district presents sufficient information to enable the DOE to determine whether a WPCP is necessary and what permits may be required. After the review, the district notifies the headquarters Project Development Office of projects

requiring a WPCP. When the district prepares the actual plan they will coordinate with the DOE region and, as needed, get technical assistance from the headquarters Project Development Office. The completed plan is sent to the headquarters Project Development Office for review and approval. After approval, the district submits the WPCP to the DOE region for approval along with a copy of or reference to the approved SEPA document.

After DOE approves the WPCP, the district incorporates the relevant contents of the approved WPCP into the Contract Documents. As outlined in the Standard Specifications for Road, Bridge, and Municipal Construction (Section 1-07), the district also reviews, approves, and implements the contractor's Temporary Water Pollution Control Plan. Temporary Water Pollution Control Plans should be carefully checked for compliance with the DOE approved WPCP in the contract documents. Any substantive deviations from the DOE approved WPCP should be discussed with DOE Regional representatives prior to approval of the contractor's plan.

Construction activities should be monitored by the district to ensure that the DOE approved WPCP and the contractor's Temporary Water Pollution Control Plan are followed and water quality is not adversely impacted. Additional measures to protect water quality may be needed as construction progresses and should be implemented when required.

For projects that involve rest area or maintenance site sewage disposal systems, the district shall submit plans and specifications to the DOE, DSHS, or local agency, depending on the volume of the system. See Figures 240-1a and 1b for the Permits and Approvals listing. After a mechanical or lagoon treatment facility is constructed, the district will submit an Operation and Maintenance Manual to DOE as per WAC 173-240.

#### (b) Contents of WPCP.

- Location and description of the project using a vicinity map and a detailed site map showing wells, streams and other water bodies, water and sewer lines, existing and proposed drainage, pollution control facilities, and access routes to these facilities.
- A list of wells, streams, and water bodies that might be impacted by the project, including their water quality classification and use.
- A list of permits or other documentation required for the project, such as Corps of Engineers, Shoreline, and Hydraulic Project Approval.
- Describe the construction and operation of stormwater systems including design storms and runoff quantities, drainage system sizes



and capacities, and locations of discharges to receiving waters.

- Discuss construction and operation of erosion control methods, including maximum disturbed areas, contributing areas, and proposed maintenance.
- Discuss construction and operation of sediment control including methods, location, size, design criteria, and proposed maintenance.
- Oil and buoyant material control methods and proposed maintenance including hazardous spill control locations, methods, capacities, and clean-up procedures.
- Woodwaste fill and stockpile locations, construction procedures, drainage, and leachate control and prevention methods.
- Waste disposal methods and locations.
- Timing for installation of pollution control facilities.

## **240.11 WASHINGTON STATE DEPARTMENT OF NATURAL RESOURCES (DNR)**

### **(1) General**

The DNR administers the Forest Practice Act, the state's natural resources, and certain state-owned lands. These lands include tidelands and shorelands, school trust lands, Forest Board lands, escheat lands, and certain Federal Land Grants provided by the Enabling Act.

When any DNR lands are needed for highway purposes, WSDOT negotiates for that use with the Commissioner of Public Lands. Except for obtaining rights of entry to do surveys and studies, all coordination and negotiations for DNR lands are made by the WSDOT Land Management Office.

### **(2) Lease Property**

When WSDOT requires highway materials from DNR land, the district submits one copy of SF-4046, Application to Purchase Materials Upon State Lands, through the Land Management Office to DNR. The application includes estimates of quantities, time periods, and a map showing site details. DNR reviews the application and negotiates a royalty with WSDOT. Both agencies sign a nonexclusive contract (lease) for a specified time, allowing WSDOT to extract material from the site. Every six months for the life of the extraction lease, the district sends a "Removal Report" to DNR stating amount of material removed and includes payment for that material. The permit or lease normally allows WSDOT to stockpile materials at the site if room is available. Prior to using the site, WSDOT must also complete a reclamation plan as shown in Chapter 510 and the *Plans Preparation Manual*. When WSDOT uses their own land for surface mining, a DNR operating permit for surface mining is required.

Details for obtaining the permit are found in the *Plans Preparation Manual*.

### **(3) Right of Entry**

When WSDOT determines that access to land is needed from the DNR, the district requests a Right of Entry from the local DNR office. A copy of the request is also sent to the Land Management Office. The district will not enter upon DNR land to survey or appraise until the Right of Entry is obtained.

### **(4) Transfer of Jurisdiction**

When the district determines that DNR land is required for the project, the district will develop the appropriate right of way maps indicating DNR land involved. When the district is ready to appraise the property, they will contact a DNR appraiser to jointly inspect the parcel so appraisal issues can be immediately identified and discussed. The Land Management Office determines the need for timber cruises or other special studies. With the appraisal process complete, the Land Management Office submits maps, legal description, letter indicating intent to acquire, and WSDOT offer to DNR. The DNR should respond in 60 days. If accepted, WSDOT receives a Transfer of Jurisdiction. If rejected, the Land Management Office continues negotiations.

If lands are needed for a marine facility the WSDOT must only file a map of required area with DNR in accordance with RCW 47.12.026.

If any of the above actions involve leased DNR land, the WSDOT must get a release or waiver from the lessee before the DNR will act.

### **(5) Washington Forest Practice**

(a) **General.** The DNR administers and enforces the Washington Forest Practices Rules and Regulations, except as otherwise provided in the Forest Practice Act. WAC 222, "Washington Forest Practices Rules and Regulations," is available in booklet form through the DNR. Lands may be private or publicly owned lands on which activities are planned that are subject to the authority of the Forest Practices Regulations.

All Forest Practices Regulations are promulgated to achieve compliance with the water quality laws. Forest Land is land that is capable of supporting a merchantable stand of timber and is not being actively used for a purpose incompatible with timber growing. Forest Practice is any activity conducted on or directly pertaining to forest land and relating to growing, harvesting, or processing timber such as road and trail construction, harvesting (final and intermediate), precommercial thinning, reforestation, fertilization, prevention and suppression of

diseases and insects, salvage of trees, and brush control.

When any land that can be defined as Forest Land is altered or becomes the site of construction, the district may be required to fill out a Forest Practices Application/Notification form and submit it to the DNR area office. If the contractor fills out the application, it must still be signed by the District Administrator. Permit application forms are available from DNR. Locations and addresses are shown on Figure 240-3.

**(b) Permit Procedures.** The types of Forest Practices for the determination of permit application and notification requirements are divided into four classes:

- Class I Forest Practice operations are those with no direct potential for damaging a public resource. Class I requires no application or notification but does require compliance with all other Forest Practice Regulations.
- Class II Forest Practice operations are those that are determined to have a less than ordinary potential to damage a public resource. Class II requires a notification to DNR. Operations may begin five calendar days after the notification is sent.
- Class III Forest Practice operations are those that are not listed under Classes I, II or IV. Class III requires an application that must be approved or disapproved within fourteen calendar days of receipt by DNR.
- Class IV Forest Practice operations are those that are determined to have potential for a substantial impact on the environment. Class IV Forest Practices are divided into two groups; Class IV Special and Class IV General. Each requires an application to DNR that is approved or disapproved within thirty calendar days. Class IV Special requires an additional evaluation by DNR to determine whether a detailed environmental impact statement is necessary. Additional time is generally required when a detailed environmental impact statement is necessary.

## **240.12 WASHINGTON STATE DEPARTMENT OF LABOR AND INDUSTRIES**

### **(1) General**

When WSDOT has need to store explosives, the district obtains a storage license from the State Department of Labor and Industries (L&I).

### **(2) License**

The district files an "Application for License to Operate a Storage Magazine for Explosives." The application is available through any office of L&I and must be submitted with detailed plans of the storage facility showing

its distance from inhabited buildings, public highways, and other facilities. The approximate quantity, in pounds, of stored material or storage capacity should also be identified.

### **(3) Procedures**

The district completes the application and sends it to the Olympia Office of L&I. The district also takes the lead in coordinating with any other agency that may be involved to secure approval of the storage facilities.

If the stored material involves projectiles or military explosives, the facility plan must be coordinated with and reviewed by the U.S. Department of Defense.

Concurrence to store explosives must also be obtained from the property owner where the facility is on lands that WSDOT does not own, such as U.S. Forest Service Land, DNR land, etc.

## **240.13 LOCAL AGENCIES**

### **(1) General**

Many local agencies have miscellaneous use permits and regulations that they have instituted to maintain orderly growth and development. WSDOT complies with permits, approvals, or licenses delegated to the local agency by the state, such as building, air pollution, and shorelines permits.

The Department of Transportation, as a state agency, is not legally obligated and will not obtain permits and approvals enacted at local discretion. However, in maintaining a working relationship with local agencies, the district coordinates project development activities with the local agencies, seeking to obtain their views, comments, and input.

### **(2) Change of Grade Permit**

Whenever WSDOT construction entails a change in street grades in an incorporated city or town, the state is obligated by law to present the plans of new grades to the city or town for adoption by ordinance. To eliminate project delays, the district should send plans to the local agency for approval during the design report stage.

On limited access facilities, no grade approval is usually required for the highway itself. However, plans must be submitted to any incorporated city or town for grade approval for connecting streets, frontage roads, streets outside the limited access, and streets or connections within interchange areas, including any roadway passing over or under the facility but having no connection to it.

### **(3) Shoreline Substantial Development Permit**

**(a) General.** Local governments, delegated the authority by DOE, issue a Shorelines Permit for projects that involve substantial development on waters of the state or shorelines of the state. Shorelines of the state

include the water areas of the state and their associated wetlands, including lands within 200 feet of the high-water mark and associated marshes, bogs, swamps, floodways, river deltas, and flood plains. Streams with a mean annual flow of less than 20 cfs or lakes smaller than 20 acres (including the adjacent wetlands) are exempt. Substantial development means any development of which the total cost, or fair market value, exceeds \$2500; or, any development that materially interferes with normal public use of the water or shorelines of the state. DOE has maps showing areas affected by the Shoreline Development Permit.

A Conditional Use Permit or Variance (RCW 36.70, "Planning Enabling Act") is required when the project or an element of the project does not conform to the Shoreline Master Plan. For this permit, DOE makes the decision whether to approve or deny the permit based on the local agency's recommendation.

**(b) Process.** The district applies for a Shoreline Substantial Development permit from the local agency when sufficient design information is available. The local agency will schedule a hearing on the application to solicit any comments. When responses to comments are satisfied and the local agency receives WSDOT's final environmental document, the local agency then takes action on the shorelines permit. If the permit is denied, WSDOT may appeal to the Shorelines Hearings Board. Construction in the shoreline area cannot begin until 30 days after the permit has been approved.

#### **240.14 UTILITY AGREEMENTS**

To complete projects to the contract stage, it is frequently necessary to enter into agreements with numerous other entities. Most frequently used are Utility Agreements, Detour and Haul Road Agreements, and Railroad Agreements. The initiation of these agreements is done by the district Utilities Section. Further information is available in the *Utilities Manual*, M 22-87.

# Permits and Approvals

Permit Approval	Grantor	Conditions Requiring	When To Initiate	Who Applies	References
Section 10	Army Corps of Engineers	Obstruction, alteration, or improvement of any navigable water (rechanneling, piers, wharfs, dolphins, bulkheads, buoys...)	Early stages of project development	District	Rivers and Harbors Act — 1899 33 USC 401 § 10
Section 404	Army Corps of Engineers	Discharging, dredging, or placing fill material within waters of the USA or adjacent wetlands	Early stages of project development	District	Sec. 404 FWPCA 1972 33 USC 1344
Coast Guard Section 9	Coast Guard	Bridges and causeways in navigable waters, including all tidal influenced streams	After design	HQ Bridge Division	Rivers and Harbors Act — 1899 33 USC § 9
FAA Airport/ Highway Clearance	FAA	Airspace intrusion of highway facility (proposed construction in the vicinity of public use/military airports may require FAA notice)	During design/prior to work	District	FHPM 6-1-1-2 FAA Regs. P.77
Restricted Hydro-Electric Land	FERC	Utilize land from a FERC licensed project	During preparation of environmental document	District	18 CFR Part 2.13
Fish & Wildlife Coordination	USFWS	Consultation required when any waters are proposed to be modified or controlled	During preparation of environmental document	District	FWCA § 2 33 USC 66., 662
Wetlands Report	USFWS	Impact to lowlands covered with shallow and sometimes temporary/intermittent waters (swamps, marshes, bogs, sloughs, potholes...)	During preparation of environmental document	District requests HQ	49 USC 1651 EO 11990 (Protection of Wetlands)
Endangered/ Threatened Species	USFWS/NMFS	Plant or animal species that are suspected to be, or actually are, of the endangered or threatened status	During preparation of environmental document	District requests HQ	16 USC 1531-1543
Prime & Unique Farmland	Soil Conservation Service	Lands impacted are of prime or unique status	During preparation of environmental document	District	7 CFR 650
4(f)	FHWA and Affected Agency	Use of park and recreation lands, wildlife and waterfowl refuges, and historic sites of national, state, or local significance	During preparation of environmental document	District	49 USC 1651 (f) DOT Act of 1966 § 4 (Amended 5/19/78) FHPM 7-7-2(20) 23 CFR 138
Historic Section 106	OAHP	Suspected/actual historic/archaeological properties impacted by project	During preparation of environmental document	District to HQ	RCW 43.51.750 36 CFR 800 16 USC 470 Historic Preservation ActS106
Sole Source Aquifer	EPA	Any activity which may affect the aquifer recharge zone	During preparation of environmental document	District	SDWA P.L. 93-523
Hydraulic	Dept. of Fisheries and Dept. of Wildlife	Projects that will use, divert, obstruct, or change the natural flow or bed of any state waters (culvert work, realignment, bridge replacement, etc.)	After/during preparation of environmental document	District	RCW 75.20.100
Water Quality Certification	DOE	Prior to issuance of a federal permit/license for activity which involves discharge into navigable waters, certification of compliance with state water quality standards is necessary	During project development	DOE issues w/o requests	FWPCA § 401 RCW 90.48.260 WAC 173-225
Floodplains	DOE/Counties	Any structure/activity which may adversely affect the flood regime of stream within the flood zone	After/during preparation of environmental document	District	State-Flood Control Zone Act of 1935 Federal-EO 11988 (Flood plain Mgmt.)

Figure 240-1a

Permit Approval	Grantor	Conditions Requiring	When To Initiate	Who Applies	References
CZMA	DOE	Applicants for federal permit/license are required to certify that the activity will comply with the state's Coastal Zone Management program (Shoreline Management Act)	When applying for permit	District	CZMA Sec. 307 16 USC 145 RCW 90.58
NPDES	DOE	Discharge of pollutants into state surface waters	During design	District	WAC 173-220 FWPCA § 402 33 USC 1344 RCW 90.48.260
State Waste Disposal (Discharge)	DOE	Discharge of waste material from sand and gravel washing, pit dewatering, or cement/asphalt plant discharge into state waters	During design	District	RCW 90.48.160 WAC 173-220
Short-Term Modification	DOE (Regional)	Short-term activities which may result in temporary reduction of water quality standards and activities not subject to a waste discharge permit or water quality certification	During design	District	WAC 173-201-035(8)(e) WAC 173-201-035(5)(a) WAC 173-102-100(2)
Water Rights Appropriation	DOE	Appropriation of ground water or surface water	Prior to putting water to use	District or Contractor	RCW 90.44 RCW 90.03.250
Forest Practices Approval	DNR (Area Offices)	Public/private land capable of supporting merchantable timber — some activities — road construction, pits, pesticide use, hydraulic permits, shoreline permits, reforestation, etc.	Environmental document phase/prior to commencing	Contractor	WAC 222
Operating Permit for Surface Mining	DNR	Surface mining (pit and quarry sites) — more than 3 acres disturbed at one time or pit walls are more than 30 feet high and steeper than 1:1	After approval of the ultimate reclamation plan	HQ	RCW 78.44
Shoreline Management	Counties/Cities DOE	Shoreline development or construction valued at \$2,500 or more, or materially interfering with normal public use of water. Development within 200 feet of water must be consistent with the local Shoreline Master Plan.	During preparation of environmental document	District	RCW 90.58 RCW 36.70
Temporary Air Pollution	Local Air Pollution Control Authority/DOE	Pollutants above allowed levels for temporary periods	Prior to work commencing	Contractor	RCW 70.94
New Source Construction	DOE	Air pollution from point source (asphalt plants, rock crushers, etc.)	Prior to work commencing	Contractor	RCW 70.94.152
Building	County/City	Construction of any building — value of materials over \$500	Prior to work commencing	Contractor	RCW 36.21.080
Sewage Facilities	DOE/DSHS/County	Construction/modification of domestic/ industrial wastewater facilities (sewer relocation, rest area construction...) DOE: greater than 14,500 gpd, surface water discharge, or a mechanical treatment process involvement. DSHS: 3,500 gpd to 14,500 gpd. County: less than 3,500 gpd.	Prior to work commencing	District/ Contractor	RCW 90.48.110 WAC 173-240

CFR — Code of Federal Regulations  
 CZMA — Coastal Zone Management Act  
 DNR — Department of Natural Resources  
 DOE — Department of Ecology  
 EO — Executive Order  
 EPA — Environmental Protection Agency  
 FERC — Federal Energy Regulatory Commission  
 FHWA — Federal Highway Administration  
 FWCA — Fish and Wildlife Coordination Act  
 FWPCA — Federal Water Pollution Control Act

NMFS — National Marine Fisheries Service (Dept. of Commerce)  
 NPDES — National Pollutant Discharge Elimination System  
 OAHP — Office of Archaeology and Historic Preservation  
 RCW — Revised Code of Washington  
 SDWA — Safe Drinking Water Act  
 USFWS — U. S. Fish & Wildlife Service (Dept. of Interior)  
 WAC — Washington Administration Code

Figure 240-1a

NOTICE REQUIREMENTS RELATED TO HIGHWAYS

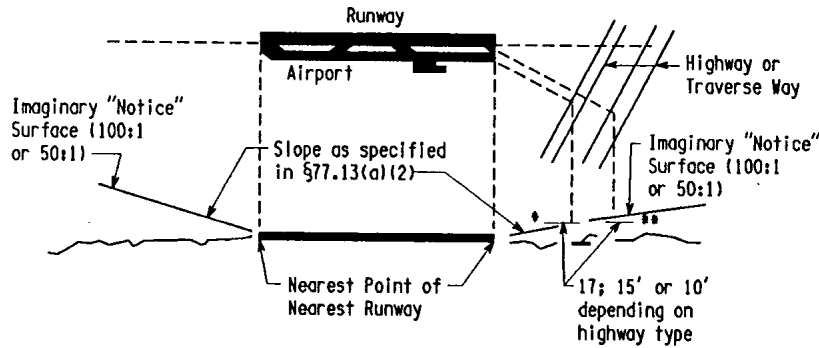

NOTICE REQUIREMENTS RELATED TO HELIPORTS

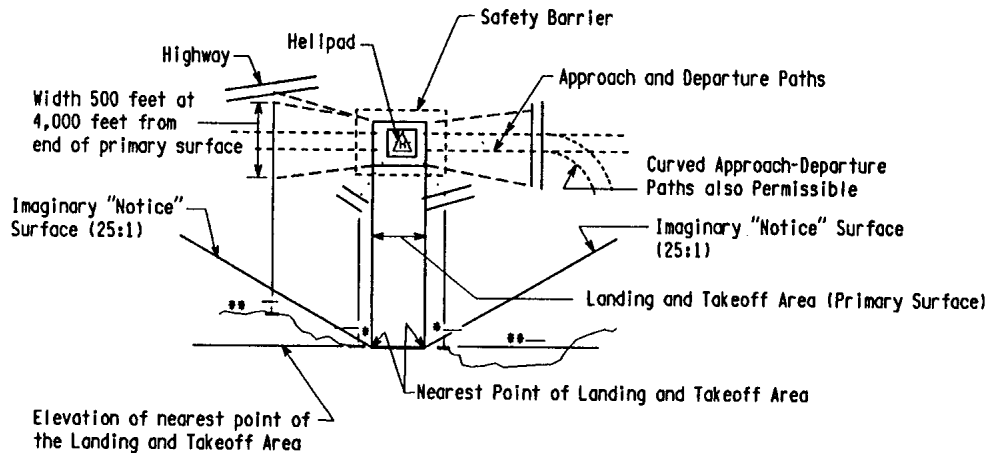

- \* Notice required
- \*\* Notice not required

NOTES:

The following FAA Notice requirements are excerpts from; Federal Aviation Regulations Part 77, Objects Affecting Navigable Airspace, Published January 1975.

Each airport must be available for public use and listed in the Airport Directory of the current Airman's Information Manual, or in either the Alaska or Pacific Airman's Guide and Chart Supplement; under construction and the subject of a notice or proposal on File with FAA, and except for Military airports, it is clearly indicated that that airport will be available for public use, or operated by an armed force of the United States. (Heliports and seaplane bases without specified boundaries are excluded.)

SUBPART B - NOTICE OF CONSTRUCTION OR ALTERATION

§77.13(a)(2) - A notice is required for any proposed construction or alteration that would be of greater height than an imaginary surface extending outward and upward at one of the following slopes -

- (i) 100 to 1 for a horizontal distance of 20,000 feet from the nearest point of the nearest runway more than 3,200 feet in actual length.
- (ii) 50 to 1 for a horizontal distance of 10,000 feet from the nearest point of the nearest runway of each airport with its longest runway no more than 3,200 feet in actual length.
- (iii) 25 to 1 for a horizontal distance of 5,000 feet from the nearest landing and takeoff area of each heliport, available for public use and listed in the Airport Directory of the current Airman's Information Manual or in either the Alaska or Pacific Airman's Guide and Chart Supplement; is under construction and is the subject of a notice or proposal on file with the FAA and except for military heliports, it is clearly indicated that that heliport will be available for public use, or operated by a Federal Military agency.

§77.13(a)(3) - Notice is required for any proposed construction or alteration of any highway, railroad, or other traverse way for mobile objects if a greater height than the standards of 77.13(a)(1) or (2) after their height has been adjusted upward by one of the following:

- 17 feet for an Interstate highway that is part of the National System of Military and Interstate Highways,
- 15 feet for any other public roadway, 10 feet or the height of the highest mobile object that would normally traverse the road, whichever is greater, for a private road,
- 23 feet for a railroad

For a waterway or any other traverse way, an amount equal to the height of the highest mobile object that would normally use it.

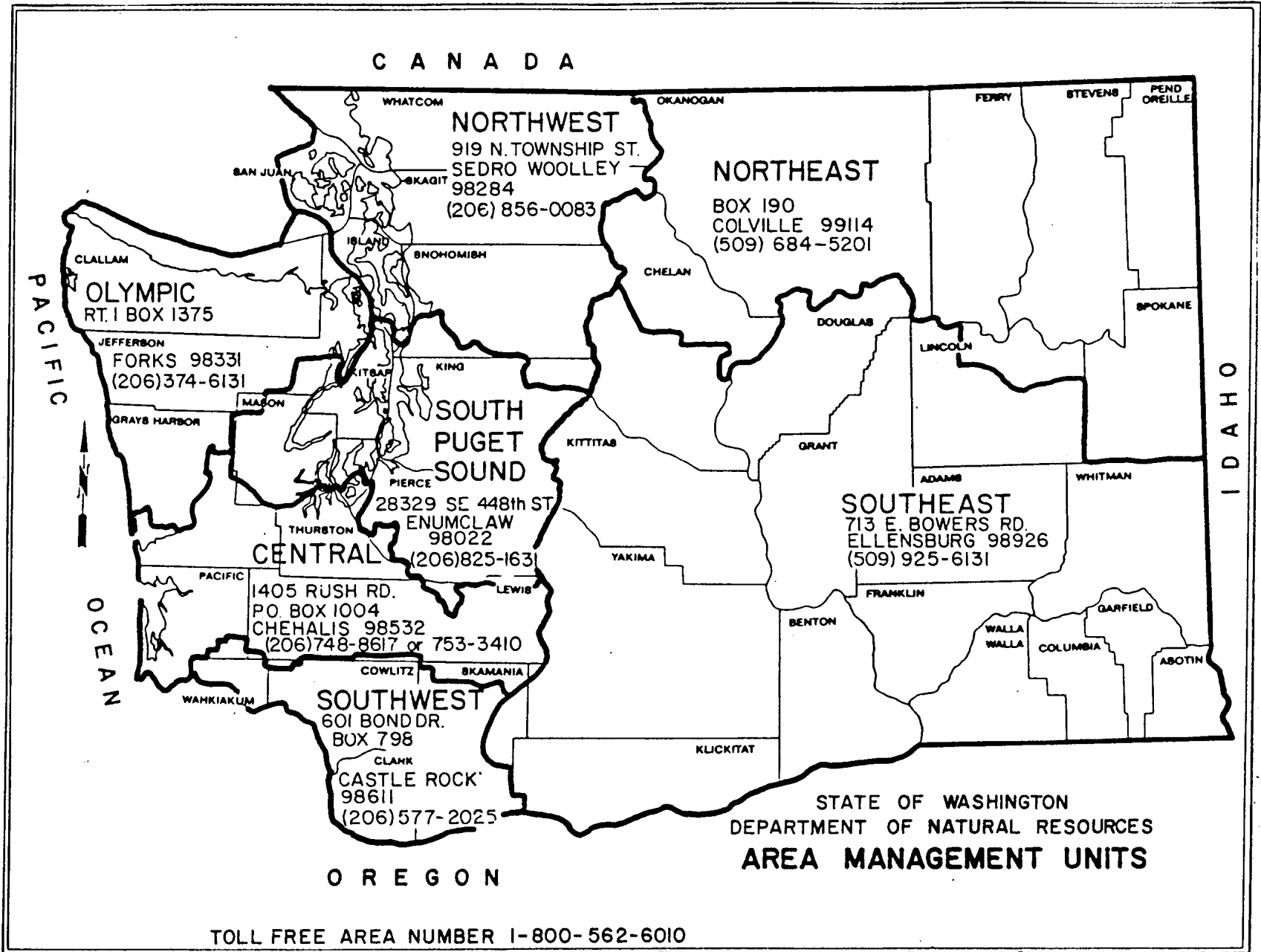

**DNR AREA MANAGEMENT UNITS**  
Figure 240-3

# 310

## Preliminary Studies

- 310.01 General
- 310.02 Legislative Studies
- 310.03 Route/Design Studies

### 310.01 GENERAL

Preliminary project studies are prepared to identify the feasible route alternatives or design options before advancing the project.

Preliminary studies are undertaken at the discretion of the district, or at the request of the legislature, Transportation Committee, or WSDOT management. Preliminary studies should not be used when the required environmental and design report process would more appropriately render a decision.

### 310.02 LEGISLATIVE STUDIES

Mandate for a study comes from the legislature in the form of a law or a resolution. Responsibility for execution of the study may be assigned to the Legislative Transportation Committee, the State Transportation Commission, or a consulting firm. The study may encompass any subject within the scope of the Commission's jurisdiction. The Assistant Secretary for Planning, Research and Public Transportation has primary staff responsibility for implementing legislative studies assigned to WSDOT. Initially, the legislative intent and scope of the study need to be clarified. If the session law does not make the intent clear, then the sponsoring legislators are contacted by department management to determine intent and precisely what information is being sought. If WSDOT is assigned the project, a Study Plan is developed which includes a statement of the legislative intent, a scope of work, a time table for the completion of the study, and an estimate of cost to complete the study. The study cost estimate is shown in Figure 310-1.

The scope of work spells out the areas of study and detail with which they will be investigated. It specifies the organization that will be responsible for gathering data for, or preparing, the various sections of the study. The format of the report is another item that is determined at this time.

A timetable is needed, since frequently the department is working against a fixed deadline for submittal to the legislature. When several organizations are contributing to the total study, it will establish when each portion must be completed.

When a study plan has been prepared, a fund request is made for conducting the study. The fund request will be made by the Assistant Secretary for Planning, Research and Public Transportation.

### (1) Content of Study Report

(a) **Areas of Investigation.** The following are some areas of investigation which may be applicable to individual studies, or as a guide to possible areas of investigation and to suggest other topics which might be included:

- Origin and destination surveys.
- Traffic analysis and evaluation.
- Benefit/Cost analysis.
- Functional classification evaluation.
- Accident analysis and summary.
- Bridge condition survey evaluation and analysis.
- Maintenance evaluation.
- Photogrammetric services.
- Soils and geological surveys and analysis.
- Land use study and analysis.
- Environmental impact analysis.
- State interest evaluation.
- Economic impact evaluation.
- Social impact evaluation.
- Public involvement evaluation.
- Engineering evaluation.
- Cost estimates.
- Toll feasibility analysis.

Only items bearing on the issues being investigated should be included in the report.

(b) **Allied Procedures.** Environmental procedures are not necessarily applicable to legislative studies. A formal Environmental Impact Statement (EIS) is not prepared unless one is specifically required. However, every attempt should be made to identify anticipated environmental impacts and the probable extent of those impacts so that the study report may be used to make decisions on the basis of material it contains.

Public involvement procedures such as workshops, public meetings, community surveys, and newsletters may be utilized, if desirable or necessary, to develop data to complete the study. All publicity procedures should be checked with the legislative sponsor prior to taking any action since extensive publicity may be undesirable.

Hearings are not held by the department unless specifically required by the legislation. The appropriate legislative committee schedules and makes all arrangements for any hearings which are held.



(c) **Written Text.** Most who read the report and act upon it do not have a technical background. To be effective the report should be written in easily understood language. If detailed technical data is needed or used in the report, it should be summarized in nontechnical language. The technical details may be included in an appendix or retained as back-up data.

Estimates of cost should only contain the major items, and should be rounded off commensurate with the accuracy of the methods used in developing quantities. It may be desirable to give a cost range for the estimate rather than a single figure. Estimate worksheets should be retained as back-up data. The date of the price index used in the estimate and the methods used in developing the estimate should be recorded.

If several people write different sections of the report, it should be edited and finalized by one person so that there is continuity and a similar style of writing throughout.

The report should be thorough, but concise, with the inclusion of support data, maps, photographs, and charts. Use and documentation of the best available resources should be made.

The report should present only the facts developed in the study. It should not make a recommendation. The department's recommendation is made in the letter of transmittal which is signed by the Secretary. A copy of the letter is bound in each copy of the report.

(d) **Maps, Photographs, and Charts.** Maps, photographs, charts, etc., are an important part of any report and frequently can be a deciding factor in whether the findings are understood and consequently accepted or rejected. The following are points to keep in mind when preparing these materials for a report:

- Maps, photos, charts, etc., should have a title, a scale and north arrow, if appropriate.
- The scale of maps or aerial mosaics should be dictated by the needs and characteristics of the particular study. Generally, the smallest practical scale should be used (consistent with illustrating the necessary details).
- Vertical alignment profiles may be necessary depending upon the requirements of the particular study. If they are not pertinent to the study, they should be omitted. If profiles are used, they should be to the same scale and on the same sheet as the plan.
- Maps, and particularly plan-profile sheets, should be limited to 11 by 17 inch maximum size (8 ½ by 11 inch size is preferred). Sometimes it is feasible to utilize facing pages which allow an 11 by 17 inch size without a fold-out. Avoid long fold-outs.

- Photographs, charts and graphs should be clearly labeled, easily interpreted, and relevant to the study. Lettering size and contrast should maximize readability.

## (2) Format of Study Report

Reports are standardized in the interest of maintaining continuity.

The report should be put together in the following sequence:

- (a) Front Cover
- (b) Letter of Transmittal
- (c) Title Page
- (d) Table of Contents
- (e) Summary
- (f) Body of Report
- (g) Appendices

For continuity of legislative reports and consistency in identification of departmental publications, it is necessary to use the same color and design for all report covers prepared during a particular legislative session. An 8 ½ by 11 inch size is used unless there is some reason to do otherwise. Preparation of covers should be coordinated with the Public Affairs Office. Information to be included on the report cover is shown in Figure 310-2.

The letter of transmittal contains the departmental recommendation and is signed by the Secretary. A draft is prepared by the District Administrator or Assistant Secretary responsible for the study and submitted to the Assistant Secretary for Planning, Research and Public Transportation with the draft report. The final letter is prepared and submitted to the Secretary for signature.

A sample of a typical title page is shown in Figure 310-3. As a minimum, it should contain the information shown. Transportation Commissioners are listed in the order of seniority.

The table of contents, introduction, and summary are generally self-explanatory. The introduction and summary should be brief, clear, and understandable. The summary should not contain a recommendation or material that has not been discussed in the body of the report.

The body of the report may be styled and formatted to fit the needs and content of the particular study, in a manner which makes the most effective presentation of the study material.

The appendices should contain any back-up data, technical material, or other information which is determined to be desirable or necessary to include in the report but which are too cumbersome or awkward to include in the body of the report.

### **(3) Publication and Distribution**

The headquarters Reproduction Section has the capability and expertise to turn out quality reports. When it is necessary or expedient to use the Department of Printing or commercial sources, coordinate arrangements through the headquarters Reproduction Section.

Distribution of the report is made by the Assistant Secretary for Planning, Research and Public Transportation (PR&PT) on the following basis:

- 55 copies to Legislative Transportation Committee
- 1 copy to State Transportation Commission
- 1 copy to Secretary of Transportation
- 1 copy to Deputy Secretary of Transportation
- 1 copy to Assistant Secretary for Aeronautics Division
- 1 copy to Assistant Secretary for Highways Division
- 1 copy to Assistant Secretary for Management Services Division
- 1 copy to Assistant Secretary for Marine Transportation Division
- 1 copy to Assistant Secretary for Planning, Research and Public Transportation Division
- 1 copy to Legislative Liaison
- 1 copy to Public Affairs Administrator
- 3 copies to WSDOT Library (Additional copies may be requested for State Library)
- 1 copy to State Project Development Engineer
- 1 copy to Program Development Engineer

For reports that may have wide public interest, extra copies should be available to the Legislative Transportation Committee for public distribution.

RCW 47.01.145 requires that whenever a study is prepared for the Legislative Transportation Committee, it should be available to each legislator. Individual legislators are furnished copies upon their request. This should not be done until the study is transmitted to the Legislative Transportation Committee.

The study is considered the property of the Legislative Transportation Committee and it is their decision as to when and to whom the report is distributed. Results of the report and department recommendations are not made public until the report has been furnished to the Legislative Transportation Committee. All requests for copies of the report will be referred to the Legislative Transportation Committee through the Assistant Secretary for PR&PT.

### **310.03 ROUTE/DESIGN STUDIES**

A preliminary study can be developed by the district when there is a need for selecting new routes, for evaluating design alternatives, to better define affordable solutions, or to more accurately define a project or related group of projects and their associated budget needs.

The study of a project begins by determining need and controlling factors within the project area (e.g., terrain and existing or potential facilities). Maps, photographs, environmental findings, and engineering data needed for investigation of each alternative are assembled. When presenting alternative comparisons, the same basic criteria and methods of investigation and evaluation are used for each alternative.

Assign a number or letter to each alternative involved in the study and identify each alternative by that designation throughout the study and in all reports and estimates.

To facilitate comparison, designate the beginning and end of all alternates from common termini.

#### **(1) Preliminary Data**

All support data, maps, and graphics must provide a sound basis for route planning and design alternates. The following types of information are used:

- Land use, population and density.
- Geological structure.
- Potential of the area for future industrial, residential, farm, or recreational development.
- Existing roads and highways serving the area.
- Existing, planned and potential utilities and facilities.
- Photogrammetric maps and aerial photographs of the area.
- Environmental conditions.

#### **(2) Information Resources**

Recent 7 ½ minute or 15 minute quadrangles or aerial surveys provide adequate information for the initial investigation. These and other maps, photographs, and data can usually be obtained from the following sources:

- Previous surveys and reports.
- Maps by federal, state, county, and municipal agencies.
- Stereographs from private sources and governmental agencies, particularly the USGS and U.S. Department of Agriculture.
- Geological reports and bulletins.
- Railway maps and profiles.
- Maps made by the Cartographic Section of the PR&PT Division.

(Also refer to Chapter 1440.)

### **(3) Mapping Requirements**

The type and scale of mapping required are dictated by the terrain and land use intensity of the study area. Mosaic reproductions or photographic prints may be used to show alternatives.

Mapping for urban and suburban areas should be to a scale of 1 inch equals 100 or 200 feet with 5 or 10-foot contour intervals. In areas of little or no land use and in mountainous or heavily timbered areas, mapping may be done to a scale of 1 inch equals 400 feet with 10-foot contour intervals. This mapping may be done photogrammetrically.

Headquarters Geographical Services Branch is available to assist in the preparation of route maps. Geographical Services will make available upon request planimetric and topographic maps, halftone photography and strip maps, regular photography at any scale desired, and all types of photogrammetric mapping and related products.

### **(4) Traffic Analysis**

The district or division will prepare a sketch map showing the traffic data needed for evaluation and forward the map and survey request to PR&PT. The request should note any possibility of a proposed environmental document, which would require additional traffic data and analysis.

Traffic analyses for interchanges, ramps, structures, or intersections, for proposed or existing facilities, or other special traffic needs will be furnished upon request.

### **(5) Route/Design Considerations**

The following principles should be used in determining route location and design alternatives for the area under study.

- (a) Satisfactory vertical and horizontal alignment is easily attained in river valleys and large mountain canyons. However, numerous stream crossings, expensive drainage and protective structures that may be needed to avert floods and washouts and environmental impacts could be a disadvantage.
- (b) Locations on ridges and divides require steeper grades and more horizontal curvature than valley routes, but require fewer drainage and protective structures.
- (c) Locations along mountainsides or hillsides offer numerous advantages. The gradient may be chosen to fit the topography as well as the distance requirements and elevation differences between fixed controls. On upper sidehills, snow and earth slide hazard will be low, and few bridges, drainage, and protective structures will be needed. A southern exposure will minimize pavement icing and reduce snow removal.
- (d) Locations in level to moderately rolling terrain usually permit the highest standards of location and

design; land use and right-of-way cost, rather than topography, will influence route selection.

- (e) In highly developed regions, all but the major topographical obstacles will usually have to be disregarded; land use, right-of-way cost, and other route corridors will be the major considerations in route/design selection.

### **(6) Elimination of Alternatives**

Elimination may proceed by successive reduction of the study area, refinement of the alternative requirements, and selection of the more representative alternatives.

Alternatives can be reduced to manageable proportions by first eliminating unreasonable ones that fall into any one of three areas:

- (a) Alternatives that fall outside of the study area are eliminated on the basis of the study requirements. Support elimination of these alternatives with a map or statement describing the study area, and a statement of the study requirements including the project termini, travel desires, type and level of service, transportation function, type and importance of location controls, and any other pertinent considerations.
- (b) Alternatives which are so alike that the cost of individual study would exceed the benefit to be derived from individual considerations. Present one alternative from each such group and document that similar alternatives have been considered and eliminated.
- (c) Alternatives so environmentally sensitive that further study is not recommended.

### **(7) Environmental Screening**

Environmental screening is used to provide environmental impact information as a basis for eliminating alternatives from further study or to provide environmental information for public involvement. Environmental screening can be an informal process performed by various environmental disciplines. (See Chapter 220.)

The information is intended to help the district or division obtain timely environmental information without an unnecessary amount of wasted effort. The district or division needs to inform the appropriate environmental expertise that they are requesting environmental screening information. If the project requires a discipline report this will be requested at a later date during preparation of the appropriate environmental document.

Examples of the conditions that would make environmental screening desirable:

- When environmental impact information is needed for a legislative study or preliminary study that is required prior to the start of the environmental process.

- When environmental impact information is needed for public involvement prior to selecting the alternatives for further study.

### **(8) Cost and Quantity Determinations**

(a) **Cost Estimates.** Quantity determinations form the basis for comparison of cost estimates made for each route being considered in the study. Cost estimates may be based on the format identified in the *Plans Preparation Manual*.

Base estimates on information from maps, quantities determined for recent similar roadways, field surveys, previous estimates, and reports from other departments.

(b) **Road User Benefit Analysis.** A road user benefit analysis may be made to compare the annual road user costs and the annual costs of improvement, maintenance, and operation of each alternative over a given period of time. It may be prepared following procedures in *A Manual on User Benefit Analysis of Highways and Bus-Transit Improvements* (AASHTO).

### **(9) Preliminary Route/Design Study Report**

The Study Report is prepared from information developed above for the evaluation of the design and economic feasibility of the route or routes studied.

The support material for the report substantiates and explains the route planning and design decisions.

The reports are prepared in 8 ½ by 11 inch format and six copies will be submitted to the headquarters Project Development Office for review. Submit seven copies if FHWA approval is required.

Content should include the following as appropriate:

- **Vicinity Map.**
- **Table of Contents.**
- **Summary.** A general description of the project area and a general assessment of the feasibility of alternatives studied.
- **Topographic Map.** A map showing topographic data pertinent to the project and alternatives under study. See 310.03(3).
- **Description of Alternates Studied.** Describe the general location and terrain for each alternative. See 310.03(5) and (6).
- **Existing Roads, Railroads, Bridges etc.** Show existing facilities, as appropriate.
- **Traffic Data.** See 310.03(4).
- **Right of Way.** Describe the property affected, the nature of impacts, and any other right of way problems.
- **Construction.** Identify unique problems created by excessive borrow or waste.
- **Environmental Consequences.** See 310.03(7).
- **Cost Estimates.** See 310.03(8).

## LEGISLATIVE STUDY COST ESTIMATE

Legislative Reference \_\_\_\_\_ Estimate Date \_\_\_\_\_

Title \_\_\_\_\_

SR No. \_\_\_\_\_ District \_\_\_\_\_ Prepared By \_\_\_\_\_

1.	Origin and Destination Study	\$ _____
2.	Traffic Analysis and Evaluation	\$ _____
3.	Benefit/Cost Analysis	\$ _____
4.	Functional Classification and Evaluation	\$ _____
5.	Accident Analysis and Summary	\$ _____
6.	Bridge Condition Survey Evaluation and Analysis	\$ _____
7.	Maintenance Evaluation	\$ _____
8.	Photogrammetric Services	\$ _____
9.	Soils and Geological Surveys and Analyses	\$ _____
10.	Environmental Impact Evaluation	\$ _____
11.	State Interest and Economic Evaluation	\$ _____
12.	Social Impact Evaluation	\$ _____
13.	Priority and Funding Evaluation	\$ _____
14.	Consultant Services	\$ _____
15.	Engineering Data and Cost Estimates	\$ _____
16.	District Evaluation and Narrative	\$ _____
17.	Field Review	\$ _____
18.a.	Other Costs (Specify)	\$ _____
	b. Other Costs	\$ _____
	c. Other Costs	\$ _____
19.	H.Q. Review, Edit, Evaluation, Typing	\$ _____
20.	H.Q. Publishing	\$ _____
	Total Estimated Cost	\$ _____
	Local Participation	\$ _____
	Total State Cost	\$ _____

### LEGISLATIVE STUDY COST ESTIMATE

Figure 310-1

LEGISLATIVE STUDY  
ANATONE TRANSPORTATION STUDY  
ASOTIN COUNTY  
(Date of Report)

PREPARED FOR  
the  
LEGISLATIVE TRANSPORTATION COMMITTEE  
at the direction of the  
19\_\_ LEGISLATURE

WASHINGTON STATE TRANSPORTATION COMMISSION  
DEPARTMENT OF TRANSPORTATION

(Information shown must be included on all covers; style and format may be altered)

**LEGISLATIVE STUDY REPORT COVER**

Figure 310-2

LEGISLATIVE STUDY  
ANATONE TRANSPORTATION STUDY  
ASOTIN COUNTY  
(Date of Report)

WASHINGTON STATE TRANSPORTATION COMMISSION

Pat Wanamaker  
Chairman

Bernice Stern

Albert D. Rosellini

Vaughn Hubbard

Jerry Overton

Richard Odabashian

Leo B. Sweeney

Commissioners

DEPARTMENT OF TRANSPORTATION

Duane Berentson  
Secretary

(All information shown must be included; style and format may be altered)

**LEGISLATIVE STUDY REPORT TITLE PAGE**

Figure 310-3

- 315.01 General
- 315.02 References
- 315.03 Definitions
- 315.04 Procedure
- 315.05 Documentation

### 315.01 General

Value Engineering is a systematic process designed to focus on the major issues of a complex project or process. It uses a multidisciplinary team to develop recommendations for the important decisions that must be made. The primary objective of a Value Engineering study is *Value Improvement*.

For projects, the value improvements might be improvements in scope definition, functional design, constructibility, coordination (both internal and external), or the schedule for project development. Other possible value improvements are reduced environmental impact, reduced public (traffic) inconvenience, or reduced project cost. The Value Engineering process incorporates, to the extent possible, the values of the design engineer, construction engineer, maintenance engineer, contractor, state and federal approval agencies, local agencies, other stakeholders, and the public. Important design decisions are formulated from the recommendations of the Value Engineering team.

### 315.02 References

CFR 23 Part 627 Value Engineering

*Value Engineering for Highways*, Study Workbook, U. S. Department of Transportation, FHWA

*Introduction To Value Engineering Principles and Practices*, Transportation Partnership in Engineering Education Development (TRANSPPEED), University of Washington.

### 315.03 Definitions

**Value Engineering (VE)** A systematic application of recognized techniques by a multidisciplinary team to identify the function of a product or service, establish a worth for that

function, generate alternatives through the use of creative thinking, and provide the needed functions to accomplish the original purpose; thus assuring the lowest life cycle cost without sacrificing safety, necessary quality, or environmental attributes. Value Engineering is sometimes referred to as Value Analysis (VA) or Value Management (VM).

**Project** The portion of a transportation facility that WSDOT proposes to construct, reconstruct, or improve as described in the *State Highway System Plan* or applicable environmental documents. A project may consist of several contracts or phases over several years that are studied together as one *project*.

### 315.04 Procedure

The VE process uses the Eight-Phase Job Plan in Figure 315-1. Only the phases 1 and 7 are discussed in this chapter. A detailed discussion of phases 2 through 6 is in the VE training manual entitled *Introduction To Value Engineering Principles and Practices*.

#### (1) Selection Phase

##### (a) Project Selection

Projects for VE studies may be selected from any of the categories identified in the Highway Construction Program including, *Preservation* or *Improvement* projects, depending on the size and/or complexity of the project. In addition to the cost, other issues adding to the complexity of the project design are considered in the selection process. These complexities include: critical constraints, difficult technical issues, expensive solutions, external influences, and complicated functional requirements.

A VE study is required for any federally funded NHS project with an estimated cost of \$25 million or more (CFR 23 Part 627). Other types of projects that usually provide the highest potential for value improvement have a preliminary estimate exceeding \$2 million and include one or more of the following:



- Projects with alternative solutions that vary the scope and cost
- New alignment or bypass sections
- Capacity improvements that widen an existing highway
- Major structures
- Interchanges on multilane facilities
- Projects with extensive or expensive environmental or geotechnical requirements
- Materials that are difficult to acquire or require special efforts
- Inferior materials sources
- Major reconstruction
- Projects requiring major traffic control
- Projects with multiple stages

**(b) Statewide VE Study Plan**

On a biennial basis, the state VE manager coordinates with the region VE coordinators to prepare the two-Year VE Study Plan with specific projects scheduled by quarter. The VE Study Plan is the basis for determining the projected VE program needs including team members, team leaders, and training. The Statewide VE Study Plan is a working document and close coordination is necessary between the Olympia Service Center (OSC) and the regions to keep it current.

The regional VE coordinator:

- Identifies potential projects for VE studies from the Project Summaries and the available planning documents for future work.
- Makes recommendations for the VE study timing
- Presents a list of the identified projects to regional management to prioritize into a regional Two-Year VE Study Plan. (VE studies other than projects are also included in the plan.)

The State Design Engineer:

- Reviews the regional Two-Year VE Study Plan regarding the content and schedule of the plan.

The state VE Manager:

- Incorporates the regional Two-Year VE Study Plans and the OSC Study Plans to create the Statewide VE Study Plan.

**(c) VE Study Timing**

Selecting the project at the appropriate stage of development (the timing of the study) is very important to the success of the VE program. Value can be added by performing a VE study any time during project development; however, the WSDOT VE program identifies three windows of opportunity for performing a VE study.

**1. Problem Definition Stage**

As soon as preliminary engineering information is available and the specific deficiencies or “drivers” are identified, the project scope and preliminary cost are under consideration. This is the best time to consider the various alternatives or design solutions and there is the highest potential that the related recommendations of the VE team can be implemented. At the conclusion of the VE study, the project scope, preliminary cost, and major design decisions can be based on the recommendations.

When conducting a study in the problem definition stage, the VE study focuses on issues affecting project “drivers.” This stage often provides an opportunity for building consensus with stakeholders.

**2. Conceptual Design Stage**

At the conceptual design stage, the project scope and preliminary cost have already been established and the major design decisions have been made. Some PS&E activities might have begun and coordination has been initiated with the various service units that will be involved with the design. At this stage, the established project scope, preliminary cost, and schedule will define the limits of the VE study. There is still opportunity for a VE study to focus on the technical issues for each of the specific design elements.

### **3. 30 % Development Stage**

At the 30% stage, most of the important project decisions have been made and the opportunity to affect the project design is limited. The VE study focuses on constructibility, construction sequencing, staging, traffic control elements, and any significant design issues that have been identified during design development.

#### **(d) Study Preparation**

To initiate a VE study, the project manager submits a Request for Value Engineering Study form (shown in Figure 315-2) to the regional VE coordinator at least one month before the proposed study date.

The regional VE coordinator then works with the state VE Manager to determine the team leader and team members.

The design team prepares a study package that includes project information for each of the team members. A list of potential items is shown in Figure 315-3.

The region provides a facility and the equipment for the study (Figure 315-3).

#### **(e) Team Leader**

The quality of the VE study is dependent on the skills of the VE team leader. This individual guides the team efforts and is responsible for its actions during the study. The best VE team leader is knowledgeable and proficient in transportation design and construction and in the VE study process for transportation projects.

For best results, the team leader should be certified by the Society of American Value (SAVE) as a Certified Value Specialist (CVS) or as a Value Methodology Practitioner (VMP).

Team leadership can be supplied from within the region or from other regions, OSC, consultants, or other qualified leaders outside the department. The state VE Manager coordinates with the regional VE coordinator to select the team leader. A statewide pool of qualified team leaders is maintained by the state VE Manager.

#### **(f) Team Members**

The VE team is usually composed of five to eight persons with diverse backgrounds that are relevant to the specific study. The team members may be selected from the regions, OSC, other state and federal agencies, local agencies, and the private sector.

The team members are selected on the basis of the kinds of expertise needed to address the major functional areas and critical high-cost issues of the study. All team members must be committed to the time required for the study. For best results, the team members have had VE training before participating in a VE study.

#### **(g) VE Study Requirements**

The time required to conduct a VE study varies with the complexity and size of the project, but typically ranges from three to five days.

The VE study Final Report and Workbook include a narrative description of project input information, background and history, constraints and drivers, VE team focus areas, and a discussion of the team speculation, evaluation, and recommendations. All of the team's evaluation documentation (including sketches, calculations, analysis, and rationale for recommendations) is included in the Workbook as part of the Final Report. The number of copies of the Final Report and Workbook is specified by the project manager.

### **(2) Implementation Phase**

The VE team's recommendations are included in the Final Report and Workbook. The project manager reviews and evaluates the recommendations and prepare a VE Decision Document. This document has a specific response for each of the VE team recommendations and a summary statement containing the managers' decisions and schedule for implementation regarding further project development.

The VE Decision Document also includes estimated costs or savings of the recommendations as well as the estimated cost to implement the recommendations. A copy of this document is sent to the state VE Manager so the results can be included in the annual VE report to FHWA.

The VE Decision Document is submitted to the State Design Engineer and a copy becomes a vital element in the design file for the project. Project development then continues based on the decisions developed from the preliminary engineering and the VE study recommendations (barring participation agreements funded by other agencies, utilities, developers, and so forth).

### **315.05 Documentation**

The following documents are to be preserved in the project file.

- Value Engineering Study Final Report and Workbook
- VE Decision Document

*P:DM3*

1. Selection Phase 315.04(1)	Select the right projects, timing, team, and project processes and elements.
2. Investigation Phase	Investigate the background information, technical input reports, field data, function analysis, and team focus and objectives.
3. Speculation Phase	Be creative and brainstorm alternative proposals and solutions.
4. Evaluation Phase	Analyze design alternatives, technical processes, life cycle costs, documentation of logic, and rationale.
5. Development Phase	Develop technical and economic supporting data to prove the feasibility of the desirable concepts. Develop team recommendations. Recommend long term as well as interim solutions.
6. Presentation Phase	Present the recommendations of the VE team in an oral presentation, and in a written report and workbook
7. Implementation Phase 315.04(2)	Evaluate the recommendations. Prepare an implementation plan (VE Decision Document) including the response of the managers and a schedule for accomplishing the decisions based on the recommendations.
8. Audit Phase	Maintain a records system to track the results and accomplishments of the VE program on a statewide basis. Compile appropriate statistical analyses as requested.

Steps 2-6 are performed during the study, see *Introduction To Value Engineering Principles and Practices* for procedure's during these steps.

### Eight-Phase Job Plan for VE Studies

*Figure 315-1*

Project Title:			
SR No.	MP	to	MP
			Length
			Subprogram
PIN			WIN
Assigned Project Engineer			
Proposed Advertising Date			
Estimated Right of Way Costs		Estimated Construction Costs	
Design Speed		Projected ADT	
Route Conditions/Geometry: Adjacent Segments			
Overall Route			
Major Project Elements			
Environmental Issues			
Construction Issues			
Suggested Value Team Composition:			
Architecture		Hydraulics	
Bridge		Landscape Architecture	
Construction		Maintenance	
Design		Planning/Programming	
Environmental		Traffic	
Other _____		Real Estate Services	
Region Contact Person		Date's requested for VE study	

**Request for Value Engineering Study**  
*Figure 315-2*

<b>Project Related Input* (Study Package)</b>	<b>Study Related Facilities and Equipment</b>
Design File	Room w/ large table
Quantities	Phone
Estimates	Photo/Video log access/SRView
R/W Plans	Van for Field Trip **
Soils Reports	Easel(s)
Plan Sheets	Large Tablet Paper (2x2 squares)
Environmental Documents	Colored Marking Pens
X-sections and Profiles	Masking and Clear Adhesive Tape
Land Use Maps	Workbook(s)
Contour Maps	Polaroid Camera
Quadrant Maps	<i>Design Manual</i>
Accident Data	"Green Book"
Traffic Data	Standard Plans
Up to Date Large Scale Aerial Photographs	Standard Specifications
Vicinity Map	M.P. Log
Hydraulics Report	Bridge List
Aerial Photos	WSDOT Phone Book
Existing As-Built Plans	Scales and Straight Edge
	Red Book - Field Tables
	Unit Bid Prices
	Calculators
	Scissors

\* Not all information listed may be available to the team depending on the stage of the project.

\*\* If field trip is not possible, provide video of project.

**VE Study Team Tools**  
*Figure 315-3*

325.01	General
325.02	Terminology
325.03	Design Matrix Procedures
325.04	Selecting a Design Matrix
325.05	Project Type
325.06	Using a Design Matrix

### 325.01 General

This highway *Design Manual* provides guidance for three levels of design for highway projects: the basic, modified, and full design levels. The design matrices in this chapter are used to identify the design level(s) for a project and the associated processes and approval authority for allowing design variances. The matrices address the majority of preservation and improvement projects and focus on those design elements that are of greatest concern in project development.

The design matrices are five tables that are identified by route type. Two of the matrices apply to Interstate highways. The other three matrices apply to preservation and improvement projects on non-Interstate highways.

### 325.02 Terminology

The **National Highway System (NHS)** consists of highways designated as a part of the Interstate System, other urban and rural principal arterials, and highways that provide motor vehicle access between such an arterial and a major port, airport, public transportation facility, or other intermodal transportation facility. The NHS includes a highway network that is important to the United States strategic defense policy and provides defense access, continuity, and emergency capabilities for the movement of personnel, materials, and equipment during times of war and peace. It also includes major network connectors that provide motor vehicle access between major military installations and other highways that are part of the strategic highway network.

The **Preventive Maintenance** mentioned under project type on Interstate Design Matrices 1 and 2 includes roadway work such as pavement patching; restoration of drainage system; panel

replacement; joint and shoulder repair; and bridge work such as crack sealing, joint repair, seismic retrofit, scour countermeasures and painting. Preventive maintenance projects must not degrade any existing safety or geometric aspects of the facility.

In Design Matrices 1 and 2 and in Figure 330-1, the term **New/Reconstruction** includes the following types of work:

- Capacity changes: add a through lane, convert a general purpose (GP) lane to a special purpose lane (such as an HOV lane), or convert an HOV lane to GP.
- Other lane changes: add or eliminate a collector-distributor or auxiliary lane. (A rural truck climbing lane that, for its entire length, meets the warrants in Chapter 1010 is not considered new/reconstruction.)
- Pavement reconstruction: full depth PCC or AC pavement replacement.
- New interchange
- Changes in interchange type such as diamond to directional
- New or replacement bridge (main line)

The **HAL, HAC, PAL, and Risk location** mentioned in the notes on Design Matrices 3, 4, and 5 are high accident locations (HAL), high accident corridors (HAC), pedestrian accident locations (PAL), and locations that have a high probability of run-off-the-road accidents based on existing geometrics (Risk).

The **Non-Interstate Freeway** mentioned on Design Matrices 3, 4, and 5 is multilane, divided highway with full access control.

The **Master Plan for Access Control** mentioned in the notes on Design Matrices 3, 4, and 5 is available from the Olympia Service Center, Design Office, Access and Hearings Unit.

The **corridor or project analysis** mentioned in notes 2 and 4 (on Design Matrices 3, 4, and 5) is the justification needed to support a change

in design level from the indicated level. The analysis can be based on route continuity, and other existing features, as well as the recommendations for future improvements in an approved Route Development Plan.

### **(1) Project Types**

**Diamond Grinding** is grinding a concrete pavement to remove surface wear or joint faulting.

**Milling with AC Inlays** is removal of a specified thickness of asphalt surfacing, typically from the traveled lanes, and then overlaying with asphalt concrete at the same specified thickness.

**Nonstructural Overlay** is an asphalt concrete pavement overlay that is placed to minimize the aging effects and minor surface irregularities of the existing asphalt concrete pavement structure. The existing pavement structure is not showing extensive signs of fatigue (longitudinal or alligator cracking in the wheel paths). Nonstructural overlays are typically less than 0.13 ft thick.

**AC Structural Overlay** is an asphalt concrete pavement overlay that is placed to increase the load carrying ability of the pavement structure. Structural overlay thickness is greater than or equal to 0.13 ft.

**PCC Overlay** is a Portland cement concrete pavement overlay of an existing PCC or AC pavement.

**Dowel Bar Retrofit** is re-establishing the load transfer efficiencies of the existing concrete joints and transverse cracks by the cutting of slots, placement of epoxy coated dowel bars, and placement of high-early strength, non-shrink concrete.

**Bridge Deck Rehabilitation** is repair of any delaminated concrete bridge deck and adding a protective overlay that will prevent further corrosion of the reinforcing steel.

**Safety, All Others** includes collision reduction, collision prevention, channelization, and signalization projects.

**Safety, At Grade** is a project on a multilane highway to build grade separation facilities that replace the existing intersection.

**Bridge Restriction** projects are listed under economic development because these bridges do not have any structural problems. However, if the vertical or load capacity restrictions are removed, then it will benefit the movement of commerce.

### **(2) Design Elements**

The following elements are shown on the Design Matrices. If the full design level applies, see the chapters listed below. If basic design level applies, see Chapter 410. If the modified design level applies, see Chapter 430.

**Horizontal Alignment** is the horizontal attributes of the roadway including horizontal curvature, superelevation, and stopping sight distance; all based on design speed. (See Chapter 620 for horizontal alignment, Chapter 640 for superelevation, Chapter 650 for stopping sight distance, and Chapter 440 for design speed.)

**Vertical Alignment** is the vertical attributes of the roadway including vertical curvature, profile grades, and stopping sight distance; all based on design speed. (See Chapter 630 for vertical alignment, Chapters 440 and 630 for grades, Chapter 650 for stopping sight distance, and Chapter 440 for design speed.)

**Lane Width** is the distance between lane lines. (See Chapter 640.)

**Shoulder Width** is the distance between the outside or inside edge line and the edge of in-slope, or face of barrier. (See Chapter 640.)

**Lane and Shoulder Taper** (pavement transitions) are the rate and length of transition of changes in width of roadway surface. (See Chapters 440 and 620.)

**Median Width** is the distance between inside edge lines. (See Chapters 440 and 640.)

**Cross Slope, Lane** is the rate of elevation change across a lane. This element includes the algebraic difference in cross slope between adjacent lanes. (See Chapter 640.)

**Cross Slope, Shoulder** is the rate of elevation change across a shoulder. (See Chapter 640.)

**On/Off Connection** is the widened portion of the main line beyond the ramp terminal. (See Chapter 940.)



**Fill/Ditch Slope** is downward slope from edge of shoulder to bottom of ditch or catch. (See Chapter 640.)

**Access** is means of entering or leaving a public street or highway from an abutting private property or another public street or highway. (See Chapter 1420.)

**Clear Zone** is the total roadside border area, starting at the edge of the traveled way, available for use by errant vehicles. This area may consist of a shoulder, a recoverable slope, a nonrecoverable slope, and/or a clear run-out area. (See Chapter 700.)

**Signing, Delineation, Illumination** are signs, guide posts, pavement markings, and lighting. (See Chapter 820 for signing, Chapter 830 for delineation, and Chapter 840 for illumination.)

**Basic Safety** is the safety items listed in Chapter 410.

**Bridge Lane Width** is the distance between lane lines on a structure. (See Chapters 440, 640 and 1120.)

**Bridge Shoulder Width** is the distance between outside or inside edge line and face of curb or barrier, whichever is less. (See Chapters 440, 640 and 1120.)

**Bridge Vertical Clearance** is the minimum height between the roadway including shoulder and an overhead obstruction. (See Chapter 1120.)

**Bridge Structural Capacity** is the load bearing ability of a structure. (See Chapters 440 and 1120.)

**Intersections Turning Radii** See Chapter 910 for definition.

**Intersections Angle** See Chapter 910 for definition.

**Intersections Sight Distance** See Chapter 910 for definition.

**Barriers Terminals and Transitions Section** — **Terminals** are crashworthy end treatment for longitudinal barriers that is designed to reduce the potential for spearing, vaulting, rolling, or

excessive deceleration of impacting vehicles from either direction of travel. Impact attenuators are considered terminals and beam guardrail terminals include anchorage. — **Transitions** are sections of barriers used to produce a gradual stiffening of a flexible or semi-rigid barrier as it connects to a more rigid barrier or fixed objects. (See Chapter 710 and 720.)

**Barriers Standard Run** are guardrail and other barriers excluding terminals, transitions, attenuators, and bridge rails. (See Chapter 710.)

**Barriers Bridge Rail** is barrier on a bridge excluding transitions. (See Chapter 710.)

### 325.03 Design Matrix Procedures

When scoping, or designing a project, the following steps are used to select and apply the design matrix. Each step is further explained in this chapter.

- *Select a design matrix* by identifying the route: Interstate, NHS, or non-NHS
- Within the design matrix: for Matrices 1 and 2 *select the row* by the type of work and for Matrices 3, 4 and 5 *select the row* by identifying the project type
- *Use the design matrix* to determine the design level for the design elements of the project. Apply the appropriate design levels and document the design decisions as required by this chapter and Chapter 330.

### 325.04 Selecting a Design Matrix

Selection of a design matrix is based on highway system (Interstate, non-NHS and other NHS) and location (main line, interchange). (See Figure 325-1.) Figures 325-2a and 2b provide a list of NHS highways in the state of Washington. The design matrices are shown in Figures 325-4 through 325-8. Follow *Design Manual* guidance for all projects except as noted in the design matrices and elsewhere as applicable.

Route	Project	
	Main Line	Interchange Area
Interstate	Matrix 1	Matrix 2
NHS	Matrix 3	Matrix 4
Non-NHS	Matrix 5	Matrix 4

### Design Matrix Selection Guide

Figure 325-1

#### 325.05 Project Type

In the design matrices, row selection is based on project type or type of work. The Project Summary defines and describes the project. (Project Summary is discussed in Chapter 330.) For non-NHS and NHS routes, the project's program/subprogram might be sufficient information for identifying project type.

For project types not listed in the design matrices, consult the OSC Design Office for guidance.

See Figures 325-3a through 3c for program and subprogram titles and definitions. The various sources of funds for these subprograms carry eligibility requirements that the designers and program managers must identify and monitor throughout project development — especially if the type of work changes — to ensure accuracy when writing agreements and to avoid delaying advertisement for bids.

Some projects involve work from several subprograms. In such cases, identify the various limits of the project that apply to each subprogram. Where the project limits overlap, apply the higher design level to the overlapping portion.

#### 325.06 Using a Design Matrix

The column headings on a design matrix are **design elements**. They are based on the following thirteen FHWA controlling design criteria: design speed, lane width, shoulder width, bridge width, structural capacity, horizontal alignment, vertical alignment, grade, stopping sight distance, cross slope, superelevation, vertical clearance,

and horizontal clearance. For the column headings, some of these controlling criteria have been combined (for example, design speed is part of horizontal and vertical alignment).

For Improvement type projects, full design level applies to all design elements except as noted in design matrices and in *Design Manual* chapters as applicable.

A **blank cell** on a design matrix signifies that the design element will not be addressed because it is beyond the scope of the project.

#### (1) Design Levels

In the Interstate matrices, full design level applies unless otherwise noted.

In the non-Interstate matrices, design levels are noted in the cells by B, M, F, and a number corresponding to a footnote on the matrix.

The design levels of basic, modified, and full (B, M, and F) were used to develop the design matrices. Each design level is based on the investment intended for the route type and type of work. (For example, the investment is higher for Interstate reconstruction than for an overlay on a non-NHS route.)

**Basic design level (B)** preserves pavement structures, extends pavement service life, and maintains safe operations of the highway. See Chapter 410.

**Modified design level (M)** preserves and improves existing roadway geometrics, safety, and operational elements. See Chapter 430.

**Full design level (F)** improves roadway geometrics, safety, and operational elements. See Chapter 440 and other applicable *Design Manual* chapters for design guidance.

#### (2) Design Variances

Types of design variances are design exceptions (DE), evaluate upgrades (EU), and deviations.

**Design exception (DE)** in a matrix cell indicates an existing condition that is not standard, relative to the current design level. The condition will not be corrected unless a need has been identified in the Highway System Plan and prioritized in accordance with the programming

process. A design exception must be identified in the project documents but no further justification is required.

**Evaluate upgrade (EU)** in a matrix cell indicates that analysis of an existing nonstandard condition is required to determine the impacts and cost effectiveness of upgrading to the standards of the applicable design level. The analysis and justification must be provided in the project documentation.

A **deviation** is required when an existing or proposed design element does not meet or exceed the applicable design level for the project and neither DE nor EU processing is indicated. Documentation of a deviation must contain justification and it must be approved at the appropriate approval level. See the Design Approval Level table in Chapter 330. Justification for a deviation must be supported by at least two of the following:

- Accident history or potential
- Benefit/cost analysis
- Engineering judgment
- Environmental issues
- Route continuity

*P65:DP/DMM*

State Route	NHS Route Designation	Beginning SR MP	Begin ARM	Ending SR MP	End ARM
US 2	I-5 to Idaho State Line	0.00	0.00	334.51	326.64
US 2 Couplet	Everett Couplet	0.00	0.00	1.64	0.87
US 2 Couplet	Brown Street Couplet	287.45	0.00	288.08	0.63
US 2 Couplet	Division Street Couplet	289.19	0.00	290.72	1.53
SR 3	SR 101 to SR 104	0.00	0.00	60.02	59.81
SR 4	SR 101 to I-5	0.00	0.00	62.28	62.27
I-5	Oregon State Line to Canadian Border	0.00	0.00	276.56	276.62
SR 8	SR 12 to SR 101	0.00	0.00	20.67	20.67
SR 9	SR 539 to Canadian Border	93.61	93.52	98.17	98.08
SR 9 Spur	Sumas Spur	98.00	0.00	98.25	0.24
SR 11	I-5 to Alaskan Ferry Terminal	19.93	19.93	21.28	21.28
US 12	SR 101 to Idaho State Line	0.00	0.00	434.19	430.76
US 12 Couplet	Aberdeen Couplet	0.33	0.00	0.68	0.35
SR 14	I-5 to SR 97	0.00	0.00	101.02	100.93
SR 14 Spur	Maryhill Spur	100.66	0.00	101.05	0.39
SR 16	I-5 to SR 3	0.00	0.00	29.19	27.01
SR 16 Spur	SR 16 to SR 3	28.74	0.00	29.13	0.39
SR 17	SR 395 to I-90	7.43	0.00	50.89	43.40
SR 18	So. Federal Way Park & Ride to I-5	2.20B	0.00	0.00	0.53
SR 18	I-5 to I-90	0.00	0.53	27.91	28.41
SR 20	SR 101 to I-5	0.00	0.00	59.54	59.49
SR 20 Spur	SR 20 to San Juan Ferry	47.89	0.00	55.67	7.78
SR 22	SR 97 to I-82	0.70	0.00	4.00	3.31
SR 26	I-90 to US 195	0.00	0.00	133.53	133.61
SR 26 Spur	SR 26 to US 195	133.44	0.00	133.51	0.07
SR 28	SR 2 to SR 281	0.00B	0.00	29.77	33.91
I-82	I-90 to Oregon State Line	0.00	0.00	132.60	132.57
I-90	I-5 to Idaho State Line	1.94	0.00	299.82	297.52
I-90 Reverse Lane	Reversible lane	1.99	0.00	9.44	7.45
SR 96	McCullum Park and Ride to I-5	0.00	0.00	0.52	0.52
US 97	Oregon State Line to SR 22	0.00B	0.00	61.44	61.30
US 97	I-90 to Canadian Border	133.90	118.80	336.48	321.62
US 97 Couplet	Maryhill Couplet	2.59	0.00	2.68	0.09
US 97 Spur	SR 97 to SR 2 (Orondo)	213.36	0.00	213.62	0.26
US 97 Y	SR 970 to SR 97				
SR 99	188th to SeaTac Airport	18.35	14.70	18.77	15.12
SR 99	SR 509 to SR 104	26.04	22.40	43.60	39.84
US 101	Oregon State Line to SR 401	0.00	0.00	0.46	0.46
US 101	SR 4 to I-5	28.89	28.89	367.41	365.78
US 101 Couplet	Aberdeen Couplet	87.49	0.00	91.66	4.17
US 101 Couplet	Port Angeles Couplet	249.65	0.00	251.32	1.67
SR 104	SR 101 to I-5	0.20	0.00	29.67	29.14
SR 109	Pacific Beach Access	0.00	0.00	30.25	30.29
SR 125	Oregon State Line to SR 12	0.00	0.00	6.09	6.08
SR 125 Spur	SR 125 to SR 12	6.09	0.00	6.76	0.67
SR 127	SR 12 to SR 26	0.03	0.00	27.05	27.05
SR 128	SR 12 to Idaho State Line	0.00	0.00	2.30	2.30
This list provided by the OSC Planning Office					

**NHS Highways in Washington**  
*Figure 325-2a*

State Route	NHS Route Designation	Beginning SR MP	Begin ARM	Ending SR MP	End ARM
SR 166	Naval Fuel Depot	0.02	0.00	3.40	3.38
SR 167	I-5 to I-405	0.00	0.00	27.28	28.60
I-182	I-82 to US 395	0.00	0.00	15.19	15.19
US 195	Idaho State Line to I-90	0.00B	0.00	95.99	93.37
US 195 Spur	US 195 to Idaho State Line	0.06	0.00	0.60	0.54
I-205	Oregon State Line to I-5	26.59	0.00	37.16	10.57
SR 240	Hanford Access	30.63	28.86	34.87	33.10
SR 270	SR 195 to Idaho	0.00	0.00	9.89	9.89
SR 270	Pullman Couplet	2.67	0.00	2.90	0.23
SR 270	SR 195 Y Connection	0.00	0.00	0.38	0.38
SR 281	SR 28 to I-90	0.00	0.00	10.55	10.55
SR 281 Spur	SR 281 to I-90	2.65	0.00	4.34	1.69
SR 303	SR 3 to SR 304	0.00B	0.00	8.73	8.89
SR 304	SR 16 to Bremerton Ferry	0.00	0.00	3.51	3.24
SR 305	SR 3 to Winslow Ferry	0.02	0.00	13.52	13.50
SR 307	SR 305 to SR 104	0.00	0.00	5.25	5.25
SR 310	SR 3 to SR 304	0.00	0.00	1.84	1.84
US 395	Congressional High Priority Route	13.05	13.05	270.26	275.09
SR 401	SR 101 to SR 4	0.00	0.00	12.13	12.13
I-405	I-5 to I-5	0.00	0.00	30.32	30.30
SR 432	SR 4 to I-5	0.00	0.00	10.33	10.32
SR 433	Oregon State Line to SR 432	0.00	0.00	0.94	0.94
SR 500	I-5 to SR 503	0.00	0.00	5.96	5.96
SR 501	I-5 to Port of Vancouver	0.00	0.00	3.83	3.42
SR 502	I-5 to SR 503	0.00B	0.00	7.56	7.58
SR 503	SR 500 to SR 502	0.00	0.00	8.09	8.09
SR 509	SR 99 to 12th Place S	24.35B	26.13	29.83	33.11
SR 509	Pacific Ave. to Marine View Drive	0.22	1.44	3.20	4.42
SR 512	I-5 to SR 167	0.00	0.00	12.06	12.06
SR 513	Sandpoint Naval Air Station	0.00	0.00	3.35	3.35
SR 516	I-5 to SR 167	2.03	2.02	4.72	4.99
SR 518	I-5 to SR 509	0.00	0.00	3.81	3.42
SR 519	I-5 to Seattle Ferry Terminal	0.00	0.00	1.14	1.14
SR 520	I-5 to SR 202	0.00	0.00	12.83	12.82
SR 522	I-5 to SR 2	0.00	0.00	24.68	24.68
SR 524	Lynnwood Park and Ride to I-5	4.64	4.76	5.20	5.32
SR 524 Spur	Cedar Way Spur - Lynnwood Park and Ride to I-5	4.64	0.00	5.14	0.50
SR 525	I-5 to SR 20	0.00	0.00	30.49	30.72
SR 526	SR 525 to I-5	0.00	0.00	4.52	4.52
SR 529	Everett Homeport	0.00	0.00	2.20	2.20
SR 539	I-5 to Canadian Border	0.00	0.00	15.16	15.16
SR 543	I-5 to Canadian Border	0.00	0.00	1.09	1.09
SR 546	SR 539 to Canadian Border	0.00	0.00	8.02	8.02
I-705	I-5 to Schuster Parkway	0.00	0.00	1.50	1.50
SR 970	I-90 to SR 97	0.00	0.00	10.31	10.31
SR 970 Y	Y connection to US 97	0.00	0.00	0.10	0.10
This list provided by the OSC Planning Office					

**NHS Highways in Washington (continued)**

*Figure 325-2b*

# Highway Capital Preservation Program

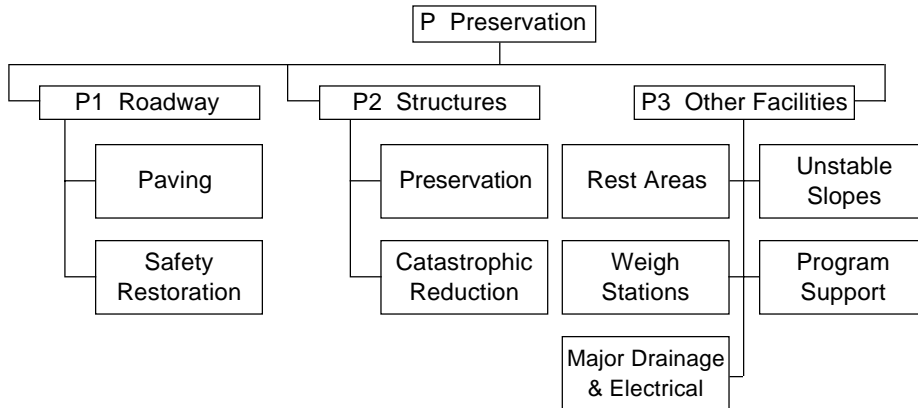

**P Preservation** — Preserve the highway infrastructure cost effectively to protect the public investment.

## **P1 Roadway**

1. Repave highways at regular intervals to minimize long-term costs.
2. Restore existing safety features.

## **P2 Structures**

1. Rehabilitate or replace existing bridges and other structures to preserve operational and structural integrity.
2. Reduce the risk of naturally caused catastrophic bridge failures.

## **P3 Other Facilities**

1. Refurbish rest areas to extend service life and improve safety.
2. Construct weigh facilities to ensure enforcement across the entire highway system.
3. Refurbish electrical systems, electronics, and mechanical systems to extend service life and improve safety. Rehabilitate or replace existing major drainage features to preserve operational and structural integrity.
4. Stabilize known unstable slopes.
5. The program support subcategory consists of critical construction support items that are required to maintain efficiency and ensure continued progress of the construction programs.

Paraphrased excerpt from the *State Highway System Plan*, State Highway System Plan Service Objectives and Action Strategies.

**Preservation Program**  
*Figure 325-3a*

# Highway Capital Improvement Program

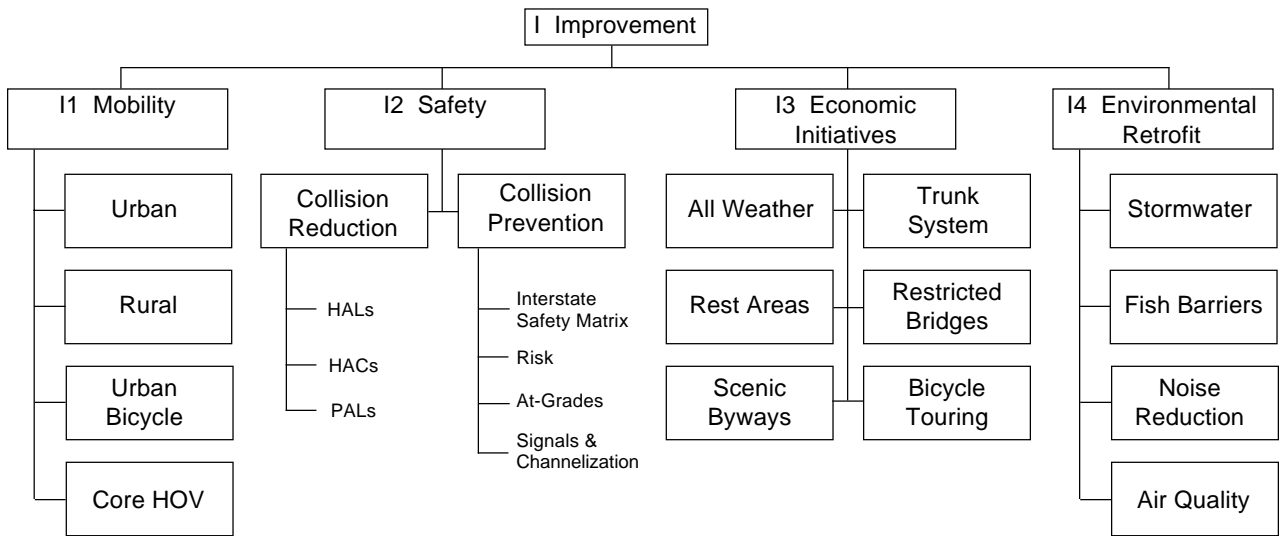

## I Improvement

### I1 Mobility — Improve mobility within congested highway corridors.

1. Mitigate congestion on urban highways in cooperation with local and regional jurisdictions when the peak period level of service falls below Level of Service D.
2. Provide uncongested condition (Level of Service C) on rural highways.
3. Provide bicycle connections along or across state highways within urban growth areas to complete local bicycle networks.
4. Complete the Freeway Core HOV Lane System in the Puget Sound region.
5. Provide uncongested conditions (Level of Service C) on high occupying vehicle (HOV) lanes.

### I2 Safety — Provide the safest possible highways within available resources.

1. Improve highway sections that have a high accident history.
2. Improve geometrics of the Interstate System per the Federal Highway Administration (FHWA)/WSDOT Stewardship Agreement.
3. Improve roadways where geometrics, traffic volumes, and speed limits indicate a high accident potential.
4. Eliminate major at-grade intersections on multilane highways with speed limits of 45 mph or higher.
5. Construct intersection channelization, signals, or both when traffic volume warrants (thresholds) are met.

Paraphrased excerpt from the *State Highway System Plan*, State Highway System Plan Service Objectives and Action Strategies.

## Improvement Program

Figure 325-3b

- I3 Economic Initiatives** — Support efficient and reliable freight movement on state highways. Support tourism development and other Washington industries.
1. Upgrade state highways on the Freight and Goods Transportation System (FGTS) to have an all-weather surface capable of supporting legal loads year-round
  2. Provide four-lane limited access facilities on a trunk system consisting of all FGTS highways with a T-1 classification (truck travel exceeding 10,000,000 tons per year).
  3. Ensure public access to appropriately sized, rest room equipped facilities every 60 miles on the NHS and Scenic & Recreational (S & R) highways.
  4. Where cost effective, replace or modify structures on the Interstate System with restricted vertical clearance.
  5. Where cost effective, replace or modify structures that cannot carry legal overloads.
  6. Cooperatively promote and interpret the heritage resources along S & R highways, including providing incentives for alternatives to outdoor advertising.
  7. On rural bicycle touring routes, provide a minimum of 4 ft shoulders (structures are not included).
- I4 Environmental Retrofit** — Retrofit state highway facilities as appropriate to reduce existing environmental impacts.
1. Reconstruct storm water discharge facilities as opportunities arise.
  2. Remove identified fish passage barriers.
  3. Reduce the public's exposure to noise from state highway facilities where local land use authorities have adopted development regulations which reduce future exposure to excessive noise levels near highway facilities.
  4. Implement the WSDOT Transportation Control Measures required by the Statewide Implementation Plan for Air Quality.

Paraphrased excerpt from the *State Highway System Plan*, State Highway System Plan Service Objectives and Action Strategies

**Improvement Program (continued)**  
*Figure 325-3c*



# DESIGN MATRIX 1

## Interstate Routes (Main Line)

### Figure 325-4

↓ Project Type															Bridges			Barriers			
Design Elements →	Horiz. Align.	Vert. Align.	Lane Width	Shldr Width (13)	On/Off Conn't.	Median Width	Cross Slope Lane	Cross Slope Shldr	Fill/Ditch Slopes	Clear Zone	Sign. (10)	Delini. (9)	Illumin.	Vert. Clear. (11)	Lane Width	Shldr Width	Structural Capacity	Term. & Trans. Section (12)	Std Run	Bridge Rail (14)	
<b>(1-1) Preventive Maintenance</b>																					
<b>Pavement Restoration</b>																					
(1-2) Diamond Grinding										EU	EU	F		DE				F	EU	F	
(1-3) Milling with ACP Inlays									EU	F	EU	F		DE				F	EU	F	
(1-4) Nonstructural Overlay				DE			EU	EU	EU	F	EU	F		EU				F	F	F	
<b>Pavement Rehab./Resurf.</b>																					
(1-5) ACP Structural Overlays	EU	DE	F	F	F	DE	F	EU	F	F	EU	F	F	F	F	DE		F	F	F	
(1-6) PCCP Overlays	EU	DE	F	F	F	DE	F	EU	F	F	EU	F	F	F	F	DE		F	F	F	
(1-7) Dowel Bar Retrofit	EU	DE	F	F	F	DE	DE		F	F	EU	F	F	DE		DE		F	F	F	
<b>Bridge Rehabilitation</b>																					
(1-8) Bridge Deck Rehabilitation												F		F	F	DE	(11)	F (6)		F	
<b>Reconstruction (16)</b>																					
(1-9) New/Reconstruction	F	F	F	F	F	F	F	F	F	F	F	F	F	F	F	F	F	F	F	F	

- Not Applicable
- F** Full design level
- M** Modified design level. See Chapter 430.
- DE** Design Exception to full design level.
- EU** Evaluate Upgrade to full design level.

- (6) Applies only to bridge end terminals and transition sections.
- (9) Continuous shoulder rumble strips required in rural areas. See Chapter 700.
- (10) See Chapter 820.
- (11) See Chapter 1120.
- (12) Impact attenuators are considered as terminals.
- (13) See Chapter 440 and 640.
- (14) Includes crossroad bridge rail.
- (16) For design elements not in the matrix headings, apply full design level as found in the applicable *Design Manual* chapters.

# DESIGN MATRIX 2

## Interstate Interchange Areas

Figure 325-5

↓ Project Type	Ramps and Collector Distributors														Cross Road																	
																												Ramp Terminals			Barriers	
	Design Elements →	Horiz. Align.	Vert. Align.	Lane Width	Shldr Width	Lane & Shldr. Taper	On/Off Conn't.	Cross Slope Lane	Cross Slope Shldr	Fill/ Ditch Slopes	Limited Access	Clear Zone	Vertical Clear. (11)	Sign., Del., Illumin.	Turn Radii	Angle	I/S Sight Dist.	Term. & Trans. Section (12)	Std Run	Bridge Rail	Lane Width	Shldr Width	Vert. Clear.	Ped. & Bike	Limited Access	Fill/ Ditch Slopes	Clear Zone	Sign., Del., Illumin.	Term. & Trans. Section (12)	Std. Run	Bridge Rail	
<b>(2-1) Preventive Maintenance</b>																																
<b>Pavement Restoration</b>																																
(2-2) Diamond Grinding											EU		F (15)				F	EU	F								EU	F (15)	F	EU	F	
(2-3) Milling with ACP Inlays										EU		F	F	F (15)			F	F	F					EU	F	F (15)	F	F	F			
(2-4) Nonstructural Overlay							EU	EU	EU			F	F	F (15)			F	F	F					EU	F	F (15)	F	F	F			
<b>Pavement Rehab./Resurf.</b>																																
(2-5) ACP Structural Overlays	EU	DE	F	F	F	F	F	EU	F	F	F	F	F (15)	F	F	F	F	F	F	DE	DE	F	DE	F	DE	F	F (15)	F	F	F		
(2-6) PCCP Overlays	EU	DE	F	F	F	F	F	EU	F	F	F	F	F (15)	F	F	F	F	F	F	DE	DE	F	DE	F	DE	F	F (15)	F	F	F		
(2-7) Dowel Bar Retrofit	DE		DE	DE	F	F	DE		F	F	F	DE	F (15)	F	F	F	F	F	F					F			F (15)	F	F	F		
<b>Bridge Rehabilitation</b>																																
(2-8) Bridge Deck Rehabilitation												F					F (6)		F			F						F (6)		F		
<b>Reconstruction (16)</b>																																
(2-9) New/Reconstruction	F	F	F	F	F	F	F	F	F	F	F	F	F	F	F	F	F	F	F	F	F	F	F	F	F	F	F	F	F	F	F	

- Not Applicable
- F** Full design level
- M** Modified design level. See Chapter 430.
- DE** Design Exception to full design level.
- EU** Evaluate Upgrade to full design level.

- (6) Applies only to bridge end terminals and transition sections.
- (10) See Chapter 820.
- (11) See Chapter 1120.
- (12) Impact attenuators are considered as terminals.
- (15) EU for signing and illumination.
- (16) For design elements not in the matrix headings, apply full design level as found in the applicable *Design Manual* chapters.



# DESIGN MATRIX 4

## Non-Interstate Interchange Areas

### Figure 325-7

↓ Project Type	Ramps and Collector Distributors														Cross Road																			
																											Ramp Terminals			Barriers			Barriers	
Design Elements →	Horiz. Align.	Vert. Align.	Lane Width	Shldr Width	Lane & Shldr. Taper	On/Off Conn.	Cross Slope Lane	Cross Slope Shldr	Fill/ Ditch Slopes	Access (3)	Clear Zone	Sign, Del., Illumin.	Basic Safety	Turn Radii	Angle	I/S Sight Dist.	Term. & Trans. Section (12)	Std Run	Bridge Rail	Lane Width	Shldr Width	Vert. Clear.	Ped. & Bike	Access (3)	Sign., Del., Illumin.	Fill/ Ditch Slopes	Clear Zone	Basic Safety	Term. & Trans. Section (12)	Std. Run	Bridge Rail			
<b>Preservation</b>																																		
<b>Roadway</b>																																		
(4-1) Non-Interstate Freeway	DE/F	DE/F	DE/F	DE/F	DE/F	DE/F	DE/F	DE/F	DE/F	DE/F		B	B	DE/F	DE/F	DE/F	<u>B</u>	B	F	DE/F	DE/F	F			B	DE/F		B	<u>B</u>	B	F			
(4-2) ACP/PCCP/BST Overlays												B	B			B	<u>B</u>	B	F			F			B			B	<u>B</u>	B	F			
Ramps																																		
<b>Structures</b>																																		
(4-3) Bridge Replacement	F(2)	F(2)	F(2)	F(2)	F	F(2)	F(2)	F(2)	F(2)	F	F	F		F	F	F	F	F	F	F(2)	F(2)	F	F	F	F	F(2)	F		F	F	F			
(4-4) Bridge Deck Rehab												B	B				<u>B</u> (6)		F			F		B			B	<u>B</u> (6)		F				
<b>Improvements (16)</b>																																		
<b>Mobility</b>																																		
(4-5) Non-Interstate Freeway	F	F	F	F	F	F	F	F	F	F	F	F		F	F	F	F	F	F	F	F	F	F	F	F	F	F		F	F	F			
(4-6) Urban	F(2)	F(2)	F(2)	F(2)	F	F(2)	F(2)	F(2)	F(2)	F	F	F		F(2)	F(2)	F	F	F	F	F(2)	F(2)	F	F	F	F	F(2)	F		F	F	F			
(4-7) Rural	F(2)	F(2)	F(2)	F(2)	F	F(2)	F(2)	F(2)	F(2)	F	F	F		F(2)	F(2)	F	F	F	F	F(2)	F(2)	F	F	F	F	F(2)	F		F	F	F			
(4-8) HOV By Pass	F(2)	F(2)	F(2)	F(2)	F	F(2)	F(2)	F(2)	F(2)	F	F	F		F(2)	F(2)	F	F	F	F	F(2)	F(2)	F	F	F	F	F(2)	F		F	F	F			
(4-9) Bike/Ped. Connectivity	(5)	(5)	(5)	(5)	(5)		(5)	(5)	(5)	(5)	(5)	(5)		(5)	(5)	(5)	(5)	(5)	(5)	(5)	(5)	(5)	(5)	(5)	(5)	(5)		(5)	(5)	(5)				
<b>Safety</b>																																		
(4-10) Non-Interstate Freeway	F	F	F	F	F	F	F	F	F	F	F	F		F	F	F	F	F	F	F	F	F		F	F	F	F		F	F	F			
(4-11) At Grade (1)	F(2)	F(2)	F(2)	F(2)	F	F(2)	F(2)	F(2)	F(2)	F	F	F		F(2)	F(2)	F	F	F	F	F(2)	F(2)	F	F	F	F	F(2)	F		F	F	F			
(4-12) All Others (1)	M(4)	M(4)	M(4)	M(4)	F	M(4)	M(4)	M(4)	M(4)	EU/F	F	F		M(4)	M(4)	F	F	F	F	F(2)	F(2)	F		EU/F	F	M(4)	F		F	F	F			
<b>Economic Development</b>																																		
(4-13) Four-Lane Trunk System	F	F	F	F	F	F	F	F	F	F	F	F		F	F	F	F	F	F	F	F	F		F	F	F	F		F	F	F			

- Not Applicable
- F** Full design level
- M** Modified design level. See Chapter 430.
- B** Basic design level. See Chapter 410.
- DE** Design Exception
- EU** Evaluate Upgrade

- (1) Collision Reduction (HAL, HAC, PAL), or Collision Prevention (Risk, Signalization & Channelization). Specific deficiencies that created the project must be upgraded to design level as stated in matrix.
- (2) Modified design level may apply based on a corridor or project analysis. See 325.02.
- (3) If designated in limited access master plan apply limited access standards, if not access management standards apply. See Chapter 920.
- (4) Full design level may apply based on a corridor or project analysis. See 325.02.
- (5) For bike/pedestrian design see Chapter 1020.
- (6) Applies only to bridge end terminals and transition sections.
- (7) 4 ft minimum shoulders.
- (12) Impact attenuators are considered as terminals.
- (16) For design elements not in the matrix headings, apply full design level as found in the applicable *Design Manual* chapters.

# DESIGN MATRIX 5

## Non-NHS Routes

### Figure 325-8

↓ Project Type														Bridges				Intersections			Barriers		
Design Elements →	Horiz. Align.	Vert. Align.	Lane Width	Shldr Width	Lane & Shldr Taper	Median Width	Cross Slope Lane	Cross Slope Shldr	Fill/Ditch Slopes	Access (3)	Clear Zone	Sign, Del., Illumin.	Basic Safety	Lane Width	Shldr Width	Vertical Clear.	Structural Capacity	Turn Radii	Angle	Sight Dist.	Term. & Trans. Section (12)	Std Run	Bridge Rail
<b>Preservation</b>																							
<b>Roadway</b>																							
(5-1) ACP/PCCP												B	B			F				B	<u>B</u>	B	F
(5-2) BST																							
(5-3) BST Routes/Basic Safety												B	B							B	<u>B</u>	B	F
(5-4) Replace ACP with PCCP at I/S			EU/M	EU/M		EU/M	EU/M					B	B			F					<u>B</u>	B	F
<b>Structures</b>																							
(5-5) Bridge Replacement	M	F	M	M	F		M	M	M		F	F		F (2)	F(2)	F	F(11)	M	M	F	F	F	F
(5-6) Bridge Repl. (Multi-Lane)	F (2)	F (2)	F (2)	F (2)	F	F (2)	F (2)	F (2)	F (2)		F	F		F (2)	F (2)	F	F(11)	F (2)	F (2)	F	F	F	F
(5-7) Bridge Deck Rehab												B	B								<u>B</u> (6)	F	F
<b>Improvements (16)</b>																							
<b>Mobility</b>																							
(5-8) Urban (Multilane)	F (2)	F (2)	F (2)	F (2)	F	F (2)	F (2)	F (2)	F (2)	F	F	F		F (2)	F (2)	F	F (11)	EU/F	EU/F	F	F	F	F
(5-9) Urban	M	M	M	M	F		M	M	M	F	F	F		M	M	F	F (11)	EU/M	EU/M	F	F	F	F
(5-10) Rural	M	M	M	M	F	M	M	M	M	F	F	F		M	M	F	F (11)	EU/M	EU/M	F	F	F	F
(5-11) HOV	M	M	M	M	F	M	M	M	M	F	F	F		M	M	F	F (11)	EU/M	EU/M	F	F	F	F
(5-12) Bike/Ped. Connectivity	(5)	(5)	(5)	(5)	(5)	(5)	(5)	(5)	(5)	(5)	(5)	(5)		(5)	(5)	(5)	(5)	(5)	(5)	5	(5)	(5)	(5)
<b>Safety</b>																							
(5-13) Non-Interstate Freeway	F(2)	F (2)	F (2)	F (2)	F (2)	F (2)	F (2)	F (2)	F (2)	F	F	F		F (2)	F (2)	F		F (2)	F (2)	F	F	F	F
(5-14) All Others (1)	EU/M	EU/M	EU/M	EU/M	EU/F	EU/M	EU/M	EU/M	EU/M	EU/F	F	EU/F		EU/M	EU/M	EU/F		EU/M	EU/M	EU/F	F	F	EU/F
<b>Economic Development</b>																							
(5-15) Freight & Goods(Frost Free)(8)	EU/M	EU/M	EU/M	EU/M	EU/F	EU/M	M	M	EU/M		F	B	B	EU/M	EU/M	F		EU/M	EU/M	EU/F	F	B	F
(5-16) Rest Areas(New)	F	F	F	F	F	F	F	F	F	F	F	F		F	F			F	F	F	F	F	F
(5-17) Bridge Restrictions	M	F	M	M	F	M	M	M	M		F	F		M	M	F	F(11)	M	M	F	F	F	F
(5-18) Bike Routes (Shldr)			EU/M	(7)	EU/F			EU/M	EU/M			B	B	EU/M	EU/M					B	F	B	EU/F

Not Applicable

**F** Full design level

**M** Modified design level. See Chapter 430.

**B** Basic design level. See Chapter 410.

**EU** Evaluate Upgrade

(1) Collision Reduction (HAL, HAC, PAL), or Collision Prevention (Risk, Signalization & Channelization). Specific deficiencies that created the project must be upgraded to design level as stated in matrix.

(2) Modified design level may apply based on a corridor or project analysis. See 325.02.

(3) If designated in Limited Access Master Plan, apply limited access standards. If not, access management standards apply. See Chapter 920.

(5) For bike/pedestrian design see Chapter 1020.

(6) Applies only to bridge ends terminal and transition sections.

(7) 4 ft minimum shoulders.

(8) If all weather structure can be achieved with spot digouts and overlay, basic design level applies. See Chapter 820.

(11) See Chapter 1120.

(12) Impact attenuators are considered as terminals.

(16) For design elements not in the matrix headings, apply full design level as found in the applicable *Design Manual* chapters.

330.01	General
330.02	References
330.03	Purpose
330.04	Project Development
330.05	Project Definition Phase
330.06	Design Documentation
330.07	Design Approval
330.08	Process Review for Region Approved Projects

### 330.01 General

The project file contains the documentation of planning, project definition, programming, design, approvals, contract assembly, utility relocation, needed right-of-way, advertisement, award, construction, and maintenance of a project. A project file is completed for all projects and follows the project until a new project supersedes it.

Design documentation is a part of the project file. It documents design decisions and the design process followed. Design documentation is retained in a permanent retrievable file at a central location in each region. For operational changes and developer projects, design documentation is required and is retained by the region.

### 330.02 References

*Construction Manual*, M 41-01, WSDOT

Directional Documents Publication Index,  
D 00-00, WSDOT

Washington State Department of Transportation  
Certification Acceptance Approval from FHWA,  
December 4, 1978, and subsequent revisions

FHWA Washington Stewardship Plan, WSDOT  
1993

Master Plan for Limited Access, WSDOT

*Plans Preparation Manual*, M 22-31, WSDOT

*Route Development Plan*, WSDOT

*State Highway System Plan*, WSDOT

*Highway Runoff Manual*, WSDOT

### 330.03 Purpose

Design documentation is prepared to record the evaluations by the various disciplines that result in design recommendations. Design assumptions and decisions made prior to and during the project definition phase are included. Changes that occur throughout the project development process are documented. Justification and approvals, if required, are also included.

The design documentation identifies:

- The condition or problem that generated the purpose and need for the project (as noted in the Project Summary)
- The design alternatives considered
- The project design selected
- The work required to satisfy the commitments made in the environmental documents
- The conformity of the selected design to departmental policies and standard practices
- The supporting information for any design variances
- The internal and external coordination

The design documentation is used to:

- Examine estimates of cost
- Prepare access and right of way plans
- Assure that all commitments are provided for in the recommended design
- Plan for maintenance responsibilities as a result of the project
- Provide supporting information for design variances
- Explain design decisions
- Document the project development process and design decisions
- Preserve a record of the project's development for future reference
- Prepare plans, specifications, and estimate (PS&E)

### 330.04 Project Development

The region initiates the project by preparing the Project Summary package. The project coordination with other disciplines (such as Real Estate Services, Utilities, and Surveying) is started in the project definition phase and continues throughout the project's development. The region coordinates with state and federal resource agencies and local governments to provide and obtain information to assist in developing the project.

The project is developed in accordance with all applicable Directives, Instructional Letters, and manuals as listed in D 00-00; the Master Plan for Limited Access Highways; *State Highway System Plan*; Level of Development Plan; *Route Development Plan*; FHWA Washington Stewardship Plan; and the Project Summary.

The region develops and maintains documentation for each project. This file includes documentation of all work on the project from before the project definition phase through public involvement, environmental action, design decisions, right of way acquisition, and PS&E development. Refer to the *Plans Preparation Manual* for PS&E documentation.

All projects involving FHWA action require NEPA clearance. Environmental action is determined through the Environmental Classification Summary (ECS) form. The environmental approval levels are shown in Figure 330-2.

Upon receipt of the ECS approval, the region proceeds with environmental documentation, including instituting public involvement methods that are appropriate to the magnitude and type of the project. (See Chapter 210.)

The Assistant State Design Engineer works with the regions on project development and conducts process reviews on projects as described in 330.08.

### 330.05 Project Definition Phase

Project definition is the initial phase of project development. The project definition effort is prompted by the State Highway System Plan. The project definition phase consists of determining a preliminary project description, schedule, and

estimate. The intent is to make design decisions early in the project development process. During the project definition effort, the *Project Summary* documents are produced.

**Project Summary** provides information on the results of the project definition phase; links the project to the Highway System Plan; and documents the design decisions, the environmental classification, and agency coordination. The Project Summary is developed before the project is funded for construction. The Project Summary consists of the *Environmental Review Summary*, *Design Decisions Summary*, and *Project Definition*.

**Environmental Review Summary (ERS)** lists the environmental permits and approvals that will be required, environmental classifications, and environmental considerations. This form lists requirements by environmental and permitting agencies. If there is a change in project definition, the information in the ERS must be reviewed and changed to match the new project definition. The ERS is prepared during the project definition effort. The ERS is approved by the region.

**Design Decisions Summary (DDS)** states the roadway geometrics, design deviations, evaluate upgrades (EUs), other roadway features, and any design decisions made during the project definition phase of a project. The information contained in this form is compiled from various databases of departmental information, field data collection, and evaluations made in development of the *Project Definition* and the ERS. To sign the Design Decision Summary the region must be comfortable that there will be no significant change in the project definition or estimated cost. Design decisions may be revised throughout the project development process based on continuing evaluations.

The DDS is approved by the Assistant State Design Engineer for new construction and reconstruction projects on the Interstate system. The regional design authority approves the DDS for all other types of projects. (See Figure 330-1)

**Project Definition (PD)** identifies the various disciplines and design elements that will be encountered in project development. The Project

Definition states the needs, the purpose of the project, program categories, and the design matrices that were used to develop the Project Definition. This information determines the level of documentation and evaluation that is needed for approval of the design. The Project Summary is completed in the project definition phase.

Once the project has been formally adopted into the WSDOT operating program, project development continues. Design of projects is further refined by a project manager through an interdisciplinary team process. Projects continue with the development of environmental and design documentation.

## **330.06 Design Documentation**

### **(1) FHWA Requirements**

For projects on the Interstate system, the level of FHWA oversight varies according to the type of project, the agency doing the work, and the funding source. See Figure 330-1 for details.

FHWA operational acceptance is required for any new or revised access point on the Interstate system, regardless of funding. (See Chapter 1425.)

Documentation for projects requiring FHWA review and approval is submitted through the Olympia Service Center (OSC) Design Office. Include the following items if applicable to the project:

- Project Definition (form)
- Environmental Review Summary (form)
- Design Decisions Summary (form)
- Design Variance Inventory (form) with support information for EUs and deviations
- Cost estimate
- NEPA documentation
- Design Clear Zone Inventory (form)
- Interchange plans, and profiles (and roadway sections if appropriate)
- Traffic projections and analysis
- Accident analysis

- The report requesting new or revised access points

The forms listed above (Project Definition, Environmental Review Summary, Design Decisions Summary) are generated by the Project Summary database. Specific on-line instructions for filling them out are contained in the database.

### **(2) Design Documents**

The design portion of the project file preserves the decision documents generated during the design process. A summary (list) of these documents is recommended because projects vary in scope and the documents applicable to the project vary accordingly.

The design documents commonly included in the project file for all but the simplest projects are listed below. The ERS, PD, and DDS forms are in the Project Summary database which includes on-line instructions.

- Documentation of any design decision to do more, or less, than WSDOT guidance indicates and documentation of design decisions for components not addressed by WSDOT guidance. (These may be separate documents or portions of the documents listed below.)
- Environmental Review Summary (ERS form)
- Project Definition (PD form)
- Design Decisions Summary (DDS form)
- Corridor or project analysis. See Chapter 325 for definition and Figures 330-5a and 5b
- Design Variance Inventory (form) with support information for EUs and deviations
- Cost Estimate
- Design Clear Zone Inventory (form)
- Copies of interchange plans, intersection plans, and profiles (and roadway sections if appropriate)
- SEPA and NEPA documentation
- Work Zone Traffic Control Strategy
- Other project components: Provide documentation in the project file as detailed in the applicable *Design Manual* chapters.



Documentation is not required for components not related to the project.

The **Design Variance Inventory** is required for NHS roadway preservation projects only. This form lists all design exceptions, evaluate upgrades not upgraded to the applicable design level, and deviations. See Figure 330-6 for a sample evaluate upgrade and Figures 330-7a and b and 8a and b for sample deviations.

The Project Definition and Environmental Review Summary are required for all projects.

The Design Decisions Summary form is not required for the following project types unless they involve reconstructing the lanes, shoulders, or fill slopes. Since these project types are not included in the design matrices, evaluate them with respect to modified design level (M) for non-NHS routes and full design level (F) for all others.

- Bridge painting
- Crushing and stockpiling
- Pit site reclamation
- Lane marker replacement
- Guidepost replacement
- Signal rephasing
- Signal upgrade
- Seismic retrofit
- Bridge joint repair
- Navigation light replacement
- Signing upgrade
- Illumination Upgrade
- Rumble Strips
- Electrical upgrades
- Major Drainage
- Slope Stability\*
- Bridge scour
- Fish passage
- Other projects as approved by OSC Design

\*Address rock scour within the project limits whenever feasible.

### 330.07 Design Approval

Design Approval is the approval of the design file. When the design file is complete, the region takes an action to make an approval that becomes part of the file. Figure 330-1 identifies the approval levels for design, evaluate upgrades (EUs), and deviations. The following items must be approved prior to design approval:

- Required environmental documentation (NEPA, SEPA)
- Project Summary (includes Project Definition, Design Decision Summary, and Environmental Review Summary)
- Design Variance Inventory (includes evaluate upgrades and deviations)
- Cost estimate

See Figures 330-1 through 4 for review and approval levels for project design and PS&E documents. Figures 330-2, 330-3, and 330-4 are summaries of information provided in other WSDOT documents.

### 330.08 Process Review

The process review is done to provide reasonable assurance that projects are prepared in compliance with established standards and procedures and that adequate records exist to show compliance with state and federal requirements.

The design and PS&E process review is performed in each region at least once each year by the OSC Project Development Branch. Four documents are used in the review process: the Design Review Check List, PS&E Review Check List, Design Review Summary, and PS&E Review Summary. These are generic forms used for all project reviews. Copies of these working documents are available for reference when assembling project documentation. OSC Design Office, Project Development maintains current copies on Exchange and on the Internet. For paper copies or a specific electronic address contact the OSC Project Development Branch.

Each project selected for review is examined completely and systematically beginning with the project definition and the project summary phase and continuing through contract plans and (when

available) construction records and change orders. Projects are normally selected after contract award. For projects having major traffic design elements, the OSC Traffic Operations personnel are involved in the review. The WSDOT process reviews may be held in conjunction with FHWA process reviews.

The OSC Project Development Branch schedules the process review and coordinates it with the region. Notification of the scheduled process review is sent to FHWA for their information and for use in coordinating a joint process review.

A process review follows this general agenda:

1. Review team meets with regional personnel to discuss the object of the review.
2. Review team reviews the design and PS&E documents, and the construction documents and change orders if available, using the check lists.
3. Review team meets with regional personnel to ask questions and clarify issues that have arisen.
4. Review team meets with regional personnel to discuss findings.
5. Review team submits a draft report to the region for comments and input.
6. If the review of a project shows a serious discrepancy, the regional design authority is asked to report the steps that will be taken to correct the deficiency.
7. The process review summary forms are completed.
8. The summary forms and check lists are evaluated by the State Design Engineer.
9. The findings and recommendations of the State Design Engineer are forwarded to the regional design authority, for action and/or information, within 30 days of the review.

*P65:DP/DME*

<b>Project Design</b>	<b>FHWA Oversight Level</b>	<b>Deviation and Corridor/Project Approval</b>	<b>EU Approval</b>	<b>Design Approval</b>
<b>Interstate</b>				
New/Reconstruction <sup>(e)</sup> • Federal funds • No federal funds	(a) (b)	FHWA	Region	FHWA
SC&DI over \$1 million • Federal funds • No federal funds	(a) (b)	FHWA	Region	FHWA
All Other <sup>(d)</sup> • Federal funds • State funds • Local agency funds	(c) (c) (b)	OSC Design	Region	Region
<b>NHS</b>				
All	(c)	OSC Design	Region	Region
<b>Non-NHS</b>				
New/Reconstruction	N/A	OSC Design	Region	Region
All Other	N/A	Region	Region	Region

FHWA = Federal Highway Administration  
OSC = Olympia Service Center

- (a) Requires FHWA review and approval (full oversight) of design and PS&E submitted by OSC Design.
- (b) To determine the appropriate oversight level, FHWA reviews the Project Summary (or other programming document) submitted by OSC Design or by TransAid through OSC Design.
- (c) FHWA oversight is accomplished by process review. (See 330.08.)
- (d) Reduction of through lane or shoulder widths (regardless of funding) requires FHWA review and approval of the proposal.
- (e) See Chapter 325 for definition.

**Design Approval Level**  
*Figure 330-1*

Item	Region		OSC		FHWA	
	Review	Approval	Review	Approval	Review	Approval
<b>Program Development</b>						
Work Order Authorization				X		X [1]
<b>Public Hearings</b>						
Corridor Plan [13]				X		
Design Summary [14]				X		
Access Hearing Plan [14]				X		
Access Findings and Order [15]				X		
<b>Environmental By Classification</b>						
Summary (ECS) NEPA						X
Class I NEPA (EIS)			X			X
Class I SEPA (EIS)				X		
Class II NEPA *Programmatic Categorical Exclusion (CE)		X				
Class II NEPA — Documented Categorical Exclusion (CE)	X					X
Class II SEPA — Categorical Exemption (CE)		X				
Class III NEPA — Environmental Assessment (EA)			X			X
SEPA Check List		X				

\*If on the preapproved list.

**Notes:**

X Normal procedure

[1] Federal aid projects only

[3] Applies to new/reconstruction projects on Interstate routes

[13] Assistant Secretary for Environmental and Engineering Service Center approval

[14] State Design Engineer approval

[15] Refer to Chapter 210 for approval requirements

**Reviews and Approvals**

*Figure 330-2*

Item	Region		OSC		FHWA	
	R	Approval	Review	Approval	Review	Approval
<b>Design</b>						
Design Deviations		[2]		[2]		[2]
Experimental Features				X		X [3]
Environmental Review Summary		X				
Final Design Decision Summary		X		X [3]		
Final Project Definition				X [4]		
Access Point Revision Report			X			X
Non-Interstate Interchange Access Point Report				X		
Interchange Plans [12]		X		X [3]		
Intersection Plans [12]		X		X [3]		
Materials Source Report				X [5]		
Pavement Determination Report				X [5]		
Project Design Approval		[2]		[2]		[2]
Proprietary Items				X		X [3]
Resurfacing Report				X [5]		
Signal Permits		X [6]				
Geotechnical Report				X [5]		
Tied Bids		X				X [3]
Bridge Design Plans (Bridge Layout)		X		X		
Hydraulic Report		[7]	X [8]			
Preliminary Signalization Plans			X			
Rest Area Plans				X		
Roadside Restoration Plans		X [9]		X [10]		
Structures Requiring TS&L's				X		X
Wetland Mitigation Plans		X		X		
Wetland Mitigation Planting Plans		X [9][11]		X [10]		
Grading Plans		X [9][11]		X [10]		

**Reviews and Approvals, Design**  
*Figure 330-3a*

**Notes:**

- X Normal procedure
- [2] Refer to Figure 330-1 for design approval level
- [3] Applies to new/reconstruction projects on Interstate routes
- [4] OSC Program Management
- [5] Submit to OSC Materials Branch for review and approval
- [6] Approved by Regional Administrator
- [7] See M 23-03, Hydraulics Manual for additional guidance
- [8] Region to submit Hydraulic Report. Refer to Hydraulics Manual
- [9] Applies only to regions with a Landscape Architect
- [10] Applies only to regions without a Landscape Architect
- [11] Approved by Regional Landscape Architect
- [12] Include channelization details

**Reviews and Approvals, Design (continued)**

*Figure 330-3b*

<b>Item</b>	<b>Interstate New/ Reconstruction</b>	<b>NHS and Non-NHS</b>
Minority/training goals	OSC(a)	OSC(a)
Right of way certification for federal aid projects	OSC(b)	OSC(b)
Right of way certification for state funded projects	Region(b)	Region(b)
Railroad agreements	OSC(c)	OSC(c)
Work performed for public or private entities	OSC[1][6]	Region[1][6]
State force work	FHWA[2](d)	OSC[2](c)(d)
Use of stockpiled materials	FHWA[3]	Region[3]
Stockpiling materials for future projects	FHWA[3]	Region[3]
Work order authorization	OSC[4](d)	OSC[4](d)
Ultimate reclamation plan approval through DNR	Region	Region
Proprietary item use	FHWA	OSC(c)
Mandatory material sources and/or waste sites	FHWA[3]	Region[3]
Nonstandard bid item use	Region	Region
Incentive provisions	FHWA	OSC(e)
Nonstandard liquidated damages	FHWA[5](e)	OSC[5](e)

**Notes:**

- [1] This work requires a written agreement. See Plans Preparation Manual .  
[2] Use of state forces is subject to \$30,000 limitation as stipulated in RCWs 47.28.030 and 47.28.035.  
[3] Applies only to federal aid projects. However, document for all projects.  
[4] Prior FHWA funding approval required for federal aid projects.  
[5] Consult with OSC Transportation Data Office. See Plans Preparation Manual.  
[6] Region approval subject to \$250,000 limitation.

**Regional or Olympia Service Center approval authority:**

- (a) Office of Equal Opportunity  
(b) Real Estate Services  
(c) Design Office  
(d) Program Management Office  
(e) Construction Office

**PS&E Process Approvals**  
*Figure 330-4*

## Project Analysis

**L-0000 SR A**

**Yodelin Hill Climbing Lane SR A MP B to MP C**

### Overview

High truck volumes and steep grades are adversely impacting traffic flows and safety on this section of highway. The purpose of this project is to increase traffic flows and safety by adding a climbing lane.

For this NHS rural mobility project, the Design Matrix calls for full design level with an option to use modified design level based on a corridor or project analysis. In *Design Manual* Chapter 440, the ADT of 6300, DHV of 730, and truck percentage of 18% in design year 2016 indicates design class P-2 multilane. Considering the following justification, the region proposes to design this project to the modified design level MDL-14 with a truck climbing lane.

A climbing lane warrant has been met.

### Route Description

This section of SR A parallels a mountain stream and is located in steep mountainous terrain. Adjacent roadway sections consist of two 11.3 ft lanes with 4 ft shoulders. Fill slopes generally range between 3H:1V and 4H:1V as do ditch inslopes. The posted speed is 60 mph in both directions.

### Comparison

	Existing Conditions	Modified Design Level (MDL-14)	Full Design Level (P-2)	Proposed (MDL-14)
Fill slopes	3H:1V to 4H:1V	4H:1V	6H:1V	4H:1V
Lane Width	11.3 ft	12 ft	12 ft	12 ft
No. Thru. Lanes	2	2+1	4	2+1
Shoulder Width	4 ft	4 ft	10 ft	4 ft
Median Width	none	none	18	none

The use of full design level would require a wider roadway which would in turn require significant impacts to the stream, very high and lengthy rock cut, additional right of way including acquisition of numerous cabins, and utility impacts. The cost to construct this section to full design level is approximately \$6 million more than to construct to modified design level with an additional climbing lane.

Adding a fourth lane throughout this narrow corridor would have minimal benefits to the traveling public. There is no proposed improvement in the 20 year System Plan to make either this section, or adjacent sections of highway, four lanes.

## Sample Project Analysis

*Figure 330-5a*



**Accidents**

The accident history from April 1993 through March 1996 indicates 28 accidents resulting in 1 fatality, 16 injuries, and \$392,100 in property damage.

14 of the 28 accidents, including the fatality, occurred while passing uphill traffic. Seven other accidents occurred during turning maneuvers at four different locations throughout the project.

Addition of the truck climbing lane should reduce the number and severity of accidents on this section of roadway. The additional fourth lane throughout would probably not significantly reduce the number or severity of accidents.

**Summary**

Considering route continuity, environmental constrains, additional cost, and minimal benefit, the region feels constructing to full design level is not justified. Therefore, the region proposes to construct this project to modified design level.

_____	_____	_____	_____
Regional Concurrence	Date	OSC Design Approval	Date

**Sample Project Analysis**  
*Figure 330-5b*

## Evaluate Upgrade

**Subject Project: L-0000, Region Wide Channelization**

**Intersections of Concern: SR 1 at V Street  
SR 15 at SR 13**

### Project Description

The purpose of this project is to make safety improvements to five intersections in the region. This evaluation is for the intersection angles at the intersections of SR 1 at V Street and SR 15 at SR 13.

### Design Matrix

The Design Matrix requires an evaluation of upgrading intersection angles outside the range of 75-105 degrees. This applies to both Non-NHS and NHS routes.

### Existing Intersection Angles

The existing intersection angles are as follows:

SR 1 at V Street	107-41-53
SR 15 at SR 13	126-52-57

The accident history listings show no accidents related to the existing intersection angle.

### Impacts

Upgrading these intersection angles on this project would result in the following impacts:

SR 1 at V Street: A USBR irrigation siphon crosses SR 1 at this intersection. To correct the intersection angle would require realignment of the irrigation canal and construction of a new siphon. This canal is operational year-round. In addition to the irrigation impacts upgrading the angle would require purchase of right of way.

SR 15 at SR 13: This intersection was constructed to its present configuration under a developer agreement. This intersection is surrounded by retail developments. Correction of the intersection angle would require reconstruction of the existing signal system and extensive right of way purchase. The impacted parcels would result in negative economic impacts to a newly developed area and the relocation of multiple businesses.

### Funding

Reconstructing these intersections to meet design standards would cost approximately \$500,000 for the intersection of SR 1 at V Street and approximately \$2,000,000 for the intersection of SR 15 at SR 13.

### Recommendation

After considering the accident history, impacts to USBR canal, impacts to multiple businesses, and the limited right of way, reconstructing these intersections to meet the intersection angle standards does not represent good economic or engineering judgment. The realignment would provide minimal benefits for the excessive costs. Therefore it is proposed to not upgrade the existing intersection angles.

## Sample Evaluate Upgrade (EU)

*Figure 330-6*

## DEVIATION - Fill Slopes

L-0000

SR A

MP A to MP B

### APPLE TREE LANE CHANNELIZATION

#### Overview

The purpose of this I-2 project is to reduce accidents in the intersection of Apple Tree Lane and State Route A by adding left turn channelization. This intersection is a high accident location (HAL).

#### Existing Conditions

State Route A is an NHS route. This section of SR A is semi-urban and follows the rolling terrain as it approaches the city. The posted speed is 45 mph and the ADT is 4500 with a truck percentage of 9%.

The adjacent roadway consists of two 12 ft lanes, 7.3 to 8 ft shoulders, and 3H:1V to 4H:1V fill and ditch inslopes.

A wetland is present at the toe of the existing 3H:1V slope near the intersection. The water in the wetland is less than 2 ft deep and thus is not a hazard. There are no hazards within the Design Clear Zone in this vicinity.

#### Proposed Project

It is proposed to construct two 12 ft lanes, 8 ft shoulders, one 12 ft left turn lane (each direction) and 4H:1V fill and ditch inslopes except for the 3H:1V fill slope noted below. All turning movements will meet standards for the WB-40 design vehicle.

MDL-11 standards are proposed.

#### Deviation Description

Modified design level calls for 4H:1V fill slopes for fill height less than 20 ft. In order to avoid impacts to a wetland, the region proposes to leave an existing 3H:1V fill slope ranging in height from 7 to 13 ft for a length to 130 ft (MP 101.22 to MP 101.24) on the right. There will not be any hazards on the 3H:1V fill slope or within in the Design Clear Zone in this vicinity.

#### Other Options Considered

Several options were consider.

*Option 1* - Realign the highway to the north to avoid the wetland. The left turn lane is designed asymmetrically. All of the widening is proposed to be on the opposite side of the highway from the wetland to avoid impacts. Shifting the highway further would create a potentially hazardous alignment in an otherwise straight section of highway. This would be especially dangerous at night and during snowy and icy conditions.

This option would also require minor right of way acquisition and would adversely impact access to a pumping island at a gas station.

## Sample Deviation, Rural

*Figure 330-7a*

*Option 2* - Install guardrail or barrier. Guardrail is not required as per Chapter 700 and the installation of guardrail to protect a 3H:1V slope would place a fixed object (guardrail) closer to the traveling public than the slope.

*Option 3* - Fill the Wetland. Using a 4H:1V fill slope would impact 6 acres of wetland.

This would require mitigation consisting of creating more wetlands elsewhere. It would also require long term maintenance and monitoring of the wetland. The estimated cost for this including permits (if possible), design, construction, and maintenance is \$90,000.

#### **Accident Summary**

From April 1993 to March 1996 there were 41 accidents including 35 injuries and two fatalities at this intersection. 16 accidents were rear-enders. 22 accidents occurred during turning movements (including both fatalities).

14 of the 41 accidents occurred at night. Illumination is proposed.

Only two accidents were single vehicle run off the road accidents. Neither included an injury.

The proposed left turn lane for both eastbound and westbound traffic should reduce the number and severity of accidents at this intersection. Drive off the road accidents are not prevalent at this intersection.

#### **Recommendation**

The proposed project addresses the primary causes of this intersection being a HAL by providing a left turn lane with illumination.

The 3H:1V slope is not a significant hazard. There are no better alternatives to the 3H:1V slope.

Therefore, the region requests a deviation to leave the existing 3H:1V slope as noted above.

\_\_\_\_\_  
Regional Concurrence

\_\_\_\_\_  
Date

\_\_\_\_\_  
OSC Design Approval

\_\_\_\_\_  
Date

### **Sample Deviation, Rural**

*Figure 330-7b*

## SR Z Northbound Downtown Rechannelization

01 0000

### Project Description

This project proposes to add an auxiliary (add/drop) lane to northbound SR-Z through a portion of downtown Suak between the Universal Street On Ramp and the Morgan Street Off Ramp. This auxiliary lane will be added to the northbound main line by reconstructing the existing shoulders and restriping the roadway. There is no roadway or bridge widening proposed for this project. Items of work associated with this project include; shoulder reconstruction, replacement of bridge rail and guardrail, drainage work, striping, minor electrical, and signing.

The intent of this project is to provide an economically feasible solution to a congestion problem occurring at the Morgan Street Off Ramp. This congestion problem has resulted in a "High Accident Location" as is documented in the WSDOT 1992 HAL Review and again summarized in the 1996 High Accident Location Review. (See Appendix A - 1996 High Accident Review)

Though this work will provide a capacity increase for SR 5, the main benefit from this project will be accident reduction. This work will reduce the high number of rear end accidents along the inside lane by providing an exit only lane to the Morgan Street Off Ramp. This auxiliary lane will provide safer storage on the main line when the ramp queues up onto SR 5. (See Appendix B - Photographs)

SR 5 is a NHS route. This section of SR 5 is in a highly urban area, with a design speed of 60 mph, and the current ADT is 213,000. The average daily traffic truck percentage is 4-5%. The design classification is I-1 documented per "Design Guidelines - for Interstate Routes - PCC Pavements - Geometric Elements", Reconstruction, Capacity Improvements and HOV Lanes.

### Deviation #1 — Reduced Shoulder Widths

#### Existing Condition:

Currently, the Universal Street On Ramp merges into the inside lane of northbound SR 5 at approximately MP 165.94. The Morgan Street Off Ramp then diverges from the inside lane at approximately MP 166.44. The northbound main line of SR 5 in this section consists of four 12 ft through lanes. The existing outside shoulder is standard with a width of 11.6 ft. The existing inside shoulder is nonstandard for approximately half of the project from the beginning of the project (station 67+84) to the end of Bridge 5/545E (station 82+08). The nonstandard shoulder in this section varies in width from 5 to 10 ft. The existing inside shoulder becomes standard for the second half of the project with a width of 10 ft. (See Appendix C - Existing Channelization.)

#### Standard:

The standard shoulder width (left and right) for an eight lane interstate is 10 ft. (Figure 440-1a, Geometric Design Data, Interstate, WSDOT Design Manual, March, 1994)

#### Alternatives:

- No Build** - By not constructing this project, the right shoulder would remain standard and the left shoulder would remain standard for the second half of the project. The left shoulder on the first half of the project would remain substandard. This option would not solve the SR 5 capacity, Morgan Street storage, and the high accident problems associated with the current configuration. A benefit/cost evaluation for this alternative would be undefined as both the benefit and cost would be nothing.
- Build to Full Standards** - Widening the bridge and roadway to provide a full standard 10 ft shoulder on both sides would benefit safety, emergency use, disabled use, maintenance use, and refuge. However, the cost of this alternative would be in the hundreds of millions of dollars. The bridge and roadway could either be widened to the right, left, or both. Widening in either direction would require additional right-of-way in downtown Suak. Widening to the right would require realigning the Apple off and on ramps, and relocating an 27 by 2,600 ft retaining wall supporting Capital Hill. Undercrossings, city streets, parking, retail businesses, and apartment complexes would be impacted and possibly have to be relocated. Widening to the left would require realigning southbound SR 5 further to the west. Again, this would impact undercrossings, existing ramp alignments, city streets, businesses, and large buildings including the Washington State Convention Center. The cost of providing 10 ft shoulders could easily exceed hundreds of millions of dollars.
- Modified Design** - (See Appendix D - Channelization Plans) Construct project with substandard shoulder widths. This configuration would consist of full standard lane widths including four 12 ft through lanes and one 12 ft auxiliary (add/drop) lane. The left shoulder adjacent to the auxiliary (add/drop) lane would be a 2 ft width. The right shoulder would reduce from a full standard 10 ft width down to a 6 ft width. This would be maintained for a short segment of 260 ft. The right shoulder would then increase to 8 ft. This width would be maintained

2

past the Owhi Way Undercrossing. The shoulder would then taper back to a full 10 ft width. This configuration would maximize the right shoulder width allowing most of the right shoulder throughout the limits of the project to be used for emergency use. This configuration allows enough room to have the Universal On Ramp become an add lane that would drop at the Morgan Street Off Ramp. This alternative would provide the benefit of increasing capacity for the short segment and overall corridor, provide safer additional storage for the Morgan off ramp on the main line, and thereby reduce accidents. All of these benefits would come at a reasonable cost.

### Recommendation #1

We recommend alternative #3 and request a design deviation for the following reasons:

- This is the only economically feasible alternative that increases storage for the Morgan Off Ramp and solves the current configuration problem.
- All of the barrier within the project limits will be upgrading to current AASHTO standards, thus helping mitigate the reduced shoulder widths.
- The smaller substandard left shoulder with a minimum width of 2 ft is only adjacent to the auxiliary (add/drop) lane and not the main line through lanes.
- If, at a later date, the reduced shoulder widths prove to be a safety problem, the roadway could simply be restriped back to the original configuration and this section of the corridor would have full depth PCCP shoulders and upgraded barriers to current AASHTO standards.
- By providing this additional lane, we estimate we will reduce rear end accidents by one third. We also anticipate a reduction in the number of sideswipe accidents.
- As the photographs show (Appendix B), motorists are already using the shoulder for storage. By making this improvement, we eliminate the conflicts that the current shoulder usage is creating.

### Deviation #2 — Undercrossings - Barriers

#### Existing Condition:

There are four undercrossings that fall within the project limits. (See Appendix D - Channelization Plans) They are:

Spear Street Undercrossing  
Spruce Street / Balen Ave. Undercrossing  
Apple Way Undercrossing  
Owhi Way Undercrossing

3

With the exception of a single Northbound off ramp to Apple and a single Northbound on ramp from Apple, there is no other access to northbound SR. 5.

All four undercrossings have the original barriers (bridge rails) which consist of a 7 in high curb with a width of either 2 ft, 10 ft, or 12 ft. On top of the curb is a 10 in wide by 1.5 ft high parapet supporting a Type 3-A Bridge Rail. (See Appendix B - Bridge Rail Photographs).

#### Standard:

The standard barrier (bridge rail) for an undercrossing is required to withstand a 5 kip load. (Section 710.08 Bridge Rails, WSDOT Design Manual, June, 1995) The Bridge and Structures office was asked to assess these bridge rails for strength and they found that they do not meet current AASHTO specifications for strength. (See Appendix E - Bridge Correspondence)

#### Alternatives:

- No Build** - This alternative would leave the existing bridge rails on all the undercrossings. A benefit/cost evaluation for this alternative would be undefined as the cost would be nothing.
- Build to Full Standards (Concrete Safety Shape - Preferred Treatment)** - Under this alternative, all of the existing bridge rails would be removed and replaced with a concrete safety shape barrier. This alternative has been estimated to cost approximately \$500,000. The benefit of this alternative has been estimated to be very small for the reasons listed under "Recommendation" of this deviation.
- Build to Full Standards (Attach Thrie Beam to Parapet)** - Under this alternative, thrie beam would be attached directly to the parapets. Although the cost for this alternative is significantly less the Alt. #2 (approximately \$150,000), once again the benefit has been estimated to be very small..
- Modified "Full Standard" Add a safety shaped barrier between the traveled lanes and the sidewalks.** This alternative initially seems to be make the most sense because it additionally provides a barrier between the vehicles and the pedestrians and saves the cost of removing the old rail. However, this is an extremely high pedestrian area that would require many pedestrian access points (breaks in the barrier). These breaks would be required at the ends of the bridges and all four corners of Spruce and Balen.

4

## Sample Deviation, Urban Figure 330-8a

All of these new barriers would be inside the clear zone and therefore make it a more dangerous situation for the motorist than is currently existing.

#### Recommendation #2

We recommend alternative #1 and request a design deviation to leave the existing bridge rails on all four undercrossings for the following reasons:

1. All of the existing bridge rails are outside of the clear zone (1.6 ft behind the face of curb for 35 mph or less)
2. All of the undercrossings are tangent sections with low speeds (posted 25 mph).
3. There is no evidence or record of repair work indicating that any of the existing bridge rails have ever been damaged by any sort of impact. Certainly, no vehicle has ever broken through these barriers.
4. Although the DOT does not maintain traffic data (traffic counts and accident history) for these undercrossings that are City of Suak streets with no access to the interstate, evidence and conversations suggest that the majority of accidents that have occurred on these undercrossings are rear-end types. Replacing the barriers would do nothing to reduce rear-end accidents.
5. All barriers except the north side of Owhi and the north side of Spruce have a 10 ft or 12 ft wide sidewalk in front of them. It would be difficult for a vehicle to even reach these barriers. The north side of Spear has a 12 ft sidewalk with large concrete planter boxes between the traveled lane and the sidewalk. (See Appendix B - Bridge Rail Photographs - 1st Picture).
6. The cost of this work and traffic and pedestrian impacts may jeopardize the likelihood of the project ever being funded.
7. There are literally miles and miles of substandard bridge rail along the SR5 corridor through the downtown Suak area where vehicle speeds exceed 60 mph and impacts to these rails occur on a regular basis. These barriers should be brought to standard before money is spent on these undercrossings. If bridge rail replacement projects were prioritized, these undercrossings would be at the bottom of the list.

#### Deviation #3 — Reduced Lane Widths

##### Existing Condition:

1. Currently, the Universal Street On Ramp merges into the inside lane of northbound SR 5 at approximately MP 165.94. The Morgan Street Off Ramp then diverges from the inside lane at approximately MP 166.44. The northbound

5

3. **Modified Design** - (See Appendix D - Channelization Plans) Construct project with substandard lane widths. This configuration would consist of utilizing reduced lane widths of 11 ft for all but lane 4. The left shoulder adjacent to the auxiliary (add/drop) lane would vary from a 2 ft width to 4 ft width. This design would provide a right shoulder that would remain at full standards, 10 ft width. This configuration would maximize the right shoulder width allowing full use of the right shoulder throughout the limits of the project to be used for emergency use. This configuration allows enough room to have the Universal On Ramp become an add lane that would drop at the Morgan Street Off Ramp. This alternative would provide the benefit of increasing capacity for the short segment and overall corridor, provide safer additional storage for the Morgan off ramp on the main line, and thereby reduce accidents. All of these benefits would come at a reasonable cost.

#### Recommendation #3

We recommend alternative #3 and request a design deviation to construct this project under a modified design for the following reasons (The text below has been extracted from our Memorandum dated May, 5 1997):

The intent of this project is to provide an economically feasible solution to the congestion problem occurring at the Morgan Street Off Ramp. This problem has resulted in a "High Accident Location". The main benefits from this project will be accident reduction and capacity improvement.

Early discussions during the initial scoping of this project directed us to maintain 12 ft lanes throughout the project and accommodate the additional add/drop lane by reducing the width of the shoulders. Our initial channelization plans were developed with five 12 ft lanes, a two ft inside shoulder, and a six-ft outside shoulder.

During the NW Regions Traffic review of the channelization plans, they commented that the reduced shoulder width is not desirable through this location. They believe that it is crucial to have a least one usable shoulder for disabled use, maintenance, enforcement, and incident response. There are no/minimal shoulders immediately south of this project and when accidents occur under the convention center, disabled vehicles are pushed north to this location. The effect of losing this shoulder for disabled vehicles can be devastating to the corridor's capacity. This is one of the few full shoulders remaining in this section of SR. 5 where disabled vehicles can be

7

main line of SR 5 in this section consists of four 12 ft throughlanes. The existing outside shoulder is standard with a width of 11.6 ft. The existing inside shoulder is nonstandard for approximately half of the project from the beginning of the project (station 67+84) to the end of Bridge 5/545E (station 82+08). The nonstandard shoulder in this section varies in width from 5 to 10 ft. The existing inside shoulder becomes standard for the second half of the project with a width of 10 ft. (See Appendix C - Existing Channelization)

##### Standard:

Per the Interstate design standards, lane width for an eight lane interstate is 12 ft. (Figure 440-1a, Geometric Design Data, Interstate, WSDOT Design Manual, March, 1994)

##### Alternatives:

1. **No Build** - By not constructing this project, all four existing lanes would remain at the full standard width of 12 ft and no auxiliary lane would be constructed. The right shoulder would remain standard and the left shoulder would remain standard for the second half of the project. The left shoulder on the first half of the project would remain substandard (see deviation request #1). This option would not solve the SR 5 capacity, Morgan Street storage, and the high accident problems associated with the current configuration. A benefit/cost evaluation for this alternative would be undefined as both the benefit and cost would be nothing.
2. **Build to Full Standards** - Widening the bridge and roadway to provide a full standard 12 ft lanes and 10 ft shoulders would benefit safety, emergency use, disabled use, maintenance use, and refuge. However, the cost of this alternative would be in the hundreds of millions of dollars. The bridge and roadway could either be widened to the right, left or both. Widening in either direction would require additional right-of-way in downtown Suak. Widening to the right would require realigning the Apple off and on ramps, and relocating an 27 by 2,600 ft retaining wall supporting Capital Hill. Undercrossings, city streets, parking, retail businesses, and apartment complexes would be impacted and possibly need to be relocated. Widening to the left would require realigning southbound SR 5 further to the west. Again, this would impact undercrossings, existing ramp alignments, city streets, businesses, and large buildings including the Washington State Convention Center. The cost of providing 10 ft shoulders could easily exceed hundreds of millions of dollars.

6

cleared from the traveled lane. History shows that for every minute an incident blocks a lane, there is a resultant 5 minutes of delay to the affected motorist. This adds up quickly and we know how vital this section of SR-Z is for moving people and goods. Effective incident management (including clearance/removal) is critical through this stretch.

Accident statistics for a 3-year period between October 1993 and October 1996, reveal a total of 672 accident occurred along this section of SR-Z. Of these, 408 occurred south of the Universal Street vicinity. It is estimated that up to 100 of these 408 may be attributed to the conflict area where Universal traffic merges onto the mainline. 482 of the 672 accidents were rear-end type. This equates to 72% vs. a statewide average of 35% and a NW Region average of 45%. The highest number of these rear end accidents (not surprisingly) occurred in lane 4 (the inside lane), see photos - Appendix B.

The only way to provide a full usable 10 ft outside shoulder and maintain a desirable SSD (SSD only meets minimum, not desirable, with a two foot inside shoulder) along this section of SR 5 is to reduce some or all of the lane widths from 12 ft to 11 ft. Many alternatives were considered and through sound engineering principles and practices it was determined that alternative E was the best design.

[A portion of the original's text was omitted here to save space.]

For these reasons, we recommend the implementation of alternative E shown in Appendix E of this document and more specifically on the proposed channelization sheets shown in Appendix D.

#### Appendices

(Sample list follows)

- A. Accident History
- B. Photographs
- C. Existing Channelization
- D. Channelization Plans
- E. Bridge Correspondence
- F. Benefit/Cost Analysis
- G. Traffic Study

8

### Sample Deviation, Urban Figure 330-8b

- 410.01 General
- 410.02 Required Safety Items of Work
- 410.03 Minor Safety and Minor Preservation Work

### 410.01 General

Basic design level (B) preserves pavement structures, extends pavement service life, and maintains safe operations of the highway. The basic design level includes restoring the roadway for safe operations and, where needed, may include safety enhancement. Flexibility is provided so that other conditions can be enhanced while remaining within the scope of pavement preservation work.

The required safety items of work listed below may be programmed under a separate project from the paving project as long as there is some benefit to the delay, the safety features remain functional, and the work is completed within two years after the completion of the paving project. If some of the required items are separated from the paving project, maintain a separate documentation file that addresses the separation of work during the two-year time period.

For bituminous surface treatment projects on non-NHS routes, the separation of required safety items is not limited to the two years stated above. The safety work can be accomplished separately using a corridor-by-corridor approach.

### 410.02 Required Safety Items of Work

For basic design level (B), the following items of work are required:

- Install and replace delineation in accordance with Chapter 830
- Install and replace rumble strips in accordance with the matrices and Chapter 700
- Adjust existing features that are affected by resurfacing, such as monuments, catch basins, and access covers

- Adjust guardrail height in accordance with Chapter 710
- Replace deficient signing, as needed, using current standards. This does not include replacement of sign bridges or cantilever supports
- Relocate, protect, or provide breakaway features for sign supports, luminaires, and WSDOT electrical service poles inside the design clear zone
- Restore sight distance at public road intersections and the inside of curves through low cost measures if they are available such as removal or relocation of signs and other obstructions, and cutting of vegetative matter
- Upgrade nonstandard bridge rail in accordance with the matrices and Chapter 710
- Upgrade barrier terminals and bridge end protection, including transitions, in accordance with Chapter 710
- Restore the cross slope to 1.5 percent when the existing cross slope is flatter than 1.5 percent and, in the engineer's judgment, the steeper slope is needed to solve highway runoff problems in areas of intense rainfall

### 410.03 Minor Safety and Minor Preservation Work

Consider the following items, where appropriate, within the limits of a paving project:

- Spot safety enhancements. These are modifications to isolated roadway or roadside features that, in the engineer's judgment, reduce potential accident frequency or severity
- Striping changes that will provide additional or improved channelization for intersections where sufficient pavement width and structural adequacy exist
- Roadside safety hardware (such as guardrail, signposts, impact attenuators)

- Addressing Location 1 Utility Objects in accordance with the *Utilities Accommodation Policy*, M 22-86

Consider the following items when restoration, replacement, or completion is necessary to assure that an existing system can function as intended:

- Right of way fencing
- Drainage
- Illumination
- Electrical

Examples of the above include, but are not limited to, the following: installing short sections of fence needed to control access, replacing grates that are a hazard to bicycles, upgrading electrical system components that require excessive maintenance, and beveling culverts.

*P:DM4*



430.01	General
430.02	Design Speed
430.03	Roadway Widths
430.04	Ramp Lane Widths
430.05	Stopping Sight Distance
430.06	Profile Grades
430.07	Cross Slope
430.08	Fill Slopes and Ditch Inslopes
430.09	Intersections
430.10	<u>Bridges</u>
430.11	Documentation

### 430.01 General

Modified design level (M) preserves and improves existing roadway geometrics, safety, and operational elements. This chapter provides the design guidance that is unique to the modified design level.

Design elements that do not have modified design level guidance include:

- Access control, see Chapter 1420
- Access management, see Chapter 920
- Basic safety, see Chapter 410
- Clear zone, see Chapter 700
- Traffic barriers, see Chapter 710
- Gore area lighting, see Chapter 840
- Interchange areas, see Chapter 940

Design elements that have both modified and full design level components include:

- Horizontal alignment, see Chapter 620
- Superelevation and shoulder cross slope, see Chapter 640
- Vertical alignment, see Chapter 630

### 430.02 Design Speed

When applying modified design level to a project, select a design speed for use in the design process that reflects the character of the terrain and the type of highway. Select a speed that is not less than the posted speed, the proposed posted speed, or the operating speed, whichever is higher. Document which speed was used, include any supporting studies and data.

### 430.03 Roadway Widths

The design of a project must not decrease the existing roadway width.

Lane and shoulder widths are shown in Figures 430-3 and 4. Consider joint use with other modes of transportation in shoulder design.

Review route continuity and roadway widths. Select widths on the tangents to be consistent throughout a given section of the route. Make any changes where the route characteristics change.

#### (1) Turning Roadway Widths

It may be necessary to widen the roadway on curves to accommodate large vehicles. The total two-lane roadway width of a curve may not be less than that shown in Figure 430-5 or, if the internal angle (delta) is less than 90 degrees, Figure 430-6. The proposed roadway width for a curve may not be less than that of the adjacent tangent sections.

The total roadway width from Figure 430-5 or Figure 430-6 may include the shoulder. When the shoulder is included, full-depth pavement is required.

Widening of the total roadway width of a curve by less than 2 ft is not required for existing two-lane roadways that are to remain in place.

#### (2) Median Width

See Figure 430-3.

### 430.04 Ramp Lane Widths

Ramp lane widths are shown in Figure 430-1 and in Figure 430-10. For ramps with radii less than 300 ft apply full design level see Chapter 640.

Curve Radius	Lane Width
Tangent - 4,000	13
3,000 - 2,000	14
1,000 - 300	15

**Turning Ramp Lane Widths  
Modified Design Level**

*Figure 430-1*

## **430.05 Stopping Sight Distance**

### **(1) Existing Stopping Sight Distance for Vertical Curves**

For crest vertical curves use the existing algebraic difference in grades and the length of curve to compare the existing condition to Figure 430-7. If corrective action is required by Figure 430-7, apply full design level and see Chapter 650.

When modified design level is being applied, sag vertical curves are not normally addressed.

### **(2) Stopping Sight Distance for Horizontal Curves**

For modified design level, use the existing lateral clearance to the sight obstruction and the curve radius to compare the existing condition to Figure 430-8. If corrective action is required by Figure 430-8, apply full design level and see Chapter 650.

For Figure 430-8, an obstruction is any object with a height of 2 ft or more above the roadway surface on the inside of a curve. Examples of possible obstructions are median barrier, guard-rail, bridges, walls, cut slopes, wooded areas, and buildings.

## **430.06 Profile Grades**

When applying modified design level, profile grades generally are not flattened. However, corrective action may be justified for combinations of steep grades and restricted horizontal or vertical curvature. Identify major modifications to horizontal and vertical alignment in the Project Decisions Summary. Total removal of pavement and reconstruction of the subgrade are examples of major modifications.

## **430.07 Cross Slope**

On all tangent sections, the normal cross slopes of the traveled way are 2 percent. Cross slopes up to 2 percent have a barely perceptible effect on vehicle steering, but cross slopes steeper than 2 percent can be noticeable.

The algebraic difference in cross slopes is an operational factor during a passing maneuver on a two-lane road. Its influence increases when increased traffic volumes decrease the number and size of available passing opportunities.

If a longitudinal contiguous section of pavement is to be removed or is on a reconstructed alignment, or if a top course is to be placed over existing pavement, design the restored pavement to a cross slope of 2 percent.

A somewhat steeper cross slope may be necessary to facilitate pavement drainage in areas of intense rainfall, even though this might be less desirable from the operational point of view. In such areas, the design cross slopes may be increased to 2.5 percent with an algebraic difference of 5 percent.

For existing pavements, cross slopes within a range of 1 to 3 percent may remain if there are no operational or drainage problems and— on a two-way, two-lane road — the following conditions are met:

- The algebraic difference is not greater than 4 percent where the ADT is greater than 2000.
- The algebraic difference is not greater than 5 percent where the ADT is 2000 or less.
- The algebraic difference is not greater than 6 percent and the road is striped or signed for no passing.

If the existing pavement does not meet the conditions above, correct the cross slope(s) to be within the range of 1.5 to 2.5 percent. For a two-way, two-lane road, provide an algebraic difference to meet the appropriate conditions stated above except when facilitating drainage in areas of intense rainfall. When applying modified design level to a road with bituminous surface treatment (BST), cross slope correction is not required on the basis of algebraic differences alone.

To maintain or restore curb height, consider lowering the existing pavement level and correcting cross slope by grinding before an asphalt overlay. On urban highways, the cross slope of the outside shoulder may be steepened to minimize curb height and other related impacts. The shoulder may be up to 6 percent with a rollover between the traveled way and the shoulder of no more than 8 percent.

## 430.08 Fill Slopes and Ditch Inslopes

Foreslopes (fill slopes and ditch inslopes) and cut slopes are designed as shown in Figure 430-9 for modified design level main line roadway sections. After the foreslope has been determined, use the guidance in Chapter 700 to determine the need for a traffic barrier.

When a crossroad or road approach has steep foreslopes, there is the possibility that an errant vehicle might become airborne. Therefore, flatten crossroad and road approach foreslopes to 6H:1V where practical and at least to 4H:1V. Provide smooth transitions between the main line foreslopes and the crossroad or road approach foreslopes. Where possible, move the crossroad or road approach drainage away from the main line. This can locate the pipe outside the design clear zone and reduce the length of pipe required.

## 430.09 Intersections

### (1) General

Except as given below, design intersections to meet the requirements in Chapter 910.

### (2) Design Vehicle

Figure 430-2 is a guide for determining the design vehicle. Perform a field review to determine intersection type, type of vehicle that use the intersection, and adequacy of the existing geometrics.

### (3) Angle

The allowable angle between any two respective legs is between 60° and 120°. When realignment is required to meet this angle requirement, consider realigning to an angle between 75° and 105°.

## 430.10 Bridges

Design all new and replacement bridges to full design level (Chapter 440) unless a corridor or project analysis justifies the use of modified design level lane and shoulder widths. Evaluate bridges to remain in place using Figures 430-3 and 4. Whenever possible, continue the roadway lane widths across the bridge and adjust the shoulder widths.

Intersection Type	Design Vehicle
Junction of Major Truck Routes	WB-67
Junction of State Routes	WB-40
Ramp Terminals	WB-40
Other Rural	SU <sup>1</sup>
Urban Industrial	SU <sup>1</sup>
Urban Commercial	P <sup>1</sup>
Residential	P <sup>1</sup>

<sup>1</sup>When the intersection is on a transit or school bus route, use the BUS design vehicle. See Chapter 1060 for additional guidance for transit facilities and for the BUS turning path templates.

### Design Vehicles Modified Design Level

Figure 430-2

Consider joint use with other modes of transportation in lane and shoulder design. See Chapter 1020, Facilities for Nonmotorized Transportation, Chapter 1050, High Occupancy Vehicle Facilities, and Chapter 1060, Transit Benefit Facilities.

## 430.11 Documentation

The following documents are to be preserved in the project file. See Chapter 330.

- Design speed selection
- Existing roadway widths
- Stopping sight distance evaluation
- Justification for profile grade modification
- Existing crown and superelevation
- Intersection field review

	Multilane Divided				Multilane Undivided			
	Trucks Under 10%		Trucks 10% and Over		Trucks Under 10%		Trucks 10% and Over	
Design Class	MDL-1	MDL-2	MDL-3	MDL-4	MDL-5	MDL-6	MDL-7	MDL-8
Current ADT <sup>(1)</sup>	Under 4000	Over 4000	Under 4000	Over 000	Under 4000	Over 4000	Under 4000	Over 4000
Design Speed	The posted speed, the proposed posted speed, or the operating speed, whichever is higher.							
Traffic Lanes Number Width	4 or more 11 ft	4 or more 11 ft	4 or more 11 ft	4 or more 12 ft	4 or more 11 ft	4 or more 11 ft	4 or more 11 ft	4 or more 12 ft
Parking Lanes Urban	None	None	None	None	8 ft	8 ft <sup>(2)</sup>	8 ft	8 ft <sup>(2)</sup>
Median Width Rural Urban	Existing Existing	Existing Existing	Existing Existing	Existing Existing	2 ft 2 ft	4 ft 2 ft	4 ft 2 ft	4 ft 2 ft
Shoulder Width Right <sup>(3)</sup> Left <sup>(4)</sup>	4 ft 2 ft	6 ft 2 ft	4 ft 2 ft	6 ft 2 ft	4 ft	6 ft <sup>(5)</sup>	4 ft	6 ft <sup>(5)</sup>
Minimum Width for Bridges to Remain in Place <sup>(6)(7)(8)</sup>	24 ft <sup>(9)</sup>	26 ft <sup>(9)</sup>	24 ft <sup>(9)</sup>	26 ft <sup>(10)</sup>	48 ft <sup>(9)</sup>	50 ft <sup>(9)(11)</sup>	50 ft <sup>(9)(11)</sup>	54 ft <sup>(10)(11)</sup>
Minimum Width for Rehabilitation of Bridges to Remain in Place <sup>(6)(12)(8)</sup>	28 ft <sup>(9)</sup>	30 ft <sup>(9)</sup>	28 ft <sup>(9)</sup>	32 ft <sup>(10)</sup>	54 ft <sup>(9)</sup>	60 ft <sup>(9)(11)(13)</sup>	56 ft <sup>(9)(11)</sup>	64 ft <sup>(10)(11)(13)</sup>
Minimum Width for Replacement	Full Design Level Applies <sup>(14)</sup>							
Access Control	See Chapter 1420 and the Master Plan for Limited Access Highways, or WAC 468-52 and the region's Highway Access Management Classification Report							

- (1) If current ADT is approaching a borderline condition, consider designing for the higher classification.
- (2) Parking restricted when ADT is over 15,000.
- (3) For lanes 11 ft or more in width, the minimum shy distance from the edge of traveled way to the face of the curb is 2 ft on the right. However, for noncontinuous curbs or where bicycles are anticipated, the minimum shy distance from the edge of traveled way to the face of the curb is 3 ft on the right.
- (4) For lanes 11 ft or more in width, the minimum shy distance to the face of the curb is 1 ft on the left.
- (5) May be reduced by 2 ft under urban conditions.
- (6) Width is the clear distance between curbs or rails, whichever is less.
- (7) Use these widths when a bridge within the project limits requires deck treatment or thrie beam retrofit only.
- (8) For median widths 25 ft or less, see Chapter 1120.
- (9) Add 11 ft for each additional lane.
- (10) Add 12 ft for each additional lane.
- (11) Includes a 4 ft median which may be reduced by 2 ft under urban conditions.
- (12) Use these widths when a bridge within the project limits requires any work beyond the treatment of the deck such as bridge rail replacement, deck replacement, or widening.
- (13) Includes 6 ft shoulders — may be reduced by 2 ft on each side under urban conditions.
- (14) Modified design level lane and shoulder widths may be used when justified with a corridor or project analysis.

**Modified Design Level for Multilane Highways and Bridges**  
*Figure 430-3*

	Two-Lane Highways					
	Trucks Under 10%			Trucks 10% and Over		
Design Class	MDL-9	MDL-10	MDL-11	MDL-12	MDL-13	MDL-14
Current ADT <sup>(1)</sup>	Under 1000	1000-4000	Over 4000	Under 1000	1000-4000	Over 4000
Design Speed	The posted speed, the proposed posted speed, or the operating speed, whichever is higher.					
Traffic Lane <sup>(2)</sup> Width	11 ft	11 ft	11 ft	11 ft	11 ft	12 ft
Parking Lanes Urban	8 ft	8 ft	8 ft <sup>(3)</sup>	8 ft	8 ft	8 ft <sup>(3)</sup>
Shoulder Width <sup>(4)</sup>	2 ft	3 ft <sup>(5)</sup>	4 ft	2 ft	3 ft <sup>(5)</sup>	4 ft
Minimum Width for Bridges to Remain in Place <sup>(6)(7)</sup>	22 ft <sup>(8)</sup>	24 ft	28 ft	22 ft <sup>(8)</sup>	24 ft	28 ft
Minimum Width for Rehabilitation of Bridges to Remain in Place <sup>(7)(9)</sup>	28 ft <sup>(10)</sup>	32 ft	32 ft	28 ft <sup>(10)</sup>	32 ft	32 ft
Minimum Width for Replacement	Full Design Level Applies <sup>(11)</sup>					
Access Control	See Chapter 1420 and the Master Plan for Limited Access Highways, or WAC 468-52 and the region's Highway Management Classification Report.					

(1) If current ADT is approaching a borderline condition, consider designing for the higher classification.

(2) See Figures 430-5 and 430-6 for turning roadways.

(3) Parking restriction recommended when ADT exceeds 7,500.

(4) For lanes 11 ft or more in width, the minimum shy distance from the edge of traveled way to the face of the curb is 2 ft. However, for noncontinuous curbs or where bicycles are anticipated, the minimum shy distance from the edge of traveled way to the face of the curb is 3 ft.

(5) For design speeds of 50 mph or less on roads of 2,000 ADT or less, width may be reduced by 1 ft, with justification.

(6) Use these widths when a bridge within the project limits requires deck treatment or thrie beam retrofit only.

(7) Width is the clear distance between curbs or rails, whichever is less.

(8) 20 ft when ADT 250 or less.

(9) Use these widths when a bridge within the project limits requires any work beyond the treatment of the deck such as bridge rail replacement, deck replacement, or widening.

(10) 26 when ADT 250 or less.

(11) Modified design level lane and shoulder widths may be used when justified with a corridor or project analysis.

## Modified Design Level for Two-Lane Highways and Bridges

Figure 430-4

Radius of Center Line R (ft)	Minimum Total Roadway Width W (ft)	Minimum Lane Width L (ft)
Tangent	26	11
900	26	11
800	27	12
700	27	12
600	28	12
500	28	12
400	29	12
350	30	12
300	31	12
250	33	13
200	35	13
150	39	13

Notes: Also see minimums from Figure 430-4.

If the minimum total roadway width is greater than the sum of the shoulders and lane widths, apply the extra width to the inside of the curve.

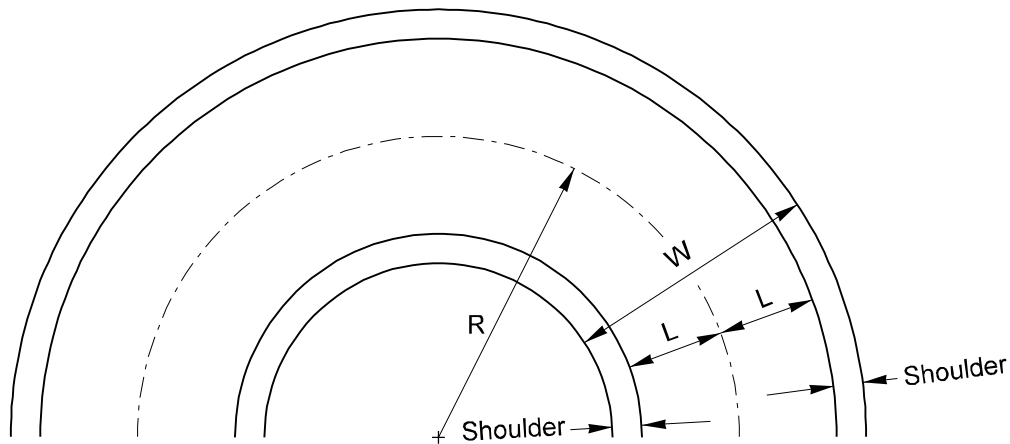

**Minimum Total Roadway Widths for Two-Lane Highway Curves  
Modified Design Level**

*Figure 430-5*

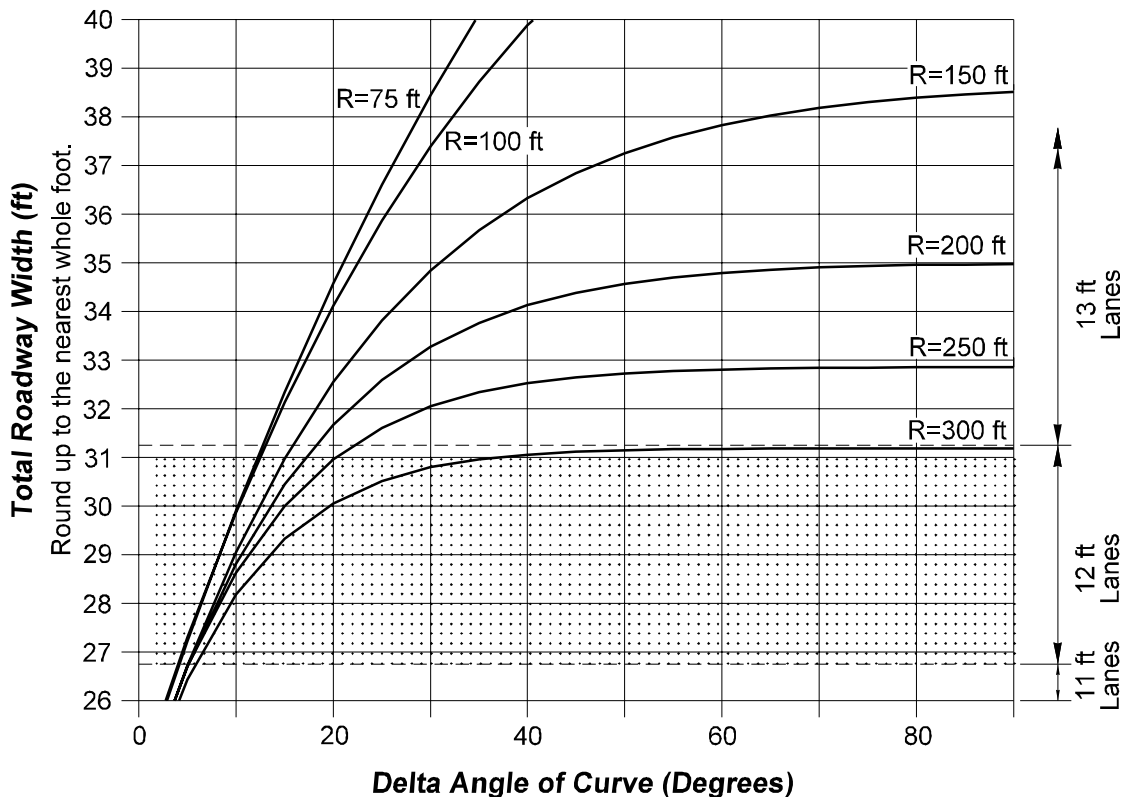

If result is less than the total roadway width from Figure 430 - 4, use the greater.

**Minimum Total Roadway Widths for Two-Lane Highway Curves,  $D < 90^\circ$**   
**Modified Design Level**  
*Figure 430-6*

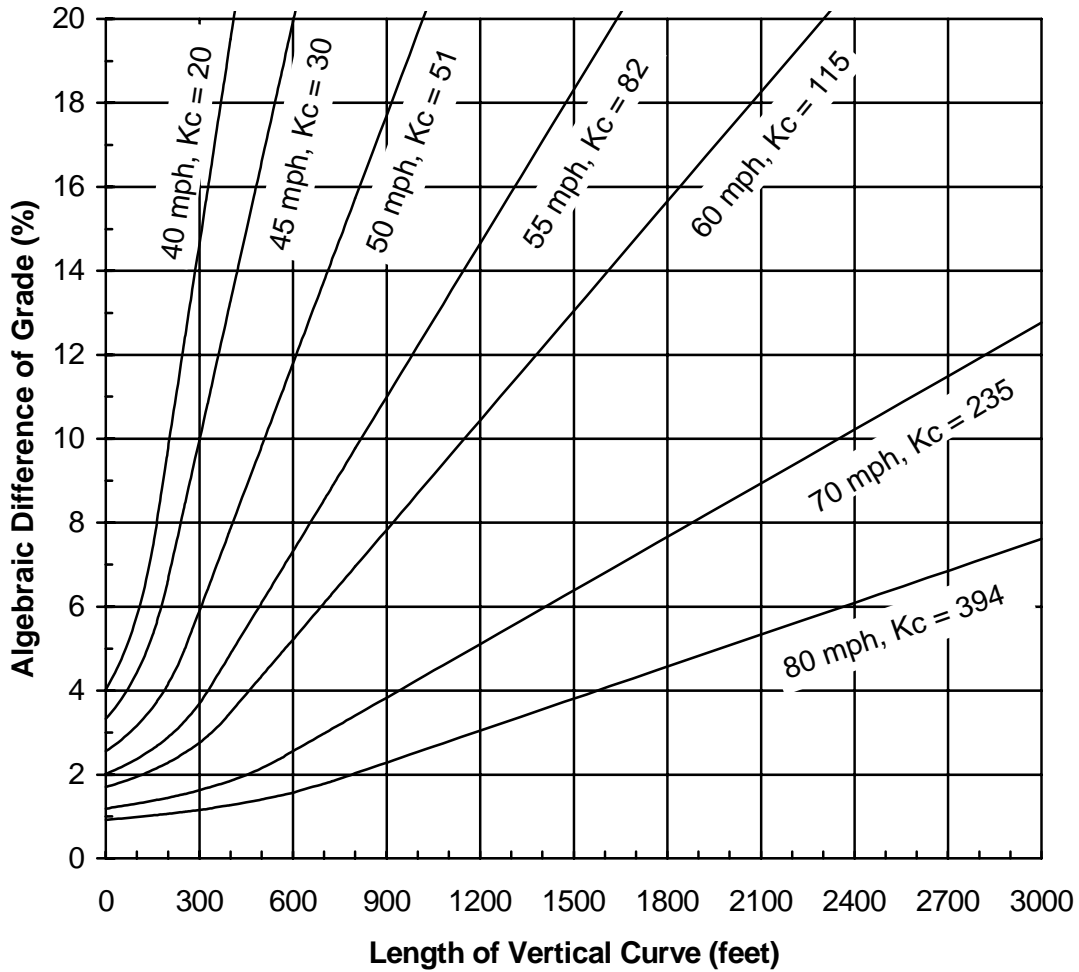

When the intersection of the algebraic difference of grade with the length of vertical curve is above the selected design speed line, corrective action must be considered.

$K_c$  see Chapter 650

**Evaluation for Stopping Sight Distance for Crest Vertical Curves  
Modified Design Level**

*Figure 430-7*



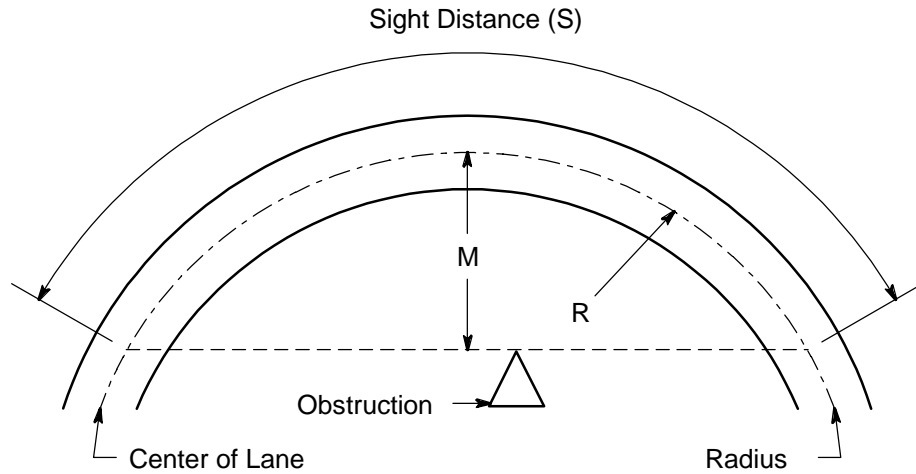

M is the distance in feet from the center line of the inside lane to the obstruction. Obstruction is a cut slope or other object 2 ft or more above the inside lane.

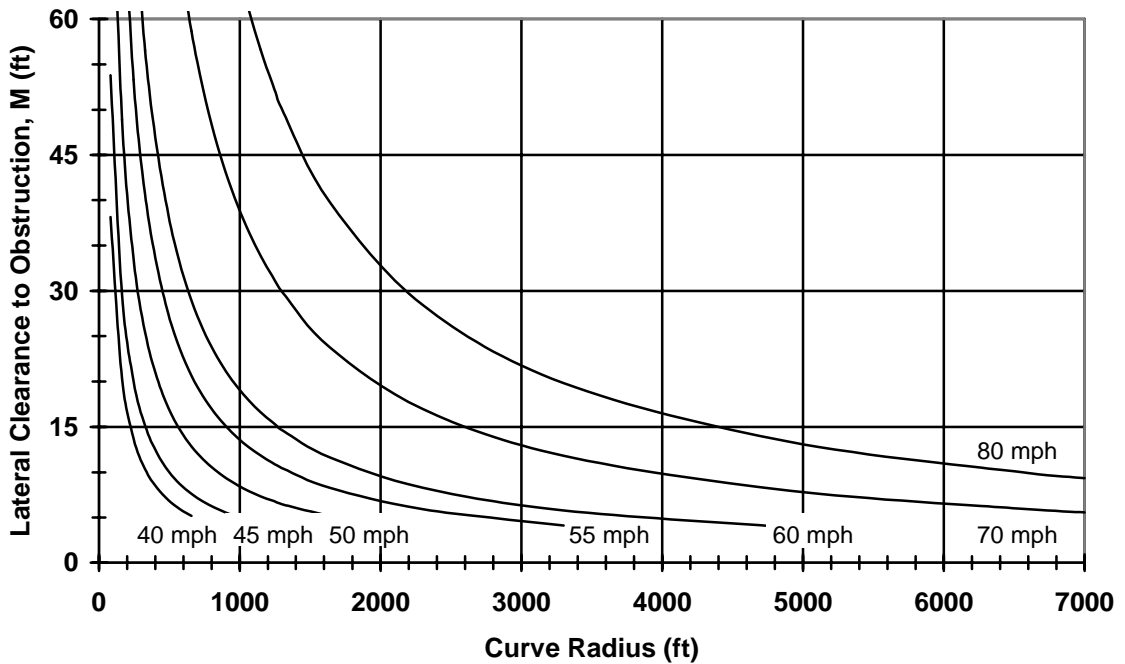

When the intersection of the lateral clearance (M) with the curve radius (R) falls below the curve for the selected design speed, corrective action must be considered.

**Evaluation for Stopping Sight Distance for Horizontal Curves  
Modified Design Level**  
*Figure 430-8*

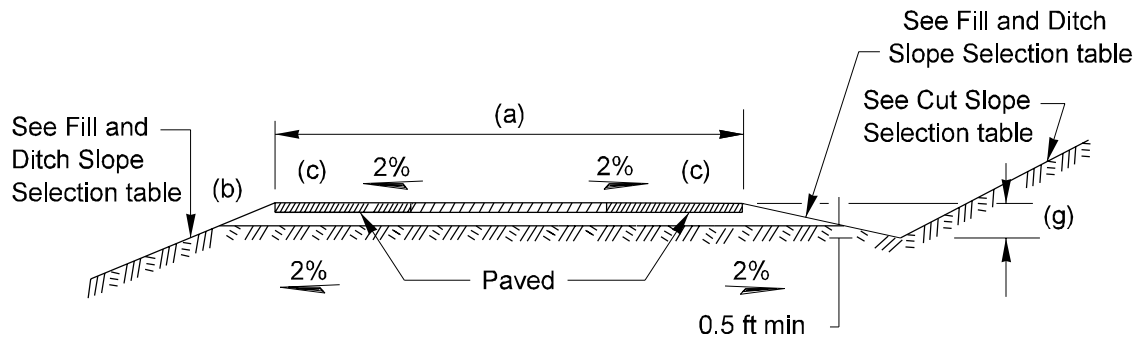

**Notes:**

Height of Cut (ft)	Slope not Steeper than (d)
0 - 5	4H:1V
5 - 20	3H:1V
over 20	2H:1V

Cut Slope Selection

Height of Fill/Depth of Ditch (ft)	Slope not Steeper than
0 - 20	4H:1V
20- 30	3H:1V
over 30	2H:1V <sup>(e)</sup>

Fill and Ditch Slope Selection

- (a) See Figures 430-3 and 4 for minimum roadway widths and Figures 430-5 and 6 for turning roadway widths.
- (b) Widen and round embankments steeper than 4H:1V
- (c) See Chapter 640 for shoulder slope requirements.
- (d) Or as recommended by the soils or geotechnical report. Refer to Chapter 700 and 710 for clear zone and barrier requirements.
- (e) Consider flatter slopes for the greater fill heights and ditch depths where practical.
- (f) Fill slopes up to 1 1/2H:1V may be used where favorable soil conditions exist. Refer to Chapter 640 for additional details and Chapter 700 and 710 for clear zone and barrier requirements.
- (g) Minimum ditch depth is 2 ft for design speeds over 40 mph or 1.5 ft for design speeds 40 mph or less.

**Main Line Roadway Sections  
Modified Design Level  
Figure 430-9**

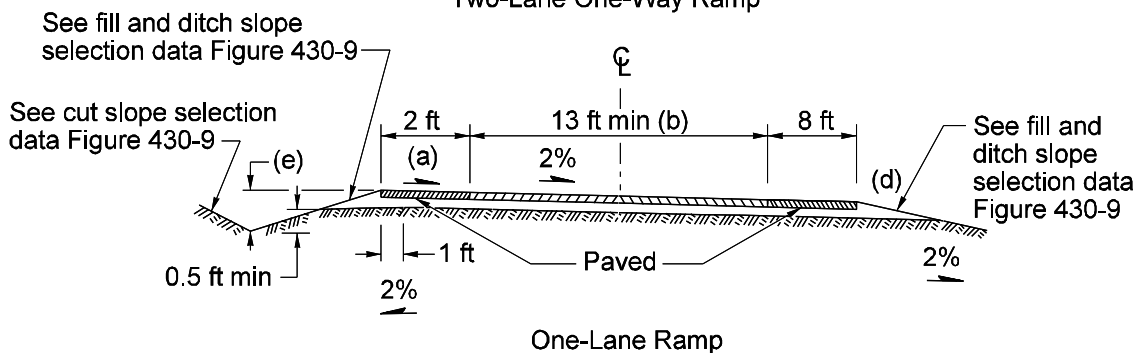
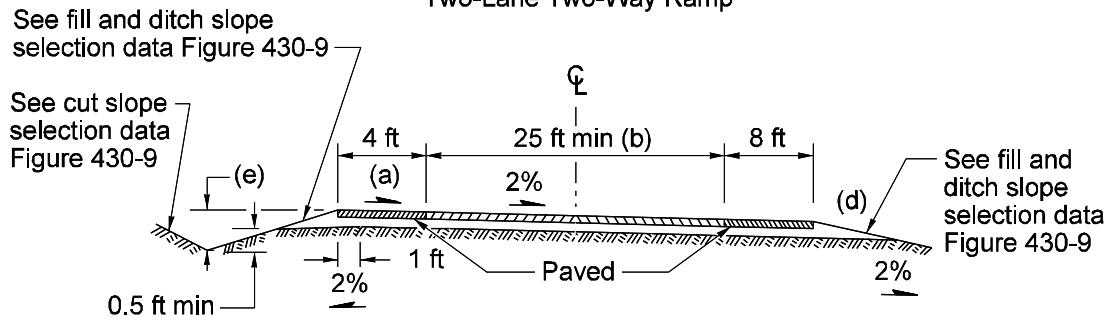
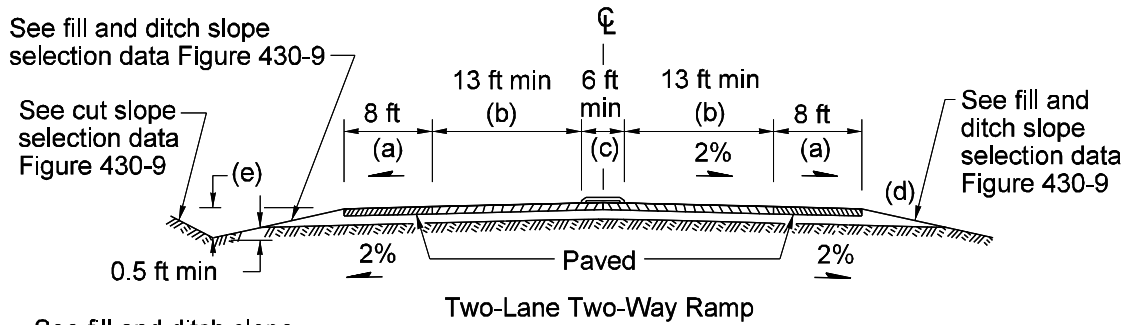

- (a) See Chapter 640 for shoulder slope requirements.
- (b) See text 430.04 for minimum ramp width.
- (c) The median width of a two-lane, two-way ramp shall not be less than that required for traffic control devices and their required shy distances.
- (d) Widen and round embankments steeper than 4H : 1V.
- (e) Minimum ditch depth is 2 ft for design speeds over 40 mph and 1.5 ft for design speeds at and under 40 mph.

**Ramp Roadway Sections**  
**Modified Design Level**  
*Figure 430-10*

440.01	General
440.02	References
440.03	Definitions
440.04	Functional Classification
440.05	Terrain Classification
440.06	Geometric Design Data
440.07	Design Speed
440.08	Traffic Lanes
440.09	Shoulders
440.10	Medians
440.11	Parking
440.12	Pavement Type
440.13	Structure Width
440.14	Grades

### 440.01 General

Full design level is the highest level of design standards and is used on new and reconstructed highways. These projects are designed to provide optimum mobility, safety, and efficiency of traffic movement. The overall objective is to move the greatest number of vehicles, at the highest allowable speed, and at optimum safety. Major design controls are functional classification, terrain classification, urban or rural surroundings, traffic volume, traffic character and composition, design speed, and access control.

### 440.02 References

*Revised Code of Washington (RCW) 47.05.021, Functional classification of highways.*

*Revised Code of Washington (RCW) 47.24, City Streets as Part of State Highways*

*Washington Administrative Code (WAC) 468-18-040), "Design standards for rearranged county roads, frontage roads, access roads, intersections, ramps and crossings"*

*Standard Plans for Road, Bridge, and Municipal Construction (Standard Plans), M 21-01, WSDOT*

*Standard Specifications for Road, Bridge, and Municipal Construction (Standard Specifications), M 41-10, WSDOT.*

*Plans Preparation Manual, WSDOT, M 22-31*

*Local Agency Guidelines (LAG), M 36-63, WSDOT*

*A Policy on Geometric Design of Highways and Streets (Green Book), 1994, AASHTO*

*A Policy on Design Standards - Interstate System, 1991, AASHTO*

### 440.03 Definitions

**auxiliary lane** The portion of the roadway adjoining the through lanes for parking, speed change, turning, storage for turning, weaving, truck climbing, and other purposes supplementary to through-traffic movement.

**bikeway** Any trail, path, part of a highway or shoulder, sidewalk, or any other traveled way specifically signed and/or marked for bicycle travel.

**collector system** Routes that primarily serve the more important intercounty, intracounty, and intraurban travel corridors, collect traffic from the system of local access roads and convey it to the arterial system, and on which, regardless of traffic volume, the predominant travel distances are shorter than on arterial routes (RCW 47.05.021).

**functional classification** The grouping of streets and highways according to the character of the service they are intended to provide.

**high pavement type** Portland cement concrete pavement or asphalt cement concrete pavement on treated base.

**intermediate pavement type** Asphalt cement concrete pavement on an untreated base.

**Interstate System** A network of routes selected by the state and the FHWA under terms of the federal aid acts as being the most important to the development of a national system. The Interstate System is part of the principal arterial system.

**lane** A strip of roadway used for a single line of vehicles.

**lane width** The lateral design width for a single lane, striped as shown in the Standard Plans and Standard Specifications. The width of an existing lane is measured from the edge of traveled way to the center of the lane line or between the centers of successive lane lines.

**low pavement type** Bituminous surface treatment.

**median** The portion of a divided highway separating the traveled ways for traffic in opposite directions.

**minor arterial system** A rural network of arterial routes linking cities and other activity centers that generate long distance travel and, with appropriate extensions into and through urban areas, form an integrated network providing interstate and interregional service (RCW 47.05.021).

**National Highway System (NHS)** An interconnected system of principal arterial routes that serves interstate and interregional travel; meets national defense requirements; and serves major population centers, international border crossings, ports, airports, public transportation facilities, other intermodal transportation facilities, and other major travel destinations. The Interstate System is a part of the NHS.

**outer separation** The area between the outside edge of traveled way for through traffic and the nearest edge of traveled way of a frontage road.

**principal arterial system** A connected network of rural arterial routes with appropriate extensions into and through urban areas, including all routes designated as part of the Interstate System, that serve corridor movements having travel characteristics indicative of substantial statewide and interstate travel (RCW 47.05.021).

**roadway** The portion of a highway, including shoulders, for vehicular use. A divided highway has two or more roadways.

**shoulder** The portion of the roadway contiguous with the traveled way, primarily for accommodation of stopped vehicles, emergency use, lateral support of the traveled way, and use by pedestrians and bicycles.

**shoulder width** The lateral width of the shoulder, measured from the outside edge of the outside lane to the edge of the roadway.

**traveled way** The portion of the roadway intended for the movement of vehicles, exclusive of shoulders and lanes for parking, turning, and storage for turning.

**usable shoulder** The width of the shoulder that can be used by a vehicle for stopping.

#### **440.04 Functional Classification**

As provided in RCW 47.05.021, the state highway system is divided and classified according to the character and volume of traffic carried by the routes and distinguished by specific geometric design standards. The functional classifications used on highways, from highest to lowest classification, are Interstate, principal arterial, minor arterial, and collector. The higher functional classes give more priority to through traffic and less to local access.

The criteria used in making the functional classification consider the following:

- Urban population centers within and without the state stratified and ranked according to size
- Important traffic generating economic activities, including but not limited to recreation, agriculture, government, business, and industry
- Feasibility of the route, including availability of alternate routes within and without the state
- Directness of travel and distance between points of economic importance
- Length of trips
- Character and volume of traffic
- Preferential consideration for multiple service which shall include public transportation
- Reasonable spacing depending upon population density
- System continuity

## 440.05 Terrain Classification

To provide a general basis of reference between terrain and geometric design, three classifications of terrain have been established.

**Level.** Level to moderately rolling. This terrain offers few or no obstacles to the construction of a highway having continuously unrestricted horizontal and vertical alignment.

**Rolling.** Hills and foothills. Slopes rise and fall gently but occasional steep slopes might offer some restriction to horizontal and vertical alignment.

**Mountainous.** Rugged foothills, high steep drainage divides, and mountain ranges.

Terrain classification pertains to the general character of the specific route corridor. Roads in valleys or passes of mountainous areas might have all the characteristics of roads traversing level or rolling terrain and are usually classified as level or rolling rather than mountainous.

## 440.06 Geometric Design Data

### (1) State Highway System

For all projects designed to full design level, use the geometric design data in Figures 440-3 through 6b.

### (2) State Highways as City Streets

When a state highway within an urban area is coincident with and is a portion of a local agency roadway, develop the design features in cooperation with the local agency. For facilities on the NHS, use the design criteria in this manual for the functional class of the route as the minimum standards. For facilities not on the NHS, the *Local Agency Guidelines* may be used as minimum design criteria; however, the use of WSDOT standards is encouraged where feasible.

### (3) City Streets and County Roads

Plan and design facilities that cities or counties will be requested to accept as city streets or county roads according to the applicable standards shown in:

- WAC 468-18-040.
- *Local Agency Guidelines*.
- The standards of the local agency that will be requested to accept the facility.

## 440.07 Design Speed

Design speed is the maximum safe speed that can be maintained over a specified section of highway when conditions are so favorable that the design features of the highway govern the maximum safe speed.

Vertical and horizontal alignment, sight distance, and superelevation will vary appreciably with design speed. Such features as traveled way width, shoulder width, and lateral clearances are usually not affected. See Chapters 620, 630, 640, and 650 for the relationships between design speed, geometric plan elements, geometric profile elements, superelevation, and sight distance.

The choice of a design speed is influenced principally by functional classification, posted speed, terrain classification, traffic volumes, accident history, access control, and economic factors. However, a geometric design that adequately allows for future improvement is the major criterion, rather than strictly economics. Categorizing a highway by a terrain classification often results in arbitrary reductions of the design speed when, in fact, the terrain would allow a higher design speed without materially affecting the cost of construction. Savings in vehicle operation and other costs alone might be sufficient to offset the increased cost of right of way and construction.

It is important to consider the geometric conditions of adjacent sections. Maintain a uniform design speed for a significant segment of highway.

Select a design speed that is as high as practical within the range given in Figures 3, 4a, 5a, and 6a. The desirable design speed is dependent on the posted speed. Figure 440-1 provides guidance for selecting the desirable design speed.

Posted Speed	Desirable Design Speed
35 mph or less	Not less than the posted speed.
40 mph to 50 mph	5 mph over the posted speed
55 mph or higher	10 mph over the posted speed

### Desirable Design Speed

*Figure 440-1*

Select a design speed for urban arterial streets and highways with some access control and fairly long distances between intersections as discussed above. However, highway arterials that have obvious “street-like” characteristics, operationally and physically, do not require a design speed determination. In such instances, closely spaced intersections and other operational constraints usually limit vehicular speeds, negating the design speed factor.

### 440.08 Traffic Lanes

Lane width and condition has a great influence on safety and comfort. The added cost for wider lanes is offset, to some extent, by the reduction in shoulder maintenance cost due to the lessening of wheel load concentrations at the edge of the lane.

Lanes 12 ft wide provide desirable clearance between large vehicles where traffic volumes are high and a high number of large vehicles are expected.

Highway capacity is also affected by the width of the lanes. With narrow lanes, drivers must operate their vehicles closer (laterally) to each other than they normally desire. To compensate for this, drivers reduce their speed and increase the headway, resulting in reduced capacity.

Figures 440-3 through 440-6b give the minimum lane width for the various design classes. See Chapter 640 for guidance on width requirements on turning roadways.

### 440.09 Shoulders

The shoulder width is controlled by the functional classification of the roadway, the traffic volume, and the function the shoulder is to serve.

The more important shoulder functions are to:

- (1) Provide space for:
  - Stopping out of the traffic lanes
  - Escaping potential accidents or to reduce their severity
  - Lateral clearance to roadside objects, such as guardrail (see Chapters 700 and 710)
  - Pedestrian and bicycle use (see Chapter 640)
  - Large vehicle off tracking on curves (see Chapter 640)
  - Maintenance operations
  - Law enforcement
  - Bus stops (see Chapter 1060)
  - Slow vehicles turnouts and shoulder driving (see Chapter 1010)
  - Ferry holding lanes
  - A sense of openness contributing to driver ease and freedom from strain
  - For use as a lane during reconstruction of the through lanes

- (2) Provide structural support for the traveled way

- (3) Improve sight distance in cut sections (see Chapter 650)

- (4) Improve capacity

- (5) Reduce seepage adjacent to the traveled way by discharging storm water farther away

For minimum overall shoulder widths based on functional classification and traffic volume, see Figures 440-3 through 6b.

Guidance and width requirements for the shoulder functions with chapter references is in those chapters. Figure 440-2 gives minimum

overall and usable shoulder widths for other functions. For the remaining functions listed, the benefits vary with the width of the shoulder.

The width of shoulder required for maintenance operations depends on the operation performed and the equipment needed. To be able to park a maintenance truck out of the through lane, 10 ft usable width is needed. For equipment with outriggers, such as used to service luminaires and repair guardrail, a width of 12 ft is required or a lane will need to be closed while the equipment is working. Contact the region maintenance office to determine the shoulder width for maintenance operations. When shoulder widths wider than called for in Figures 440-3 through 6b are requested, compare the added cost of the wider shoulders to the added benefits to maintenance operations and other benefits that may be derived. When the maintenance office requests a shoulder width different than for the design class, justify the width selected.

Shoulder Function	Minimum Shoulder Width
Minimum lateral clearance and structural support	2 ft
Pedestrian or bicycle use	4 ft <sup>(1)</sup>
Stopping out of the traffic lanes	6 ft <sup>(2)</sup>
Law enforcement and Ferry holding	6 ft <sup>(3)</sup>
<p>(1) Minimum when pedestrians or bicycles are considered, see Chapter 1020 for additional information</p> <p>(2) Minimum usable shoulder width.</p> <p>(3) Minimum usable shoulder width, 10 ft preferred. See Chapters 1040 and 1050 for additional information on enforcement areas.</p>	

**Minimum Shoulder Width**

*Figure 440-2*

When vertical features (such as traffic barrier, walls, or curbs) are at the edge of the shoulder, add shy distance to the usable shoulder to obtain the overall shoulder width for the shoulder function. A distance of 2 ft is normally used for the shy distance. See Chapter 710 for the required widening at traffic barrier, see Chapter 910 for shy distances at curbs.

Provide a minimum clearance to roadside objects so that the shoulders do not require narrowing. At existing bridge piers and abutments, shoulders less than full width to a minimum of 2 ft shy may be used with design exception documentation. See Chapter 700 for design clear zone and safety treatment requirements.

Shoulder widths greater than 10 ft may encourage use as a travel lane. Therefore, use shoulders wider than this only where required to meet one of the listed functions. See Chapter 1010 when shoulder driving is to be allowed.

#### **440.10 Medians**

The primary functions of a median are to:

- Separate opposing traffic
- Provide for recovery of out-of-control vehicles
- Reduce head-on accidents
- Provide an area for emergency parking
- Allow space for left turn lanes
- Minimize headlight glare
- Allow for future widening

For maximum efficiency, make medians highly visible both night and day. Medians may be depressed, raised, or flush with the through lanes.

The width of a median is measured from edge of traveled way to edge of traveled way and includes the shoulders. The minimum median width for each design class is given in Figures 440-3 through 440-6b. When selecting a median width, consider future needs such as wider left shoulders when widening from four to six lanes.

See Chapter 700 for barrier requirements and Chapter 910 for left-turn lane design.



## **440.11 Parking**

In urban areas and rural communities, land use might require parking along the highway. In general, on-street parking decreases capacity, increases accidents, and impedes traffic flow. Therefore, it is desirable to prohibit parking.

Although design data for parking lanes are included on Figures 440-4a through 6b, consider them only in cooperation with the municipality involved. The lane widths given are the minimum for parking.

## **440.12 Pavement Type**

The pavement types given in Figures 440-3 through 6a are the recommended for each design class. Submit Form 223-528, Pavement Type Determination to the OSC Materials Laboratory for a final determination of the pavement type to use. When a roadway is to be widened and the existing pavement will remain, the new pavement type may be the same as the existing without a pavement type determination.

## **440.13 Structure Width**

Provide a clear width between curbs on a bridge equal to the approach roadway width (lanes plus shoulders). The structure widths given in Figures 440-3 through 6a are the minimum bridge width for each design class.

Shy distance is not normally added to the roadway width for the bridge width. When a bridge is in a run of roadside barrier, consider adding the shy distance on shorter bridges to prevent narrowing the roadway.

## **440.14 Grades**

Grades can have a pronounced effect on the operating characteristics of the vehicles negotiating them. Generally, passenger cars can readily negotiate grades as steep as 5% without appreciable loss of speed from that maintained on level highways. Trucks, however, travel at the average speed of passenger cars on the level but display up to a 5% increase in speed on downgrades and a 7% or more decrease in speed on upgrades (depending on length and steepness of the grade as well as weight to horsepower ratio).

The maximum grades for the various functional classes and terrain conditions are shown in Figures 440-3 through 6a. For the effects of these grades on the design of a roadway see Chapters 630 and 1010.

<b>Design Class</b>	<b>Divided Multilane</b> I-1		
<b>Design Year</b>	(1)		
<b>Access Control</b> <sup>(2)</sup>	Full		
<b>Separate Cross Traffic</b> Highways Railroads	All All		
<b>Design Speed</b> (mph) Rural Urban	80 <sup>(3)</sup> 70 <sup>(4)</sup>		
<b>Traffic Lanes</b> Number Width (ft)	4 or more divided 12		
<b>Median Width</b> (ft)	4 lane	6 lanes or more	
Rural —Minimum <sup>(5)</sup> Urban —Minimum	40 16	50 22	
<b>Shoulder Width</b> (ft) Right of Traffic Left of Traffic	10 4	10 10 <sup>(6)</sup>	
<b>Pavement Type</b> <sup>(7)</sup>	High		
<b>Right of Way</b> <sup>(8)</sup> Rural —Minimum Width (ft) Urban —Minimum Width (ft)	63 from edge of traveled way As required <sup>(9)</sup>		
<b>Structures</b> Width <sup>(10)</sup> (ft)	Full roadway width each direction <sup>(11)</sup>		

<b>Grades (%)</b> <sup>(12)</sup>				
Type of Terrain	Design Speed (mph)			
	50	60	70	80
Level	4	3	3	3
Rolling	5	4	4	4
Mountainous	6	6	5	5

**Interstate Notes:**

- 1 The design year is 20 years after the year the construction is scheduled to begin.
- 2 See Chapter 1420 for access control requirements.
- 3 80 mph is the desirable design speed, with justification the design speed may be reduced to 60 mph in mountainous terrain and 70 mph in rolling terrain.
- 4 70 mph is the desirable design speed, with justification, the design speed may be lowered to 50 mph.
- 5 Independent alignment and grade is desirable in all rural areas and where terrain and development permits in urban areas.
- 6 For existing 6-lane roadways, existing 6 ft left shoulders may remain when no other widening is required.
- 7 Submit Form 223-528, Pavement Type Determination.
- 8 Provide right of way width 10 ft desirable, 5 ft minimum, wider than the slope stake for fill and slope treatment for cut. See Chapter 640 and the Standard Plans for slope treatment information.
- 9 In urban areas, make right of way widths not less than those required for necessary cross section elements.
- 10 See Chapter 1120 for minimum vertical clearance.
- 11 For median widths 26 ft or less, address bridge(s) in accordance with Chapter 1120.
- 12 Grades 1% steeper may be used in urban areas where development precludes the use of flatter grades and for one-way down grades except in mountainous terrain.

**Geometric Design Data, Interstate**  
*Figure 440-3*

Design Class	Divided Multilane				Two-Lane						Undivided Multilane	
	P-1		P-2		P-3		P-4		P-5		P-6 <sup>(1)</sup>	
	Rural	Urban	Rural	Urban	Rural	Urban	Rural	Urban	Rural	Urban	Rural	Urban
<b>DHV in Design Year</b> <sup>(2)</sup> NHS Non NHS	Over 1,500		Over 701		201-700 <sup>(3)</sup> 301-700		61-200 <sup>(4)</sup> 101-300		60 and under 100 and Under		Over 701	
<b>Access Control</b> <sup>(5)</sup>	Full		Partial		Partial		Partial or None		None		Special Cases	
<b>Separate Cross Traffic</b> Highways Railroads	All All		Where Justified All		Where Justified All <sup>(6)</sup>		Where Justified Where Justified <sup>(7)</sup>		Where Justified Where Justified <sup>(7)</sup>		Where Justified Where Justified <sup>(7)</sup>	
<b>Design Speed Range (mph)</b> <sup>(8)</sup>	70 50		70 50		70 50	60 40	70 50	60 40	60 40	60 30	70 40	60 30
<b>Traffic Lanes</b> Number Width (ft)	4 or more divided 12		4 or 6 divided 12		2 12		2 12		2 12		4 12	4 or 6 11 <sup>(9)</sup>
<b>Shoulder Width (ft)</b> Right of Traffic Left of Traffic	10 Variable <sup>(10)</sup>		10 Variable <sup>(10)</sup>		8		6		4		8	8 <sup>(11)</sup>
<b>Median Width (ft)</b> 4 lane 6 or more lanes	40 <sup>(12)</sup> 48 <sup>(12)</sup>	16 22	60 60	16 22							4 4	2 <sup>(13)</sup> 2 <sup>(13)</sup>
<b>Parking Lanes Width (ft) — Minimum</b>	None		None		None		None	10	None	10	None	10 <sup>(14)</sup>
<b>Pavement Type</b> <sup>(15)</sup>	High				High or intermediate							
<b>Right of Way</b> <sup>(16)</sup> — Min Width (ft)	(17)	(18)	(17)	(18)	120	80	120	80	100	80	150	80
<b>Structures Width (ft)</b> <sup>(19)</sup>	Full roadway width <sup>(20)</sup>				40		36		32		Full roadway width	
<b>Other Design Considerations-Urban</b>					(21)		(21)		(21)		(21)	

Grades (%) <sup>(22)</sup>									
Type of Terrain	Rural — Design Speed (mph)					Urban — Design Speed (mph)			
	40	50	60	70	80	30	40	50	60
Level	5	4	3	3	3	8	7	6	5
Rolling	6	5	4	4	4	9	8	7	6
Mountainous	8	7	6	5	5	11	10	9	8

Geometric Design Data, Principal Arterial  
Figure 440-4a

### Principal Arterial Notes:

- 1 Justify the selection of a P-6 standard.
- 2 The design year is 20 years after the year the construction is scheduled to begin.
- 3 Where DHV exceeds 700, provide four lanes. For lower volumes, when the volume/capacity ratio is equal to or exceeds 0.75, consider the needs for a future four-lane facility. When considering truck climbing lanes on a P-3 design class highway, perform an investigation to determine if a P-2 design class highway is justified.
- 4 When considering a multilane highway, perform an investigation to determine if a truck climbing lane will satisfy the need.
- 5 See Chapter 1420 for access control requirements.
- 6 All main line and major-spur railroad tracks will be separated. Consider allowing at-grade crossings at minor-spur railroad tracks.
- 7 Criteria for railroad grade separations are not clearly definable. Evaluate each site regarding the hazard potential. Provide justification for railroad grade separations.
- 8 The preferred design speed is within the range. Design speeds above the range may be selected, with justification. The lower end of the range is the minimum design speed for the design class.
- 9 12-ft lanes are required when the truck DHV is 6% or greater.
- 10 Minimum left shoulder width is to be as follows: four lanes — 4 ft; six or more lanes — 10 ft. For 6-lane roadways, existing 6 ft left shoulders may remain when no other widening is required.
- 11 When curb section is used, a 6 ft shoulder outside the face of curb is acceptable. See Chapter 910 for shy distances at curbs.
- 12 On freeways or expressways requiring less than eight lanes within the 20-year design period, provide sufficient median or lateral clearance and right of way to permit addition of a lane in each direction if required by traffic increase after the 20-year period.
- 13 When signing is required in the median of a six-lane section, the minimum width is 6 ft. If barrier is to be installed at a future date, a 8 ft minimum median is required.
- 14 Parking restricted when ADT is over 15,000.
- 15 Submit Form 223-528, Pavement Type Determination.
- 16 Provide right of way width 10 ft desirable, 5 ft minimum, wider than the slope stake for fill and slope treatment for cut. See Chapter 640 and the Standard Plans for slope treatment information.
- 17 63 ft from edge of traveled way.
- 18 Make right of way widths not less than those required for necessary cross section elements.
- 19 See Chapter 1120 for the minimum vertical clearance.
- 20 For median widths 26 ft or less, address bridges in accordance with Chapter 1120.
- 21 For pedestrian, bicycle, and sidewalk requirements see Chapter 1020. Curb requirements are in Chapter 910. Lateral clearances from the face of curb to obstruction are in Chapter 700.
- 22 Except in mountainous terrain, grades 1% steeper may be used in urban areas where development precludes the use of flatter grades or for one-way downgrades.

### Geometric Design Data, Principal Arterial

Figure 440-4b

Design Class	Divided Multilane		Two-Lane						Undivided Multilane	
	M-1		M-2		M-3		M-4		M-5 <sup>(1)</sup>	
	Rural	Urban	Rural	Urban	Rural	Urban	Rural	Urban	Rural	Urban
DHV in Design Year <sup>(2)</sup> NHS Non NHS	Over 701		201-700 <sup>(3)</sup> 401-700		61-200 <sup>(4)</sup> 201-400		60 and Under 200 and Under		Over 701	
Access Control <sup>(5)</sup>	Partial		Partial		Partial or None		None		Special Cases	
Separate Cross Traffic Highways Railroads	Where Warranted All		Where Warranted All <sup>(6)</sup>		Where Warranted Where Warranted <sup>(7)</sup>		Where Warranted Where Warranted <sup>(7)</sup>		Where Warranted Where Warranted <sup>(7)</sup>	
Design Speed Range (mph) <sup>(8)</sup>	70 50		70 50	60 40	70 50	60 40	60 40	60 30	70 40	60 30
Traffic Lanes Number Width (ft)	4 or 6 divided 12		2 12		2 12		2 12		4 12	4 or 6 11 <sup>(9)</sup>
Shoulder Width (ft) Right of Traffic Left of Traffic	10 Variable <sup>(10)</sup>		8		6		4		8	8 <sup>(11)</sup>
Median Width (ft) 4 lane 6 lane	60 60	16 22							4	2 <sup>(12)</sup>
Parking Lanes Width (ft) — Minimum	None		None		None	10	None	10	None	10 <sup>(13)</sup>
Pavement Type <sup>(14)</sup>	High		As required						High or Intermediate	
Right of Way <sup>(15)</sup> — Min Width (ft)	(16)	(17)	120	80	120	80	100	80	150	80
Structures (ft) <sup>(18)</sup>	Full Roadway Width <sup>(19)</sup>		40		36		32		Full Roadway Width	
Other Design Considerations-Urban			(20)		(20)		(20)		(20)	

Grades (%) <sup>(21)</sup>									
Type of Terrain	Rural — Design Speed (mph)					Urban — Design Speed (mph)			
	40	50	60	70	80	30	40	50	60
Level	5	4	3	3	3	8	7	6	5
Rolling	6	5	4	4	4	9	8	7	6
Mountainous	8	7	6	5	5	11	10	9	8

Geometric Design Data, Minor Arterial  
Figure 440-5a

### Minor Arterial Notes:

- 1 Justify the selection of an M-5 standard.
- 2 The design year is 20 years after the year the construction is scheduled to begin.
- 3 Where DHV exceeds 700, provide four lanes. For lower volumes, when the volume/capacity ratio is equal to or exceeds 0.75, consider the needs for a future four-lane facility. When considering truck climbing lanes an M-2 design class highway, perform an investigation to determine if an M-1 design class highway is justified.
- 4 When considering a multilane highway, perform an investigation to determine if a truck climbing lane will satisfy the need.
- 5 See Chapter 1420 for access control requirements.
- 6 All main line and major-spur railroad tracks will be separated. Consider allowing at-grade crossings at minor-spur railroad tracks.
- 7 Criteria for railroad grade separations are not clearly definable. Evaluate each site regarding the hazard potential. Provide justification for railroad grade separations.
- 8 The preferred design speed is within the range. Design speeds above the range may be selected, with justification. The lower end of the range is the minimum design speed for the design class.
- 9 When the truck DHV is 6% or greater, consider 12 ft lanes.
- 10 The minimum left shoulder width is 4 ft for four lanes and 10 ft for six or more lanes. For 6-lane roadways, existing 6 ft left shoulders may remain when no other widening is required.
- 11 When curb section is used, a 6 ft shoulder outside the face of curb is acceptable. See Chapter 910 for shy distances at curbs.
- 12 When signing is required in the median of a six-lane section, the minimum width is 6 ft. If barrier is to be installed at a future date, a 8 ft minimum median is required.
- 13 Parking restricted when ADT is over 15,000.
- 14 Submit Form 223-528, Pavement Type Determination.
- 15 Provide right of way width 10 ft desirable, 5 ft minimum, wider than the slope stake for fill and slope treatment for cut. See Chapter 640 and the Standard Plans for slope treatment information.
- 16 63 ft from edge of traveled way
- 17 Make right of way widths not less than those required for necessary cross section elements.
- 18 See Chapter 1120 for the minimum vertical clearance.
- 19 For median widths 26 ft or less, address bridges in accordance with Chapter 1120.
- 20 For pedestrian, bicycle, and sidewalk requirements see Chapter 1020. Curb requirements are in Chapter 910. Lateral clearance from the face of curb to obstruction are in Chapter 700.
- 21 Except in mountainous terrain, grades 1% steeper may be used in urban areas where development precludes the use of flatter grades or for one-way downgrades.

### Geometric Design Data, Minor Arterial

Figure 440-5b

Design Class	Undivided Multilane		Two-Lane					
	C-1		C-2		C-3		C-4	
	Rural	Urban	Rural	Urban	Rural	Urban	Rural	Urban
DHV in Design Year <sup>(1)</sup> NHS Non NHS	Over 901		301-900 <sup>(2)</sup> 501-900		201-300 <sup>(3)</sup> 301-500		200 and under 300 and Under	
Access Control	(4)							
Separate Cross Traffic Highways Railroads	Where Warranted Where Warranted <sup>(5)</sup>		Where Warranted All <sup>(5)</sup>		Where Warranted Where Warranted <sup>(5)</sup>		Where Warranted Where Warranted <sup>(5)</sup>	
Design Speed Range (mph) <sup>(6)</sup>	70 40	60 30	70 50	60 40	70 50	60 40	60 40	60 30
Traffic Lanes Number Width (ft)	4 12	4 or 6 11 <sup>(7)</sup>	2 12		2 12		2 12	
Shoulder Width (ft)	8	8 <sup>(8)</sup>	8		6		4	
Median Width — Minimum (ft)	4	2 <sup>(9)</sup>						
Parking Lanes Width (ft) — Minimum	None	10	None		None	10	None	10
Pavement Type <sup>(10)</sup>	High or Intermediate		As required					
Right of Way <sup>(11)</sup> (ft)	150	80	120	80	120	80	100	80
Structures Width (ft) <sup>(12)</sup>	Full Roadway Width		40		36		32	
Other Design Considerations-Urban			(13)		(13)		(13)	

Grades (%) <sup>(14)</sup>									
Type of Terrain	Rural — Design Speed (mph)					Urban — Design Speed (mph)			
	30	40	50	60	70	30	40	50	60
Level	7	7	6	5	4	9	9	7	6
Rolling	9	8	7	6	5	11	10	8	7
Mountainous	10	10	9	8	6	12	12	10	9

Geometric Design Data, Collector  
Figure 440-6a

### Collector Notes:

- 1 The design year is 20 years after the year the construction is scheduled to begin.
- 2 Where DHV exceeds 900, provide four lanes. For lower volumes, when the volume/capacity ratio is equal to or exceeds 0.85, consider the needs for a future four-lane facility. When considering truck climbing lanes on a C-2 design class highway, perform an investigation to determine if a C-1 design class highway is justified.
- 3 When considering a multilane highway, perform an investigation to determine if a truck climbing lane will satisfy the need.
- 4 See Chapter 1420 for access control requirements.
- 5 Criteria for railroad grade separations are not clearly definable. Evaluate each site regarding the hazard potential. Provide justification for railroad grade separations.
- 6 The preferred design speed is within the range. Design speeds above the range may be selected, with justification. The lower end of the range is the minimum design speed for the design class.
- 7 Consider 12 ft lanes when the truck DHV is 6% or greater.
- 8 When curb section is used, a 6 ft shoulder outside the face of curb is acceptable. See Chapter 910 for shy distances at curbs.
- 9 When signing is required in the median of a six-lane section, the minimum width is 6 ft median. If barrier is to be installed at a future date, a 8 ft minimum median is required.
- 10 Submit Form 223-528, Pavement Type Determination.
- 11 Provide right of way width 10 ft desirable, 5 ft minimum, wider than the slope stake for fill and slope treatment for cut. See Chapter 640 and the Standard Plans for slope treatment information.
- 12 See Chapter 1120 for the minimum vertical clearance.
- 13 For pedestrian, bicycle, and sidewalk requirements, see Chapter 1020. Curb requirements are in Chapter 910. Lateral clearances from the face of curb to obstruction are in with Chapter 700.
- 14 Except in mountainous terrain, grades 1% steeper may be used in urban areas where development precludes the use of flatter grades or for one-way downgrades.



510.01	General
510.02	References
510.03	Materials Sources
510.04	Geotechnical Investigation, Design, and Reporting
510.05	Use of Geotechnical Consultants
510.06	Geotechnical Work by Others
510.07	Surfacing Report
510.08	Documentation

### 510.01 General

It is the responsibility of the Washington State Department of Transportation (WSDOT) to understand the characteristics of the soil and rock materials that support or are adjacent to the transportation facility to ensure that the facility, when designed, will be adequate to safely carry the estimated traffic. It is also the responsibility of WSDOT to ensure the quality and quantity of all borrow materials used in the construction of transportation facilities.

The following information serves as guidance in the above areas. Where a project consists of a surface overlay of an existing highway, requirements as set forth in *WSDOT Pavement Guide for Design, Evaluation and Rehabilitation* are used.

To identify the extent and estimated cost for a project, it is necessary to obtain and use an adequate base data. In recognition of this need, preliminary soils investigation work begins during project definition. This allows early investigative work and provides necessary data in a timely manner for use in project definition and design. More detailed subsurface investigation follows during the project design and plan, specification, and estimate (PS&E) phases.

It is essential to get the region's Materials Engineer (RME) and the Olympia Service Center (OSC) Geotechnical Branch involved in the project design as soon as possible once the need for geotechnical work is identified. See 510.04(3) for time-estimate information. Furthermore, if major changes occur as the project is developed,

inform the RME and OSC Geotechnical Branch as soon as possible so that the geotechnical design can be adapted to the changes without significant delay to the project.

### 510.02 References

*Construction Manual*, M 41-01, WSDOT

*Hydraulics Manual*, M 23-03, WSDOT

*Plans Preparation Manual*, M 22-31, WSDOT

*Standard Plans for Road, Bridge, and Municipal Construction* (Standard Plans), M 21-01, WSDOT

*Standard Specifications for Road, Bridge, and Municipal Construction* (Standard Specifications), M 41-10, WSDOT

*WSDOT Pavement Guide for Design, Evaluation and Rehabilitation*

### 510.03 Materials Sources

#### (1) General

The region's Project Development Engineer (RPDE) determines when a materials source is needed. The region's Materials Engineer (RME) determines the best materials source for the project. (See Figure 510-1.) It is preferred that existing approved materials source sites be used when there are suitable sites available. When there are no approved sites available, the RME conducts a site investigation. The Olympia Service Center (OSC) Geotechnical Branch provides assistance upon request.

The RME selects sources for gravel base, borrow excavation and gravel borrow, crushed surfacing materials, mineral and concrete aggregates, riprap, and filler only after careful investigation of:

- The site. (Consider the adequacy of the work area.)
- The quality of the material.

- The quantity of the material. (Consider the needs of the immediate project and the needs to support future maintenance and construction work in the area.)
- Reclamation requirements.
- Aesthetic considerations.
- Economic factors.
- Ability to preserve or enhance the visual quality of the highway and local surroundings.

Once the materials source investigation and laboratory testing have been completed the RME prepares a materials source report. The materials source report summarizes the site geology, site investigation (including boring and test pit logs), source description, quality and quantity of material available, and other aspects of the materials sources that are relevant.

## **(2) Materials Source Approval**

The RME submits the materials source report to the OSC Geotechnical Branch for review and approval.

The OSC Materials Office and the OSC Design Office must approve each pit or quarry site before it is purchased, leased, or acquired on a royalty basis. Until the approval process is complete, the project cannot be advertised for bids. Local and state permits are required for materials sources. To avoid delay in advertising the project, begin the site investigations and permitting process in the early stages of project definition.

## **510.04 Geotechnical Investigation, Design, and Reporting**

### **(1) General**

A geotechnical investigation is conducted on all projects that involve significant grading quantities, unstable ground, or foundations for structures in a manner that preserves the safety of the public who use the facility, as well as preserving the economic investment by the state of Washington. Geotechnical engineering must be conducted by engineers or engineering geologists who possess adequate geotechnical training

and experience, and must be conducted in accordance with regionally or nationally accepted geotechnical practice. Where required by law, geotechnical engineering must be performed by, or under the direct supervision of, a person licensed to perform such work in the state of Washington.

### **(2) Key Contacts for Initiating Geotechnical Work**

In general, the RME functions as the clearing house for all geotechnical work, with the exception of structural projects and Washington State Ferries (WSF) projects. The RME takes the lead in conducting the geotechnical work if the geotechnical work required is such that the ground is stable and relatively firm, bedrock is not involved, and the design of the project geotechnical elements does not require specialized geotechnical design expertise. If this is not the case, the RME asks for the involvement and services of the OSC Geotechnical Branch. They respond to and provide recommendations directly to the region's project design office (or the OSC Equipment and Facilities Office in the case of Facilities projects), but always keeping the RME "in the loop."

For structural projects (bridges and tunnels, for example), the Bridge and Structures Office works directly with the OSC Geotechnical Branch.

For WSF projects, the Terminal Engineering Office works directly with the RME or the OSC Geotechnical Branch, depending on the nature of the project.

For walls and noise walls, see Chapters 1130 and 1140, respectively. For geosynthetic design, see Chapter 530.

### **(3) Scheduling Considerations for Geotechnical Work**

The region's Design Office, Bridge and Structures Office, WSF, and the Equipment and Facilities Office are responsible for identifying the potential need for geotechnical work, and requesting time and budget estimates from the RME or the OSC Geotechnical Branch, as early as practical to prevent delays to the project.

Once the geotechnical design request and the site data are received by the RME or the OSC Geotechnical Branch, it can take anywhere from two to six months, or more, to complete the geotechnical design, depending on the complexity of the project, whether or not test holes are needed, current workload, the need to give the work to consultants, and how long it takes to obtain environmental permits and rights of entry (ROE).

If a consultant must be used, the minimum time required to complete a design (for even a simple project) is typically 2.5 months.

In true emergency situations (a highway blocked by a landslide or a collapsed bridge, for example), it is possible to get geotechnical design work completed (in house or by consultants) more rapidly to at least provide a design for temporary mitigation.

Consider all of these factors when deciding how soon to initiate the geotechnical work for a project but, in general, the sooner, the better.

#### **(4) Site Data and Permits Needed to Initiate Geotechnical Work**

To initiate geotechnical work on a project during the design and PS&E phases, provide the following information:

- (a) Project description.
- (b) Plan sheets showing the following:
  - Station and location of cuts, fills, walls, bridges, retention/detention ponds, or other geotechnical features to be designed.
  - Existing utilities (as-built plans are acceptable).
  - Right of way limits.
  - Wetlands.
  - Drainage features.
  - Existing structures.
  - Other features or constraints that could affect the geotechnical design or investigation.
- (c) Electronic files, or cross sections every 50 ft to 65 ft or as appropriate, to define existing and

new ground line above and below the wall, cut, fill, and other pertinent information.

- Show stationing.
  - Show locations of existing utilities, right of way lines, wetlands, and other constraints.
  - Show locations of existing structures that might contribute load to the cut or fill.
- (d) Right of entry agreements and permits required for geotechnical investigation.
  - (e) Due date and work order number.
  - (f) Contact person.

When the alignment and any constraints as noted above are staked, the stationing on the plans and in the field must be in the same units. Physical surveys are preferred to photogrammetric surveys to ensure adequate accuracy of the site data.

Permits and agreements to be supplied by the region might include:

- HPA
- Shoreline permits
- Tribal lands and waters
- Railroad easement and right of way
- City, county or local agency use permits
- Sensitive area ordinance permits

The region's project office is also responsible for providing the stations, offsets, and elevations of test holes to the nearest 1 ft once the test holes have been drilled. Provide test hole locations using state plane coordinates as well, if available.

#### **(5) Overview of Geotechnical Design Objectives for the Various Project Stages**

(a) **Project Definition.** The project design office uses the geotechnical investigation results obtained during the project definition phase to develop the project delivery cost and schedule. Geotechnical recommendations provided for this phase will be at the conceptual/feasibility level. The investigation for this phase usually consists of a visual project walk-through and a review of the existing records, geologic maps, and so forth.

For projects of significant geotechnical scope and complexity, and if soil borings are not available at critical locations within the project, some soil borings might be drilled at this time. Potential geotechnical hazards (earthquake faults, liquefaction, landslides, rockfall, soft ground, for example) are identified during project definition, and conceptual hazard avoidance or mitigation plans are developed. Future geotechnical design services needed in terms of time and cost, including the need for special permits to perform the geotechnical exploration (critical areas ordinances), are determined at this time.

(b) **Project Design.** Once the roadway geometry is established, detailed design of cut and fill slopes, adequate to establish the right-of-way needs, is accomplished. Once approximate wall locations and heights are known, preliminary design of walls is performed to establish feasibility, primarily to establish right-of-way needs (as is true for slopes) and likely wall types. A similar level of design is applied to hydraulic structures, and to determine overall construction staging and constructibility requirements to address the geotechnical issues at the site. Conceptual and/or more detailed preliminary bridge foundation design is conducted during this phase if it was not conducted during project definition. Before the end of this phase, the geotechnical data necessary to allow future completion of the PS&E level design work is gathered (final geometric data, test hole data, and so forth.).

(c) **PS&E Development.** Final design of all geotechnical project features is accomplished. Recommendations for these designs, as well as special provisions and plan details to incorporate the geotechnical design recommendations in the PS&E, are provided in the geotechnical report. Minor geotechnical features such as signal/sign foundations and small detention/retention ponds are likely to be addressed at this stage, as the project details become clearer. Detailed recommendations for the constructibility of the project geotechnical features are also provided.

## **(6) Earthwork**

(a) **Project Definition.** The project designer contacts and meets with the RME, and the OSC Geotechnical Branch as needed, at the project site

to conduct a field review to help identify the geotechnical issues for the project.

In general, if soil/rock conditions are poor and/or large cuts or fills are anticipated, the RME requests that the OSC Geotechnical Branch participate in the field review and reporting efforts.

The designer provides a description and location of the proposed earthwork to the RME.

- For widening of existing facilities, the anticipated width, length, and location of the widening, relative to the current facility, are provided.
- For realignments, the approximate new location proposed for the facility is provided.
- Locations in terms of length can be by mile post or stations.

A brief conceptual level report is provided to the designer that summarizes the results of the investigation.

(b) **Project Design.** Geotechnical data necessary to allow completion of the PS&E level design is compiled during the design phase. This includes soils borings, testing, and final geometric data. Detailed design of cut and fill slopes can be done once the roadway geometry is established and geotechnical data is available. The purpose of this design effort is to determine the maximum stable cut or fill slope and, for fills, potential for short and long term settlement. Also, the usability of the cut materials and the type of borrow needed for the project, if any, is evaluated. Evaluate the use of soil bioengineering as an option for building steeper slopes or to prevent surface erosion. See the Chapter 1350 - Soil Bioengineering for more information.

The designer requests a geotechnical report from the RME. The site data indicated in 510.04(4), as applicable, is provided. It is important that the request for the geotechnical report be made as early in the design phase as practical. Cost and schedule requirements to generate the report are project specific and can vary widely. The time required to obtain permits and rights of entry

must be considered when establishing schedule requirements.

The RME, in conjunction with the OSC Geotechnical Branch, provides the following information as part of the geotechnical report (as applicable):

1. General description of the regional and site geology
2. Summary of the investigation
3. Boring logs
4. Laboratory tests and results
5. Soil/rock unit descriptions
6. Ground water conditions
7. Embankment design recommendations
  - The slope required for stability
  - Estimated amount and rate of settlement
  - Stability and settlement mitigation requirements
  - Construction staging requirements
  - Effects of site constraints
  - Monitoring needs
  - Material and compaction requirements
  - Subgrade preparation
8. Cut design recommendations
  - The slope required for stability
  - Stability mitigation requirements (deep seated stability and erosion)
  - Identification of seepage areas and how to mitigate them
  - Effects of site constraints
  - Monitoring requirements
  - Usability of excavated cut material, including gradation, moisture conditions and need for aeration, and shrink/swell characteristics

The recommendations include the background regarding analysis approach and any agreements

with the region or other customers regarding the definition of acceptable level of risk.

The project office uses the report to finalize design decisions for the project. To meet slope stability requirements, additional right of way might be required or a wall might be needed. Wall design is covered in Chapter 1130. Construction timing might require importing material rather than using cut materials. The report is used to address this and other constructibility issues. The report is also used to proceed with completion of the project PS&E design.

(c) **PS&E Development.** Adequate geotechnical design information to complete the PS&E is typically received during project design. Additional geotechnical work might be needed when right of way cannot be acquired, restrictions are included in permits, or other requirements are added that result in changes in the design.

Special provisions and plan details, if not received as part of the report provided during project design, are developed with the assistance of the RME or the OSC Geotechnical Branch. The project designer uses this information, as well as the design phase report, to complete the PS&E documents. Both the region's Materials Section and the OSC Geotechnical Branch can review the contract plans before the PS&E review process begins, if requested. Otherwise, they will review the contract plans during the normal PS&E review process.

## ***(7) Hydraulic Structures and Environmental Mitigation***

(a) **Project Definition.** The designer provides a description and location of the proposed hydraulic/environmental improvements and other pertinent site information, and discusses the extent of the hydraulics and environmental improvements, with both the RME and the Hydraulics Sections, to identify the geotechnical issues to be investigated. At this stage, only the identification and feasibility of the proposed hydraulic structures or environmental mitigation are investigated. The cost and schedule require-

ments for the geotechnical investigation are also determined at this time.

Examples of hydraulic structures include, but are not limited to, large culverts, pipe arches, underground detention vaults, and fish passage structures. Examples of environmental mitigation include, but are not limited to, detention/retention ponds and wetland creation.

(b) **Project Design.** The designer requests a geotechnical report from the RME. The site data indicated in 510.04(4), as applicable, is provided along with the following information:

- Pertinent field observations (such as unstable slopes, existing soft soils or boulders, or erosion around and damage to existing culverts or other drainage structures).
- Jurisdictional requirements for geotechnical design of berms/dams.

It is important that the request for the geotechnical report be made as early in the design phase as practical. Cost and schedule requirements to generate the report are project specific and can vary widely. The time required to obtain permits and rights of entry must be considered when establishing schedule requirements.

The RME, with support from the OSC Geotechnical Branch as needed, provides the following information, when requested and where applicable, as part of the project geotechnical report:

- Soil boring logs.
- Soil pH and resistivity.
- Water table elevation.
- Soil infiltration rates (highest rate for assessing spill containment/aquifer protection and long-term rate for determining pond capacity).
- Bearing capacity and settlement for hydraulic structure foundations.
- Slope stability for ponds.
- Retention berm/dam design.
- Potential for and amount of differential settlement along culverts and pipe arches

and the estimated time required for settlement to occur.

- Soil pressures and properties (primarily for underground detention vaults).
- Erosion potential.
- Geosynthetic design per Chapter 530.
- Recommendations for mitigation of the effect of soft or unstable soil on the hydraulic structures.
- Recommendations for construction.

Note that retaining walls that are part of a pond, fish passage, and the like, are designed per Chapter 1130.

The project designer uses the geotechnical information to:

- Finalize design decisions.
- Evaluate and mitigate environmental issues.
- Proceed with completion of the PS&E design (includes determining the most cost effective hydraulic structure/pond to meet the desired objectives, locating and sizing ponds and foundations for hydraulic structures, structural design, mitigating the effects of settlement, satisfying local jurisdictional requirements for design, and so forth).

(c) **PS&E Development.** During PS&E development, the designer uses the information provided in the geotechnical report as follows:

- Select pipe materials in accordance with corrosion, resistivity, and abrasion guidelines in the *Hydraulics Manual*.
- Consider and include construction recommendations.

Additional design and specification guidance and support from the RME or the OSC Geotechnical Branch are sought as needed. Both sections provide careful review of the contract plans before the PS&E review process begins, if requested. Otherwise, they will review the contract plans during the normal PS&E review process.

## **(8) Signals, Sign Bridges, Cantilever Signs, and Luminaire Foundations**

### **(a) Project Definition and Design.**

Geotechnical information is usually not required for signals, sign bridges, cantilever signs, and luminaires during project definition.

The region's Traffic Office contacts the RME for conceptual foundation recommendations. The conceptual recommendations are based on existing information in the area, and identify if Standard Plan foundations are feasible or if special design foundations are required. If good soils are anticipated or the foundations will be placed in fill, Standard Plan foundations can be assumed. If special design foundations are required, additional time and money can be included in the project to accommodate increased field exploration for foundation design, OSC Geotechnical Branch involvement, and structural design by the Bridge and Structures Office.

**(b) PS&E Development.** Foundation recommendations are made by either the RME or the OSC Geotechnical Branch. The recommendations provide all necessary geotechnical information to complete the PS&E.

The region's Traffic Office (or region's Project Engineer in some cases) is responsible for delivering the following project information to the region's Materials Engineer:

- Plan sheet showing the location of the structures (station and offset) and the planned structure type.
- Applicable values for: XYZ, strain pole class, sign bridge span length, luminaire height, variable message sign weight, wind load, CCTV pole height, and known utility information in the area.

The RME provides the following information to the requester if Standard Plan foundation types can be used:

- Allowable lateral bearing capacity of the soil.
- Results of all field explorations.
- Groundwater elevation.
- Foundation constructibility.

The region uses this information to complete the plan sheets and prepare any special provisions. If utilities are identified during the field investigation that could conflict with the foundations, the region's project office pursues moving or accommodating the utility. Accommodation could require special foundation designs.

If special designs are required, the RME notifies the requester that special designs are required and forwards the information received from the region to the Geotechnical Branch. The Geotechnical Branch provides the Bridge and Structures Office with the necessary geotechnical recommendations to complete the foundation designs. The region coordinates with the Bridge and Structures Office to ensure that they have all the information necessary to complete the design. Depending on the structure type and complexity, the Bridge and Structures Office might produce the plan sheets and special provisions for the foundations, or they might provide the region with information so that the region can complete the plan sheets and special provisions.

## **(9) Buildings, Park and Ride Lots, Rest Areas, and Communication Towers**

In general, the RME functions as the clearing house for the geotechnical work to be conducted in each of the phases for technical review of the work if the work is performed by consultants, or for getting the work done in-house. For sites and designs that are more geotechnically complex, the RME contacts the OSC Geotechnical Branch for assistance.

Detailed geotechnical investigation guidance is provided in Facilities Operating Procedure 9-18, "Site Development." In summary, this guidance addresses the following phases of design:

**(a) Site Selection.** Conceptual geotechnical investigation (based on historical data and minimal subsurface investigation) of several alternative sites is performed in which the geotechnical feasibility of each site for the intended use is evaluated, allowing the sites to be ranked. In this phase, geological hazards (landslides, rockfall, compressible soils, liquefaction,

and so forth) are identified, and geotechnical data adequate to determine a preliminary cost to develop and build on the site is gathered.

(b) **Schematic Design.** For the selected site, the best locations for structures, utilities, and other elements of the project are determined based on site constraints and ground conditions. In this phase, the site is characterized more thoroughly than in the site selection phase, but subsurface exploration is not structure specific.

(c) **Design Development.** The final locations of each of the project structures, utilities, and other project elements determined from the schematic design phase are identified. Once these final locations are available, a geotechnical investigation adequate to complete the final design of each of the project elements (structure foundations, detention/retention facilities, utilities, parking lots, roadways, site grading, and so forth) is conducted. From this investigation and design, the final PS&E is developed.

### **(10) Retaining Walls, Reinforced Slopes, and Noise Walls**

(a) **Project Definition.** The designer provides a description and location of the proposed walls or reinforced slopes, including the potential size of the proposed structures and other pertinent site information, to the RME. At this stage, only the identification and feasibility of the proposed walls or reinforced slopes are investigated. A field review may also be conducted at this time as part of the investigation effort. In general, if soil/rock conditions are poor and/or large walls or reinforced slopes are anticipated, the RME requests that the OSC Geotechnical Branch participate in the field review and reporting efforts. The cost and schedule requirements for the geotechnical investigation are also determined at this time.

A brief conceptual level report that summarizes the results of the investigation may be provided to the designer at this time, depending on the complexity of the geotechnical issues.

(b) **Project Design and PS&E Development.** Geotechnical data necessary to allow completion of the PS&E level design for walls and reinforced

slopes are compiled during the design and PS&E development phases. This includes soils borings, testing, and final geometric data. Detailed design of walls and reinforced slopes can be done once the roadway geometry is established and geotechnical data are available. The purpose of this design effort is to determine the wall and slope geometry needed for stability, noise wall and retaining wall foundation requirements, and the potential for short- and long-term settlement.

The designer requests a geotechnical report from the RME for retaining walls, noise walls, and reinforced slopes that are not part of the bridge preliminary plan. For walls that are part of the bridge preliminary plan, the Bridge and Structures Office requests the geotechnical report for the walls from the OSC Geotechnical Branch. For both cases, see Chapter 1130 for the detailed design process for retaining walls and reinforced slopes and Chapter 1140 for the detailed design process for noise walls. It is important that requests for a geotechnical report be made as early in the design phase as practical. The time required to obtain permits and rights of entry must be considered when establishing schedule requirements.

For retaining walls and reinforced slopes, the site data to be provided with the request for a geotechnical report are as indicated in Chapter 1130. Also supply right of entry agreements and permits required for the geotechnical investigation. The site data indicated in 510.04(4), as applicable, are provided for noise walls.

The RME or the OSC Geotechnical Branch (see Chapter 1130 or 1140 for specific responsibilities for design), provides the following information as part of the geotechnical report (as applicable):

1. General description of the regional and site geology
2. Summary of the investigation
3. Boring logs
4. Laboratory tests and results
5. Soil/rock unit descriptions
6. Ground water conditions



## 7. Retaining wall/reinforced slope and noise wall recommendations

- Recommended geometry for stability
- Stability and settlement mitigation requirements, if needed
- Foundation type and capacity
- Estimated amount and rate of settlement
- Design soil parameters
- Construction staging requirements
- Effects of site constraints
- Monitoring needs
- Material and compaction requirements
- Subgrade preparation

The recommendations may also include the background regarding analysis approach and any agreements with the region or other customers regarding the definition of acceptable level of risk. Additional details and design issues to be considered in the geotechnical report are as provided in Chapter 1130 for retaining walls and reinforced slopes and in Chapter 1140 for noise walls. The project designer uses this information for final wall/reinforced slope selection and to complete the PS&E.

For final PS&E preparation, special provisions and plan details (if not received as part of the report provided during project design) are developed with the assistance of the region Materials Section or the OSC Geotechnical Branch. Both the region Materials Section and the OSC Geotechnical Branch can review the contract plans before the PS&E review process begins, if requested. Otherwise, they will review the contract plans during the normal PS&E review process.

### **(11) Unstable Slopes**

Unstable slope mitigation includes the stabilization of known landslides and rockfall that occur on slopes adjacent to the WSDOT transportation system, and that have been programmed under the P3 unstable slope program.

(a) **Project Definition.** The region's project office provides a description and location of the proposed unstable slope mitigation work to the RME. Location of the proposed work can be mile post limits or stationing. The region's project designer meets at the project site with the RME and the OSC Geotechnical Branch to conduct a field review, discuss project requirements, and to identify geotechnical issues associated with the unstable slope project. The RME requests that the OSC Geotechnical Branch participate in the field review and project definition reporting.

The level of work in the project definition phase for unstable slopes is conceptual in nature, not final design. The geotechnical investigation generally consists of a field review, a more detailed assessment of the unstable slope, review of the conceptual mitigation developed during the programming phase of the project, and proposed modification (if any) to the original conceptual level unstable slope mitigation. The design phase geotechnical services cost and schedule, including any required permits, are determined at this time. A brief conceptual level report is provided to the project designer that summarizes the results of the project definition investigation.

(b) **Project Design.** Geotechnical information and field data necessary to complete the unstable slope mitigation design is compiled during this design phase. This work includes, depending on the nature of the unstable slope problem, test borings, rock structure mapping, geotechnical field instrumentation, laboratory testing, and slope stability analysis. The purpose of this design effort is to determine the most appropriate method (s) to stabilize the known unstable slope.

The designer requests a geotechnical report from the OSC Geotechnical Branch through the RME. The site data indicated in 510.04(4), as applicable, is provided along with the following information:

- Plan sheet showing the station and location of the proposed unstable slope mitigation project.
- If requested, Digital Terrain Model (DTM) files necessary to define the on-ground

topography of the project site. The limits of the DTM will have been defined during the project definition phase.

It is important that the request for the geotechnical report be made as early in the design phase as practical. Cost and schedule requirements to generate the report are project specific and can vary widely. Unstable slope design investigations might require geotechnical monitoring of ground movement and ground water over an extended period of time to develop the required field information for the unstable slope mitigation design. The time required to obtain rights of entry and other permits, as well as the long-term monitoring data, must be considered when establishing schedule requirements for the geotechnical report.

The OSC Geotechnical Branch provides the following information as part of the project geotechnical report (as applicable):

- General site description and summary of site geology.
- Summary of the field investigation.
- Boring logs.
- Laboratory tests and results.
- Geotechnical field instrumentation results.
- Summary of the engineering geology of the site including geologic units encountered.
- Unstable slope design analysis and mitigation recommendations.
- Constructibility issues associated with the unstable slope mitigation.
- Appropriate special provisions for inclusion in the contact plans.

The region's project design office uses the geotechnical report to finalize the design decisions for the project and the completion of the PS&E design.

(c) **PS&E Development.** Adequate geotechnical design information to complete the PS&E is typically obtained during the project design phase. Additional geotechnical work

might be needed when right of way cannot be acquired, restrictions are included in permits, or other requirements are added that result in changes to the design.

Special provisions, special project elements, and design details (if not received as part of the design phase geotechnical report) are developed with the assistance of the RME and the OSC Geotechnical Branch. The region's project designer uses this information in conjunction with the design phase geotechnical report to complete the PS&E document. The RME and the OSC Geotechnical Branch can review the contract plans before the PS&E review begins, if requested. Otherwise, they will review the contract plans during the normal PS&E review process.

## **(12) *Rockslope Design***

(a) **Project Definition.** The region's project office provides a description and location of the proposed rock excavation work to the RME. For widening of existing rock cuts, the anticipated width and length of the proposed cut in relationship to the existing cut are provided. For new alignments, the approximate location and depth of the cut are provided. Location of the proposed cut(s) can be mile post limits or stationing. The project designer meets at the project site with the RME and the OSC Geotechnical Branch to conduct a field review, discusses project requirements, and identify any geotechnical issues associated with the proposed rock cuts. The RME requests that the OSC Geotechnical Branch participate in the field review and project definition reporting.

The level of rock slope design work for the project definition phase is conceptual in nature. The geotechnical investigation generally consists of the field review, review of existing records, an assessment of existing rockslope stability, and preliminary geologic structure mapping. The focus of this investigation is to assess the feasibility of the rock cuts for the proposed widening or realignment, not final design. A brief conceptual level report that summarizes the result of the

project definition investigation is provided to the project designer.

(b) **Project Design.** Detailed rockslope design is done once the roadway geometrics have been established. The rockslope design cannot be finalized until the roadway geometrics have been finalized. Geotechnical information and field data necessary to complete the rockslope design are compiled during this design phase. This work includes rock structure mapping, test borings, laboratory testing, and slope stability analysis. The purpose of this design effort is to determine the maximum stable cut slope angle, and any additional rockslope stabilization measures that could be required.

The designer requests a geotechnical report from the OSC Geotechnical Branch through the RME. The site data indicated in 510.04(4), as applicable, is provided.

It is important that the request for the geotechnical report be made as early in the design phase as practical. Cost and schedule requirements to generate the report are project specific and can vary widely. The time required to obtain permits and rights of entry must be considered when establishing schedule requirements.

The OSC Geotechnical Branch provides the following information as part of the project geotechnical report (as applicable):

1. General site description and summary of site geology.
2. Summary of the field investigation.
3. Boring logs.
4. Laboratory tests and results.
5. Rock units encountered within the project limits.
6. Rock slope design analysis and recommendations.
  - Type of rockslope design analysis conducted and limitation of the analysis. Also included will be any agreements with the region and other customers regarding the definition of acceptable risk

- The slope(s) required for stability
- Additional slope stabilization requirements (rock bolts, rock dowels, and so forth.)
- Rockslope ditch criteria (See Chapter 640)
- Assessment of rippability
- Blasting requirements including limitations on peak ground vibrations and air blast overpressure, if required
- Usability of the excavated material including estimates of shrink and swell
- Constructibility issues associated with the rock excavation

The project office uses the geotechnical report to finalize the design decisions for the project, and the completion of the PS&E design for the rockslope elements of the project.

(c) **PS&E Development.** Adequate geotechnical design information to complete the PS&E is typically obtained during the project design phase. Additional geotechnical work might be needed when right of way cannot be acquired, restrictions are included in permits, or other requirements are added that result in change to the design.

Special provisions, special blasting requirements, and plans details, if not received as part of the design phase geotechnical report, are developed with the assistance of the RME or the OSC Geotechnical Branch. The project designer uses this information in conjunction with the design phase geotechnical report to complete the PS&E documents. The RME and the OSC Geotechnical Branch review the contract plans before the PS&E review begins, if requested. Otherwise, they will review the contract plans during the normal PS&E review process.

### **(13) Bridge Foundations**

(a) **Project Definition.** The OSC Geotechnical Branch supports the project definition process to develop reasonably accurate estimates of bridge substructure costs. For major projects and for projects that are located in areas with little or no existing geotechnical information, a field review

is recommended. The region's office responsible for project definition coordinates field reviews. Subsurface exploration (drilling) is usually not required at this time, but might be needed if cost estimates cannot be prepared within an acceptable range of certainty.

The Bridge and Structures Office, once they have received the necessary site data from the region's project office, is responsible for delivering the following project information to the OSC Geotechnical Branch:

- Alternative alignments and/or locations of bridge structures.
- A preliminary estimate of channelization (structure width).
- Known environmental constraints.

The Bridge and Structures and region offices can expect to receive the following from the OSC Geotechnical Branch:

- Summary or copies of existing geotechnical information.
- Identification of geotechnical hazards (slides, liquefiable soils, soft soil deposits, and so forth.).
- Identification of permits that might be required for subsurface exploration (drilling).
- Conceptual foundation types and depths.
- If requested, an estimated cost and time to complete a geotechnical foundation report.

The Bridge Office uses this information to refine preliminary bridge costs. The region's project office uses the estimated cost and time to complete a geotechnical foundation report to develop the project delivery cost and schedule.

(b) **Project Design.** The OSC Geotechnical Branch assists the Bridge and Structures Office with preparation of the bridge Preliminary Plan. Geotechnical information gathered for project definition will normally be adequate for this phase, as test holes for the final bridge design cannot be drilled until accurate pier location information is available. For selected major projects, a type, size, and location (TS&L)

report might be prepared which usually requires some subsurface exploration to provide a more detailed, though not final, estimate of foundation requirements.

The Bridge Office is responsible for delivering the following project information, based on bridge site data received from the region's project office, to the OSC Geotechnical Branch:

- Anticipated pier locations
- Approach fill heights
- For TS&L, alternate locations/alignments/structure types

The Bridge Office can expect to receive:

- Conceptual foundation types, depths and capacities
- Permissible slopes for bridge approaches
- For TS&L, a summary of site geology and subsurface conditions, and more detailed preliminary foundation design parameters and needs
- If applicable or requested, erosion or scour potential

The Bridge Office uses this information to complete the bridge preliminary plan. The region's project office confirms right of way needs for approach embankments. For TS&L, the geotechnical information provided is used for cost estimating and preferred alternate selection. The preliminary plans are used by the OSC Geotechnical Branch to develop the site subsurface exploration plan.

(c) **PS&E Development.** During this phase, or as soon as a 95 percent preliminary plan is available, subsurface exploration (drilling) is performed and a geotechnical foundation report is prepared to provide all necessary geotechnical recommendations needed to complete the bridge PS&E.

The Bridge Office is responsible for delivering the following project information to the OSC Geotechnical Branch:

- 95 percent preliminary plans (concurrent with distribution for region approval)
- Estimated foundation loads and allowable settlement criteria for the structure, when requested

The Bridge Office can expect to receive:

- Bridge geotechnical foundation report

The Bridge and Structures Office uses this information to complete the bridge PS&E. The region's project office reviews the geotechnical foundation report for construction considerations and recommendations that might affect region items, estimates, staging, construction schedule, or other items.

Upon receipt of the structure PS&E review set, the OSC Geotechnical Branch provides the Bridge and Structures Office with a Summary of Geotechnical Conditions for inclusion in Appendix B of the contract.

#### **(14) Geosynthetics**

See Chapter 530 for geosynthetic design guidance.

#### **(15) Washington State Ferries Projects**

(a) **Project Design.** The OSC Geotechnical Branch assists the Washington State Ferries (WSF) division with determining the geotechnical feasibility of all offshore facilities, terminal facility foundations, and bulkhead walls. For upland retaining walls and grading, utility trenches, and pavement design, the RME assists WSF with determining geotechnical feasibility.

In addition to the site data identified in Section 510.04(4), as applicable, the following information is supplied by WSF to the OSC Geotechnical Branch or the RME, as appropriate, with the request for the project geotechnical report::

- A plan showing anticipated structure locations as well as existing structures.
- Relevant historical data for the site.
- A plan showing utility trench locations.
- Anticipated utility trench depths.

- Proposed roadway profiles.

WSF can expect to receive:

- Results of any borings or laboratory tests conducted.
- A description of geotechnical site conditions.
- Conceptual foundation types, depths and capacities.
- Conceptual wall types.
- Assessment of constructibility issues that affect feasibility.
- Surfacing depths and/or pavement repair and drainage schemes.
- If applicable or requested, erosion or scour potential.

WSF uses this information to complete the project design report, design decisions, and estimated project budget and schedule.

WSF is responsible for obtaining any necessary permits or right of entry agreements needed to access structure locations for the purpose of subsurface exploration (for example, test hole drilling). The time required for obtaining permits and rights of entry must be considered when developing project schedules. Possible permits and agreements might include but are not limited to:

- City, county or local agency use permits.
- Sensitive area ordinance permits.

#### **(b) PS&E Development**

Subsurface exploration (drilling) is performed and a geotechnical foundation report is prepared to provide all necessary geotechnical recommendations needed to complete the PS&E.

The designer requests a geotechnical report from the OSC geotechnical branch or the RME, as appropriate. The site data indicated in 510.04(4), as applicable, is provided along with the following information:

- A plan showing final structure locations as well as existing structures.
- Proposed structure loadings.

WSF can expect to receive:

- Results of any borings or laboratory tests conducted.
- A description of geotechnical site conditions.
- Final foundation types, depths and capacities.
- Final wall types and geotechnical designs/ parameters for each wall.
- Assessment of constructibility issues to be considered in foundation selection and when assembling the PS&E.
- Pile driving information - driving resistance and estimated overdrive.
- Surfacing depths and/or pavement repair and drainage schemes.

WSF uses this information to complete the PS&E.

Upon receipt of the WSF PS&E review set, the OSC Geotechnical Branch provides WSF with a Summary of Geotechnical Conditions for inclusion in Appendix B of the Contract. A Final Geotechnical Project Documentation package is assembled by the OSC Geotechnical Branch and sent to WSF or the Plans Branch, as appropriate, for reproduction and sale to prospective bidders.

### **510.05 Use of Geotechnical Consultants**

The OSC Geotechnical Services Branch or the RME assists in developing the geotechnical scope and estimate for the project, so that the consultant contract is appropriate. (Consultant Services assists in this process.) A team meeting between the consultant team, the region or Washington State Ferries (depending on whose project it is), and the OSC Geotechnical Services Branch/RME is conducted early in the project to develop technical communication lines and relationships. Good proactive communication between all members of the project team is crucial to the success of the project due to the complex supplier-client relationships.

### **510.06 Geotechnical Work by Others**

Geotechnical design work conducted for the design of structures or other engineering works by other agencies or private developers within the right of way is subject to the same geotechnical engineering requirements as for engineering works performed by WSDOT. Therefore, the provisions contained within this chapter also apply in principle to such work. All geotechnical work conducted for engineering works within the WSDOT right of way or that otherwise directly impacts WSDOT facilities must be reviewed and approved by the OSC Geotechnical Services Branch or the RME.

### **510.07 Surfacing Report**

Detailed criteria and methods that govern pavement rehabilitation can be found in *WSDOT Pavement Guide for Design, Evaluation and Rehabilitation*, Volume 1, pages 2-22 through 2-26. The RME provides the surfacing report to the region's project office. This report provides recommended pavement types, surfacing depths, pavement drainage recommendations, and pavement repair recommendations.

### **510.08 Documentation**

#### **(1) Design Documentation**

When a project requires investigation of soils or surfacing materials, the results of the investigations are to be preserved in the project file. (See Chapter 330.) This includes all reports, forms, and attachments.

- Materials source report and approvals
- Geotechnical reports
- Surfacing report

#### **(2) Final Geotechnical Project Documentation and Geotechnical Information Included as Part of the Construction Contract**

Once a project PS&E is near completion, all of the geotechnical design memorandums and reports are compiled together to form the Final

Geotechnical Project Documentation, to be published for the use of prospective bidders. The detailed process for this is located in the *Plans Preparation Manual*.

Geotechnical information included as part of the contract generally consists of the final project boring logs, and, as appropriate for the project, a Summary of Geotechnical Conditions. Both of these items are provided by the OSC Geotechnical Services Branch.

*P65:DP/DMM*

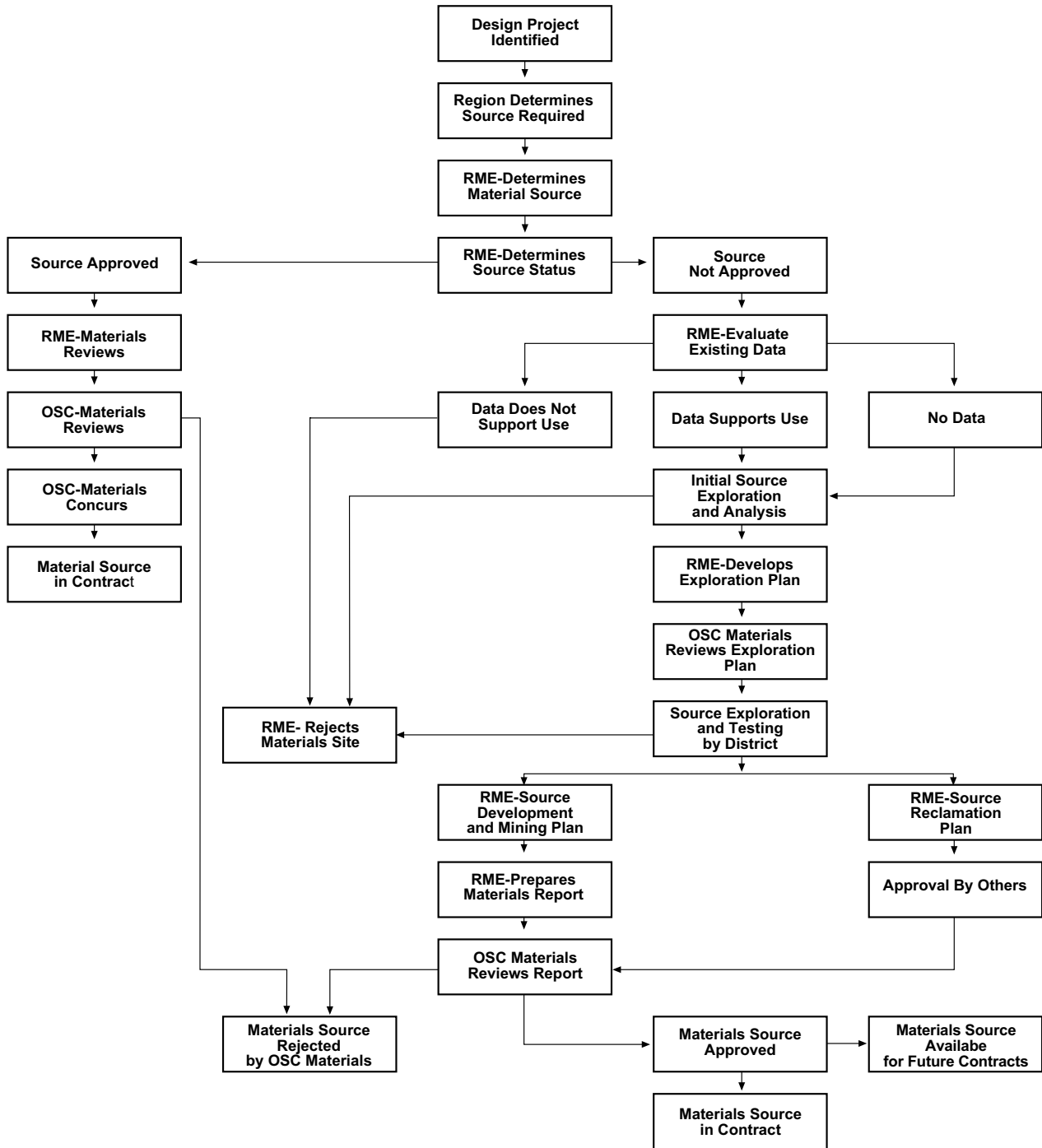

### Material Source Development Plan

Figure 510-1



520.01 Introduction

I 520.02 Estimating Tables

**520.01 Introduction**

Detailed criteria and methods that govern pavement design are in the *WSDOT Pavement Guide for Design, Evaluation and Rehabilitation*.

**520.02 Estimating Tables**

Figures 520-1 through 520-5b are to be used when detailed estimates are required. They are for pavement sections, shoulder sections, stockpiles, and asphalt distribution. Prime coats and tack coats are in Figure 520-2a.

*P65:DP/DME*

Unit Dry Weight				
Type of Material	Truck Measure		Compacted on Roadway	
	lb/yd <sup>3</sup>	T/ yd <sup>3</sup>	lb/ yd <sup>3</sup>	T/ yd <sup>3</sup>
Ballast	3100	1.55	3900	1.95
Crushed Surfacing Top Course	2850	1.43	3700	1.85
Crushed Surfacing Base Course	2950	1.48	3700	1.85
Screened Gravel Surfacing			3700	1.85
**Gravel Base			3400 - 3800	1.70 - 1.90
Shoulder Ballast			2800	1.40

Maintenance Sand 3/8" - 0	2900	1.45
Mineral Aggregate 2" - 1"	2600	1.30
Mineral Aggregate 1 3/4" - 3/4"	2600	1.30
Mineral Aggregate 1 1/2" - 3/4"	2550	1.28
Mineral Aggregate 1" - 3/4"	2500	1.25
Mineral Aggregate 3/4" - 1/2"	2400	1.20
Mineral Aggregate 1 1/4" - 1/4"	2600	1.30
Mineral Aggregate 1" - 1/4"	2600	1.30
Mineral Aggregate 7/8" - 1/4"	2550	1.28
Mineral Aggregate 3/4" - 1/4"	2500	1.25
Mineral Aggregate 5/8" - 1/4"	2650	1.33
Mineral Aggregate 1/2" - 1/4" or #4	2600	1.30
Mineral Aggregate 1/4" or #4 - 0	2900	1.45
Concrete Aggr. No. 2 (1 1/4" - #4)	3000	1.50
Concrete Sand (Fine Aggregate)	2900	1.45
Crushed Cover Stone	2850	1.43

\*\* 3,700 lb/yd<sup>3</sup> (1.85 tons/ yd<sup>3</sup>) is recommended as the most suitable factor; however, if the grading approaches the coarseness of ballast, the factor would approach 3,800 lb/yd<sup>3</sup> (1.90 tons/ yd<sup>3</sup>), and if the grading contains more than 45% sand, the factor would decrease, approaching 3,400 lb/yd<sup>3</sup> (1.70 tons/ yd<sup>3</sup>) for material that is essentially all sand.

Mineral Aggregate in Stockpile * (tons/mile)								
Class	Pavement Compacted Depth (ft)	Agg. Size (in)	Approx Mix Ratio (%)	Roadway Width (ft)				
				10	11	12	22	24
A & B	0.10	5/8" - 1/4"	35	145	160	175	320	350
		1/4" - 0	65	270	297	324	594	648
D	0.04	3/8" - 0	100	166	183	199	366	398
E	0.10	1 1/4" - 1/4"	50	208	229	249	458	498
		1/4" - 0	50	208	229	249	458	498
F	0.10	3/4" - 1/4"	35	145	160	175	320	350
		1/4" - 0	65	270	297	324	594	648
G	0.10	3/8" - 0	100	416	457	499	914	998

\* 94% by weight of complete mix (92.5% min - 96% max)   
 {(142 lb/ yd<sup>2</sup> / 0.10 ft = 2.13 T/ yd<sup>3</sup>)}

Includes 10% handling loss.

Mineral filler 1% of wearing course for Class B.

### General Notes

Weights shown are dry weights and corrections are required for water contents.

The tabulated weights for the materials are reasonably close; however, corrections should be applied in the following order:

For specific gravity:

$$\text{Wt.} = \frac{\text{tabular wt.} \times \text{specific gravity on surface report}}{2.65}$$

For water content:

$$\text{Wt.} = \text{tabular wt.} \times (1 + \text{free water \% in decimals})$$

Required quantities should be increased by 10 percent to allow for waste if they are to be stockpiled.

Attention should be directed to the inclusion of crushed surfacing top course material that may be required for keystone when estimating quantities for projects having ballast course.

### Estimating — Miscellaneous Tables

Figure 520-1

General Data <sup>1 2 3</sup>														
Asphalt Concrete Pavement														
Complete Mix														
Class of Mix	Depth (ft)	Spread per yd <sup>2</sup>		yd <sup>2</sup> per ton	Tons/Mile Width (ft)									
		lb	ton		10	11	12							
A, B, E, F & G	0.10	137	0.0685	14.60	402	442	482							
D	0.04	55	0.0275	36.36	161	177	194							
Prime Coats and Tack Coats														
Asphalt							Aggregate <sup>4</sup>							
Application	Type of Asphalt <sup>5</sup>	Application gal <sup>6</sup> per yd <sup>2</sup>	Tons <sup>6</sup> per yd <sup>2</sup>	Tons/Mile Width (ft)			Application lb per yd <sup>2</sup>	Tons/Mile Width (ft)			yd <sup>3</sup> per yd <sup>2</sup>	yd <sup>3</sup> /Mile Width (ft)		
				10	11	12		10	11	12		10	11	12
Prime Coat	MC-250	0.25	0.001004	5.9	6.5	7.1	30	88	97	106	0.0105	62	68	74
Tack Coat	CSS-1	0.05	0.000208	1.2	1.3	1.5								
Class D Tack Coat	CSS-1	0.10	0.000417	2.4	2.7	2.9								
Fog Seal	CSS-1	0.04	0.000167	1.0	1.1	1.2								
Total	CSS-1	0.14	0.000584	3.4	3.8	4.1								
Specific Data <sup>1 2 3</sup>														
Asphalt Concrete Paving Quantities (tons/mile) *														
Width (ft)	Depth of Pavement (ft)													
	0.10	0.15	0.20	0.25	0.30	0.35	0.40	0.45	0.50	0.55	0.60	0.65	0.70	0.75
4	161	241	321	402	482	563	643	723	804	884	964	1045	1125	1206
6	241	362	482	603	723	844	964	1085	1206	1326	1447	1567	1688	1808
8	321	482	643	804	964	1125	1286	1447	1607	1768	1929	2090	2250	2411
10	402	603	804	1005	1206	1407	1607	1808	2009	2210	2411	2612	2813	3014
11	442	663	884	1105	1326	1547	1768	1989	2210	2431	2652	2873	3094	3315
12	482	723	964	1206	1447	1688	1929	2170	2411	2652	2893	3135	3376	3617
22	884	1326	1768	2210	2652	3094	3536	3978	4421	4863	5305	5747	6189	6631
24	964	1447	1629	2411	2893	3376	3858	4340	4822	5305	5787	6269	6751	7234
* Based on 137 lb/ yd <sup>2</sup> of 0.10 ft compacted depth = 2.05 tons/ yd <sup>3</sup>														

<sup>1</sup>The specific gravity of the aggregate will affect the weight of aggregate in the completed mix.

<sup>2</sup>The percentage of fine mineral in the coarse aggregate will affect the ratio of coarse to fine. If the coarse aggregate produced contains an excessive amount of fines (1/4" to 0), the percentage of coarse aggregate should be increased and the fines decreased accordingly.

<sup>3</sup>Quantities shown do not provide for widening, waste from stockpile, or thickened edges.

<sup>4</sup>See miscellaneous tables for the average weights of mineral aggregates used in calculation of this data.

<sup>5</sup>The column "Type of Asphalt" is shown for the purpose of conversion to proper weights for the asphalt being used and does not imply that the particular grade shown is required for the respective treatment.

<sup>6</sup>Quantities shown are retained asphalt.

### Estimating — Asphalt Concrete Pavement and Asphalt Distribution Tables

Figure 520-2a

Asphalt Distribution (tons/mile) <sup>1</sup>																						
Asphalt Grade	Gal./ton @ 60° F	Width (ft)	Rate of Application (Gal./yd <sup>3</sup> )																			
			0.05	0.10	0.15	0.20	0.25	0.30	0.35	0.40	0.45	0.50	0.55	0.60	0.65	0.70	0.75	0.80	0.85	0.90	0.95	1.00
SC, MC, RC 70	253	10	1.16	2.32	3.48	4.64	5.80	6.96	8.12	9.28	10.46	11.59	12.79	13.91	15.07	16.23	17.39	18.55	19.71	20.87	22.03	23.19
		11	1.28	2.55	3.83	5.10	6.38	7.65	8.93	10.20	11.48	12.75	14.03	15.30	16.58	17.86	19.13	20.41	21.68	22.96	24.23	25.51
		12	1.39	2.78	4.17	5.57	6.96	8.35	9.74	11.13	12.52	13.91	15.30	16.70	18.09	19.48	20.87	22.26	23.65	25.04	26.43	27.83
SC, MC, RC 250	249	10	1.18	2.36	3.53	4.71	5.89	7.07	8.25	9.42	10.60	11.78	12.96	14.14	15.31	16.49	17.67	18.85	20.03	21.20	22.38	23.56
		11	1.30	2.59	3.89	5.18	6.48	7.78	9.07	10.37	11.66	12.96	14.25	15.55	16.85	18.14	19.44	20.73	22.03	23.33	24.62	25.92
		12	1.41	2.83	4.24	5.65	7.07	8.48	9.90	11.31	12.72	14.14	15.55	16.96	18.38	19.79	21.20	22.62	24.03	25.45	26.86	28.27
SC, MC, RC 800	245	10	1.20	2.39	3.59	4.79	5.99	7.18	8.38	9.58	10.78	11.97	13.17	14.37	15.56	16.76	17.96	19.16	20.35	21.55	22.75	23.95
		11	1.30	2.63	3.95	5.27	6.59	7.90	9.22	10.54	11.85	13.17	14.49	15.80	17.12	18.44	19.79	21.07	22.39	23.71	25.02	26.34
		12	1.44	2.87	4.31	5.75	7.18	8.62	10.06	11.49	12.93	14.37	15.80	17.24	18.68	20.11	21.55	22.99	24.42	25.86	27.30	28.73
SC, MC, RC 3000	241	10	1.22	2.44	3.66	4.87	6.09	7.31	8.53	9.75	10.97	12.19	13.41	14.62	15.84	17.06	18.28	19.50	20.72	21.94	23.15	24.37
		11	1.34	2.68	4.02	5.36	6.69	8.03	9.37	10.71	12.05	13.39	14.73	16.07	17.41	18.74	20.08	21.42	22.76	24.10	25.44	26.78
		12	1.46	2.92	4.38	5.84	7.30	8.76	10.22	11.68	13.15	14.61	16.07	17.53	18.99	20.45	21.91	23.37	24.83	26.29	27.75	29.21
Paving Asphalt 200-300 PEN.	239	10	1.23	2.45	3.68	4.91	6.14	7.36	8.59	9.82	11.05	12.27	13.50	14.73	15.96	17.18	18.41	19.64	20.86	22.09	23.32	24.55
		11	1.35	2.70	4.05	5.40	6.75	8.10	9.45	10.80	12.15	13.50	14.85	16.20	17.55	18.90	20.25	21.60	22.95	24.30	25.65	27.00
		12	1.47	2.95	4.42	5.89	7.36	8.84	10.31	11.78	13.26	14.73	16.20	17.67	19.15	20.62	22.09	23.56	25.04	26.51	27.98	29.46
Emulsified Asphalt	240	10	1.22	2.44	3.67	4.89	6.11	7.33	8.56	9.77	11.00	12.22	13.44	14.67	15.89	17.11	18.33	19.56	20.78	22.00	23.22	24.44
		11	1.34	2.67	4.03	5.38	6.72	8.07	9.41	10.76	12.10	13.45	14.79	16.13	17.48	18.82	20.17	21.51	22.86	24.20	25.54	26.89
		12	1.47	2.93	4.40	5.87	7.33	8.80	10.27	11.73	13.20	14.67	16.13	17.60	19.07	20.53	22.00	23.47	24.93	26.40	27.87	29.33

<sup>1</sup>Quantities of asphalt shown should be applied on the basis of 60° temperature and recomputed to the application temperature for the particular grade.

**Estimating — Asphalt Concrete Pavement and Asphalt Distribution Tables**  
*Figure 520-2b*

Bituminous Surface Treatment <sup>1</sup>																	
Class of Mix	Type of Application	Average Application		Mineral Aggregate <sup>3</sup>						Average Spread	Asphalt <sup>2,5,6</sup>						Basic <sup>4</sup> Asphalt Used
				10 ft		11 ft		12 ft			10 ft		11 ft		12 ft		
		lb/yd <sup>2</sup>	yd <sup>3</sup> /yd <sup>2</sup>	t/mi	t/mi	t/mi	t/mi	t/mi	t/mi	gal/yd <sup>2</sup>	gal/mi	gal/mi	gal/mi	gal/mi	gal/mi	gal/mi	
A	Prime Coat									0.48	2787	11.2	3065	12.3	3344	13.4	MC-250
	Crushed Screenings 3/4" - 1/2"	35	0.0146	103	86	113	94	123	103								
	Tack Coat									0.43	2493	10.4	2743	11.4	2992	12.5	CRS-2
	Crushed Screenings 1/2" - 1/4"	28	0.0106	81	62	89	68	97	74								
	Crushed Screenings 1/4" - 0"	5	0.0017	15	10	16	11	18	12								
	Totals	68	0.0269	199	158	218	173	238	189	0.91	5280	21.6	5808	23.7	6336	25.9	
B	Seal Coat									0.50	2933	12.2	3227	13.4	3520	14.7	CRS-2
	Crushed Screenings 5/8" - 1/4"	33	0.0123	95	72	105	79	114	86								
	Crushed Screenings 1/4" - 0"	5	0.0017	15	10	16	11	18	12								
	Totals	38	0.0140	110	82	121	90	132	98	0.50	2933	12.2	3227	13.4	3520	14.7	
C	Seal Coat									0.45	2640	11.0	2904	12.1	3168	13.2	CRS-2
	Crushed Screenings 1/2" - 1/4"	28	0.0106	81	62	89	68	97	74								
	Crushed Screenings 1/4" - 0"	5	0.0017	15	10	16	11	18	12								
	Totals	33	0.0123	96	72	105	79	115	86	0.45	2640	11.0	2904	12.1	3168	13.2	
D	Seal Coat									0.43	2493	10.4	2743	11.4	2992	12.5	CRS-2
	Crushed Screenings 3/8" - #10	25	0.0088	73	51	81	57	88	62								
Preseal for B, C & D	Preseal									0.18	1027	4.3	1129	4.7	1232	5.1	CRS-2
	Crushed Screenings 1/4" - 0"	12	0.0040	34	23	37	26	40	28								

- Quantities shown do not provide for widening, waste from stockpile, or thickened edges.
- Quantities of asphalt shown should be applied on the basis of 60°F temperature and recomputed to the application temperature for the particular grade.
- See miscellaneous tables for average weights of material aggregates and weights of mineral aggregate in stockpile.
- The column "Basic Asphalt Used" is shown for the purpose of conversion to proper weights for the asphalt being used and does not imply that the particular grade shown is required for the respective treatment.
- For cutbacks, decrease asphalt by 25 percent.
- For stress absorbing membrane (rubberized asphalt), increase asphalt by 25 percent.

Estimating — Bituminous Surface Treatment  
Figure 520-3

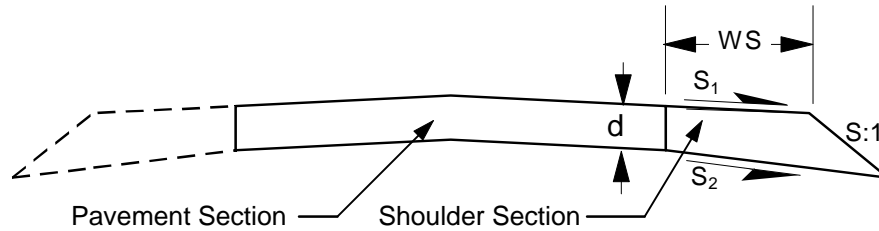

- $W_s$  = Shoulder Width - (Varies 4 ft, 6 ft, 8 ft, 10 ft, 12 ft)  
 $d$  = Depth of Section - (Varies 0.05 ft to 2 ft)  
 $S$  = Side Slope (H:V) - (Varies 2:1, 3:1, 4:1, and 6:1)  
 $S_1$  = Top Shoulder Slope - (Varies -0.02 ft/ft or -0.05 ft/ft)  
 $S_2$  = Bottom Shoulder Slope - (Varies -0.02 ft/ft or -0.05 ft/ft)

Formula for Shoulder Section		
Tons/mile. = (A)(K) $K = (5280/27)(1.85 \text{ tons/yd}^3)$		
$A = \frac{[d + W_s(1/S - S_1)]^2 S}{2(1 - SS_2)} - \frac{W_s^2}{2}(1/S - S_1)$		
Case 1	$S_1 = S_2 = -0.02 \text{ ft/ft}$	$A = \frac{[d + W_s(1/S - 0.02)]^2 S}{2(1 - 0.02S)} - \frac{W_s^2}{2}(1/S - 0.02)$
Case 2	$S_1 = -0.02 \text{ ft/ft}, S_2 = -0.05 \text{ ft/ft}$	$A = \frac{[d + W_s(1/S - 0.02)]^2 S}{2(1 - 0.05S)} - \frac{W_s^2}{2}(1/S - 0.02)$
Case 3	$S_1 = -0.05 \text{ ft/ft}, S_2 = -0.02 \text{ ft/ft}$	$A = \frac{[d + W_s(1/S - 0.05)]^2 S}{2(1 - 0.02S)} - \frac{W_s^2}{2}(1/S - 0.05)^*$
Case 4	$S_1 = S_2 = -0.05 \text{ ft/ft}$	$A = \frac{[d + W_s(1/S - 0.05)]^2 S}{2(1 - 0.05S)} - \frac{W_s^2}{2}(1/S - 0.05)$
* Limit: Positive Values of A only when $d = W_s(0.03)$		

EXAMPLE: Shoulder Section

Given - Shoulder Width    8 ft  
           Top Course            0.25 ft  
           Base Course          0.80 ft  
           Total Depth          1.05 ft  
           Side Slope            3:1  
           Shoulder Slope       -0.05  
           Subgrade Slope      -0.02

Depth                    1.05 ft (Case 3) = 3070 tons/mile  
 Top Course              0.25 ft (Case 4) = 763 tons/mile  
 Base Course              = 2307 tons/mile

Top Course            = 763 tons/mile  
 Base Course           = 2307 tons/mile

### Estimating — Base and Surfacing Typical Section Formulae and Example

Figure 520-4

Shoulder Section												
Shldr. Width Ws(ft)	Side Slope S:1	Case	Quantity in tons per mile*									
			Surfacing Depth (ft)									
			0.05	0.10	0.15	0.20	0.25	0.30	0.35	0.40	0.45	0.50
4	2	1	73	148	226	304	385	468	553	639	728	818
		2	171	251	333	417	504	592	682	774	869	965
		3	N/A	N/A	131	205	281	360	440	522	605	691
		4	73	149	226	306	387	470	556	643	733	824
	3	1	74	150	230	313	398	486	577	671	768	868
		2	178	262	350	442	536	634	734	838	945	1056
		3	N/A	N/A	131	206	285	366	450	537	627	720
		4	74	151	231	315	402	492	585	681	780	883
	4	1	74	153	235	321	411	505	603	705	810	920
		2	185	275	370	469	572	681	793	910	1032	1158
		3	N/A	N/A	131	208	288	373	461	554	650	750
		4	75	154	237	326	418	516	617	724	834	950
	6	1	75	157	245	339	439	545	658	776	901	1032
		2	204	307	417	535	661	794	936	1085	1242	1406
		3	N/A	N/A	131	210	296	387	485	589	699	815
		4	76	160	252	351	459	574	696	827	965	1111
6	2	1	109	221	334	449	566	685	806	929	1053	1180
		2	325	444	565	688	812	939	1068	1199	1332	1467
		3	N/A	N/A	N/A	239	349	461	575	691	809	929
		4	110	221	335	450	568	687	809	933	1058	1186
	3	1	110	223	339	457	579	703	830	961	1094	1230
		2	338	462	590	722	856	994	1134	1278	1426	1576
		3	N/A	N/A	N/A	239	350	464	581	701	824	949
		4	110	223	340	460	583	709	838	970	1106	1245
	4	1	110	225	343	466	592	722	856	994	1136	1282
		2	352	483	619	760	905	1055	1209	1368	1531	1699
		3	N/A	N/A	N/A	239	351	467	587	711	839	971
		4	111	226	346	470	599	733	871	1013	1160	1311
	6	1	112	229	353	483	620	762	911	1066	1227	1394
		2	386	534	690	853	1025	1204	1391	1585	1788	1998
		3	N/A	N/A	N/A	239	353	474	600	733	871	1016
		4	112	233	360	496	640	791	950	1116	1291	1473
8	2	1	146	293	443	594	747	902	1059	1218	1379	1541
		2	526	683	843	1004	1167	1333	1500	1670	1841	2015
		3	N/A	N/A	N/A	N/A	376	522	670	820	972	1125
		4	146	293	443	595	749	904	1062	1222	1384	1548
	3	1	146	295	447	602	760	920	1084	1250	1419	1591
		2	546	711	879	1050	1224	1402	1583	1766	1954	2144
		3	N/A	N/A	N/A	N/A	376	523	673	825	981	1139
		4	146	296	448	604	763	926	1091	1260	1432	1607
	4	1	147	297	452	610	773	939	1109	1284	1462	1644
		2	568	741	919	1101	1288	1479	1675	1875	2080	2290
		3	N/A	N/A	N/A	N/A	376	524	675	831	990	1153
		4	147	298	454	615	780	950	1124	1302	1486	1673
	6	1	148	302	462	628	801	979	1164	1355	1552	1755
		2	622	816	1017	1226	1443	1668	1900	2140	2388	2643
		3	N/A	N/A	N/A	N/A	376	525	681	842	1009	1183
		4	149	305	469	641	820	1008	1203	1406	1616	1835

**Estimating — Base and Surfacing Quantities**

*Figure 520-5a*

Shoulder Section												
Shldr. Width Ws(ft)	Side Slope S:1	Case	Quantity in tons per mile*									
			Surfacing Depth (ft)									
			0.55	0.60	0.65	0.70	0.75	0.80	0.85	0.90	0.95	1.00
4	2	1	910	1004	1100	1198	1297	1399	1502	1608	1715	1824
		2	1063	1163	1266	1370	1476	1585	1695	1807	1922	2038
		3	779	868	960	1053	1148	1245	1344	1445	1548	1652
		4	918	1013	1110	1210	1311	1415	1520	1628	1738	1849
	3	1	971	1076	1185	1296	1410	1527	1647	1770	1896	2024
		2	1169	1286	1406	1529	1655	1785	1918	2053	2193	2335
		3	816	914	1016	1120	1228	1338	1451	1567	1686	1807
		4	989	1098	1210	1326	1444	1566	1691	1820	1951	2086
	4	1	1034	1151	1273	1398	1528	1661	1798	1939	2085	2234
		2	1289	1424	1564	1708	1857	2010	2168	2330	2497	2668
		3	855	963	1075	1191	1311	1435	1562	1694	1830	1969
		4	1070	1194	1323	1456	1594	1737	1884	2035	2191	2352
	6	1	1169	1312	1462	1617	1779	1947	2121	2301	2488	2680
		2	1579	1759	1947	2142	2346	2557	2776	3002	3237	3479
		3	937	1066	1200	1341	1488	1641	1800	1966	2138	2315
		4	1265	1426	1596	1773	1957	2150	2350	2558	2774	2998
6	2	1	1308	1438	1570	1704	1840	1978	2117	2259	2402	2548
		2	1603	1742	1883	2026	2171	2318	2467	2618	2771	2926
		3	1050	1174	1299	1426	1555	1686	1819	1954	2090	2229
		4	1315	1447	1581	1716	1854	1994	2135	2279	2425	2573
	3	1	1369	1510	1655	1802	1953	2106	2262	2421	2583	2748
		2	1729	1886	2046	2209	2376	2545	2718	2894	3073	3255
		3	1078	1209	1343	1480	1620	1763	1909	2058	2209	2363
		4	1387	1532	1681	1832	1987	2145	2306	2471	2638	2809
	4	1	1432	1586	1743	1905	2070	2240	2413	2591	2772	2957
		2	1871	2048	2229	2415	2606	2801	3000	3204	3412	3625
		3	1106	1246	1389	1537	1688	1843	2003	2166	2333	2504
		4	1467	1628	1793	1963	2137	2315	2499	2686	2878	3075
	6	1	1567	1746	1932	2124	2322	2526	2736	2953	3175	3404
		2	2215	2441	2674	2916	3164	3421	3685	3957	4237	4525
		3	1167	1325	1488	1658	1833	2015	2203	2398	2598	2805
		4	1663	1861	2066	2279	2500	2729	2965	3209	3461	3721
8	2	1	1706	1872	2040	2211	2383	2557	2732	2910	3090	3271
		2	2190	2367	2547	2728	2912	3097	3285	3475	3666	3860
		3	1281	1438	1597	1758	1921	2086	2253	2422	2592	2765
		4	1713	1881	2051	2223	2397	2573	2751	2930	3112	3296
	3	1	1766	1944	2125	2309	2495	2685	2877	3072	3271	3472
		2	2338	2534	2734	2937	3144	3353	3566	3782	4001	4223
		3	1300	1464	1631	1801	1974	2149	2328	2509	2693	2880
		4	1785	1966	2151	2339	2530	2724	2921	3122	3326	3533
	4	1	1830	2020	2214	2411	2613	2819	3028	3242	3459	3681
		2	2504	2722	2945	3172	3404	3641	3882	4128	4378	4632
		3	1320	1491	1666	1845	2028	2215	2405	2600	2799	3001
		4	1865	2062	2263	2469	2679	2894	3114	3337	3566	3799
	6	1	1965	2181	2402	2630	2864	3105	3351	3604	3863	4128
		2	2907	3178	3457	3743	4038	4340	4650	4967	5292	5626
		3	1363	1549	1741	1940	2144	2355	2572	2795	3024	3259
		4	2061	2295	2536	2786	3043	3308	3580	3861	4149	4445

**Estimating — Base and Surfacing Quantities**

*Figure 520-5b*



Shoulder Section												
Shldr. Width Ws(ft)	Side Slope S:1	Case	Quantity in tons per mile*									
			Surfacing Depth (ft)									
			0.05	0.10	0.15	0.20	0.25	0.30	0.35	0.40	0.45	0.50
10	2	1	182	366	551	739	928	1119	1312	1507	1704	1903
		2	773	969	1167	1367	1569	1773	1979	2187	2397	2609
		3	N/A	N/A	N/A	N/A	N/A	543	724	908	1094	1281
		4	182	366	552	740	930	1122	1315	1511	1709	1909
	3	1	182	368	556	747	941	1137	1337	1539	1745	1953
		2	802	1007	1215	1426	1640	1858	2079	2303	2530	2760
		3	N/A	N/A	N/A	N/A	N/A	543	725	910	1098	1289
		4	182	368	557	749	944	1143	1344	1549	1757	1968
	4	1	183	370	560	755	954	1156	1363	1573	1787	2006
		2	834	1049	1268	1492	1721	1954	2191	2433	2679	2930
		3	N/A	N/A	N/A	N/A	N/A	543	726	912	1103	1298
		4	183	371	563	760	961	1167	1377	1592	1811	2035
	6	1	184	374	570	773	982	1196	1417	1644	1878	2117
		2	913	1153	1399	1654	1916	2186	2464	2750	3043	3344
		3	N/A	N/A	N/A	N/A	N/A	543	727	917	1113	1316
		4	185	377	578	786	1001	1225	1456	1695	1942	2197
12	2	1	218	438	660	883	1109	1336	1566	1797	2030	2265
		2	1066	1301	1537	1776	2016	2259	2504	2750	2999	3249
		3	N/A	N/A	N/A	N/A	N/A	N/A	N/A	956	1175	1397
		4	218	438	660	884	1110	1339	1569	1801	2035	2271
	3	1	219	440	664	891	1121	1354	1590	1829	2071	2315
		2	1106	1351	1599	1850	2104	2362	2623	2887	3154	3424
		3	N/A	N/A	N/A	N/A	N/A	N/A	N/A	956	1177	1401
		4	219	441	666	894	1125	1360	1598	1839	2083	2330
	4	1	219	442	669	900	1134	1373	1616	1862	2113	2367
		2	1151	1407	1668	1933	2203	2478	2757	3040	3328	3621
		3	N/A	N/A	N/A	N/A	N/A	N/A	N/A	956	1179	1405
		4	219	443	672	904	1142	1384	1630	1881	2137	2397
	6	1	220	446	679	918	1162	1413	1671	1934	2203	2479
		2	1259	1544	1836	2136	2444	2759	3083	3414	3752	4099
		3	N/A	N/A	N/A	N/A	N/A	N/A	N/A	957	1182	1413
		4	221	450	686	930	1182	1442	1709	1985	2268	2558
Pavement Section												
Width W <sub>p</sub> (ft)	0.05	0.10	0.15	0.20	0.25	0.30	0.35	0.40	0.45	0.50		
11	199	398	597	796	995	1194	1393	1592	1791	1990		
12	217	434	651	868	1085	1302	1519	1737	1954	2171		
22	398	796	1194	1592	1990	2388	2786	3184	3582	3980		
24	434	868	1302	1737	2171	2605	3039	3473	3907	4341		
*Tabulated quantities are based on compacted weight of 1.85 tons/yd <sup>3</sup>												

**Estimating — Base and Surfacing Quantities**  
Figure 520-5c

Shoulder Section												
Shldr. Width W <sub>s</sub> (ft)	Side Slope S:1	Case	Quantity in tons per mile*									
			Surfacing Depth (ft)									
			0.55	0.60	0.65	0.70	0.75	0.80	0.85	0.90	0.95	1.00
10	2	1	2104	2306	2511	2717	2925	3135	3347	3561	3777	3995
		2	2823	3039	3257	3477	3699	3923	4149	4378	4608	4840
		3	1471	1662	1855	2050	2247	2446	2646	2849	3053	3260
		4	2111	2315	2521	2729	2939	3151	3366	3582	3800	4020
	3	1	2164	2378	2595	2815	3038	3264	3492	3724	3958	4195
		2	2994	3230	3470	3714	3960	4209	4462	4718	4977	5239
		3	1483	1680	1880	2082	2288	2496	2707	2921	3138	3358
		4	2183	2401	2621	2845	3072	3303	3536	3773	4013	4256
	4	1	2228	2454	2684	2918	3156	3398	3643	3893	4147	4404
		2	3186	3446	3710	3980	4253	4531	4814	5101	5393	5689
		3	1496	1699	1905	2116	2330	2548	2770	2996	3227	3460
		4	2263	2496	2734	2976	3222	3473	3729	3989	4253	4522
	6	1	2363	2615	2873	3137	3407	3684	3966	4255	4550	4851
		2	3653	3969	4294	4626	4965	5313	5668	6031	6402	6781
		3	1524	1739	1960	2187	2420	2660	2906	3157	3415	3679
		4	2459	2729	3007	3292	3585	3887	4195	4512	4836	5168
12	2	1	2502	2740	2981	3224	3468	3714	3962	4212	4464	4718
		2	3502	3757	4013	4272	4533	4795	5060	5327	5596	5866
		3	1620	1845	2072	2301	2532	2765	2999	3236	3474	3714
		4	2509	2750	2992	3236	3482	3730	3981	4233	4487	4743
	3	1	2562	2813	3066	3322	3581	3843	4107	4375	4645	4919
		2	3698	3975	4255	4538	4824	5114	5406	5702	6001	6304
		3	1627	1857	2089	2324	2562	2803	3047	3294	3544	3796
		4	2581	2835	3092	3352	3615	3882	4151	4424	4700	4980
	4	1	2626	2888	3154	3424	3698	3976	4258	4544	4834	5128
		2	3918	4220	4526	4837	5152	5472	5796	6125	6458	6796
		3	1635	1869	2107	2348	2594	2844	3098	3355	3617	3882
		4	2661	2930	3204	3482	3765	4052	4344	4640	4941	5246
	6	1	2761	3049	3343	3643	3950	4262	4581	4906	5237	5575
		2	4453	4815	5185	5562	5948	6341	6742	7150	7566	7991
		3	1651	1894	2144	2400	2662	2930	3205	3485	3772	4065
		4	2857	3163	3477	3799	4128	4465	4810	5163	5524	5892
Pavement Section												
Width W <sub>p</sub> (ft)	0.55	0.60	0.65	0.70	0.75	0.80	0.85	0.90	0.95	1.00		
11	2189	2388	2587	2786	2985	3184	3383	3582	3781	3980		
12	2388	2605	2822	3039	3256	3473	3690	3907	4124	4341		
22	4378	4775	5173	5571	5969	6367	6765	7163	7561	7959		
24	4775	5210	5644	6078	6512	6946	7380	7814	8249	8683		
*Tabulated quantities are based on compacted weight of 1.85 tons/yd <sup>3</sup>												

**Estimating — Base and Surfacing Quantities**  
*Figure 520-5d*





Shoulder Section												
Shldr. Width Ws(ft)	Side Slope S:1	Case	Quantity in tons per mile*									
			Surfacing Depth (ft)									
			1.05	1.10	1.15	1.20	1.25	1.30	1.35	1.40	1.45	1.50
10	2	1	4214	4436	4659	4884	5111	5340	5571	5804	6038	6275
		2	5074	5310	5548	5788	6031	6275	6521	6769	7019	7272
		3	3468	3678	3890	4104	4320	4537	4757	4978	5201	5427
		4	4242	4466	4692	4920	5150	5382	5617	5853	6091	6331
	3	1	4435	4678	4924	5173	5424	5679	5936	6196	6460	6726
		2	5505	5774	6045	6320	6599	6880	7165	7453	7744	8038
		3	3581	3806	4035	4266	4501	4738	4978	5221	5467	5715
		4	4503	4752	5005	5261	5520	5782	6048	6316	6588	6863
	4	1	4666	4931	5201	5474	5751	6032	6317	6606	6899	7196
		2	5990	6295	6605	6919	7238	7561	7889	8221	8558	8900
		3	3698	3940	4186	4436	4689	4947	5208	5474	5743	6017
		4	4796	5074	5357	5644	5935	6232	6532	6838	7147	7462
	6	1	5158	5472	5792	6117	6449	6787	7132	7482	7839	8202
		2	7167	7561	7963	8373	8790	9215	9648	10088	10537	10993
		3	3950	4226	4509	4798	5093	5394	5701	6015	6334	6660
		4	5508	5856	6211	6574	6945	7323	7710	8104	8506	8915
12	2	1	4974	5231	5491	5752	6015	6281	6548	6816	7087	7360
		2	6139	6414	6691	6969	7250	7533	7818	8104	8393	8684
		3	3956	4200	4446	4694	4944	5195	5449	5704	5961	6220
		4	5002	5262	5524	5788	6055	6323	6593	6866	7140	7416
	3	1	5195	5474	5756	6041	6329	6619	6913	7209	7509	7811
		2	6609	6918	7230	7545	7863	8184	8509	8837	9168	9502
		3	4052	4310	4571	4836	5103	5372	5645	5921	6199	6481
		4	5262	5548	5837	6129	6424	6723	7024	7329	7637	7948
	4	1	5425	5727	6033	6342	6656	6973	7294	7619	7948	8282
		2	7138	7485	7836	8192	8553	8917	9287	9661	10039	10422
		3	4151	4425	4702	4983	5268	5557	5850	6147	6448	6753
		4	5556	5870	6189	6512	6840	7172	7509	7851	8197	8547
	6	1	5918	6268	6624	6986	7354	7728	8109	8495	8888	9287
		2	8422	8862	9309	9764	10227	10698	11176	11662	12156	12657
		3	4364	4669	4981	5298	5622	5952	6288	6630	6979	7333
		4	6268	6652	7043	7442	7849	8264	8687	9117	9555	10001
Pavement Section												
Width W <sub>p</sub> (ft)	1.05	1.10	1.15	1.20	1.25	1.30	1.35	1.40	1.45	1.50		
11	4179	4378	4576	4775	4974	5173	5372	5571	5770	5969		
12	4558	4775	4993	5210	5427	5644	5861	6078	6295	6512		
22	8357	8755	9153	9551	9949	10347	10745	11143	11541	11939		
24	9117	9551	9985	10419	10853	11287	11722	12156	12590	13024		
*Tabulated quantities are based on compacted weight of 1.85 tons/yd <sup>3</sup>												

### Estimating — Base and Surfacing Quantities

Figure 520-5g

Shoulder Section												
Shldr. Width Ws(ft)	Side Slope S:1	Case	Quantity in tons per mile*									
			Surfacing Depth (ft)									
			1.55	1.60	1.65	1.70	1.75	1.80	1.85	1.90	1.95	2.00
10	2	1	6513	6753	6995	7239	7485	7733	7983	8234	8488	8743
		2	7526	7782	8041	8301	8563	8827	9094	9362	9632	9905
		3	5654	5883	6113	6346	6581	6817	7056	7296	7538	7782
		4	6573	6818	7064	7312	7562	7814	8069	8325	8583	8843
	3	1	6995	7266	7541	7819	8099	8382	8669	8958	9250	9545
		2	8335	8636	8940	9247	9557	9870	10187	10506	10829	11156
		3	5967	6221	6479	6739	7002	7268	7537	7809	8084	8361
		4	7141	7423	7707	7995	8286	8581	8878	9179	9482	9789
	4	1	7497	7802	8111	8423	8740	9060	9385	9713	10045	10381
		2	9246	9596	9951	10311	10675	11043	11416	11794	12176	12563
		3	6294	6575	6860	7149	7442	7739	8040	8344	8653	8966
		4	7780	8104	8432	8764	9101	9442	9788	10139	10494	10853
	6	1	8571	8946	9327	9715	10108	10508	10914	11326	11744	12169
		2	11457	11928	12408	12895	13390	13892	14403	14921	15447	15980
		3	6992	7330	7674	8025	8382	8744	9113	9488	9870	10257
		4	9333	9758	10191	10631	11079	11536	11999	12471	12950	13437
12	2	1	7634	7911	8189	8469	8751	9035	9321	9609	9899	10190
		2	8977	9272	9569	9868	10168	10471	10776	11083	11392	11703
		3	6481	6744	7009	7276	7544	7814	8087	8361	8637	8915
		4	7695	7975	8258	8542	8828	9117	9407	9700	9994	10291
	3	1	8116	8424	8735	9049	9365	9685	10007	10333	10661	10992
		2	9840	10180	10524	10871	11221	11575	11931	12291	12654	13020
		3	6765	7052	7342	7635	7931	8230	8532	8836	9144	9454
		4	8263	8581	8901	9225	9553	9883	10216	10553	10893	11236
	4	1	8619	8960	9304	9653	10006	10363	10723	11088	11456	11829
		2	10810	11202	11599	12000	12405	12816	13230	13650	14073	14502
		3	7061	7374	7691	8011	8335	8664	8996	9332	9672	10017
		4	8902	9262	9626	9994	10367	10745	11127	11514	11905	12300
	6	1	9692	10103	10521	10945	11374	11810	12253	12701	13155	13616
		2	13167	13684	14209	14741	15282	15830	16386	16949	17521	18100
		3	7694	8061	8434	8813	9199	9590	9988	10392	10802	11218
		4	10454	10915	11384	11861	12346	12838	13338	13846	14361	14885
Pavement Section												
Width W <sub>p</sub> (ft)	1.55	1.60	1.65	1.70	1.75	1.80	1.85	1.90	1.95	2.00		
11	6168	6367	6566	6765	6964	7163	7362	7561	7760	7959		
12	6729	6946	7163	7380	7597	7814	8031	8249	8466	8683		
22	12337	12735	13133	13530	13928	14326	14724	15122	15520	15918		
24	13458	13892	14326	14761	15195	15629	16063	16497	16931	17365		
*Tabulated quantities are based on compacted weight of 1.85 tons/yd <sup>3</sup>												

**Estimating — Base and Surfacing Quantities**  
*Figure 520-5h*

530.01	General
530.02	References
530.03	Geosynthetic Types and Characteristics
530.04	Geosynthetic Function Definitions and Applications
530.05	Design Approach for Geosynthetics
530.06	Design Responsibility
530.07	Documentation

### 530.01 General

Geosynthetics include a variety of manufactured products that are used in drainage, earthwork, erosion control, and soil reinforcement applications.

Several geosynthetic applications are addressed in the *Standard Specifications for Road, Bridge, and Municipal Construction* (Standard Specifications). These applications are as follows:

- Low survivability underground drainage
- Moderate survivability underground drainage
- Separation
- Soil stabilization
- Moderate survivability permanent erosion control
- High survivability permanent erosion control
- Ditch lining
- Temporary silt fence

The Standard Specifications address geosynthetic properties as well as installation requirements and are not site specific. Geosynthetic properties provided in the Standard Specifications are based on the range of soil conditions likely to be encountered in the state of Washington for the applications defined. Other applications, such as prefabricated edge drains, pond liners, and geotextile retaining walls, are currently handled by special provision.

Design responsibilities are discussed in 530.05 below and illustrated in Figures 530-4 and 5.

This chapter does not address applications where geosynthetics are used to help establish vegetation through temporary prevention of erosion (vegetation mats).

### 530.02 References

*Highway Runoff Manual*, M 31-15, WSDOT

*Hydraulics Manual*, M 23-03, WSDOT

*Pavement Guide for Design, Evaluation and Rehabilitation*, WSDOT

*Plans Preparation Manual*, M 22-31, WSDOT

*Standard Specifications for Road, Bridge, and Municipal Construction* (Standard Specifications), M 41-10, WSDOT

### 530.03 Geosynthetic Types and Characteristics

Geosynthetics include woven and nonwoven geotextiles, geogrids, geonets, geomembranes, and geocomposites. Terms used in the past for these construction materials include *fabrics*, *filter fabric*, or *filter cloth* which are for the most part synonymous with the newer term *geotextile*.

Photographs of the various types of geosynthetics are provided in Figure 530-6.

**Woven geotextiles** consist of slit polymer tapes, monofilament fibers, fibrillated yarns, or multifilament yarns simply woven into a mat. Woven geotextiles generally have relatively high strength and stiffness and, except for the monofilament wovens, relatively poor drainage characteristics.

**Nonwoven geotextiles** consist of a sheet of continuous or staple fibers entangled randomly into a felt in the case of needle-punched nonwovens, and pressed and melted together at the fiber contact points in the case of heat-bonded nonwovens. Nonwoven geotextiles tend to have low to medium strength and stiffness with high elongation at failure, and relatively good drainage characteristics. The high elongation characteristic gives them superior ability to deform around stones and sticks.

**Geogrids** consist of a polymer grid mat constructed either of coated yarns or punched and stretched polymer sheet and usually have high strength and stiffness. They are used primarily for soil reinforcement.

**Geonets** are similar to geogrids but are typically lighter weight, weaker, and have smaller mesh openings. They are used in light reinforcement applications or are combined with drainage geotextiles to form a drainage structure.

**Geomembranes** consist of impervious polymer sheets that are typically used to line ponds or landfills, or in some cases are placed over moisture sensitive swelling clays to control moisture.

**Geocomposites** include prefabricated edge drains, wall drains, and sheet drains, that consist typically of a cusped or dimpled polyethylene drainage core wrapped in a geotextile. The geotextile wrap keeps the core clean so that water can freely flow through the drainage core. The drainage core acts as a conduit. Prefabricated edge drains are used in place of shallow geotextile wrapped trench drains at the edges of the roadway to provide subgrade and base drainage. Wall drains and sheet drains are typically placed between the back of the wall and the soil to drain the soil retained by the wall.

### 530.04 Geosynthetic Function Definitions and Applications

The function of the geosynthetic varies with the application. See Figure 530-7 for pictorial representations of the various applications. The geosynthetic must be designed with its function(s) in the given application in mind. Typical geosynthetic functions include filtration, drainage, separation, reinforcement, and erosion control. Definitions of these functions and examples of applications where these functions are dominant are as follows:

**Geosynthetic filtration** is defined as the passage of water through the geosynthetic relatively unimpeded (permeability or permittivity) without allowing passage of soil through the geosynthetic (retention). This is the primary function of geotextiles in underground drainage applications.

**Drainage** is defined as the carrying of water in the plane of the geosynthetic as a conduit (transmissivity). This is a primary function of geocomposite drains and in some cases thick nonwoven needle-punched geotextiles placed in underground drainage applications where water must be transported away from a given location by the geosynthetic itself.

**Separation** is defined as the prevention of the mixing of two dissimilar materials. This is a primary function of geotextiles placed between a fine-grained subgrade and a granular base course beneath a roadway.

**Reinforcement** is defined as the strengthening of a soil mass by the inclusion of elements (geosynthetics) that have tensile strength. This is the primary function of high strength geotextiles and geogrids in geosynthetic reinforced wall or slope applications, or in roadways placed over very soft subgrade soils that are inadequate to support the weight of the construction equipment or even the embankment itself.

**Geosynthetic erosion control** is defined as the minimizing of surficial soil particle movement due to the flow of water over the surface of bare soil or due to the disturbance of soil caused by construction activities under or near bodies of water. This is the primary function of geotextiles used as silt fences or placed beneath riprap or other stones on soil slopes. Silt fences keep eroded soil particles on the construction site, whereas geotextiles placed beneath riprap or other stones on soil slopes prevent erosion from taking place at all. In general, the permanent erosion control methods described in this chapter are only used where more natural means (such as the use of biodegradable vegetation mats to establish vegetation to prevent erosion) are not feasible.

These functions control some of the geosynthetic properties, such as apparent opening size (AOS) and permittivity, and in some cases load-strain characteristics.



The application will also affect the geosynthetic installation conditions. These installation conditions influence the remaining geosynthetic properties needed, based on the *survivability* level required.

**Geosynthetic survivability** is defined as the ability of the geosynthetic to resist installation conditions without significant damage, such that the geosynthetic can function as intended. Survivability affects the strength properties of the geosynthetic required.

### 530.05 Design Approach for Geosynthetics

Four questions must be answered to complete a geosynthetic design:

- Is a geosynthetic really needed?
- What geosynthetic properties will ensure that the geosynthetic functions as intended?
- Where should the geosynthetic be located?
- Will maintenance of the geosynthetic, or the structure of which it is a part, be needed? And, if so, how will it be maintained?

The site conditions and purpose for the geotextile are reviewed to determine whether or not a geotextile is needed.

- For most drainage, separation, soil stabilization, permanent erosion control, and silt fence applications, if a geotextile is needed the geotextile properties in the Standard Specifications can be used.
- In some situations where soil conditions are especially troublesome or in critical or high risk applications, a project specific design may be needed.
- The location of the geosynthetic will depend on how it is intended to function. (See Figure 530-7 for examples.)
- Consider the flow path of any ground water or surface water when locating the geotextile as well as selecting the geotextile to be used. For example, in permanent erosion control applications, water may flow to the geotextile from the existing ground as well as from the surface through wave action, stream flow, or

overland sheet flow. For saturated fine sandy or silty subgrades, water must be able to flow from the subgrade through the geotextile soil stabilization layer during the pumping action caused by traffic loads.

Background information and the answers to each of these questions, or at least guidance to obtaining the answers to these questions, are provided for each Standard Specification application as follows:

#### (1) *Underground Drainage, Low and Moderate Survivability*

Geotextile used for underground drainage must provide filtration to allow water to reach the drain aggregate without allowing the aggregate to be contaminated by finer soil particles.

Geotextile filtration properties are a function of the soil type. For underground drainage applications, if the subgrade soil is relatively clean gravel or coarse sand, a geotextile is probably not required. At issue is whether or not there are enough fines in the surrounding soil to eventually clog the drain rock or drain pipe if unrestricted flow toward the drain is allowed.

To approximately match the geotextile filtration properties to various soil types, specifications for three classes of Construction Geotextile for Underground Drainage are available in the Standard Specifications. For underground drainage applications, use the gradation of the soil, specifically the percent by weight passing the #200 sieve, to select the drainage geotextile class required. Base selection of the appropriate class of geotextile on the following table:

Percent Passing the #200 Sieve	Geotextile Class
Less than 15%	A
15% to 50%	B
Greater than 50%	C

**Selection Criteria for Geotextile Class**

*Figure 530-1*

Obtain soil samples for geotextile underdrain design every 300 ft along the roadway alignment, using hand holes, and at major soil type transitions. This may be spread to every 1,000 ft if the soil conditions appear to be uniform. Use existing soil data where feasible instead of taking new soil samples.

If soil conditions vary widely along the alignment where underground drainage geotextile is anticipated, different classes of drainage geotextile may be required for specific sections of a continuous system.

Strength properties for the underground drainage geotextile depend on the survivability level required to resist installation stresses.

Low survivability designates that the installation stresses placed on the geotextile will be relatively low, requiring only moderate geotextile strength to resist potentially damaging installation conditions. Examples of low survivability level underground drainage applications include:

- Trench drains
- Drains placed behind walls or other structures to drain the backfill
- A geotextile filter sheet placed behind a gabion wall to prevent fines from being washed through the gabion wall face. Trench depths, or the height of the geotextile filter sheet behind gabion walls, must be less than or equal to 6 ft for the low survivability level.

In moderate survivability applications, significant installation stresses may occur, requiring higher geotextile strength. Examples of the moderate survivability application include:

- Trench drains with a depth of greater than 6 ft
- A geotextile filter sheet behind a gabion wall with a height greater than 6 ft
- Any area drain

An area drain is defined as a geotextile placed over or under a horizontal to moderately sloping (1.5H:1V or flatter slope) layer of drainage aggregate. Examples of area drains include:

- Drainage layers over cut-and-cover tunnels
- Rock buttress drainage
- Permeable base beneath highway pavement (see the *Pavement Guide for Design, Evaluation and Rehabilitation* for additional information on permeable bases)
- A parking lot drainage layer

Note that pipe wrapping (the geotextile is wrapped around the surface of the pipe) is not included as an underground drainage application.

Locate the geotextile such that it will function as intended. For example, if the objective is to keep the drainage aggregate surrounding a drain pipe clean, locate the geotextile such that it completely separates the drainage aggregate from more silty surrounding soils, which may include native soils as well as relatively silty roadway base or fill materials.

Consider the flow path of any ground water or surface water when locating the geotextile.

The flow path from the geotextile, as part of the ground water drainage, is typically directed to a surface water conveyance system. Design of surface water conveyance is guided by the *Hydraulics Manual*. The surface water conveyance must be low enough to prevent backflow and charging of the ground water drainage; typically by matching inverts of ground water drainage to crowns of surface water conveyance pipes. A 1 ft allowance is usually applied when connecting to open water or ditches.

## **(2) Separation**

Geotextile used for separation must prevent penetration of relatively fine grained subgrade soil into the ballast or other roadway or parking lot surfacing material to prevent contamination of the surfacing material (the separation function). This application may also apply to situations other than beneath roadway or parking lot surfacing where it is not necessary for water to drain through the geotextile unimpeded (filtration), but where separation of two dissimilar materials is required.

Separation geotextile should only be used in roadway applications where the subgrade is workable such that it can be prepared and compacted as required in Section 2-06.3 of the Standard Specifications, but without removal and replacement of the subgrade soil with granular material. Such removal and replacement defeats the purpose of the geotextile separator.

Separation geotextile placed beneath roadway surfacing is feasible if the subgrade resilient modulus is greater than 5,800 psi and if a saturated fine sandy, silty, or clayey subgrade is not likely to be present. Note that the feasibility of separation geotextile may be dependent on the time of year and weather conditions expected when the geotextile is to be installed.

For separation applications, a geotextile is not needed if the subgrade is dense and granular (silty sands and gravels), but is not saturated fine sands. In general, a separation geotextile is not needed if the subgrade resilient modulus is greater than 15,000 psi.

### **(3) Soil Stabilization**

Geotextile used for soil stabilization must function as a separator, a filtration layer, and to a minor extent as a reinforcement layer. This application is similar to the separation application, except that the subgrade is anticipated to be softer and wetter than in the separation application.

Soil stabilization geotextile is used in roadway applications if the subgrade is too soft and wet to be prepared and compacted as required in Section 2-06.3 of the Standard Specifications. Soil stabilization geotextile is placed directly on the soft subgrade material, even if some overexcavation of the subgrade is performed. Backfill to replace the overexcavated subgrade is not placed below the geotextile soil stabilization layer, as this would defeat the purpose of the geotextile.

The need for soil stabilization geotextile should be anticipated if the subgrade resilient modulus is less than or equal to 5,800 psi, or if a saturated fine sandy, silty, or clayey subgrade is likely to be present.

Consider the flow path of any ground water or surface water when locating the soil stabilization geotextile and when selecting the geotextile to be used. For saturated fine sandy or silty subgrades, water must be able to flow from the subgrade through the geotextile soil stabilization layer during the pumping action caused by traffic loads.

Even if the subgrade is not anticipated to be saturated based on available data, if the subgrade is silty or clayey and it is anticipated that the geotextile will be installed during prolonged wet weather, a soil stabilization geotextile may still be needed.

Soil stabilization geotextile should not be used for roadway fills greater than 5 ft in height or if extremely soft and wet silt, clay, or peat is anticipated at the subgrade level. (Such deposits may be encountered in wetlands, for example.) In such cases the reinforcement function becomes more dominant, requiring that a site-specific design be performed.

### **(4) Permanent Erosion Control, Moderate and High Survivability**

The primary function of geotextile used for permanent erosion control is to protect the soil beneath it from erosion due to water flowing over the protected soil.

The need for a permanent erosion control geotextile depends on the type and magnitude of water flow over the soil being considered for protection, the soil type in terms of its erodability, and the type and amount of vegetative cover present. (See the *Highway Runoff Manual*.)

The source of flowing water could be streams, man-made channels, wave action, or runoff. Water may also flow from the soil behind the geotextile depending on the ground water level.

If ground water cannot escape through the geotextile, an erosion control system failure termed *ballooning* (resulting from water pressure buildup behind the geotextile) or soil piping could occur. Therefore, the geotextile must have good filtration characteristics.

Three classes of permanent erosion control geotextile are available to approximately match geotextile filtration characteristics to the soil. In order to select the drainage geotextile class, determine the gradation of the soil, specifically the percent by weight passing the #200 sieve. Base selection of the appropriate class of geotextile using Figure 530-1.

A minimal amount of soil sampling and testing is needed to determine the geotextile class required. Permanent erosion control geotextile generally does not extend along the roadway alignment for significant distances as does underground drainage geotextile. One soil sample per permanent erosion control location is sufficient. If multiple erosion control locations are anticipated along a roadway alignment, soil sampling requirements for underground drainage can be applied.

If soil conditions vary widely along the alignment where permanent erosion control geotextile is anticipated, different classes of erosion control geotextile may be required for specific sections of a continuous system.

Examples of the permanent erosion control application are the placement of geotextile beneath riprap or gabions along drainage channels, shorelines, waterways, around bridge piers, and under slope protection for highway cut or fill slopes.

If a moderate survivability geotextile is to be used, the geotextile must be protected by a 12 in aggregate cushion and be placed on slopes of 2H:1V or flatter to keep installation stresses to a relatively low level. Large stones can cause significant damage to a moderate survivability geotextile if the geotextile is not protected in this manner. If these conditions are not met, then a high survivability erosion control geotextile must be used.

### **(5) Ditch Lining**

The primary function of the geotextile in a ditch lining application is to protect the soil beneath it from erosion.

This ditch lining application is limited to man-made ditches less than 16 ft wide at the top with side slopes of 2H:1V or flatter. (If the ditch does not meet these requirements, then permanent

erosion control, moderate or high survivability geotextile must be used.) It is assumed that only quarry spall sized stones or smaller will be placed on the geotextile so only a moderate survivability geotextile will be required.

Filtration is not a significant function in this application. Since the ditch is relatively shallow, it is expected that the main water source will be the water carried by the ditch, and little water will pass through the geotextile.

Another application with a similar geotextile function is the placement of geotextile below culvert outlets to prevent erosion at the outlet.

### **(6) Temporary Silt Fence**

The primary function of geotextile used in a temporary silt fence is to prevent eroded material from being transported away from the construction site by runoff water. The silt fence acts primarily as a temporary dam and secondarily as a filter.

In some cases, depending on the topography, the silt fence may also function as a barrier to direct flow to low areas at the bottom of swales where the water can be collected and temporarily ponded. It is desirable to avoid the barrier function as much as possible, as silt fences are best suited to intercepting sheet flow rather than concentrated flows as would occur in swales or intermittent drainage channels.

To function as intended, the silt fence should have a low enough permeability to allow the water to be temporarily retained behind the fence allowing suspended soil particles in the water to settle to the ground. If the retention time is too long, or if the flow rate of water is too high, the silt fence could be overtopped thus allowing silt laden water to escape. Therefore, a minimal amount of water must be able to flow through the fence at all times.

Temporary water ponding is considered the primary method of silt removal and the filtration capabilities of the fence are the second line of defense. However, removal of silt sized particles from the water directly by the geotextile creates severe filtration conditions for the geotextile, forcing the geotextile to either blind or allow the fines to pipe through the geotextile. (Blinding is

the coating of the geotextile surface with soil particles such that the openings are effectively plugged.) If the geotextile openings (AOS) are designed to be small enough to capture most of the suspended soil particles, the geotextile will likely blind, reducing the permeability enough to allow water to overtop the fence. Therefore, it is best to allow some geotextile openings that are large enough to allow the silt sized particles to easily pass through. Even if some silt particles pass through the fence, the water flow rate below the fence will be decreased and the volume of silt laden water passing through the geotextile is likely to be relatively small and the water is partially filtered.

The geotextile apparent opening size (AOS) and permittivity are typically used to specify the filtration performance of geotextiles. The geotextile function in silt fence applications is more complex than this and AOS and permittivity do not relate directly to how well a silt fence will perform. However, nominal values of AOS and permittivity can be specified such that the types of geotextile products known to perform satisfactorily in this application are selected. Such values are provided in the Standard Specifications.

The source of load on the geotextile is from silt buildup at the fence and water ponding. The amount of strength required to resist this load depends on whether or not the geotextile is supported with a wire or polymer grid mesh between the fence posts. Obviously, unsupported geotextile must have greater strength than supported geotextile. If the strength of the geotextile or its support system is inadequate, the silt fence could fail. Furthermore, unsupported geotextile must have enough stiffness such that it does not deform excessively and allow silt laden water to go over the top of the fence.

The need for a silt fence can be anticipated where construction activities will disturb and expose soil that could erode. The ground surface is considered disturbed if vegetative cover is at least partially removed over a significant area by construction activities. Consider whether or not silt laden runoff water from the disturbed area can reach an environmentally sensitive area or a

man-made storm water system. If the exposed soil is a clean sand or gravel or if a significant zone of heavy vegetative cover separates the exposed soil from the environmentally sensitive area, a silt fence may not even be needed. Obtain assistance from the Olympia Service Center (OSC) Hydraulics Section for help in determining whether or not a silt fence is needed in such situations.

The feasibility of a geotextile silt fence depends on the magnitude of water flow to the fence, the steepness of the slope behind the fence and whether or not flow is concentrated at the fence. If the silt fence is not feasible, alternative erosion control methods may be required. (See the *Highway Runoff Manual*.)

Consider all feasible erosion control options in terms of potential effectiveness and economy before making the final decision to use a silt fence. Select the best option for the site conditions, including site geometry and contours, soil type, and rainfall potential. Consider silt fences for temporary erosion control in disturbed areas in the following circumstances:

- Fully covering disturbed areas temporarily with polyethylene sheeting or other temporary covering is not feasible or practical.
- Permanent ground cover for disturbed areas is not yet established.
- Runoff water reaches the silt fence primarily as sheet flow rather than as concentrated flows, with the exception of some ditch and swale applications.
- Slopes above the silt fence are not steeper than 1.5H:1V.
- The sheet flow length (length of slope contributing runoff water to the silt fence) is not too long.

Maximum sheet flow lengths allowed for silt fences are provided in the following table which is based on the typical 2-year 24-hour design storm for Washington resulting in a 24-hour rainfall of 3 in.

Slope	Sheet Flow Length
1.5H:1V	100 ft
2H:1V	115 ft
4H:1V	150 ft
6H:1V	200 ft

**Maximum Sheet Flow Lengths for Silt Fences**

*Figure 530-2*

The sheet flow length represents the area contributing runoff water from precipitation. The sheet flow length is defined in Figure 530-8. The sheet flow lengths provided in Figure 530-2 were determined assuming a bare soil condition, with the soil classified as a silt. These are worst case assumptions because less runoff would be expected for sand or gravel soils or if some vegetation is present.

The sheet flow length is usually equal to or greater than the disturbed soil slope length. However, undisturbed sloping ground above the disturbed slope area may also contribute runoff to the silt fence area. The length of undisturbed sloping ground above the disturbed slope to included in the total contributing slope length depends on the amount and type of vegetation present, the slope steepness, and the degree of development above the slope.

If unsure whether the proposed silt fence meets the requirements in Figure 530-2, contact the OSC Hydraulics Section for assistance.

Average or Ditch Swale Grade	Ditch or Swale Storage Length	Allowable Contributing Area per Foot of Ditch or Swale Storage Width
16%	13 ft	200 ft <sup>2</sup>
10%	20 ft	250 ft <sup>2</sup>
5%	40 ft	300 ft <sup>2</sup>
4%	50 ft	400 ft <sup>2</sup>
3%	65 ft	500 ft <sup>2</sup>
2%	100 ft	600 ft <sup>2</sup>
1%	200 ft	1,000 ft <sup>2</sup>

**Maximum Contributing Area for Ditch and Swale Applications**

*Figure 530-3*

Temporary silt fences may also be used in ditch or swale applications. If the area contributing runoff to the fence exceeds the value determined from Figure 530-3, hydraulic overload will occur. The ditch or swale storage length and width are defined in Figure 530-9. The assumptions used in the development of Figure 530-3 are the same as those used for Figure 530-2 in terms of the design storm and ground conditions.

As an example, if a site has a 13-ft wide ditch with an average slope of 2%, the fence can be located such that 7,800 ft<sup>2</sup> of area drain to it. If it appears that the area draining to the fence will be larger than the allowable, it may be possible to divide the contributing area into smaller areas and add a silt fence for each smaller area as shown in Figure 530-10.

The minimum storage length for the ditch behind each silt fence must be maintained. If this is not possible, it may be necessary to use an alternate erosion control structure as described in the *Highway Runoff Manual* or to develop a special silt fence design.

Figure 530-3 was developed with the assumption that water will be able to pond to a depth of at least 2 ft behind the fence. If this is not the case (the ditch or swale depth is less than 2 ft), the table cannot be used. Furthermore, the ditch depth must be greater than the height of the silt fence at its lowest point within the ditch. Otherwise, there will not be enough storage available behind the fence and water will circumvent the fence by flowing around it.

Locate silt fences on contour as much as possible. At the ends of the fence turn it up hill such that it captures the runoff water and prevents water from flowing around the end of the fence. This is illustrated in Figure 530-11.

Silt fences are designed to capture up to a 2 ft depth of water behind the fence. Therefore, the ground line at the ends of the fence must be at least 2 ft above the ground line at the lowest part of the fence. This 2 ft requirement applies to ditches as well as to general slope erosion control.

If the fence must cross contours (except for the ends of the fence) use gravel check dams placed perpendicular to the back of the fence to minimize concentrated flow and erosion along the back of the fence. (See Figure 530-12.)

- The gravel check dams are approximately 1 ft high at the back of the fence and be continued perpendicular to the fence at the same elevation until the top of the dam intercepts the ground surface behind the fence.
- Locate the gravel check dams every 10 ft along the fence.
- In general, the slope of the fence line is not be steeper than 3H:1V.
- For the gravel check dams, use Crushed Surfacing Base Course Section 9-03.9(3)), Gravel Backfill for Walls Section 9-03.12(2), or Shoulder Ballast Section 9-03.9(2)).

If the silt fence application is considered critical (such as when the fence is placed immediately adjacent to environmentally sensitive areas such as streams, lakes, or wetlands) place a second silt fence below the first silt fence to capture any silt

that passes through the first fence and/or place straw bails behind the silt fence. Locate silt fences at least 7 ft from an environmentally sensitive area. Where this is impossible, and a silt fence must be used, a special design may be necessary.

Temporary silt fences are sometimes used to completely encircle underground drainage inlets or other similar features to prevent silt from entering the drainage system. This is acceptable, but the silt fence functions primarily as a barrier, and not as a ponding or filtering mechanism, unless the drainage inlet is in a depression that is large enough to allow water to pond behind the silt fence.

- If the drainage inlet and silt fence are not in a large enough depression, silt laden water will simply be directed around the fence and must be captured by another fence or sedimentation pond downslope.
- If the depression is deep, locate the silt fence no more than 2 ft below the top of the depression to prevent overtopping. A site-specific design may be needed if the silt fence is located deeper than 2 ft within the depression.

It may be necessary to relocate silt fences during the course of a construction project as cuts and fills are built or as disturbed areas change. An erosion control/silt fence plan that accounts for the anticipated construction stages (and eventual removal) should be developed. Do not assume that one silt fence location can routinely be used for the entire life of the contract. Periodically check the locations in the field during the construction project and field-adjust the silt fence locations as necessary to ensure that the silt fence functions as intended.

#### **(7) Standard Specification Geotextile Application Identification in the Plans**

Identify the geotextile in the contract plan detail in a way that ties it to the appropriate Standard Specification application. For example:

- If a geotextile is to be used to line an underground trench drain 3 ft in depth and the native soil has less than 15% passing the #200 sieve, identify the geotextile on the

plan sheet as “Construction Geotextile for Underground Drainage, Low Survivability, Class A.”

- If the geotextile is to be placed beneath riprap on a slope without a cushion layer between the geotextile and the riprap and the native soil contains 35% passing the #200 sieve, identify the geotextile on the plan sheet as “Construction Geotextile for Permanent Erosion Control, High Survivability, Class B.”
- If the geotextile is to be placed between the roadway base course and a moist silt subgrade with a resilient modulus of 6,500 psi, and the roadway is planned to be constructed during the dry summer and early fall months, identify the geotextile on the plan sheet as “Construction Geotextile for Separation.”

### **(8) Site-Specific Designs (All Applications)**

A site-specific design is required:

- For all reinforcement applications
- For applications not covered by the Standard Specifications

Consider a site-specific design:

- For high risk applications
- For exceptionally large geotextile projects: if the geotextile quantity in a single application is over 35,000 yd<sup>2</sup>, or over 85,000 yd<sup>2</sup> for the separation application
- For severe or unusual soil or ground water conditions
- If the soil in the vicinity of the proposed geotextile location consists of alternate thin layers of silt or clay with potentially water-bearing sand layers on the order of 1 to 3 in in thickness or less
- If the soil is known through past experience to be problematic for geosynthetic drains
- For drains in native soil behind structures except drains contained within granular backfill

- For drains designed to stabilize unstable slopes
- For drains designed to mitigate frost heave

In such cases, obtain assistance from the OSC Materials Laboratory Geotechnical Branch. To initiate the special design provide a plan and cross-section showing:

- The geosynthetic structure to be designed
- Its relative location to other adjacent structures that it could potentially affect
- Its intended purpose
- Any soil data in the vicinity

Consider a site-specific design for temporary silt fences:

- If silt fence must be used in intermittent streams or where a significant portion of the silt fence functions as a barrier that directs flow to the lower portions of the silt fence
- If the fence must be located on steep slopes
- In situations not meeting the requirements in Figures 530-2 and 3
- If the 2 year, 24 hour design storm for the site is greater than the 3 in assumed for the development of Figures 530-2 and 3
- Where concentrated flow is anticipated
- If closer than 7 ft from an environmentally sensitive area
- If more than 2 ft depth of storage is needed

For a site-specific temporary silt fence design, obtain assistance from the OSC Hydraulics Section. To initiate the design, send the following information to the OSC Hydraulics Section and a copy to the OSC Materials Laboratory Geotechnical Branch:

- Plan sheets showing proposed silt fence locations and grading contours
- Estimate of the area contributing runoff to each silt fence, including percentage and general type of vegetative cover within the contributing area
- Any available site soil information



For all site-specific designs of applications not covered by the Standard Specifications, complete plans and special provisions are needed. In general, for site-specific designs of Standard Specification applications, only a minor modification of the appropriate geotextile property table will be needed.

### **530.06 Design Responsibility**

The design responsibility and process for geotextile design are illustrated in Figures 530-4 and 5. The Regional Project Development Office, in particular the Regional Project Manager, is responsible to initiate and develop all Standard Specification geotextile designs, except for roadway separation and soil stabilization applications, which are initiated and developed by the Regional Materials Laboratory.

The Regional Materials Laboratory assists the Regional Project Manager with Standard Specifications underground drainage and permanent erosion control designs.

The Regional Environmental Design Section assists with Standard Specifications permanent erosion control and temporary silt fence designs.

Once the Regional Project Manager or Materials Laboratory has determined that a geotextile is appropriate, development of a Standard Specification geotextile design includes the development of plan details showing the plan location and cross-section of the geotextile installation. Standard details for geotextiles as provided in the *Plans Preparation Manual* may be used or modified to adapt to the specific project situation. Note that only minimum dimensions for drains are provided in these standard details.

Site-specific geosynthetic designs and applications not addressed by the Standard Specifications are designed by the region with the assistance of the OSC Materials Laboratory Geotechnical Branch or the OSC Hydraulic Section as described in 530.05.

Design assistance by the Geotechnical Branch or Hydraulics Section for site-specific design of Standard Specifications applications includes determination of geosynthetic properties and other advice as needed to complete the geosynthetic plans and any special provisions required.

The Geotechnical Branch is fully responsible to develop and complete the geosynthetic design, plan details that can be used to develop the contract plan sheets, and special provisions for geosynthetic reinforced walls, slopes, and embankments; deep trench drains for landslide stabilization; and other applications that are an integral part of an OSC geotechnical design. The Regional Project Manager incorporates the plan details and special provisions into the PS&E.

### **530.07 Documentation**

The following documents are to be preserved for future reference in the project file. See Chapter 330.

- Soil information
- Erosion control/silt fence plan

*P65:DP/DME*

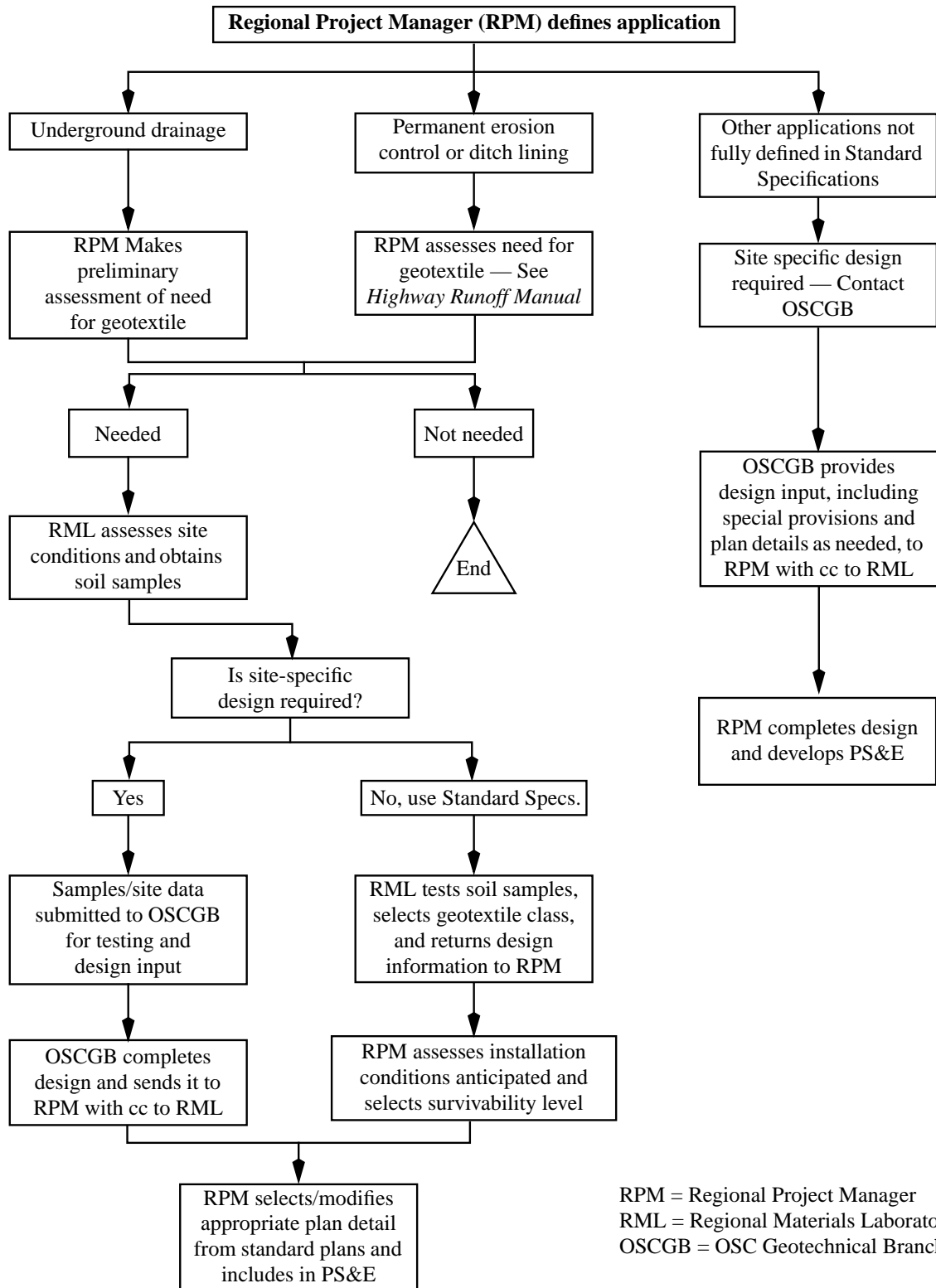

**Design Process for Drainage and Erosion Control  
 Geotextiles and Nonstandard Applications**

*Figure 530-4*

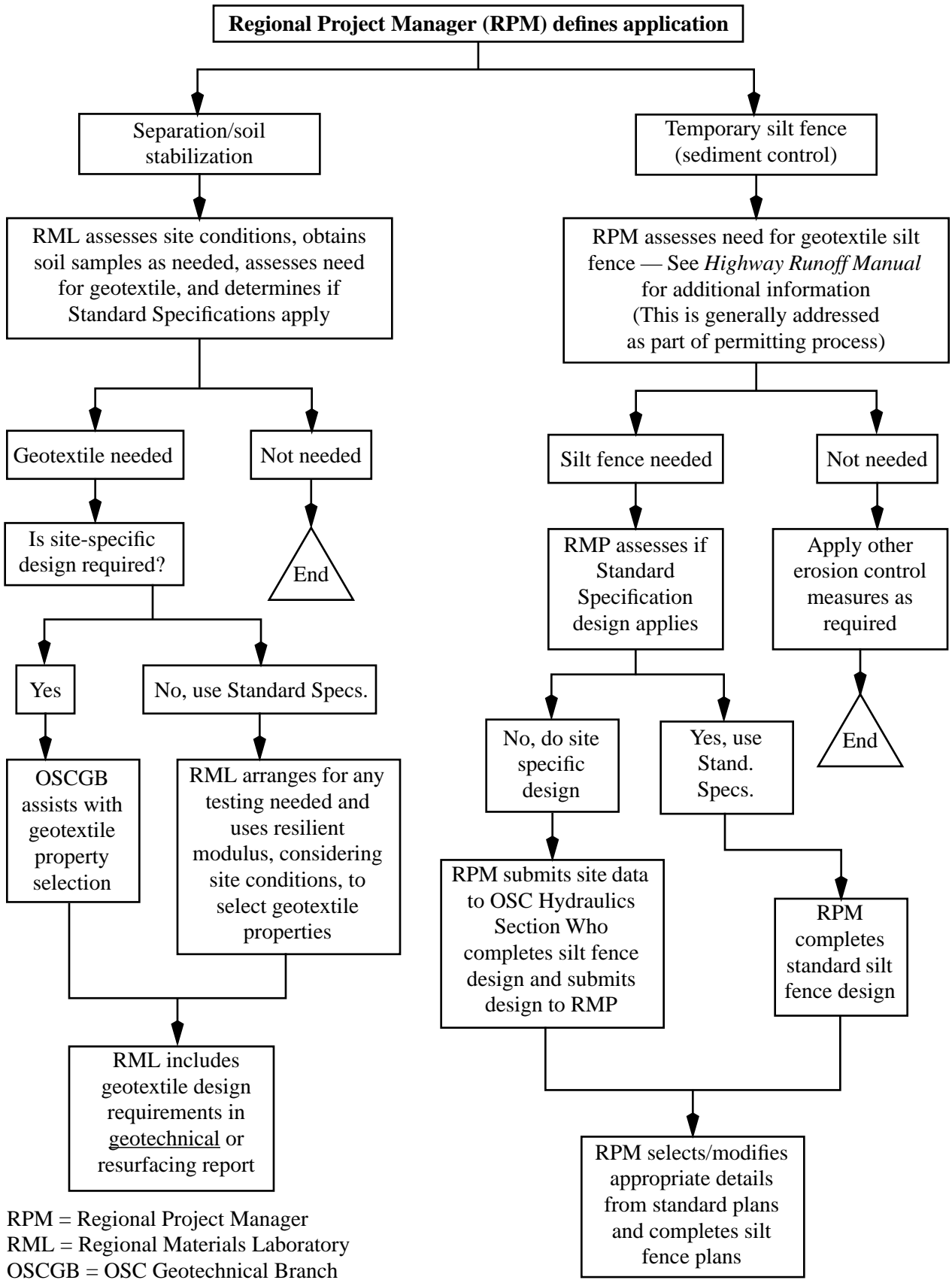

**Design Process for Separation, Soil Stabilization, and Silt Fence**

*Figure 530-5*

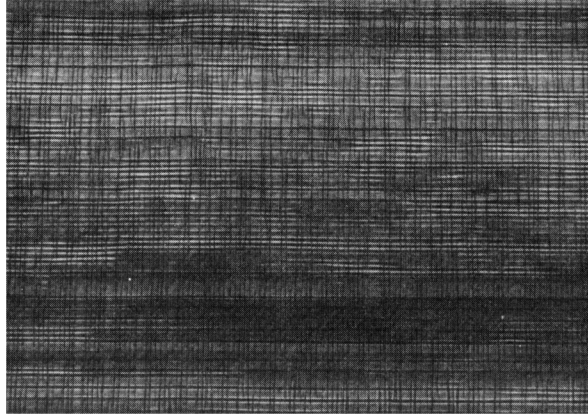

*Slit Film Woven Geotextile*

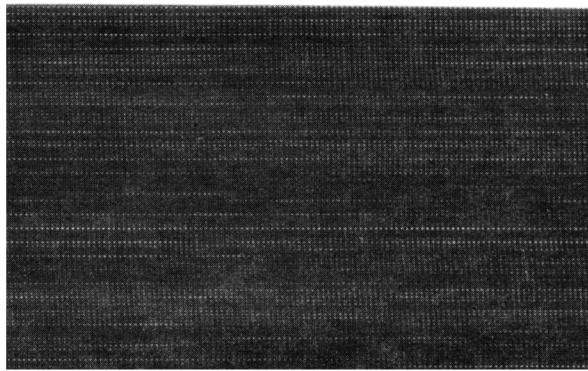

*Monofilament Woven Geotextile*

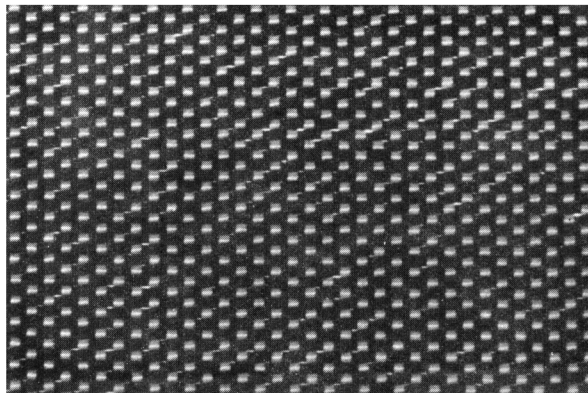

*Multifilament Woven Geotextile*

**Examples of Various Geosynthetics**  
*Figure 530-6a*

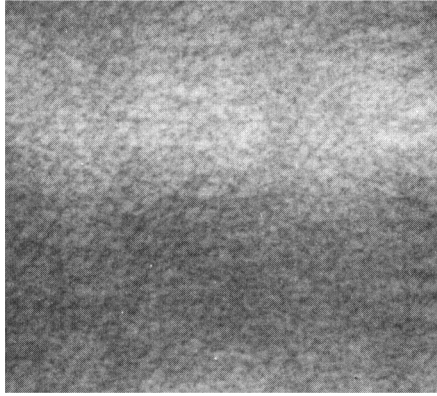

*Needle Punched Nonwoven Geotextile*

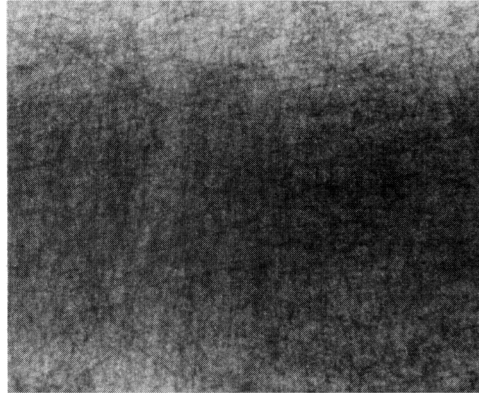

*Heat Bonded Nonwoven Geotextile*

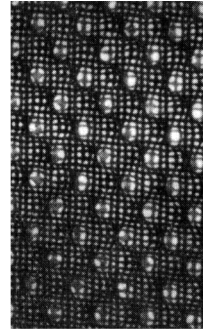
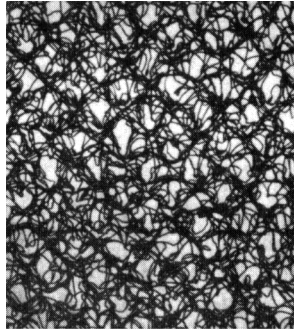
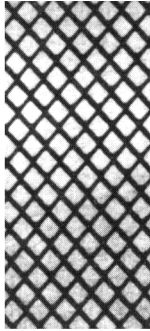

*Geocomposite Drains (Geotextile With Core)*

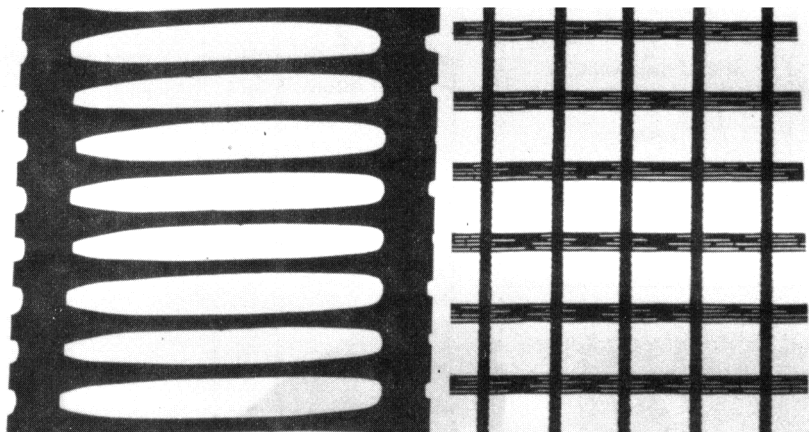

*Extruded and Woven Geogrids*

**Examples of Various Geosynthetics**

*Figure 530-6b*

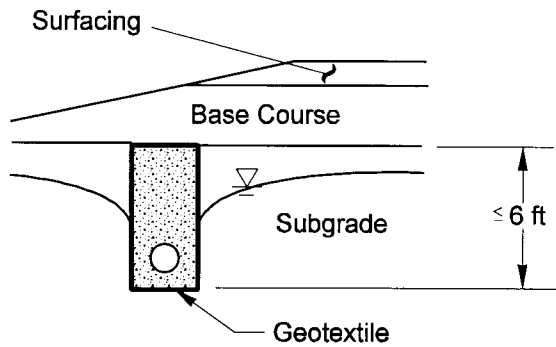

a. Underground drainage, low survivability (roadway trench drain)

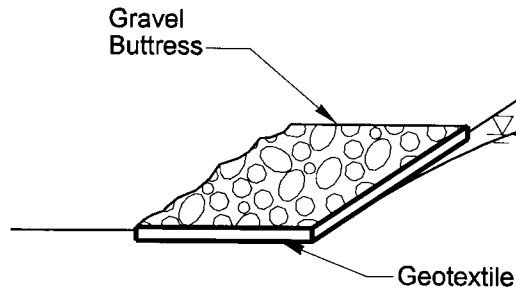

b. Underground drainage, moderate survivability (area drain beneath buttress)

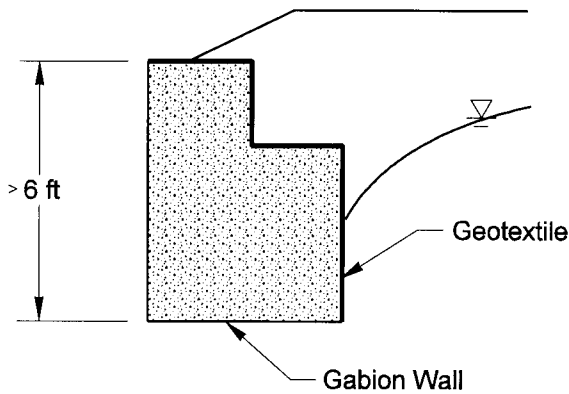

c. Underground drainage, moderate survivability (geotextile sheet drain)

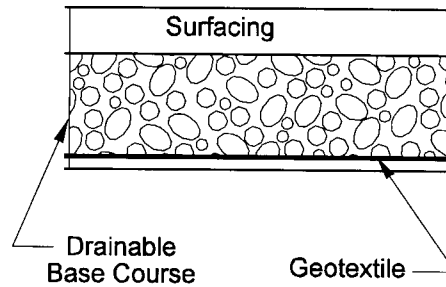

d. Underground drainage, moderate survivability (area drain beneath parking lot or roadway)

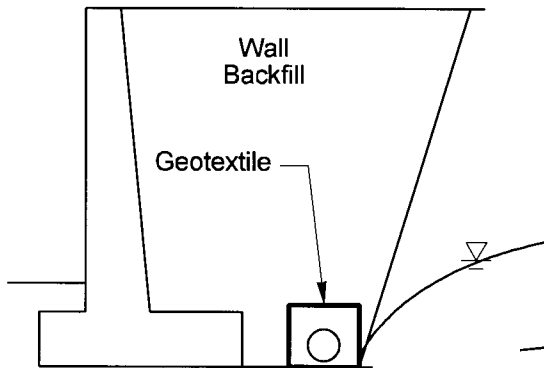

e. Underground drainage, low survivability (wrapped drain behind foundation)

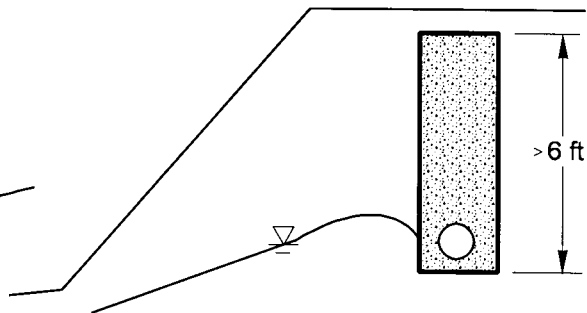

f. Underground drainage, moderate survivability (deep trench drain for slope stabilization)

### Geotextile Application Examples

Figure 530-7a

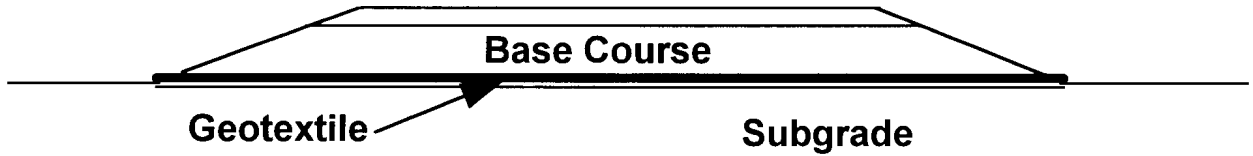

g. Separation or soil stabilization for new roadway (depends on subgrade condition)

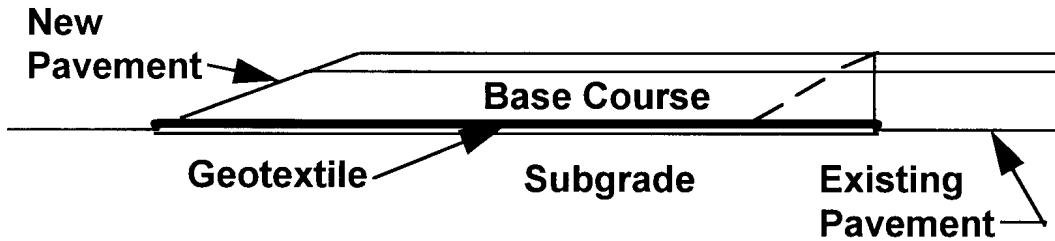

h. Separation or soil stabilization for widened roadway (depends on subgrade condition)

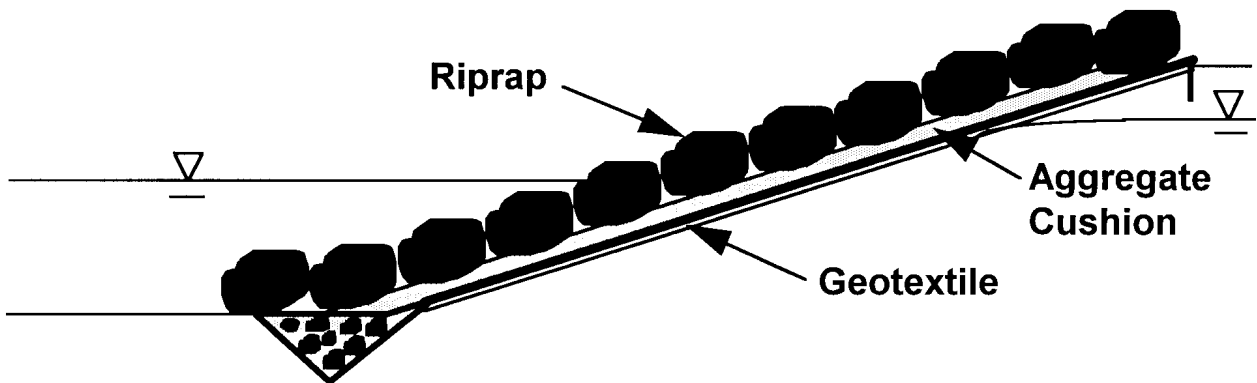

i. Permanent erosion control, moderate survivability

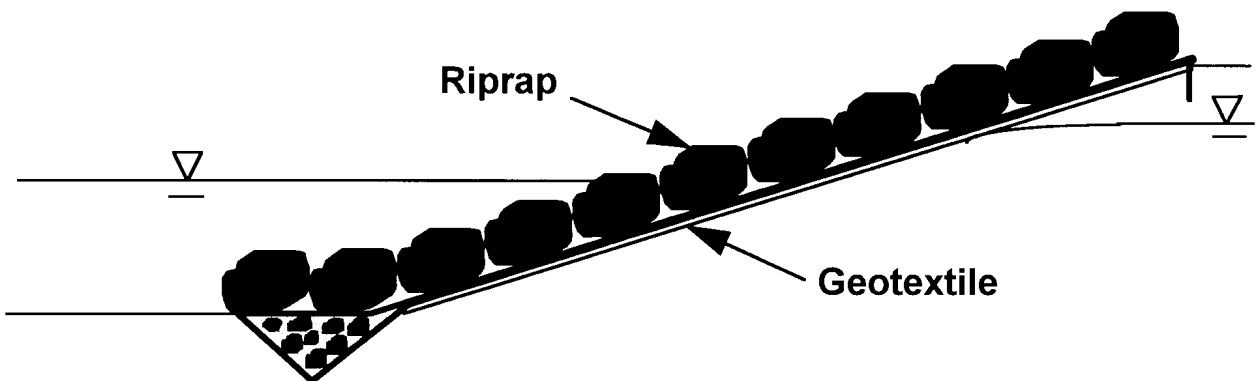

j. Permanent erosion control, high survivability

Geotextile Application Examples  
Figure 530-7b

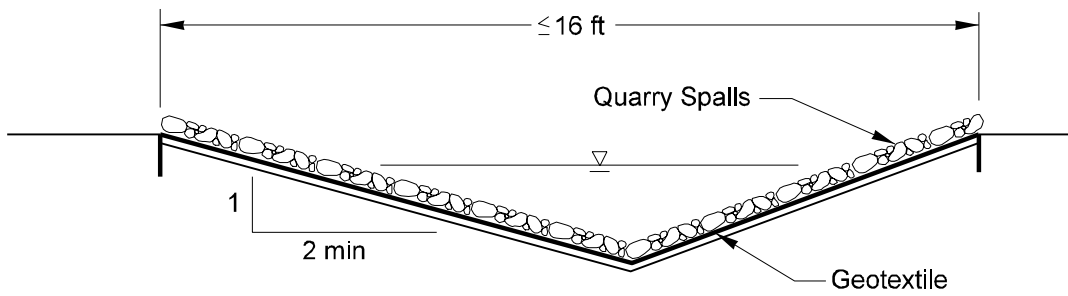

k. Ditch lining

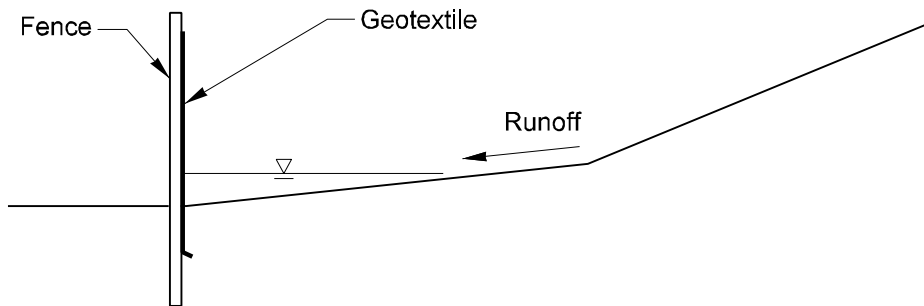

l. Silt fence not immediately adjacent to environmentally sensitive area

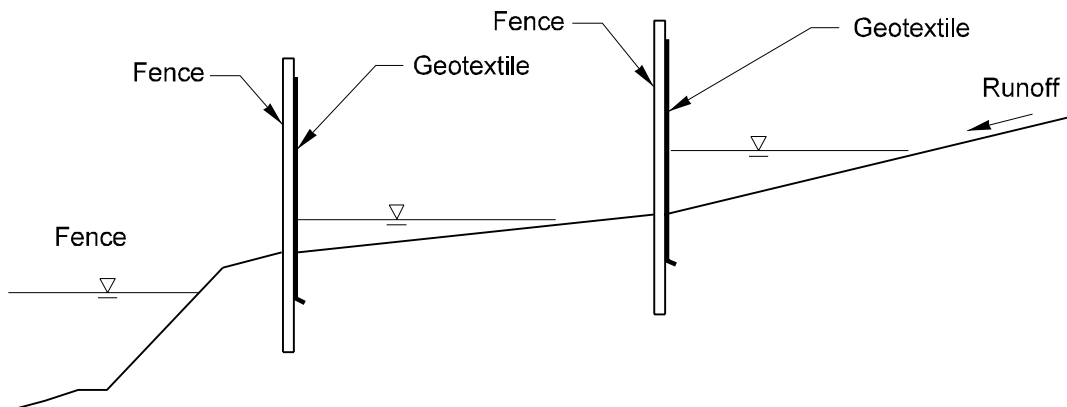

m. Silt fence immediately adjacent to environmentally sensitive area

**Geotextile Application Examples**  
*Figure 530-7c*



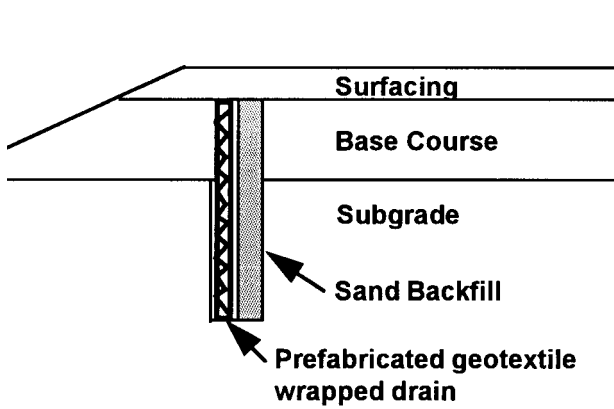

**n. Prefabricated edge drain for roadway**

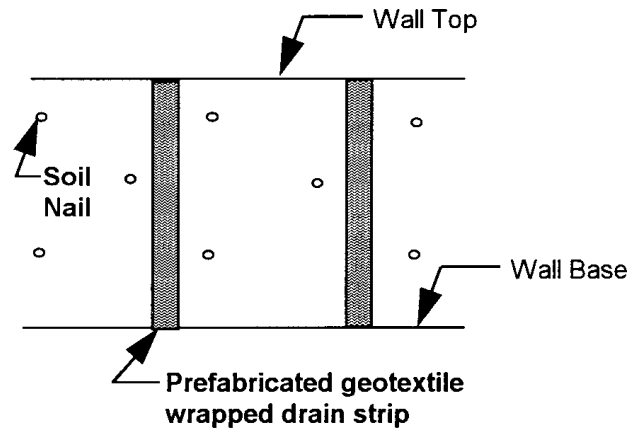

**o. Prefabricated drain strip behind wall face**

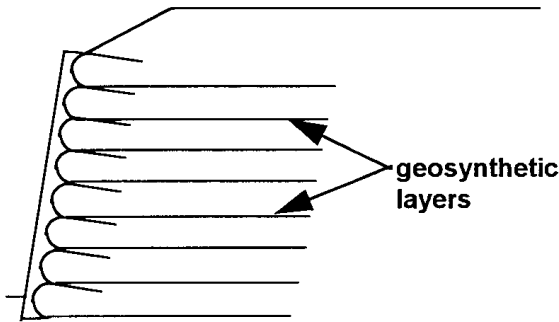

**p. Geosynthetic wall**

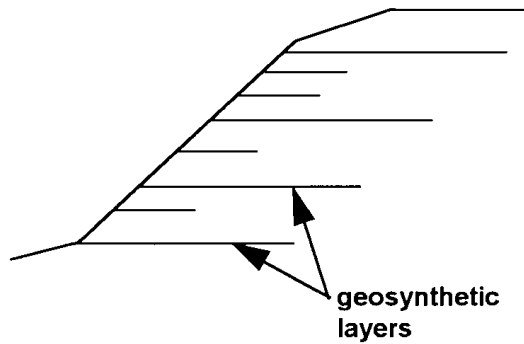

**q. Geosynthetic reinforced slope**

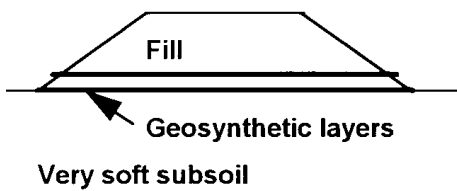

**r. Geosynthetic reinforced embankment**

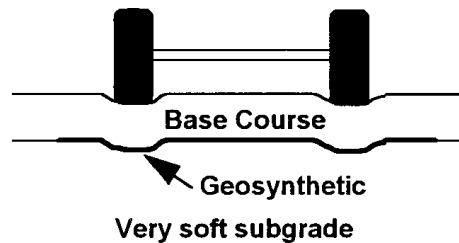

**s. Geosynthetic subgrade reinforcement for temporary roads**

**Geotextile Application Examples**  
*Figure 530-7d*

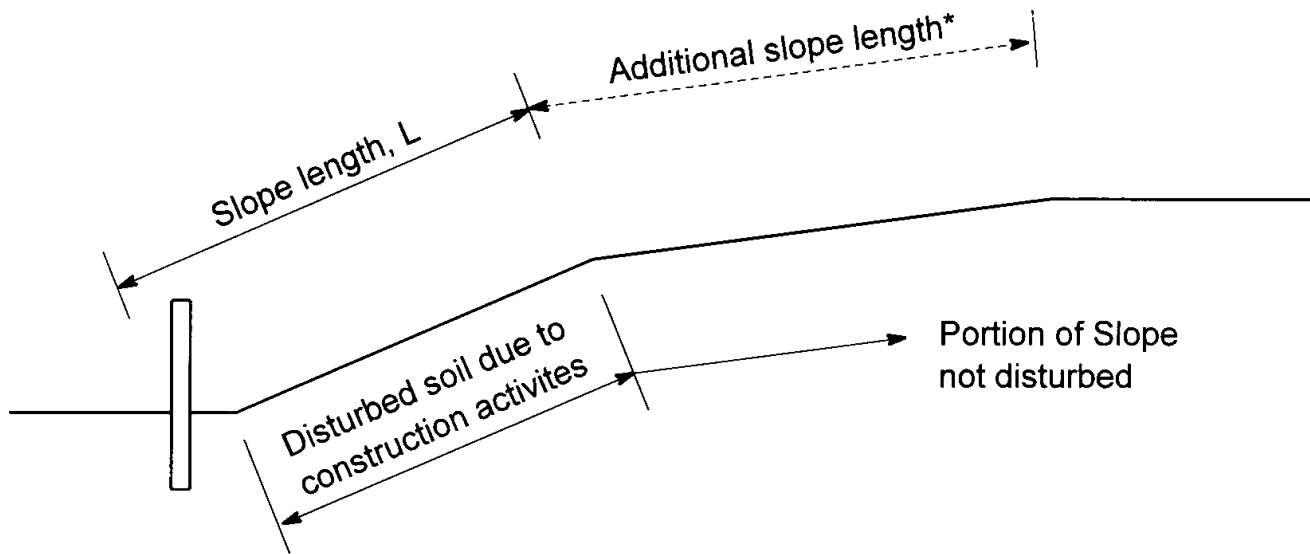

\*May need to be included as part of slope length depending on vegetative cover, slope steepness, and degree of development above slope.

**Definition of Slope Length**  
*Figure 530-8*

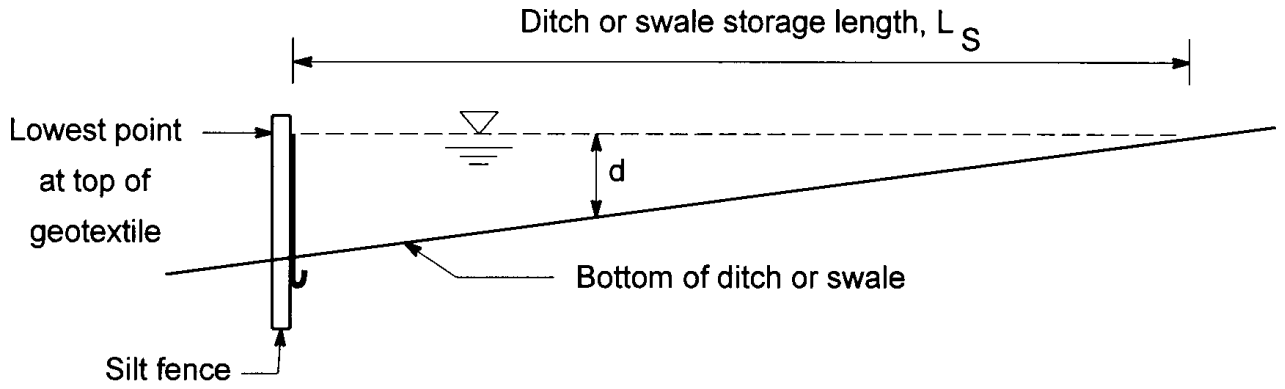

(a) Storage Length

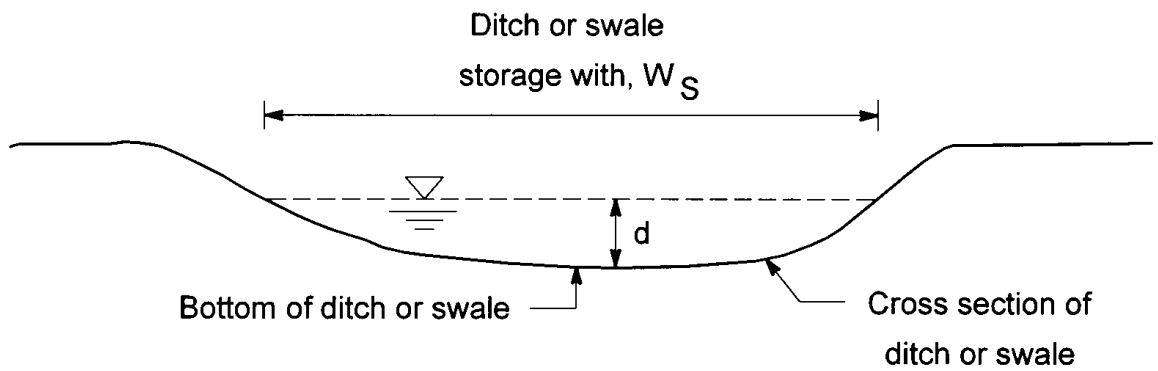

(b) Storage Width

**Definition of Ditch or Swale Storage Length and Width**

*Figure 530-9*

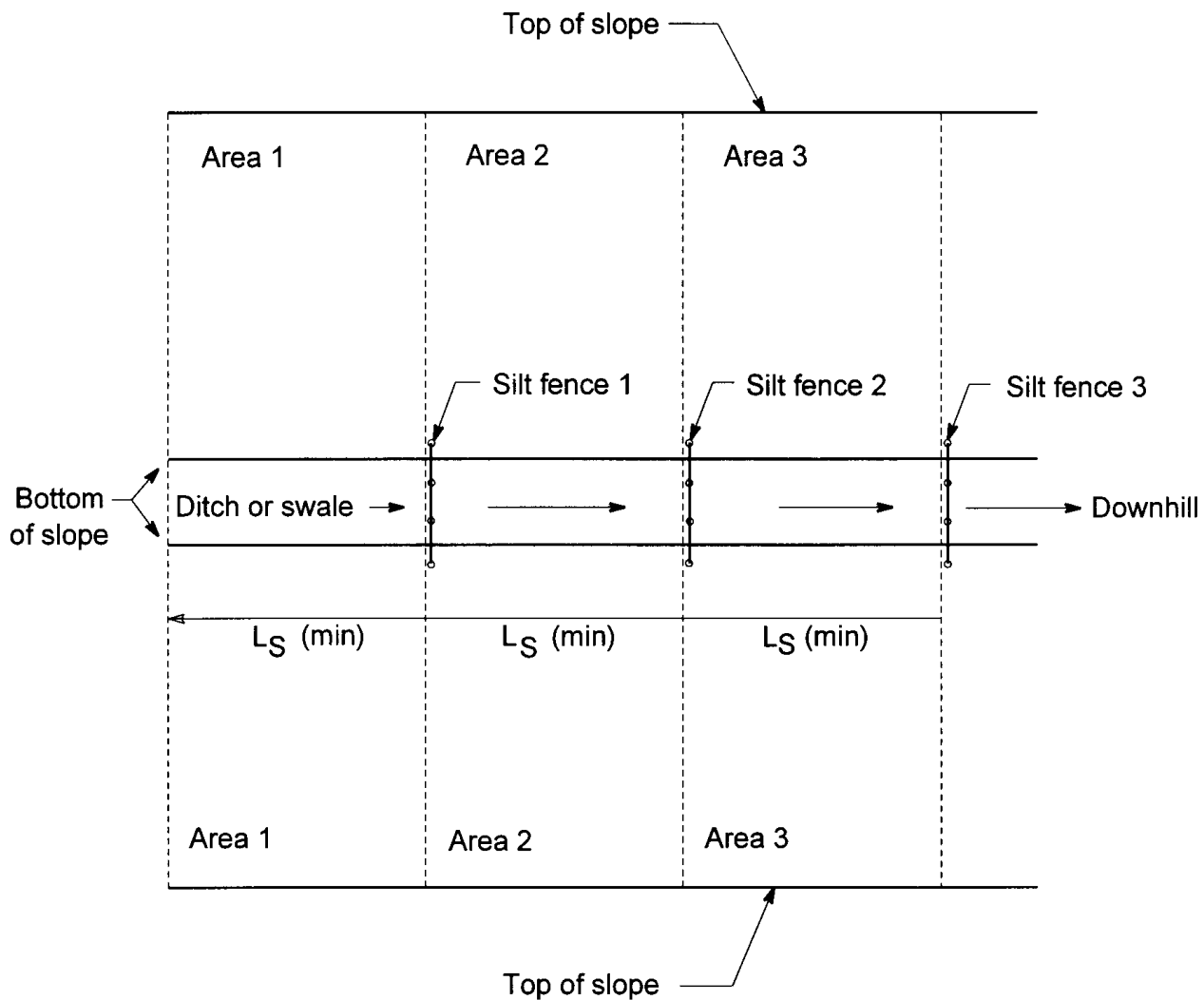

Method to keep contributing area to ditch or swale within allowable limits if contributing area too large based on Figure 530-3.

**Silt Fences for Large Contributing Area**  
*Figure 530-10*

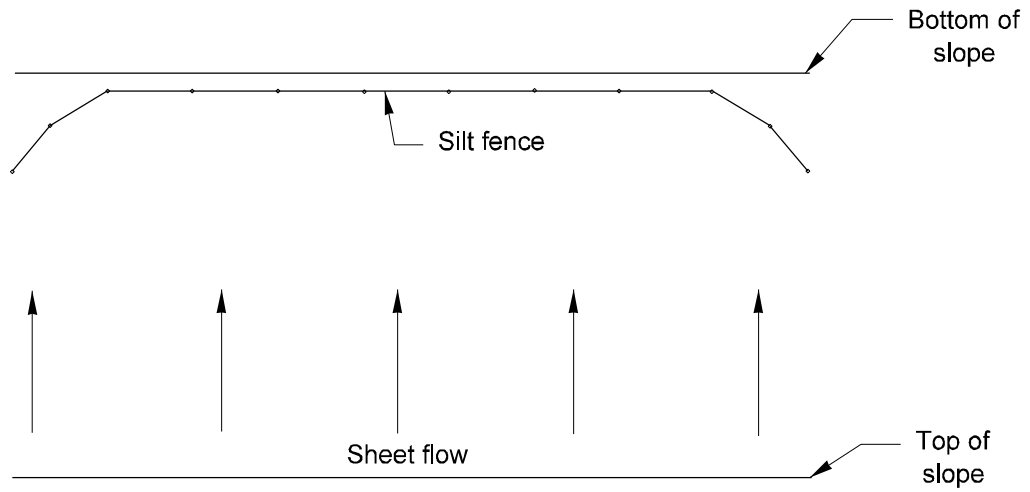

(a) Silt Fence Plan

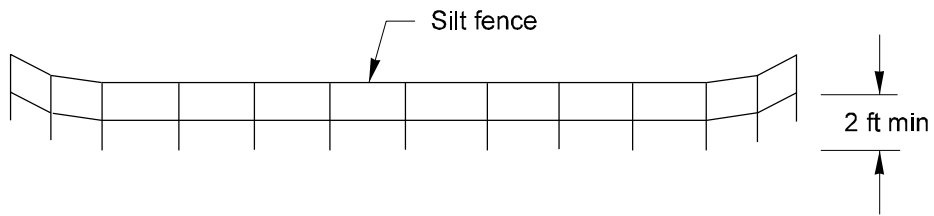

(b) Silt Fence Profile

Silt fence plan and profile illustrating how to insure silt fence will capture runoff water and not allow water to run around ends of fence.

### Silt Fence End Treatment

Figure 530-11

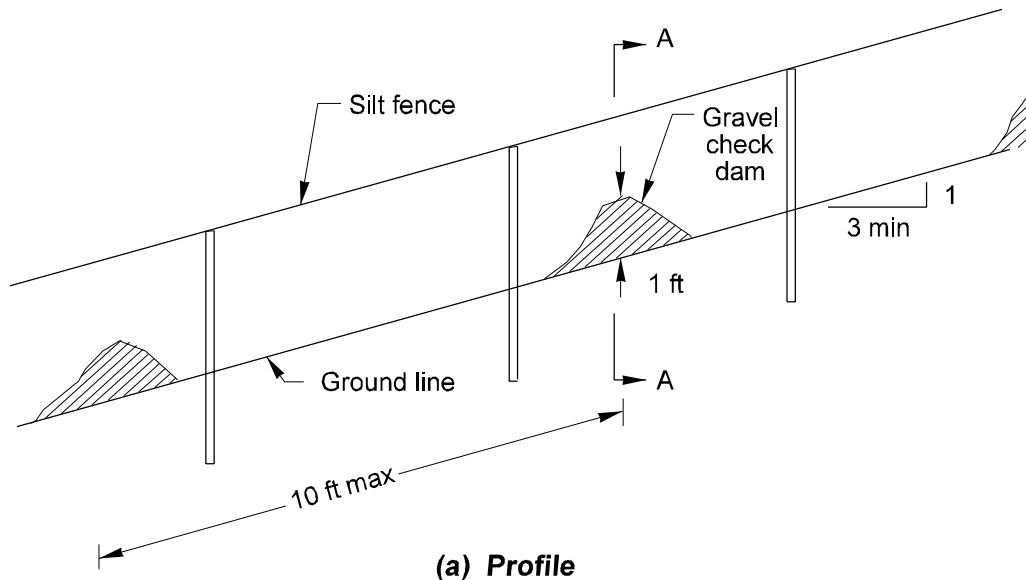

(a) Profile

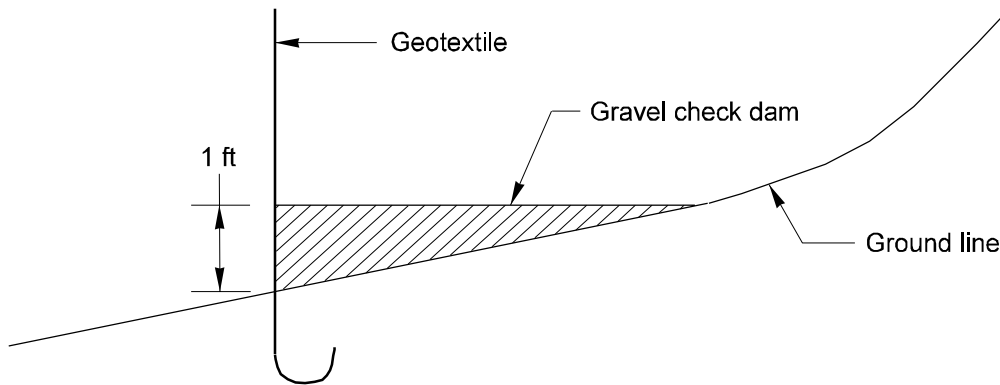

(b) Cross-Section A-A

**Gravel Check Dams for Silt Fences**  
*Figure 530-12*

# 610

## Highway Capacity

- 610.01 General
- 610.02 Definitions and Symbols
- 610.03 Design

### 610.01 GENERAL

The term “capacity” is used to express the maximum number of vehicles that have a reasonable expectation of passing over a section of a lane or a roadway during a given time period under prevailing roadway and traffic conditions. Highway capacity is of vital concern in the design of highways. A knowledge of highway capacity is essential to the proper fitting of a planned highway to the requirements of traffic. It helps both in the selection of highway type and in determining dimensional needs such as number of lanes.

The purpose of this section is to provide the user with enough information to perform a preliminary capacity analysis for basic highway sections. This chapter also gives a basis for determining the need for more detailed capacity analysis.

This Design Manual chapter does not cover preliminary capacity analysis for highway portions with signal spacing of less than 2 miles and those within 2,500 feet of interchange ramps.

### 610.02 DEFINITIONS AND SYMBOLS

#### (1) Definitions

**Average Daily Traffic (ADT).** The volume of traffic passing a point or segment of a highway, in both directions, during a period of time, divided by the number of days in the period and factored to represent an estimate of traffic volume for an average day of the year.

**Directional Design Hour Volume (DDHV).** The traffic volume for the peak hour in the peak direction of flow; usually a forecast of the relevant peak hour volume. (Units of DDHV are vehicles per hour. DDHV should be rounded to the nearest 50 vph.)

**Freeway.** A divided highway facility that has a minimum of two lanes for the exclusive use of traffic in each direction and full control of access.

**Level of Service (LOS).** A qualitative measure describing the operational conditions within a traffic stream; generally described in terms of such factors as speed, travel time, freedom to maneuver, comfort and convenience, safety, and others. See Figure 610-1 for appropriate design levels of service for different highway types.

**Multilane Highway.** A highway with at least two lanes for the exclusive use of traffic in each direction, with or

without partial control of access, that may have periodic interruptions to flow at signalized intersections.

**Peak Hour Factor (PHF).** The ratio of the volume occurring during the peak hour to the maximum rate of flow during a given time period within the peak hour. It is the measure of peaking characteristics of a highway section or intersection.

**Service Flow Rate (SFL).** The maximum hourly rate of flow that can be accommodated past a point or short uniform segment of traffic lane (for multilane) or the entire roadway (for a two-lane facility), under prevailing traffic, roadway, and control conditions while maintaining a stated level of service; value is specific to a given level of service.

#### Terrain.

- (a) **Level Terrain.** Any combination of grades and horizontal and vertical alignment permitting heavy vehicles to maintain approximately the same speed as passenger cars; this generally includes short grades of no more than 1 to 2 percent.
- (b) **Rolling Terrain.** Any combination of grades and horizontal or vertical alignment causing heavy vehicles to reduce their speeds substantially below those of passenger cars, but not causing heavy vehicles to operate at crawl speeds for any significant length of time.
- (c) **Mountainous Terrain.** Any combination of grades and horizontal and vertical alignment causing heavy vehicles to operate at crawl speeds for significant distances or at frequent intervals.

Heavy vehicle is defined as any vehicle having more than four tires touching the pavement. Crawl speed is the maximum sustained speed which heavy vehicles can maintain on an extended upgrade of a given percent.

#### (2) Symbols

- K** The percentage of ADT occurring in the peak hour.
- D** The percentage of peak hour traffic in the heaviest direction of flow.
- KD** The product of K and D.
- f<sub>E</sub>** Adjustment factor to account for the effect of the highway’s access and egress points (intersections, driveways, ramps) and whether or not it is a divided highway. (See Figure 610-2.)

## 610.03 DESIGN

### (1) Design Responsibility

District Location Project Engineer's office initiates the process of highway capacity determination and performs the capacity analysis for the highway segment under consideration. If the capacity analysis goes beyond the scope of this chapter, the district Traffic Design Office or the Travel Data Office of the headquarters Planning, Research and Public Transportation Division should be requested to do the analysis. This request should be made as soon as possible to ensure that the capacity analysis is completed during the design report stage.

### (2) Two-Lane Rural Highway

The objective of capacity analysis for two-lane rural highways is to determine the design level of service for a given segment for future sets of conditions.

- Determine the appropriate design level of service from Figure 610-1.
- Select the appropriate maximum allowable ADT directly from Figure 610-3 for the highway's level of service, K factor (percent of ADT occurring in peak traffic) and terrain type. No computations are needed at this stage.
- Compare the maximum allowable ADT to the expected ADT at design year. If the maximum allowable ADT is less than the design year ADT, a more detailed capacity analysis is warranted.

### (3) Multi-Lane Highway

- Determine the DDHV, given the anticipated ADT during the design year, using the formula:

$$DDHV = ADT \times KD \text{ where}$$

$$KD = \begin{array}{l} 0.11 \text{ for rural} \\ 0.08 \text{ for suburban} \\ 0.05 \text{ for urban} \end{array}$$

Use these general values when specific values for the particular corridor are unavailable. Generally, multi-lane highways with less than ten uncontrolled access points (driveways, intersections, ramps) per mile (on one side) are considered to be "rural" while those with more than ten uncontrolled access points per mile are considered to be suburban.

- Select an appropriate value of the service flow rate per lane (SFL) from Figure 610-4 for the highway's level of service (from Figure 610-1), environment type (urban, suburban, or rural) and terrain type.

- Determine the required number of lanes in each direction, N, from the formula:

$$N = DDHV / (SFL \times f_E \times PHF)$$

where  $f_E$  is found in Figure 610-2 and PHF in Figure 610-5. Round the value, "N", to the nearest whole number.

- Compare 2N to the number of lanes proposed. The proposed number of lanes should be greater than or equal to 2N. Otherwise, a more detailed capacity analysis is warranted.

### (4) Basic Freeway Sections

- Determine the DDHV, given the anticipated ADT during the design year, using the formula:

$$DDHV = ADT \times KD \text{ where}$$

$$KD = \begin{array}{l} 0.11 \text{ for rural freeways} \\ 0.07 \text{ for suburban freeways} \\ 0.05 \text{ for urban freeways} \end{array}$$

Use these values when specific values for the particular corridor are unavailable.

- Select an appropriate value of the service flow rate per lane, SFL, from Figure 610-6 for the prevailing truck percentage and terrain and for the required LOS (from Figure 610-1).
- Determine the required number of lanes in one direction, N, from the formula:

$$N = DDHV / (SFL \times PHF)$$

where PHF can be obtained from Figure 610-5. Round the value, "N", to the nearest whole number.

- Compare 2N to the number of lanes proposed. The proposed number of lanes should be greater than or equal to 2N. Otherwise, a more detailed capacity analysis is warranted.

### (5) Miscellaneous Highway Sections

For the capacity analysis of intersections, highways with signal spacing of 2 miles or less, highways within 2,500 feet of interchange ramps, ramps, weaving sections, transit systems, and bicycle and pedestrian trails, refer to the *Highway Capacity Manual* (Special Report No. 209, Washington, D.C.: Highway Research Board, 1985). Refer to Chapter 910 for channelization guidelines. The district Traffic Design Office or the Travel Data Office of the Headquarters Planning, Research and Public Transportation Division should be requested to do the capacity analysis on these miscellaneous highway sections.



<u>Highway Type</u> <sup>2</sup>	<u>Rural</u> <sup>1</sup> <u>Level</u>	<u>Rural</u> <sup>1</sup> <u>Rolling</u>	<u>Rural</u> <sup>1</sup> <u>Mountainous</u>	<u>Urban and</u> <sup>1</sup> <u>Suburban</u>
Principal Arterial	B	B	B	C
Minor Arterial	B	B	C	C
Collector	C	C	D	D
Local Access	D	D	D	D

**NOTES:**

- (1) Refer to 610.02 and Chapter 440 for definitions of these area types.  
(2) Refer to Chapters 120 & 440 for definitions of these highway types.

**TYPE OF AREA AND APPROPRIATE LEVEL OF SERVICE**

Figure 610-1

<u>Type</u>	<u>No Access Control</u>		<u>Partial Access Control</u>	
	<u>Divided</u>	<u>Undivided</u>	<u>Divided</u>	<u>Undivided</u>
Rural	1.00	0.95	1.00	0.95
Suburban	0.90	0.80	1.00	0.95

**ADJUSTMENT FACTOR FOR TYPE OF MULTILANE HIGHWAY AND DEVELOPMENT ENVIRONMENT,  $f_E$**

Figure 610-2

K-FACTOR	LEVEL OF SERVICE				
	A	B	C	D	E
Level Terrain <sup>2</sup>					
0.10	2,400	4,800	7,900	13,500	22,900
0.11	2,200	4,400	7,200	12,200	20,800
0.12	2,000	4,000	6,600	11,200	19,000
0.13	1,900	3,700	6,100	10,400	17,600
0.14	1,700	3,400	5,700	9,600	16,300
0.15 <sup>5</sup>	1,600 <sup>5</sup>	3,200 <sup>5</sup>	5,300 <sup>5</sup>	9,000 <sup>5</sup>	15,200 <sup>5</sup>
Rolling Terrain <sup>3</sup>					
0.10	1,100	2,800	5,200	8,000	14,800
0.11	1,000	2,500	4,700	7,200	13,500
0.12	900	2,300	4,400	6,600	12,300
0.13	900	2,100	4,000	6,100	11,400
0.14	800	2,000	3,700	5,700	10,600
0.15 <sup>5</sup>	700 <sup>5</sup>	1,800 <sup>5</sup>	3,500 <sup>5</sup>	5,300 <sup>5</sup>	9,900 <sup>5</sup>
Mountainous Terrain <sup>4</sup>					
0.10	500	1,300	2,400	3,700	8,100
0.11	400	1,200	2,200	3,400	7,300
0.12	400	1,100	2,000	3,100	6,700
0.13	400	1,000	1,800	2,900	6,200
0.14	300	900	1,700	2,700	5,800
0.15 <sup>5</sup>	300 <sup>5</sup>	900 <sup>5</sup>	1,600 <sup>5</sup>	2,500 <sup>5</sup>	5,400 <sup>5</sup>

**NOTES:**

- (1) Assumed conditions include 60/40 directional split, 14 percent trucks, 4 percent RV's and no buses.
- (2) 20 percent, no passing zones.
- (3) 40 percent, no passing zones.
- (4) 60 percent, no passing zones.
- (5) Use for rural two-lane highways, when k-factor is unavailable.

**MAXIMUM ADT VS. LEVEL OF SERVICE AND  
TYPE OF TERRAIN FOR TWO-LANE RURAL HIGHWAYS<sup>1</sup>**

Figure 610-3

LEVEL OF SERVICE	PERCENT TRUCKS <sup>2</sup>				
	0	5	10	15	20
Level Terrain					
A	700	700	650	650	600
B	1,100	1,050	1,000	1,000	1,000
C	1,400	1,350	1,300	1,250	1,250
D	1,750	1,700	1,650	1,600	1,550
E	2,000	1,950	1,850	1,800	1,750
Rolling Terrain					
A	700	600	550	500	450
B	1,100	950	850	800	700
C	1,400	1,200	1,100	1,000	900
D	1,750	1,500	1,350	1,250	1,100
E	2,000	1,750	1,550	1,450	1,250
Mountainous Terrain					
A	700	500	400	350	300
B	1,100	800	650	550	450
C	1,400	1,050	850	700	600
D	1,750	1,300	1,050	850	750
E	2,000	1,500	1,200	1,000	850

**NOTES:**

- (1) Service flow rates are in units of vehicles per hour per lane (vphpl).
- (2) Truck percentages should include both the single units (two and three axle trucks and buses) and the combinations (trucks with trailers and trailer combinations).

**SERVICE FLOW RATE PER LANE (SFL)<sup>1</sup> FOR MULTILANE HIGHWAYS**

Figure 610-4

<u>Metropolitan Area Population</u>	<u>Peak-Hour Factor</u>
Over 1,000,000	0.91
500,000 - 1,000,000	0.83
Under 500,000	0.77

**PEAK-HOUR FACTORS**

Figure 610-5

LEVEL OF SERVICE	PERCENT TRUCKS <sup>2</sup>				
	0	5	10	15	20
Level Terrain					
A	700	650	650	600	600
B	1,100	1,050	1,000	950	950
C	1,550	1,500	1,450	1,350	1,300
D	1,850	1,800	1,700	1,600	1,550
E	2,000	1,900	1,850	1,750	1,700
Rolling Terrain					
A	700	600	550	500	450
B	1,100	950	850	750	700
C	1,550	1,350	1,200	1,050	1,000
D	1,850	1,600	1,400	1,300	1,150
E	2,000	1,750	1,550	1,400	1,250
Mountainous Terrain					
A	700	500	400	350	230
B	1,100	800	650	550	400
C	1,550	1,150	900	750	550
D	1,850	1,350	1,100	900	650
E	2,000	1,500	1,200	1,000	700

**NOTES:**

- (1) Service flow rates are in units of vehicles per hour per lane (vphpl).
- (2) Truck percentages should include both the single units (two and three axle trucks and buses) and the combinations (trucks with trailers and trailer combinations).

**SERVICE FLOW RATES PER LANE (SFL) FREEWAYS<sup>1</sup>**

Figure 610-6

620.01	General
620.02	References
620.03	Definitions
620.04	Horizontal Alignment
620.05	Distribution Facilities
620.06	Number of Lanes and Arrangement
620.07	Pavement Transitions
620.08	Procedures
620.09	Documentation

### 620.01 General

This chapter provides guidance on the design of horizontal alignment, frontage roads, number of lanes, the arrangement of the lanes, and pavement transitions. See the following chapters for additional information:

Chapter	Subject
430	All roadway width requirements for modified design level
440	Lane and shoulder width requirements for full design level
640	Open highway and ramp lane widths on turning roadways for full design level
640	Superelevation rate and transitions
650	Sight distance
910	Shy distance requirements for curbs and islands

### 620.02 References

*Washington Administrative Code (WAC)* 468-18-040, "Design standards for rearranged county roads, frontage roads, access roads, intersections, ramps and crossings"

*Utilities Manual*, M 22-87, WSDOT

*Plans Preparation Manual*, M 22-31, WSDOT

*Manual on Uniform Traffic Control Devices for Streets and Highways (MUTCD)*, USDOT, FHWA; including the *Washington State Modifications to the MUTCD*, M 24-01, WSDOT

*Right of Way Manual*, M 26-01, WSDOT

*Local Agency Guidelines (LAG)*, M 36-63, WSDOT

*A Policy on Geometric Design of Highways and Street*, 1994, AASHTO

### 620.03 Definitions

**auxiliary lane** The portion of the roadway adjoining the traveled way for parking, speed change, turning, storage for turning, weaving, truck climbing, passing, and other purposes supplementary to through-traffic movement

**basic number of lanes** The minimum number of general purpose lanes designated and maintained over a significant length of highway

**frontage road** An auxiliary road that is a local road or street located on the side of a highway for service to abutting property and adjacent areas and for control of access

**outer separation** The area between the outside edge of the through highway lanes and the inside edge of a frontage road

**turning roadway** A curve on an open highway, a curve on a ramp, or a connecting roadway between two intersecting legs of an intersection

### 620.04 Horizontal Alignment

#### (1) General

Horizontal and vertical alignments (Chapter 630) are the primary controlling elements for highway design. It is important to coordinate these two elements with design speed, drainage, intersection design, and aesthetic principles in the early stages of design.

Figures 620-1a and 1c show both desirable and undesirable alignment examples for use with the following considerations:

- (a) Make the highway alignment as direct as possible and still blend with the topography while considering developed and undeveloped properties, community boundaries, and environmental concerns.

(b) Make highway alignment consistent by:

- Using gentle curves at the end of long tangents.
- Using a transition area of moderate curvature between the large radius curves of rural areas and the small radius curves of populated areas.
- Making horizontal curves visible to approaching traffic.

(c) Avoid minimum radii and short curves unless:

- Restrictive conditions are present and are not readily or economically avoidable.
- On two-lane highways, minimum radii will result in tangent sections long enough for needed passing.

(d) Avoid any abrupt change in alignment. Design reverse curves with an intervening tangent long enough for complete superelevation transition for both curves. See Chapter 640 for more information on superelevation transitions.

(e) Avoid the use of curves in the same direction connected by short tangents (broken back curves); substitute a single larger curve.

(f) Avoid compound curves on open highway alignment if a simple curve can be obtained. When compound curves are used, make the shorter radius at least two-thirds the longer radius. Make the total arc length of a compound curve not less than 500 ft.

(g) On divided multilane highways, take advantage of independent alignment to produce a flowing alignment along natural terrain.

(h) The preferred locations for bridges, interchanges, intersections, and temporary connections are on tangent sections in clear view of the driver.

(i) On two-lane, two-way highways, strive for as much passing sight distance as possible. (See Chapter 650.)

## **(2) Horizontal Curve Radii**

Design speed is the governing element of horizontal curves. For guidance regarding design speed selection see Chapter 440 for full design level, Chapter 430 for modified design level, and Chapter 940 for ramps.

Use the following factors to determine the radius for a curve:

- Stopping sight distance where sight obstructions are on the inside of a curve. The following are examples of sight obstructions: median barrier, bridges, walls, cut slopes, wooded areas, buildings, and guardrail. See Chapter 650 to check for adequate stopping sight distance for the selected design speed.
- Superelevation is the rotation or banking of the roadway cross section to overcome part of the centrifugal force that acts on a vehicle traversing a curve. Design information on the relationship between design speed, radius of curve, and superelevation is in Chapter 640.
- Coordinate vertical and horizontal alignment (see Chapter 630).
- For aesthetic reasons, on open highways, the desirable minimum curve length is 1,500 ft and the maximum is around 5,000 ft. See Figures 620-1a through 1c.

Spiral curves, although no longer used on new highway construction or major realignment, still exist on Washington highways. Spirals were used to transition between tangents and circular curves with the curvature rate increasing from tangent to curve and decreasing from curve to tangent. Spirals do not pose an operational concern and may remain in place.

## **620.05 Distribution Facilities**

### **(1) General**

In addition to the highway under consideration, other facilities can be provided to distribute traffic to and from the highway and to fulfill access requirements. Highway flexibility can be augmented by:

- Frontage roads
- Collector distributor roads

- On and off connections
- Parallel arterial routes with connections between them and the highway under consideration
- Loop highways around large metropolitan areas

A city or county may be asked to accept a proposed distribution facility as a city street or county road. Plan and design these facilities according to the applicable standards as shown in the following:

- Chapter 468-18 WAC
- Local Agency Guidelines
- The standards of the city or county in which the facility will be located

## **(2) Frontage Roads**

Frontage roads constructed as part of highway development may serve any of the following purposes:

- To reestablish continuity of an existing road severed by the highway.
- To provide service connections to adjacent property that would otherwise be isolated as a result of construction of the highway.
- To control access to the highway.
- To maintain circulation of traffic on each side of the highway.
- To segregate local traffic from the higher speed through traffic and intercept driveways of residences and commercial establishments along the highway.
- To relieve congestion on the arterial highway during periods of high use or in emergency situations.

Additional guidelines for auxiliary roads are in Chapters 330 and 1420. Frontage roads are generally not permanent state facilities. They are usually turned back to the local jurisdiction. Refer to the *Utilities Manual* for turnback procedures.

Outer separations function as buffers between the through traffic on the highway and the local traffic on the frontage road. The width is governed by requirements for grading, signing, barriers, aesthetics, headlight glare, and ramps. Where possible, make the separation wide enough to allow for development on both sides of the frontage road. Wider outer separations also move the intersection with the frontage road and a cross road farther from the intersection with the through roadway.

Where two-way frontage roads are provided, a driver on the highway must contend with approaching traffic on the right (opposing frontage road traffic) as well as opposing traffic on the left. Make the outer separation wide enough to minimize the effects of approaching traffic, particularly the headlight glare. With one-way same-direction frontage roads, the outer separation need not be as wide as with two-way frontage roads.

Wide separations lend themselves to landscape treatment and can enhance the appearance of both the highway and the adjoining property.

A substantial width of outer separation is particularly advantageous at intersections with cross streets. The wider separation reduces conflicts with pedestrians and bicycles.

Where ramp connections are provided between the through roadway and the frontage road, the minimum outer separation width will depend on design requirements for the ramp termini.

## **620.06 Number of Lanes and Arrangement**

### **(1) General**

The basic number of lanes is designated and maintained over a length of highway. The total number of lanes is the basic number of lanes plus any auxiliary lanes required to meet:

- Level of service (volume-capacity).
- Lane balance.
- Flexibility of operation.

## **(2) Basic Number of Lanes**

Keep the basic number of lanes constant over a highway route, or a significant portion thereof, regardless of changes in traffic volume. See Chapter 440 for the minimum number of lanes for each functional class of highway.

Change the basic number of lanes only for general changes in traffic volume over a substantial length of the route. The recommended location for a reduction in the basic number of lanes is on a tangent section between interchanges or intersections.

To accommodate high traffic volumes for short distances, such as between adjacent interchanges, use auxiliary lanes. When consecutive sections between interchanges require auxiliary lanes, consider increasing the basic number of lanes through the entire length.

## **(3) Auxiliary Lanes**

Auxiliary lanes are added to the basic number of lanes to allow additional traffic movements on short segments. These added lanes are based primarily on volume-to-capacity relationships (Chapter 610).

To ensure efficient operation of auxiliary lanes see the following:

910	Left and right turn lanes and storage for turning
940	Weaving and auxiliary lanes associated with interchanges
1010	Truck climbing and passing lanes

# **620.07 Pavement Transitions**

## **(1) Lane Transitions**

To narrow a lane or to reduce the number of lanes, a transition is required. The following guidelines apply:

- Locate transitions where decision sight distance exists, preferably on a tangent section and on the approach side of any crest vertical curve (except the end of climbing lanes which are transitioned in accordance with Chapter 1010).

- Supplement the transition with traffic control devices.
- Reduce the number of lanes by dropping only one at a time from the right side in the direction of travel. (When dropping a lane on the left side, an approved deviation is required.) See the MUTCD when more than one lane in a single direction must be dropped.
- Use the following formula to determine the minimum length of the lane transition for high speed conditions (45 mph or more):

$$L = VT$$

Where:

L = length of transition (ft)

V = design speed (mph)

T = tangential offset width (ft)

- Use a tangential rate of change of 1:25 or flatter for low speed conditions (less than 45 mph).

To widen a lane or to increase the number of lanes, a tangential rate of change in the range of 1:4 to 1:15 is sufficient. Aesthetics are the main consideration.

## **(2) Median Width Transitions**

Whenever two abutting sections have different median widths, use long, smooth transitions ( $L = VT$  or flatter). When horizontal curves are present, this can be accomplished by providing the transition throughout the length of the curve. When required on a tangent section, the transition may be applied about the center line or on either side of the median based on whether or not the abutting existing section is programmed for the wider median in the future. To satisfy aesthetic requirements, make the transition length as long as feasible.

## **620.08 Procedures**

When the project will realign the roadway, develop horizontal alignment plans for inclusion in the PS&E. Show the following as needed to maintain clarity and provide necessary information:



- Horizontal alignment details (tangent bearing, curve radius, and superelevation rate)
- Stationing
- Number of lanes
- Intersections, road approaches, railroad crossings, and interchanges (Chapters 910, 920, 930, and 940)
- Existing roadways and features affecting or affected by the project

See the *Plans Preparation Manual* for additional plan requirements.

Justify any realignment of the roadway. Include the reasons for the realignment, profile considerations, alternatives considered, and the reasons the selected alignment was chosen.

When the project will change the number of lanes, include a capacity analysis supporting the number selected (Chapter 610) with the justification for the number of lanes.

Include with the justification for a frontage road any traffic analyses performed, the social, environmental, and economic considerations, the options considered, and the reasons for the final decision.

## **620.09 Documentation**

The following documents are to be preserved in the project file. See Chapter 330.

- Alignment justification
- Number of lanes justification
- Frontage road justifications

*P65:DP/DM6*

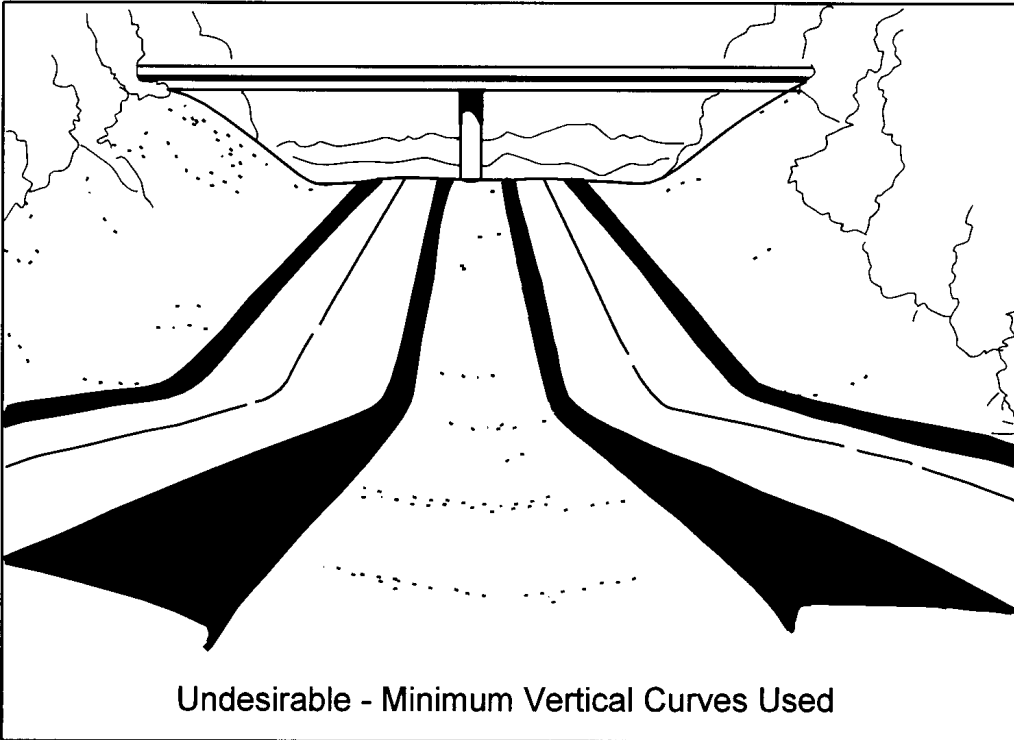
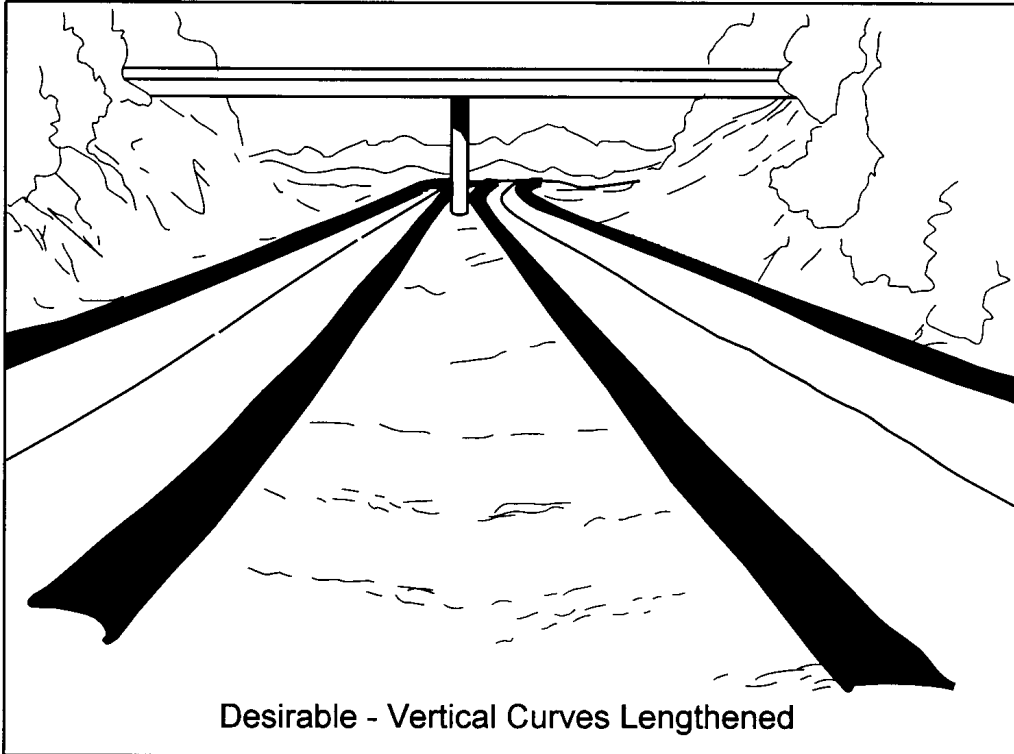

**Alignment Examples**  
*Figure 620-1a*

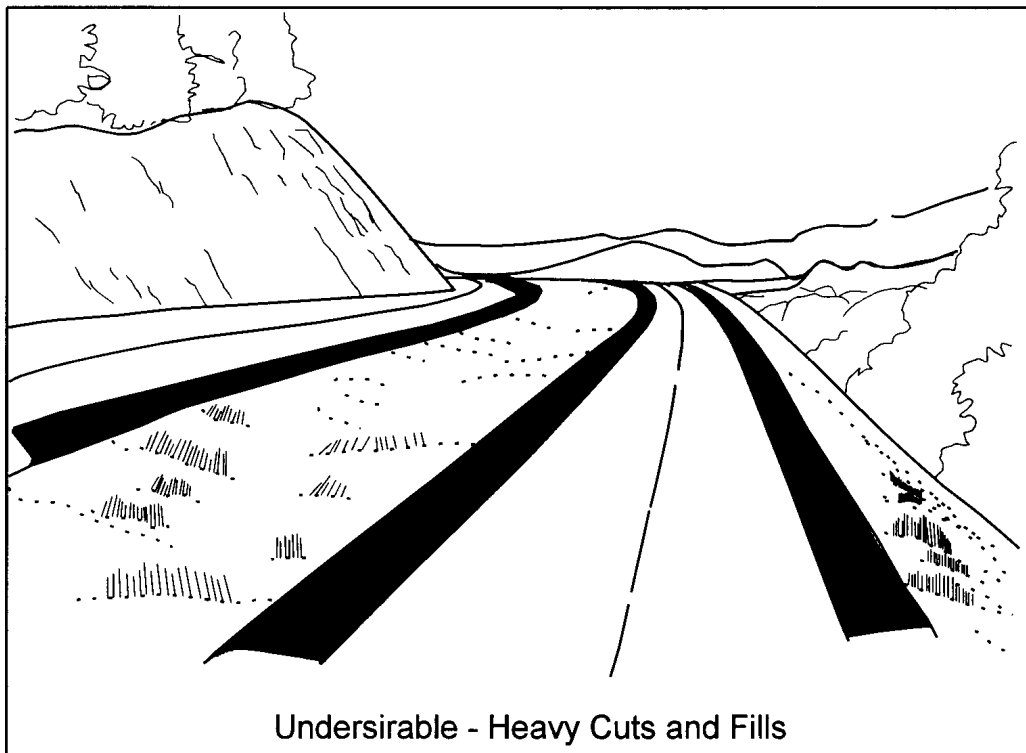
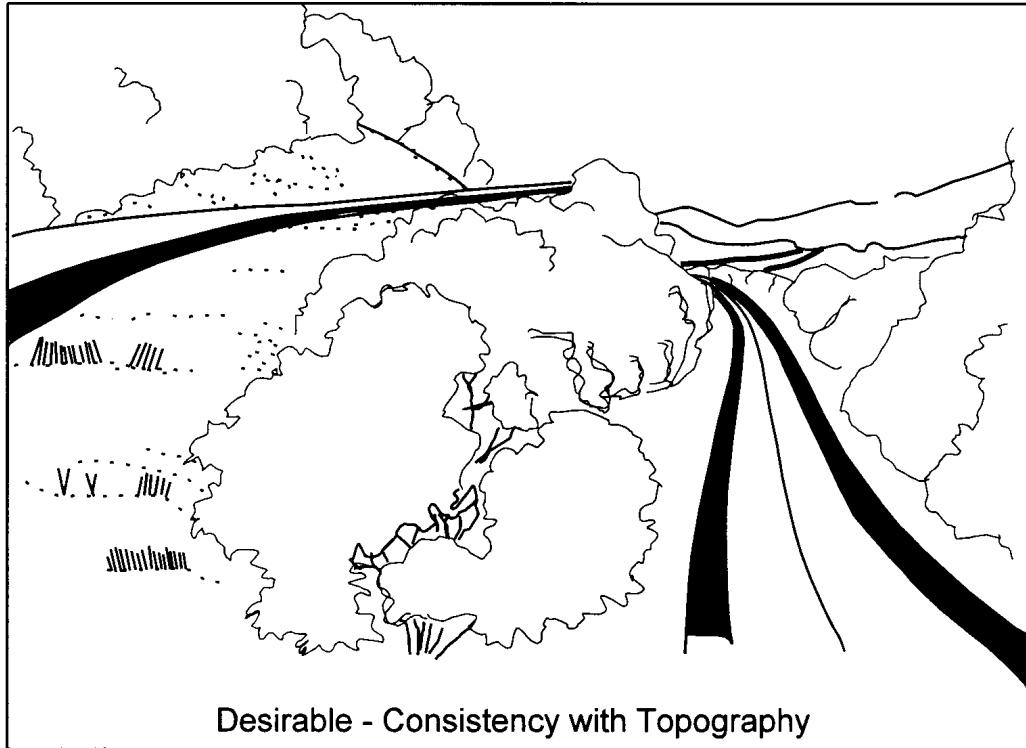

**Alignment Examples**  
*Figure 620-1b*

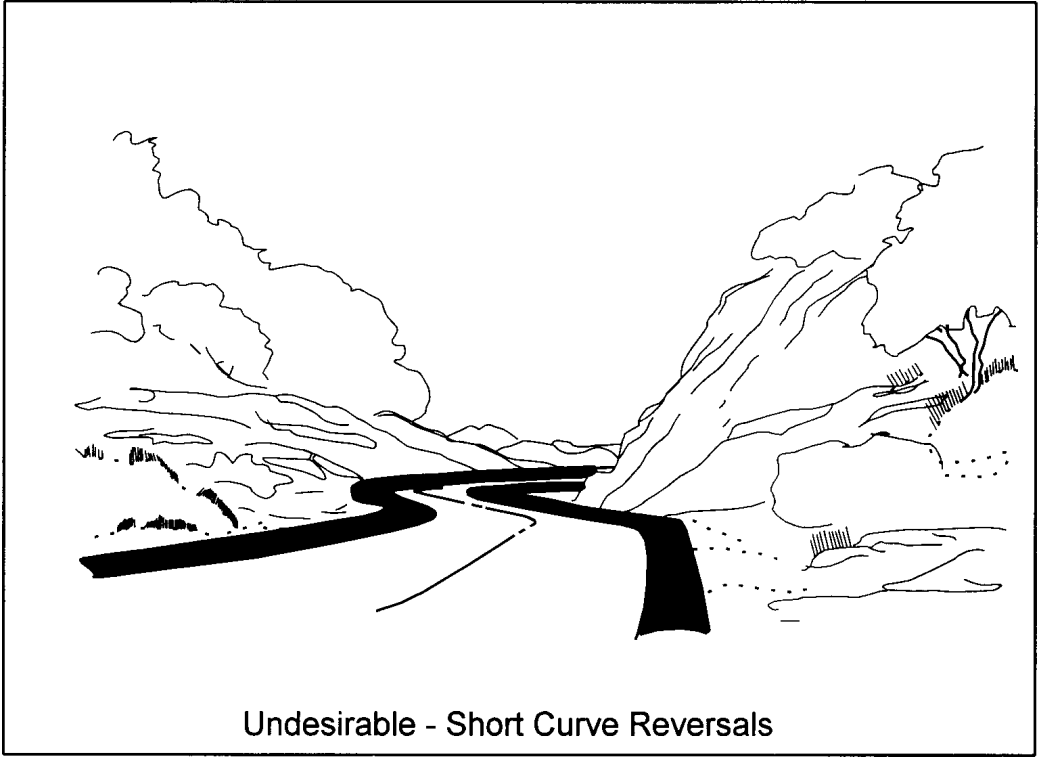
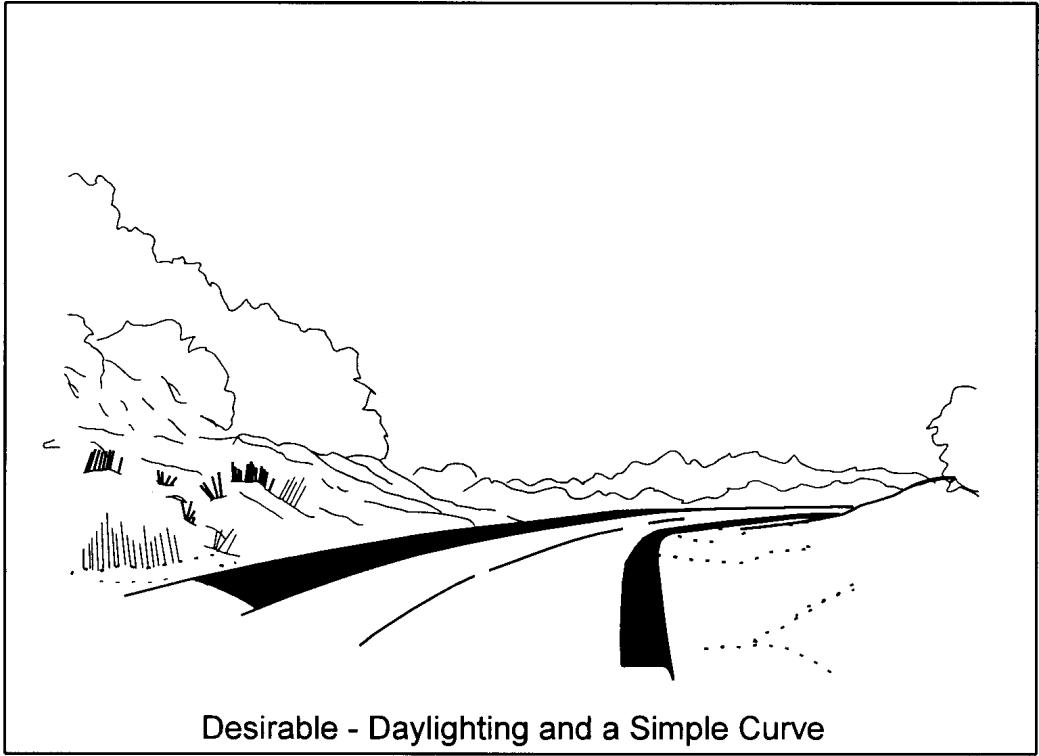

**Alignment Examples**  
*Figure 620-1c*

630.01	General
630.02	References
630.03	Vertical Alignment
639.04	Coordination of Vertical and Horizontal Alignments
630.05	Airport Clearance
630.06	Railroad Crossings
630.07	Procedures
630.08	Documentation

### 630.01 General

Vertical alignment (roadway profile) consists of a series of gradients connected by vertical curves. It is mainly controlled by:

- Topography
- Class of highway
- Horizontal alignment
- Safety
- Sight distance
- Construction costs
- Drainage
- Adjacent land use
- Vehicular characteristics
- Aesthetics

This chapter provides guidance for the design of vertical alignment. See the following chapters for additional information:

Chapter	Subject
440	Maximum grade for each functional class
620	Horizontal alignment
650	Sight distance

### 630.02 References

*Washington Administrative Code (WAC)*  
468-18-040, "Design standards for rearranged county roads, frontage roads, access roads, intersections, ramps and crossings"

*Plans Preparation Manual*, M 22-31, WSDOT

*Manual on Uniform Traffic Control Devices for Streets and Highways (MUTCD)*, USDOT, FHWA; including the *Washington State Modifications to the MUTCD*, M 24-01, WSDOT

*Local Agency Guidelines (LAG)*, M 36-63, WSDOT

*A Policy on Geometric Design of Highways and Street*, 1994, AASHTO

### 630.03 Vertical Alignment

#### (1) Design Controls

The following are general controls for developing vertical alignment (also see Figures 630-1a and 1c):

- Use a smooth grade line with gradual changes, consistent with the class of highway and character of terrain. Avoid numerous breaks and short grades.
- Avoid "roller coaster" or "hidden dip" profiles by use of gradual grades made possible by heavier cuts and fills or by introducing some horizontal curvature in conjunction with the vertical curvature.
- Avoid grades that will affect truck speeds and, therefore, traffic operations.
- Avoid broken back grade lines with short tangents between two vertical curves.
- Use long vertical curves to flatten grades near the top of long steep grades.
- Where at-grade intersections occur on roadways with moderate to steep grades, it is desirable to flatten or reduce the grade through the intersection.
- Establish the subgrade at least 1 ft above the high water table (real or potential) or as recommended by the region Materials Engineer. Consider the low side of superelevated roadways.

- When a vertical curve takes place partly or wholly in a horizontal curve, coordinate the two as discussed in 630.04.

### **(2) Minimum Length of Vertical Curves**

The minimum length of a vertical curve is controlled by design speed, the requirements for stopping sight distance, and the change in grade. See Chapter 650 to design vertical curves to meet stopping sight distance requirements.

In addition to stopping sight distance requirements, the minimum length of a vertical curve, in meters, is equal to the design speed, in miles per hour. For aesthetics, the desirable length of a vertical curve is two to three times the length required for stopping sight distance.

### **(3) Maximum Grades**

Analyze grades for their effect on traffic operation because they may result in undesirable truck speeds. Maximum grades are controlled by functional class of the highway, terrain type, and design speed (Chapter 440).

### **(4) Minimum Grades**

Minimum grades are used to meet drainage requirements. Avoid selecting a “roller coaster” or “hidden dip” profile merely to accommodate drainage.

Minimum ditch gradients of 0.3% on paved materials and 0.5% on earth can be obtained independently of roadway grade. Medians, long sag vertical curves, and relatively flat terrain are examples of areas where independent ditch design may be justified. A closed drainage system may be needed as part of an independent ditch design.

### **(5) Length of Grade**

The desirable maximum length of grade is the maximum length on an upgrade at which a loaded truck will operate without a 15 mph reduction. Figure 630-2 gives the desirable maximum length for a given percent of grade. For grades that are not at a constant percent, use the average. For grades longer than the desirable maximum, consider an auxiliary climbing lane (Chapter 1010).

When long steep downgrades are unavoidable, consider an emergency escape ramp (Chapter 1010).

### **(6) Alignment on Structures**

Avoid high skew, vertical curvature, horizontal curvature, and superelevation on structures, but do not sacrifice safe roadway alignment to achieve this.

## **630.04 Coordination of Vertical and Horizontal Alignments**

Do not design horizontal and vertical alignment independently. Coordinate them to obtain safety, uniform speed, pleasing appearance, and efficient traffic operation. Coordination can be achieved by plotting the location of the horizontal curves on the working profile to help visualize the highway in three dimensions. Perspective plots will also give a view of the proposed alignment. Figures 630-1a and 1b show sketches of desirable and undesirable coordination of horizontal and vertical alignment.

Guides for the coordination of the vertical and horizontal alignment are as follows:

- Balance curvature and grades. Using steep grades to achieve long tangents and flat curves, or excessive curvature to achieve flat grades, are both poor design.
- Vertical curvature superimposed on horizontal curvature generally results in a more pleasing facility. Successive changes in profile not in combination with horizontal curvature may result in a series of dips not visible to the driver.
- Do not begin or end a horizontal curve at or near the top of a crest vertical curve. This condition can be unsafe, especially at night, if the driver does not recognize the beginning or ending of the horizontal curve. Safety is improved if the horizontal curve leads the vertical curve, that is, the horizontal curve is made longer than the vertical curve in both directions.

- To maintain drainage, design vertical and horizontal curves so that the flat profile of a vertical curve will not be located near the flat cross slope of the superelevation transition.
- Do not introduce a sharp horizontal curve at or near the low point of a pronounced sag vertical curve. The road ahead is foreshortened and any horizontal curve that is not flat assumes an undesirably distorted appearance. Further, vehicular speeds, particularly of trucks, often are high at the bottom of grades and erratic operation may result, especially at night.
- On two-lane roads, the need for safe passing sections (at frequent intervals and for an appreciable percentage of the length of the roadway) often supersedes the general desirability for combination of horizontal and vertical alignment. Work toward long tangent sections to secure sufficient passing sight distance.
- On divided highways, consider variation in width of median and the use of independent alignments to derive the design and operational advantages of one-way roadways.
- Make horizontal curvature and profile as flat as feasible at intersections where sight distance along both roads is important and vehicles may have to slow or stop.
- In residential areas, design the alignment to minimize nuisance factors to the neighborhood. Generally, a depressed facility makes a highway less visible and less noisy to adjacent residents. Minor horizontal adjustments can sometimes be made to increase the buffer zone between the highway and clusters of homes.
- Design the alignment to enhance attractive scenic views of the natural and manmade environment, such as rivers, rock formations, parks, and outstanding buildings.

When vertical and horizontal curves are coordinated, plot profiles of the edges of pavement to ensure smooth transitions.

### 630.05 Airport Clearance

For a proposed highway construction or alteration in the vicinity of a public or military airport, early contact by the region with the airport authorities is required so that advance planning and design work can proceed within the required FAA regulations (Chapter 240).

### 630.06 Railroad Crossings

When a highway crosses a railroad at grade, design the highway grade so that a low-hung vehicle will not damage the rails or get hung up on the tracks. Figure 630-3 gives guidance on designing highway grades at railroad crossings. For more information on railroad-highway crossings, see Chapter 930.

### 630.07 Procedures

When the project will modify the vertical alignment, develop vertical alignment plans for inclusion in the PS&E to a scale suitable for showing vertical alignment for all proposed roadways including ground line, grades, vertical curves, and superelevation. See the *Plans Preparation Manual* for additional requirements.

When justifying any modification to the vertical alignment, include the reasons for the change, alternatives considered (if any) and why the selected alternative was chosen. When the profile is a result of new horizontal alignment, consider vertical and horizontal alignments together and document the profile with the horizontal alignment justification.

### 630.08 Documentation

The following documents are to be preserved in the project file. See Chapter 330.

- Vertical alignment revision justification

P65:DP/DM6

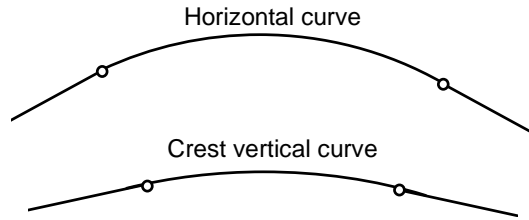

**Coinciding Horizontal and Crest Vertical Curves.**

When horizontal and crest vertical curves coincide, a satisfactory appearance results.

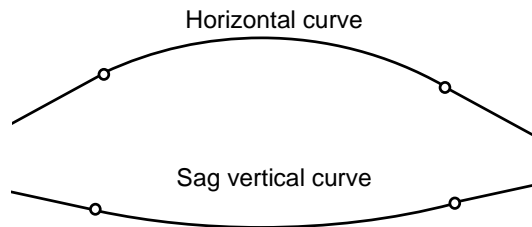

**Coinciding Horizontal and Sag Vertical Curves**

When horizontal and sag vertical curves coincide, a satisfactory appearance results.

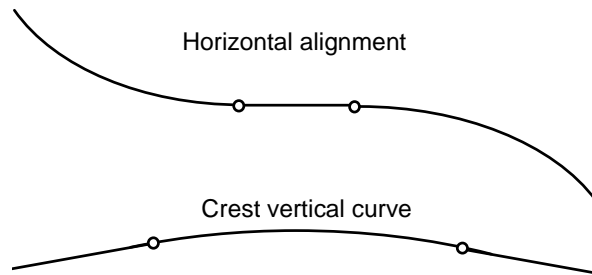

**Short Tangent on a Crest Between Two Horizontal Curves**

This combination is deficient for several reasons:

- The curve reversal is on a crest making the second curve less visible.
- The tangent is too short for the superelevation transition.
- The flat area of the superelevation transition will be near the flat grade in the crest.

**Coordination of Horizontal and Vertical Alignments**

*Figure 630-1a*



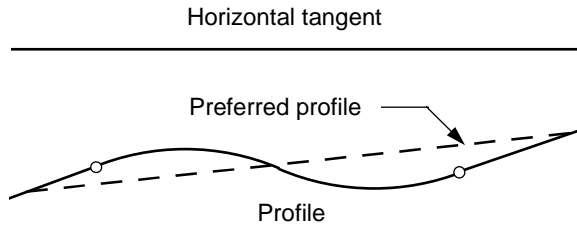

**Profile with Tangent Alignment**

Avoid designing dips on an otherwise long uniform grade.

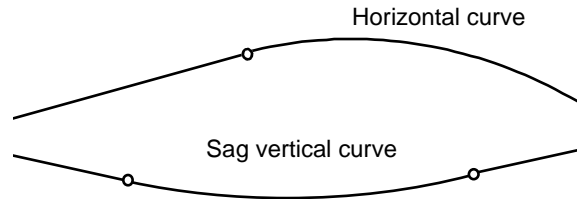

**Sharp Angle Appearance**

This combination presents a poor appearance. The horizontal curve looks like a sharp angle.

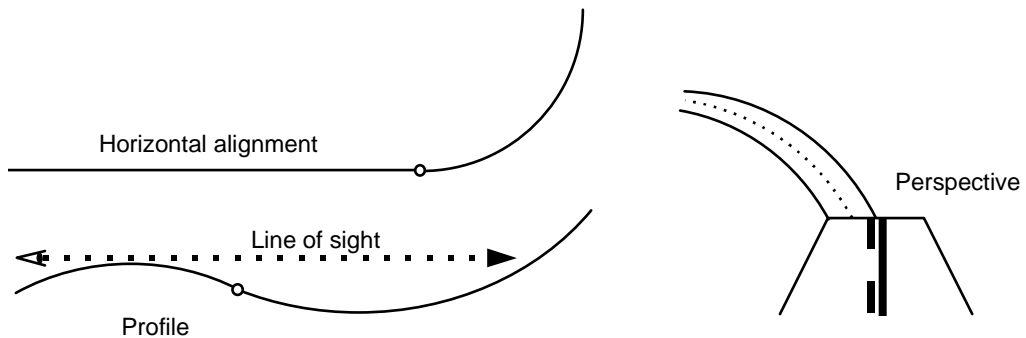

**Disjointed Effect**

A disjointed effect occurs when the beginning of a horizontal curve is hidden by an intervening crest while the continuation of the curve is visible in the distance beyond the intervening crest.

**Coordination of Horizontal and Vertical Alignments**

*Figure 630-1b*

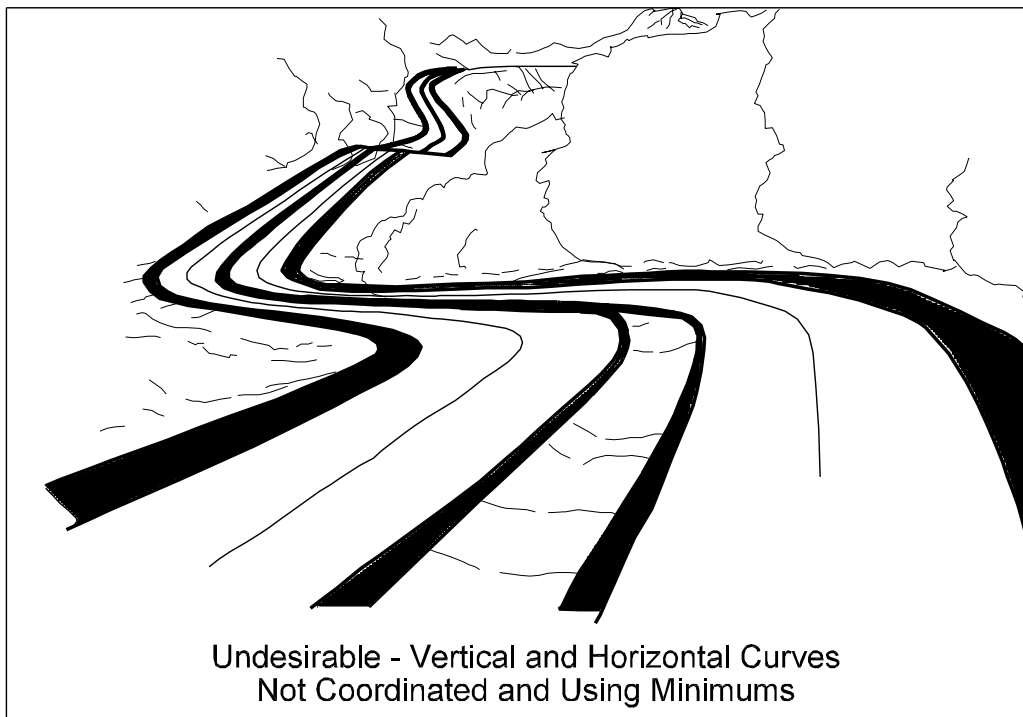
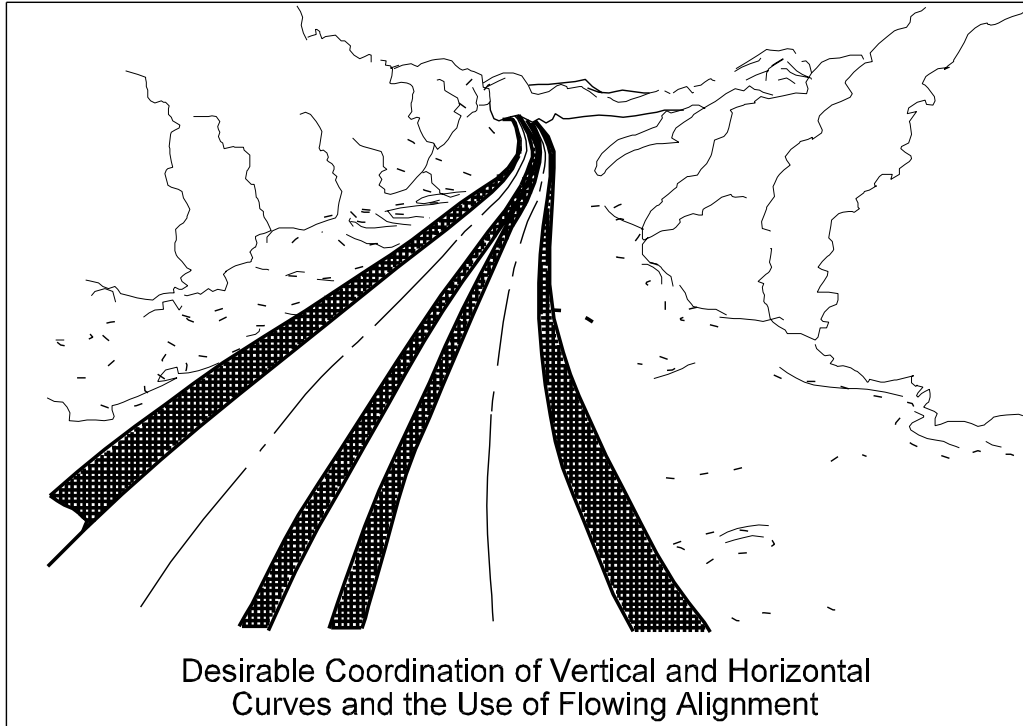

**Coordination of Horizontal and Vertical Alignments**  
*Figure 630-1c*

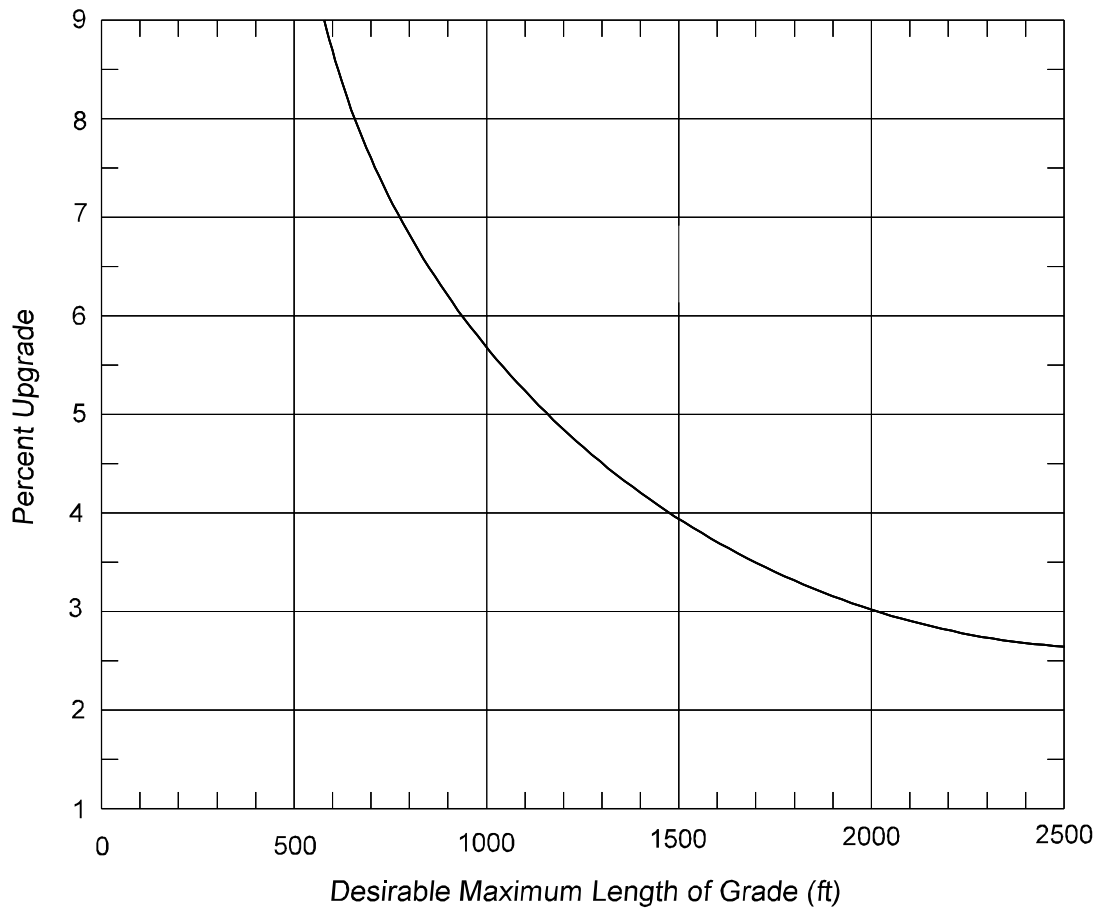

**Grade Length**  
*Figure 630-2*

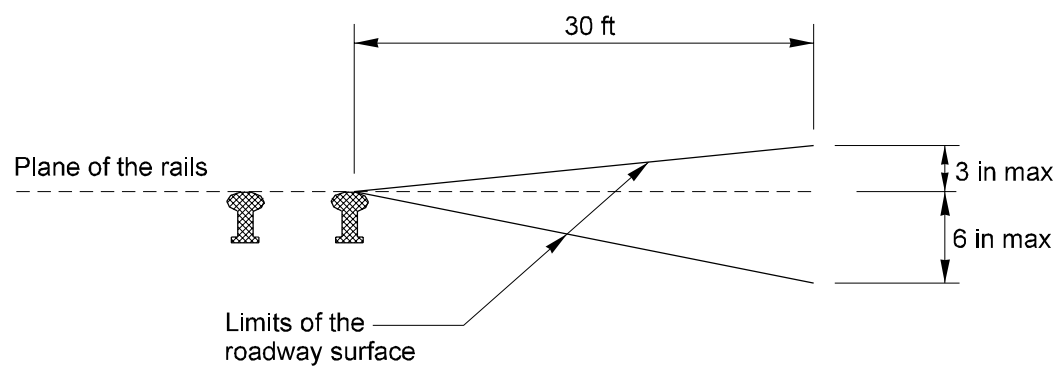
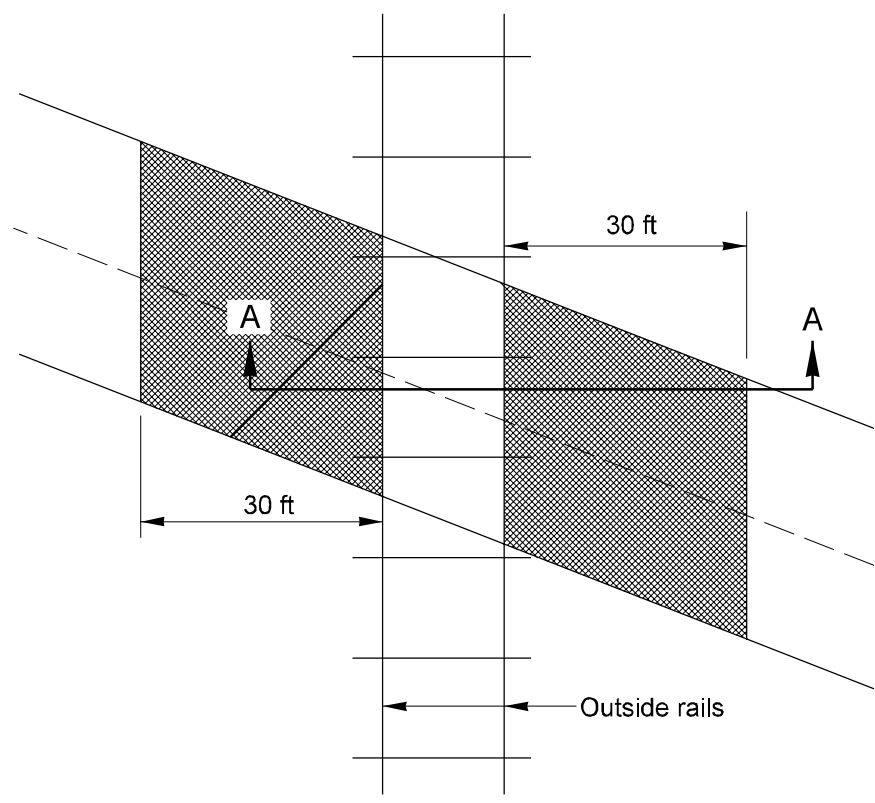

Detail A-A

**Grading at Railroad Crossings**  
*Figure 630-3*

- 640.01 General
- 640.02 References
- 640.03 Definitions
- 640.04 Roadways
- 640.05 Superelevation
- 640.06 Medians and Outer Separations
- 640.07 Roadsides
- 640.08 Roadway Sections
- 640.09 Documentation

### 640.01 General

Geometric cross sections for state highways are governed by functional classification criteria, traffic volume, and whether the highway is in a rural or urban area. See Chapter 440 for guidance on selecting a design class.

High Occupancy Vehicle (HOV) lanes must be considered when continuous through lanes are to be added within the limits of an urban area over 200,000 population (Chapter 1050).

When a state highway within an incorporated city or town is a portion of a city street, the design features must be developed in cooperation with the local agency. For city streets and county roads that are not part of the state highway system, use Chapter 468-18 WAC and the Local Agency Guidelines.

See the following chapters for additional information:

#### Chapter Subject

- 430 all roadway widths for modified design level
- 440 lane and shoulder widths for full design level
- 910 shy distances for curbs and islands
- 940 lane and shoulder widths for ramps

### 640.02 References

*Washington Administrative Code (WAC 468-18-040)*, “Design standards for rearranged county roads, frontage roads, access roads, intersections, ramps and crossings”

*Standard Plans for Road, Bridge, and Municipal Construction (Standard Plans)*, M 21-01, WSDOT

*Plans Preparation Manual*, WSDOT, M 22-31

*Highway Runoff Manual*, M 31-16, WSDOT

*Local Agency Guidelines (LAG)*, M 36-63, WSDOT

*Standard Specifications for Road, Bridge, and Municipal Construction (Standard Specifications)*, M 41-10, WSDOT.

*WSDOT Pavement Guide for Design, Evaluation and Rehabilitation (Pavement Guide)*, WA-RD 335.1, WSDOT

*A Policy on Geometric Design of Highways and Streets (Green Book)*, 1994, AASHTO

### 640.03 Definitions

**auxiliary lane** The portion of the roadway adjoining the through lanes for parking, speed change, turning, storage for turning, weaving, truck climbing, and other purposes supplementary to through-traffic movement.

**high pavement type** Portland cement concrete pavement or asphalt cement concrete on a treated base.

**intermediate pavement type** Asphalt cement concrete pavement on an untreated base.

**lane** A strip of roadway used for a single line of vehicles.

**lane width** The lateral design width for a single lane, striped as shown in the Standard Plans and the Standard Specifications. The width of an existing lane is measured from the edge of traveled way to the center of the lane line or between the centers of successive lane lines.

**low pavement type** Bituminous surface treatment.

**median** The portion of a divided highway separating the traveled ways for traffic in opposite directions.

**outer separation** The area between the outside edge of traveled way for through traffic and the nearest edge of traveled way of a frontage road.

**roadway** The portion of a highway, including shoulders, for vehicular use. A divided highway has two or more roadways.

**shoulder** The portion of the roadway contiguous with the traveled way, primarily for accommodation of stopped vehicles, emergency use, lateral support of the traveled way, and use by pedestrians.

**shoulder width** The lateral width of the shoulder, measured from the outside edge of the outside lane to the edge of the roadway.

**superelevation** The rotation of the roadway cross section in such a manner as to overcome part of the centrifugal force that acts on a vehicle traversing a curve.

**superelevation runoff** The length of highway needed to accomplish the change in cross slope from a level section to a fully superelevated section, or vice versa.

**superelevation transition length** The length of highway needed to change the cross slope from normal crown or normal pavement slope to full superelevation.

**tangent runoff** The length of highway needed to change the cross slope from normal crown to a section with adverse crown removed (level).

**traveled way** The portion of the roadway intended for the movement of vehicles, exclusive of shoulders and lanes for parking, turning, and storage for turning.

**turning roadway** A curve on an open highway, a ramp, or the connecting portion of roadway between two intersecting legs of an intersection.

## 640.04 Roadways

The cross sections shown in Figures 640-3, 4, 5, 6a, and 6b represent minimum standards for full design level.

For the specific type of roadway section see Chapter 440 and for pavement type details see the Pavement Guide.

### (1) Traveled Way Cross Slope

The cross slope on tangents and curves is a main element in cross section design. The cross slope or crown on tangent sections and large radius curves is complicated by two contradicting controls. Reasonably steep cross slopes are desirable to aid in water runoff and to minimize ponding as a result of pavement imperfections and unequal settlement. However, steep cross slopes are undesirable on tangents because of the tendency for vehicles to drift to the low side of the roadway. Cross slopes greater than 2% are noticeable in steering and increase susceptibility to sliding to the side on icy or wet pavements.

A 2% cross slope is normally used for tangents and large radius curves on high and intermediate pavement types.

In some areas, a somewhat steeper cross slope may be desirable to improve roadway runoff, although it is undesirable operationally. For these areas, with justification, a 2.5% cross slope may be used.

On low pavement types, such as bituminous surface treatment, the cross slope may be increased to 3% to allow for reduced construction control and greater settlement.

Superelevation on curves is determined by the design speed and the radius of the curve. See 640.05 for guidance on superelevation design.

### (2) Turning Roadway Widths

The roadway on a curve may need to be widened to make the operating conditions comparable to those on tangents. There are two main reasons to do this. One is the offtracking of vehicles, such as trucks and buses. The other is the increased difficulty drivers have in keeping their vehicles in the center of the lane.

(a) **Two-lane two-way roadways.** Figure 640-7a shows the traveled way width  $W$  for two-lane two-way roadways. For values of  $R$  between those given, interpolate  $W$  and round up to the next foot.

Minimum traveled way width  $W$  based on the delta angle of the curve is shown in Figure 640-7b. Round  $W$  to the nearest foot.

(b) **Two-lane one-way roadways.** Figure 640-8a shows the traveled way width for two-lane one-way turning roadways, including two lane ramps and four lane divided highways. For values of  $R$  between those given, interpolate  $W$  and round up to the next foot. Treat each direction of travel of multilane divided facilities as a one-way roadway.

Minimum width  $W$  based on the delta angle of the curve is shown in Figure 640-8b. Round  $W$  to the nearest foot.

To keep widths to a minimum, traveled way widths for Figures 640-8a and 8b were calculated using the WB-40 design vehicle. When volumes are high for both trucks larger than the WB-40 and other traffic, consider using the widths from Figures 640-7a and 7b.

(c) **One-lane one-way roadways.** Figure 640-9a shows the traveled way width for one-lane one-way turning roadways, including one lane ramps. For values of  $R$  between those given, interpolate  $W$  and round up to the next foot.

For minimum widths based on the delta angle of the curve, use Figure 640-9b for one-lane roadways using the radius to the outer edge of the traveled way and Figure 640-9c for one-lane roadways using the radius on the inner edge of the traveled way. Round  $W$  to the nearest foot.

Build shoulder pavements at full depth for one-lane one-way roadways because, to keep widths to a minimum, traveled way widths were calculated using the WB-40 design vehicle which may force larger vehicles to encroach on the shoulders.

(d) **Other roadways.**

- For multilane two-way undivided roadways use the following:

$$W = \frac{W_a \times N}{2}$$

Where:

$W$  = The multilane roadway width.

$W_a$  = The width from 640.04(2)(a) for a two-lane two-way roadway.

$N$  = The total number of lanes.

- For one-way roadways with more than two lanes, for each lane in addition to two, add the standard lane width for the highway functional class from Chapter 440 to the width from 640.04(2)(b).
- For three-lane ramps with HOV lanes, see Chapter 1050.

(e) **All roadways.** Full design shoulder widths for the highway functional class or ramp are added to the traveled way width to determine the total roadway width.

If the total roadway width deficiency is less than 2 ft on existing roadways that are to remain in place, correction is not required.

When widening

- Traveled way widening may be constructed on the inside of the traveled way or divided equally between the inside and outside.
- Place final marked center line, and any central longitudinal joint, midway between the edges of the widened traveled way.
- Provide widening throughout the curve length.
- For widening on the inside, make transitions on a tangent, where possible.
- For widening on the outside, develop the widening by extending the tangent. This avoids the appearance of a reverse curve that a taper would create.
- For widening of 6 ft or less, use a 1:25 taper, for widths greater than 6 ft use a 1:15 taper.

### (3) Shoulders

Pave the shoulders of all highways where high or intermediate pavement types are used. Where low pavement type is used, treat the roadway full width.

Shoulder cross slopes are normally the same as the cross slopes for adjacent lanes. With justification, shoulder slopes may be increased to 6%. The maximum difference in slopes between the lane and the shoulder is 8%. Examples of locations where it may be desirable to have a shoulder grade different than the adjacent lane are:

- Where curbing is used.
- Where shoulder surface is bituminous, gravel, or crushed rock.
- Where overlays are planned and it is desirable to maintain the grade at the edge of the shoulder.
- On divided highways with depressed medians where it is desirable to drain the runoff into the median.
- On the high side of the superelevation on curves where it is desirable to drain storm water or melt water away from the roadway.

When asphalt concrete curb is used, see the Standard Plans for required widening. Widening is normally required when traffic barrier is installed (see Chapter 710).

It is preferred that curb not be used on high speed facilities. In some areas, curb may be needed to control runoff water until ground cover is attained to prevent erosion. Plan for the removal of the curb when the ground cover becomes adequate. Arrange for curb removal with regional maintenance as part of the future maintenance plans. When curb is used in conjunction with guardrail, see Chapter 710 for guidance.

Figures 640-10a and 10b represent shoulder details and requirements.

### 640.05 Superelevation

To maintain the desired design speed, highway and ramp curves are usually superelevated to overcome part of the centrifugal force that acts on a vehicle.

### (1) Superelevation Rates for Open Highways and Ramps

The maximum superelevation rate allowed for open highways or ramps is 10%. (See Figure 640-11a.)

Base superelevation rate and its corresponding radius for open highways on Figure 640-11a, Superelevation Rate (10% Max), with the following exceptions:

- Figure 640-11b, Superelevation Rate (6% Max), may be used under the following conditions:
  1. Urban conditions without limited access
  2. Mountainous areas or locations that normally experience regular accumulations of snow and ice
  3. Short-term detours (generally implemented and removed in one construction season). For long-term detours, consider a higher rate up to 10%, especially when associated with a main line detour.
- Figure 640-11c, Superelevation Rate (8% Max), may be used for existing roadways and for the urban, mountainous, and snow and ice conditions that are less severe or where the 6% rate will not work; for example, where a curve with a radius less than the minimum for the design speed from Figure 640-11b is required.

Design the superelevation for ramps the same as for open highways. With justification, ramps in urban areas with a design speed of 35 mph or less, Figure 640-12 may be used to determine the superelevation.

Round the selected superelevation rate to the nearest full percent.

Document which set of curves is being used and, when a curve other than the 10% maximum rate is used, document why the curve was selected.

Depending on design speed, construct large radius curves with a normal crown section and superelevate curves with smaller radii in accordance with the appropriate superelevation from Figures 640-11a through 11c. The minimum radii for normal crown sections are shown in Figure 640-1.



Design Speed (mph)	Minimum Radius for Normal Crown Section (ft)
25	2,640
30	3,340
35	4,380
40	5,550
45	6,870
50	8,320
55	9,940
60	11,690
70	14,690
80	18,080

**Minimum Radius for Normal Crown Section**

*Figure 640-1*

**(2) Existing Curves**

Evaluate the superelevation on an existing curve to determine its adequacy. Use the following equation:

$$R = \frac{6.69V^2}{e + f}$$

Where:

$R$  = The minimum allowable radius of the curve in feet.

$V$  = Design speed in mph

$e$  = Superelevation rate in percent

$f$  = Side friction factor from Figure 640-2

Superelevation is deficient when the radius is less than the minimum from the equation.

For preservation projects, where the existing pavement is to remain in place, the superelevation on existing curves may be evaluated with a ball banking analysis.

Address deficient superelevation as provided in 640.05 (1).

Design Speed (mph)	Side Friction Factor $f$
20	17
25	16
30	16
35	15
40	15
45	14
50	14
60	12
70	10
80	8

**Side Friction Factor**

*Figure 640-2*

**(3) Turning Movements at Intersections**

Curves associated with the turning movements at intersections are superelevated assuming greater friction factors than open highway curves. Since speeds of turning vehicles are not constant and curve lengths are not excessive, higher friction factors can be tolerated. Use superelevation rates as high as practical, consistent with curve length and climatic conditions. Figure 640-12 shows acceptable ranges of superelevation for given design speed and radius. It is desirable to use the values in the upper half or third of the specified range whenever possible. Use judgment in considering local conditions such as snow and ice. When using high superelevation rates on short curves, provide smooth transitions with merging ramps or roadways.

**(4) Superelevation Runoff for Highway Curves**

For added comfort and safety, provide uniform superelevation runoff over a length adequate for the likely operating speeds.

Provide transitions for all superelevated highway curves as specified in Figures 640-13a through 13e. Which transition to use depends on the location of the pivot point, the direction of the curve, and the roadway cross slope.

Consider the profile of the edge of traveled way. To be pleasing in appearance, do not let it appear distorted. The combination of superelevation transition and grade may result in a hump or dip in the profile of the edge of traveled way. When this happens, the transition may be lengthened to eliminate the hump or dip. If the hump or dip cannot be eliminated this way, pay special attention to drainage in the low areas.

When reverse curves are necessary, provide sufficient tangent length for complete superelevation runoff for both curves (that is, from full superelevation of the first curve to level to full superelevation of the second curve). If tangent length is longer than this but not sufficient to provide standard super transitions (that is, from full superelevation of the first curve to normal crown to full superelevation of the second curve), increase the superelevation runoff lengths until they abut. This provides one continuous transition, without a normal crown section, similar to Designs C2 and D2 in Figures 640-13c and 3d except full super will be attained rather than the normal pavement slope as shown.

Superelevation runoff is permissible on structures but not desirable. Whenever practical, strive for full super or normal crown slopes on structures.

### **(5) Superelevation Runoff for Ramp Curves**

Superelevation transition lengths for one-lane ramps are shown in Figure 640-14a and 14b. For multilane ramps, use the method for highway curves (Figures 640-13a through 13e).

Superelevation transition lengths ( $L_T$ ) given in Figures 640-14a and 14b are for a single 15-ft lane. They are based on maximum cross slope change between the pivot point and the edge of the traveled way over the length of the superelevation transition. Maximum relative slopes for specific design speeds are similar to those given for highway curves.

**I** For a single 15-ft lane, use the distances given in the  $L_T$  column for  $L_R$  wherever possible. The  $L_B$  distances will give the maximum allowable rate of cross slope change. Use the  $L_B$  distances only with justification where the  $L_T$  distance cannot be achieved.

For ramps wider than 15 ft, adjust the  $L_B$  distance by the equation for  $L_R$ . If the result is larger than the  $L_T$  distance, round upward to the next whole 5 ft or 10 ft increment; if it is smaller, use the  $L_T$  distance.

## **640.06 Medians and Outer Separations**

### **(1) Purpose**

The main function of a median is to separate opposing traffic lanes. The main function of an outer separation is to separate the main roadway from a frontage road. Medians and outer separations also provide space for:

- Drainage facilities
- Undercrossing bridge piers
- Vehicle storage space for crossing and left turn movements at intersections
- Headlight glare screens, including planted or natural foliage
- Visual buffer of opposing traffic
- Safety refuge areas for errant or disabled vehicles
- Storage space for snow and water from traffic lanes
- Increased safety, comfort, and ease of operations

### **(2) Design**

In addition to Figures 640-15a through 15c, refer to other applicable sections for minimum design requirements. Median widths in excess of the minimums are highly desirable. No attempt has been made to cover all the various grading techniques that are possible on wide, variable-width medians. Considerable latitude in treatment is intended, provided the requirements of minimum geometrics, safety, and aesthetics are met or exceeded.

When the horizontal and vertical alignments of the two roadways of a divided highway are independent of each other, determine median slopes in conformance with Figure 640-3. Unnecessary clearing, grubbing, and grading

within wide medians is undesirable. Give preference to selective thinning and limited reshaping of the natural ground. For slopes into the face of traffic barriers, see Chapter 710.

In areas where land is expensive, make an economic comparison of wide medians to narrow medians with their barrier requirements. Consider right of way, construction, maintenance, and accident costs. The widths of medians need not be uniform. Make the transition between median widths as long as feasible.

Independent horizontal and vertical alignment, rather than parallel alignment, is desirable.

When using concrete barriers in depressed medians or on curves, provide for surface drainage on both sides of the barrier. The transverse notches in the base of precast concrete barrier are not intended to be used as a drainage feature but rather as pick-up points when placing the sections.

## 640.07 Roadsides

### (1) Side Slopes

The Cut Slope Selection tables on Figures 640-3, 4, 5, and 6b are for preliminary estimates or where no other information is available. Design the final slope as recommended in the soils or geotechnical report.

When designing side slopes, fit the slope selected for any cut or fill into the existing terrain to give a smooth transitional blend from the construction to the existing landscape. Slopes flatter than recommended are desirable, especially within the Design Clear Zone. Slopes not steeper than 4H:1V, with smooth transitions where the slope changes, will provide a reasonable opportunity to recover control of an errant vehicle. Where mowing is contemplated, slopes must not be steeper than 3H:1V. If there will be continuous traffic barrier on a fill slope, and mowing is not contemplated, the slope may be steeper than 3H:1V.

In cases of unusual geological features or soil conditions, treatment of the slopes will depend upon results of a review of the location by the region's Materials Engineer.

Do not disturb existing stable cut slopes just to meet the slopes given in the Cut Slope Selection tables on Figures 640-3, 4, 5, and 6b. When an existing slope is to be revised, document the reason for the change.

If borrow is required, consider obtaining it by flattening cut slopes uniformly on one or both sides of the highway. Where considering wasting excess material on an existing embankment slope, consult the region's Materials Engineer to verify that the foundation soil will support the additional material.

In all cases, provide for adequate drainage from the roadway surface and adequate drainage in ditches. See 640.07(4) for details on drainage ditches in embankment areas.

At locations where vegetated filter areas or detention facilities will be established to improve highway runoff water quality, provide appropriate slope, space, and soil conditions for that purpose. See the *Highway Runoff Manual* for design criteria and additional guidance.

Rounding, as shown in the Standard Plans, is required at the top of all roadway cut slopes, except for cuts in solid rock. Unless Class B slope treatment is called for, Class A slope treatment is used. Call for Class B slope treatment where space is limited, such as where right of way is restricted.

### (2) Roadway Sections in Rock Cuts

Typical sections for rock cuts, illustrated in Figures 640-16a and 16b, are guides for the design and construction of roadways through rock cuts. Changes in slope or fallout area are recommended when justified. Base the selection of the appropriate sections on an engineering study and the recommendations of the region's Materials Engineer and Landscape Architect. Olympia Service Center Materials Lab concurrence is required.

There are two basic design treatments applicable to rock excavation (Figures 640-16a and 16b). Design A applies to most rock cuts. Design B is a talus slope treatment.

(a) **Design A.** This design is shown in stage development to aid the designer in selecting an appropriate section for site conditions in regard to backslope, probable rockfall, hardness of rock, and so forth.

The following guidelines apply to the various stages shown in Figure 640-16a.

- Stage 1 is used where the anticipated quantity of rockfall is small, adequate fallout width can be provided, and the rock slope is 1/2H:1V or steeper. Controlled blasting is recommended in conjunction with Stage 1 construction.
- Stage 2 is used when a “rocks in the road” problem exists or is anticipated. Consider it on flat slopes where rocks are apt to roll rather than fall.
- Stage 3 represents full implementation of all protection and safety measures applicable to rock control. Use it only when extreme rockfall conditions exist.

Show Stage 3 as ultimate stage for future construction on the PS&E plans if there is any possibility that it will be needed.

The use of Stage 2 or 3 alternatives (concrete barrier) is based on the designer’s analysis of the particular site. Considerations include maintenance, size and amount of rockfall, probable velocities, availability of materials, ditch capacity, adjacent traffic volumes, distance from traveled lane, and impact severity. Incorporate removable sections in the barrier at approximately 200 ft intervals. Appropriate terminal treatment is required (Chapter 710).

Occasionally, the existing ground above the top of the cut is on a slope approximating the design cut slope. The height (H) is to include the existing slope or that portion that can logically be considered part of the cut. The cut slope selected for a project must be that required to effect stability of the existing material.

Benches may be used to increase slope stability; however, the use of benches may alter the design requirements for the sections given in Figure 640-16a.

The necessity for benches, their width, and vertical spacing is established only after an evaluation of slope stability. Make benches at least 20 ft wide. Provide access for maintenance equipment at the lowest bench, and to the higher benches if feasible. Greater traffic benefits in the form of added safety, increased horizontal sight distance on curves, and other desirable attributes may be realized from widening a cut rather than benching.

(b) **Design B.** A talus slope treatment is shown in Design B (Figure 640-16b). The rock protection fence is placed at any one of the three locations shown but not in more than one position at a particular location. The exact placement of the rock protection fence in talus slope areas requires considerable judgment and should be determined only after consultation with the region’s Materials Engineer.

- Fence position a is used when the cliff generates boulders less than 0.25 cy<sup>3</sup> in size, and the length of the slope is greater than 350 ft.
- Fence position b is the preferred location for most applications.
- Fence position c is used when the cliff generates boulders greater than 0.25 cy<sup>3</sup> in size, regardless of the length of the slope. On short slopes, this may require placing the fence less than 100 ft from the base of the cliff.
- Use of gabions may be considered instead of the rock protection shown in fence position a. However, gabion treatment is considered similar to a wall and, therefore, requires appropriate face and end protection for safety (Chapter 710).

Use of the alternate shoulder barrier is based on the designer’s analysis of the particular site. Considerations similar to those given for Design A alternatives apply.

Rock protection treatments other than those described above may be required for cut slopes that have relatively uniform spalling surfaces, consult with the region’s Materials Engineer.

### (3) Stepped Slopes

Stepped slopes are a construction method intended to promote early establishment of vegetative cover on the slopes. They consist of a series of small horizontal steps or terraces on the face of the cut slope. Soil conditions dictate the feasibility and necessity of stepped slopes. They are to be considered only on the recommendation of the region's Materials Engineer (Chapter 510). Consult region's landscape personnel for appropriate design and vegetative materials to be used. See Figure 640-17 for stepped slope design details.

### (4) Drainage Ditches in Embankment Areas

Where it is necessary to locate a drainage ditch adjacent to the toe of a roadway embankment, consider the stability of the embankment. A drainage ditch placed immediately adjacent to the toe of an embankment slope has the effect of increasing the height of the embankment by the depth of the ditch. In cases where the foundation soil is weak, the extra height could result in an embankment failure. As a general rule, the weaker the foundation and the higher the embankment, the farther the ditch should be from the embankment. Consult the region's Materials Engineer for the proper ditch location.

When topographic restrictions exist, consider an enclosed drainage system with appropriate inlets and outlets. Do not steepen slopes to provide lateral clearance from toe of slope to ditch location, thereby necessitating traffic barriers or other protective devices.

Maintenance operations are also facilitated by adequate width between the toe of the slope and an adjacent drainage ditch. Where this type of facility is anticipated, provide sufficient right of way for access to the facility and place the drainage ditch near the right of way line.

Provide for disposition of the drainage collected by ditches in regard to siltation of adjacent property, embankment erosion, and other undesirable effects. This may also apply to cut slope top-of-slope ditches.

P65:DP/DME

### (5) Bridge End Slopes

Bridge end slopes are determined by several factors, including: location, fill height, depth of cut, soil stability, and horizontal and vertical alignment. Close coordination between the OSC Bridge and Structures Office and the region is necessary to ensure proper slope treatment (Chapter 1120).

Early in the preliminary bridge plan development, determine preliminary bridge geometrics, end slope rates, and toe of slope treatments. Figure 640-18a provides guidelines for use of slope rates and toe of slope treatments for overcrossings. Figure 640-18b shows toe of slope treatments to be used on the various toe conditions.

## 640.08 Roadway Sections

Provide a typical section for inclusion in the PS&E for each general type used on the main roadway, ramps, detours, and frontage or other roads. See the *Plans Preparation Manual* for requirements.

## 640.09 Documentation

The following documents are to be preserved in the project file. See Chapter 330.

- Justification for cross slopes other than 2% on tangents.
- Justification for shoulder cross slopes not the same as the cross slopes for the adjacent lane.
- Documentation of superelevation maximum rate being used and justification for a rate other than 10% maximum.
- Justification for the use of LB on ramp curves when the minimum transition cannot be achieved.
- Documentation of the reasons for modifying an existing cut slope.
- Engineering study and recommendations for rock cuts.
- Materials Engineer recommendation for stepped slopes.
- Materials Engineer recommendation for ditch location at the toe of fill.

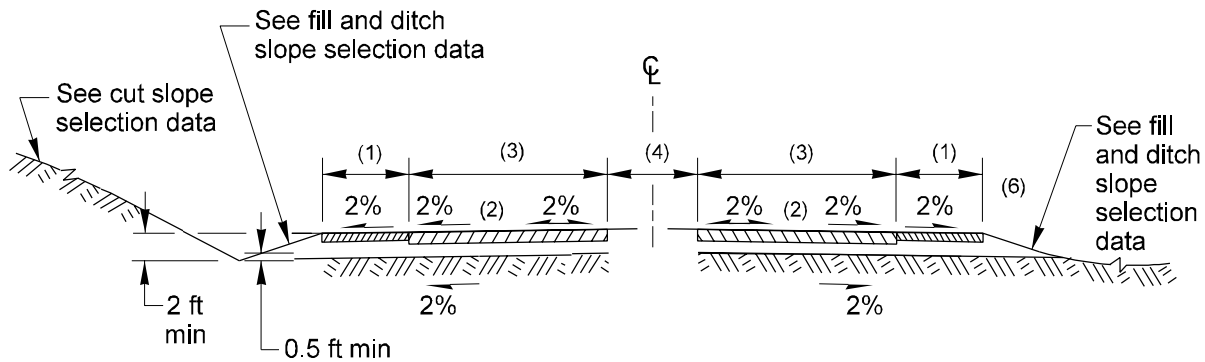

Class I, P-1, P-2, M-1

Height of fill/depth of ditch (ft)	Slope not steeper than (H:V) (5)
10	6 : 1
10 - 20	4 : 1
20 - 30	3 : 1 (6)
over 30	2 : 1 (6) (8)

### Fill and Ditch Slope Selection

- (1) See Figures 640-10a and 10b for shoulder details. See Chapter 440 for minimum shoulder width.
- (2) Generally, the crown slope will be as follows:
  - Four-lane highway — slope all lanes away from the median.
  - Six-lane highway — slope all lanes away from the median unless high rainfall intensities would indicate otherwise.
  - Eight-lane highway — slope two of the four directional lanes to the right and two to the left unless low rainfall intensities indicate that all four lanes could be sloped away from the median.
- (3) See Chapter 440 for minimum number and width of lanes. See Figures 640-8a and 8b and 640.04(2) for turning roadway width.
- (4) See Figures 640-15a and 15c for median details. See Chapter 440 for minimum median width.

Height of cut (ft)	Slope not steeper than (H:V)
0 - 5	6 : 1
5 - 20	3 : 1
over 20	2 : 1 (7)

### Cut Slope Selection (9)

- (5) Where practical, consider flatter slopes for the greater fill heights and ditch depths.
- (6) Widen and round foreslopes steeper than 4H:1V as shown on Figure 640-10b.
- (7) Cut slopes steeper than 2H:1V may be used where favorable soil conditions exist or stepped construction is used. See Chapter 700 for clear zone and barrier requirements.
- (8) Fill slopes as steep as 1½H:1V may be used where favorable soil conditions exist. See Chapter 700 for clear zone and barrier requirements.
- (9) This table is for preliminary estimates or where no other information is available. Design the final slope as recommended in the soils or geotechnical report. Do not disturb existing stable slopes just to meet the slopes given in this table.

## Divided Highway Roadway Sections

Figure 640-3

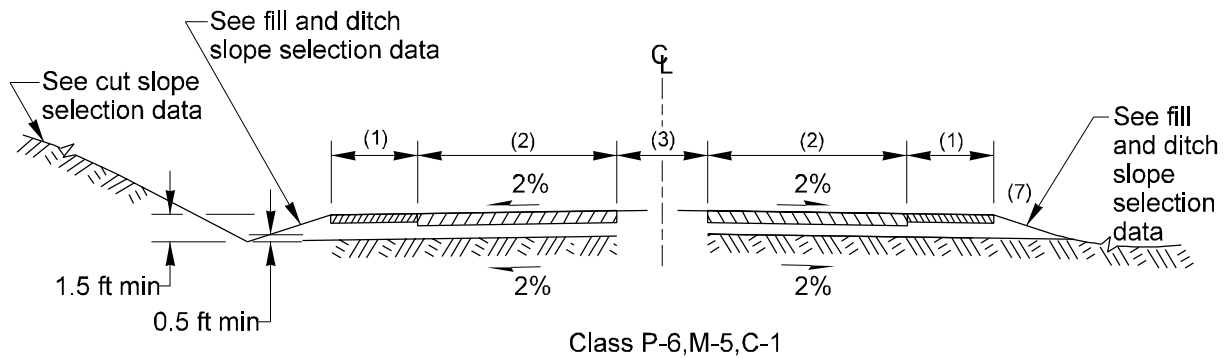

Height of fill/depth of ditch (ft)	Slope not steeper than (H:V) (4)
0 - 5	6 : 1
5 - 20	4 : 1
20 - 30	3 : 1 (7)
over 30	2 : 1 (6) (7)

#### Fill and Ditch Slope Selection

- (1) See Figures 640-10a and 10b for shoulder details. See Chapter 440 for minimum shoulder width.
- (2) See Chapter 440 for minimum number and width of lanes. See Figures 640-7a and 7b and 640.04(2) for turning roadway width.
- (3) See Chapter 440 for minimum median width.
- (4) Where practical, consider flatter slopes for the greater fill heights and ditch depths.
- (5) Cut slopes steeper than 2H:1V may be used where favorable soil conditions exist or stepped construction is used. See Chapter 700 for clear zone and barrier requirements.

Height of cut (ft)	Slope not steeper than (H:V)
0 - 5	4 : 1
over 5	2 : 1 (5)

#### Cut Slope Selection (8)

- (6) Fill slopes up to 1<sup>1</sup>/<sub>2</sub>H:1V may be used where favorable soil conditions exist. See Chapter 700 for clear zone and barrier requirements.
- (7) Widen and round foreslopes steeper than 4H:1V as shown on Figure 640-10b.
- (8) This table is for preliminary estimates or where no other information is available. Design the final slope as recommended in the soils or geotechnical report. Do not disturb existing stable slopes just to meet the slopes given in this table.

**Undivided Multilane Highway Roadway Sections**  
Figure 640-4

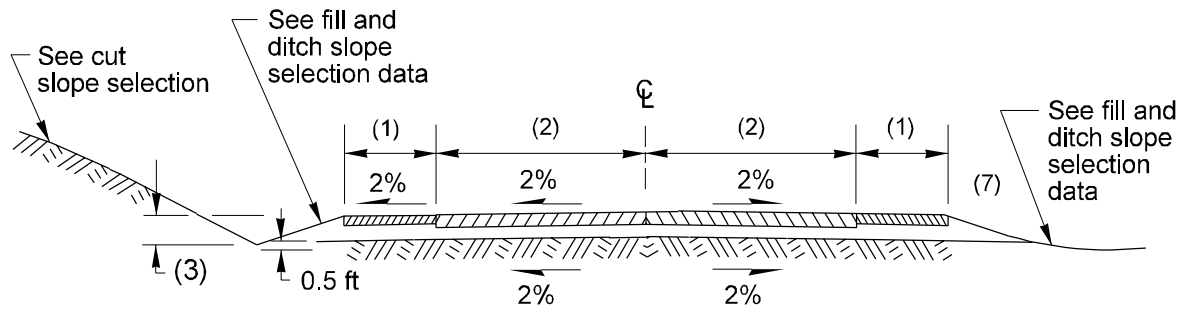

Design Class P-3,P-4,P-5,M-2,M-3,M-4,C-2,C-3,C-4

Design class of highway	P-3, P-4, M-2, C-2 (4)	P-5, M-3, M-4, C-3, C-4
Height of fill/depth of ditch (ft)	Slope not steeper than (H:V)	
0 - 10	6 : 1	4 : 1
10 - 20	4 : 1	4 : 1
20 - 30	3 : 1 (7)	3 : 1 (7)
over 30	2 : 1 (5) (7)	2 : 1 (5) (7)

Design class of highway	P-3, P-4, M-2, C-2	P-5, M-3, M-4, C-3, C-4
Height of cut (ft)	Slope not steeper than (H:V)	
0 - 5	6 : 1	4 : 1
5 - 20	3 : 1	2 : 1 (6)
over 20	2 : 1 (6)	2 : 1 (6)

Cut Slope Selection (8)

### Fill and Ditch Slope Selection

- (1) See Figures 640-10a and 10b for shoulder details. See Chapter 440 for minimum shoulder width.
- (2) See Chapter 440 for minimum width of lanes. See Figures 640-7a and 7b and 640.04(2) for turning roadway width.
- (3) The minimum ditch depth is 2 ft for Design Class P-3 and 1.5 ft for Design Class P-4, P-5, M-2, M-3, M-4, C-2, C-3, and C-4.
- (4) Where practical, consider flatter slopes for the greater fill heights.
- (5) Fill slopes up to 1<sup>1</sup>/<sub>2</sub>H:1V may be used where favorable soil conditions exist. See Chapter 700 for clear zone and barrier requirements.
- (6) Cut slopes steeper than 2H:1V may be used where favorable soil conditions exist or stepped construction is used. See Chapter 700 for clear zone and barrier requirements.
- (7) Widen and round foreslopes steeper than 4H:1V, as shown on Figure 640-10b.
- (8) This table is for preliminary estimates or where no other information is available. Design the final slope as recommended in the soils or geotechnical report. Do not disturb existing stable slopes just to meet the slopes given in this table.

## Two-Lane Highway Roadway Sections

Figure 640-5



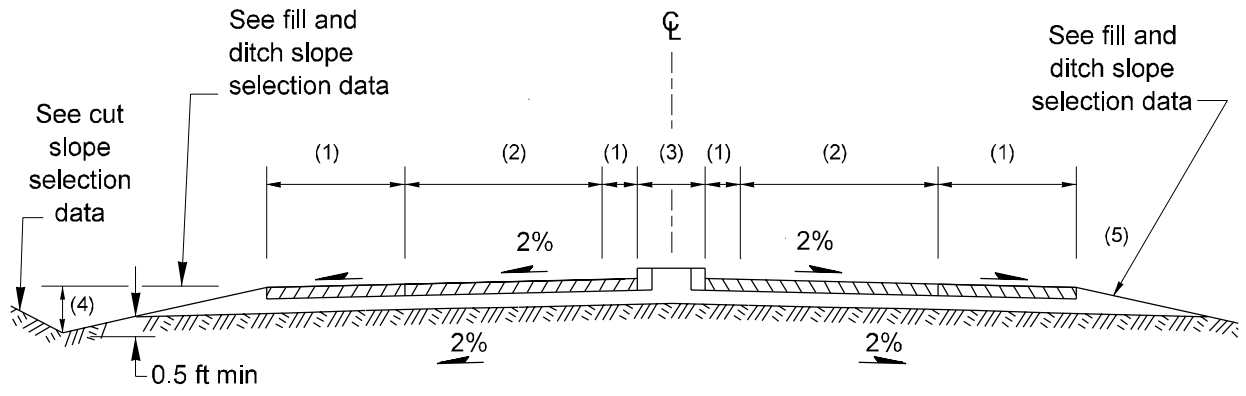

Two-Lane Two-Way Ramp

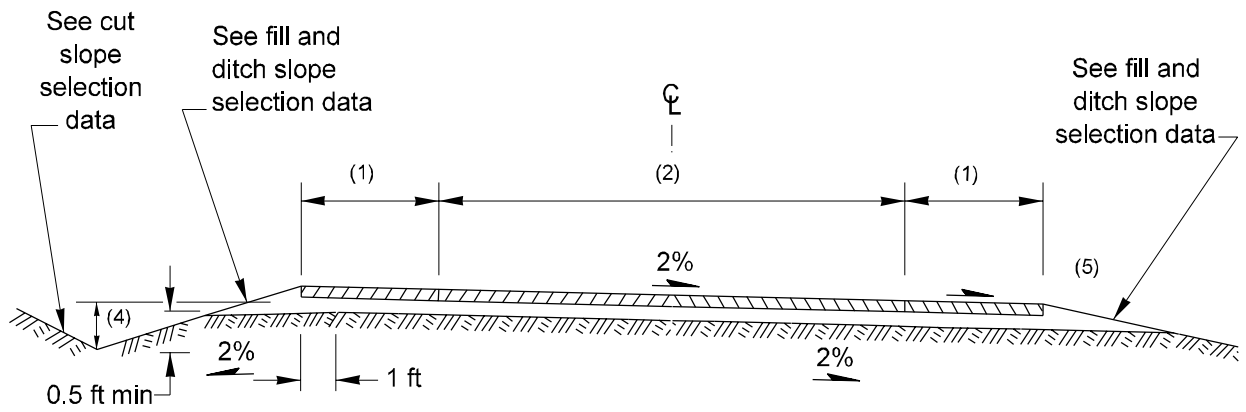

Two-Lane One-Way Ramp

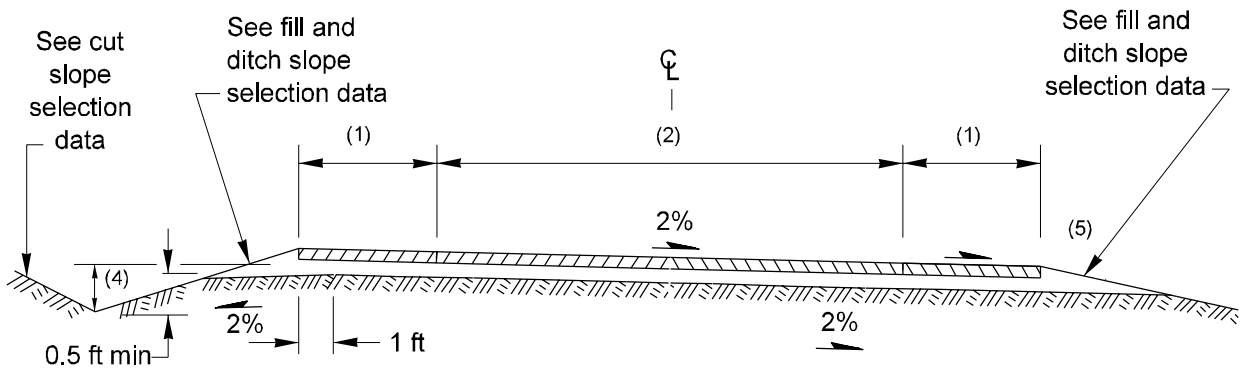

One-Lane Ramp

For notes, dimensions, and slope selection tables see Figure 640-6b

**Ramp Roadway Sections**  
*Figure 640-6a*

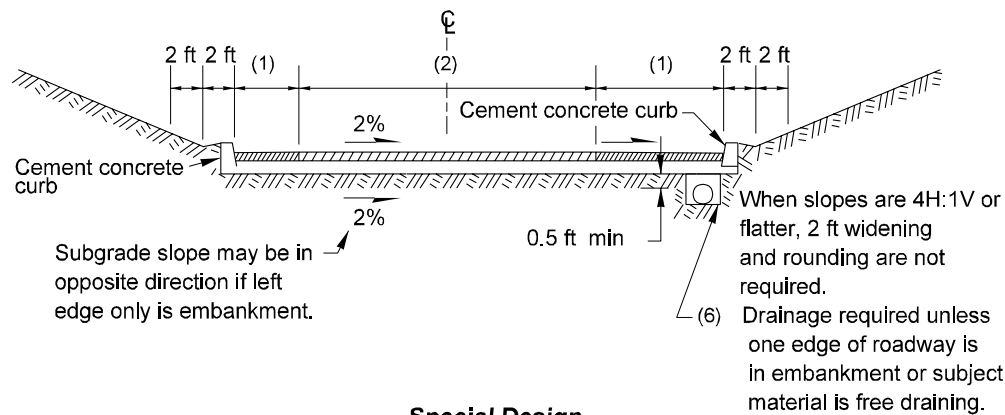

### Special Design

This special design is to be used only when restrictions (high right of way costs or physical features that are difficult or costly to correct) require its consideration.

Height of fill/depth of ditch (ft)	Slope not steeper than (H:V) (7)
0 - 10	6 : 1
10 - 20	4 : 1
20 - 30	3 : 1 (5)
over 30	2 : 1 (5) (9)

### Fill and Ditch Slope Selection

- (1) See Figures 640-10a and 10b for shoulder details. See Chapter 940 for minimum shoulder widths.
- (2) See Chapter 940 for minimum ramp lane widths.
  - For one-lane ramp turning roadways see Figures 640-9a thru 9c for traveled way width.
  - For two-lane one-way ramp turning roadways, see Figures 640-8a & 8b for traveled way width.
  - For two-way ramps treat each direction as a separate one-way roadway.
- (3) The minimum median width of a two-lane, two-way ramp is not less than that required for traffic control devices and their respective shy distances.
- (4) Minimum ditch depth is 2 ft for design speeds over 40 mph and 1.5 ft for design speeds of 40 mph or less. Rounding may be varied to fit drainage requirements when minimum ditch depth is 2 ft.

Height of cut (ft)	Slope not steeper than (H:V)
0 - 5	6 : 1
5 - 20	3 : 1
over 20	2 : 1 (8)

### Cut slope Selection (10)

- (5) Widen and round foreslopes steeper than 4H:1V as shown on Figure 640-10b.
- (6) Method of drainage pickup to be determined by the designer.
- (7) Where practical, consider flatter slopes for the greater fill heights and ditch depths.
- (8) Cut slopes steeper than 2H:1V may be used where favorable soil conditions exist or stepped construction is used. See Chapter 700 for clear zone and barrier requirements.
- (9) Fill slopes as steep as 1½H:1V may be used where favorable soil conditions exist. See Chapter 700 for clear zone and barrier requirements.
- (10) This table is for preliminary estimates or where no other information is available. Design the final slope as recommended in the soils or geotechnical report. Do not disturb existing stable slopes just to meet the slopes given in this table.

## Ramp Roadway Sections

Figure 640-6b

Radius on center line of traveled way (ft)	Design traveled way width (W) (ft)
3,000 to tangent	24
2,999	25
2,000	26
1,000	27
800	28
700	28
600	29
500	29
400	30
350	31
300	32
250	34
200	36
150	40

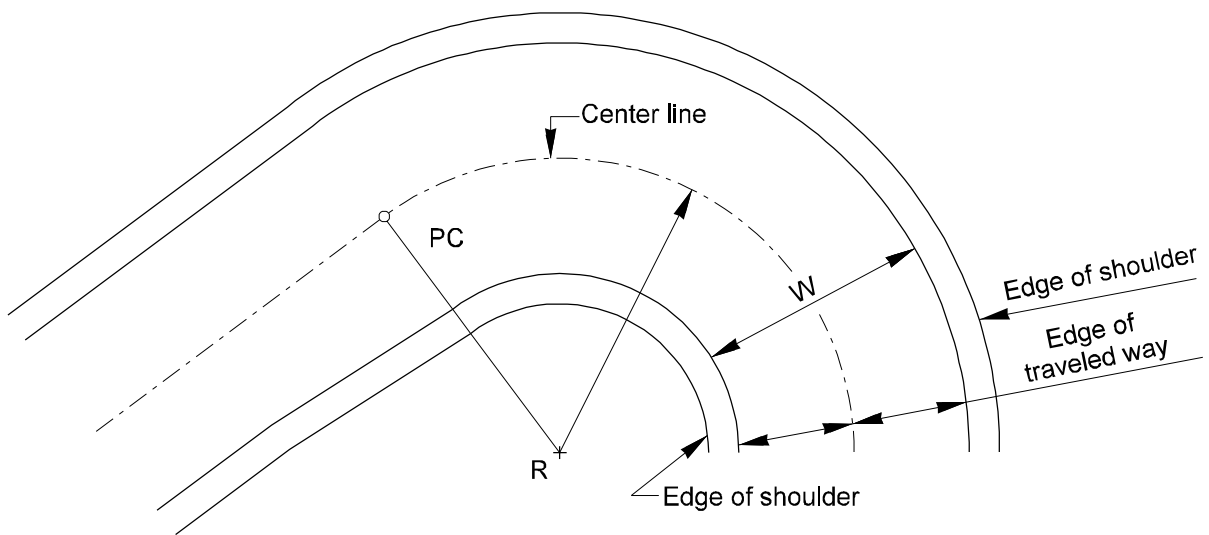

**Traveled Way Width for Two-Way Two-Lane Turning Roadways**  
*Figure 640-7a*

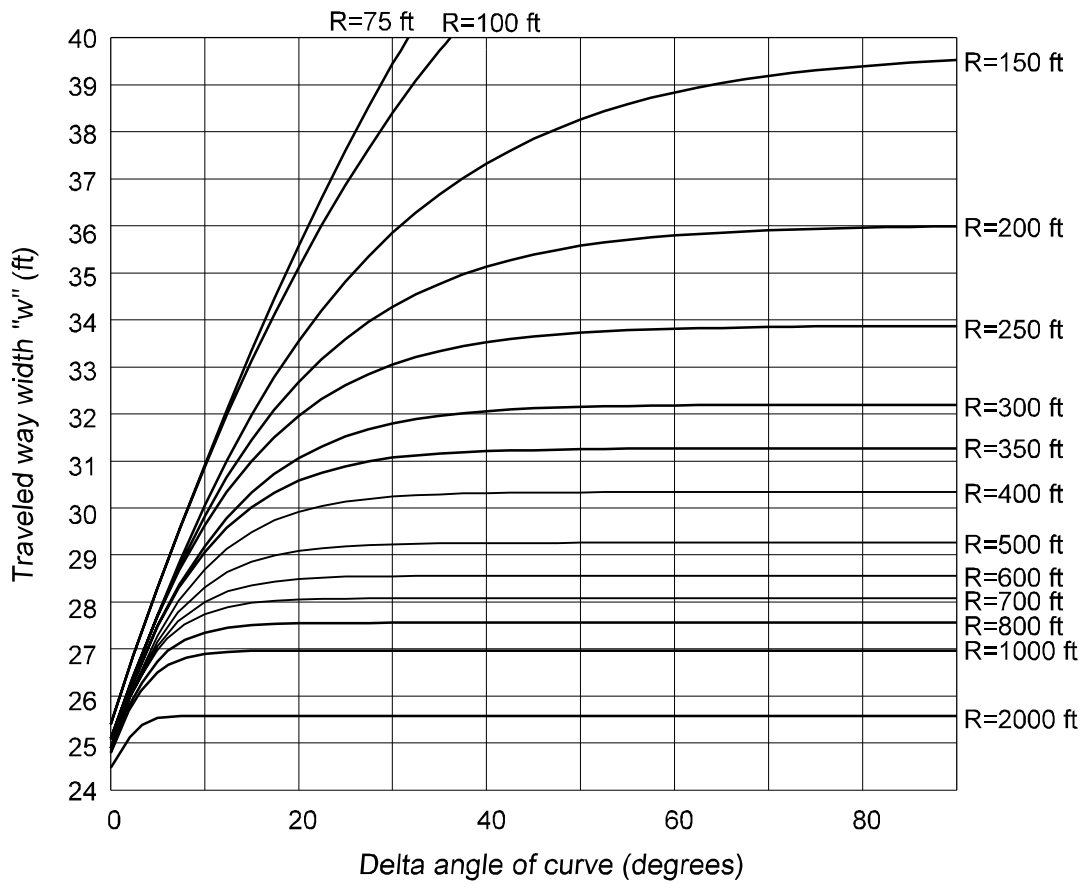

**Traveled Way Width for Two-Way Two-Lane Turning Roadways**  
*Figure 640-7b*

Radius on center line of traveled way (ft)	Design traveled way width (W) (ft)
3,000 to tangent	24
<u>1,000 to 2,999</u>	25
999	26
600	26
500	27
400	27
350	28
300	28
250	29
200	29
150	31
100	34

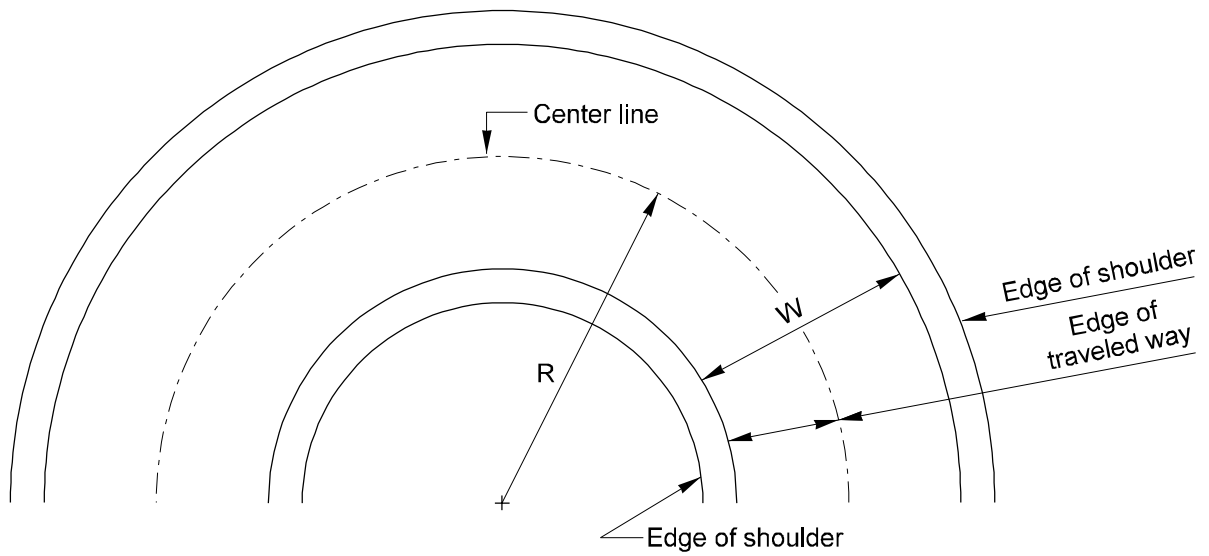

**Traveled Way Width for Two-Lane One-Way Turning Roadways**  
*Figure 640-8a*

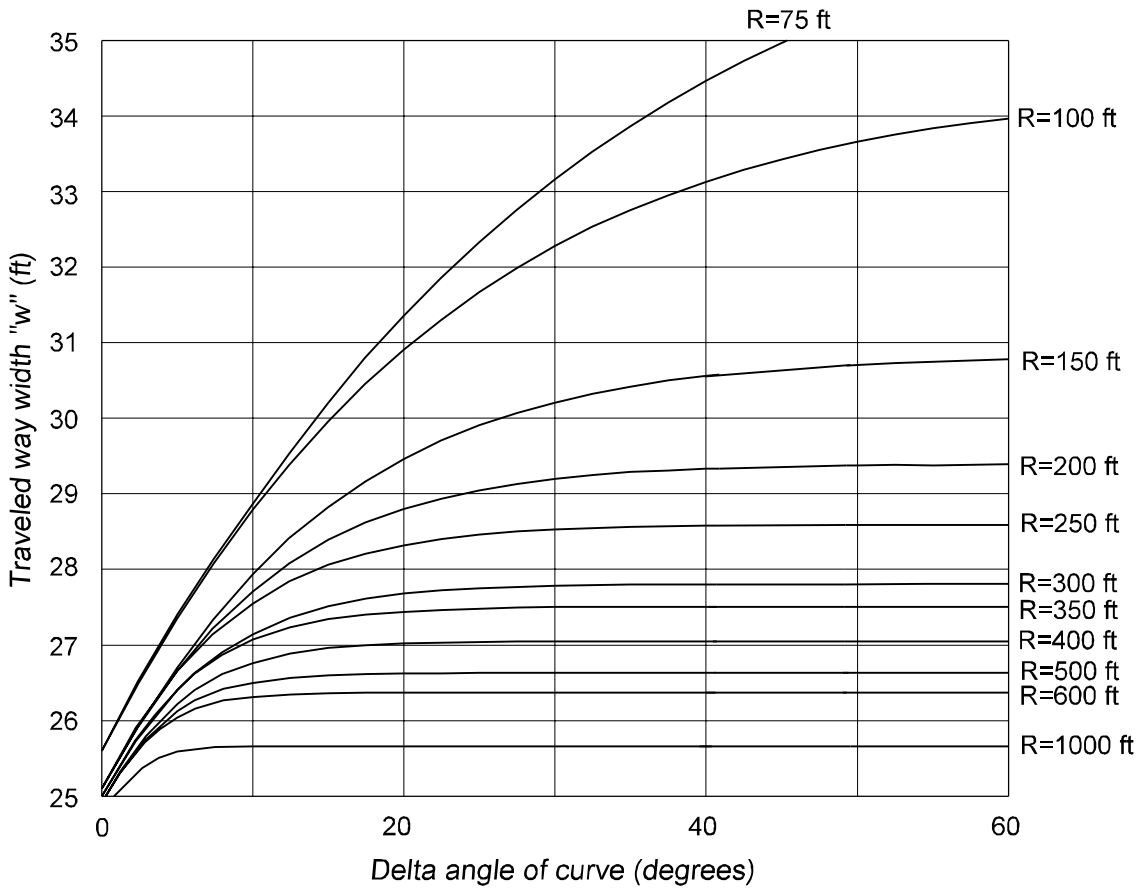

**Traveled Way Width for Two-Lane One-Way Turning Roadways**  
*Figure 640-8b*

Radius (ft)	Design traveled way width (W) (ft)
300 to tangent	15 <sup>(1)</sup>
299	16
250	16
200	17
165	17.5
130	18 <sup>(2)</sup>
100	19 <sup>(3)</sup>
75	21 <sup>(4)</sup>

- (1) On tangents, the minimum lane width may be reduced to 12 ft.
- (2) The width given is for a radius on the outside edge of the traveled way. When the radius is on the inside edge of traveled way, the width may be 17.7 ft.
- (3) The width given is for a radius on the outside edge of the traveled way. When the radius is on the inside edge of traveled way, the width may be 18 ft.
- (4) The width given is for a radius on the outside edge of the traveled way. When the radius is on the inside edge of traveled way, the width may be 19 ft.

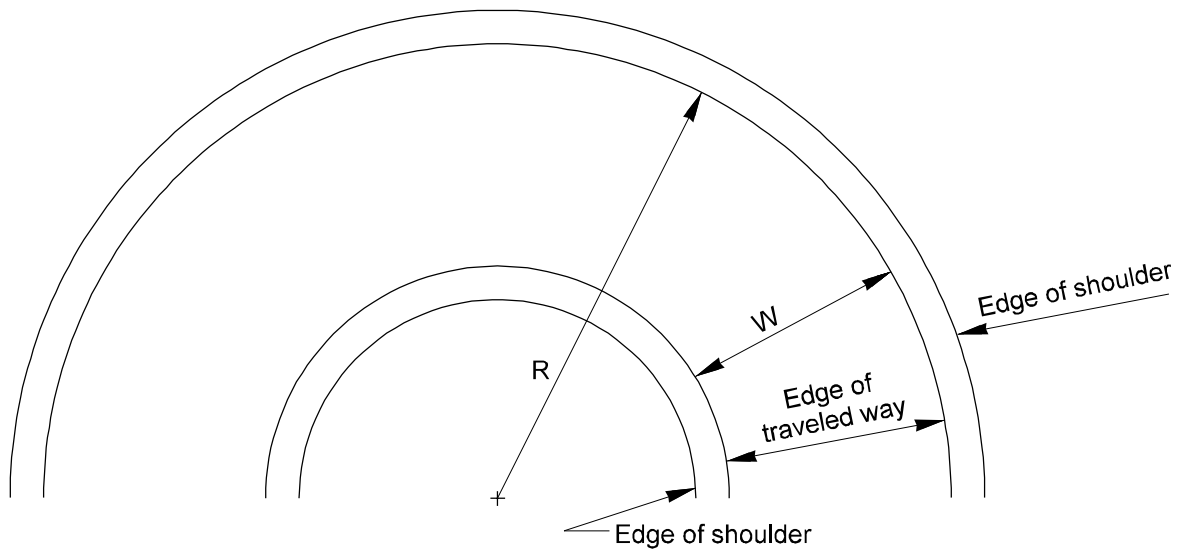

### Traveled Way Width for One-Lane Turning Roadways

Figure 640-9a

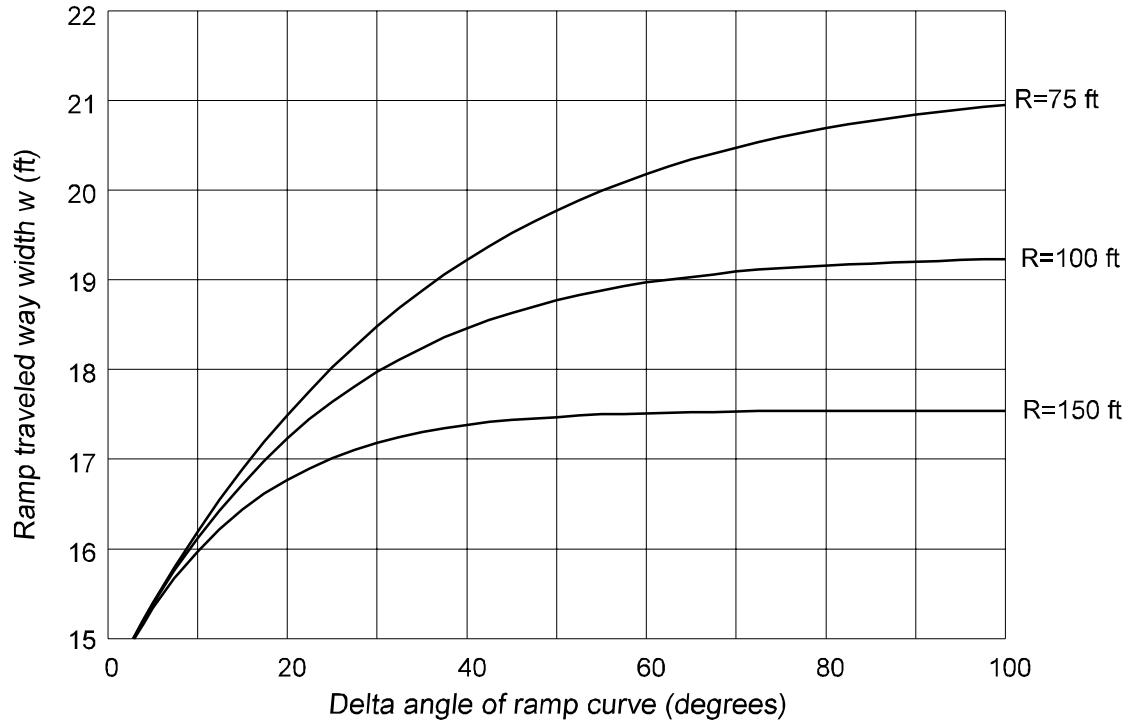

NOTE: All Radii are to the outside edge of traveled way.

**Traveled Way Width for One-Lane Turning Roadways**  
*Figure 640-9b*



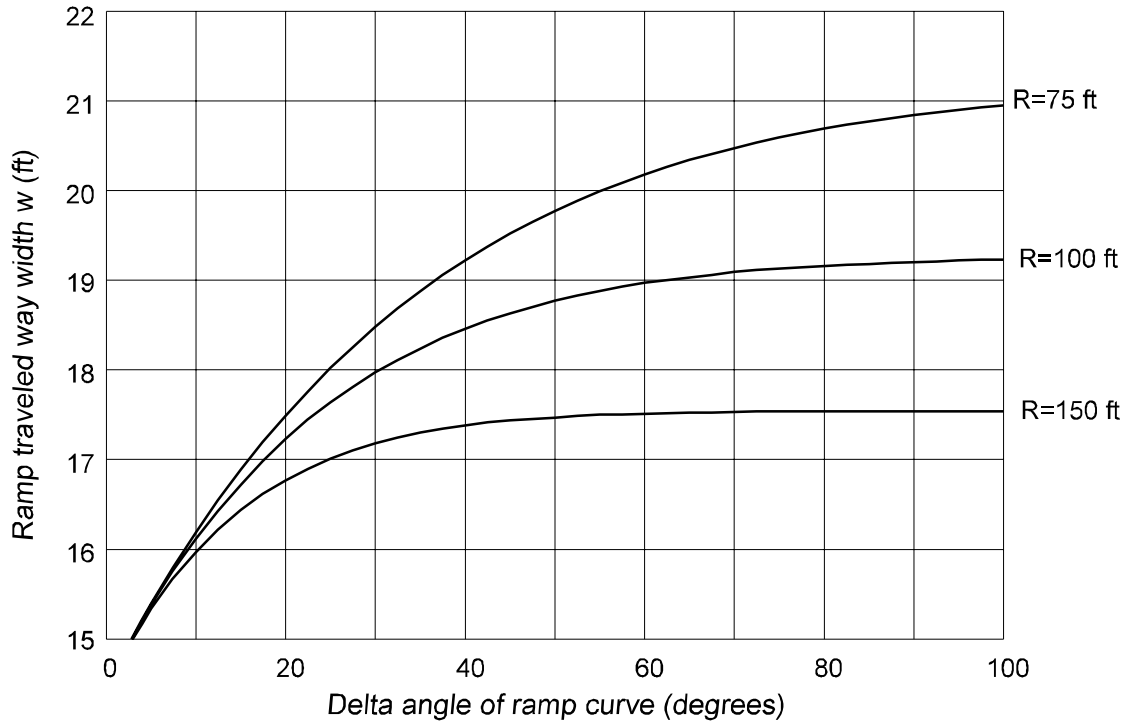

NOTE: All Radii are to the outside edge of traveled way.

**Traveled Way Width for One-Lane Turning Roadways**  
*Figure 640-9c*

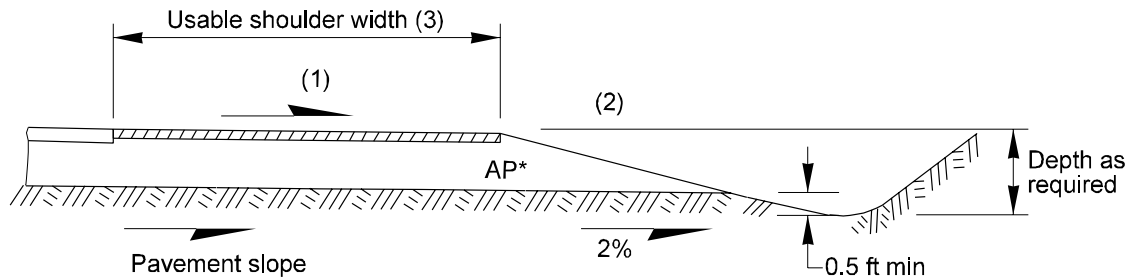

Shoulder Design on the Low Side of the Roadway for Cross Slopes Greater Than 2%

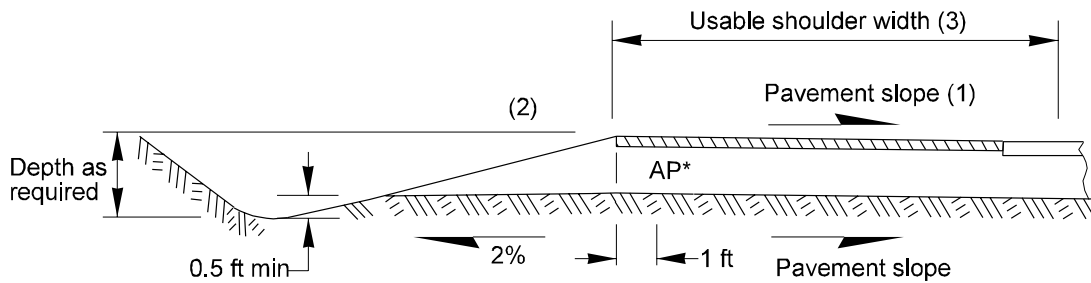

Shoulder Design on the High Side of the Roadway on Curves and Divided Roadways Shoulder Slopes with Roadway

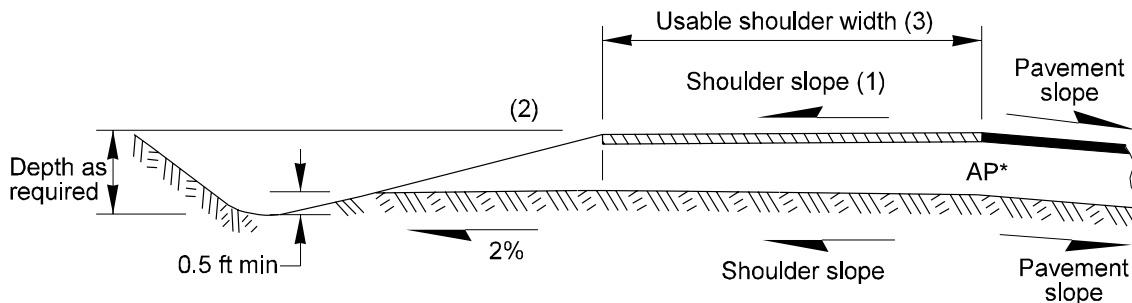

Shoulder Design on the High Side of the Roadway on Curves and Divided Roadways Away from Roadway

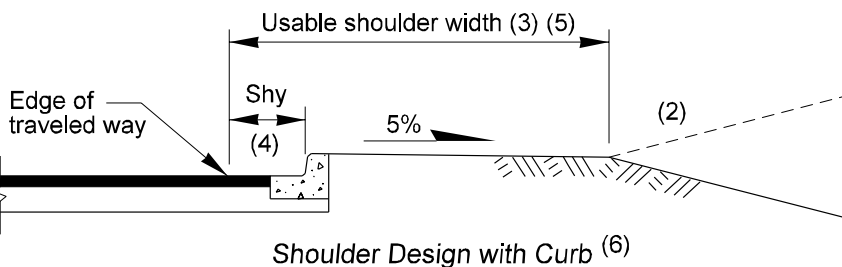

\* AP = angle point in the subgrade.  
For notes, see Figure 640-10b

**Shoulder Details**  
*Figure 640-10a*

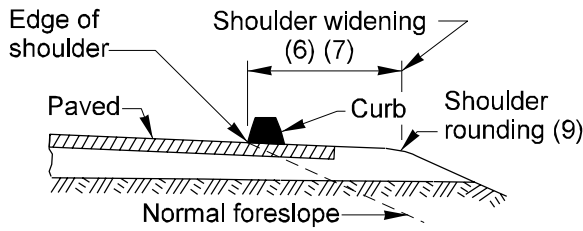

Asphalt Concrete Curb Placement

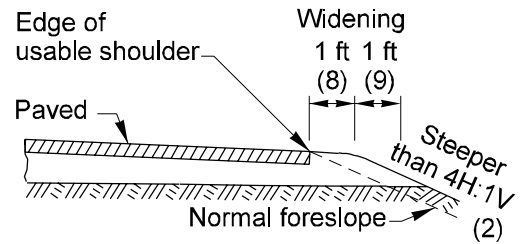

Shoulder Rounding

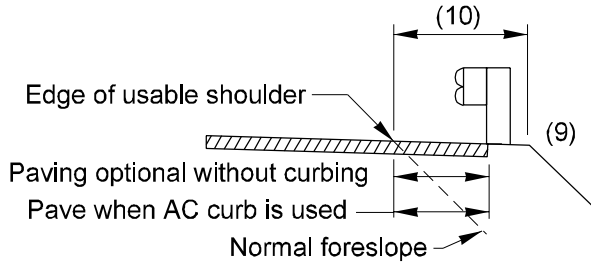

Shoulder Widening for Guardrail

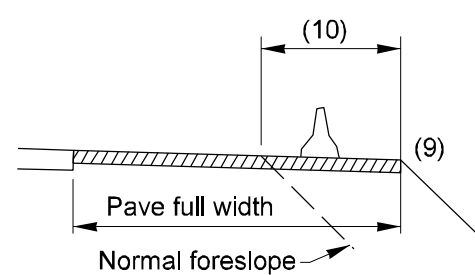

Shoulder Widening for Guardrail

- (1) Shoulder cross slopes are normally the same as the cross slopes for adjacent lanes. See 640.04(3) in the text for examples, additional information, and requirements of locations where it may be desirable to have a shoulder cross slope different than the adjacent lane.
- (2) Widening and shoulder rounding outside the usable shoulder is required when foreslope is steeper than 4H:1V.
- (3) See Chapter 440 for shoulder width.
- (4) See Chapter 910 for shy distance.
- (5) See Chapter 1020 for additional requirements for sidewalks.
- (6) It is preferred that curb not be used on high speed facilities (posted speed >40 mph).
- (7) Paved shoulders are required wherever asphalt concrete curb is placed. Use it only where necessary to control drainage from roadway runoff. See the Standard Plans for additional details and dimensions.
- (8) When rounding is required, use it uniformly on all ramps and crossroads, as well as the main roadway. End rounding on the crossroad just beyond the ramp terminals and at a similar location where only a grade separation is involved.
- (9) When widening beyond the edge of usable shoulder is required for asphalt concrete curb, barrier, or other purposes, additional widening for shoulder rounding is not required.
- (10) See Chapter 710 for required widening for guardrail and concrete barrier.
- (11) On divided multilane highways see Figures 640-15a and 15c or additional details and requirements for median shoulders.

## Shoulder Details

Figure 640-10b

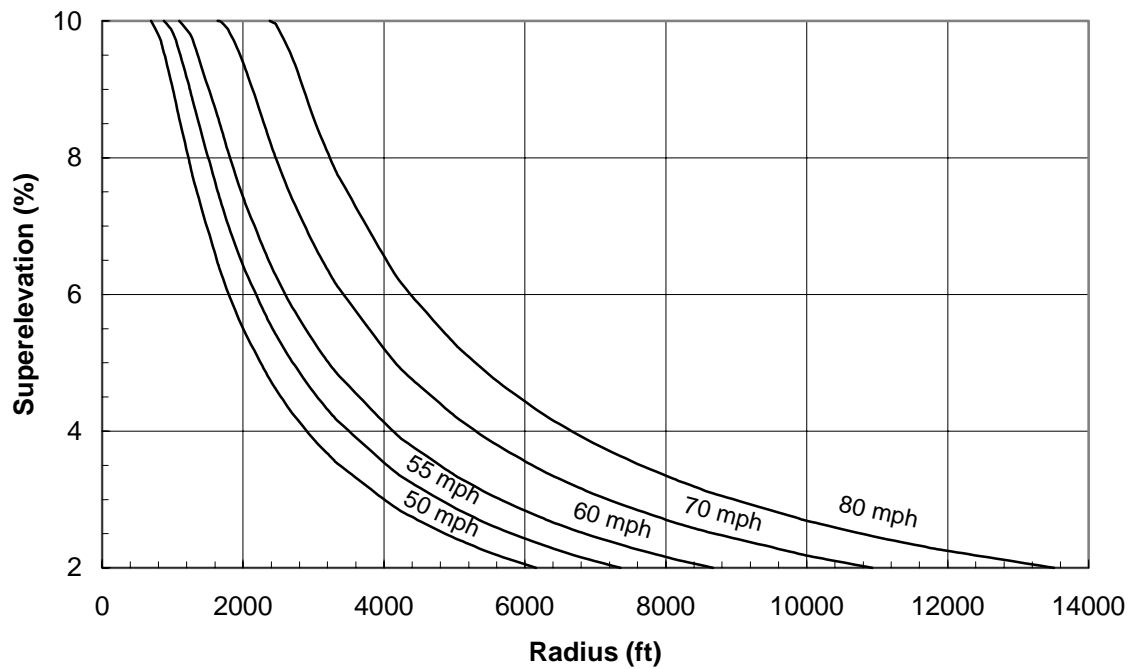
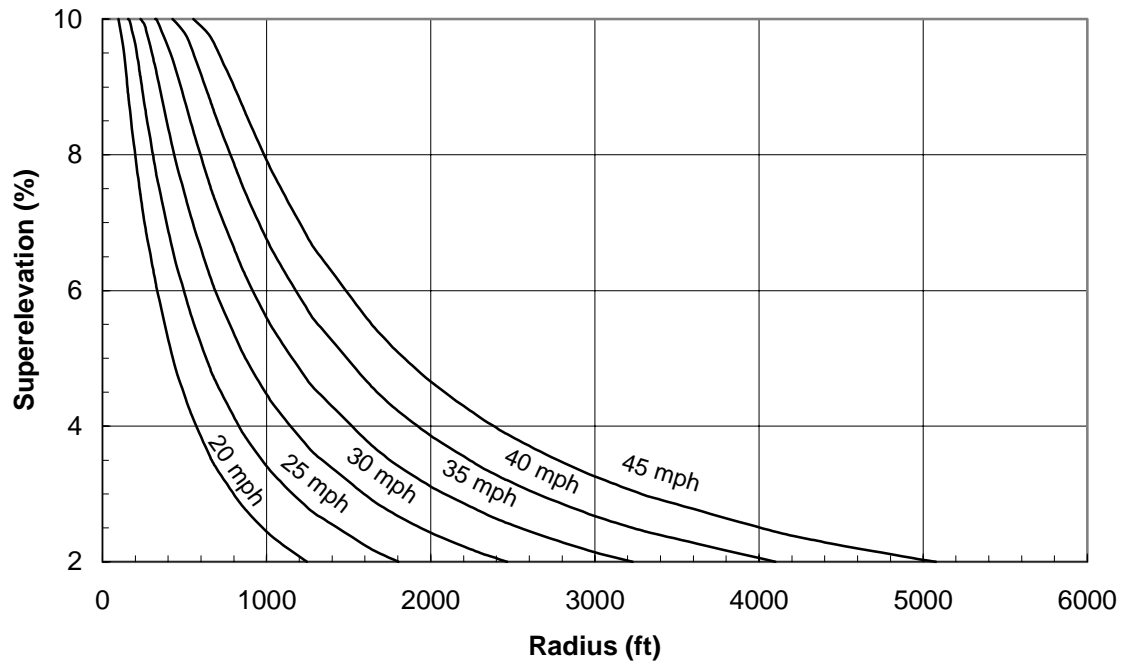

Design Speed (mph)	20	25	30	35	40	45	50	55	60	70	80
Minimum Radius (ft)	100	160	240	330	430	560	700	880	1100	1640	2380

**Superelevation Rates (10% max)**  
*Figure 640-11a*

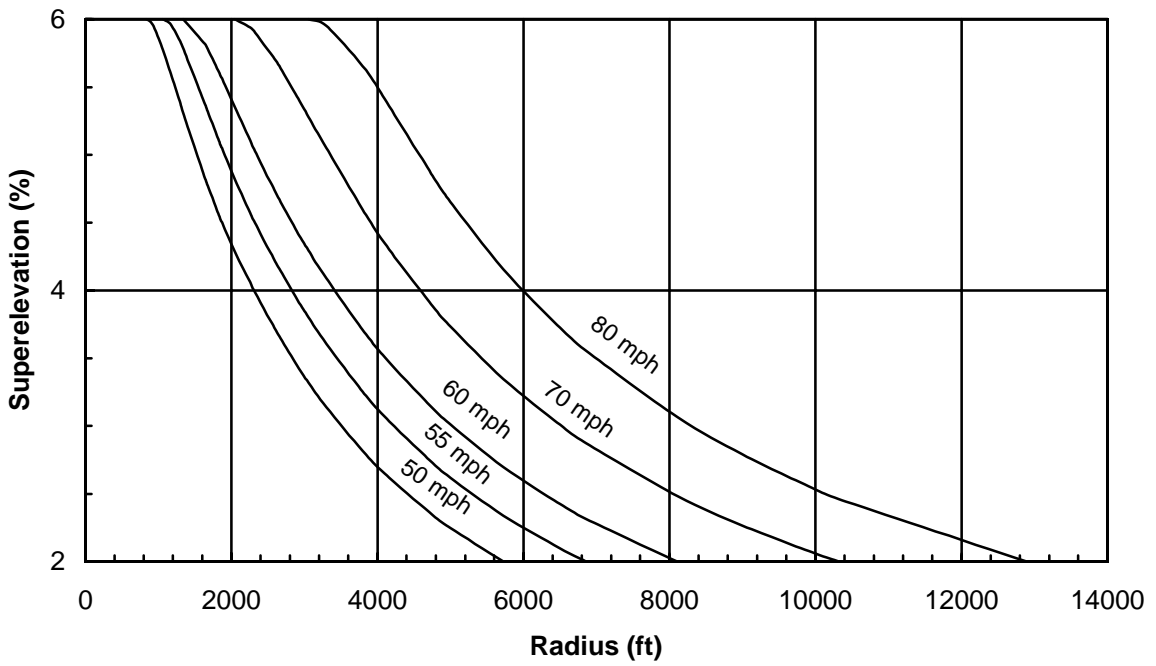
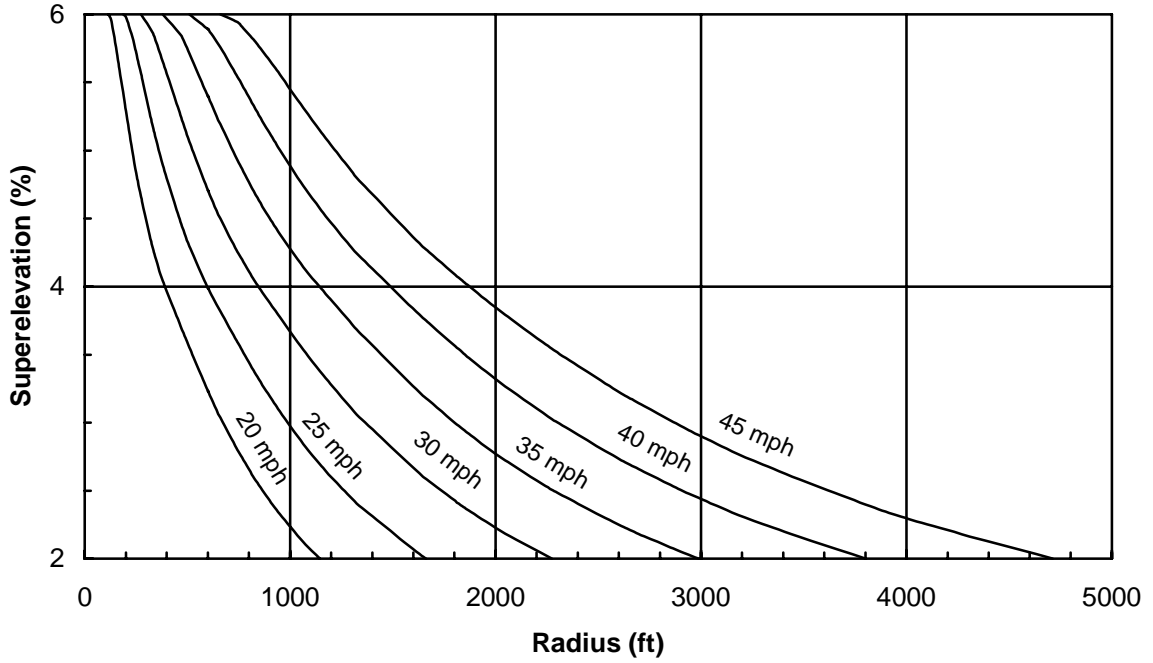

Design Speed (mph)	20	25	30	35	40	45	50	55	60	70	80
Minimum Radius (ft)	120	190	280	390	510	670	840	1070	1340	2050	3060

**Superelevation Rates (6% max)**  
*Figure 640-11b*

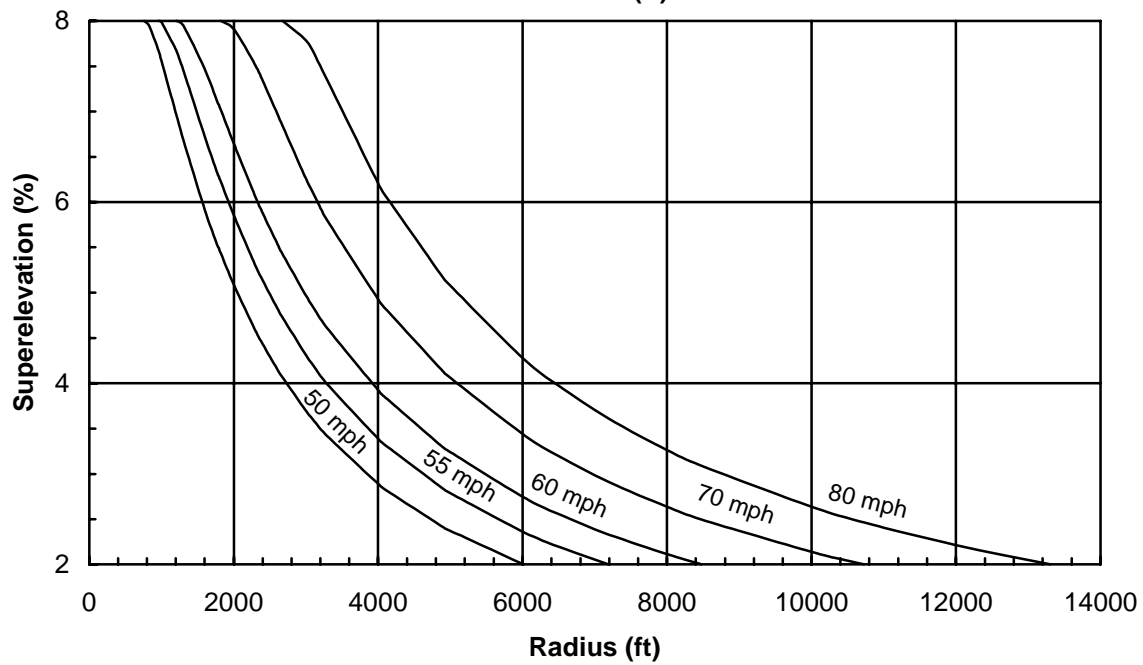
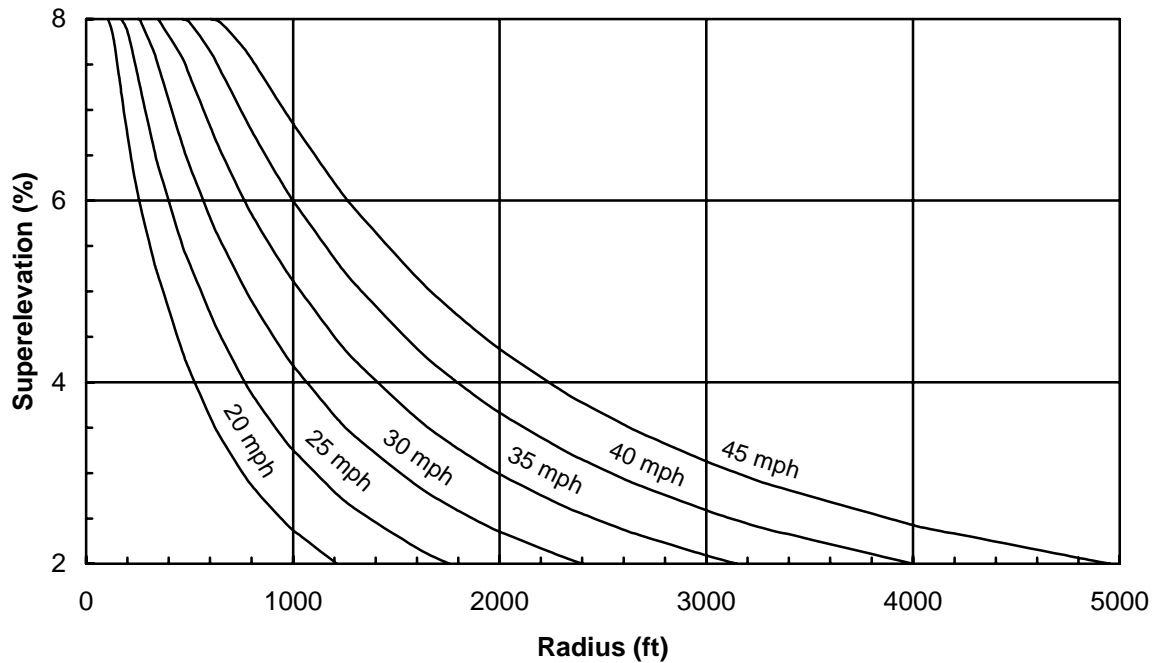

Design Speed (mph)	20	25	30	35	40	45	50	55	60	70	80
Minimum Radius (ft)	110	180	260	350	470	610	770	970	1210	1830	2680

**Superelevation Rates (8% max)**  
*Figure 640-11c*

Curve Radius (ft)	Range in Superelevation Rates (%) for Design Speed of:					
	15 mph	20 mph	25 mph	30 mph	35 mph	40 mph
50	2 - 10					
90	2 - 7	2 - 10				
150	2 - 5	2 - 8	4 - 10			
230	2 - 4	2 - 6	3 - 8	6 - 10		
310	2 - 3	2 - 4	3 - 6	5 - 9	8 - 10	
430	2 - 3	2 - 3	3 - 5	4 - 7	6 - 9	9 - 10
600	2	2 - 3	2 - 4	3 - 5	5 - 7	7 - 9
1,000	2	2 - 3	2 - 3	3 - 4	4 - 5	5 - 6
1,500	2	2	2	2 - 3	3 - 4	4 - 5
2,000	2	2	2	2	2 - 3	3 - 4
3,000	2	2	2	2	2	2 - 3

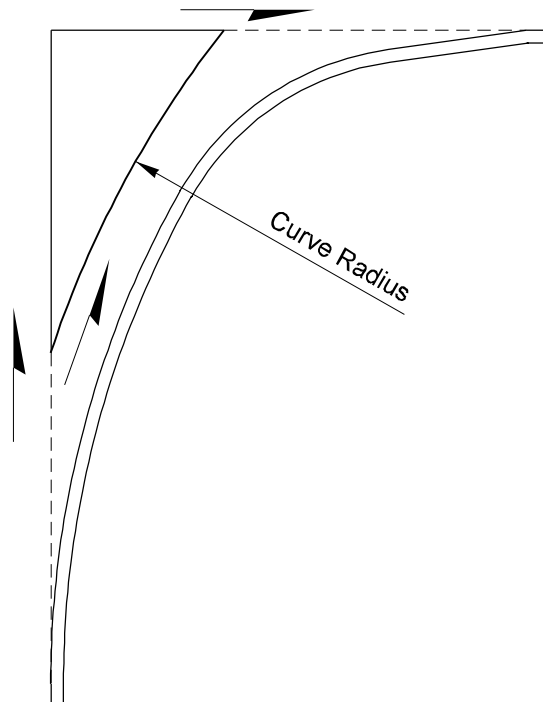

**Superelevation Rates for Turning Roadways at Intersections**  
**Figure 640-12**

S	*L <sub>B</sub> =Basic runoff in feet for Design Speed of:										
	20 mph	25 mph	30 mph	35 mph	40 mph	45 mph	50 mph	55 mph	60 mph	70 mph	80 mph
2	35	35	35	40	45	45	45	50	55	60	65
3	50	50	55	60	65	65	70	75	80	90	100
4	65	70	70	75	85	90	95	100	105	120	130
5	80	85	90	95	105	110	120	125	130	150	165
6	95	100	105	115	125	135	140	150	160	180	200
7	110	120	125	135	145	155	165	180	185	210	230
8	125	135	145	155	165	180	190	200	210	235	265
9	140	150	160	175	190	200	215	225	235	265	295
10	160	170	180	195	210	225	235	255	265	295	330
Min L <sub>R</sub>	65	80	115	115	130	150	165	165	180	215	230

\*Based on one 12 ft lane between the pivot point and the edge of traveled way. When the distance exceeds 12 ft use the following equation to obtain L<sub>R</sub>:

$$L_R = L_B(1 + 0.04167X)$$

Where:

X = The distance in excess of 12 ft between the pivot point and the furthest edge of traveled way, in meters

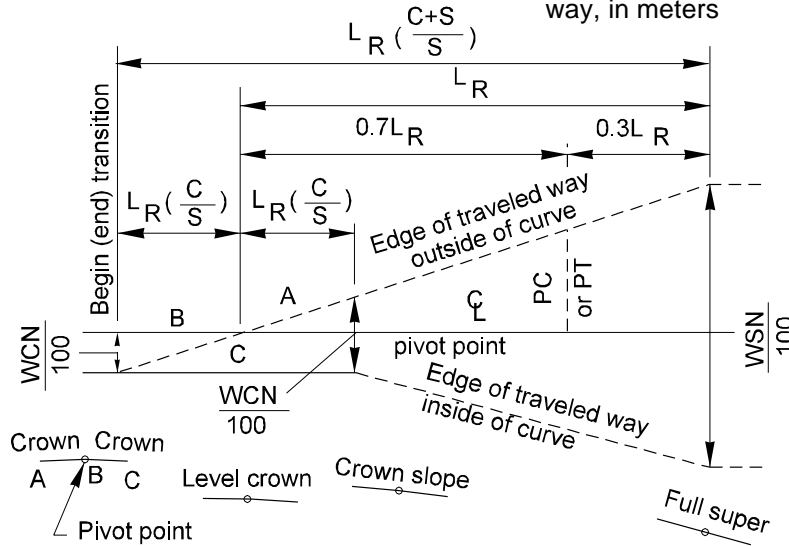

Design A Pivot Point on Center Line Crowned Section

- C = Normal crown(%)
- S = Superelevation rate (%)
- N = Number of lanes between points
- W = Width of lane

### Superelevation Transitions for Highway Curves

Figure 640-13a



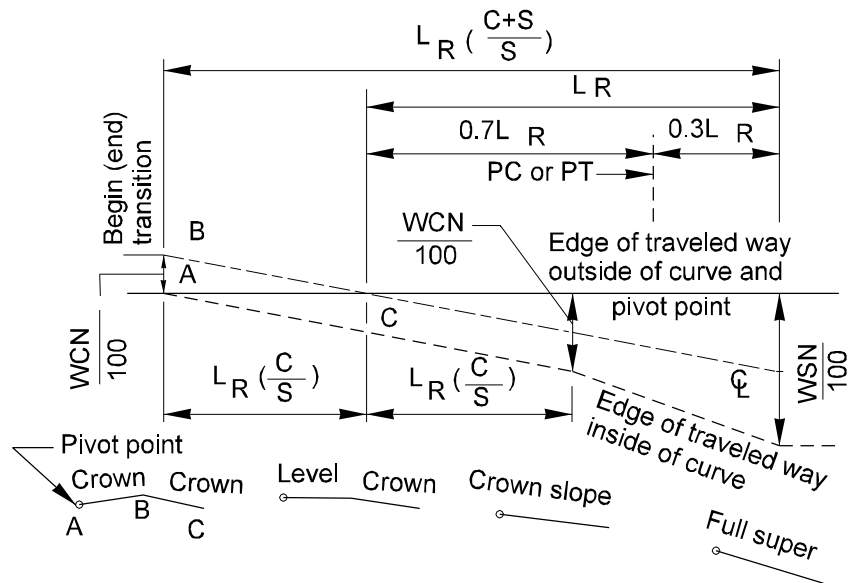

Design B<sup>1</sup> Pivot Point on Edge of Pavement Outside of Curve Crowned Section

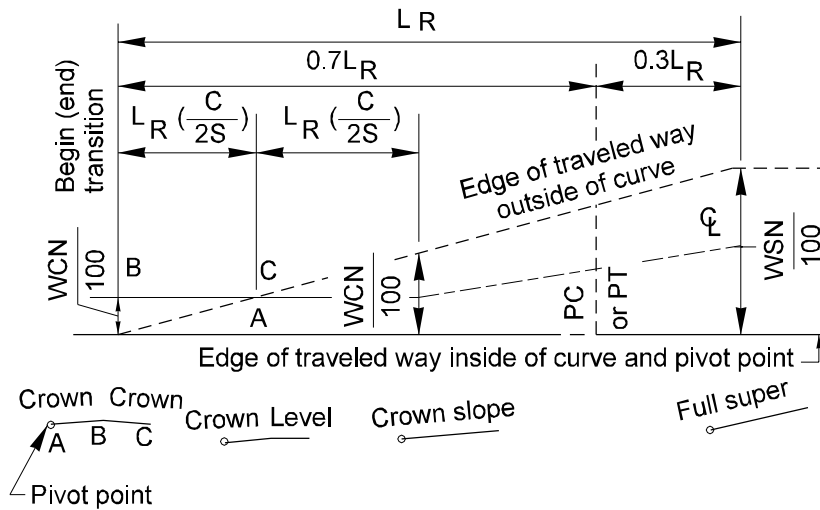

Design B<sup>2</sup> Pivot Point on Edge of Pavement Inside of Curve Crowned Section

- C = Normal crown(%)
- S = Superelevation rate (%)
- N = Number of lanes between points
- W = Width of lane

**Superelevation Transitions for Highway Curves**  
Figure 640-13b

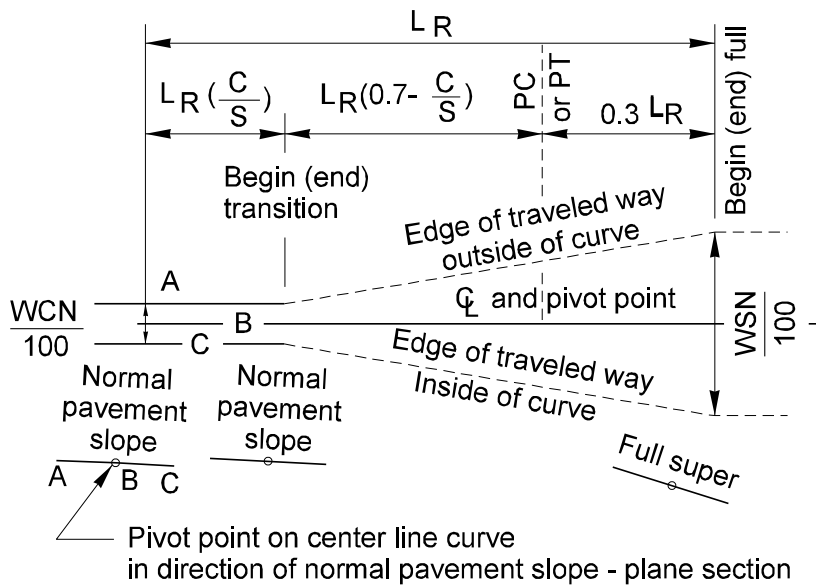

### Design C<sup>1</sup>

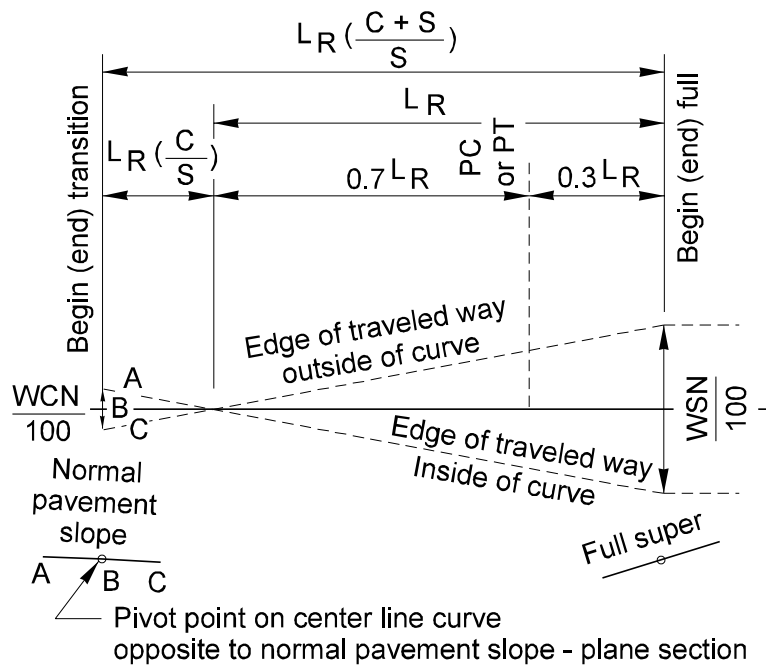

### Design C<sup>2</sup>

- C = Normal crown(%)
- S = Superelevation rate (%)
- N = Number of lanes between points
- W = Width of lane

## Superelevation Transitions for Highway Curves

Figure 640-13c

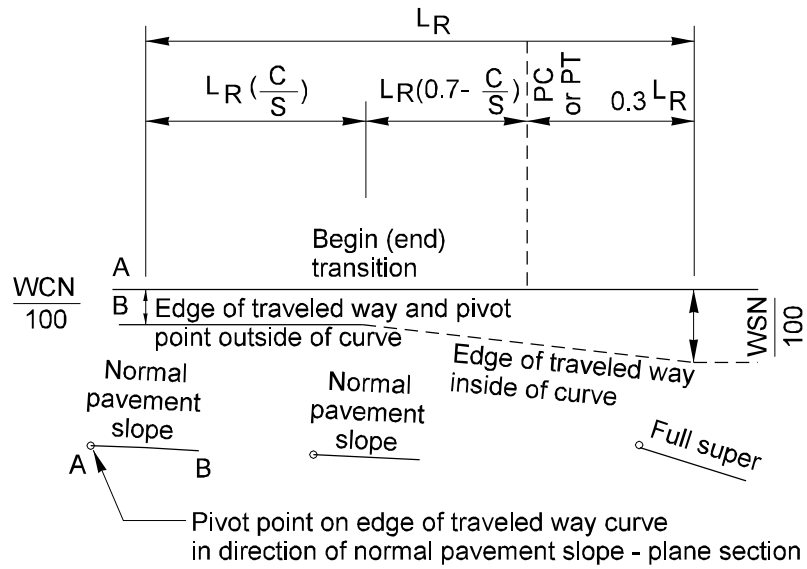

Design D<sup>1</sup>

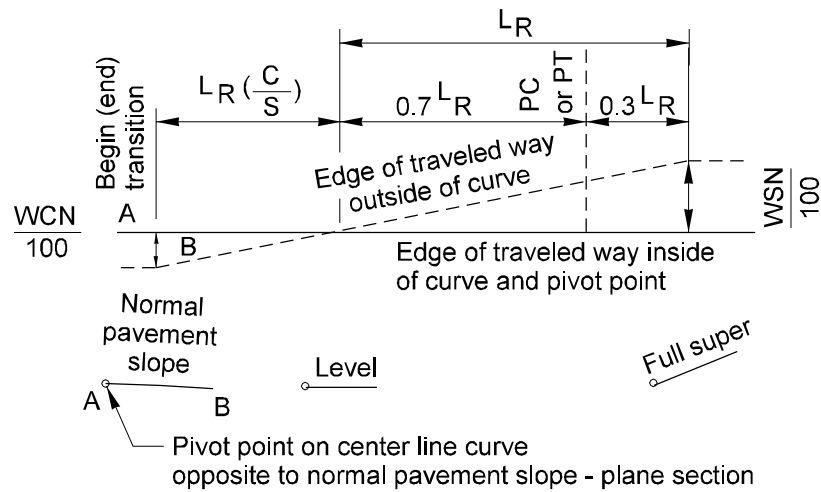

Design D<sup>2</sup>

- C = Normal crown(%)
- S = Superelevation rate (%)
- N = Number of lanes between points
- W = Width of lane

### Superelevation Transitions for Highway Curves

Figure 640-13d

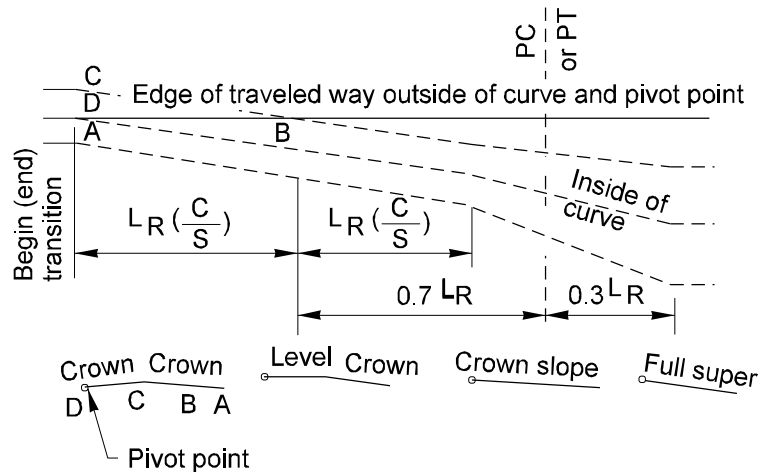
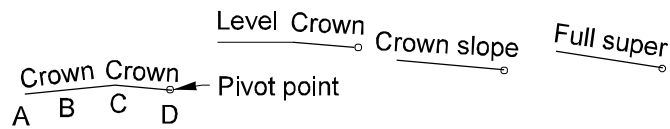
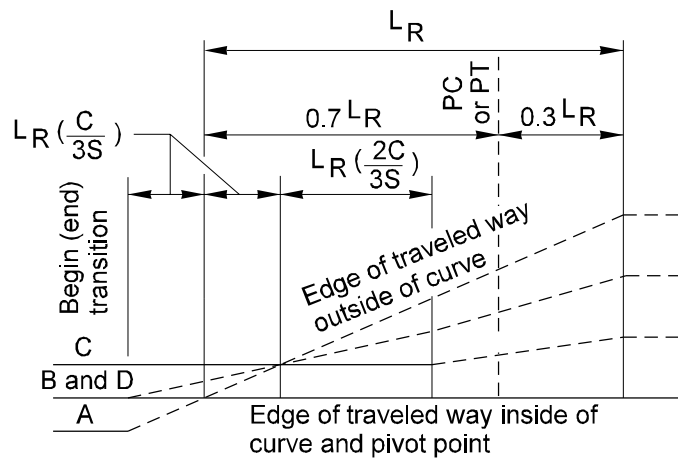

Transition profiles for typical six lanes with median  
Design E

- C = Normal crown(%)
- S = Superelevation rate (%)
- N = Number of lanes between points
- W = Width of lane

**Superelevation Transitions for Highway Curves**  
Figure 640-13e

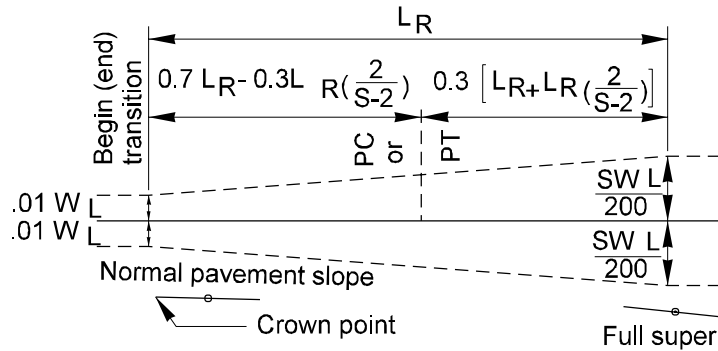

S (%)	Length of transition in feet for Design Speed of:															
	20 mph		25 mph		30 mph		35 mph		40 mph		45 mph		50 mph		≥ 55 mph	
	L <sub>B</sub>	L <sub>T</sub>	L <sub>B</sub>	L <sub>T</sub>	L <sub>B</sub>	L <sub>T</sub>	L <sub>B</sub>	L <sub>T</sub>	L <sub>B</sub>	L <sub>T</sub>	L <sub>B</sub>	L <sub>T</sub>	L <sub>B</sub>	L <sub>T</sub>	L <sub>B</sub>	L <sub>T</sub>
3	10	65	15	80	15	115	15	115	15	130	15	150	15	165	15	165
4	20	65	25	80	25	115	25	115	25	130	30	150	30	165	35	165
5	30	65	35	80	35	115	35	115	40	130	45	150	45	165	50	165
6	40	65	45	80	45	115	50	115	55	130	55	150	60	165	65	165
7	50	65	55	80	55	115	60	115	65	130	70	150	75	165	80	165
8	60	65	65	80	70	115	75	115	80	130	85	150	90	165	95	165
9	70	70	75	80	80	115	85	115	95	130	100	150	105	165	110	165
10	80	80	85	85	90	115	100	115	105	130	115	150	120	165	130	165

Table 1 Pivot Point on Center Line — Curve in Direction of Normal Pavement Slope

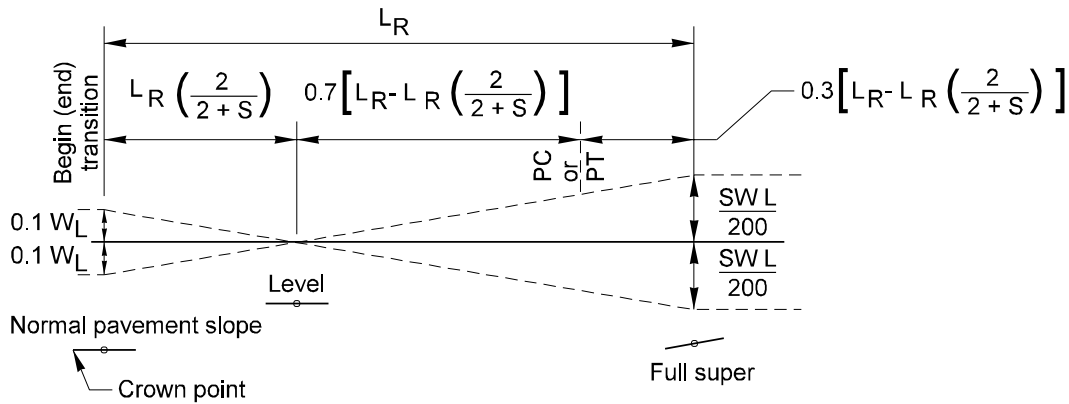

S (%)	Length of transition in feet for Design Speed of:															
	20 mph		25 mph		30 mph		35 mph		40 mph		45 mph		50 mph		≥ 55 mph	
	L <sub>B</sub>	L <sub>T</sub>	L <sub>B</sub>	L <sub>T</sub>	L <sub>B</sub>	L <sub>T</sub>	L <sub>B</sub>	L <sub>T</sub>	L <sub>B</sub>	L <sub>T</sub>	L <sub>B</sub>	L <sub>T</sub>	L <sub>B</sub>	L <sub>T</sub>	L <sub>B</sub>	L <sub>T</sub>
2	40	65	40	80	45	115	50	115	55	130	55	150	60	165	65	165
3	50	65	55	80	55	115	60	115	65	130	70	150	75	165	80	165
4	60	65	65	80	70	115	75	115	80	130	85	150	90	165	95	165
5	70	70	75	80	80	115	85	115	90	130	100	150	105	165	110	165
6	80	80	85	85	90	115	95	115	105	130	115	150	120	165	130	165
7	90	90	95	95	100	115	110	115	120	130	125	150	135	165	145	165
8	100	100	105	105	115	115	120	120	130	130	140	150	150	165	160	165
9	110	110	120	120	125	125	135	135	145	145	155	155	165	165	175	175
10	120	120	130	130	135	135	145	145	160	160	170	170	180	180	190	190

Table 2 Pivot Point on Center Line — Curve in Direction Opposite to Normal Pavement Slope

$L_R = L_B * (1 + 0.04167x)$  Where:  $x$  = width of lane greater than 15 ft.

$W_L$  = width of ramp lane

### Superelevation Transitions for Ramp Curves

Figure 640-14a

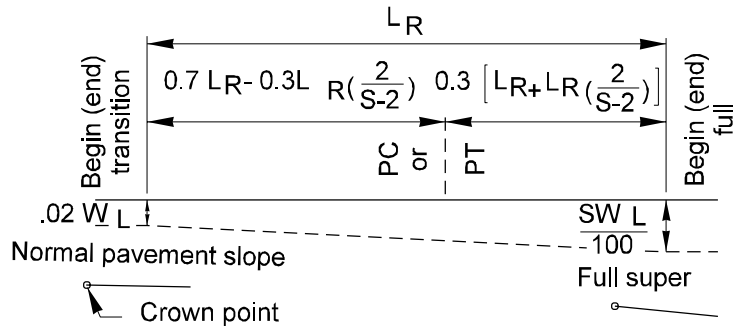

S (%)	Length of transition in feet for Design Speed of:															
	20 mph		25 mph		30 mph		35 mph		40 mph		45 mph		50 mph		≥ 55 mph	
	L <sub>B</sub>	L <sub>T</sub>	L <sub>B</sub>	L <sub>T</sub>	L <sub>B</sub>	L <sub>T</sub>	L <sub>B</sub>	L <sub>T</sub>	L <sub>B</sub>	L <sub>T</sub>	L <sub>B</sub>	L <sub>T</sub>	L <sub>B</sub>	L <sub>T</sub>	L <sub>B</sub>	L <sub>T</sub>
3	20	65	25	80	25	115	25	115	25	130	30	150	30	165	35	165
4	40	65	45	80	45	115	50	115	55	130	55	150	60	165	65	165
5	60	65	65	80	70	115	75	115	80	130	85	150	90	165	95	165
6	80	80	85	85	90	115	100	115	105	130	115	150	120	165	130	165
7	100	100	105	105	115	115	120	120	130	130	140	150	150	165	160	165
8	120	120	130	130	135	135	145	145	160	160	170	170	180	180	190	190
9	140	140	150	150	160	160	170	170	185	185	195	195	210	210	225	225
10	160	160	170	170	180	180	195	195	210	210	225	225	240	240	255	255

Table 3 Pivot Point on Edge of Lane — Curve in Direction of Normal Pavement Slope

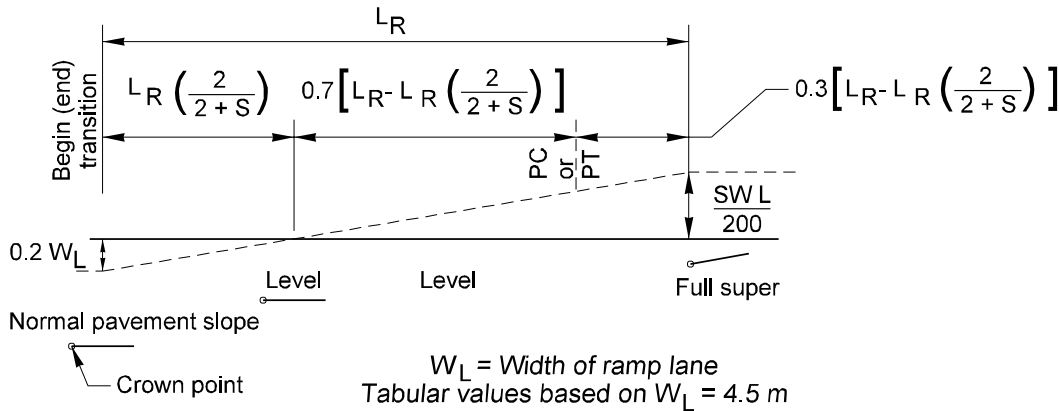

S (%)	Length of transition in feet for Design Speed of:															
	20 mph		25 mph		30 mph		35 mph		40 mph		45 mph		50 mph		≥ 55 mph	
	L <sub>B</sub>	L <sub>T</sub>	L <sub>B</sub>	L <sub>T</sub>	L <sub>B</sub>	L <sub>T</sub>	L <sub>B</sub>	L <sub>T</sub>	L <sub>B</sub>	L <sub>T</sub>	L <sub>B</sub>	L <sub>T</sub>	L <sub>B</sub>	L <sub>T</sub>	L <sub>B</sub>	L <sub>T</sub>
2	80	80	85	85	90	115	100	115	105	130	115	150	120	165	130	165
3	100	100	105	105	115	115	120	120	130	130	140	150	150	165	160	165
4	120	120	130	130	135	135	145	145	160	160	170	170	180	180	190	190
5	140	140	150	150	160	160	170	170	185	185	195	195	210	210	225	225
6	160	160	170	170	180	180	195	195	210	210	225	225	240	240	255	255
7	180	180	190	190	205	205	220	220	235	235	255	255	270	270	290	290
8	200	200	210	210	225	225	245	245	265	265	280	280	300	300	320	320
9	220	220	235	235	250	250	265	265	290	290	310	310	330	330	350	350
10	240	240	255	255	270	270	290	290	315	315	340	340	360	360	385	385

Table 4 Pivot Point on Edge of Lane — Curve in Direction Opposite to Normal Pavement Slope

$L_R = L_B * (1 + 0.04167x)$  Where:  $x$  = width of lane greater than 15 ft.

$W_L$  = width of ramp lane

### Superelevation Transitions for Ramp Curves

Figure 640-14b

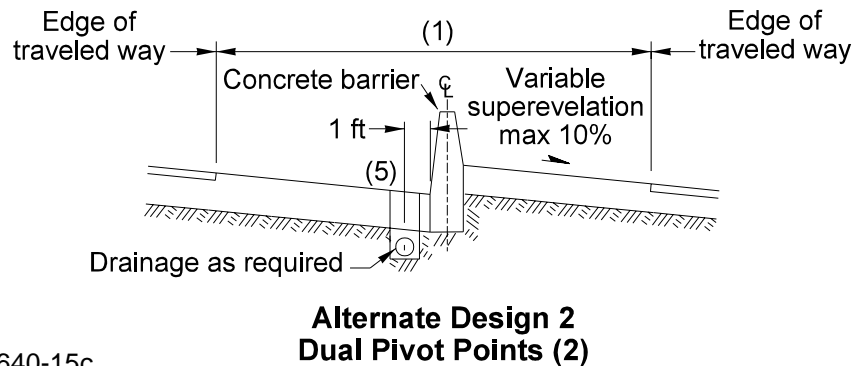
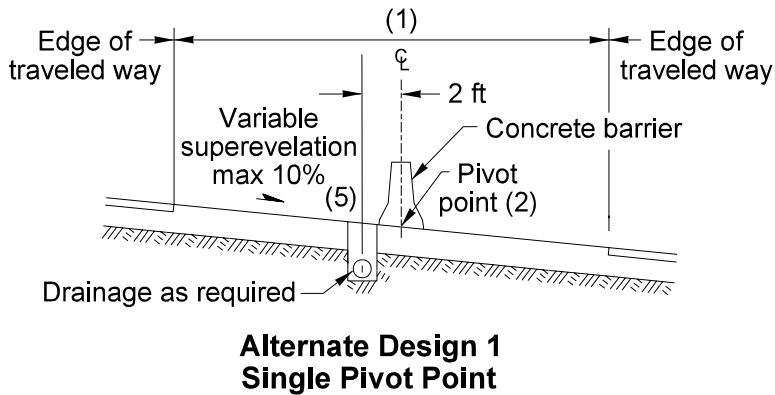
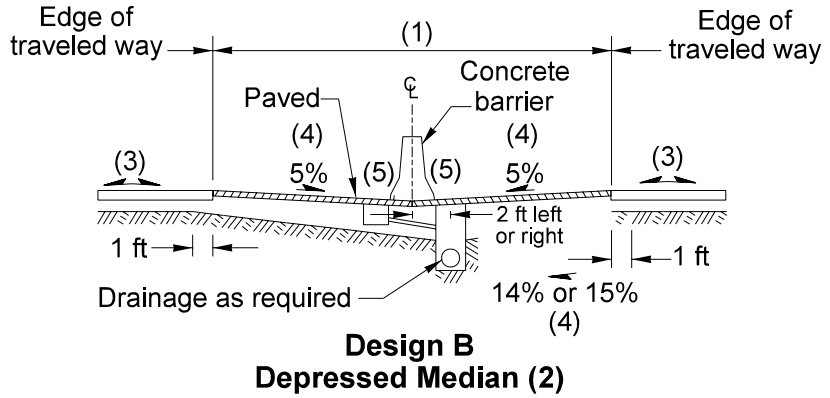
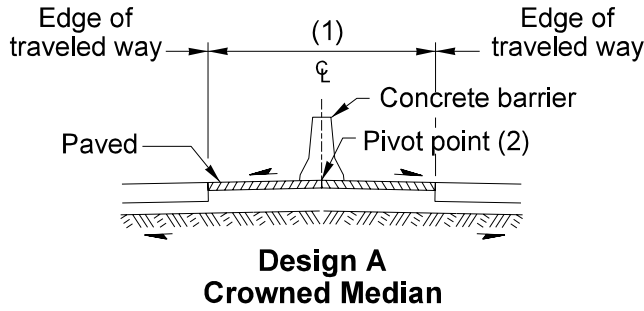

For notes, see Figure 640-15c

**Divided Highway Median Sections**  
*Figure 640-15a*

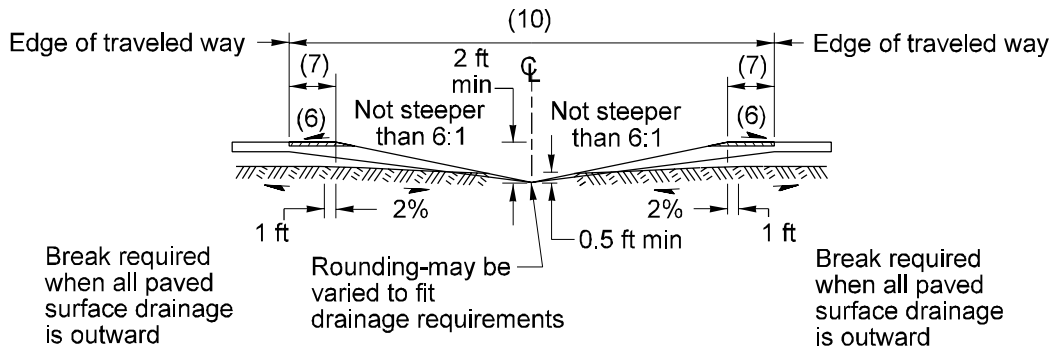

**Design C Minimum Nonpaved Median for 4 or More Lanes (2)**

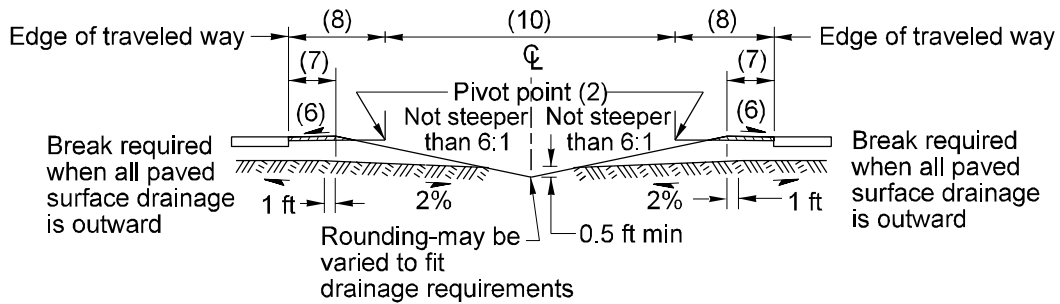

**Design D Minimum for 4 or More Lanes with Future Lanes in Median**

For notes, see Figure 640-15c

**Divided Highway Median Sections**  
*Figure 640-15b*



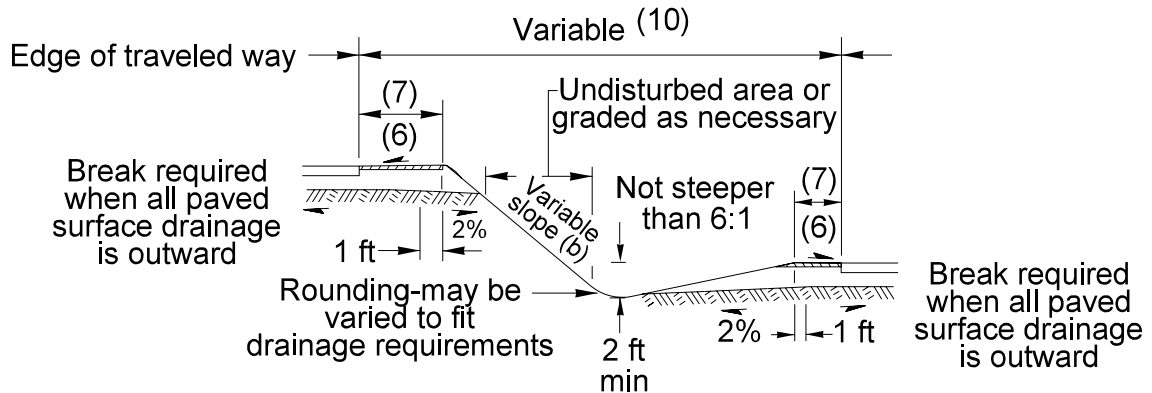

### Design E

Minimum for 4 or more lanes with independent alignment

- (1) Designs A and B including Alternate Designs 1 and 2 are urban median designs. see Chapter 440 for minimum urban median width.
- (2) Locate the pivot point to best suit the requirements of vertical clearances, drainage, and aesthetics.
- (3) Pavement slopes generally shall be in a direction away from the median. A crowned roadway section may be used in conjunction with the depressed median where conditions warrant. See Figure 640-3 for additional crown information.
- (4) Design B may be used uniformly on both tangents and horizontal curves. Use alternate designs 1 or 2 when the "roll over" between the shoulder and the inside lane on the high side of a superelevated curve exceeds 8%. Provide suitable transitions at each end of the curve for the various conditions encountered in applying the alternate to the basic median design.
- (5) Method of drainage pickup to be determined by the designer.
- (6) Median shoulders normally slope in the same direction and rate as the adjacent through lane. When median shoulders are over 6 ft wide or cement concrete pavement is used, median shoulders may slope toward the median. However, the "roll over" algebraic difference in rate of cross slope shall not exceed 8%. See figures 640-10a and 10b for additional shoulder details.
- (7) See Chapter 440 for minimum shoulder width.
- (8) Future lane, see Chapter 440 for minimum width.
- (9) Widen and round foreslopes steeper than 4H:1V as shown on Figure 640-10b.
- (10) Designs C, D, and E are rural median designs, see Chapter 440 for minimum rural median widths. Rural median designs may be used in urban areas when minimum rural median widths can be achieved.

## Divided Highway Median Sections

Figure 640-15c

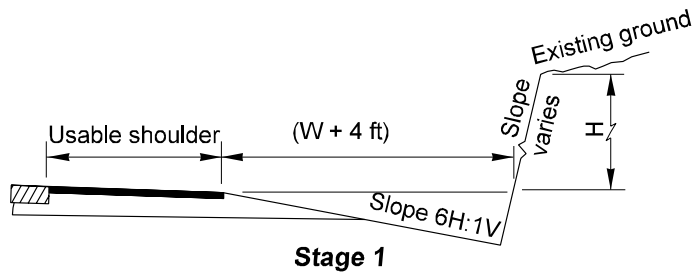

**Stage 1**

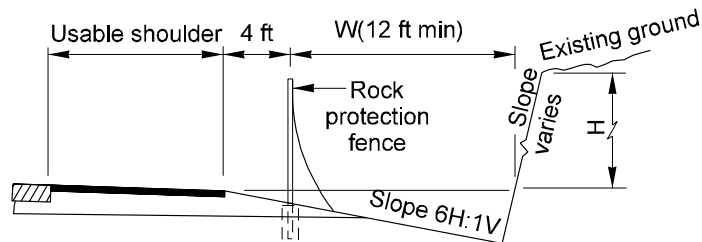

**Stage 2**

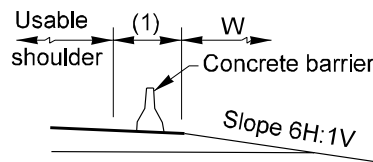

**Stage 2 Alternate**

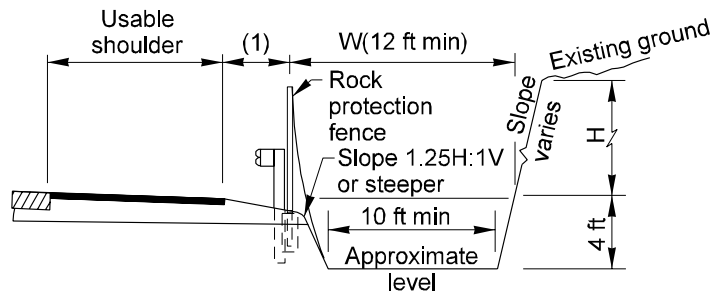

**Stage 3**

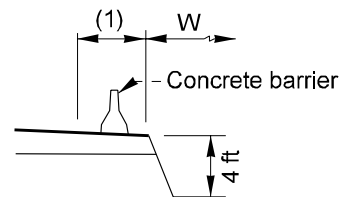

**Stage 3 Alternate**

Notes:

Rock Slope	H(ft)	W(ft)
Near Vertical	20-30	12
	30-60	15
	>60	20
0.25H:1V or 0.30H:1V	20-30	12
	30-60	15
	60-100 >100	20 25

Cut heights less than 20 ft shall be treated as a normal roadway unless otherwise determined by the Region Materials Engineer.

Stage 2 and 3 Alternates may be used when site conditions dictate.

Fence may be used in conjunction with the Stage 3 Alternate. See Chapter 700 for clear zone requirements.

(1) See Chapter 710 for required widening for guardrail and concrete barrier.

## Roadway Sections in Rock Cuts, Design A

Figure 640-16a

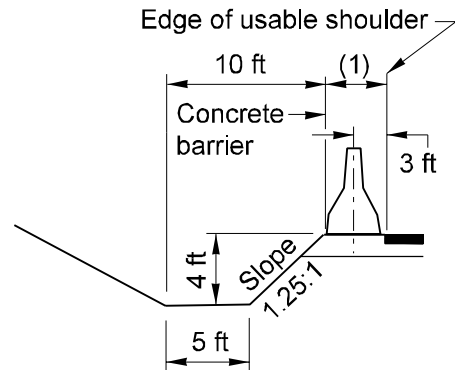
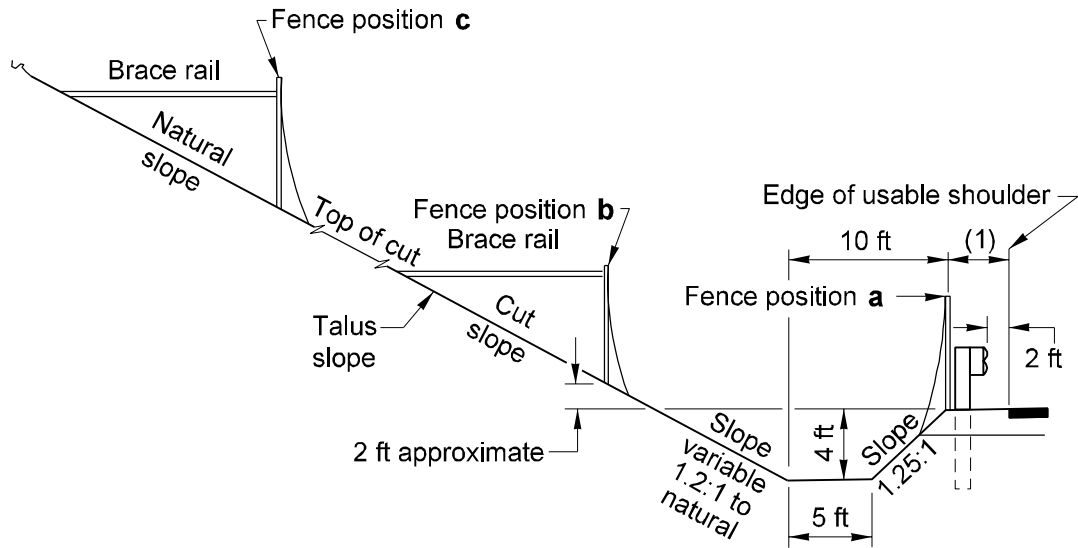

**Shoulder Barrier  
Alternate**

**Notes**

Ordinarily, place fence within a zone of 100 ft to 200 ft maximum from base of cliff measured along slope.

Rock protection fence may be used in conjunction with the Shoulder Barrier Alternate when site conditions dictate.

(1): See Chapter 710 for required widening for guardrail and concrete barrier.

**Roadway Sections in Rock Cuts, Design B**  
*Figure 640-16b*

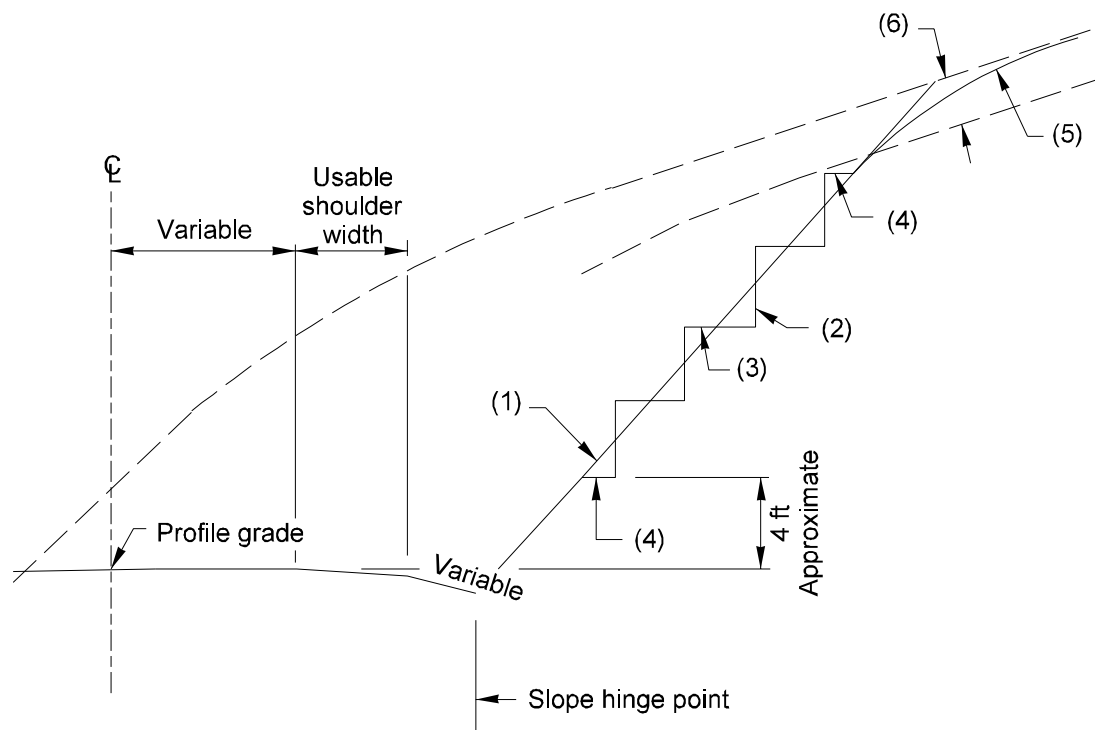

Notes:

- (1) Staked slope line - Maximum slope 1:1.
- (2) Step rise - height variable 1 ft to 2 ft
- (3) Step tread - width = staked slope ratio x step rise.
- (4) Step termini - width = 1/2 step tread width.
- (5) Slope rounding.
- (6) Overburden area - variable slope ratio.

**Roadway Sections With Stepped Slopes**  
*Figure 640-17*

Bridge End Condition	Toe of Slope End Slope Rate	Lower Roadway Treatment (1)	Slope Rate
End Piers on Fill	Height                  Rate ≤ 35 ft                  1 <sup>3</sup> / <sub>4</sub> H:1V > 35 ft                  2H:1V (2)	Posted speed                  Treatment of lower roadway. > 50 mph                  Rounding ≤ 50 mph                  No rounding	
End Piers in Cut	Match lower roadway slope.(3)	No rounding, toe at center line of the lower roadway ditch.	(4)
Lower Roadway in Cut	Match lower roadway slope.(3)	No rounding, toe at center line of the lower roadway ditch.	(4)
Ends in Partial Cut and Fill	When the cut depth is > 8 ft and length is > 100 ft, match cut slope of the lower roadway.	When the cut depth is > 8 ft and length is > 100 ft, no rounding, toe at center line of the lower roadway ditch.	(4)
	When the cut depth is ≤ 5 ft or the length is ≤ 100 ft, it is designers choice.	When the cut depth is ≤ 5 ft or the length is ≤ 100 ft, it is designers choice.	(4)

Notes:

- (1) See Figure 640-18b
- (2) Slope may be 1<sup>3</sup>/<sub>4</sub>H:1V in special cases.
- (3) In interchange areas, continuity may require variations. See 640.07.

**Bridge End Slopes**  
*Figure 640-18a*

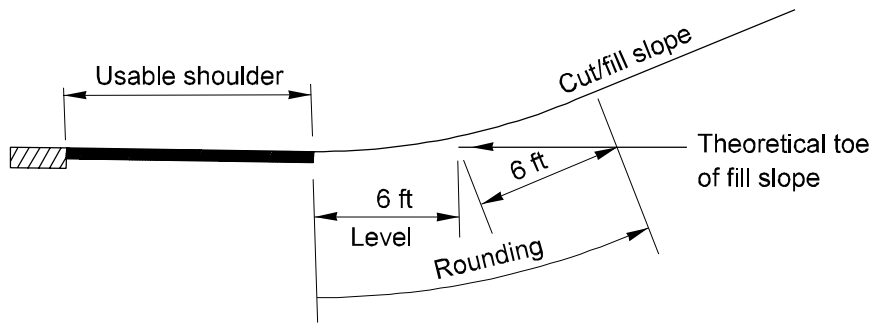

**Rounding**

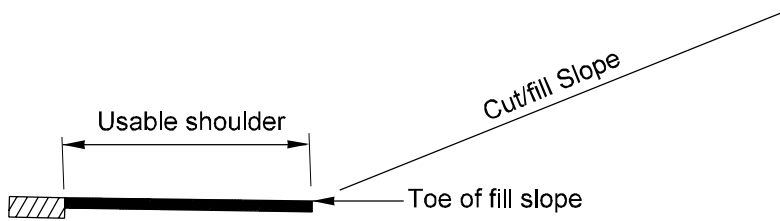

**No Rounding**

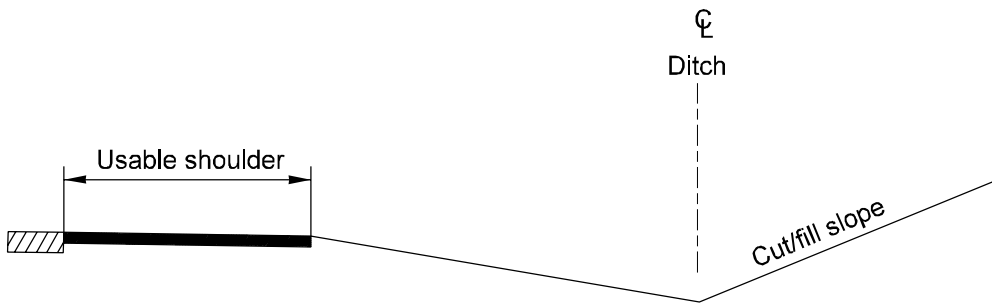

**Toe at  $\perp$  of Roadway Ditch**

**Bridge End Slopes**  
*Figure 640-18b*

650.01	General
650.02	References
650.03	Definitions
650.04	Passing Sight Distance
650.05	Stopping Sight Distance
650.06	Decision Sight Distance

### 650.01 General

It is essential that the driver of a vehicle be able to see far enough ahead to assess developing situations and take appropriate action. For purposes of design, sight distance is considered in terms of passing sight distance, stopping sight distance, and decision sight distance.

See the following chapters for additional information:

Chapter	Subject
910	Sight distance at intersections at grade
920	Sight distance at road approaches
930	Sight distance at railroad crossings
1020	Sight distance for paths and trails

### 650.02 References

*Manual on Uniform Traffic Control Devices for Streets and Highways* (MUTCD), USDOT, FHWA; including the *Washington State Modifications to the MUTCD*, M 24-01, WSDOT

*A Policy on Geometric Design of Highways and Streets*, 1994, AASHTO

### 650.03 Definitions

**decision sight distance** The sight distance required for a driver to detect an unexpected or difficult-to-perceive information source or hazard, interpret the information, recognize the hazard, select an appropriate maneuver, and complete it safely and efficiently

**passing sight distance** The sight distance (on a two-lane highway) required for a vehicle to execute a normal passing maneuver as related to design conditions and design speed

**sight distance** The length of highway visible to the driver

**stopping sight distance** The sight distance required to safely stop a vehicle traveling at design speed

### 650.04 Passing Sight Distance

#### (1) Design Criteria

Passing sight distance is the sum of four distances:

- The distance traveled by the passing vehicle during perception and reaction time and initial acceleration to the point of encroachment on the opposing lane.
- The distance the passing vehicle is in the opposing lane.
- The distance that an opposing vehicle travels during two-thirds of the time the passing vehicle is in the opposing lane.
- A clearance distance between the passing vehicle and the opposing vehicle at the end of the passing maneuver.

Passing sight distance is calculated for a passenger car using an eye height of 3.50 ft and an object height of 4.25 ft. Figure 650-1 gives the passing sight distances for various design speeds.

Design Speed (mph)	Passing Sight Distance (ft)
25	935
30	1,085
35	1,280
40	1,475
50	1,770
60	2,065
70	2,460

Passing Sight Distance

Figure 650-1

On two-lane, two-way highways, provide passing opportunities to meet traffic volume demands. This can be accomplished by using numerous sections with safe passing sight distance or by adding passing lanes at critical locations (Chapter 1010).

In the design stage, passing sight distance can be provided by adjusting the alignment either vertically or horizontally to increase passing opportunities.

These considerations also apply to multilane highways where staged construction includes a two-lane, two-way operation as an initial stage. Whether auxiliary lanes are provided, however, depends on the time lag proposed between the initial stage and the final stage of construction.

## (2) Vertical Curves

Figure 650-6 gives the length of crest vertical curve needed to provide passing sight distance for two-lane highways.

Sag vertical curves are not a restriction to passing sight distance.

## (3) Horizontal Curves

Passing sight distance can be restricted on the inside of a horizontal curve by roadside objects that are 3.60 ft or more above the roadway surface. When the length of curve is greater than the passing sight distance and the sight restriction is more than half the passing sight distance into the curve, use the following formula to determine if the object is close enough to the roadway to be a restriction to passing sight distance:

$$M = R \left[ 1 - \cos \left( \frac{28.65 S}{R} \right) \right]$$

Where:

M = The distance from the center line of the roadway to the obstruction

R = Radius of the curve

S = The passing sight distance from Figure 650-1

When the length of curve is less than the passing sight distance or the sight restriction is less than half the passing sight distance into the curve, the desired sight distance may be available with a lesser M distance. When this occurs, the sight distance can be checked graphically.

## (4) No-Passing Zone Markings

A knowledge of practices for marking no-passing zones on two-lane roads is helpful in designing a safe highway. The values in Figure 650-1 are the passing sight distances starting at the point the pass begins. The values in the MUTCD are lower than the Figure 650-1 values. They are for no-passing zone marking limits and start at the point the safe pass must be completed.

The MUTCD values are not to be used directly in design but are discussed for the designer's recognition of locations requiring no-passing pavement markings. Sections of highway providing passing sight distance in the range of values between the distances in Figure 650-1 and MUTCD values require careful review by the designer.

## 650.05 Stopping Sight Distance

### (1) Design Criteria

Stopping sight distance is the sum of two distances; the distance traveled during perception and reaction time and the distance required to stop the vehicle.

Stopping sight distance is calculated for a passenger car using an eye height of 3.50 ft and an object height of 0.50 ft. For various design speeds, Figure 650-2 gives the design stopping sight distances, the minimum curve length for a one percent grade change to provide the sight distance for a crest ( $K_C$ ) and sag ( $K_S$ ) vertical curve, and the minimum length of vertical curve for the design speed ( $VCL_m$ ). Figure 650-3 gives the values for existing stopping sight distance and the associated  $K_C$  and  $K_S$ .

Provide for design stopping sight distance (Figure 650-2) at all points on all highways and on all intersecting roadways.



Design Speed (mph)	Design Stopping Sight Distance (ft)	K <sub>C</sub>	K <sub>S</sub>	VCL <sub>m</sub> (ft)
25	165	20	28	75
30	200	30	36	90
35	260	51	52	105
40	330	82	70	120
50	460	159	105	150
60	655	323	159	180
70	855	550	215	210
80	1,050	830	271	240

**Design Stopping Sight Distance**  
*Figure 650-2*

Existing stopping sight distance (Figure 650-3) is used when the vertical and horizontal alignments are unchanged and the sight obstruction is existing.

Design Speed (mph)	Existing Stopping Sight Distance (ft)	K <sub>C</sub>	K <sub>S</sub>
25	165	20	28
30	200	30	36
35	230	40	44
40	295	65	61
50	395	117	88
60	525	207	123
70	625	294	151
80	755	429	187

**Existing Stopping Sight Distance**  
*Figure 650-3*

## (2) Effects of Grade

The grade of the highway has an effect on the stopping sight distance. The vehicle stopping distance is increased on downgrades and decreased on upgrades. Figure 650-4 gives the stopping sight distances for grades steeper than three percent. When evaluating sight distance with a changing grade, use the grade for which the longest sight distance is needed.

Design Speed (mph)	Stopping Sight Distance (ft)					
	Down Grades			Up Grades		
	3-5%	6-8%	≥9%	3-5%	6-8%	≥9%
25	165	165	165	150	150	150
30	195	215	230	180	180	165
35	260	280	295	215	215	215
40	330	360	375	260	260	245
50	490	540	590	360	345	330
60	690	740	785	460	445	425
70	920	1,000	—	575	540	—
80	1,130	—	—	690	—	—

**Design Stopping Sight Distance on Grades**  
*Figure 650-4*

## (3) Crest Vertical Curves

Use Figure 650-7 to find the minimum crest vertical curve length to provide stopping sight distance when given the algebraic difference in grades. The length can also be determined by multiplying the algebraic difference in grades by the K<sub>C</sub> value from Figure 650-2 for design or 650-3 for existing ( $L=K_C \cdot A$ ). Both the figure and the equation give approximately the same length of curve. Neither the figure nor the equation uses the sight distance greater than the length of curve equation. When the sight distance is greater than the length of curve and the length of curve is critical, the  $S>L$  equation given on Figure 650-7 may be used to find the minimum curve length.

When a new crest vertical curve is built or an existing one is rebuilt, provide Design Stopping Sight Distance from Figure 650-2. An existing crest vertical curve with Existing Stopping Sight Distance from Figure 650-3 may remain in place.

#### **(4) Sag Vertical Curves**

Use Figure 650-8 to find the minimum length for a sag vertical curve when given the stopping sight distance and the algebraic difference in grades. The minimum length for a sag vertical curve can also be determined by multiplying the algebraic difference in grades by the  $K_S$  value from Figure 650-2 for design or 650-3 for existing ( $L=K_S*A$ ). Both the figure and the equation give approximately the same length of curve. Neither the figure nor the equation uses the sight distance greater than the length of curve equation. When the sight distance is greater than the length of curve and the length of curve is critical, the  $S>L$  equation given on Figure 650-8 may be used to find the minimum length of curve.

When a new sag vertical curve is built or an existing one is rebuilt, provide Design Stopping Sight Distance from Figure 650-2. An existing sag vertical curve with Existing Stopping Sight Distance from Figure 650-3 may remain in place.

#### **(5) Horizontal Curves**

Use Figure 650-9 to check for adequate stopping sight distance where sight obstructions are on the inside of a curve. A stopping sight distance obstruction is any object 2 ft or greater above the roadway surface (such as median barrier, guardrail, bridges, walls, cut slopes, wooded areas, and buildings). Figure 650-9 (both the equation and the graph) are for use when the length of curve is greater than the sight distance and the sight restriction is more than half the sight distance from the end of the curve. When the length of curve is less than the stopping sight distance or the sight restriction is less than half the stopping sight distance into the curve, the desired sight distance may be available with a lesser  $M$  distance. When this occurs, the sight distance can be checked graphically.

Provide Design Stopping Sight Distance from Figure 650-2 for horizontal curves as follows:

- For all new roadways
- When the roadway is widened
- When there is an alignment shift
- For new features (such as median barrier, bridges, walls, or guardrail)
- When additional right of way is required for roadside improvements

When design stopping sight distance is not required, existing features that have Existing Stopping Sight Distance from Figure 650-3, may remain in place.

### **650.06 Decision Sight Distance**

Decision sight distance values are greater than stopping sight distance values because they give the driver an additional margin for error and afford sufficient length to maneuver at the same or reduced speed rather than to just stop.

Provide decision sight distance where highway features create a likelihood for error in information reception, decision making, or control actions. Example highway features include interchanges and intersections; changes in cross section at toll plazas, drop lanes, etc.; and areas of concentrated demand where sources of information compete, as those from roadway elements, traffic, traffic control devices, and advertising signs. If possible, locate these highway features where decision sight distance can be provided. If this is not possible, use suitable traffic control devices and positive guidance to give advanced warning of the conditions.

Use the decision sight distances in Figure 650-5 where highway features require complex driving decisions.

Design speed (mph)	Decision Sight Distance for Maneuvers (ft)				
	A	B	C	D	E
30	230	510	460	510	625
40	345	725	605	725	825
50	510	985	755	900	1,030
60	690	1,310	1,000	1,150	1,280
70	900	1,525	1,100	1,310	1,460
80	1,100	1,790	1,360	1,425	1,640

**Decision Sight Distance**

*Figure 650-5*

The maneuvers in Figure 650-5 are as follows:

- A. Rural stop
- B. Urban stop
- C. Rural speed/path/direction change
- D. Suburban speed/path/direction change
- E. Urban speed/path/direction change

Decision sight distance is calculated using the same criteria as stopping sight distance; 3.50 ft eye height and 0.50 ft object height. Use the equations on Figures 650-7, 8, and 9 to determine the decision sight distance at vertical and horizontal curves.

P65:DP/DME

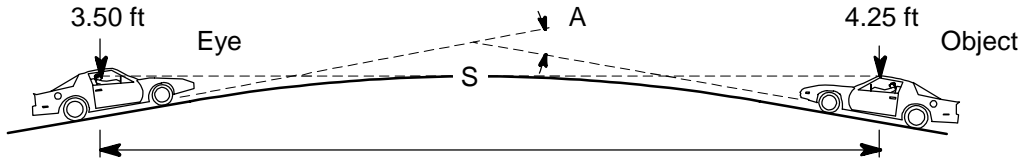

Formulas:

When S is less than L

$$L = AS^2/3093$$

When S is greater than L

$$L = 2S - 3093/A$$

---

S = Sight distance in feet

L = Length of vertical curve in feet

A = Algebraic difference of grades in percent

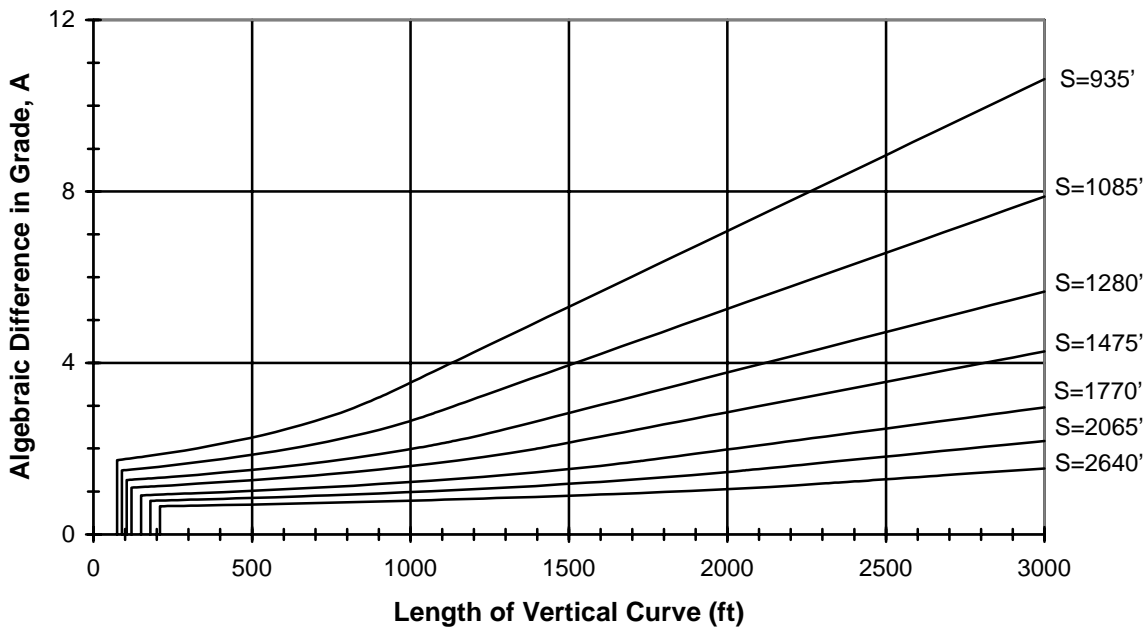

**Passing Sight Distance for Crest Vertical Curves**  
*Figure 650-6*

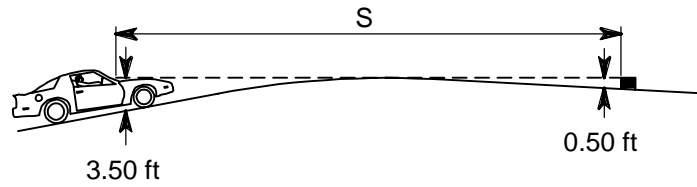

When $S > L$	When $S < L$
$L = 2S - 1329/A$ (not used in figure)	$L = AS^2/1329$
$L$ = Curve length (ft) $A$ = Algebraic grade difference (percent) $S$ = Sight distance (ft)	

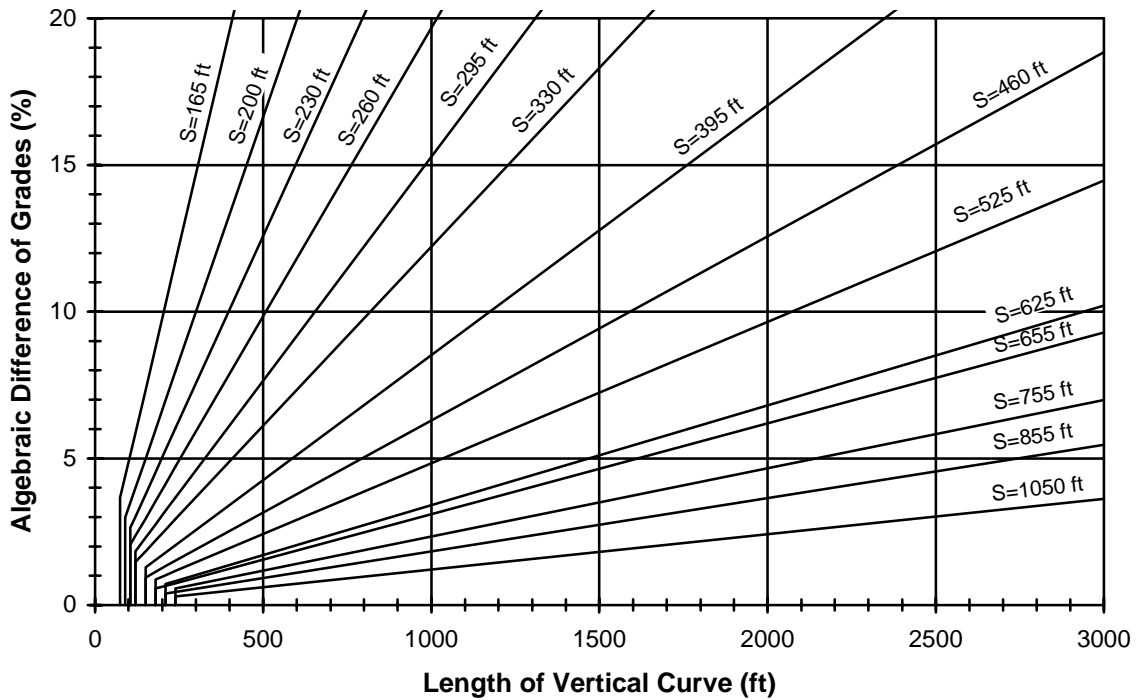

**Stopping Sight Distance for Crest Vertical Curves**  
*Figure 650-7*

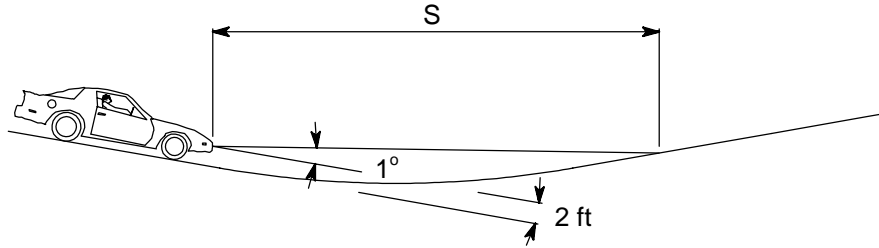

When $S > L$	When $S < L$
$L = 2S - \frac{400 + 3.5S}{A}$ (not used in figure)	$L = \frac{AS^2}{400 + 3.5S}$
L = Curve length (feet) A = Algebraic grade difference (percent) S = Sight distance (feet)	

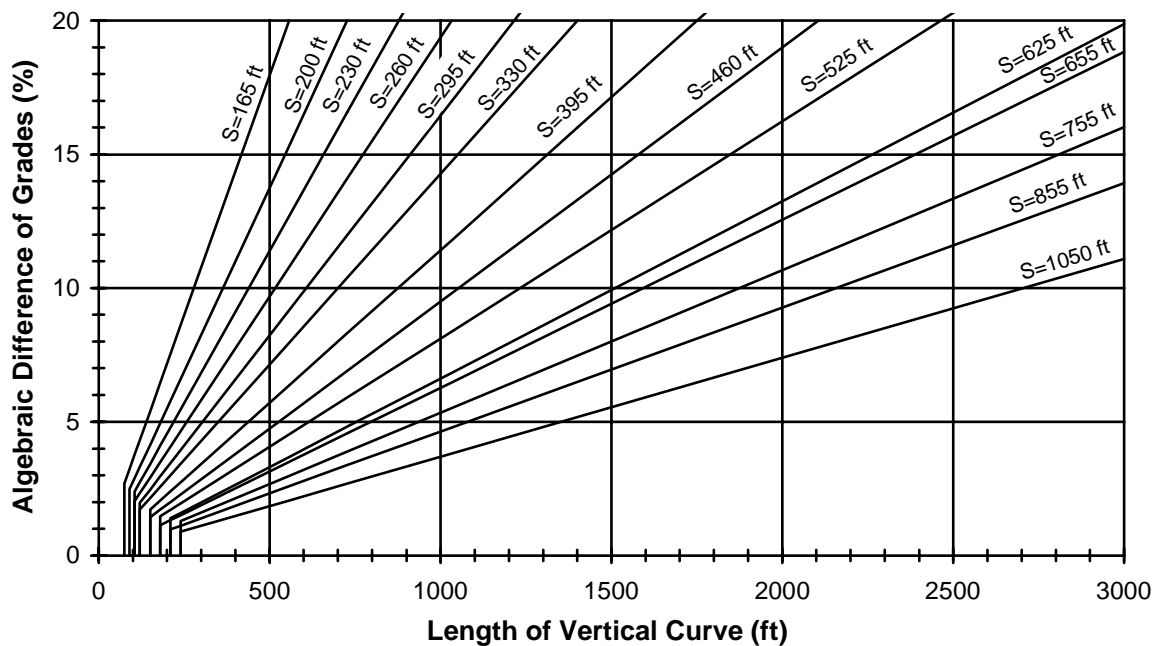

**Stopping Sight Distance for Sag Vertical Curves**  
*Figure 650-8*

Height of eye: 3.50 ft  
 Height of object: 0.50 ft  
 Line of sight is normally 200 ft above  
 center line of inside lane at point of  
 construction provided no vertical curve  
 is present in horizontal curve.

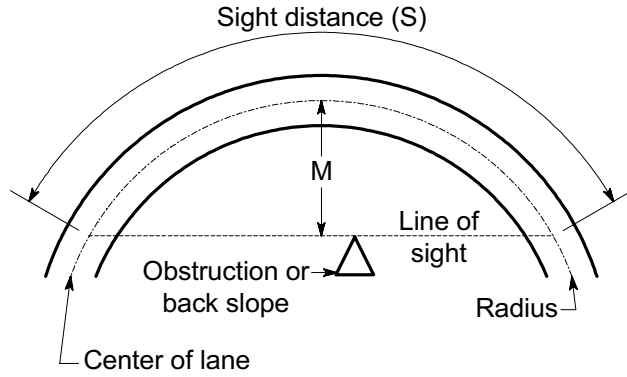

$$M = R \left( 1 - \cos \frac{28.65 S}{R} \right)$$

$$S = \frac{R}{28.65} \left[ \cos^{-1} \left( \frac{R - M}{R} \right) \right]$$

$S \leq$  Length of curve  
 Angle is expressed in degrees

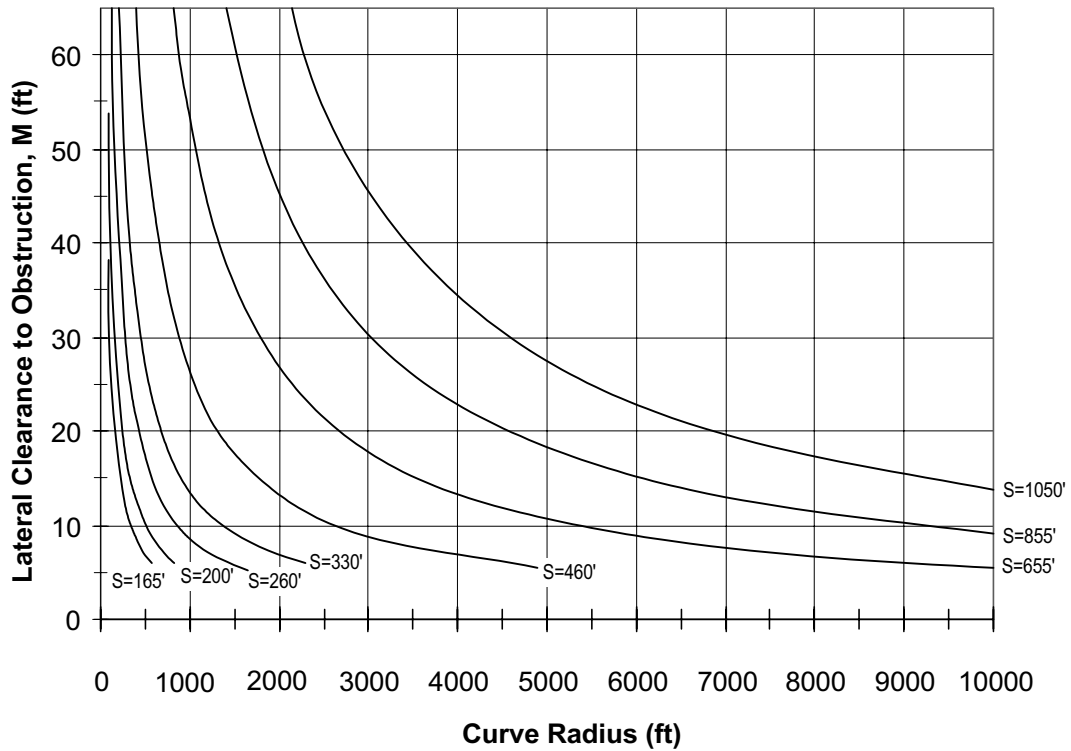

**Horizontal Stopping Sight Distance**  
 Figure 650-9

700.01	General
700.02	References
700.03	Definitions
700.04	Clear Zone
700.05	Hazards to be Considered for Mitigation
700.06	Median Considerations
700.07	Other Roadside Safety Features
700.08	Documentation

### 700.01 General

Roadside safety addresses the area outside of the roadway and is an important component of total highway design. The roadside environment is significant to safety as illustrated by the fact that nearly one third of the fatal accidents are single vehicle run-off-the-road accidents. There are numerous reasons why a vehicle leaves the roadway. Regardless of the reason, a forgiving roadside can reduce the seriousness of the consequences of a roadside encroachment. The ideal highway has roadsides and median areas that are flat and unobstructed by hazards.

Elements such as side slopes, fixed objects, and water are potential hazards that a vehicle might encounter when it leaves the roadway. These hazards present varying degrees of danger to the vehicle and its occupants. Unfortunately, geography and economics do not always allow ideal highway conditions. The mitigative measures to be taken depend on the probability of an accident occurring, the likely severity, and the available resources.

In order of preference, mitigative measures are: removal, relocation, reduction of the impact severity (using breakaway features or making it traversable), and shielding with a traffic barrier. Consider cost (initial and life cycle costs) and maintenance requirements in addition to accident severity when selecting a mitigative measure. Use traffic barriers or earth berms only when other measures cannot reasonably be accomplished. See Chapter 710 for additional information on traffic barriers.

### 700.02 References

*Standard Plans for Road, Bridge, and Municipal Construction* (Standard Plans), M 21-01, WSDOT

*Roadside Management Manual*, M 25-30, WSDOT

*Roadside Design Guide*, AASHTO

### 700.03 Definitions

**ADT** The average daily traffic for the design year under consideration.

**clear run-out area** The area at the toe of a nonrecoverable slope available for safe use by an errant vehicle.

**clear zone** The total roadside border area, starting at the edge of the traveled way, available for use by errant vehicles. This area may consist of a shoulder, a recoverable slope, a nonrecoverable slope, and/or a clear run-out area. The clear zone cannot contain a critical slope. **Design Clear Zone** is the minimum target value used in highway design.

**critical slope** A slope on which a vehicle is likely to overturn. Slopes steeper than 3H:1V are considered critical slopes.

**hazard** A side slope, a fixed object, or water that, when struck, would result in unacceptable impact forces on the vehicle occupants or place the occupants in a hazardous position. It can be either natural or manmade.

**nonrecoverable slope** A slope on which an errant vehicle will continue until it reaches the bottom, without having the ability to recover control. Fill slopes steeper than 4H:1V, but no steeper than 3H:1V, are considered nonrecoverable.

**recoverable slope** A slope on which a the driver of an errant vehicle can regain control of the vehicle. Slopes of 4H:1V or flatter are considered recoverable.



**recovery area** The minimum target value used in highway design when a fill slope between 4H:1V and 3H:1V starts within the Design Clear Zone

**traffic barrier** A longitudinal barrier, including bridge rail or an impact attenuator, used to redirect vehicles from hazards located within an established Design Clear Zone, to prevent median crossovers, to prevent errant vehicles from going over the side of a bridge structure, or (occasionally), to protect workers, pedestrians, or bicyclists from vehicular traffic.

**traveled way** The portion of the roadway intended for the movement of vehicles, exclusive of shoulders and lanes for parking, turning, and storage for turning.

## 700.04 Clear Zone

The clear zone is a primary consideration when analyzing hazards. The intent is to provide as much clear, traversable recovery area as practical. The Design Clear Zone values shown in Figure 700-1 are used to judge the adequacy of the existing clear zone and to provide a minimum target value for highway design. These values are not to be used as justification to compromise or take away from the existing clear zone.

A Design Clear Zone inventory is required for all projects indicating evaluate upgrade (EU) or Full Design Level (F) for the clear zone columns on the design matrices. (See Chapter 325.) Use the Design Clear Zone Inventory form (Figure 700-2) to inventory the roadside for potential hazards. Identify the hazards and propose corrective actions. Eliminating the hazard is the preferred action. Analyze a roadside hazard to determine if further mitigation is necessary even when it is beyond the values in Figure 700-1. When locating a highway appurtenance (such as a sign bridge, bridge pier, or sign post) in an otherwise recoverable area, use the values in Figure 700-1 as guidance in determining the need for mitigation.

The Design Clear Zone is a function of the posted speed, side slope, and traffic volume. There are no distances in the table for 3H:1V fill slopes. Although fill slopes between 4H:1V and 3H:1V are considered traversable if free of fixed objects,

these slopes are defined as nonrecoverable slopes. A vehicle may be able to begin recovery on the shoulder, but will be unable to further this recovery until reaching a flatter area (4H:1V or flatter) at the toe of the slope. Under these conditions, the Design Clear Zone distance is called a recovery area. The method used to calculate the recovery area and an example are shown in Figure 700-3.

For ditch sections, the following criteria determine the Design Clear Zone:

- (a) For ditch sections with foreslopes 4H:1V or flatter (see Figure 700-4, Case 1, for an example) the Design Clear Zone distance is the greater of:
1. The Design Clear Zone distance for a 10H:1V cut section based on speed and ADT, or
  2. A horizontal distance of 5 ft beyond the beginning of the back slope.

When a back slope steeper than 3H:1V continues for 5 ft beyond the beginning of the back slope (as is the case with a redirection land form), it is not necessary to use the 10H:1V cut slope criteria.

(b) For ditch sections with foreslopes steeper than 4H:1V, and back slopes steeper than 3H:1V the Design Clear Zone distance is 10 ft horizontal beyond the beginning of the back slope. (See Figure 700-4, Case 2, for an example.)

(c) For ditch sections with foreslopes steeper than 4H:1V and back slopes 3H:1V or flatter, the Design Clear Zone distance is the distance established using the recovery area formula (Figure 700-3). (See Figure 700-4, Case 3, for an example.)

## 700.05 Hazards to be Considered for Mitigation

There are three general categories of hazards: side slopes, fixed objects, and water. The following sections provide guidance for determining when these obstacles present a significant hazard to an errant motorist. In addition, several conditions require special consideration:

- Locations with high accident histories.
- Locations with pedestrian and bicycle usage. See Chapter 1020.02(c) (pedestrian) and 1020.03(6)(a)4 (bicycle).

- Playgrounds, monuments, and other locations with high social or economic value may require mitigation such as a barrier.

Use of a traffic barrier for obstacles other than those described below requires justification in the design file.

### **(1) Side Slopes**

(a) **Fill Slopes.** Fill slopes can present a hazard to an errant vehicle with the degree of severity dependant upon the slope and height of the fill. Providing fill slopes that are 4H:1V or flatter can mitigate this hazard. If flattening the slope is not feasible or cost effective, the installation of a barrier may be appropriate. Figure 700-5 represents a selection procedure used to determine whether a fill side slope constitutes a hazard for which a barrier is a cost-effective mitigation. The curves are based on the severity indexes and represent the points where total costs associated with a traffic barrier are equal to the predicted accident cost associated with selected slope heights without traffic barrier. If the ADT and height of fill intersect on the “Barrier Recommended” side of the embankment slope curve, then provide a barrier if flattening the slope is not feasible or cost effective. Do not use Figure 700-5 for slope design. Design guidance for slopes is in Chapters 430 and 640. Also, if the figure indicates that barrier is not recommended at an existing nonstandard slope, that result is not justification for a deviation.

For example, if the ADT is 4000 and the embankment height is 10 ft, barrier would be cost effective for a 2H:1V slope, but not for a 2.5H:1V slope.

This process only addresses the potential hazard of the slope. Obstacles on the slope may compound the hazard. Where barrier is not cost effective, use the recovery area formula to evaluate fixed objects on critical slopes less than 10 ft high.

(b) **Cut Slopes.** A cut slope is usually less of a hazard than a traffic barrier. The exception is a rock cut with a rough face that could cause vehicle snagging rather than providing relatively smooth redirection.

Analyze the potential motorist risk and the benefits of treatment of rough rock cuts located within the Design Clear Zone. A cost-effectiveness analysis that considers the consequences of doing nothing, removal or smoothing of the cut slope, and all other viable options to reduce the severity of the hazard can be used to determine the appropriate treatment. Some potential options are:

- Redirectional land form.
- Flexible barrier.
- More rigid barrier.
- Rumble strips.

Conduct an individual investigation for each rock cut or group of rock cuts. Select the most cost-effective treatment.

### **(2) Fixed Objects**

Consider the following objects for mitigation:

- Wooden poles or posts with cross sectional area greater than 16 square inches that do not have breakaway features.
- Nonbreakaway steel sign supports.
- Nonbreakaway luminaire supports.
- Trees having a diameter of 4 in or more measured at 6 in above the ground surface.
- Fixed objects extending above the ground surface by more than 4 in; for example, boulders, concrete bridge rails, piers, and retaining walls.
- Existing nonstandard guardrail (see Chapter 710).
- Drainage items, such as culvert and pipe ends.

Remove objects that are hazards when feasible. Focus on the area within the Design Clear Zone but do not exclude consideration of objects outside this area. The possible mitigative measures are listed below in order of preference.

- Remove.
- Relocate.

- Reduce impact severity (using a breakaway feature).
- Shield the object by using redirection landform, longitudinal barrier, or impact attenuator.

(a) **Trees.** When evaluating new plantings or existing trees, consider the maximum allowable diameter of 4 in measured at 6 in above the ground when the tree has matured. When removing trees within the Design Clear Zone, complete removal of stumps is preferred. However, to avoid significant disturbance of the roadside vegetation, larger stumps may be mitigated by grinding or cutting them flush to the ground and grading around them. See the *Roadside Management Manual* for further guidance on the treatment of the disturbed roadside.

(b) **Mailboxes.** Ensure that all mailboxes located within the Design Clear Zone have supports and connections as shown in the Standard Plans. The standard height of mailboxes from the ground to the bottom of the mailbox is 40 in. This height may vary from 40 to 48 in if requested by the mail carrier. Include a note in the contract plans that gives the height desired if it is to be different from the standard height. See Figure 700-6 for installation guidelines.

In urban areas where sidewalks are prevalent, contact the postal service to determine the most appropriate mailbox location. Locate mailboxes on access controlled highways in accordance with Chapter 1420. A turnout, as shown on Figure 700-6, is not required on access controlled facilities with shoulders of 6 ft or more where only one mailbox is to be installed. On highways without access control, mailboxes must be on the right-hand side of the road in the direction of travel of the postal carrier. Avoid placing mailboxes along high-speed, high-volume highways. Locate Neighborhood Delivery and Collection Box Units (NDCBU) outside the Design Clear Zone.

(c) **Culvert Ends.** Provide a traversable end treatment when the culvert end section or opening is on the roadway side slope and within the Design Clear Zone. This can be accomplished for

small culverts by beveling the end to match the side slope, with a maximum of 4 in extending out of the side slope.

Bars may be necessary to provide a traversable opening for larger culverts. Place bars in the plane of the culvert opening in accordance with the Standard Plans when:

1. Single cross culvert opening exceeds 40 in measured parallel to the direction of travel.
2. Multiple cross culvert openings that exceed 30 in each, measured parallel to the direction of travel.
3. Culvert approximately parallel to the roadway has an opening that exceeds 24 in measured perpendicular to the direction of travel.

Bars are permitted where they will not significantly affect the stream hydraulics and where debris drift is minor. Consult the regional Maintenance Office to verify these conditions. If debris drift is a concern, consider options to reduce the amount of debris that can enter the pipe (see the *Hydraulics Manual*). Other treatments are extending the culvert to move the end outside the Design Clear Zone or installing a traffic barrier.

(d) **Sign Posts.** Whenever possible, locate sign supports behind existing or planned traffic barrier installations to eliminate the need for breakaway supports. Place them at least 25 ft from the end of the barrier terminal and with the sign face behind the barrier. When barrier is not present use terrain features to reduce the likelihood of an errant vehicle striking the sign supports. Whenever possible, depending on the type of sign and the sign message, adjust the sign location to take advantage of barrier or terrain features. This will reduce accident potential and, possibly, future maintenance costs. See Chapter 820 for additional information regarding the placement of signs.

Sign posts with cross sectional areas greater than 16 square inches that are within the Design Clear Zone and not located behind a barrier must have breakaway features as shown in the Standard Plans.

### **(3) Water**

Water with a depth of 2 ft or more and located with a likelihood of encroachment by an errant vehicle must be considered for mitigation on a project-by-project basis. Consider the length of time traffic is exposed to this hazard and its location in relationship to other highway features such as curves.

Analyze the potential motorist risk and the benefits of treatment of bodies of water located within the Design Clear Zone. A cost-effectiveness analysis that considers the consequences of doing nothing versus installing a longitudinal barrier can be used to determine the appropriate treatment.

### **700.06 Median Considerations**

Medians must be analyzed for the potential of an errant vehicle to cross the median and encounter on-coming traffic. Median barriers are normally used on access controlled, multilane, high-speed, high traffic volume facilities. These facilities generally have posted speeds of 50 mph or greater. Median barrier is not normally placed on collector highways or other facilities that do not have controlled access. Providing access through median barrier requires openings and, therefore, end-treatments.

In the absence of cross median accident data, on access controlled, high-speed, multilane, high traffic volume facilities that have relatively flat, unobstructed medians, use Figure 700-7 to determine if median barrier is warranted.

As indicated in Figure 700-7, the need for median barrier is based on a combination of ADT and median widths. At low ADTs, the probability of a vehicle crossing the median is relatively low. Thus, for ADTs less than 20,000, use of median barrier is optional. Likewise, for relatively wide medians, the probability of a vehicle crossing the median is also relatively low. Thus, for median widths greater than 30 ft, use of median barrier is optional. Consider cable barrier in these wide medians. Median barrier is not recommended for medians wider than 50 ft unless there is a history of across-the-median accidents.

When median barrier is warranted for a median of less than 6 ft on an existing facility, median widening is required to provide median width of 8 ft. An approved deviation is required for the use of a median barrier in a median of less than 6 ft.

Consider a wider median when the barrier casts a shadow on the roadway and hinders the melting of ice. See Chapter 640 for additional criteria for placement of median barrier. See Chapter 710 for information on the types of barriers that can be used. See Chapter 620 for lateral clearance on the inside of a curve to provide the required stopping sight distance.

When median barrier is being placed in an existing median, identify the existing crossovers and enforcement observation points. Provide the necessary median crossovers in accordance with Chapter 910, considering enforcement needs.

### **700.07 Other Roadside Safety Features**

#### **(1) Rumble Strips**

Rumble strips are grooves or rows of raised pavement markers placed perpendicular to the direction of travel to alert inattentive drivers.

There are two kinds of rumble strips:

(a) **Roadway rumble strips** are placed across the traveled way to alert drivers approaching a change of roadway condition or a hazard that requires substantial speed reduction or other maneuvering. Examples of locations where roadway rumble strips may be used are in advance of:

- Stop controlled intersections.
- Port of entry/customs stations.
- Lane reductions where accident history shows a pattern of driver inattention.

They may also be placed at locations where the character of the roadway changes, such as at the end of a freeway.

Contact the Olympia Service Center Design Office for additional guidance on the design and placement of roadway rumble strips.

Document justification for using roadway rumble strips in the project file.

(b) **Shoulder rumble strips** are placed on the shoulders just beyond the traveled way to warn drivers when they are entering a part of the roadway not intended for routine traffic use. A comparison of rolled-in rumble strips and milled-in Continuous Shoulder Rumble Strips (CSRS) has determined that CSRS, although more expensive, are more cost effective. CSRS are the standard design.

Rumble strips may be used when an analysis indicates a problem with run-off-the-road accidents due to inattentive or fatigued drivers. Consider them on both shoulders of rural divided highways. CSRS are required on both the right and left shoulders of rural Interstate highways.

Lack of required CSRS is a design exception (DE) under any one of the following conditions:

- When another project scheduled within two years of the proposed project will overlay or reconstruct the shoulders or will use the shoulders for detours.
- When a pavement analysis determines that installing CSRS will result in inadequate shoulder strength.
- When shoulders will be less than 4 ft wide on the left and 6 ft wide on the right.

When CSRS are used, discontinue them where no edge strip is present such as at intersections and where curb and gutter are present.

## **(2) Headlight Glare**

Headlight glare from opposing traffic can cause safety problems. Glare can be reduced by the use of wide medians, separate alignments, earth mounds, plants, standard and tall barriers, and by devices known as glare screens specifically designed to reduce glare. Consider long term maintenance when selecting the treatment for glare. When considering earth mound and planting to reduce glare, see the *Roadside Management Manual* for additional guidance. When considering glare screens, see Chapter 620 for lateral clearance on the inside of a curve to provide the required stopping sight distance. In

addition to reducing glare, taller concrete barriers also provide improved crash performance for larger vehicles such as trucks.

Glare screen is relatively expensive and its use must be justified and documented. It is difficult to justify the use of glare screen where the median width exceeds 20 ft, the ADT is less than 20,000 vehicles per day, or the roadway has continuous lighting. Consider the following factors when assessing the need for glare screen:

- Higher rate of night accidents compared to similar locations or statewide experience.
- Higher than normal ratio of night to day accidents.
- Unusual distribution or concentration of nighttime accidents.
- Over representation of older drivers in night accidents.
- Combination of horizontal and vertical alignment, particularly where the roadway on the inside of a curve is higher than the roadway on the outside of the curve.
- Direct observation of glare.
- Public complaints concerning glare.

The most common glare problem is between opposing main line traffic. Other conditions for which glare screen might be appropriate are:

- Between a highway and an adjacent frontage road or parallel highway, especially where opposing headlights might seem to be on the wrong side of the driver.
- At an interchange where an on-ramp merges with a collector distributor and the ramp traffic might be unable to distinguish between collector and main line traffic. In this instance, consider other solutions, such as illumination.
- Where headlight glare is a distraction to adjacent property owners. Playgrounds, ball fields, and parks with frequent nighttime activities might benefit from screening if headlight glare interferes with these activities.

There are currently three basic types of glare screen available: chain link (see Standard Plans), vertical blades, and concrete barrier (see Figure 700-8).

When the glare is temporary (due to construction activity), consider traffic volumes, alignment, duration, presence of illumination, and type of construction activity. Glare screen may be used to reduce rubbernecking associated with construction activity, but less expensive methods, such as plywood that seals off the view of the construction area, might be more appropriate.

### **700.08 Documentation**

The following documents are to be preserved in the project file. See Chapter 330.

- Design Clear Zone inventory and evaluation documents
- Justification for barrier use not meeting criteria in 700.05
- Hydraulic evaluation for culvert bars
- Median accident evaluation and barrier warrant determination
- Median width deviation for barrier placement
- Roadway rumble strip justification
- Conditions for CSRS DE
- Glare screen justification

*P65:DDDM/DME*

Clear Zone Distances (In feet from edge of traveled way)													
Posted Speed mph	Average Daily Traffic	Cut Section (H:V)						Fill Section (H:V)					
		3:1	4:1	5:1	6:1	8:1	10:1	3:1	4:1	5:1	6:1	8:1	10:1
35 or Less	The Clear Zone distance is established at 10 feet or 2 feet beyond the face of curb in urban areas.												
40	Under 250	10	10	10	10	10	10	*	13	12	11	11	10
	251-800	11	11	11	11	11	11	*	14	14	13	12	11
	801-2000	12	12	12	12	12	12	*	16	15	14	13	12
	2001-6000	14	14	14	14	14	14	*	17	17	16	15	14
	Over 6000	15	15	15	15	15	15	*	19	18	17	16	15
45	Under 250	11	11	11	11	11	11	*	16	14	13	12	11
	251-800	12	12	13	13	13	13	*	18	16	14	14	13
	801-2000	13	13	14	14	14	14	*	20	17	16	15	14
	2001-6000	15	15	16	16	16	16	*	22	19	17	17	16
	Over 6000	16	16	17	17	17	17	*	24	21	19	18	17
50	Under 250	11	12	13	13	13	13	*	19	16	15	13	13
	251-800	13	14	14	15	15	15	*	22	18	17	15	15
	801-2000	14	15	16	17	17	17	*	24	20	18	17	17
	2001-6000	16	17	17	18	18	18	*	27	22	20	18	18
	Over 6000	17	18	19	20	20	20	*	29	24	22	20	20
55	Under 250	12	14	15	16	16	17	*	25	21	19	17	17
	251-800	14	16	17	18	18	19	*	28	23	21	20	19
	801-2000	15	17	19	20	20	21	*	31	26	23	22	21
	2001-6000	17	19	21	22	22	23	*	34	29	26	24	23
	Over 6000	18	21	23	24	24	25	*	37	31	28	26	25
60	Under 250	13	16	17	18	19	19	*	30	25	23	21	20
	251-800	15	18	20	20	21	22	*	34	28	26	23	23
	801-2000	17	20	22	22	23	24	*	37	31	28	26	25
	2001-6000	18	22	24	25	26	27	*	41	34	31	29	28
	Over 6000	20	24	26	27	28	29	*	45	37	34	31	30
65	Under 250	15	18	19	20	21	21	*	33	27	25	23	22
	251-800	17	20	22	22	24	24	*	38	31	29	26	25
	801-2000	19	22	24	25	26	27	*	41	34	31	29	28
	2001-6000	20	25	27	27	29	30	*	46	37	35	32	31
	Over 6000	22	27	29	30	31	32	*	50	41	38	34	33
70	Under 250	16	19	21	21	23	23	*	36	29	27	25	24
	251-800	18	22	23	24	26	26	*	41	33	31	28	27
	801-2000	20	24	26	27	28	29	*	45	37	34	31	30
	2001-6000	22	27	29	29	31	32	*	50	40	38	34	33
	Over 6000	24	29	31	32	34	35	*	54	44	41	37	36

\* When the fill section slope is steeper than 4H:1V but not steeper than 3H:1V, the clear zone distance modified by the recovery area formula (shown on Figure 710-3) and is referred to as the recovery area. The basic philosophy behind the recovery area formula is that a vehicle can traverse these slopes but cannot recover (control steering) and therefore, the horizontal distance of these slopes is added to the clear zone distance to form the recovery area.

**Design Clear Zone Distance Table**  
*Figure 700-1*

Design Clear Zone Inventory Form  
Figure 700-2, Sheet 1 of 2



Washington State  
Department of Transportation

## Design Clear Zone Inventory

Region		SR	Control Section		MP	to MP		Date	
Project Number		Project Title				Responsible Unit			
Item Number	MP to MP	Distance From Traveled Way		Description	Corrective Actions Considered (2)	Estimated Cost to Correct	Correction Planned (1)		
		L	R				Yes	No	

DOT Form 410-026 EF  
Revised 6/97

(1) Only one "Yes" or "No" per item number. Corrections not planned must be explained on reverse side.  
 (2) A list of Location 1 & 2 Utility Objects to be forwarded to the region Utility Office for coordination per Control Zone Guidelines.





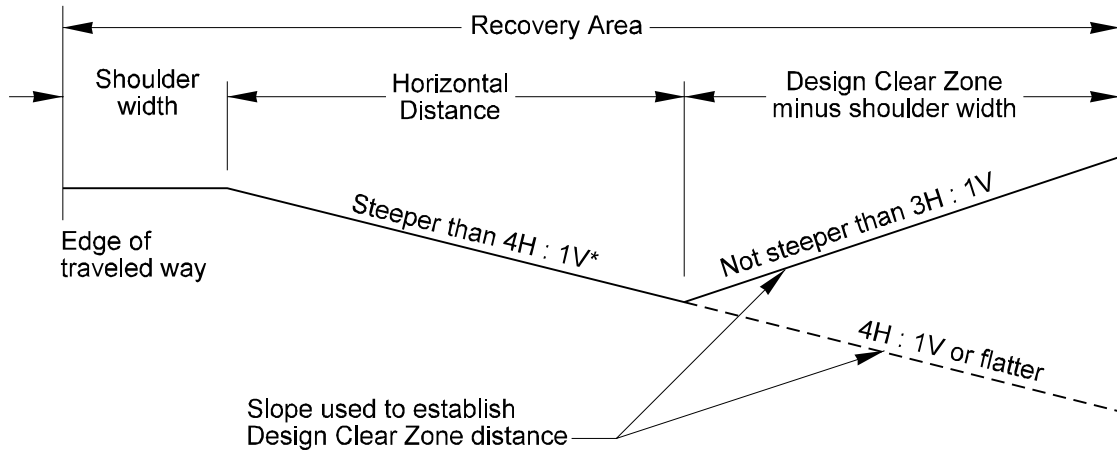

\*Recovery Area normally applies to slopes steeper than 4H:1V but no steeper than 3H:1V. For steeper slopes, the recovery area formula may be used as a guide if the embankment height is 10 ft or less.

**Formula:**

$$\text{Recovery Area} = (\text{shoulder width}) + (\text{horizontal distance}) + (\text{Design Clear Zone distance} - \text{shoulder width})$$

**Example:**

Fill Section (slope 3H:1V or steeper)

Conditions: Speed - 45 mph  
 Traffic - 3000 ADT  
 Slope - 3H:1V

Criteria: Slope 3H:1V - use  
 Recovery Area Formula

$$\begin{aligned} \text{Recovery Area} &= (\text{shoulder width}) + (\text{horizontal distance}) \\ &+ (\text{Design Clear Zone distance} - \text{shoulder width}) \\ &= 8 + 12 + (17 - 8) \\ &= 29 \text{ ft} \end{aligned}$$

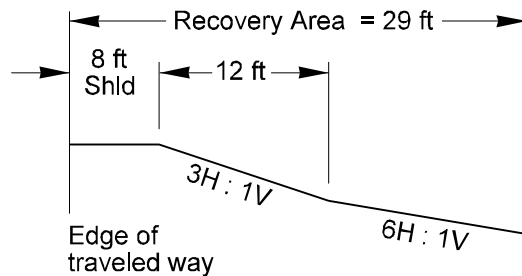

**Recovery Area**  
*Figure 700-3*

Cut Section with Ditch (foreslope 4H:1V or flatter)

Conditions: Speed - 55 mph  
 Traffic - 4200 ADT  
 Slope - 4H:1V

Criteria: Greater of  
 (1) Design Clear Zone for 10H:1V Cut Section, 23 ft  
 (2) 5 ft horizontal beyond beginning of backslope, 22 ft

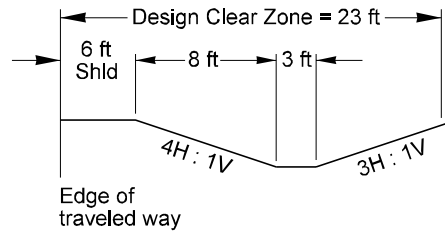

Design Clear Zone = 23 ft

### Case 1

Cut Section with Ditch (foreslope 3H:1V or steeper and backslope steeper than 3H:1V)

Conditions: NA  
 Criteria: 10 ft horizontal beyond beginning of backslope

Design Clear Zone = 19 ft

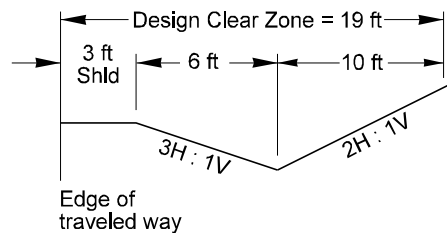

### Case 2

Cut Section with Ditch (foreslope 3H:1V or steeper and backslope not steeper than 3H:1V)

Conditions: Speed - 45 mph  
 Traffic - 3000 ADT  
 Foreslope - 2H:1V  
 Backslope 4H:1V  
 Criteria: Use Recovery Area Formula

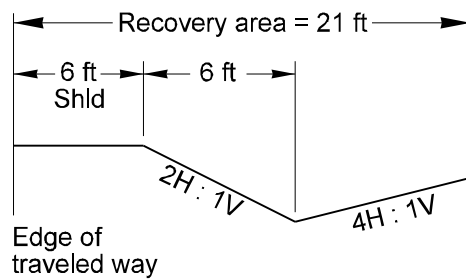

Recovery Area = (shoulder width) + (horizontal distance) + (Design Clear Zone distance - shoulder width) = 6 + 6 + (15 - 6) = 21 ft

### Case 3

## Design Clear Zone for Ditch Sections

Figure 700-4

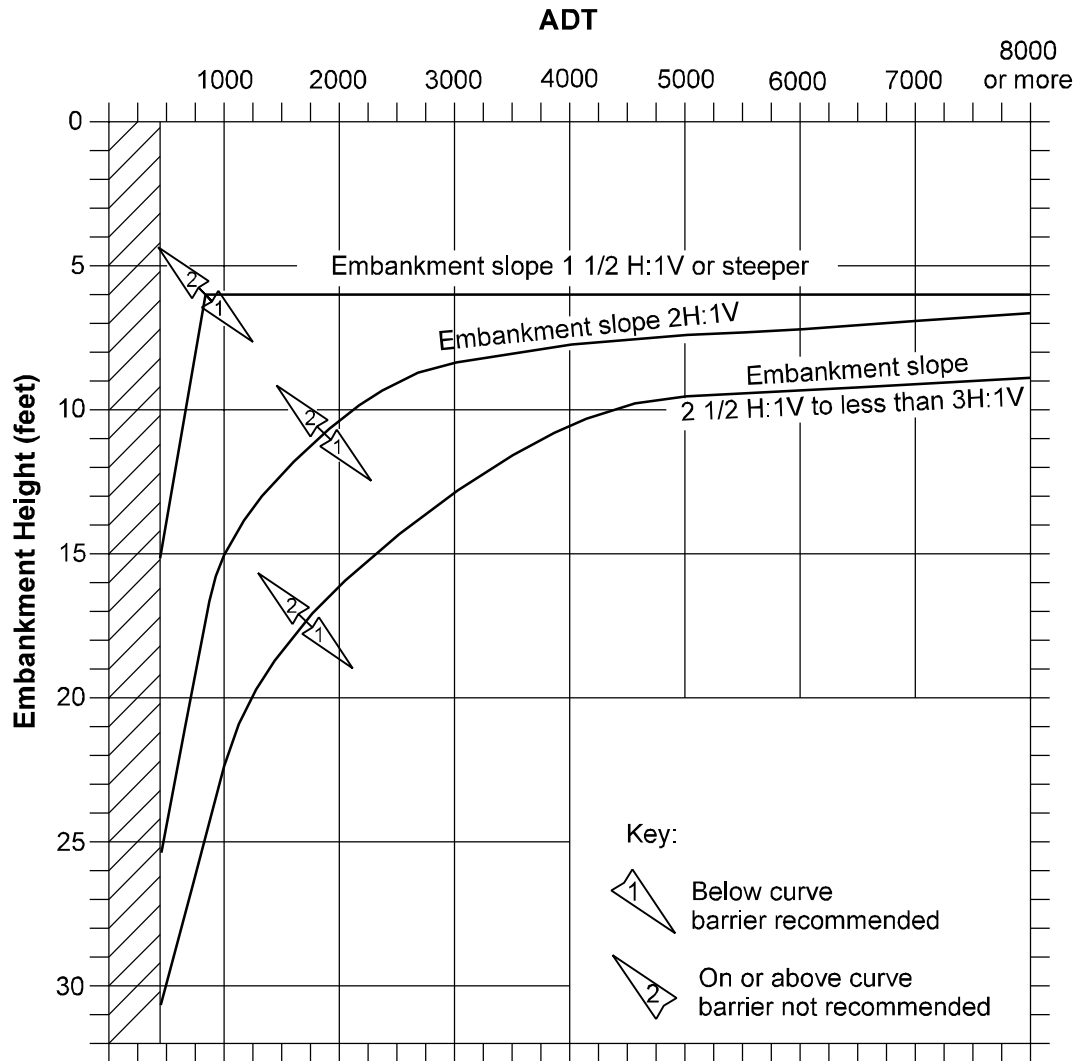

Note: Routes with ADTs under 400 may be evaluated on a case by case basis.

### Guidelines for Embankment Barrier

Figure 700-5

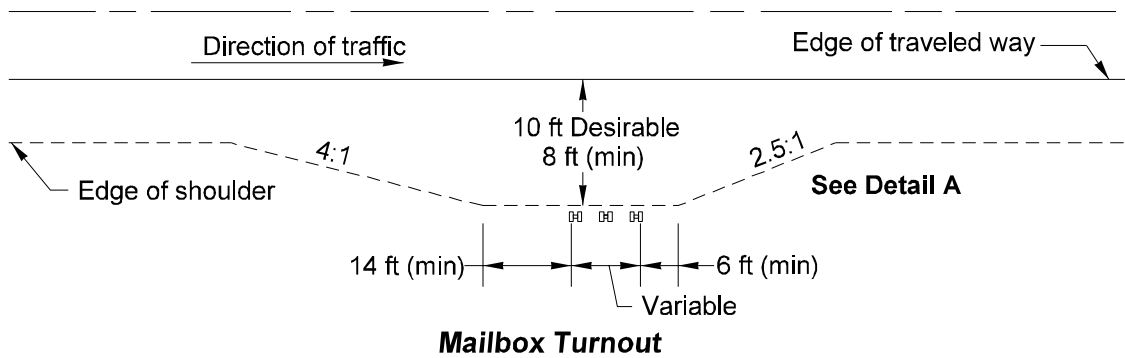
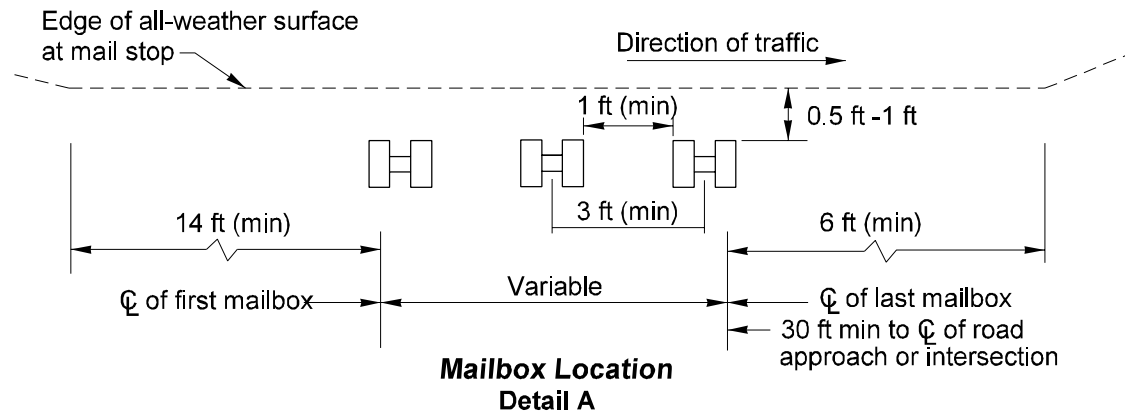

### Mailbox Location and Turnout Design

Figure 700-6

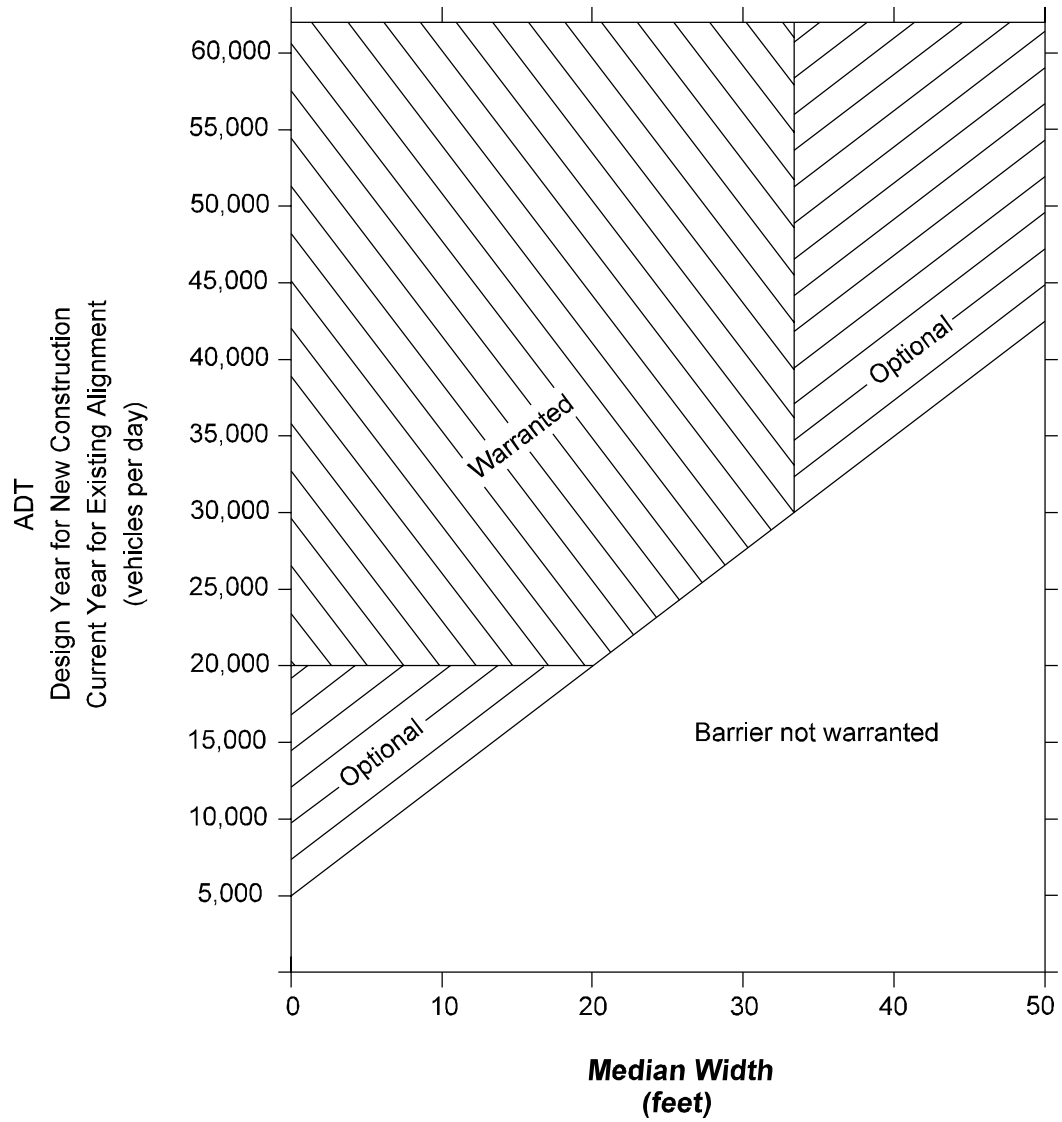

**Warrants for Median Barrier**  
*Figure 700-7*

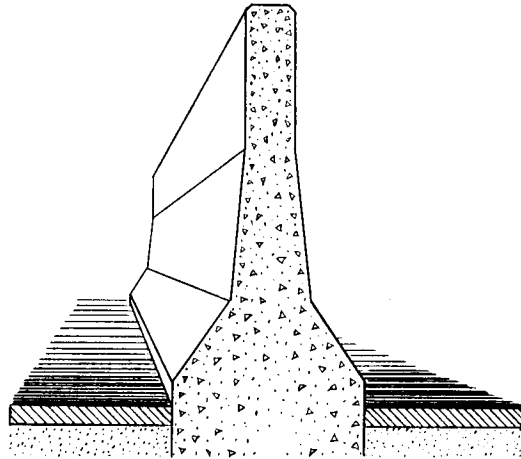
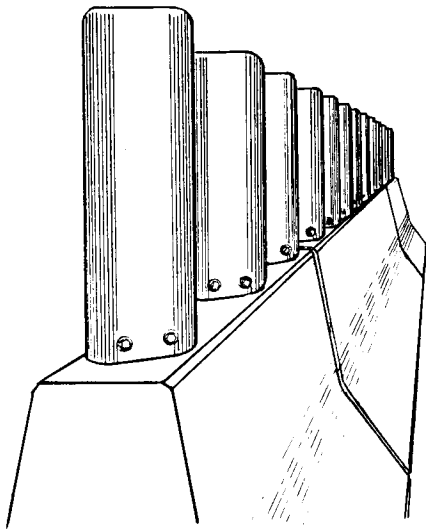
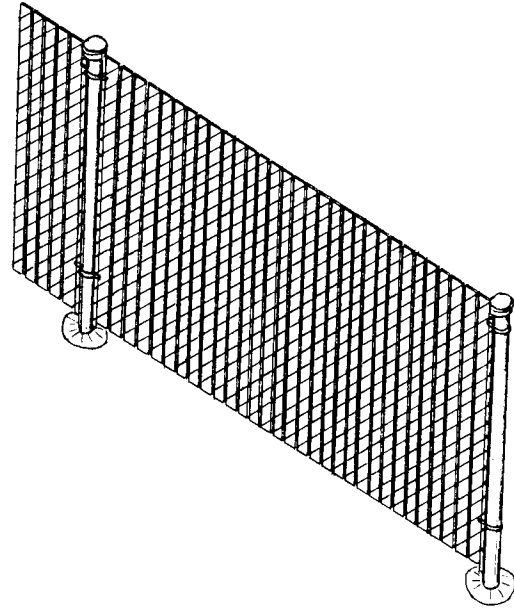
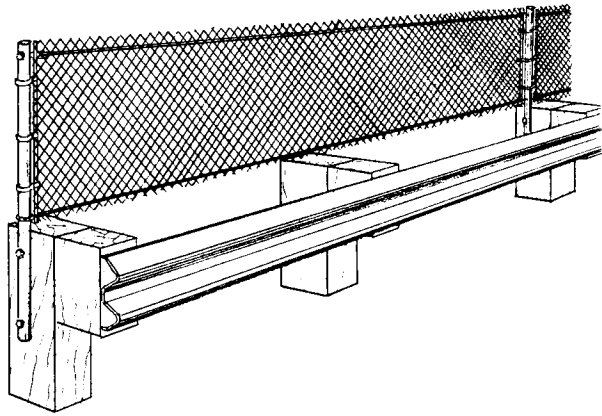

**Glare Screens**  
*Figure 700-8*

710.01	General
710.02	References
710.03	Definitions
710.04	Project Requirements
710.05	Barrier Design
710.06	Beam Guardrail
710.07	Cable Barrier
710.08	Concrete Barrier
710.09	Special Use Barriers
710.10	Redirectional Land Forms
710.11	Bridge Rails
710.12	Other Barriers
710.13	Documentation

### 710.01 General

Traffic barriers are used to reduce the severity of accidents that occur when an errant vehicle leaves the traveled way. However, traffic barriers are obstacles that the vehicle will encounter and must only be used when justified by accident history or the criteria in Chapter 700.

### 710.02 References

*Standard Plans for Road, Bridge, and Municipal Construction (Standard Plans)*, M 21-01, WSDOT

*Roadside Design Guide*, AASHTO

*Bridge Design Manual*, M 23-50, WSDOT

*Traffic Manual*, M 51-02, WSDOT

### 710.03 Definitions

**barrier terminal** A crashworthy end treatment for longitudinal barriers that is designed to reduce the potential for spearing, vaulting, rolling, or excessive deceleration of impacting vehicles from either direction of travel. Beam guardrail terminals include anchorage.

**controlled releasing terminal (CRT) post** A standard length guardrail post that has two holes drilled through it so that it will break away when struck.

**crashworthy** A feature that has been proven acceptable for use under specified conditions

either through crash testing or in-service performance.

**guardrail transition** A section of barrier used to produce a gradual stiffening of a flexible or semirigid barrier as it connects to a more rigid barrier or fixed object.

**impact attenuator system** A device that acts primarily to bring an errant vehicle to a stop at a deceleration rate tolerable to the vehicle occupants or to redirect the vehicle away from a hazard.

**length of need** The length of a traffic barrier needed to shield a hazard.

**longitudinal barrier** Traffic barrier oriented parallel or nearly parallel to the roadway. The purpose is to contain or redirect errant vehicles. Beam guardrail, cable barrier, bridge rail, and concrete barrier are longitudinal barriers. Longitudinal barriers are categorized as rigid, unrestrained rigid, semirigid, or flexible and can be installed as roadside or median barriers.

**shy distance** The distance from the edge of the traveled way beyond which a roadside object will not be perceived as an immediate hazard by the typical driver to the extent that the driver will change the vehicle's placement or speed.

**traffic barrier** A longitudinal barrier, including bridge rail, or an impact attenuator used to redirect vehicles from hazards located within an established Design Clear Zone, to prevent median crossovers, to prevent errant vehicles from going over the side of a bridge structure, or (occasionally) to protect workers, pedestrians, or bicyclists from vehicular traffic.

### 710.04 Project Requirements

This section identifies the barrier elements that must be addressed according to the Design Matrices in Chapter 325. Remove any barrier that is not needed (based on the criteria in Chapter 700) and poses a more severe hazard than the hazard it is shielding.



## **(1) Barrier Terminals and Transitions**

(a) **Basic Design Level (B).** When the basic design level (B) is indicated in the Terminal and Transition Section column of a Design Matrix, install, replace, or upgrade transitions as discussed in 710.06(3), Beam Guardrail Transitions.

Replace guardrail ends that do not have a crashworthy design with a crashworthy guardrail terminal. See 710.06(2), Beam Guardrail Terminals.

Common features of noncrashworthy designs are as follows:

- No cable anchor.
- A cable anchored into concrete in front of the first post.
- Second post not breakaway (CRT).
- Design A end section (Design C end sections may be left in place).
- Beam guardrail on both sides of the posts (two sided).

One terminal that was used extensively on Washington's highways was the Breakaway Cable Terminal (BCT). This system used a parabolic flare similar to the SRT and a Type 1 anchor. Type 1 anchor posts are wood set in a steel tube or a concrete foundation.

BCTs that have at least a 3 ft offset may remain in place when the basic design level applies unless the guardrail run or anchor is being reconstructed or reset. (Raising the rail element is not considered reconstruction or resetting.) Replace all BCTs that have less than a 3 ft offset.

Replace existing buried guardrail terminals that slope down such that the guardrail height is reduced to less than 24 in.

Concrete barrier terminals must meet the requirements found in 710.08(2).

Impact attenuators must meet the requirements found in Chapter 720, Impact Attenuators.

For preservation projects, this work may be programmed under a separate project as described in Chapter 410.

(b) **Full Design Level (F).** When the full design level (F) is indicated, the requirements for the basic design level apply except that all BCT's must be replaced.

## **(2) Standard Run of Barrier**

(a) **Basic Design Level (B).** When the basic design level (B) is indicated in the Standard Run column of a Design Matrix and the height of W-beam guardrail is or would be reduced to less than 24 in from the ground to the top of the rail element, adjust the height to the standard height as shown in the *Standard Plans*. If Type 1 Alternate W-beam guardrail is present, raise the rail element after each overlay.

Overlays in front of safety shaped concrete barriers can extend to the top of the lower, near-vertical face of the barrier before adjustment is required.

(b) **Full Design Level (F).** When the full design level (F) is indicated, in addition to the requirements for the basic design level, the barrier must meet the requirements found in the following:

710.05(1)	Shy Distance
710.05(2)	Barrier Deflection
710.05(3)	Barrier Flare Rate
710.05(4)	Length of Need
710.06	Beam Guardrail
710.07	Cable Barrier
710.08	Concrete Barrier

Examples of nonstandard barriers include:

- W-beam guardrail with 12 ft-6 in post spacing and no blockouts.
- W-beam guardrail on concrete posts.
- Cable barrier on wood or concrete posts.
- Half-moon or C shape rail element.

In all cases where nonstandard barrier is to be left in place, the terminals and transitions must be upgraded.

## **(4) Bridge Rail**

When the Bridge Rail column of a matrix applies to the project, the bridge rails must meet the following requirements:

Use an approved, crash tested concrete bridge rail on new bridges or bridges to be widened. The *Bridge Design Manual* provides examples of typical bridge rails. Consult the Bridge and Structures Office regarding bridge rail selection and design and for design of the connection to an existing bridge.

An existing bridge rail on a highway with a posted speed of 30 mph or less may remain in place if it is not located on a bridge over a National Highway System highway. All other bridge rails must be evaluated for strength and geometrics. (See 710.11 for guidance on retrofit techniques.)

The Type 7 bridge rail is common. Type 7 bridge rails have a curb, a vertical-face parapet, and an aluminum top rail. The curb width and the type of aluminum top rail dictate the adequacy of the Type 7 bridge rail as shown on Figure 710-1. Consult the Bridge and Structures Office for assistance in evaluating other bridge rails.

### 710.05 Barrier Design

When selecting a barrier, consider the flexibility, cost, and maintainability of the system. It is generally desirable to use the most flexible system possible to minimize damage to the

impacting vehicle. However, since nonrigid systems sustain more damage during an impact, the exposure of maintenance crews to traffic might be increased.

Concrete barrier maintenance costs are lower than for other barrier types. Deterioration due to weather and vehicle impacts is limited. Unanchored precast concrete barrier can usually be realigned or repaired when moved from its alignment. However, heavy equipment may be required to reposition or replace barrier segments. Therefore, in medians, consider the shoulder width and the traffic volume when determining the acceptability of unanchored precast concrete barrier versus a rigid concrete barrier.

Drainage alignment and drifting snow or sand are considerations that may influence selection of barrier type. Beam guardrail and concrete barrier can cause snow drifts. Consider long-term maintenance costs associated with snow removal at locations prone to snow drifting. Slope flattening is highly recommended, even at additional cost, to eliminate the need for the barrier. Cable barrier is not an obstruction to drifting snow and can be used if slope flattening is not practical.

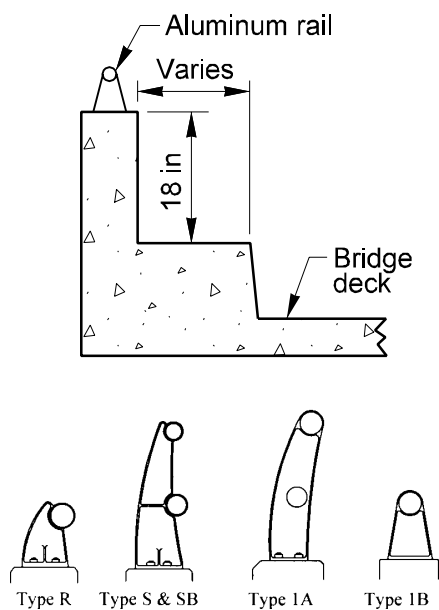

	Curb Width	
	9 in or less	Greater than 9 in*
Aluminum Rail Type	9 in or less	Greater than 9 in*
Type R, S, or SB	Bridge rail adequate	Bridge rail adequate
Type 1B or 1A	Bridge rail adequate	Upgrade bridge rail
Other	Consult the Bridge and Structures Office	

\*When the curb width is greater than 9 in, the aluminum rail must be able to withstand a 5 kip load.

### Type 7 Bridge Rail Upgrade Criteria

Figure 710-1

When designing a barrier for use on a Scenic Byway or Heritage Tour Route (formerly Scenic and Recreational Highway), consider barriers that are consistent with the recommendations in the associated Corridor Management Plan (if one is available). Contact the region's Landscape Architect or Heritage Corridors Program manager to determine if the project is on a designated route. Low cost options, such as using weathering steel beam guardrail (see 710.06) or cable barrier (see 710.07) may be feasible on most projects. Higher cost options, such as steel backed timber rail and stone guardwalls (see 710.09) might require a partnering effort to fund the additional costs. Grants might be available and attainable for this purpose if the need is identified early in the project definition phase. (See Chapter 120.)

### (1) *Shy Distance*

Provide an additional 2 ft of widening for shy distance when a barrier is to be installed in areas where the roadway is to be widened and the shoulder width will be less than 8 ft. This shy distance is not required when the section of roadway is not being widened or the shoulders are at least 8 ft wide.

### (2) *Barrier Deflections*

All barriers except rigid barriers (concrete bridge rails for example) will deflect when hit by an errant vehicle. The amount of deflection depends on the stiffness of the system. For flexible and semirigid roadside barriers, the deflection distance is designed to prevent the impacting vehicle from striking the object being shielded. For unrestrained rigid systems (unanchored precast concrete barrier), the deflection distance is designed to prevent the barrier from being knocked over the side of a drop-off or steep fill slope (1V:2H or steeper).

In median installations, the deflected system must not become a hazard to oncoming traffic. In addition, narrow medians provide little space for maintenance crews to repair or reposition the barrier. Avoid installing deflecting barriers in medians that provide less than 8 ft from the edge of the traveled way to the face of the barrier.

Use a rigid system where deflection cannot be tolerated such as in narrow medians or at the edge of a bridge deck (vertical drop-off). Runs of rigid concrete barrier can be cast-in-place, extruded with appropriate footings, or precast concrete barrier that is bolted or bracketed to the underlying material.

See Figure 710-2 for barrier deflection design values to be used when selecting a longitudinal barrier. The deflection distances for cable and beam guardrail are the minimum measurements from the face of the barrier to the hazard. The deflection distance for unanchored concrete barrier is the minimum measurement from the back edge of the barrier to the drop-off or slope break.

Barrier Type	System Type	Deflection
Cable barrier	Flexible	11.5 ft
Beam guardrail Types 1, 1a, 2, and 10	Semirigid	3 ft
Two-sided W-beam guardrail Types 3 and 4	Semirigid	2 ft
Permanent concrete barrier, unanchored	Unrestrained Rigid	3 ft <sup>(1)</sup>
Temporary concrete barrier, unanchored	Unrestrained Rigid	2 ft <sup>(2)</sup>
Concrete barrier, anchored	Rigid	no deflection

(1) When placed in front of a fill slope that is 1V:2H or flatter, the deflection distance can be reduced to 2 ft.

(2) When used as temporary bridge rail, anchor all barrier that is within 3 ft of a drop-off

### Longitudinal Barrier Deflection

*Figure 710-2*

### (3) *Flare Rate*

Flare the ends of longitudinal barriers where possible. There are four functions of the flare:

- To locate the barrier and its terminal as far from the traveled way as is feasible.

- To reduce the length of need.
- To redirect an errant vehicle without serious injuries to its occupants.
- To minimize a driver's reaction to the introduction of an object near the traveled way.

Keeping flare rates as flat as practical preserves the barrier's redirection performance and minimizes the angle of impact. But, it has been shown that an object (or barrier) close to the traveled way may cause a driver to shift laterally, slow down, or both. The flare reduces this reaction by gradually introducing the barrier so that the driver does not perceive the barrier as a hazard. The flare rates in Figure 710-3 satisfy all four functions listed above. More gradual flares may be used.

Posted Speed mph	Rigid System	Unrestrained Rigid System	Semirigid System
70	20:1	18:1	15:1
60	18:1	16:1	14:1
55	16:1	14:1	12:1
50	14:1	12:1	11:1
45	12:1	11:1	10:1
40	11:1	10:1	9:1
or below			

**Longitudinal Barrier Flare Rates**  
*Figure 710-3*

#### (4) Length of Need

The length of traffic barrier required to shield a hazard (length of need) is dependent on the location and geometrics of the hazard, direction(s) of traffic, posted speed, traffic volume, and type and location of traffic barrier. When designing a barrier for a fill slope as recommended in Chapter 700, the length of need begins at the point where barrier is recommended. For fixed objects and water hazards, Figures 710-11a and b show design parameters for determining the necessary length of a barrier for both adjacent and opposing traffic on rela-

tively straight sections of highway. When the barrier is to be installed on the outside of a horizontal curve, the length of need can be determined graphically as shown on Figure 710-11c. For installations on the inside of a curve, determine the length of need as though it was straight. Consider the flare rate, barrier deflection, and barrier end treatment to be used when determining the length of need.

Before the actual length of need is determined, establish the lateral distance between the proposed barrier installation and the item shielded. This distance must be greater than or equal to the anticipated deflection of the longitudinal barrier. (See Figure 710-2 for barrier deflections.) Place the barrier as far from the edge of the traveled way as possible while maintaining the deflection distance.

If the end of the length of need is near an adequate cut slope, extend the barrier and embed it in the slope. Avoid gaps of 300 ft or less. Short gaps are acceptable when the barriers are terminated in a cut slope. If the end of the length of need is near the end of an existing barrier, it is recommended that the barriers be connected to form a continuous barrier. Consider maintenance access when determining whether to connect barriers.

## 710.06 Beam Guardrail

### (1) Beam Guardrails

Standard beam guardrail systems are shown in the *Standard Plans*.

Strong post W-beam guardrail (Types 1 through 4) and thrie beam guardrail (Type 10) are semirigid barriers used predominately on roadsides. They also have limited application as median barrier. Strong post beam guardrail that has been installed incorrectly can cause vehicle snagging or spearing. This can be avoided by lapping the rail splices in the direction of traffic as shown in the *Standard Plans*, by using crashworthy end treatments, and by blocking the rail away from the strong posts. In no case will more than two 8 in blockouts be permitted at any location.

On asphalt concrete pavements (where overlays are anticipated), the Type 1 Alternate guardrail can be used to allow raising of the guardrail without having to adjust the posts.

Weak post W-beam guardrail (Type 20) and three beam guardrail (Type 21) are flexible barrier systems that can be used where there is adequate deflection distance. These systems use weak steel posts. The primary purpose of these posts is to position the guardrail vertically and they are designed to bend over when struck. These more flexible systems will result in less damage to the impacting vehicle. Since the weak posts will not result in snagging, blockouts are not necessary.

Keep the slope of the area between the edge of shoulder and the face of the guardrail as flat as possible. The preferred slope is 1V:10H or flatter. Do not place beam guardrail on a fill slope steeper than 1V:6H. On fill slopes between 1V:6H and 1V:10H, beam guardrail must not be placed within 12 ft of the break point. (See Figure 710-4.)

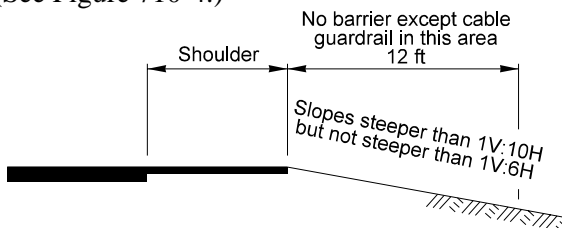

### Guardrail Locations on Slopes

Figure 710-4

On the high side of superelevated sections, place beam guardrail at the edge of shoulder.

Generally, 2 ft of shoulder widening behind the barrier is provided from the back of the post to the beginning of a fill slope. If the slope is 1V:2H or flatter, this distance can be measured from the face of the guardrail rather than the back of the post. (See Figure 710-12, Cases 1 and 2.)

On projects where no roadway widening is proposed and the minimum 2 ft shoulder widening behind the barrier is not practical, long post installations are available as shown on Figure 710-12, Cases 3, 4, 5, and 6. When guardrail is to be installed in areas where the roadway is to be widened, the use of Cases 4, 5, or 6 requires a design deviation.

The use of rail washers on beam guardrail is not standard. In areas where heavy snow accumulations are expected to cause the bolts to pull out, specify snow load post and rail washers in the contract documents. (Snow load post washers are used to prevent the bolts from pulling through the posts and snow load rail washers are used to prevent the bolt head from pulling through the rail.) Rail washers are never to be used within the limits of a guardrail terminal except at the end post where they are required for anchorage of the rail.

It is preferred that no curbs be installed in conjunction with beam guardrail. However, if a curb is necessary, the 3 in high curb is preferred. The 4 in high curb can only be used at locations where the 3 in curb will not be adequate. Do not use 6 in high curb in conjunction with beam guardrails. This policy applies to new installations. Existing 6 in high curb is allowed to remain in place. If work requires replacement of an existing 6 in curb, it must be replaced with a 3 in or 4 in curb, whichever is appropriate.

The preferred location of a curb, when used in conjunction with beam guardrail, is behind the face of the beam as shown in the *Standard Plans*.

Beam guardrail is usually galvanized and has a silver color. It can also be provided in a weathering steel that has a brown or rust color. Weathering steel guardrail may be desirable on Scenic Byways or Heritage Tour Routes. (See 710.05.)

## (2) Terminals and Anchors

A guardrail anchor is required at the ends of a run of guardrail to develop its tensile strength throughout its length. In addition, when the end of the guardrail is subject to head-on impacts, a crashworthy guardrail terminal is required. (See the *Standard Plans*.)

(a) **Buried Terminals.** The buried terminal (BT) is designed to terminate the guardrail by burying the end in a backslope. The standard BT is the preferred terminal because it eliminates the exposed end of the guardrail.

The BT uses a Type 2 anchor to develop the tensile strength in the guardrail. The entire BT can be used within the length of need.

The backslope required to install a BT must be 1V:3H or steeper and at least 4 ft in height above the roadway. Flare the guardrail into the backslope using a flare rate that meets the criteria in 710.05(3). Provide a 1V:10H or flatter foreslope into the face of the guardrail and maintain the full guardrail height to the foreslope/backslope intersection. This may require filling ditches and installing culverts in front of the guardrail face.

(b) **Flared Terminal.** If a BT cannot be installed as described above, consider a flared terminal. (See Figure 710-13.) There are currently 2 acceptable sole source proprietary designs; the Slotted Rail Terminal (SRT) and the Flared Energy Absorbing Terminal (FLEAT).

Both of these designs include an anchor for developing the tensile strength of the guardrail. The length of need begins at the third post for both flared terminals.

1. The SRT uses W-beam guardrail with slots cut into the corrugations and wood breakaway and controlled release terminal (CRT) posts that are designed to break away when hit. The end of the SRT is offset from the tangent guardrail run by the use of a parabolic flare. When struck head on, the first 2 posts are designed to break away and the parabolic flare gives the rail a natural tendency to buckle, minimizing the possibility of the guardrail end entering the vehicle. The buckling is facilitated by the slots in the rail. The CRT posts provide strength to the system for redirection and deceleration without snagging the vehicle.

The SRT has a 4 ft offset of the first post.

2. The FLEAT uses W-beam guardrail with a special end piece that fits over the end of the guardrail and wood breakaway and CRT posts. The end of the FLEAT is offset from the tangent guardrail run by the use of a straight flare. When struck head on, the end

piece is forced over the rail, bending the rail and forcing it away from the impacting vehicle.

The FLEAT is available in 2 designs based on the posted speed of the highway. For high speed highways (posted speed of 45 mph or greater) use a FLEAT 350 that has a 4 ft offset at the first post. For lower speed highways (posted speed of 40 mph or less), use a FLEAT TL-2 that has a 20 in offset at the first post.

When a flared terminal is specified, it is critical that embankment also be specified so that the area around the terminal can be flattened as shown on the *Standard Plans*. For every foot of height of the embankment, 13 cubic yards of "Embankment in Place" must be specified.

No snow load rail washers are allowed within the limits of this terminal.

The FHWA has granted approval to use these sole source proprietary terminals without justification on a project by project basis.

(c) **Nonflared Terminal.** Where widening to provide the offset for a flared terminal is not practical, consider a nonflared terminal. (See Figure 710-13.) There are currently 2 acceptable sole source proprietary designs; the ET 2000 - PLUS and the Sequential Kinking Terminal (SKT). Both of these systems use W-beam guardrail with a special end piece that fits over the end of the guardrail and wood breakaway and CRT posts. When hit head-on, the end piece is forced over the rail and either flattens or bends the rail and then forces the rail away from the impacting vehicle.

Both of these terminals include an anchor for developing the tensile strength of the guardrail. The length of need begins at the third post for both terminals.

Both of these terminals are available in two designs based on the posted speed of the highway. The primary difference in these designs is the length of the terminal. For high speed highways (posted speed of 45 mph or greater), use the ET

2000 - PLUS (TL3) or SKT 350 which are 50 ft long. For lower speed highways (posted speed of 40 mph or less), use the ET 2000 - PLUS (TL2) or SKT-TL2 which are 25 ft long.

While these terminals do not require an offset at the end, a flare is recommended so that the end piece does not protrude into the shoulder. These terminals may have a 12 in offset of the first post. One meter of widening is required at the end 2 posts to ensure that the system is properly anchored. For every foot of height of embankment, 3 cubic yards of "Embankment in Place" must be specified.

No snow load rail washers are allowed within the limits of these terminals.

The FHWA has granted approval to use these sole source proprietary terminals without justification on a project by project basis.

(d) **Other Anchor Applications.** On the trailing end of guardrail runs along one-way highways, use the Type 4 anchor to develop the tensile strength of the guardrail. Use the Type 5 anchor with the Weak Post Intersection Design. (See 710.06(4) Cases 12 and 13.) The Type 7 anchor is used to develop tensile strength in the middle of a guardrail run when the guardrail curves and weak posts are used. (See 710.06(4) cases 9, 12, and 13.)

The old Type 3 anchor was primarily used at bridge ends. (See Figure 710-5.) This anchor consisted of a steel pipe mounted vertically in a concrete foundation. Bridge approach guardrail was then mounted on the steel pipe. On one-way highways, these anchors were usually positioned so that neither the anchor nor the bridge rail posed a snagging hazard. In these cases, the anchor may remain in place if a stiffened transition section is provided at the connection to the post. On two-way highways the anchor may present a snagging hazard. In these cases, install a connection from the anchor to the bridge rail if the offset from the bridge rail to the face of the guardrail is 18 in or less. If the offset is greater than 18 in, remove the anchor and install a new transition and connection.

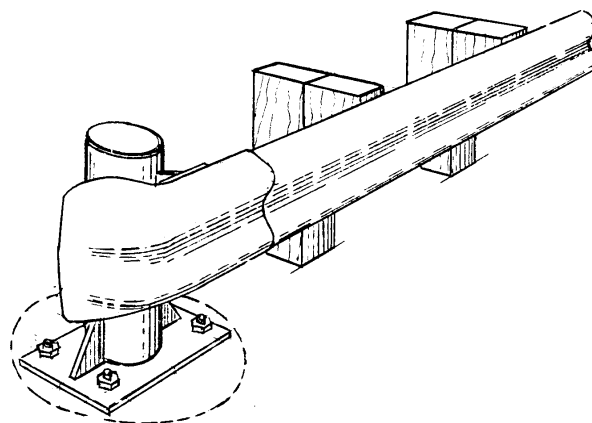

**Old Type 3 Anchor**  
*Figure 710-5*

Locations where crossroads and driveways cause gaps in the guardrail require special consideration. Elimination of the need for the barrier is the preferred solution. Otherwise, a barrier flare may be required to provide sight distance. If the slope is 1V:2H or flatter and there are no hazards on or at the bottom of the slope, a terminal can be used to end the rail. Place the anchor of this installation as close as possible to the road approach radius PC. If there is a hazard at or near the bottom of the slope that cannot be mitigated, then the Weak Post Intersection Design (see 710.04(4) and the *Standard Plans*) can be used. This system can also be used at locations where a crossroad or road approach is near the end of a bridge and installing a standard bridge approach guardrail placement (guardrail transition and terminal) is not possible.

### **(3) Transitions and Connections**

When there is an abrupt change from one barrier type to a more rigid barrier type, a vehicle hitting the more flexible barrier is likely to be caught in the deflected barrier pocket and directed into the more rigid barrier. This is commonly referred to as pocketing. A transition stiffens the more flexible barrier by decreasing the post spacing, increasing the post size, and using stiffer beam elements to eliminate the possibility of pocketing.

When connecting beam guardrail to a more rigid barrier or a structure, or when a rigid object is within the deflection distance of the barrier, use

the transitions and connections that are shown on Figures 710-6 and 7 and detailed in the *Standard Plans*. The transition pay item includes the connection.

	Connection
Untapered safety shaped bridge rails or barriers <sup>(1)</sup>	B
Bridge rails with curbs 9 in or less in width	B
Bridge rails with curbs up to 18 in in width	C
Vertical walls or tapered safety shape barrier	D

<sup>(1)</sup>New safety shaped bridge rails are designed with the toe of the barrier tapered so that it does not project past the face of the approach guardrail.

## Guardrail Connections

Figure 710-6

### (4) Guardrail Placement Cases

The *Standard Plans* contain placement cases that show all of the beam guardrail elements required for typical situations. The following is a description of each.

Case 1 is used only where there is one-way traffic. It uses a crashworthy terminal on the approach end and a Type 4 anchor on the trailing end.

Case 2 is used where there is two-way traffic. A crashworthy terminal is used on both ends. When flared terminals are used on both ends, a minimum of 25 ft of guardrail is required between the terminal limits.

Case 3 is used at railroad signal supports on one-way or two-way roadways. A terminal is used on the approach end but usually cannot be used on the trailing end because of its proximity to the railroad tracks. For one-way roadways, a Type 4 anchor is used on the trailing end. On two-way roadways a Type 1 anchor is used on the trailing end. If there is a history of crossover accidents,

consider additional protection, such as an impact attenuator.

Case 4 is used where guardrail on the approach to a bridge is to be shifted laterally to connect with the bridge rail. A terminal is used on the approach end and a transition is required at the bridge end. A curve in the guardrail is shown to shift it to the bridge rail. However, the length of the curve is not critical and the only requirement is to provide a smooth curve that is not more abrupt than the allowable flare rate. (See Figure 710-3.)

Case 5 is a typical bridge approach where a terminal and a transition are required.

Case 6 is used on bridge approaches where opposing traffic is separated by a median that is 36 ft or wider. This case was designed so that the end of the guardrail would be outside of the clear zone for the opposing traffic.

Cases 7 and 8 are used with beam guardrail median barrier when median hazards such as bridge piers are encountered. A transition is required on the approach end for each direction and the flare rate must not be more abrupt than allowed. (See Figure 710-3.)

Case 9 is used on bridge approaches where opposing traffic is separated by a median less than 36 ft wide. This design, called a “Bull Nose Attenuator,” treats both bridge ends and the opening between the bridges. The “nose” is designed to collapse when struck head-on and the ribbon strength of the rail brings the vehicle to a controlled stop. Type 7 anchors are installed on each side of the nose to develop the ribbon strength.

Since an impacting vehicle will penetrate into the system, it is critical that no fixed object be located within the first 30 ft of the system.

Table 1 on this standard plan gives the dimensions needed for a range of median widths.

Case 10 (A, B, and C) is used at roadside hazards (such as bridge piers) when 3 ft or more is available from the face of the guardrail to the hazard. The approach end is the same for one-way or two-way traffic. Case 10A is used with



Connecting W-beam guardrail to:			Transition	Connection
Bridge Rail	New		1 <sup>(1)</sup>	D
	Existing concrete	Concrete parapet > 20 in	1 <sup>(1)</sup>	Figure 710-6
		Concrete Parapet < 20 in	2	Figure 710-6
		Existing W-Beam Transition	2 <sup>(2)</sup>	<sup>(3)</sup>
	Thrie Beam installed at face of curb <sup>(5)</sup>	Approach end	10	na
		Trailing end, two way traffic only	11, 12	na
	Thrie Beam installed at bridge rail (curb exposed) <sup>(5)</sup>	Approach end	13	na
		Trailing end, two way traffic only	14, 15	na
All if:	Weak Post Intersection Design (see 710.06(4) cases 12 and 13)	5	Figure 710-6	
Concrete	Rigid/ Restrained	1	Figure 710-6	
Barrier	Unrestrained	3	A	
	Temporary	4	A	
Weak Post barrier systems (Type 20 and 21)			6	na
Rigid structures such as bridge piers	New installation (see Case 11)	16, 17, 18	na	
	Existing W-Beam Transition	<sup>(4)</sup>	na	

(1) A Type 1a transition can be used where there is a problem placing a post within 2 ft-5 in from the end of the bridge in which case a B or E connection is required. When the E connection is to be used, a special detail for the end of the bridge is required. Contact the Bridge and Structures Office.

(2) If work requires reconstruction or resetting of the transition, upgrade as shown above. Raising the guardrail is not considered reconstruction.

(3) See 710.06(2)(d) for guidance when Type 3 anchors are encountered. If the transition is not being reconstructed, the existing connection may remain in place.

(4) For new/reconstruction, use Case 11 (thrie beam). For existing Case 11 with W-beam, add a second W-beam rail element.

(5) For Service Level 1 bridge rail see 710.06(4), case 14.

### Transitions and Connections

*Figure 710-7*

two-way traffic and, therefore, a terminal is required on the trailing end. Case 10B is used for one-way traffic when there is no need to extend guardrail past the bridge pier and a Type 4 anchor is used to end the guardrail. Case 10C is used for one-way traffic when the guardrail will extend for a distance past the bridge pier.

Case 11 (A, B, and C) is used at roadside hazards (such as bridge piers) when the guardrail is to be placed within 3 ft of the hazard. Since there is no room for deflection, the rail in front of the hazard must be considered a rigid system and a transition is necessary. The trailing end cases are the same as described for Placement Case 10.

Cases 12 and 13 are called “Weak Post Intersection Designs.” They are used where an intersection requires a gap in the guardrail or there is not adequate space for a standard bridge approach installation. These placements are designed to collapse when hit at the nose, and the ribbon strength of the rail brings the vehicle to a stop. A Type 7 anchor is used to develop the ribbon strength. These designs include a Type 5 transition for connection with bridge rail and a Type 5 anchor at the other end of the rail. The Type 5 anchor is not a breakaway anchor and, therefore, can only be used on low speed side roads and driveways.

Since an impacting vehicle will penetrate into the system, it is critical that no fixed objects be located within the clear area shown on the standard plan. The 25 ft along the side road is critical for the operation of this system.

These designs were developed for intersections that are approximately perpendicular. Evaluate installation on skewed intersections on a case-by-case basis. Use the Case 22 placement if it is not feasible to install this design according to the standard plan.

Case 14 shows the approach rail layout for a Service Level 1 bridge rail system. Type 20 guardrail is used on the approach and no transition is required between the Type 20 guardrail and the Service Level 1 bridge rail since they are both weak post systems. A Type 6 transition is used when connecting the Type 20 to a strong post guardrail or a terminal.

Case 15 is used to carry guardrail across a box culvert where there is insufficient depth to install standard posts for more than 17.7 ft. This design uses steel posts anchored to the box culvert to support the rail. Newer designs, Cases 19, 20 and 21, have replaced this design for shorter spans.

Cases 16 and 17 are similar to Cases 1 and 2, except that they flare the rail and terminal as far from the road as possible and reduce the length of need.

Case 18 is used on the trailing end of bridge rail on a one-way roadway. No transition is necessary.

Cases 19 and 20 are used where it is not possible to install a post at the 6 ft-3 in spacing. These designs omit one post (which allows a span of 11.5 ft) and use nested W-beam to stiffen the rail. The cases differ by the location of the splice. No cutting of the rail or offsetting of the splices is necessary or desirable.

Case 21 is similar to Cases 19 and 20, except that it allows for two posts to be omitted which allows a span of 17.7 ft.

Case 22 is the Strong Post Intersection Design that provides a stiff barrier. This design is only to be used as a last resort at crossroads or road approaches where a barrier is necessary and there isn't a clear area behind the nose or minimum distances for a “Weak Post Intersection Design.”

## **710.07 Cable Barrier**

Cable barrier is a flexible barrier system that can be used on a roadside or as a median barrier.

This system consists of three steel cables mounted to steel posts (weak posts). The maximum spacing for the steel posts is 16 ft on tangent sections and curves of 700 ft radius or greater. A deflection of 11.5 ft is anticipated with this post spacing. A smaller spacing is required on radii less than 710 ft. For tangent sections and large radius curves, the deflection can be reduced to 7 ft by reducing the post spacing to 4 ft.

At each end of the barrier run, the cable is turned down and anchored to concrete blocks. A coil spring and turnbuckle are required on each cable to maintain tension on the system.

Cable barrier can be installed in front of side slopes as steep as  $1V:2H$ . This barrier is the only barrier that can be placed on a side slope steeper than  $1V:10H$  within the 12 ft area immediately beyond the breakpoint. Do not place this barrier on a side slope steeper than  $1V:6H$ . Figure 710-14 shows the placement of cable barrier.

When cable barrier is to be connected to a more rigid barrier, a transition section is required. Contact the Olympia Service Center (OSC) Design Office for details.

The primary advantage of cable barrier is that it provides effective vehicle containment and redirection while imposing the lowest deceleration forces on the vehicle's occupants. It also has advantages in heavy snowfall areas and it does not present a visual barrier which may make it desirable on Scenic Byways. (See 710.05.)

Maintenance is a consideration because routine maintenance is necessary to keep tension in the cables and a comparatively long run of cable barrier will have to be repaired after an impact. However, the effort (time and materials) required to maintain and repair cable barrier is much less than the effort required for a W-beam system.

### 710.08 Concrete Barrier

Concrete barriers are rigid or unrestrained, rigid systems that are primarily used as median barriers. They are also used as shoulder barriers. These systems are stiffer than beam or cable barrier and impacts with these barriers will tend to be more severe.

Light standards mounted on top of concrete median barrier must not have breakaway features. See the *Standard Plans* for the concrete barrier light standard section.

Where drainage may be a problem, contact the OSC Hydraulics Branch for guidance.

#### (1) Concrete Barrier Shapes

Concrete barriers use a safety shaped (New Jersey shape and, on bridges, the F-Shape) or single-sloped face to redirect vehicles while minimizing vehicle vaulting, rolling, and snagging. A comparison of these barrier shapes is shown on Figure 710-8.

The New Jersey shaped face is used on precast concrete barrier.

The single-slope barrier face is recommended when separating roadways with different elevations (stepped medians). The single-slope barrier face can be used for bridge rails (median or outside) when it is to be used on any approach to the bridge and an existing bridge rail is to be replaced.

The F-Shape face is used on all other bridge rails and on cast-in-place barrier where the New Jersey and single-slope face are not appropriate. When the F-Shape face is used and precast barrier is to be used on the approaches, a cast-in-place transition section is required so that no vertical edges of the barriers are exposed to oncoming traffic. For details on the F-Shape barrier or any of the bridge rail designs, see the *Bridge Design Manual*.

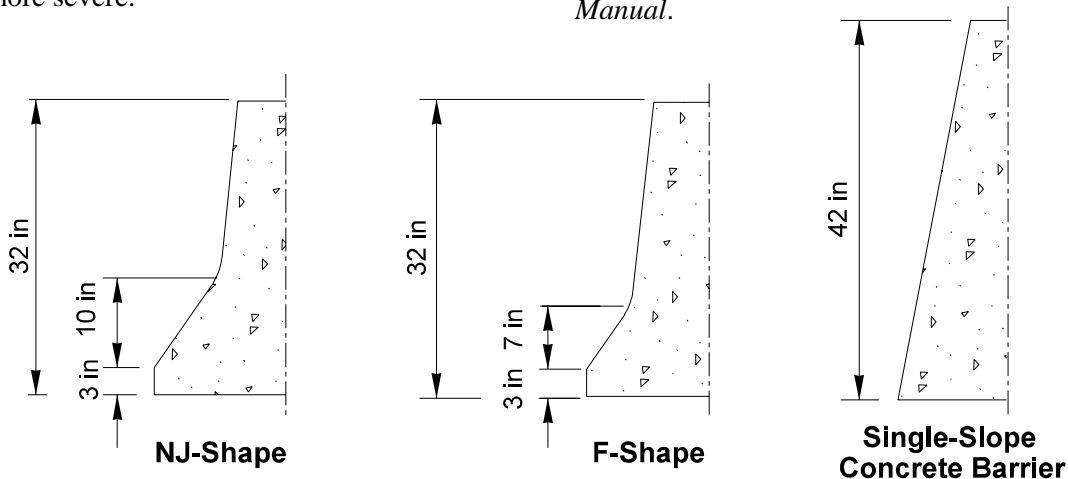

Concrete Barrier Shapes  
Figure 710-8

For aesthetic reasons, avoid changes in the shape of the barrier face within a project or corridor. However, the cost of precast Type 2 barrier is significantly less than the cost of the cast-in-place barriers. Therefore, consider the length of the barrier run to determine whether transitioning to precast Type 2 barrier is desirable. If precast Type 2 barrier is used for the majority of a project, use the New Jersey face for small sections that require cast-in-place barrier.

(a) **New Jersey Shape Barrier.** The New Jersey shaped face is primarily used on precast concrete barrier.

Concrete barrier Type 2 (see the *Standard Plans*) is a precast barrier that has the New Jersey shape on two sides and can be used for both median and shoulder installations. This barrier is 32 in in height, which includes 3 in for future pavement overlay.

Concrete barrier Type 5 is a precast barrier that has a single New Jersey face and is intended for use at bridge ends where the flat side is highly visible. Both designs are freestanding, unanchored units connected with steel pins through wire rope loops. For permanent installation, this barrier is placed on a paved surface and a 2 ft wide paved surface is provided beyond the barrier for its displacement during impact. (See Chapter 640.)

Concrete barrier Type 4 is also a precast, single-faced New Jersey shaped barrier. These units are not freestanding and must be placed against a rigid structure or anchored to the pavement. If Type 4 barriers are used back to back, consider filling any gap between them to prevent tipping.

Precast barrier can be anchored where a more rigid barrier is desired. Anchoring methods are shown in the *Standard Plans*. The Type 1 and 2 anchors are for temporary installations on a rigid pavement. Type 3 anchors can be used in temporary or permanent installations on an asphalt pavement. Consult the Bridge and Structures Office for details when anchoring permanent precast concrete barrier to a rigid pavement.

Precast barrier used on the approach to bridge rail must be connected to the bridge rail by installing wire rope loops embedded 15 in into the bridge rail with epoxy resin.

For unrestrained (unanchored) precast concrete barrier, the preferred foundation slope is 5 percent or flatter with a maximum of 8 percent. The slope of the area between the edge of the shoulder and the face of the traffic barrier should be kept as flat as possible. The maximum slope is 1V:10H.

(b) **Single Slope Barrier.** The single slope concrete barrier (see Figure 710-9) can be cast-in-place, slipformed, or precast. The most common

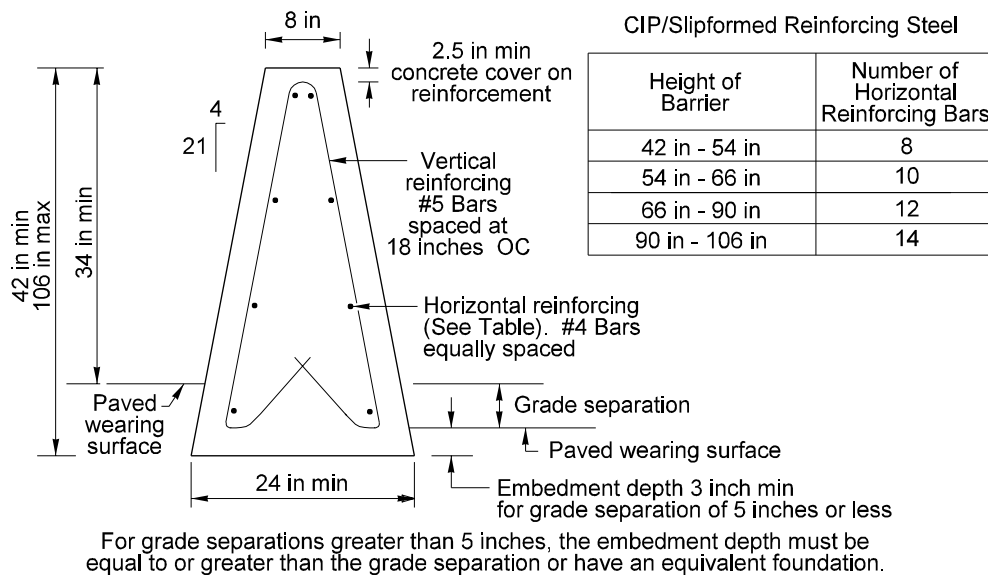

**Single Slope Concrete Barrier**  
Figure 710-9

construction technique for this barrier has been slipforming but some precast single slope barrier has been installed. The primary benefit of using precast barrier is that it can be used as temporary barrier during construction and then reset into a permanent location.

This barrier is considered a rigid system regardless of the construction method used. For new installations, the minimum height of the barrier above the roadway is 34 in which allows 2 in for future overlays. The minimum total height of the barrier section is 42 in with a minimum of 3 in embedded in the roadway wearing surface. This allows for use of the barrier between roadways with grade separations of up to 5 in. For greater grade separations, the barrier must have a depth of embedment equal to or greater than the grade separation or have an equivalent structural foundation.

For details of the single slope barrier, contact the OSC Design Office.

## **(2) Concrete Barrier Terminals**

Whenever possible, bury the end of the concrete barrier in the backslope. The backslope required to bury the end must be 1V:3H or steeper and at least 4 ft in height above the roadway. Flare the concrete barrier into the backslope using a flare rate that meets the criteria in 710.05(3). Provide a 1V:10H or flatter foreslope into the face of the barrier and maintain the full barrier height to the foreslope/backslope intersection. This might require filling ditches and installing culverts in front of the barrier face.

A precast or cast-in-place terminal section having a minimum length of 48 ft and a maximum length of 80 ft is another end treatment. It can only be used for posted speeds of 35 mph or less. Contact the OSC Design Office for details on this end treatment.

The 7 ft long precast concrete terminal end section for Concrete Barrier Type 2 may be used:

- Outside the Design Clear Zone.
- On the trailing end of the barrier when it is outside the Design Clear Zone for opposing traffic.
- On the trailing end of one-way traffic.

- Where the posted speed is 25 mph or less.

When the Barrier Terminals and Transitions column of a design matrix applies to a project, existing sloped down concrete terminals that are within the Design Clear Zone must be replaced when they do not meet the criteria above.

When the end of a concrete barrier cannot be buried in a backslope or terminated as described above, terminate the barrier using a guardrail terminal and transition or an impact attenuator. (See Chapter 720.)

## **710.09 Special Use Barriers**

The following barriers may be used on designated Scenic Byway and Heritage Corridor routes if funding can be arranged. (See 710.05 and Chapter 120.)

### **(1) Steel Backed Timber Guardrail**

Steel backed timber guardrails consist of a timber rail with a steel plate attached to the back to increase its tensile strength. There are several variations of this system that have passed crash tests. The nonproprietary systems use a beam with a rectangular cross section that is supported by either wood or steel posts. A proprietary (patented) system called the Ironwood guardrail is also available. This system uses a beam with a round cross section and is supported by steel posts with a wood covering to give the appearance of an all-wood system from the roadway. The Ironwood guardrail can be allowed as an alternate to the nonproprietary system. However, specifying this system exclusively requires the approval, from the Assistant State Design Engineer, of a public interest finding for the use of a sole source proprietary item.

The most desirable method of terminating the steel backed timber guardrail is to bury the end in a back slope as described in 710.06(2)(a).

When this type of terminal is not possible, the use of the barrier is limited to highways with speeds of 45 mph or less. On these highways, the barrier can be flared away from the traveled way and terminated in a berm.

For details of these systems, contact the OSC Design Office.

## **(2) Stone Guardwalls**

Stone guardwalls function like rigid concrete barriers but have an appearance of natural stone. These walls can be constructed of stone masonry over a reinforced concrete core wall or of simulated stone concrete. These types of barriers are designed to have a limited projection of the stones that will not affect the redirection characteristics of the barrier. Installation of stone guardwalls is limited to highways with a posted speed of 55 mph or less when the end can be buried in a backslope as described in 710.08(2). When this type of terminal is not possible, the use of the barrier is limited to highways with speeds of 45 mph or less. On these highways, the barrier can be flared away from the traveled way and terminated in a berm.

For details of these systems, contact the OSC Design Office.

## **710.10 Redirectional Land Forms**

Redirectional land forms, also referred to as earth berms, redirect an errant vehicle. They are used to mitigate hazards located in depressed medians and may be used at roadside hazards when the slope, length, and height requirements can be met.

The *Standard Plans* shows a typical redirection land form and identifies basic design features. Earth berm heights and slope rates are not fixed. Slopes adjacent to the hazard should be in the range of 1V:2H to 1V:3H. Flatter slopes may be used in the transition areas preceding the hazard. Berm heights over 10 ft are not recommended.

Redirectional land forms are constructed of readily available materials that will provide support for the traversing vehicle without special compaction. Aesthetic compatibility is a significant consideration in selecting the earth berm surface material. Contact the region's Landscape Architecture Office for additional guidance on the surface material and vegetation requirements for redirection land forms.

Redirectional land forms can add to the foundation loads or affect the seismic performance of a structure. Identify proposed locations in the planning stage of the design of a new structure.

Investigate locations of proposed berms for possible foundation overloading or seismic concerns at existing structures.

Items required to drain the roadway shoulder and median ditch areas, such as grate inlets or slotted drains, should not interrupt the smooth contours of the land form or shoulder.

## **710.11 Bridge Rails**

Bridge rails are traffic barriers that redirect errant vehicles and prevent them from going over the side of the structure. See the *Bridge Design Manual* for information on bridge rail on new bridges and replacement bridge rail on existing bridges.

For most new bridge rail installations, use a 32 in high safety shape (F Shape) bridge rail. The single slope bridge rail that is 34 in high can be used to be consistent with the heights of connecting single slope barrier (710.08(1)(b)).

Use taller, 42 in, safety shape or single slope bridge rails on Interstate or freeway routes where accident history suggests a need or where roadway geometrics increase the possibility of a larger trucks hitting the barrier at a high angle (such as on ramps for freeway to freeway connections with sharp curvature in the alignment).

For bridges where high volumes of pedestrian traffic are anticipated, see Chapter 1020 for further guidance.

Approach barriers, transitions, and connections are usually required on all four corners of bridges carrying two-way traffic and on both corners of the approach end for one-way traffic. See 710.06(3) for guidance on transitions.

If the bridge rail system does not meet the criteria for strength and geometrics, modifications to improve its redirection characteristics and its strength may be required. The modifications can be made using one of the retrofit methods described below.

### **(1) Concrete Safety Shape**

Retrofitting with a new concrete bridge rail (see Figure 710-10) is costly and requires justification when no widening is proposed. Consult the

Bridge and Structures Office for design details and to determine if the existing bridge deck and other superstructure elements are of sufficient strength to accommodate this bridge rail system.

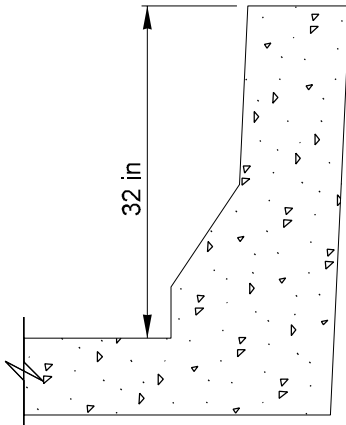

**Safety Shaped Concrete Bridge Rail Retrofit**  
**Figure 710-10**

## (2) Thrie Beam Retrofit

Retrofitting with thrie beam is an economical way to improve the strength and redirection performance of bridge rails. The thrie beam can be mounted to steel posts or the existing bridge rail, depending on the structural adequacy of the bridge deck, the existing bridge rail type, the width of curb (if any), and the curb-to-curb roadway width carried across the structure.

The existing bridge deck must have adequate strength to withstand an impact without causing significant damage to the deck. Contact the Bridge and Structures office to determine if the deck has adequate strength.

Consider the Service Level 1 (SL-1) system on bridges with wooden decks and for bridges with concrete decks that do not have adequate strength to accommodate the standard thrie beam system. Contact the Bridge and Structures Office for information required for the design of the SL-1 system.

Figure 710-15 shows typical installation criteria.

## 710.12 Other Barriers

### (1) Water Filled Barriers

Water filled barriers are longitudinal barrier systems that use light weight modules pinned together and filled with water to form a barrier. They may be used only in work zones as an improvement over cones or plastic drums. See the *Traffic Manual* for further guidance.

Two different water filled barrier systems (Triton and Guardian) have been crash tested with the vehicle hitting the system at a 25 degree angle at 45 mph and 60 mph. The systems were deflected up to 13 ft at 45 mph and up to 23 ft at 60 mph. At lesser speeds and angles this deflection will be less. However, with this amount of deflection, use of water filled barrier will generally not be practical when a crashworthy barrier is required. Therefore, they cannot be considered a substitute for concrete barrier.

The minimum length of water filled barrier is 100 ft. For 45 mph, the end 30 ft do not contribute to the length-of-need. For 60 mph, the end 60 ft do not contribute to the length of need. One of the water filled systems, the Triton Barrier, can act as its own end treatment if the end module is left empty and the retaining pin is left out of the exposed end. The other system, the Guardian, requires a crashworthy end treatment or a TMA on the approach end.

### (2) Dragnet

The Dragnet Vehicle Arresting Barrier consists of chain link or fiber net that is attached to energy absorbing units. When a vehicle hits the system, the Dragnet brings the vehicle to a controlled stop with a minimum of damage. Possible uses for this device are as follows:

- Reversible lane entrances and exits.
- Railroad crossings.
- Truck escape ramps (instead of arrester beds).
- T-intersections.
- Work zones.

For permanent installations, this system can be installed between towers that lower the unit into position when needed and lift it out of the way when it is no longer needed. For work zone applications, it is critical to provide deflection space for stopping the vehicle between the system and the work zone. For additional information on the Dragnet, contact the OSC Design Office.

## **| 710.13 Documentation**

The following documents are to be preserved in the project file. See Chapter 330.

- Barrier selection.
- Shy distance requirements.
- Barrier length of need calculation.
- Long guardrail post justification or approved deviation.
- Barrier terminal and transition selection.
- Bridge rail evaluation and upgrade method.

*P65:DP/DMM*



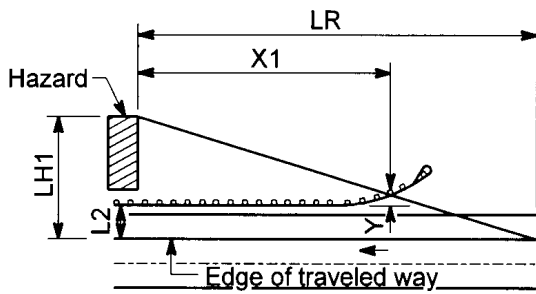

$$X1 = \frac{LH1 - (L2+Y)}{(LH1/LR)}$$

Adjacent-Side Hazard  
Barrier Parallel to Roadway

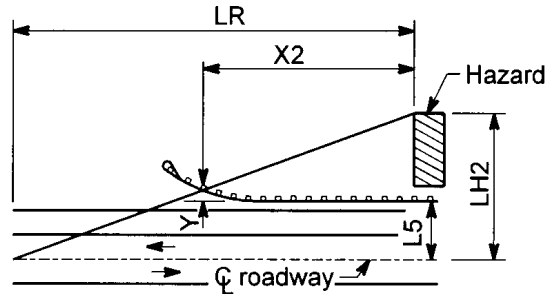

$$X2 = \frac{LH2 - (L5+Y)}{(LH2/LR)}$$

Opposite-Side Hazard  
Barrier Parallel to Roadway

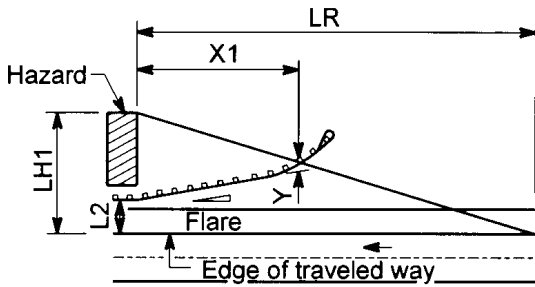

$$X1 = \frac{LH1 - (L2+Y)}{(1/F) + (LH1/LR)}$$

Adjacent-Side Hazard  
Barrier Flare Begins at Hazard

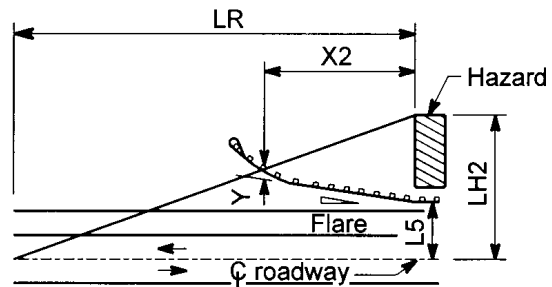

$$X2 = \frac{LH2 - (L5+Y)}{(1/F) + (LH2/LR)}$$

Opposite-Side Hazard  
Barrier Flare Begins at Hazard

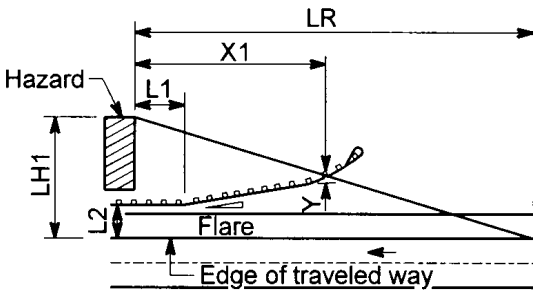

$$X1 = \frac{(LH1 + L1/F) - (L2+Y)}{(1/F) + (LH1/LR)}$$

Adjacent-Side Hazard  
Barrier Flare Begins Before Hazard

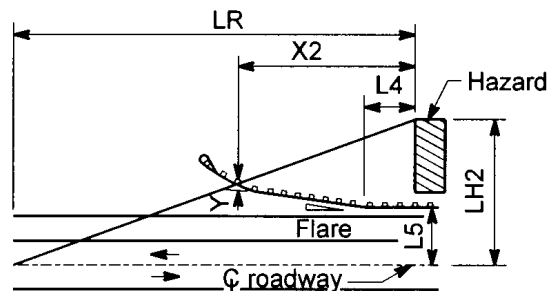

$$X2 = \frac{(LH2 + L4/F) - (L5+Y)}{(1/F) + (LH2/LR)}$$

Opposite-Side Hazard  
Barrier Flare Begins Before Hazard

### Barrier Length of Need

Figure 710-11a

- L1 = Length of barrier parallel to roadway from adjacent-side hazard to beginning of barrier flare. This is used if a portion of the barrier cannot be flared (such as a bridge rail and the transition)
- L2 = Distance from adjacent edge of traveled way to portion of barrier parallel to roadway.
- L4 = Length of barrier parallel to roadway from opposite-side hazard to beginning of barrier flare.
- L5 = Distance from center line of roadway to portion of barrier parallel to roadway. Note: if the hazard is outside of the Design Clear Zone when measured from the center line, it may only be necessary to provide a crashworthy end treatment for the barrier.
- LH1 = Distance from outside edge of traveled way to back side of adjacent-side hazard. Note: if a hazard extends past the Design Clear Zone, the Design Clear Zone can be used as LH1.
- LH2 = Distance from center line of roadway to back side of opposite-side hazard. Note: if a hazard extends past the Design Clear Zone, the Design Clear Zone can be used as LH1.
- LR = Runout length (measured parallel to roadway).
- X1 = Length of need for barrier to shield an adjacent-side hazard.
- X2 = Length of need for barrier to shield an opposite-side hazard.
- F = Flare rate value.
- Y = Offset distance required at the beginning of the length of need.

**Different end treatments require different offsets.**

For the SRT 350 and FLEAT 350, use Y = 1.8 ft.

For evaluating existing BCT's, use Y = 1.8 ft.

For the FLEAT TL-2, use Y = 0.8 ft.

No offset is required for the nonflared terminals, or impact attenuator systems. Use Y = 0.

Buried terminal end treatments are used with barrier flares and have no offset. Use Y = 0.

Design Parameters							
Posted Speed (mph)	ADT				Rigid Barrier	Unrestrained Barrier	Semirigid Barrier
	Over 10,000	5,000 to 10,000	1,000 to 4,999	Under 1,000			
	LR (ft)	LR (ft)	LR (ft)	LR (ft)	F	F	F
70	460	395	345	295	20	18	15
60	360	295	260	230	18	16	14
55	310	260	230	195	16	14	12
50	260	215	180	165	14	12	11
45	245	195	165	150	12	11	10
40	215	180	150	130	11	10	9

**Barrier Length of Need**  
*Figure 710-11b*

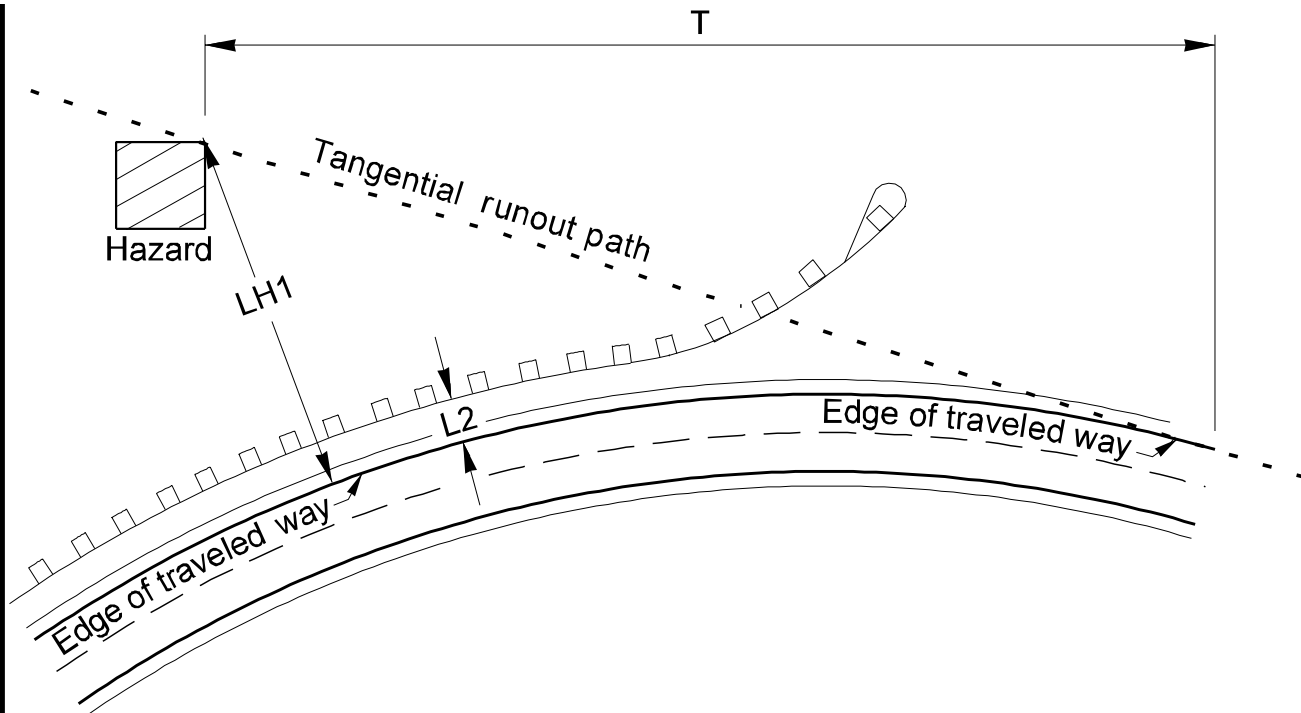

Note:

This is a graphical method for determining the length of need for barrier on the outside of a curve. On a scale drawing, draw a tangent from the curve to the back of the hazard. Compare T to LR from Figure 710-11b and use the shorter value.

If using LR, follow Figures 710-11a and b.

If using T, draw the intersecting barrier run to scale and measure the length of need.

### Barrier Length of Need on Curves

Figure 710-11c

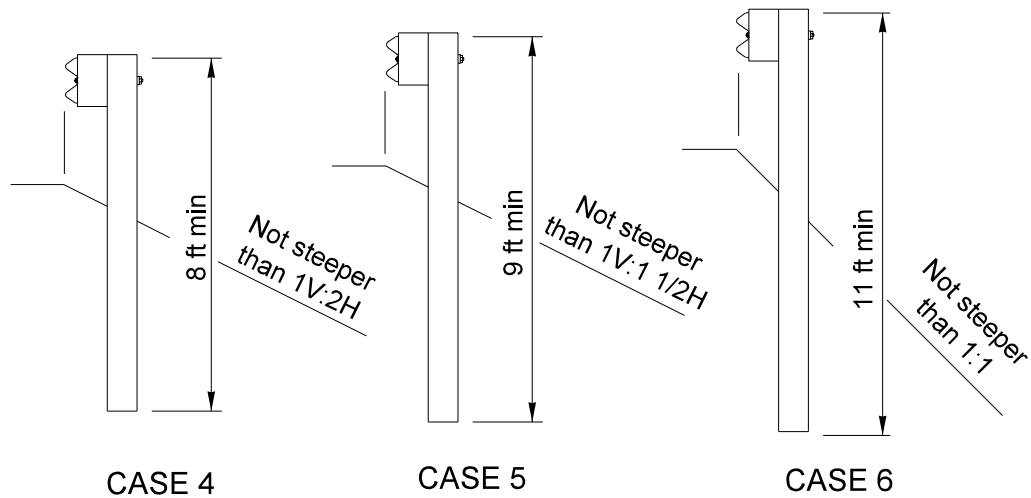
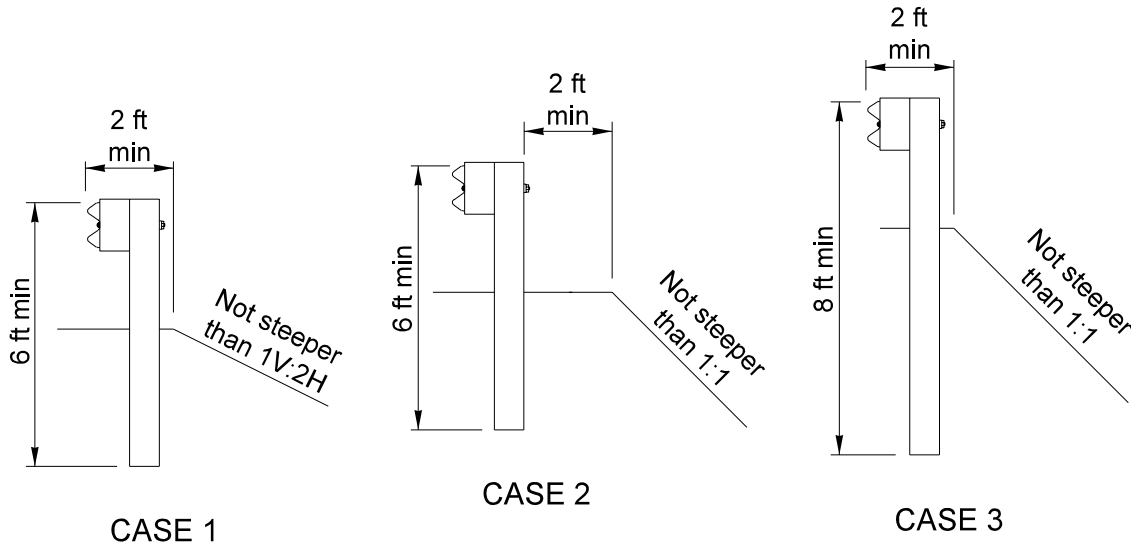

Notes:

Use cases 1, 2, and 3 when there is 2 ft or greater shoulder widening from face of guardrail to the breakpoint.

Use cases 4, 5, and 6 when there is less than 2 ft shoulder widening from face of guardrail to the breakpoint.

**Beam Guardrail Post Installation**

*Figure 710-12*

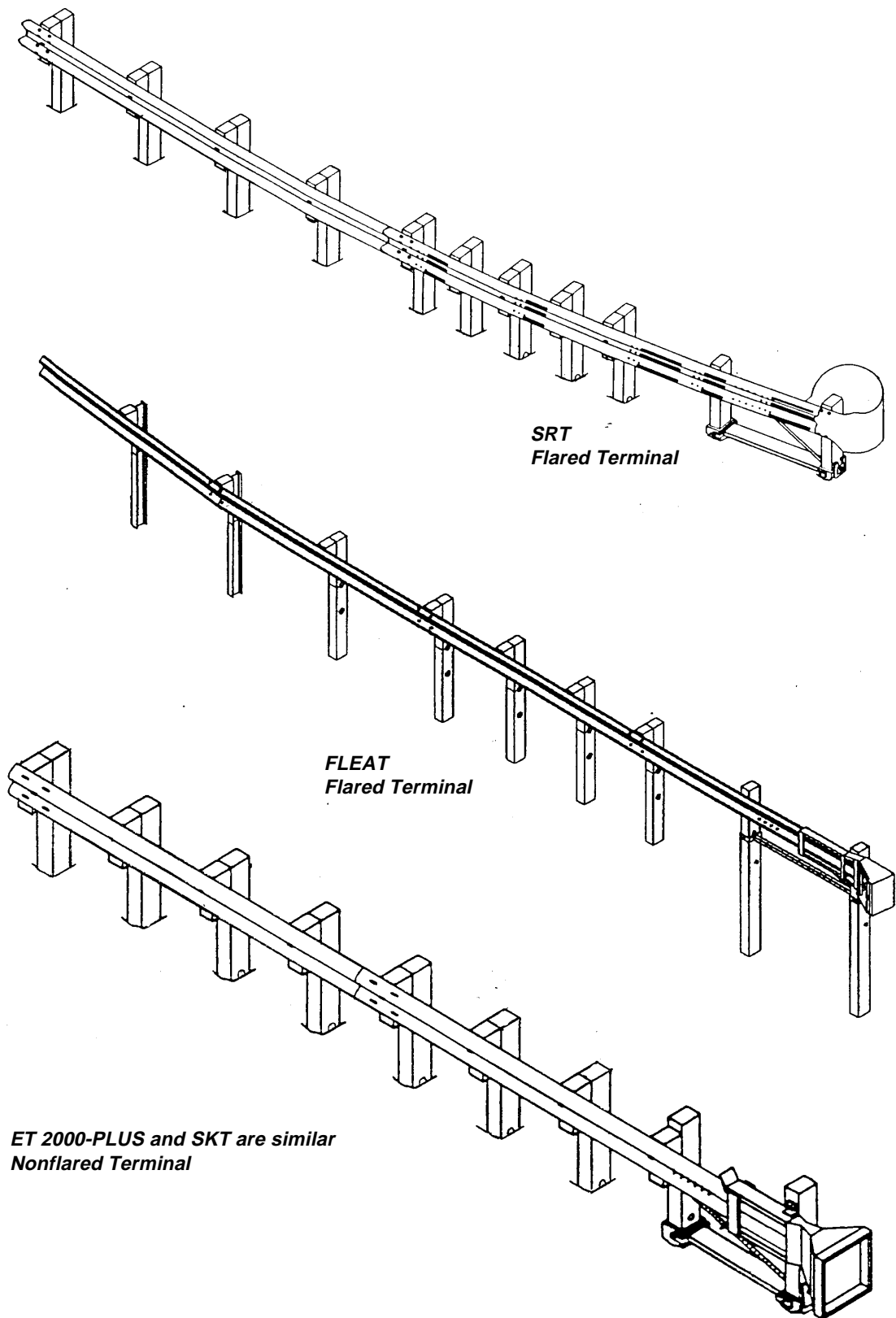

**SRT  
Flared Terminal**

**FLEAT  
Flared Terminal**

**ET 2000-PLUS and SKT are similar  
Nonflared Terminal**

**Beam Guardrail Terminals**  
*Figure 710-13*

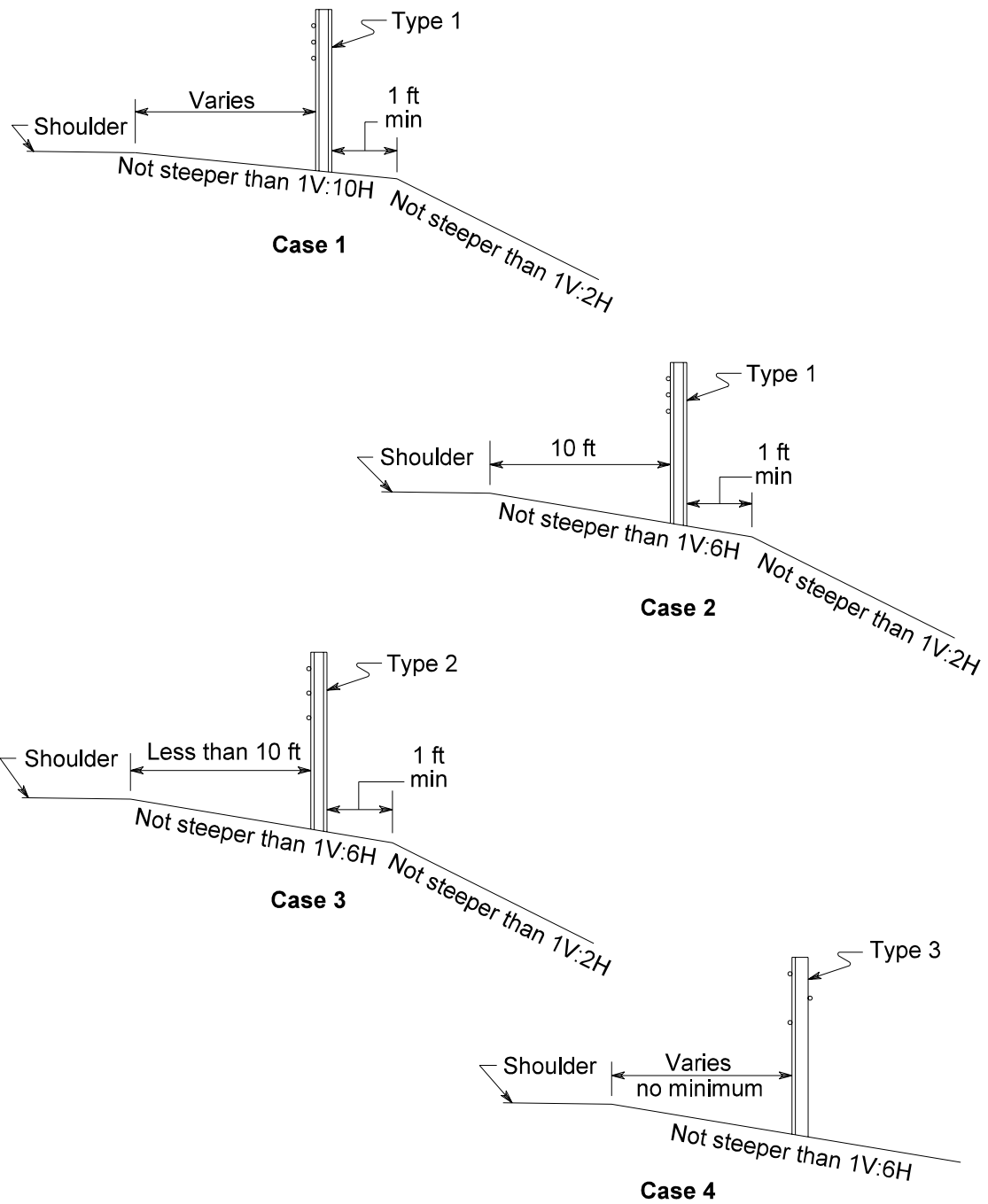

**Cable Barrier Locations on Slopes**  
*Figure 710-14*

		Concrete Bridge Deck		Wood bridge deck or Low Strength Concrete Deck
Curb Width		Concrete Bridge Rail (existing)	Steel or Wood Post Bridge Rail (existing)	Service Level 1 Bridge Rail <sup>2</sup>
18 in or less		Thrie beam mounted to existing bridge rail and blocked out to the face of curb Height = 32 in	Thrie beam mounted to steel posts <sup>2</sup> at the face of curb Height = 32 in	
Greater than 18 in	Bridge width more than 28 ft (curb-to-curb)	Thrie beam mounted to steel posts <sup>2</sup> at the face of curb <sup>1</sup> Height = 32 in		Height = 32 in
	Bridge width 28 ft (curb-to-curb) or less	Thrie beam mounted to existing bridge rail Height = 35 in	Thrie beam mounted to steel posts <sup>2</sup> in line with existing rail Height = 35 in	Curb or wheel guard must be removed

<sup>1</sup>Thrie beam may be mounted to the bridge rail to accommodate pedestrians (height = 35 in).

<sup>2</sup>Contact the Bridge and Structures Office for the post connection details and to determine if the existing bridge deck and other superstructure elements are of sufficient strength.

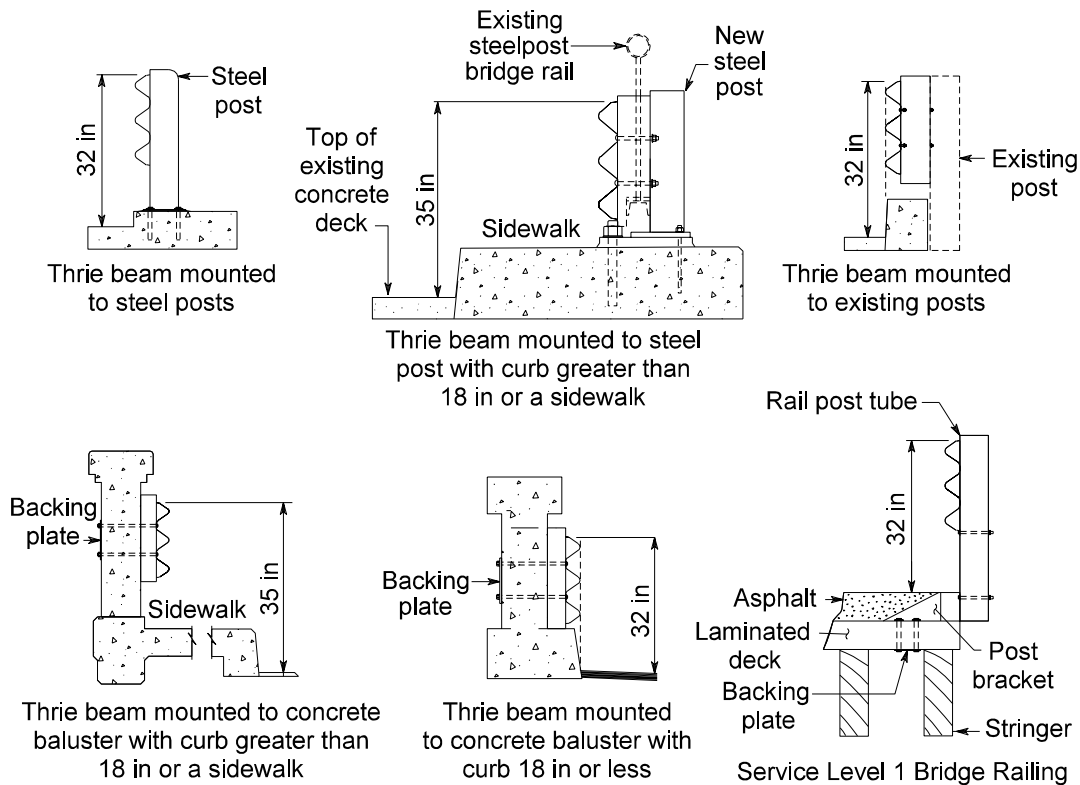

**Thrie Beam Bridge Rail Retrofit Criteria**  
Figure 710-15

720.01	Impact Attenuator Systems
720.02	Design Criteria
720.03	Selection
720.04	Documentation

### 720.01 Impact Attenuator Systems

Impact attenuator systems are protective systems that prevent errant vehicles from impacting hazards by either gradually decelerating the vehicle to a stop when hit head-on, or by redirecting it away from the hazard when struck on the side. These barriers are used to shield rigid objects or hazardous conditions that cannot be removed, relocated, or made breakaway. Approved systems are shown on Figures 720-2 through 4 and are described as follows:

#### (1) Permanent Installations

- Crash Cushion Attenuating Terminal (CAT).** The CAT is an end treatment for beam guardrail. It can also be used for concrete barrier if a transition is provided. It is 31.25 ft long and consists of slotted w-beam guardrail mounted on both sides of breakaway timber posts. Steel sleeves with soil plates hold the timber posts in place. When hit head-on, the slotted guardrail is forced over a pin that shears the steel between the slots. This shearing dissipates the energy of the impact. When this system is used with a rigid barrier, a transition is required and must be specified in the contract along with the appropriate connection. (See Chapter 710.)
- Brakemaster.** The Brakemaster system is an end treatment for beam guardrail. It can also be used for concrete barrier if a transition is provided. It is 31.5 ft long and consists of telescoping w-beam panels mounted on both sides of steel skids. The system uses a brake and cable device for attenuation and redirection. The cable is embedded in a concrete anchor at the end of the system. A concrete foundation is not required for this system but a paved surface is recommended. When this system is used with a rigid barrier, a transition is required and must be specified in the contract along with the appropriate connection. (See Chapter 710.)
- QuadTrend - 350.** The QuadTrend - 350 is an end treatment for concrete barriers. Its overall length of 20.7 ft allows it to be used at the ends of bridges where a standard beam guardrail installation is not feasible. This system consists of telescoping quadruple corrugated fender panels mounted on steel breakaway posts. Sand-filled boxes attached to the posts dissipate a portion of the energy of the impact. A concrete foundation is required to support the steel posts. An anchored cable installed behind the fender panels directs the vehicle away from the barrier end. A 6H:1V or flatter slope is required behind the barrier to allow for vehicle recovery.
- QuadGuard.** The QuadGuard is an end treatment for concrete barrier and beam guardrail and is also used to mitigate fixed objects up to 7.5 ft in width. A transition is required when it is used with beam guardrail in a location subject to reverse direction impacts. The length of the QuadGuard varies based on the posted speed of the highway (see Figure 720-1.) The QuadGuard system consists of a series of Hex-Foam cartridges surrounded by a framework of steel diaphragms and quadruple corrugated fender panels. It is installed on a concrete slab. Impact energy from end-on hits is absorbed by the internal shearing of the cartridges and the crushing of the energy absorption material. The fender panels redirect vehicles impacting the attenuator on the side.
- QuadGuard Elite.** The QuadGuard Elite is an end treatment for concrete barrier and beam guardrail and is also used to mitigate fixed objects up to 7.5 ft in width. The length of the system is 35.5 ft and consists of telescoping quadruple corrugated fender panels mounted on both sides of a series of polyethylene cylinders. The cylinders are



compressed during a head-on impact and will return to their original shape when the system is reset. The advantage of this system is that it can withstand numerous impacts without requiring extensive repair.

- **Reusable Energy Absorbing Crash Terminal (REACT 350).** The REACT 350 is an end treatment for concrete barriers and is also used to mitigate fixed objects up to 9 ft in width. The length of the REACT 350 varies based on the posted speed of the highway. (See Figure 720-1.) The system consists of polyethylene cylinders with varying wall thicknesses, redirecting cables, a steel frame base, and a backup structure. The system is installed on a concrete foundation. The redirecting cables are anchored in the concrete foundation at the front of the system and in the backup structure at the rear of the system. When hit head-on, the cylinders compress and absorb the impact energy, but the system returns to approximately 80 percent of its original length immediately. For side impacts, the cables restrain the system enough to prevent penetration and redirect the vehicle. It is anticipated that this system will require very few replacement parts or extensive repair.
- **Inertial Barrier.** Inertial barrier is an end treatment for concrete barrier and is also used to mitigate fixed objects. This system consists of an array of plastic containers filled with varying weights of sand. The length of inertial barrier arrays vary based on the posted speed of the highway (see Figure 720-1.) The inertial barriers slow an impacting vehicle by the transfer of the momentum of the vehicle to the mass of the barrier. This system is not suitable where space is limited to less than the widths shown in the Standard Plans.

## (2) Work Zone (Temporary) Installation

- **Construction Zone Guard Rail Energy Absorption Terminal (G-R-E-A-T cz).** The G-R-E-A-T cz is an end treatment for beam guardrail and concrete barrier subject to one way flow. This system consists of a series of Hex-Foam cartridges aligned by a cable and
- **diaphragm system installed on a portable support platform.** The perimeter is shielded by lapped thrie beam to redirect vehicles impacting the attenuator on the side. Impact energy from end-on hits is absorbed by internal shearing of the cartridges and crushing of the energy absorption material. The platform is anchored by bolts set in concrete (6 in minimum depth) or by anchor pins. Anchor pins may only be used on 3 in minimum depth asphalt concrete surfaces that have a prepared compacted subbase. This system is easily moved to a new site without heavy equipment.
- **Advanced Dynamic Impact Extension Module II (ADIEM II).** The ADIEM II is an end treatment for concrete barrier. Other uses may require a special transition design. The system is 30 ft long and consists of 10 lightweight concrete modules on an inclined base. The energy of an impact is dissipated as the concrete modules are crushed. An inclined base provides a track for placement of the modules and provides redirection for side impacts. At this time the use of the ADIEM II is limited to temporary installations. Existing permanent installations are experimental and are being used to evaluate long-term durability. Existing permanent units may be reset.
- **QuadGuard cz.** This system is like the permanent QuadGuard listed in (1) above except that it can be installed on a 6 in minimum depth asphalt concrete surface that has a 6 in minimum depth compacted base.
- **Reusable Energy Absorbing Crash Terminal (REACT 350).** This is the same system listed in (1) above except that it can be installed on a 4 in minimum depth asphalt concrete surface that has a 6 in minimum depth compacted base.
- **Non-Redirecting Energy Absorbing Terminal (N-E-A-T).** The N-E-A-T system is a is an end treatment for temporary concrete barrier where vehicle speeds are 45 mph or less. The system is 9.7 ft long and consists of aluminum cells encased in an aluminum

shell with steel backup, attachment hardware, and transition panels. The energy of an impact is dissipated as the aluminum cells are crushed.

- **Inertial Barrier.** This is the same system listed in (1) above. It is not suitable where space is limited to less than the widths shown in the Standard Plans.
- **Truck-Mounted Attenuator (TMA).** TMAs are portable systems used in work zones. For more information on these systems, see the *Traffic Manual*.

### (3) Older Systems

The following systems are in use on Washington State highways and may be left in place or reset. New installations of these systems require approval from the Olympia Service Center Design Office.

- **Sentre.** The Sentre is a guardrail end treatment. Its overall length of 17 ft allowed it to be used where space was not available for a standard terminal. The system is very similar to the QuadTrend in both appearance and function except that it uses three beam fender panels instead of the quadruple corrugated panels. This system requires a transition when used to terminate rigid barriers.
- **TREND.** The TREND is an end treatment with a built-in transition and was used at the end of rigid barriers including bridge rails. The system is similar to the QuadTrend except that it used three beam fender panels.
- **G-R-E-A-T (Guard Rail Energy Absorption Terminal).** This system was primarily used as an end treatment for concrete barrier. It is similar to the QuadGuard except that it used three beam fender panels.
- **Low Maintenance Attenuator System (LMA).** The LMA is an end treatment for concrete barrier and beam guardrail and was also used to mitigate fixed objects up to 3 ft in width. The system is similar to the QuadGuard Elite except that it used three beam fender panels and rubber cylinders.

- **Hex-Foam Sandwich.** The Hex-Foam Sandwich system is an end treatment for beam guardrail and concrete barrier and was also used to mitigate fixed objects 3 ft or more in width. This system consists of a number of Hex-Foam cartridges containing an energy absorption material separated by a series of diaphragms and restrained by anchor cables. It is installed on a concrete slab. Impact energy is absorbed by the internal shearing of the cartridges and crushing of the energy absorption material. Lapped panels on the perimeter serve to redirect vehicles on side impacts.

### 720.02 Design Criteria

The following design criteria apply to all new or reset, permanent and temporary impact attenuators. They also apply to existing systems to be left in place when the Barrier Terminals and Transition Sections column on a design matrix applies to the project. See Chapter 325.

Impact attenuators must be placed so that they do not present a hazard to the opposing traffic. For median and reversible lane locations, the backup structure or attenuator-to-object connection must be designed to prevent opposing traffic from being snagged. It is desirable that all existing curbing be removed and the surface smoothed with asphalt or cement concrete pavement before an impact attenuator is installed. However, curbs 100 mm or less in height may be retained depending on the practicality of their removal.

If the site has excessive grade or cross slope, additional site preparation or modification to the units in accordance with the manufacturer's literature is required. Excessive is defined as steeper than 5 percent for inertial barriers and Hex-Foam Sandwich units and steeper than 8 percent for the QuadGuard, QuadGuard Elite, ADIEM II, and REACT 350 systems. All other systems must have a 10H:1V or flatter slope between the edge of the traveled way and the near face of the unit.

In general, except the inertial barriers, attenuators are aligned parallel to the roadway.

Whenever possible, inertial barriers are aligned so that an errant vehicle deviating from the roadway by 10 degrees would be on a parallel path with the attenuator alignment. (See the Standard Plans.) Also, inertial barriers do not provide any redirection and are not appropriate where high angle impacts are likely.

Inertial barrier configurations are shown in the Standard Plans. If a situation is encountered where the configurations in the Standard Plans are not appropriate, contact the Olympia Service Center Design Office if further information is desired.

### 720.03 Selection

When selecting an impact attenuator system, consider the following:

- Posted speed
- Available space (length and width)
- Maintenance costs
- Initial cost

The posted speed is a consideration for the QuadGuard, REACT 350 (narrow model only), G-R-E-A-T cz, and the inertial barrier systems only. Use Figure 720-1 to select the size of the system required for the legal posted speed.

Posted Speed (mph)	QuadGuard (Bays)	REACT 350 (Cylinders)	G-R-E-A-T cz (Bays)	Inertial Barriers (Type)
40 or less	3	4	3	1
45	4	6	6	2
50	5	6	6	3
55	6	9	6	4
60	6	9	6	5
65	8	9	6	6
70	9	11	6	6

#### Impact Attenuator Sizes

Figure 720-1

If it is anticipated that a large volume of traffic will be traveling at speeds greater than the posted speed limit, then the next larger unit can be specified.

See Figure 720-5 for a summary of space, and initial cost information related to the impact attenuator systems.

When considering maintenance costs, anticipate the average annual hit rate. If few impacts are anticipated, lower cost devices such as inertial barriers might meet the need. Inertial barriers have the lowest initial cost and initial site preparation. However, maintenance will be costly and necessary after every hit. Labor and equipment are necessary to clean up the debris and install new containers (barrels). Also, inertial barriers must not be used where flying debris may be a danger to pedestrians.

The REACT 350 and the QuadGuard Elite have a higher initial cost, requiring substantial site preparation, including a backup or anchor wall in some cases and cable anchorage at the front of the installation. However, repair costs are comparatively low, with labor being the main expense. No maintenance may be required after minor side impacts with these systems.

For new installations where at least one impact is anticipated per year, limit the selection of impact attenuators to the low maintenance devices (QuadGuard Elite and REACT 350). Consider upgrading existing ADIEM, G-R-E-A-T, and Hex Foam impact attenuators with these low maintenance devices when the repair history shows one to two impacts per year over a three to five year period.

One consideration that must not be overlooked in selecting a system is how dangerous it will be for the workers making repairs. Some systems require nearly total replacement or replacement of critical components (such as cartridges or braking mechanisms) after a head-on impact, while others only require resetting. In areas with a high exposure to danger, a system that can be repaired quickly is most desirable.

When specifying the system or systems that can be used at a specific location, the list shown in Figure 720-5 is to be used as a starting point. As the considerations discussed previously are analyzed, the inappropriate systems are eliminated and the remaining systems are to be specified. When the site conditions vary, it may be necessary to have more than one list of acceptable systems within a contract. Systems are not to be eliminated without documented reasons. Also, wording such as 'or equivalent' is not to be used

when specifying these systems. If only one system is found to be appropriate, then approval from the Assistant State Design Engineer of a public interest finding for the use of a sole source proprietary item is required.

When a transition to connect with a concrete barrier (see Figure 720-5) is required, the transition type and connection must be specified and are included in the cost of the impact attenuator. See Chapter 710 for information on the transitions and connections to be used.

Contractors can be given more flexibility in the selection of work zone (temporary) systems, since long-term maintenance and repair are not a consideration.

## Documentation

The following documents are to be preserved in the project file. See Chapter 330.

- Approvals for use of older systems
- Documentation of reasons for eliminating attenuator options
- Approvals of public interest findings regarding sole source proprietary systems

*P65:DP/DME*

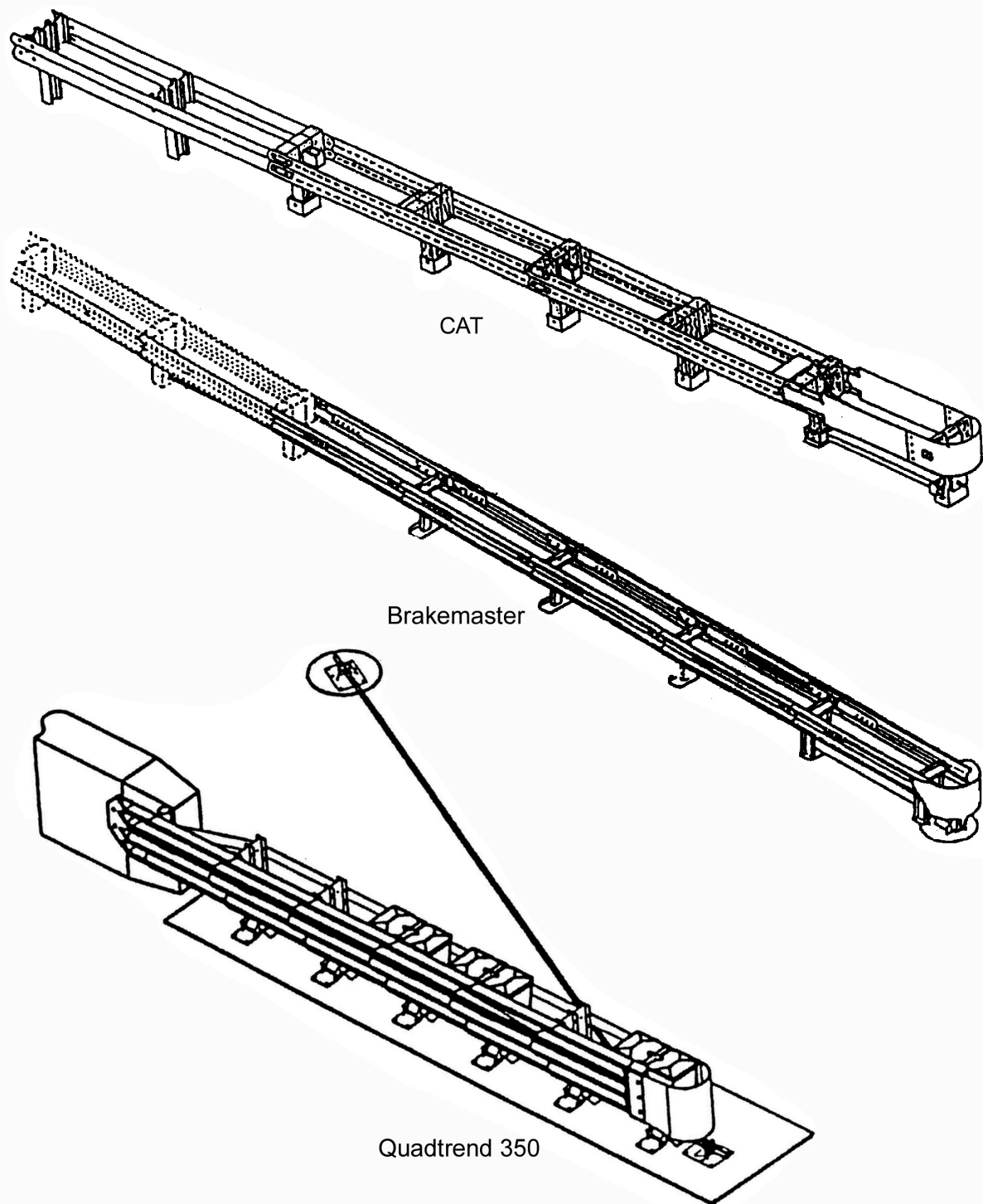

**Impact Attenuator Systems — Permanent Installations**  
*Figure 720-2a*

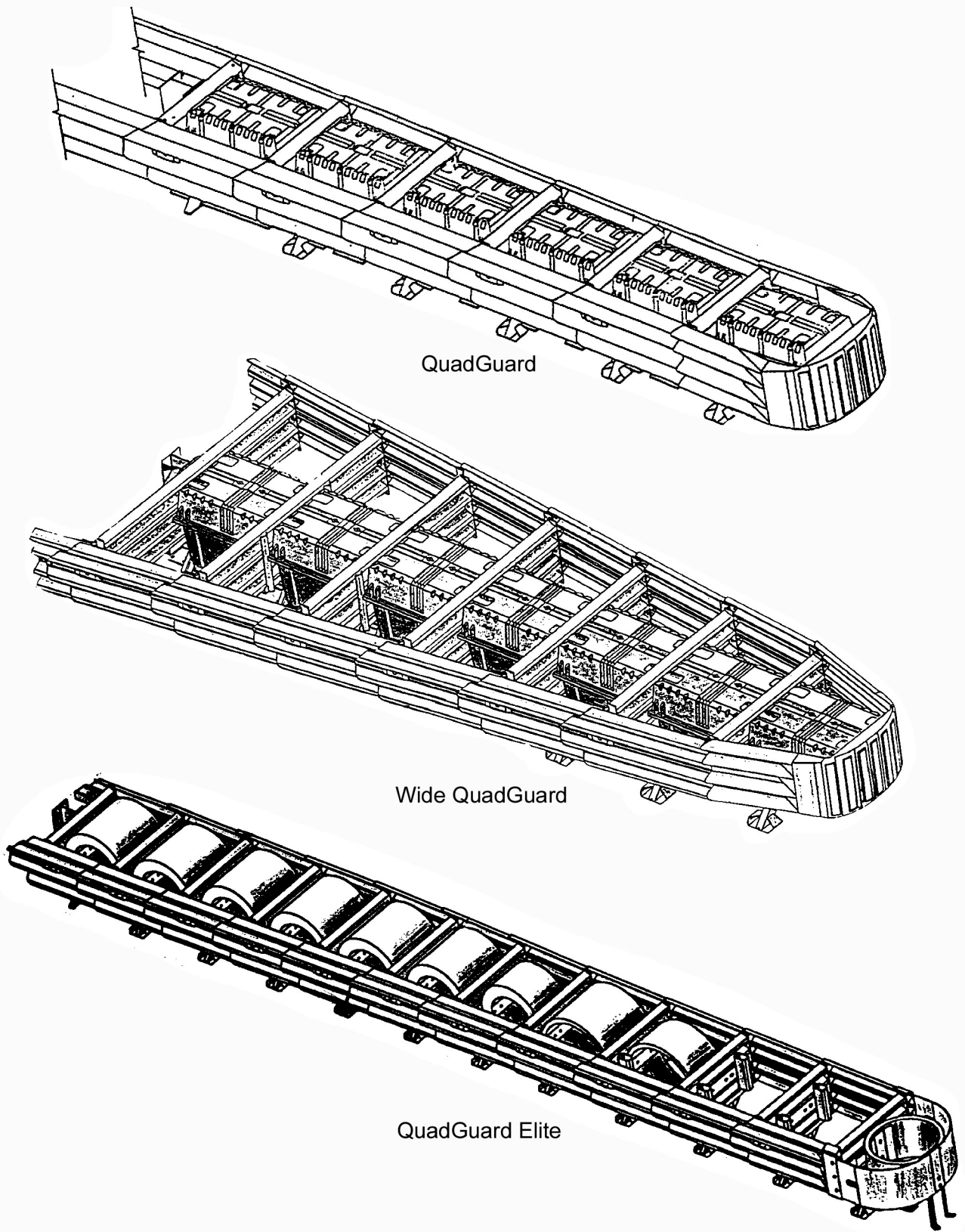

**Impact Attenuator Systems — Permanent Installations**  
*Figure 720-2b*

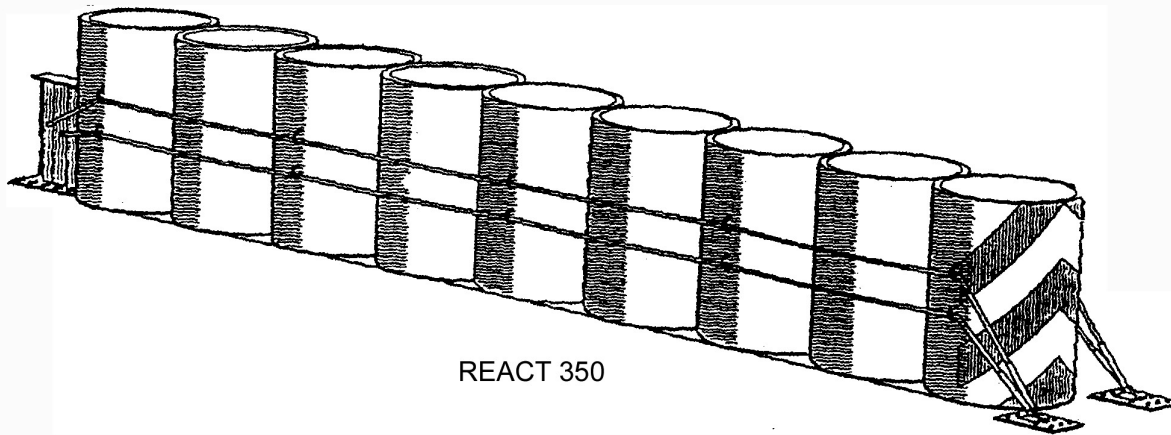

REACT 350

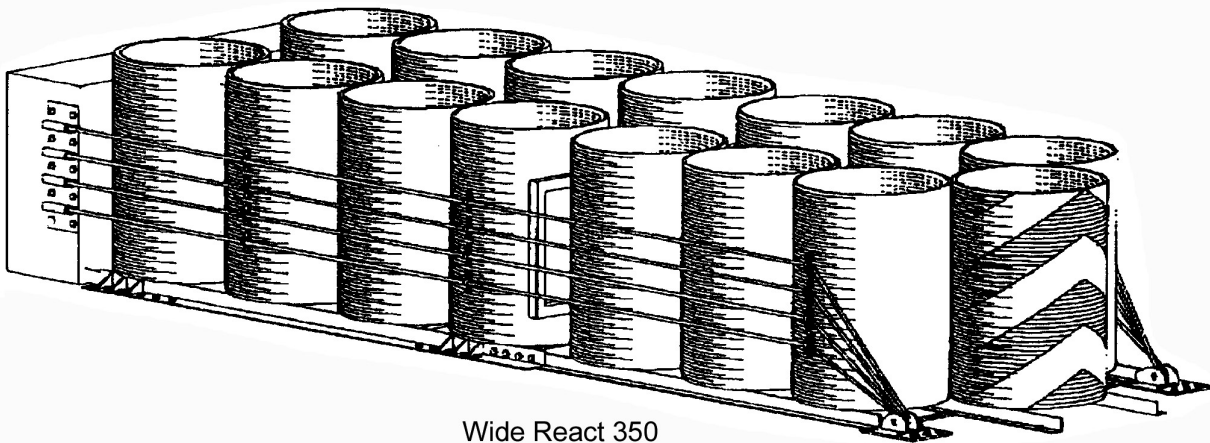

Wide React 350

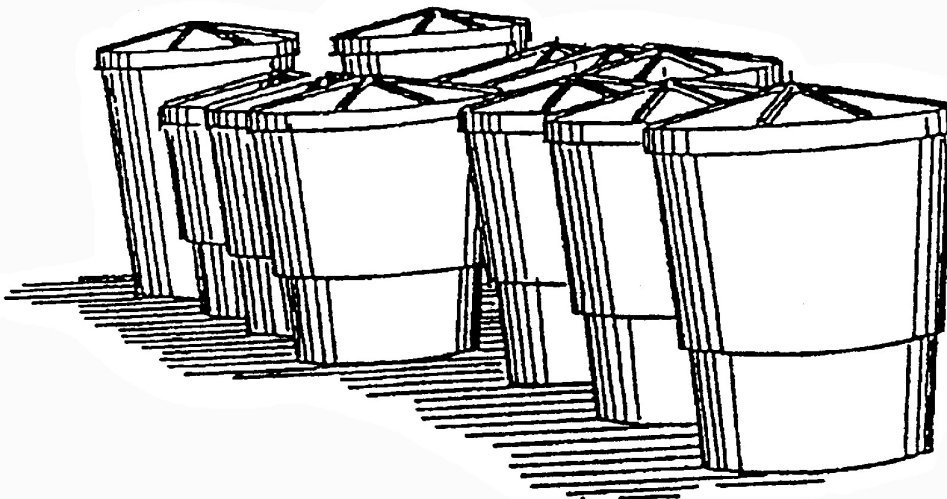

Inertial Barrier

**Impact Attenuator Systems — Permanent Installations**  
*Figure 720-2c*

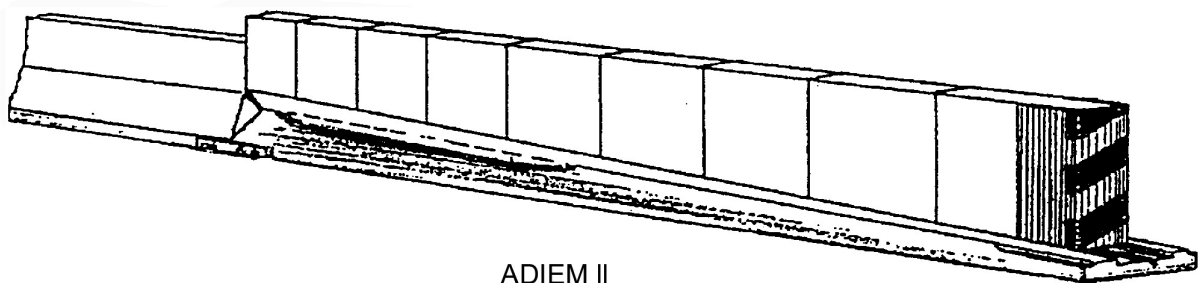

ADIEM II

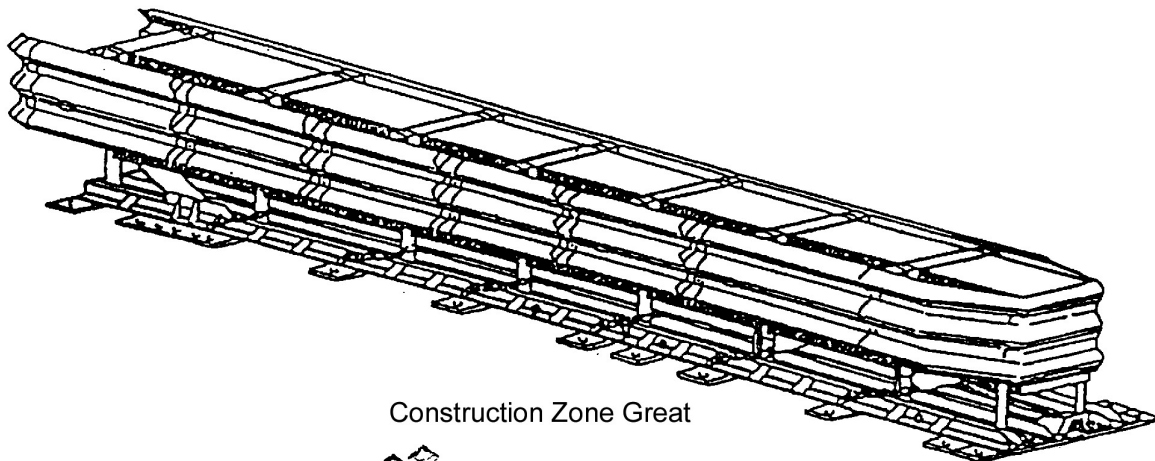

Construction Zone Great

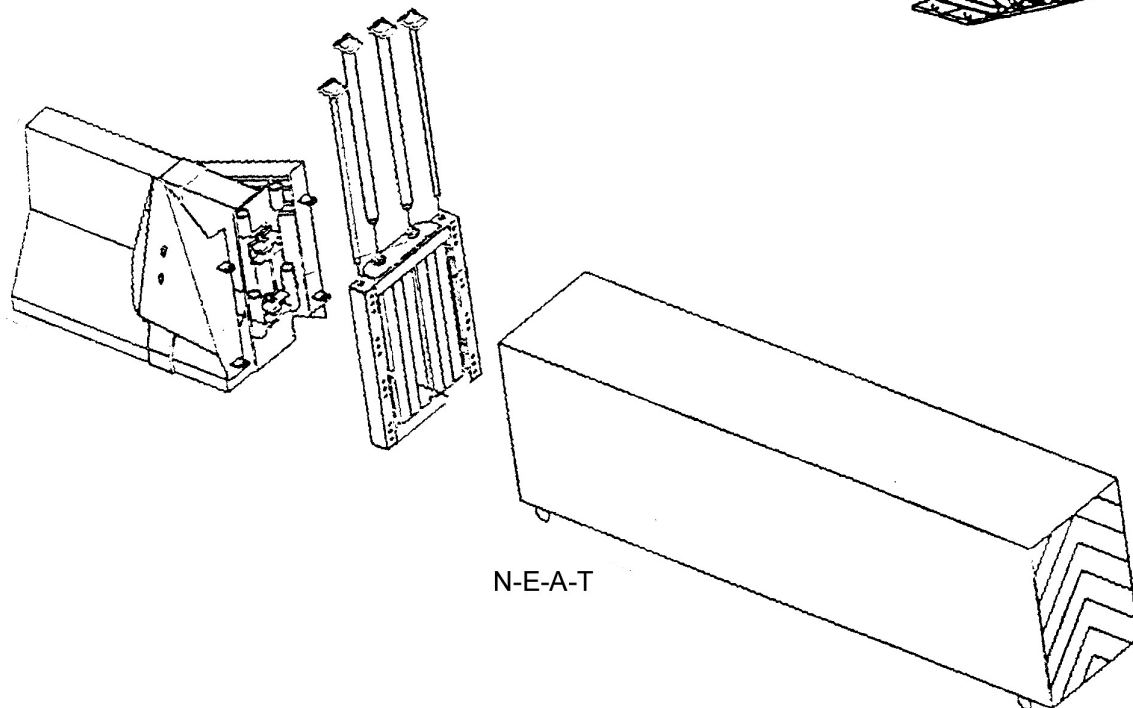

N-E-A-T

**Impact Attenuator Systems — Work Zone Installations**  
*Figure 720-3*



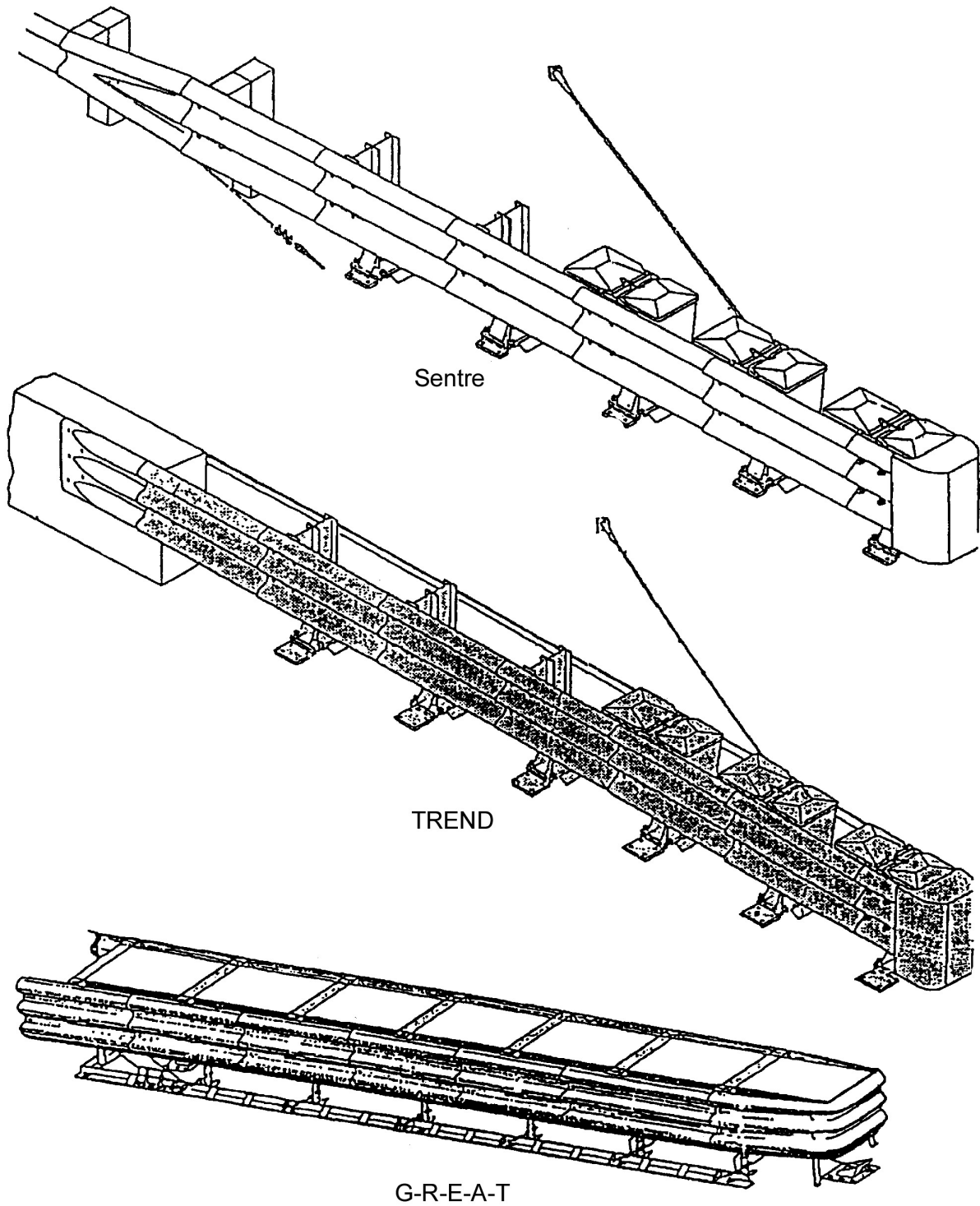

**Impact Attenuator Systems — Older Systems**  
*Figure 720-4a*

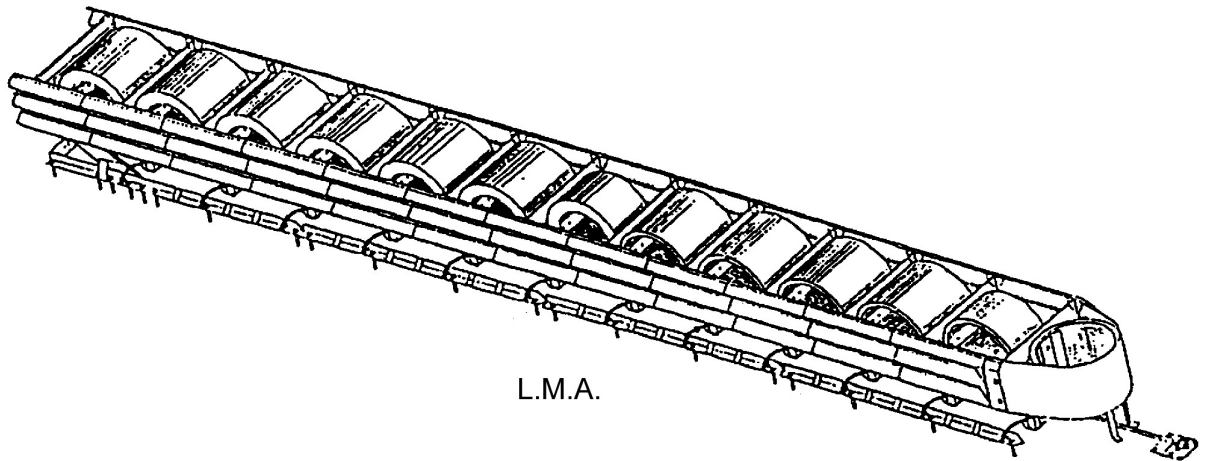

L.M.A.

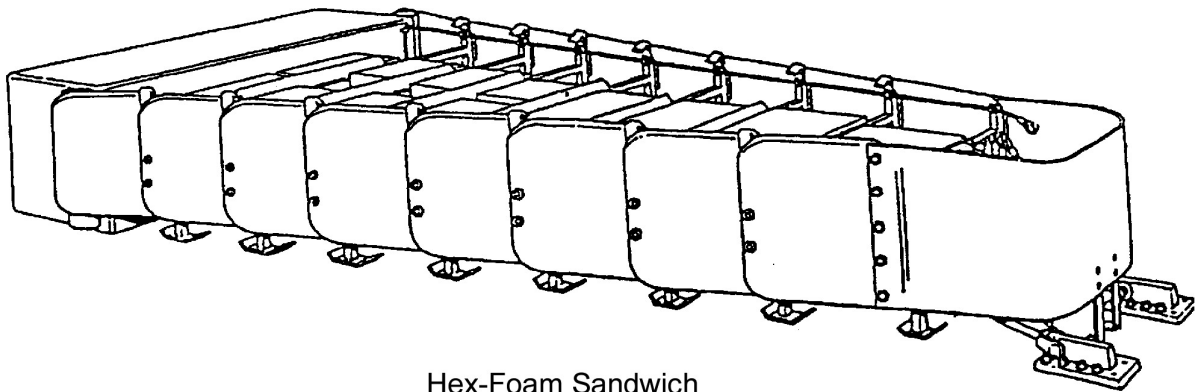

Hex-Foam Sandwich

**Impact Attenuator Systems — Older Systems**  
*Figure 720-4b*

## Impact Attenuator Systems

(All dimensions are in feet)

System	(Permanent, (T)emporary, (B)oth)	Width	Length	Transition to Rigid System Required	Distance Beyond Length of Need	Initial Cost Category	Manufacturer
CAT <sup>(2)</sup>	P	2	31.25	YES	18.8	A	SYRO, Inc.
Brakemaster <sup>(2)</sup>	P	2	31.5	YES	15.8	A	Energy Absorption Systems, Inc.
QuadTrend - 350 <sup>(6)</sup>	P	2	20.7	NO	10.5	A	Energy Absorption Systems, Inc.
QuadGuard	B	2, 2.5, 3, 5.75, 7.5	12 - 30 <sup>(4)</sup>	NO	3.3	C <sup>(5)</sup>	Energy Absorption Systems, Inc.
QuadGuard Elite	P	2, 2.5, 3, 5.75, 7.5	35.5	NO	3.3	D	Energy Absorption Systems, Inc.
REACT 350	B	3	15.25 - 36.25 <sup>(4)</sup>	NO	4.3	C <sup>(5)</sup>	Roadway Safety Service, Inc.
Wide REACT 350	B	6 - 9	23.25	NO	4.3	D <sup>(5)</sup>	Roadway Safety Service, Inc.
Inertial Barriers	B	7	17 - 30 <sup>(4)</sup>	NO	(2)	A <sup>(5)</sup>	(3)
ADIEM II <sup>(7)</sup>	T	2	30	NO	14.1	B	SYRO, Inc.
GREAT cz <sup>(9)</sup>	T	2.5	12, 21	NO	(2)	C <sup>(5)</sup>	Energy Absorption Systems, Inc.
N-E-A-T <sup>(8)</sup>	T	1.9	9.7	NO	(2)	C <sup>(5)</sup>	Energy Absorption Systems, Inc.

### Initial Cost Categories:

A (\$5,000 to \$8,000); B (\$9,000 to \$14,000); C (\$15,000 to \$25,000); D (\$25,000 to \$40,000)

- 1) Generally for use with double sided beam guardrail. Use as an end treatment for concrete barrier requires a transition.
- 2) The GREAT cz, inertial barriers, and N-E-A-T may only be used beyond the required barrier length of need.
- 3) There are 3 manufacturers of inertial barriers:
  - Energy Absorption Systems, Inc.
  - Roadway Safety Service, Inc.
  - TraFFix Devices, Inc.
- 4) See Figure 720-1 for sizes or configuration type.
- 5) The length of the QuadGuard, REACT 350, and inertial barriers varies since their design is dependent upon speed. For a typical 60 mph design, the QuadGuard design would be 21 ft, the REACT 350 would be 31 ft, and the inertial barriers would be 30 ft. Costs indicated are for a typical 60 mph design.
- 6) Generally for use at the ends of bridges where a standard beam guardrail installation is not feasible.
- 7) Generally for use with concrete barrier. Other uses may require a special transition design.
- 8) Use limited to highways with posted speeds of 45 mph or less.
- 9) Limit to one-way traffic flow.

### Impact Attenuator Comparison

Figure 720-5

### 810.01 General

The purpose of this chapter is to describe the procedures for planning construction work zone traffic control. It is important that a construction work zone traffic control strategy be identified early in project development so that its effect can be considered in the design of a project and used later in developing the traffic control plan for the PS&E.

Primary consideration should be given to worker safety within the work zone, while at the same time, providing for the safe and timely passage of nonconstruction traffic.

### 810.02 References

*Traffic Manual*, M 51-02

*Standard Plans for Road, Bridge and Municipal Construction*, M 21-01

*Plans Preparation Manual*, M 22-31

*Traffic Control Devices Handbook*, FHWA

*Manual on Uniform Traffic Control Devices for Streets and Highways*, M 24-01

### 810.03 Definitions

**construction work zone traffic control (CWZTC) strategy** A general scheme by which traffic can be controlled through or around a construction work zone.

**traffic control plan** Drawing(s) and special provisions developed as part of PS&E showing how traffic will operate and be controlled during construction. The plan includes the locations of the roadway, detour routes, temporary or portable bridges, cross-roads, ramps, pavement markings, signs, signals, and other traffic control devices.

### 810.04 Construction Work Zone Traffic Control Strategy

The CWZTC strategy may contain, for example, the following:

- The number of lanes or areas of the roadway that can be closed.
- The hours of the day when work can occur.
- The days of the week when work can occur.
- The level of service to be provided to motorists during construction.
- The need for night operations.
- The influence on other streets in the network.
- The general impact of the selected construction work zone traffic control strategy on, for example, the traveling public, the contractor, construction work forces, costs.
- Other special site related conditions (e.g. special events).
- Public and local jurisdiction information plans.

See the *Traffic Manual* for guidance in preparing the CWZTC strategy.

#### (1) Use of Law Enforcement in Work Zones

The initial determination for the use of law enforcement should be based on evaluation of the work zone by the Maintenance/Construction Office and the region Traffic Office. The evaluation should consider the type of construction activity, complexity of the traffic control plan, possible speed reduction needs, traffic volumes, nighttime work activity, geometric conditions, associated cost for the use of enforcement (cost benefit analysis), and actual traffic problems observed as the work progresses.

Refer to the *Traffic Manual* for recommended enhanced enforcement in the work zone.

**(2) Work Zone Traffic Control Design Checklist**

A checklist has been developed to assist the designer in developing the work zone traffic control strategy. Refer to the *Traffic Manual* for this checklist.

**810.05 Procedures**

The following procedures must be used for all projects:

**(1) Design Conference**

A design conference, also attended by the district traffic engineer, law enforcement officials, and a construction project engineer, must be held early in design report preparation to discuss construction work zone traffic control strategy options and to select and develop those options that appear feasible.

The options developed for the CWZTC strategy should provide adequate safety for motorists and workers, minimize travel time delays and other negative traffic related impacts while providing an acceptable level of service, and consider project constructibility and costs.

**(2) Design Report**

The design report must contain the following items:

- A brief summary of the construction work zone traffic control strategy as developed during the design conference.
- A description of and the basis for the CWZTC strategy developed during project design.

**(3) Contract Preparation**

Based on the CWZTC strategy contained in the design report, conduct studies and analyses to evaluate the impacts and verify the feasibility of the strategy, and develop the strategy to be included in the traffic control plan.

The PS&E package must include bid items, special provisions, and traffic control drawings. See the *Traffic Manual* for guidance in developing the specific traffic control plans.

See also the *Standard Plans* and the *Plans Preparation Manual*.

810:P:DM8

820.01	General
820.02	References
820.03	Design Components
820.04	Overhead Installation
820.05	Mileposts
820.06	Guide Sign Plan
820.07	Documentation

### 820.01 General

Signing is a primary mechanism for regulating, warning, and guiding traffic. Signing must be in place when any section of highway is open to the motoring public. Each highway project has unique and specific signing requirements. For statewide signing uniformity and continuity, it is sometimes necessary to provide signing beyond the project limits. Design characteristics of the facility determine the size and legend for a sign. As the design speed increases, larger sign sizes are necessary to provide adequate message comprehension time. The MUTCD, the *Traffic Manual*, and the *Sign Fabrication Manual* contain standard sign dimensions, specific legends, and reflective sheeting types for all new signs. Guide signing provides the motorist with guidance to destinations. This information is always presented in a consistent manner. In some cases, there are specific laws, regulations, and policies governing the content of the messages on these signs. All proposed guide signs for a project require the approval of the region's Traffic Engineer. The use of nonstandard signs is strongly discouraged and their use requires the approval of the State Traffic Engineer.

The Design Matrices identify the design levels for signing on all preservation and improvement projects. These levels are indicated in the column "Signing" for Interstate main line and the column "Signing, Delineation, and Illumination" for all other routes.

Review and update existing signing within the limits of all preservation and improvement projects as indicated in the matrices. Provide standard signing on projects with either a "B"

(basic design level) or "EU" (evaluate upgrade) matrix designation by applying the following criteria to determine the need to replace or modify existing signs:

- Lack of nighttime retroreflectivity.
- Substantial damage, vandalism, or deterioration.
- Age of signs (seven to ten years old).
- A change in sign use policy.
- Improper location.
- Message or destination changes necessary to satisfy commitments to public or local agencies.
- Substandard mounting height.
- Change in jurisdiction, for example a county road becomes a state route.

Address sign support breakaway features when identified in the "Clear Zone" columns of the Matrices. When the "F" (full design level) matrix designation is present, the preceding criteria are still applicable and all existing signing is required to conform to the current policy for reflective sign sheeting requirements. Remove or replace signing not conforming to this policy.

### 820.02 References

Revised Code of Washington (RCW) 47.36.030, Traffic control devices

*Manual on Uniform Traffic Control Devices for Streets and Highways* (MUTCD), USDOT, Washington DC, 1988, including the *Washington State Modifications to the MUTCD*, M 24-01, WSDOT, 1996

*Traffic Manual*, M 51-02, WSDOT

*Sign Fabrication Manual*, M 55-05, WSDOT

*Standard Plans for Road, Bridge, and Municipal Construction* (Standard Plans), M 21-01, WSDOT

*Standard Specifications for Road, Bridge, and Municipal Construction* (Standard Specifications), M 41-10, WSDOT

*Plans Preparation Manual*, M 22-31, WSDOT

Directive D 32-20, "State Route Mileposts," WSDOT

## **820.03 Design Components**

### **(1) Location**

The MUTCD contains the guidelines for positioning signs. Check sign locations to ensure that the motorist's view of the sign is not obscured by other roadside appurtenances. Also, determine if the proposed sign will obstruct the view of other signs or limit the motorist's sight distance of the roadway. Reposition existing signs, when necessary, to satisfy these visibility requirements. Where possible, locate signs behind existing traffic barriers, on grade separation structures, or where terrain features will minimize their exposure to errant vehicles.

### **(2) Longitudinal Placement**

The MUTCD and the *Traffic Manual* provide guidelines for the longitudinal placement of signs that are dependent on the type of sign. Select a location to fit the existing conditions to ensure visibility and adequate response time. In most cases, signs can be shifted longitudinally to enhance safety without compromising their intended purpose.

### **(3) Lateral Clearance**

The MUTCD contains minimum requirements for the lateral placement of signs. These requirements are shown in Figures 820-1a and 820-1b. When possible, position the signs at the maximum practical lateral clearance for safety and reduced maintenance costs. Locate large guide signs and motorist information signs beyond the Design Clear Zone, when limited right of way or other physical constraints are not a factor. See Chapter 700. On steep fill slopes, an errant vehicle is likely to be partially airborne from the slope break near the edge of shoulder to a point 12 ft down the slope. When signs are placed on fill slopes steeper than 6:1, locate the support at

least 12 ft beyond the slope break. Use breakaway sign support features, when required, for signs located within the Design Clear Zone and for signs located beyond this zone where there is a possibility they might be struck by an errant vehicle. Breakaway features are not necessary on sign posts located behind traffic barriers. Install longitudinal barrier to shield signs without breakaway features within the Design Clear Zone when no other options are available.

Sign bridges and cantilever sign structures have limited span lengths. Locate the vertical components of these structures as far from the traveled way as possible and, where appropriate, install traffic barriers or land forms. See Chapter 710.

Do not locate sign posts in the bottom of a ditch or where the posts will straddle the ditch. The preferred location is beyond the ditch or on the ditch backslope. In high fill areas, where conditions require placement of a sign behind a traffic barrier, consider adding embankment material to reduce the length of the sign supports.

### **(4) Sign Heights**

For ground-mounted signs installed at the side of the road, provide a mounting height of at least 7 ft, measured from the bottom of the sign to the edge of traveled way. Supplemental plaques, when used, are mounted directly below the primary sign. At these locations, the minimum mounting height of the plaque is 5 ft.

Do not attach supplemental guide signs to the posts below the hinge mechanism or saw cut notch on multiple post installations. The location of these hinges or saw cuts on the sign supports are shown in the Standard Plans.

A minimum 7 ft vertical height from the bottom of the sign to the ground directly below the sign is necessary for the breakaway features of the sign support to function properly when struck by a vehicle. The minimum mounting height for new signs located behind longitudinal barriers is 7 ft, measured from the bottom of the sign to the edge of traveled way. A lower mounting height of 5 ft may be used when replacing a sign panel on an existing sign assembly located behind longitudinal barrier.

Signs used to reserve parking for people with disabilities are installed at each designated parking stall and are mounted between 3 ft and 7 ft above the surface at the sign location. Figures 820-1a and 820-1b show typical sign installations.

### **(5) Foundations**

Foundation details for wood and steel ground mounted sign supports are shown in the Standard Plans. That manual also contains foundation designs for truss-type sign bridges and cantilever sign structures. Three designs, Types 1, 2, and 3, are shown for each structure.

An investigation of the foundation material is necessary to determine the appropriate foundation design. The Type 1 foundation design uses a large concrete shaft and is the preferred installation when the lateral bearing pressure of the soil is 2,500 psf or greater. The Type 2 foundation has a large rectangular footing design and is an alternate to the Type 1 foundation when the concrete shaft is not suitable. The Type 3 foundation is used in poorer soil conditions where the lateral bearing pressure of the soil is between 1,500 psf and 2,500 psf. Use the data obtained from the geotechnical report to select the foundation type.

If a nonstandard foundation or monotube structure design is planned, forward the report to the Bridge and Structures Office for their use in developing a suitable foundation design. See Chapter 510.

### **(6) Sign Posts**

Ground mounted signs are installed on either wood posts, laminated wood box posts, or steel posts. The size and number of posts required for a sign installation are based on the height and surface area of the sign, or signs, being supported. Use the information in Figures 820-2, 820-3, and 820-4 to determine the posts required for each installation. Use steel posts with breakaway supports that are multidirectional if the support is likely to be hit from more than one direction. Design features of breakaway supports are shown in the Standard Plans. Steel posts with Type 2A and 2B bases have multidirectional breakaway features.

## **820.04 Overhead Installation**

Conditions justifying the use of overhead sign installations are noted in the MUTCD. Where possible, mount overhead signs on grade separation structures rather than sign bridges or cantilever supports.

Details for the construction of truss-type sign bridges and cantilever sign supports are shown in the Standard Plans.

The Bridge and Structures Office designs structure mounted sign mountings, monotube sign bridges, and monotube cantilever sign supports. For overhead sign installation designs, provide sign dimensions, horizontal location in relation to the roadway, and the location of the lighting fixtures, to facilitate design of the mounting components by the Bridge and Structures Office.

### **(1) Illumination**

In urban areas, all overhead signs on multilane highways are illuminated. In rural areas, all overhead regulatory and warning signs including guide signs with “Exit Only” panels on both multilane and conventional highways are illuminated. All other overhead signs are only illuminated when one of the following conditions is present:

- Sign visibility is less than 800 ft due to intervening sight obstructions such as highway structures or roadside features
- Ambient light from a non-highway light source interferes with the sign’s legibility
- The sign assembly includes a flashing beacon

Sign illumination is provided with sign lighting fixtures mounted directly below the sign. The light source of the fixture is a 175 watt mercury vapor lamp. Provide one sign light for a sign with a width of 16 ft or less. For wider signs, provide two or more sign lights with a spacing not exceeding 16 ft. If two or more closely spaced signs are in the same vertical plane on the structure, consider the signs as one unit and use a uniform light fixture spacing for the entire width.

Voltage drops can be significant when the electrical service is not nearby. See Chapter 840 for guidance in calculating electrical line loss.



In areas where an electrical power source is more than 1/2 mile away, utility company installation costs can be prohibitive. Reconsider the benefit of an overhead sign installation at these locations.

### **(2) Vertical Clearance**

The minimum vertical clearance from the roadway surface to the lowest point of an overhead sign assembly is 17 ft-6 in. The maximum clearance is 21 ft.

### **(3) Horizontal Placement**

Consider roadway geometrics and anticipated traffic characteristics in order to locate signs above the lane, or lanes, to which they apply. Install advance guide signs and exit direction signs that require an EXIT ONLY and “down arrow” panel directly above the drop lanes.

To reduce driver confusion as to which lane is being dropped, avoid locating a sign with an EXIT ONLY panel on a horizontal curve.

### **(4) Service Walkways**

Walkways are provided on structure-mounted signs, truss-type sign bridges, and truss-type cantilever sign supports where the roadway and traffic conditions prohibit normal sign maintenance activities. Normally, monotube sign bridges and cantilever sign supports do not have service walkways.

Vandalism of signs, particularly in the form of graffiti, can be a major problem in some areas. Vandals sometimes use the service walkways. Maintenance costs in cleaning or replacing vandalized signs at these locations can exceed the benefit of providing the service walkway.

## **820.05 Mileposts**

Milepost markers are a part of a statewide system for all state highways and are installed in accordance with the Directive D 32-20, State Route Mileposts.

## **820.06 Guide Sign Plan**

A guide sign plan is used by the region to identify existing and proposed guide signing on state highways. The plan provides an easily understood graphic representation of the signing and allows assessment of the continuity in signing to motorist destinations, activities, and services. It is also used to identify deficiencies or poorly defined routes of travel. A guide sign plan for safety and mobility improvement projects is desirable.

When proposed highway work affects signing to a city or town, the guide sign plan can be furnished to the official governing body for review and consideration. The guide sign plan is reviewed and approved by the region’s Traffic Engineer.

## **820.07 Documentation**

Include the following items in the project file:

- An inventory of all existing signing within the project limits
- Approval of proposed guide signs
- Approval of non-standard signs
- Soils investigations for all sign bridge and cantilever sign supports

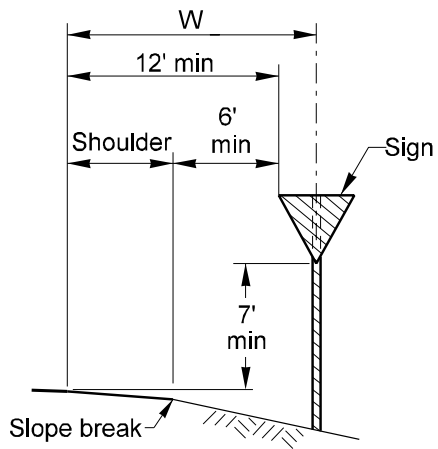

**Sign Installation in Fill Section**

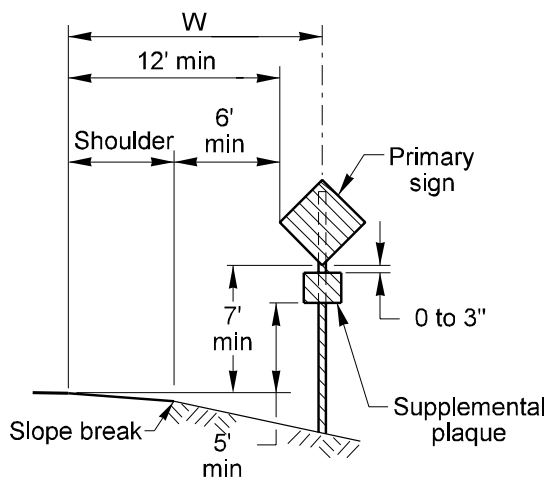

**Sign with Supplemental Plaque Installation in Fill Section**

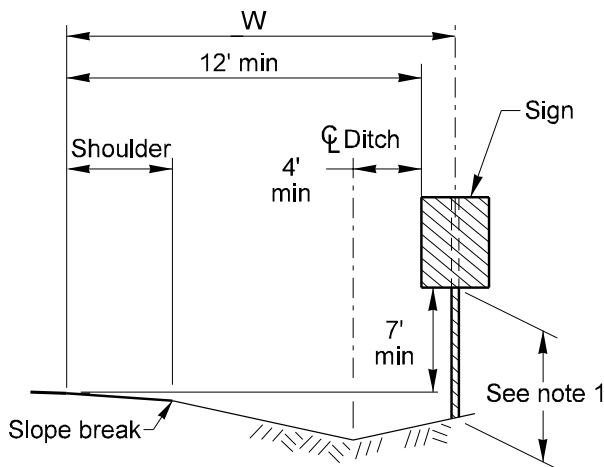

**Sign Installation in Ditch section**

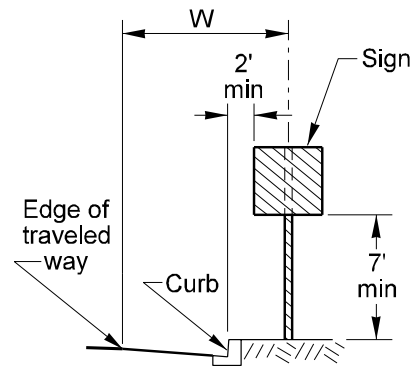

**Sign Installation in Curb Section**

**Notes**

1. 7' min vertical clearance for sign supports with breakaway features

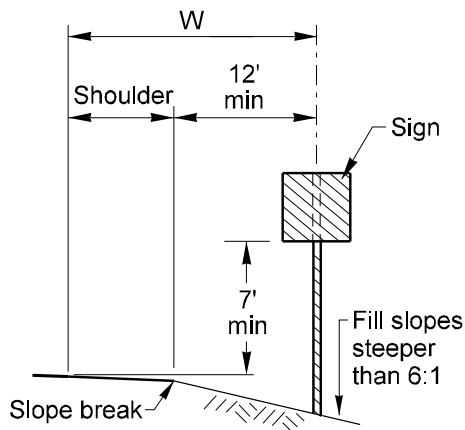

**Sign Installation on Steep Fill Slopes**

**Sign Support Locations**

*Figure 820-1a*

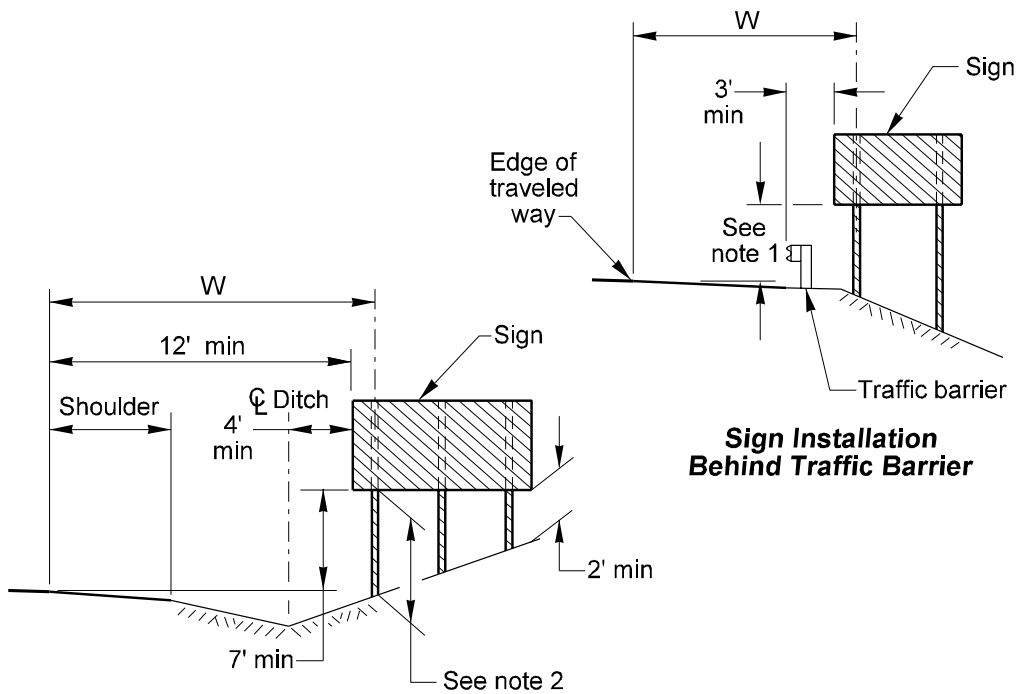

**Sign Installation Behind Traffic Barrier**

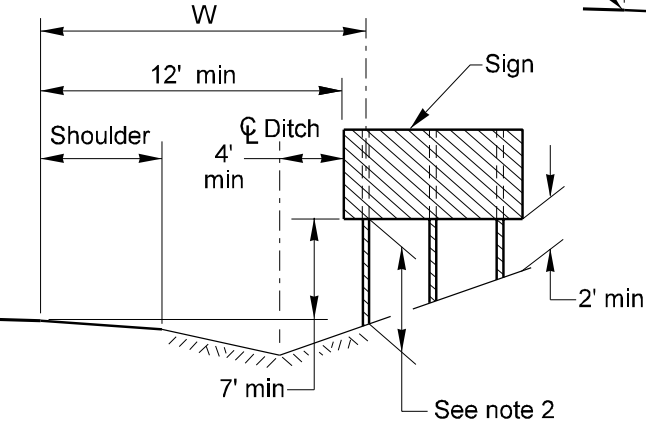

**Multiple Sign Post Installation in Ditch Section**

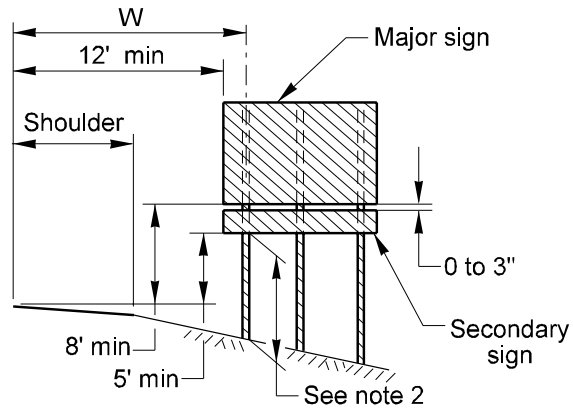

**Guide or Directional Sign with Secondary Sign Installation on Expressways and Freeways**

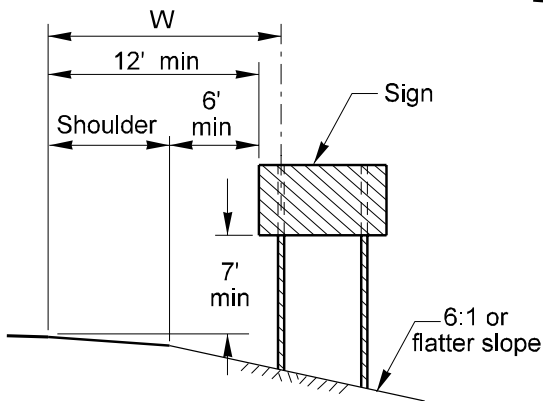

**Multiple Sign Post Installation in Fill Section**

**Notes**

1. 7' min for new sign installations  
5' min for existing sign installations
2. 7' min vertical clearance for sign supports with breakaway features

**Sign Support Locations**  
*Figure 820-1b*

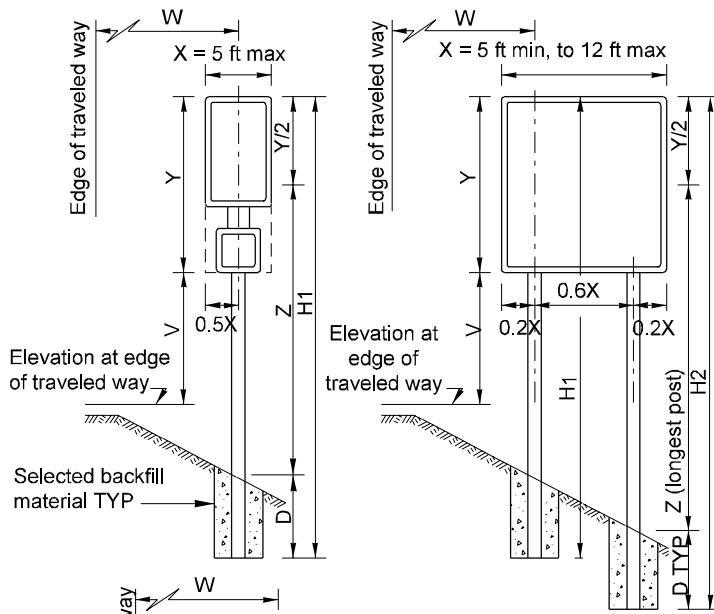

For the purpose of post selection, X and Y are as follows:  
 Single sign, or back-to-back signs, X and Y are the overall dimensions of the sign.

Multiple sign installations, X and Y are the dimensions of a rectangle enclosing all signs.

Z is the height from ground line to mid-height of sign at longest post.

H1 + H2, etc., equals overall post length.

D is the required post embedment depth.

V is the vertical clearance from edge of traveled way.

Post size	(X)(Y)(Z) in ft <sup>3</sup> **				D
	1 Post	2 Post	3 Post	4 Post	
4x4	60*	135	175	235	3 ft
4x6	175*	355	530	705	4 ft
6x6	210	425	635	845	4 ft
6x8	300	850	1280	1700	4 ft
6x10	385	1180	1770	2360	5 ft
8x10	575	1610	2410	3215	5 ft
8x12	775	2310	3465	4620	6 ft

\*Single post application utilizing Western Red Cedar has (X)(Y)(Z) allowable of 50 and 155 respectively.

\*\*Values shown are the maximum permitted. If the quantity (X)(Y)(Z) exceeds the limit for 8X12 posts, use steel post installations.

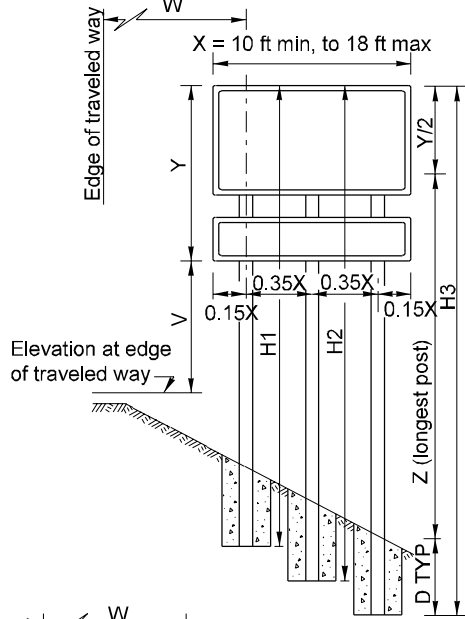

When sign is to be located in the clear zone or outside of the clear zone, but in an area where it is likely to be struck by an errant vehicle, the following configurations are not permitted:

1. Timber posts larger than 6X8.
2. Signs less than 12 ft wide and three 6X6 or larger posts.
3. Signs less than 17 ft wide and four 6X6 or larger posts.

Use steel or laminated wood posts in these situations.

#### Design Example

**Given:** 36 in wide, 42 in high sign with a 18 in wide, 24 in high sign mounted 3 in below. 8 ft shoulder with 2% slope and 6H:1V embankment. W = 15 ft. V = 5 ft.

**Solution:** Use single post.  $X=3$  ft,  $Y=5.75$  ft,  $Z=5.75/2 + (0.02 \times 8) + 5 + 7/6 = 9.21$ .  $(X)(Y)(Z)=3 \times 5.75 \times 9.21=159$  ft<sup>3</sup>. From table, select smallest post having (X)(Y)(Z) of 159 ft<sup>3</sup> or more. Use 4X6 post.  $H=Z + Y/2 + D=9.46 + 6.25/2 + 4.0=16.6$  ft. Use 6X6 when using Western Red Cedar.

#### Design Example

**Given:** 10 ft wide, 4 ft high sign. 10 ft shoulder with 2% slope and 6H:1V embankment. W=35 ft. V=7 ft. Assume sign is inside of clear zone.

**Solution:** Try two posts.  $X=10$  ft,  $Y=4$  ft,  $Z=4/2 + 7 + (0.02 \times 10) = 14.37$  ft.  $(X)(Y)(Z)=10 \times 4 \times 14.37=575$  ft<sup>3</sup>. From table, select smallest post having (X)(Y)(Z) of 575 or more. Two 6X6 posts are not sufficient, use 6X8 posts because three 6X6 posts would require a traffic barrier.

$H2=14.37 + 2 + 4=20.4$  ft

$H1=20.4 - (0.6 \times 10)/6=19.8$  ft

All dimensions are in ft unless otherwise noted.

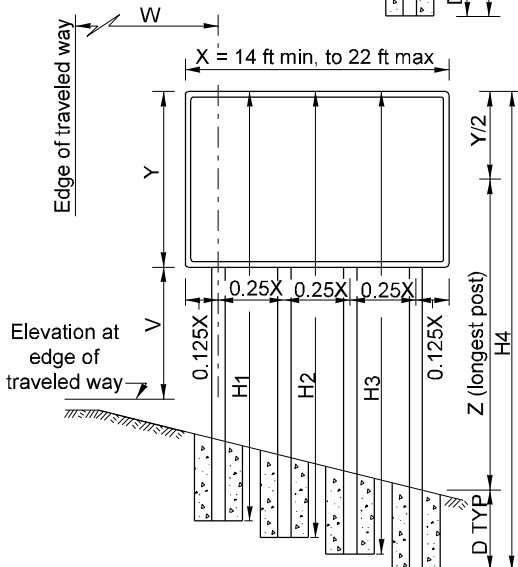

### Wood Posts Figure 820-2

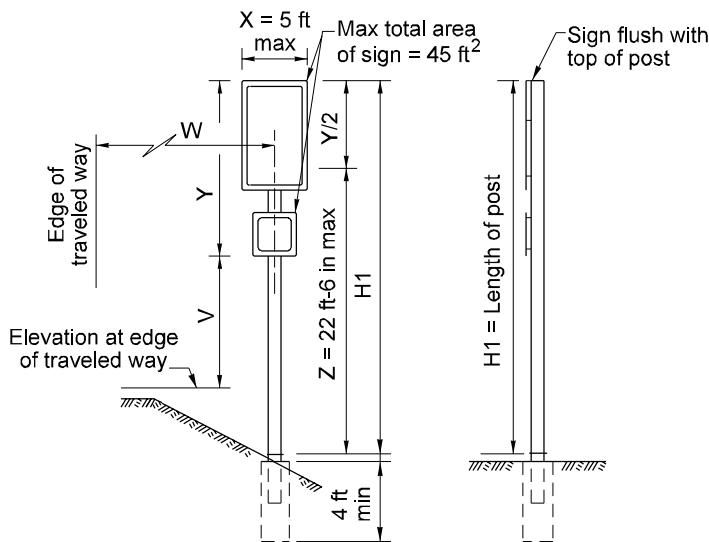

For the purpose of post selection, X and Y are as follows:  
Single sign, or back-to-back signs, X and Y are the overall dimensions of the sign.

Multiple sign installations, X and Y are the dimensions of a rectangle enclosing all signs.

Z is the height from the base connection (2 1/2 in above the post foundation) to mid-height of sign at the longest post.

H1, H2, etc., equals overall post length (base connection to top of sign).

D is the required post embedment depth (see standard plans).

V is the vertical clearance from the edge of traveled way.  
Single Post Signs

For a maximum 20 ft<sup>2</sup> sign, use 4 in standard pipe for Z less than 18 ft 6 in or 5 in standard pipe for Z greater than 18 ft 6 in.

For a maximum 45 ft<sup>2</sup> sign, use 5 in standard pipe for Z less than 15 ft 6 in or 6 in standard pipe for Z greater than 15 ft 6 in.

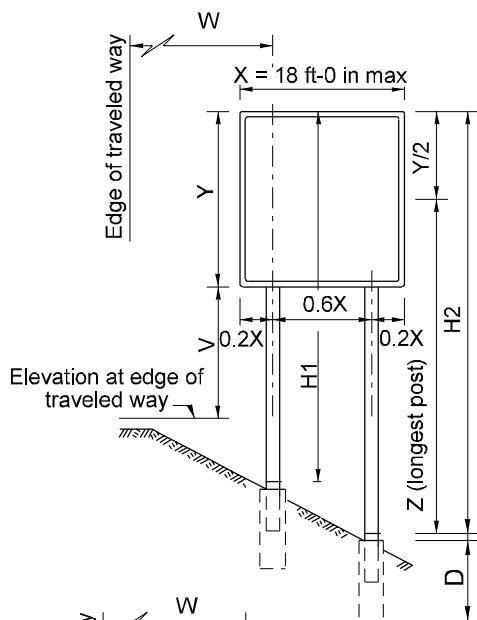

Two and Three post signs

Post Selection (X)(Y)(Z) in ft <sup>3*</sup>		Post Size	
2 Posts	3 Posts	**	AASHTO M183
1570	2355	W6x9	W6x12
2810	4220	W6x12	W6x16
4940	7410	W8x18	W8x21
7580	11370	W10x22	W10x26

\*Value shown are the maximum permitted.

\*\*AASHTO M222 or M223 may be used as an acceptable alternative to AASHTO M 183 at the sizes listed.

### Design Example

**Given:** 22 ft wide, 12 ft high sign. 10 ft shoulder with 2% slope and a 3H:1V embankment slope. W = 32 ft.

**Solution:** Use three posts. X = 22 ft, Y = 12 ft, V = 7 ft, Z = 12/2 + 7 + (0.02x10) + (22 + 0.70x22)/3 - 0.21 = 25.46 ft. (X)(Y)(Z) = 22x12x25.46 = 6721 ft<sup>3</sup>. From table, select smallest post having (X)(Y)(Z) of 6721 or more. Use W8x18 (AASHTO M222 or M223) or W8x21 (AASHTO M183) posts.

$$H3 = 25.46 + 12/2 = 31.46 \text{ ft} = 31 \text{ ft } 5 \frac{1}{2} \text{ in}$$

$$H2 = 31.46 - (0.35x22)/3 = 28.89 \text{ ft} = 28 \text{ ft } 10 \frac{5}{8} \text{ in}$$

$$H1 = 31.46 - (0.70x22)/3 = 26.33 \text{ ft} = 26 \text{ ft } 4 \text{ in}$$

For any sign installation located within the clear zone distance of the lane edge, the total weight of all the posts in the 7 ft wide path shall not exceed a combined post weight of 36 lbs/ft. If the proposed sign configuration does not meet this criteria, relocate, resize or provide additional protection for the proposed installation.

Use the following table to determine post weights.

All dimensions are in feet unless otherwise noted.

Wide Flange Beam Dimensions

Beam size	Weight lbs/ft
W6x9	9
W6x12	12
W6x16	16
W8x18	18
W8x21	21
W10x22	22
W10x26	26

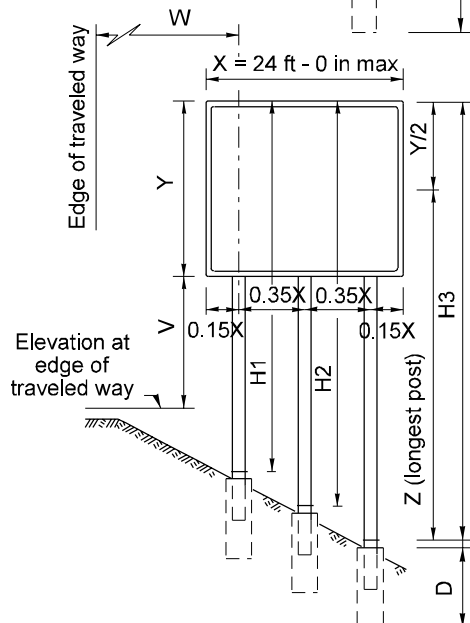

**Steel Posts**  
Figure 820-3

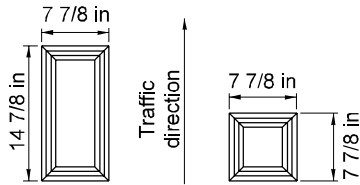
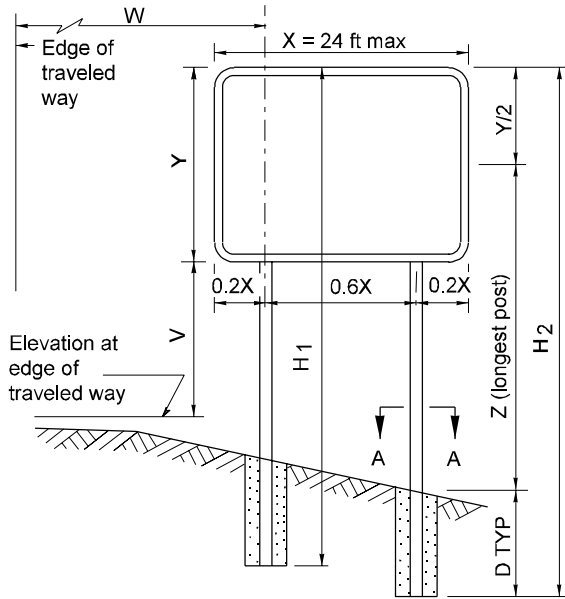

Type L Post      Type M Post

**SECTION A-A**

For the purpose of post selection, X and Y are as follows:

Single sign, or back-to-back signs. X and Y are the overall dimensions for the sign.

Multiple sign installations, X and Y are the dimensions of a rectangle enclosing all signs.

Z is the height from ground line to mid-height of sign at the longest post.

H<sub>1</sub> and H<sub>2</sub> equal overall post length.

D is the required post embedment depth.

V is the vertical clearance from edge of traveled way.

Box Post Type	Z (ft)	(X)(Y)(Z) ft <sup>3</sup>
M	15 < Z ≤ 30	1329
M	Z < 15	1661
L	15 < Z ≤ 30	3502
L	Z < 15	4378

**Design Example**

**Given:** 16 ft wide, 6 ft high sign. 10 ft shoulder with 2% slope and a 6H:1V embankment. W = 25 ft. V = 7 ft.

**Solution:** Use two posts. X = 16 ft. Y = 6 ft.

**For two posts:**  $Z = 6/2 + 7 + (0.02 \times 10) + (15 + 0.6 \times 16)/6 = 14.3$  ft.

$(X)(Y)(Z) = 16 \times 6 \times 14.3 = 1,373$  ft<sup>3</sup>

From table, select smallest post having (X)(Y)(Z) of 1,373 or more and meets the "Z" requirements.

Use two M posts

$$H_2 = Z + Y/2 + D = 14.3 + 3.0 + 6.0 = 23.3 \text{ ft.}$$

$$H_1 = 23.3 - (0.6 \times 16)/6 = 21.7 \text{ ft.}$$

**Design Example**

**Given:** 18 ft wide, 8 ft high sign, 10 ft shoulder with 2% slope and a 6H:1V embankment. W = 25 ft. V = 7 ft.

**Solution:** Use two posts. X = 18 ft, Y = 8 ft.

**For two posts:**  $Z = 8/2 + 7 + (0.02 \times 10) + (15 + 0.6 \times 18)/6 = 15.5$  ft.

$(X)(Y)(Z) = 18 \times 8 \times 15.5 = 2,232$  ft<sup>3</sup>.

From table, select smallest post having (X)(Y)(Z) of 2,232 or more and meets the "Z" requirements.

Use two L posts.

$$H_2 = Z + Y/2 + D = 15.5 + 4.0 + 9.0 = 28.5 \text{ ft.}$$

$$H_1 = 28.5 - (0.6 \times 18)/6 = 26.7 \text{ ft.}$$

All dimensions are in feet unless otherwise noted.

Z (ft)	Total Sign Area (Square Feet)					
	Up to 50	51 to 100	101 to 150	151 to 200	201 to 250	251 to 290
9 to 12	6	6	7	8	9	10
12.1 to 15	6	6	7.5	9	10	
15.1 to 18	7.0	7.5	9	Not Permitted		
18.1 to 22	7.0	8	10			
22.1 to 26	7.5	8.5				

Laminated Post Embedment Depth

**Laminated Wood Box Posts**

Figure 820-4

830.01	General
830.02	References
830.03	Pavement Markings
830.04	Guide Posts
830.05	Barrier Delineation
830.06	Wildlife Reflectors
830.07	Documentation

### 830.01 General

The primary function of delineation is to provide the visual information needed by the driver to operate a vehicle safely in a variety of situations. Delineation can be the marking of highways with painted or more durable pavement marking lines and symbols, guide posts, and other devices. These devices use retroreflectance, reflecting light from a vehicle's headlights back to the driver, to enhance their visibility at nighttime. WSDOT uses the latest edition of FHWA's *Manual on Uniform Traffic Control Devices for Streets and Highways* (MUTCD) as a guide for design, location, and application of delineation.

Delineation is a required safety item of work and is addressed on all projects. A decision to omit delineation work can only be justified if the existing delineation is unaffected by construction and an evaluation of accident rates clearly shows that delineation is not a contributing factor.

### 830.02 References

*Manual on Uniform Traffic Control Devices for Streets and Highways* (MUTCD), USDOT, Washington, DC, 1988, including the *Washington State Modifications to the MUTCD*, M 24-01, WSDOT, 1996

*Roadway Delineation Practices Handbook*, FHWA report, Washington, DC, 1994

*Standard Plans for Road, Bridge, and Municipal Construction* (Standard Plans), M 21-01, WSDOT

*Sign Fabrication Manual*, M 55-05, WSDOT

### 830.03 Pavement Markings

#### (1) Pavement Marking Types

Pavement markings have specific functions. They guide the movement of traffic and promote safety on the highway. In some cases, they are used to supplement the messages of other traffic control devices. In other cases, markings are the only way to convey a message without distracting the driver. Pavement markings are installed and maintained to provide adequate performance year round. Adequate performance is defined as meaning the marking meets or exceeds standards of both daytime and nighttime visibility. Pavement markings are classified as either longitudinal or transverse. Centerlines, lane lines, where applicable, and edge lines, except as noted, are required on all paved State highways unless an exception is granted by the State Traffic Engineer with justification. Guidelines for the application of various pavement markings are provided in Chapter 910 for intersections and channelization, Chapter 940 for interchanges, and the Standard Plans.

(a) **Longitudinal pavement markings** define the boundary between opposing traffic flows. They also define the edges of traveled way, multiple traffic lanes, turn lanes, and special use lanes. Longitudinal pavement markings are:

**skip center line.** A broken yellow line used to separate lanes of traffic moving in opposite directions, where passing in the opposing lane is allowed.

**double yellow center line.** Two parallel solid yellow lines used to separate lanes of traffic moving in opposite directions where passing in the opposing lane is prohibited.

**edge line.** A solid white line used to define the outer edge of the traveled way. Edge lines are not required where curbs or sidewalks are 4 ft or less from the traveled way.

**dotted extension line.** A broken white line that is an extension of an edge line used at exit ramps, intersections on horizontal curves, and other locations where the direction of travel for through traffic is unclear.

**wide line.** A wide solid white line used to separate lanes of traffic moving in the same direction at ramp connections, storage lanes at intersections, and high occupancy vehicle lanes.

**wide dotted line.** A wide broken white line used to designate a portion of a high occupancy vehicle lane located on an arterial highway where general purpose vehicles may enter to make a turn at an intersection.

**wide skip line.** A wide broken white line used to designate a portion of a high occupancy vehicle lane located on a divided highway where general purpose vehicles may enter to make an exit.

**lane line.** A broken white line used to separate lanes of traffic moving in the same direction.

**drop lane line.** A wide broken white line used in advance of a wide line to delineate a lane that ends at an off ramp or intersection.

**no-pass line.** A solid yellow line used in conjunction with a skip center line where passing in the opposing lane is prohibited.

**reversible lane line.** Two broken yellow lines used to delineate a lane where traffic direction is periodically reversed.

**two way left turn line.** Two yellow lines, one solid and one broken, used to delineate each side of a two way left turn lane.

**barrier line.** A very wide solid yellow line used to separate opposing traffic movements where all movements over the line are prohibited. Barrier line locations require the approval of the region's Traffic Engineer.

**(b) Transverse pavement markings** define pedestrian crossings and vehicle stopping points at intersections. They are also used to warn the motorist of approaching conditions, required vehicular maneuvers, or lane usage. Typical transverse pavement markings are:

**crosswalk line.** A series of parallel solid white lines used to define a pedestrian crossing.

**stop bar.** A solid white line used to indicate the stopping point at an intersection or railroad crossing.

**traffic arrow.** A white marking used in storage lanes and two way left turn lanes to denote the direction of turning movement. Arrows are also used at ramp terminals and intersections on divided highways to discourage wrong way movements.

**traffic letters.** White markings forming word messages, such as "ONLY", used in conjunction with a traffic arrow at drop lane situations. Traffic letters are not required for left and right turn storage lanes where the intended use of the lane is obvious.

**handicapped parking stall symbol.** A white marking used to designate parking stalls provided for motorists with disabilities.

**HOV symbol.** A white diamond marking used for high occupancy vehicle lanes. Typical spacing is 500 ft for divided highways and 300 ft for arterial highways.

**railroad crossing symbol.** A white marking used in advance of a railroad crossing where grade crossing signals or gates are located or where the posted speed of the highway is 40 mph or higher.

**bicycle lane symbol.** A white marking consisting of a symbol of a bicyclist and an arrow used in a marked bike lane. Typical spacing is between 150 ft and 250 ft.

**drainage marking.** A white line used to denote the location of a catch basin, grate inlet or other drainage feature in the shoulder of a roadway.

**aerial surveillance marker.** White markings used at one mile and one-half mile intervals on sections of highways where the State Patrol uses airplanes to enforce speed limits.



## (2) Pavement Marking Materials

Pavement markings are available in various materials. These materials are divided into two categories, paint and plastic. When selecting the pavement marking material to use in a project, consider the initial cost of the material, its service life, location, traffic conditions, the snow and ice removal practices of the particular maintenance area, and the region's ability to maintain the markings. Only consider plastic marking material if the pavement is in good condition and will not require major reconstruction for at least the service life of the material. See Figure 830-1 for the recommended pavement marking materials for different highway types and snow removal practices.

Paint is the most common pavement marking material. It is relatively easy to apply and dries quickly (30 - 90 seconds), after application. This allows the application to be a moving operation which minimizes traffic control costs and delay to the roadway users. Paint is applied on construction contracts with two coats; the first coat is 10 mils thick, followed by a second coat 15 mils thick. The disadvantage of painted pavement markings is its short service life. Only on very low volume roadways subjected to little sanding or snow removal activity will paint provide adequate performance for a year.

Plastic markings have a higher installation cost than paint. They can, however, be a more cost effective measure than paint because of their longer service life. Plastic marking materials currently listed in the Qualified Products List include the following:

- **Thermoplastic.** Thermoplastic material consists of resins and filler materials in solid form at room temperature. The material is heated to a semiliquid, molten state (400 degrees Fahrenheit) and is then applied to the roadway by spray or extrusion methods. This material can be used for both transverse and long line applications. Special equipment is required for both the initial application and subsequent maintenance renewal. Sprayed material can be applied at a thickness of 30 mils and dries in 30 to

60 seconds. The service life of material applied in this manner is slightly longer than that of paint. Extruded material is applied at a thickness of 125 mils and has a drying time of 15 minutes. This material can be applied as a flat line or it can be applied with ridges or bumps that enhance wet night visibility. These bumps produce a rumble effect similar to rumble strips when a vehicle crosses over the marking. The service life of extruded material is about 3 years. Thermoplastic pavement markings costs about three times more than paint. Failure is usually a result of delamination, rather than wear and abrasion. The material has a different coefficient of expansion than pavement material. Changes in temperature cause the thermoplastic material to crack. This allows the intrusion of moisture between the thermoplastic material and the pavement surface and eventually causes the delamination.

- **Preformed Tape.** Preformed tapes are composed of thermoplastic or other materials that are fabricated under factory conditions. After curing, the material is cut to size and shipped to the work site in rolls or in flat pieces. The material is then applied to the roadway with an adhesive or with heat to activate a preapplied bonding agent. Preformed tapes are available in a thickness of either 60 mils, 90 mils, or 125 mils. Preformed tape will last between 3 and 4 years in a rubber bit snow plow removal area. Preformed tape is about 5 times more expensive than paint. The most durable application of preformed tapes is achieved when the tape is rolled into hot asphalt and the top of the tape is flush with the surface of the pavement. Preformed tapes can have acceptable service lives in ice chisel snow removal areas when the tape is installed in a groove ground into the pavement.
- **Methyl Methacrylate (MMA).** Methyl methacrylate application can be either by spraying or extrusion. Sprayed applications are typically two coats, 45 mils thick. Extruded applications are 90 mils thick for dense asphalt or PCC pavement or 120 mils thick for open graded asphalt pavement.

The material is not heated and can be applied within a temperature range of 40 to 100 degrees Fahrenheit, provided the pavement surface is dry. The material can be used for both transverse and longitudinal applications. The material can also be applied with bumps that enhance wet night visibility. The bumps also produce the rumble effect. MMA can have acceptable service life in ice chisel snow removal areas if the material is installed in a 250 mil deep groove ground into the pavement. MMA has a service life of between 4 and 8 years. MMA, depending on the application, can cost between 5 and 10 times more than paint.

- **Raised Pavement Markers (RPMs).** RPMs are installed as positioning guides with long line pavement markings. They can also be installed as a complete substitution for certain long line markings.. RPMs have a service life of two years. RPMs provide good wet night visibility and a rumble effect. RPMs cost 2 to 3 times more than paint when used in substitution applications. RPMs are made from plastic materials and are available in three different types.

Type 1 markers are 4" diameter, 3/4" high, and nonreflectorized.

Type 2 markers are 4" wide, 2 1/2" to 4" long, 3/4" high, and reflectorized.

Type 3 markers are 4" wide, 6" to 12" long, 3/4" high, and reflectorized.

Type 2 RPMs are not used as a substitute for right edge lines. They can only be used to supplement the right edge line markings; at lane reductions, at sections with reduced lane widths such as narrow structures, and at the gore of exit ramps. All other applications supplementing right edge line markings require approval of the region's Traffic Engineer. Type 3 RPMs are used in locations where additional emphasis is desired. These locations include vehicle separations and islands. Approval of the region's Traffic Engineer is required for all installations of Type 3 RPMs.

Reflectorized RPMs are not required for center and lane line applications in continuously illuminated sections of highway. However, if reflectorized RPMs are used at an intersection within an illuminated section, they are also provided throughout that section.

## 830.04 Guide Posts

### (1) General

Guide posts are retroreflective devices mounted at the side of the roadway to indicate alignment. They are considered to be guidance devices rather than warning devices. They are used as an aid to nighttime driving primarily on horizontal curves; all multilane divided highways; ramps; tangent sections where they can be justified due to snow, fog, or other reduced visibility conditions; and at intersections without illumination.

The types of guide posts and their application are as follows:

(a) **Type W.** Guide posts with silver-white reflective sheeting, facing traffic, used on the right side of divided highways, ramps, right-hand acceleration and deceleration lanes, intersections, and ramp terminals.

(b) **Type WW.** Guide posts with silver-white reflective sheeting, on both sides, used on the outside of horizontal curves on two-way, undivided highways.

(c) **Type Y.** Guide posts with yellow reflective sheeting, facing traffic, used on the left side of ramps, left-hand acceleration and deceleration lanes, ramp terminals, intersections on divided highways, median crossovers, and horizontal curves on divided highways.

### (2) Placement and Spacing

Guide posts are placed not less than 2 ft or more than 8 ft outside the outer edge of the shoulder. Place guide posts at a constant distance from the edge of the roadway. When an obstruction intrudes into this space, position the guide posts to smoothly transition to the inside of the obstruction. Guide posts are not required along continuously illuminated divided or undivided highways. See Figure 830-2 for guide post placement requirements.

## 830.05 Barrier Delineation

Traffic barriers are delineated where guide posts are required, such as bridge approaches, ramps, and other locations on unilluminated roadways. See Figure 830-2. At these locations, the barrier delineation has the same spacing as that of guide posts. Barrier delineation is also required when the traffic barrier is 4 ft or less from the traveled way. Use a delineator spacing of no more than 40 ft at these locations.

Beam guardrail is delineated by either mounting standard length flexible guide posts behind the rail or by attaching shorter flexible guide posts to the wood guardrail posts.

Concrete barrier is delineated by placing retroreflective devices on the face of the barrier about 6" down from the top. Consider mounting these devices on the top of the barrier at locations where mud or snow accumulates against the face of the barrier.

The terminal ends of impact attenuators are delineated with modified Type 3 Object Markers. These are the impact attenuator markers in the *Sign Fabrication Manual*. When the impact attenuator is used in a roadside condition, the marker with diagonal stripes pointing downward toward the roadway is used. When the attenuator is used in a gore where traffic will pass on either side, the marker with chevron stripes is used.

## 830.06 Wildlife Warning Reflectors

### (1) Reflector System

Collisions between automobiles and wildlife (predominately deer) produce a substantial economic cost through damage to vehicles, human injuries, fatalities, and loss of the wildlife resources.

A wildlife warning reflector system has been developed to reduce this accident potential. This system consists of a series of reflectors mounted adjacent to the roadway. During the hours of low natural light (dusk, dawn, and night), light from the headlights of an approaching vehicle is reflected to the adjacent roadside by the reflectors. This reflected light creates an "optical fence" causing deer to remain motionless until the vehicle has passed.

The Olympia Service Center (OSC) Environmental Affairs Office biologist maintains a history of vehicle-deer collisions on state highways and can furnish the region with prospective "optical fence" locations. The biologist is available to assist with a benefit/cost analysis of proposed reflector installations. Consider wildlife reflectors where the deerkill for any one mile section exceeds five kills per year. Also, consider wildlife reflectors for special circumstances such as at a high use deer crossing where a short section of this reflector system might be appropriate. After-installation maintenance costs can be a prohibitive factor when considering a wildlife reflector system. To remain effective, dirty reflectors must be cleaned periodically and reflector posts damaged by snow plowing or errant vehicles must be replaced.

### (2) Reflector Placement

Spacing of the wildlife reflectors along the shoulder edges is dependent upon the geometric configuration of the highway and upon the roadside conditions. Reflectors are placed along both sides of the roadway in a staggered arrangement with the longitudinal spacing roughly equal to the combined transverse width of the roadway and reflector offset. See Figures 830-3 and 830-4 for examples of wildlife reflector placements. More detailed information for reflector placement in different locations is available from the manufacturer. Contact the OSC Environmental Affairs office biologist or the OSC Traffic Office.

## 830.07 Documentation

Preserve the following documents in the project file: See Chapter 300.

- All decisions to not provide basic delineation
- All correspondence when considering wildlife reflectors
- Approval of the use of Type 2 RPMs to delineate a right edge line

P65:DP/DME

<b>Ice Chisel Snow Removal Areas</b>					
<b>Roadway Classification</b>	<b>Marking Type</b>				
	<b>Center Lines</b>	<b>Lane Lines</b>	<b>Edge Lines</b>	<b>Wide Lines</b>	<b>Special Markings</b>
Interstate	N.A.	Plastic Insets	Paint	Paint	Paint
Major Arterial	Paint and RRPMS	Paint	Paint	Paint	Paint
Minor Arterial	Paint	Paint	Paint	Paint	Paint
Collector	Paint	Paint	Paint	Paint	Paint
<b>Steel Blade Snow Removal Areas</b>					
<b>Roadway Classification</b>	<b>Marking Type</b>				
	<b>Center Lines</b>	<b>Lane Lines</b>	<b>Edge Lines</b>	<b>Wide Lines</b>	<b>Special Markings</b>
Interstate-Urban	N.A.	Plastic	Paint or Plastic	Paint or Plastic	Paint or Plastic
Interstate-Rural	N.A.	Paint	Paint or Plastic	Paint or Plastic	Paint or Plastic
Major Arterial	Paint and RRPMS or Plastic	Paint	Paint or Plastic	Paint or Plastic	Paint or Plastic
Minor Arterial	Paint	Paint	Paint	Paint or Plastic	Paint or Plastic
Collector	Paint	Paint	Paint	Paint or Plastic	Paint or Plastic
<b>Rubber Blade Snow Removal Areas</b>					
<b>Roadway Classification</b>	<b>Marking Type</b>				
	<b>Center Lines</b>	<b>Lane Lines</b>	<b>Edge Lines</b>	<b>Wide Lines</b>	<b>Special Markings</b>
Interstate-Urban	N.A.	RPMs only or Plastic and RPMs	Paint or Plastic	Plastic	Plastic
Interstate-Rural	N.A.	RPMs only or Plastic and RPMs	Paint	Plastic	Plastic
Major Arterial	Paint and RPMs or Plastic and RPMs	Paint and RPMs	Paint	Plastic	Plastic
Minor Arterial	Paint and RPMs	Paint and RPMs	Paint	Plastic	Plastic
Collector	Paint and RPMs	Paint	Paint	Plastic	Plastic

**Notes**

1. Insets are grooves ground into the pavement and filled with material, usually methyl methacrylate.
2. Plastic refers to methyl methacrylate, thermoplastic, or preformed tape.
3. See Standard Plan H-5d for RPM substitute applications.
4. See Standard Plan H-3 and H-3a for RPM applications with paint or plastic.
5. Special Markings include arrows, symbols, letters, channelizing lines, and transverse markings.
6. RRPMS refers to RPMs installed in a groove ground into the pavement.
7. Type 2 RPMs are not required with painted or plastic center or lane line in continuously illuminated sections. See Section 830.03(2).

**Pavement Marking Material Guide**

*Figure 830-1*

Highway Type	Guide Posts on Tangents (See Note 1)	Guide Posts on Horizontal Curves (See Note 1)
<b>Divided Highways with Continuous Illumination</b>		
Main Line	None	None
Bridge Approaches	None	None
Intersections	None	None
Lane Reductions	Standard Plan H-1d	Standard Plan H-1d
Median Crossovers	None	None
Ramps	Standard Plan H-1b	Standard Plan H-1b
<b>Divided Highways without Continuous Illumination</b>		
Main Line with RPMs	None	Standard Plan H-1c
Main Line without RPMs	Right Side Only (0.10 mile spacing)	Standard Plan H-1c
Bridge Approaches	Standard Plan H-1e	Standard Plan H-1e
Intersections	Standard Plan H-1a	Standard Plan H-1a
Lane Reductions	Standard Plan H-1d	Standard Plan H-1d
Median Crossovers	Standard Plan H-1d	Standard Plan H-1d
Ramps	Standard Plan H-1b	Standard Plan H-1b
<b>Undivided Highways with Continuous Illumination</b>		
Main Line	None	None
Bridge Approaches	None	None
Intersections	None	None
Lane Reductions	Standard Plan H-1d	Standard Plan H-1d
<b>Undivided Highways without Continuous Illumination</b>		
Main Line	See Note 2	Standard Plan H-1c (See Note 2)
Bridge Approaches	Standard Plan H-1e	Standard Plan H-1e
Intersections with Illumination	None	None
Intersections without Illumination	Standard Plan H-1d	Standard Plan H-1d
Lane Reductions	Standard Plan H-1d	Standard Plan H-1d

Note 1: See Standard Plan H-1 for lateral placement of guide posts.

Note 2: Installation of guide posts on tangents and on the inside of horizontal curves is allowed at locations approved by the region's Traffic Engineer.

### Guide Post Placement

*Figure 830-2*



**Wildlife Reflectors on a Tangent Section**  
*Figure 830-3*



**Wildlife Reflectors on the Outside of a Curve**  
*Figure 830-4*

840.01	General
840.02	References
840.03	Definitions
840.04	Required Illumination
840.05	Additional Illumination
840.06	Design Criteria
840.07	Documentation

### 840.01 General

Illumination is provided along highways, in parking lots, and at other facilities to enhance visual perception of conditions or features that require additional driver, cyclist, or pedestrian alertness during the hours of darkness.

The design matrices identify the design levels for illumination on all preservation and improvement projects. (See Chapter 325.) These levels, basic or full, are indicated in the columns. At the basic design level for minor safety or preservation work, providing breakaway features on existing light standards (when required), replacing deficient electrical components, and other minor work would be the extent of consideration. Providing additional lighting or relocating light standards on preservation projects may be considered as a spot safety enhancement.

A full design level notation in a design matrix column indicates that the required illumination (see 840.04 Required Illumination) specified in this chapter is necessary. When the illumination column has an EU (evaluate upgrade to full design level), consider providing illumination if it would be beneficial to the specific project.

A deviation to not provide the illumination required for full design level on a National Highway System (NHS) highway requires Olympia Service Center (OSC) approval. Submit the necessary information, justifying the deviation, to the Assistant State Design Engineer. Design deviations on Non-NHS highways are approved by the Regional Administrators or their designees. Proposals to provide less than or more

than the required illumination are considered a deviation and require justification and the same approval process.

### 840.02 References

*Revised Code of Washington (RCW) 47.24.020, "Jurisdiction, control."*

*Washington Administrative Code (WAC) 468-18-040, "Design standards for rearranged county roads, frontage roads, access roads, intersections, ramps and crossings"*

Directive D 22-21, "Truck Weigh Stations and Vehicle Inspection Facilities on State Highways"

*Roadway Lighting Handbook, USDOT, Washington, DC 1978*

*Roadway Lighting Handbook Addendum to Chapter Six, USDOT, Washington, DC 1983*

*An Informational Guide for Roadway Lighting, AASHTO, Washington, DC 1984*

*American National Standard Practice for Roadway Lighting, IES RP-8-1983, New York, NY 1983*

*Recommended Practice for Tunnel Lighting, IESNA RP-22-96, New York, NY 1996*

*National Electrical Code, NFPA, Quincy, MA*

*City Streets as a Part of the State Highway - Final Report, WSDOT 1997*

### 840.03 Definitions

**cadela** A unit of luminous intensity equal to one lumen per steradian.

**footcandle** The illumination of a surface one square foot in area on which is uniformly distributed a flux of one lumen. A footcandle equals one lumen per square foot.

**lamp lumens** The total light output from a lamp in lumens. (A lumen being a unit of luminous flux.)

**luminous flux** The time rate of flow of light.

**minimum light level** The minimum light intensity of illumination at any point within the design area measured just prior to relamping the system.

**minimum average light level** The average of all light intensities within the design area measured just prior to relamping the system.

**mounting height** The vertical distance between the surface of the design area and the center of the light source of the luminaire. This is the distance used to compute the light level of the design area.

**pole height (H1)** The vertical distance from the light source to the pole base. This distance is specified in contracts and used by the pole manufacturers to fabricate the light standard. In curb and sidewalk areas, the H1 distance is assumed to equal the mounting height. Typically, the mounting height in fill sections is less than the H1 distance while the mounting height in cut sections is equal to or greater than the H1 distance.

**security lighting** A minimal amount of lighting used to illuminate areas for public safety or theft reduction. Security lighting for walkways is the lighting of angle points and shadow areas.

**spacing** The distance in feet measured on center line between adjacent luminaires. Spacing is equal to the lamp lumens times the coefficient of utilization times the light loss factor divided by the width and the design footcandle value.

**uniformity ratio** The ratio of the minimum average light level on the design area to the minimum light level of the same area.

**veiling luminance** The stray light produced within the eye by the light source that alters the apparent brightness of an object within the visual field and the background against which it is viewed.

## 840.04 Required Illumination

### (1) General

The Washington State Department of Transportation (WSDOT) is responsible for illumination on state highways with partial, modified, or full limited access control regardless of the location and on state highways located outside the corporate limits of cities. Cities are responsible for illumination of state highways without WSDOT established access control located within their corporate limits. Figures 840-1 through 840-5 show examples of illumination for highway applications. Illumination in these examples and the locations listed below are required on state highways.

### (2) Freeway Off Ramps and On Ramps

Provide the necessary number of light standards to illuminate the design area of all freeway off ramp gore areas and on ramp acceleration tapers. See 840.06(2).

### (3) Freeway Ramp Terminals

A single light standard is required at the intersection of a ramp terminal with a two lane roadway. At the intersection of a ramp terminal with a multilane roadway, additional lighting is required to illuminate the intersection design area. See Figure 840-5. Additional illumination is also required if the intersection has left turn channelization or a traffic signal.

### (4) Intersections With Left Turn Channelization

Illumination of the intersection area and the left turn storage is required for intersections with painted or other low profile pavement markings such as raised pavement markings. When the channelization is delineated with curbs, raised medians or islands, illuminate the raised channelization from the beginning of the left turn taper. Illumination of the secondary road intersecting the state highway can be beneficial to the motoring public. Funding and design, however, are the local agency's responsibility. Contact that agency to see if they are interested in participating.



### **(5) Intersections With Traffic Signals**

All traffic signals on state highways are illuminated. The extent of illumination is the same as for intersections with left turn channelization. Illumination of the crossroad is beneficial and participation of the local agency is desirable. In cities with a population under 22,500, the state may assume responsibility for illumination installed on signal standards.

### **(6) Railroad Crossings With Gates or Signals**

Railroad crossings with automated gates or signals on state highways are illuminated if there is nighttime train traffic. Within the corporate limits of a city, illumination is the responsibility of that agency.

### **(7) Transit Flyer Stops**

Illuminate the loading area of a transit flyer stop located within the limited access boundaries. Normally, this illumination consists of one light standard at the point where passengers enter the bus.

### **(8) Major Parking Lots**

All parking lots with usage exceeding 50 vehicles during the nighttime peak hour are considered major parking lots. Provide an illumination design that will produce the light levels shown in Figure 840-6 for the parking area and bus loading zone. During periods of low usage at night, only security lighting is required. Provide an electrical circuitry design that allows the illumination system to be reduced to approximately 25% of the required light level.

### **(9) Minor Parking Lots**

Minor parking lots have a nighttime peak hour usage of 50 or less vehicles. Provide security level lighting for those lots owned and maintained by the state. Security lighting consists of lighting the entrance and exit to the lot.

### **(10) Truck Weigh Sites**

Provide illumination of the scale platforms, parking areas, and inspection areas of weigh sites.

### **(11) Midblock Pedestrian Crossings**

Illuminate the entire midblock pedestrian crossing, including the crosswalks, the refuge area in the roadway, and the sidewalks or shoulders adjacent to the crosswalk. When a raised median pedestrian refuge design is used, illuminate this raised channelization.

### **(12) Long Tunnels**

Long tunnels have a portal to portal length greater than the wet pavement stopping sight distance. Provide both nighttime and daytime illumination for long tunnels.

## **840.05 Additional Illumination**

### **(1) General**

At certain locations, additional illumination is desirable to provide better definition of nighttime driving conditions or to provide consistency with local agency goals and enhancement projects. Funding, design, and maintenance of illumination along state highways within the corporate limits of a city is the responsibility of the municipality unless the state has acquired modified, partial, or full limited access control. Contact the local agencies to determine if they desire to participate in the installation of illumination for roadways under their jurisdiction as a part of the project. For improvement projects, consider additional illumination on state highways where there is a diminished level of service or an accident frequency during the hours of darkness.

*Diminished Level of Service* is a mobility condition where the nighttime peak hour level of service is D or lower. When volumes are used to determine the level of service, use traffic counts taken during the evening peak hour. Peaking characteristics in urban areas are related to the time of day. Traffic counts taken in the summer between 4:30 p.m. and 7:30 a.m. may be used as nighttime volumes if adjustment factors for differences in seasonal traffic volumes are applied for November, December, and January.

*Accident Frequency* condition is when the number of nighttime accidents equals or exceeds the number of daytime accidents. An engineering study that indicates that illumination will result in

a reduction in nighttime accidents is required to demonstrate justification. Consider the seasonal variations in lighting conditions when reviewing reported accidents. Accident reporting forms, using a specific time period to distinguish between “day” and “night,” might not indicate the actual lighting conditions at the time of an accident. Consider the time of year when determining if an accident occurred at nighttime. An accident occurring at 5:00 p.m. in July would be a daytime accident, but an accident occurring at the same time in December would be during the hours of darkness.

The mitigation of high nighttime, pedestrian accident locations requires different lighting strategies than vehicular accident locations. Provide light levels to emphasize crosswalks and adjacent sidewalks. Multiple lane highways with two way left turn lanes, in urban build up areas, are typically high speed facilities with numerous road approaches. These roadways allow numerous vehicle entry and exit points and provide few crossing opportunities for pedestrians. Additional illumination may be justified for this condition.

## **(2) Highways With Full Limited Access Control**

On the main line, consider full illumination if a diminished level of service exists and any two of the following conditions are satisfied:

- There are three or more successive interchanges with an average spacing of 1½ miles or less.
- The segment is in an urban area.
- The accident frequency condition exists.

At ramps, consider additional illumination when a diminished level of service exists and any of the following conditions are present:

- The ramp alignment and grade are complex.
- There are routine queues of five or more vehicles per lane at the ramp terminal due to traffic control features.
- The nighttime accident frequency condition exists.

At crossroads, consider additional illumination when a diminished level of service exists and the nighttime accident frequency exists. Also, consider additional illumination for tunnels, undercrossings, or lids on the crossroad.

## **(3) Highways With Partial or Modified Limited Access Control or With Managed Access Control**

Consider additional illumination if this segment of highway is in a commercial area and either a diminished level of service exists or the nighttime accident frequency exists and an engineering study indicates that nighttime driving conditions will be improved.

## **(4) Intersections Without Channelization**

Illumination of intersections without channelization is justified in urban areas and other locations if a nighttime accident frequency requirement is satisfied or the traffic volumes and movements would be improved with the installation of left turn channelization.

## **(5) Tunnels, Underpasses, or Lids**

Illumination is justified if portal conditions result in a brightness in the tunnel that is less than the measured daytime brightness of the approach roadway divided by 15 and the length to vertical clearance ratio is 10:1 or greater.

## **(6) Construction Zones and Detours**

Illumination may be justified if construction activities take place on the roadway at night. Illumination may also be justified for detours where the alignment and grade are unusual and require additional driver, cyclist, or pedestrian alertness.

## **(7) Transit Stops**

Transit stops with shelters are indicative of higher passenger usage and illumination is justified. This lighting consists of a single light standard positioned to illuminate both the transit pull-out area and the loading area. Additional illumination to highlight the loading area at transit stops with

significant, nighttime usage may be considered, if the transit company will provide the necessary funding for construction and maintenance.

### **(8) Bridges**

Justification for illuminating bridges is the same as that for highways with or without full limited access control, as applicable.

### **(9) Railroad Crossing Without Gates or Signals**

Illumination of these facilities is justified if there is a potential for nighttime accidents. Consider the extent of nighttime train activity in making this determination. Also, consider illumination if there is a probability that railroad cars will be stopped on the crossing during the nighttime.

### **(10) Walkways and Bicycle Trails**

Illumination of pedestrian walkways is justified if the walkway is a connection between two highway facilities. This might be between parking areas and rest room buildings at rest areas, between drop-off or pick-up points and bus loading areas at flyer stops, or between parking areas and bus loading areas or ferry loading zones, for example. Consider illuminating existing walkways and bicycle trails if security problems have been reported. Also, consider illumination if security problems are anticipated. In these conditions the walkways and bicycle trails are illuminated to security levels. Illumination to the level shown in Figure 840-6 is allowed only when approved by the Regional Administrator.

### **(11) Rest Areas**

Provide illumination at the roadway diverge and merge sections within rest areas and the parking areas as for a major parking lot.

## **840.06 Design Criteria**

### **(1) Light Levels**

Light levels vary with the class of highway, development of the adjacent area, and the level of nighttime activity. Light level requirements for highways and other facilities are shown in Figure 840-6. These levels are the minimum average

light levels required for a design area at the end of rated lamp life for applications requiring a spacing calculation. Light level requirements are not applicable for single light standard or security lighting installations. See Chapters 430 and 440 for design classes of highways.

The types of activity areas, shown below, are related to the number of pedestrian crossings. These crossings need not occur within a single crosswalk and can be at several locations along the roadway in an area with pedestrian generators. Land use and activity classifications are as follows:

- **High Activity.** Areas with over 100 pedestrian crossings during the nighttime peak pedestrian hour usage. Examples are: downtown retail areas, near stage theaters, concert halls, stadiums, and transit terminals; and parking areas adjacent to these facilities.
- **Medium Activity.** Areas with pedestrian crossings that number between 11 and 100 during the nighttime peak pedestrian hour usage. Examples are: downtown office areas, blocks with libraries, movie theaters, apartments, neighborhood shopping, industrial buildings, and older city areas; and streets with transit lines.
- **Low Activity.** Areas with pedestrian crossings that number less than 11 during the nighttime peak pedestrian hour usage. Examples are suburban single family areas, low density residential developments, and rural or semirural areas.

### **(2) Design Areas**

The design area is that portion of the roadway, parking lot, or other facility that is subject to the minimum light level, minimum average light level, and uniformity ratio design requirements. This encompasses the area between the edges of the traveled way along the roadway; the outer edges of the stopping points at intersections; and, when present, a bike lane adjacent to the traveled way. When the roadway has adjacent sidewalks with high or medium activity classifications, the design area includes these features.

Design area requirements for various applications are shown in Figures 840-1 through 840-5 and the following:

- One lane off-ramp. Two main line through lanes and the ramp lane, including gore area, from the gore point to a point 200 ft (minimum) down stream of the gore point. A 100 ft longitudinal tolerance either way from the gore point is allowed.
- Two lane off-ramp. Two main line through lanes and both ramp lanes, including gore area, from a point 200 ft upstream of the gore point to a point 200 ft downstream from the gore point. A 100 ft longitudinal tolerance either way from the gore point is allowed.
- One lane on-ramp. Two main line through lanes and the ramp lane, from a point where the ramp lane is 10 ft wide to a point 200 ft upstream. A 100 ft longitudinal tolerance either way is allowed.
- Two lane on-ramp. Two main line through lanes and the ramp lanes from a point where the ramp lanes are 22 ft wide to a point 200 ft upstream. A 100 ft longitudinal tolerance either way is allowed.
- Intersections channelized with pavement markings. The design area has two components, the intersection area and the approach areas. The intersection area is the area between the stopping points on both the main road and the minor road, including marked or unmarked crosswalks. The approach areas are the areas on the main roadway between the stopping point and where the left turn lane is full width.
- Intersections with raised channelization. The design area has two components, the intersection area and the approach areas. The intersection area is the area between the stopping points on both the main road and the minor road, including marked or unmarked crosswalks. The approach areas are the areas on the main roadway between the stopping point and where the left turn taper begins.

- Unchannelized intersection. The area between the stopping points on both the main road and the minor road, including marked or unmarked crosswalks.
- Railroad crossings. The roadway width from a point 50 ft either side of the track (the approach side only for one way roadways).
- Transit loading areas. The lane width and length designated for loading.
- Major parking lots. The entire area designated for parking including internal access lanes.
- Scale Platforms at weigh sites. The approach width from the beginning of the scale platform to the end of the platform.
- Inspection areas at weigh sites. The area dedicated to inspection as agreed upon with the Washington State Patrol.

### **(3) Light Levels for Tunnels and Underpasses**

Short tunnels and underpasses, with a length to vertical clearance ratio of 10:1 or less, normally do not have daytime illumination. Short tunnels with length to vertical clearance ratios greater than 10:1 are treated the same as an entrance zone on a long tunnel to establish daytime light levels. Nighttime light level requirements for short tunnels on continuously illuminated roadways are the same as the light level required on the roadway outside the tunnel.

Long tunnels are divided into zones for the determination of daytime light levels. Each zone is equal in length to the wet pavement stopping sight distance. The entrance zone beginning point is a point outside the portal where the motorist's view is confined to the predominance of the darkened tunnel structure.

The daytime entrance zone light level is dependent upon the brightness of the features within the motorist's view on the portal approach. The brightness level is defined as the average brightness measured over a 20 degree cone at a point 500 ft in advance of the portal. The entrance zone light level produced within the tunnel must

be sufficient to provide a brightness level of approximately 5% of the measured portal brightness, after adjustment for the reflectivity of the roadway, walls, and ceiling. Design successive zones for a daytime light level of 5% of the previous zone light level to a minimum value of 5 footcandles. Requirements for nighttime light levels for long tunnels on continuously illuminated roadways are the same as the light level required on a roadway outside the tunnel. Provide adequate illumination of fire protection equipment, alarm pull boxes, phones, and emergency exits in long tunnels to minimize the risk associated with catastrophic accidents.

#### **(4) Light Standards**

(a) **Light Standards.** Light standards are the most common supports used to provide illumination for highway facilities. The 40 ft and 50 ft high light standards with breakaway bases and Type 1 mast arms are used predominately on state highways. The angular Type 2 mast arms are allowed only to match existing systems. Use Type 1 mast arms on all new systems. Cities and counties may elect to use different mounting heights to address factors unique to their environments. On state highways, alternate light standards may be use if requested by the city or county, provided they agree to pay any additional costs associated with this change.

The typical location for a light standard is on the right shoulder. When considering designs that propose light standards mounted on concrete barrier in the median, consider the total life cycle cost of the system, including the user costs resulting from lane closures required for relamping and repair operations. Light standards located in the vicinity of overhead power lines require a 10 ft clearance from the power line to any portion of the light standard or luminaire. Consult the Bridge and Structures Office when mounting lights on structures such as retaining walls and bridge railings.

It is preferable to locate a light standard as far from the traveled way as possible to reduce the potential of impacts from errant vehicles. The length of the mast arm can vary from 6 ft to

16 ft to allow for this placement. The preferred position for the luminaire is over the edge line. However, some flexibility is acceptable with the luminaire position to allow for placement of the light standard. When necessary, the luminaire can be positioned up to 4 ft outside of the edge line. See Figure 840-7.

When light standards are located within the Design Clear Zone, breakaway features are used to reduce the severity of a potential impact. To allow these breakaway features to function as intended, it is preferred that they be installed on slopes that are 6H:1V or flatter (cut or fill slope). On fill slopes where flattening of the slope to achieve a 6H:1V slope is not practical, consider locating the light standard at least 12 ft beyond the slope break. If this is not possible, locate the light standard at the slope break. Do not place the light standard on a fill slope that is 3H:1V or steeper unless it is behind a traffic barrier.

When placing the light standard on a cut slope, that is 3H:1V or flatter (such as the backslope of a ditch), the preferred location is outside of the Design Clear Zone. If this is not practical, the light standard may be installed with a modified foundation that matches the slope's surface. In this case, it is critical that the light standard be positioned at least 4 ft beyond the bottom of the ditch. Locate light standards on slopes steeper than 3H:1V outside of the Design Clear Zone. Even when located beyond the Design Clear Zone, it is desirable to use a breakaway base if there is a possibility it could be struck by an errant vehicle.

In curb and sidewalk sections, locate the light standard behind the sidewalk.

Breakaway bases on light standards are a safety requirement for higher speed roadways. They are not always desirable at other locations. Locations where fixed bases are installed are:

- Parking lots.
- Medians where the light standard is mounted on median barrier.
- Behind traffic barrier, beyond the barrier's deflection design value (See Chapter 710).

- Along highways with posted speeds of 35 mph or less where there is medium or high pedestrian activity.
- Pedestrian walkways, bike paths, and shared use paths.

(b) **Light Standard Heights.** Non-standard pole heights require longer fabrication time and are not recommended. Use standard pole heights of 40 ft and 50 ft for roadway illumination. Standard pole heights will result in variable mounting heights for the luminaires. Use the actual mounting height at each location when calculating light standard spacing. High mast light supports may be considered for complex interchanges where continuous lighting is justified. Initial construction costs, long term maintenance, clear zone mitigation, spill-over light on to adjacent properties, and negative visual impacts are important factors when considering high mast illumination. Shorter light standards of 30 ft or less may be used for minor parking lots, trails, pedestrian walkways, and locations with restricted vertical clearance.

(c) **Standard Luminaire.** The cobra head style, high pressure sodium vapor luminaire with Type III, cut-off light distribution is the standard light source used for state highway lighting. A Type III distribution has an oval pattern, and a Type V distribution has a circular pattern. Post top mounted luminaires and other decorative light fixtures with Type V patterns are more effective for area lighting in parking lots and other locations where more symmetrical light distribution patterns are preferred. Recommended mounting heights and initial lumens for various luminaire wattages are shown in Figure 840-8.

## (5) Electrical Design

(a) **Circuit Layout.** Circuit layout is usually determined by line loss, control requirements, and maintenance considerations. Illumination systems normally operate on either 240 or 480 volts, single phase. Standard service cabinet installations provide two lighting circuits for Type B Services and five circuits for Type D or E Services. Although the electrical load can usually

be carried with one or two circuits, consider using multiple circuits for the lighting system. Multiple circuits are easier to install, maintain, and allow quicker location of circuitry failures. Consider providing separate circuits for each approach at intersections and at each ramp and the crossroad at interchanges. At major parking lots, consider providing at least two circuits for full illumination and another for security level lighting. Providing separate circuits for the inspection area, scales, and parking area at weigh sites allows more flexibility in controlling light levels.

(b) **Circuit Isolation.** Power feed conductors, from the power source to the service, are isolated from other circuits by using a separate conduit. Junction boxes in this conduit run are not allowed. Provide separate conduits for illumination circuits to isolate them from communication and traffic signal circuits on new construction. Illumination circuits may share a junction box with other circuits, including traffic signal detection and display circuits, provided that all circuits in the junction box are energized from the same service. When modifying an existing traffic signal, the installation of separate illumination conduits might be impracticable. In these situations, the illumination circuit conductors may be installed in the signal circuit conduit. When considering this, verify that all conductors in the conduit have an insulation rating equal to or exceeding the maximum circuit voltage applied to any conductor within that raceway. Ratings for various types of insulation are contained in the *National Electrical Code*.

(c) **Conductors.** Copper conductors are required for all permanent underground illumination circuits. Aluminum conductors may be used for temporary overhead illumination circuits. The conductor type installed between the utility power source and the service cabinet is specified by the utility company and is normally aluminum. The minimum conductor size for illumination circuits is a #8 AWG (American Wire Gage). Diameters, areas, ampacities, and resistance factors for various conductor sizes are shown in Figure 840-8.

(d) **Line Loss.** Line loss is the voltage drop between the electrical service and the electrical load. In illumination systems of four or five light standards that are located near the electrical service, line loss is not a factor. In more complex systems the voltage drop can be significant. The light standards farthest from the service might fail to energize if this loss is not compensated for by using larger electrical conductors or by splitting the system into two or more circuits. Some voltage drop is allowable. For design purposes, the allowable line loss for illumination circuits is 5% where the system might be expanded in the future. An 8% loss is acceptable when future expansion seems unlikely. A larger line loss of 10% is allowed for temporary illumination circuits on construction projects. Line loss is calculated by using the formula:

$$\text{Voltage Drop} = 2ALR.$$

Where: A = Current in amps  
L = Length of conductors  
R = Resistance of the conductor

An example of a line loss calculation is shown in Figures 840-9a and 840-9b.

(e) **Conduit.** The size of a conduit is dependent on the number and size of the conductors it contains. In new construction, size the conductors to occupy 26% of the cross-sectional area of the conduit. When modifying an existing system, the conductors can occupy up to 40% of the conduit's area. The table in Figure 840-8 lists the 26% and 40% cross-sectional fill areas of various conduit sizes. The minimum size conduit for illumination installations is 1 in diameter. The minimum size conduit for installation under a roadway is 1<sup>1/4</sup> in diameter.

Conduits are usually placed under existing pavement by jacking, drilling, directional boring, or by boring and casing.

- In jacking, the conduit is pushed under a roadway mechanically, usually with a hydraulic jack. A pointed tip is fitted to the leading end of the conduit to allow easier movement through the soil. Jacking is most effective when the underlying soil is free of rocks.

- In drilling, a small hole is first drilled under the roadway with an auger. Then either the conduit is attached to the auger and pulled back through the hole or the auger is retracted and the conduit is pushed through the hole.
- In directional boring, conduit is installed under the roadway using a surface launched steer-able high pressure fluid jet drilling tool. The drilling fluid maintains the stability of the tunnel, reduces drag on the conduit and provides backfill between the conduit and tunnel. A guidance system is used to measure the depth, lateral position and roll of the tool head while creating the pilot hole. Once the pilot hole is established, a reamer, a swivel and the conduit are attached to the end of the boring tool and the conduit is then pulled back into the tunnel. Multiple conduits may be pulled back into the pilot hole at the same time. Directional boring is used when: there are known objects under the roadway such as, fiber optical cable, sewer line, utility power cable, that must be avoided; the crossing distance is 30 ft or greater; and open cut trenching is not allowed.
- In boring and casing, a combination of drilling and jacking is used. An auger located in the leading end of a large diameter steel casing drills through the soil as the casing is being jacked under the roadway. The auger is then removed and conduits are placed in the casing. This type of installation is used when more than three conduits are required.

Open trenching to install conduits is allowed on existing roadways where substantial obstacles under the roadway will be encountered or where there is insufficient room for jacking pits at the edges of the roadway.

(f) **Overcurrent Protection Devices.** These devices are main breakers, branch breakers, and contactors contained within the service cabinet. They protect electrical conductors and components. Breakers are available in different amperage sizes to carry electrical loads. Size the branch breakers to at least 140% of the computed illumination circuit load. The breaker size cannot exceed the ampacity of the smallest conductor it

protects. The #10 pole and bracket cable is protected by fusing and is not a consideration in this sizing requirement. Size the main breakers to exceed 140% of all of the computed illumination loads and 125% of all other loads on the service. The minimum size main breaker is 60 amps.

Lighting contactors are used to switch the lighting circuits on and off. Contactors are used because the control equipment (photocell) operates on 120 volts and is not rated to carry the 240 or 480 volts of the lighting circuits. Size the lighting contactor to equal or exceed the branch breaker rating for the circuit it switches. Lighting contactors are available in 30, 60, and 100 amp ratings.

(g) **Control Equipment.** Photoelectric control devices and time clocks are used to control illumination circuits. The photoelectric control, with sunset turn-on and sunrise turn-off, is used for continuous nighttime operation. Continuous nighttime operation is used at the following locations:

- All required interchange illumination on highways with full limited access control.
- All additional illumination installed on highways with full limited access control.
- Illumination at intersections.
- Illumination at railroad crossings.
- Security lighting at bus loading zones at park and ride lots and at flyer stops.
- Security lighting in major parking lots.
- Security lighting for walkways at park and ride lots, flyer stops, ferry terminals, and rest areas.
- Illumination for parking areas and conflict points at rest areas.
- Detour illumination.
- Construction illumination.
- Illumination installed for accident frequency condition treatment on highways with managed access control.

- The single luminaire in the vicinity of the public telephone at weigh sites.

At certain locations, additional illumination is only required for short periods of time at night. The circuits for this illumination are controlled by a time clock or similar device. This device is designed to be overridden by the photoelectric control unit. This type of control is provided for illumination in excess of security levels in major parking lots, weigh sites, and bus loading areas in park and ride lots and flyer stops.

Other locations, such as tunnels with daytime lighting, require special controls. Controls are provided for circuits that energize certain fixtures throughout the day and night. Other controls energize additional fixtures to provide minimum daytime light levels, entrance zone light levels, and any subsequent zone lighting.

(h) **Light Level and Uniformity Calculations.** These calculations are used to determine the spacing of the luminaires to illuminate the design area. There are both manual methods and computer programs that can be used for these calculations. An example of the inputs and outputs of a computerized program are shown in Figures 840-10a through 840-10d.

## 840.07 Documentation

Preserve the following documents in the project file. See Chapter 330.

- A list of the facilities where the required illumination is provided.
- Justification and approval of proposals to install less than or more than the required illumination.
- Justification and approvals for any proposal to install additional illumination at other highway facilities.
- Justification for using nonstandard luminaires and light standards on state highways.



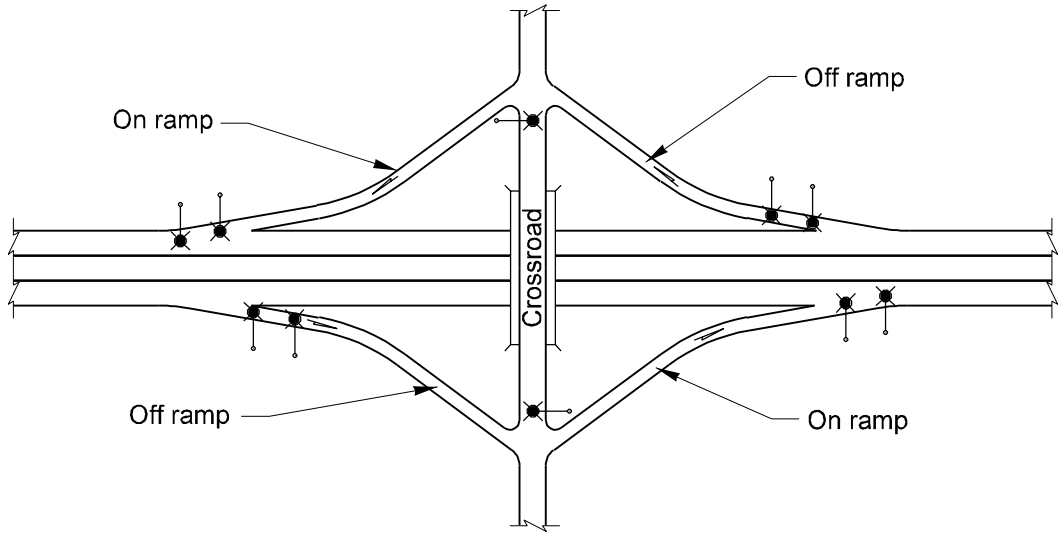

**Required Illumination for a Typical Diamond Interchange**  
 (Shown for single lane ramp connection and a two lane crossroad without channelization.)

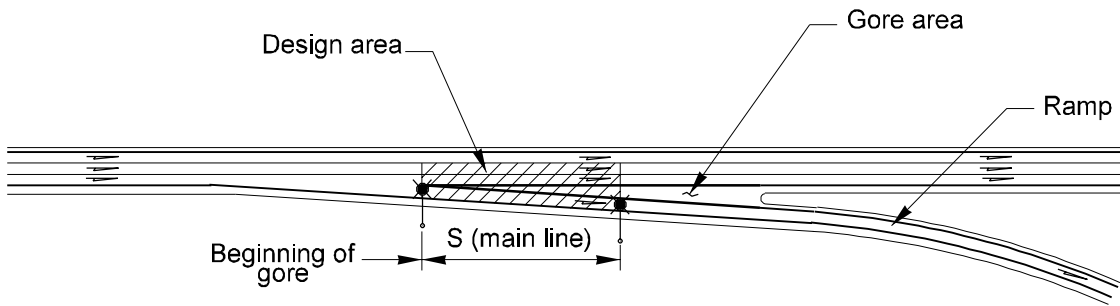

**Single Lane Off Connection**  
 (Light standards can be shifted up to 100 ft from the beginning of the gore.)

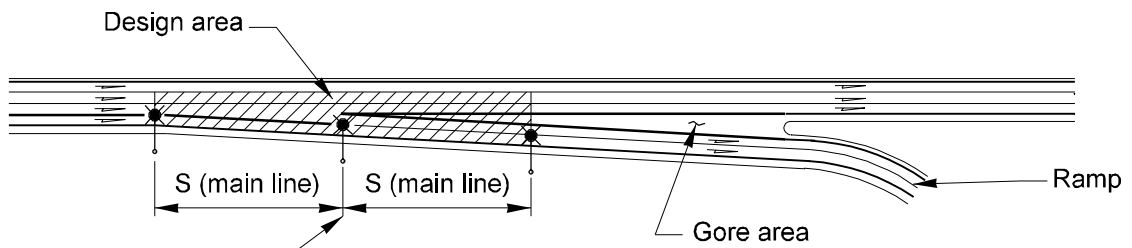

**Two Lane Off Connection**  
 (Light standards can be shifted up to 100 ft from the beginning of the gore.)

**Legend**

- S Distance between light standards that will result in an average light level that exceeds the requirements of figure 840-6.
- ✱ Light standards with mast arm mounted luminaire. (Locations are typical and not mandatory.)

**Freeway Lighting Applications**  
*Figure 840-1*

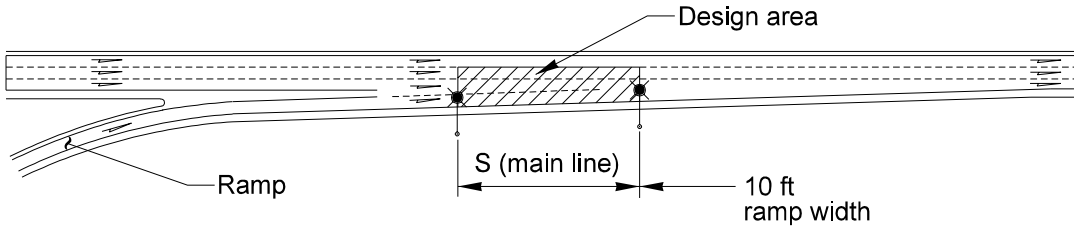

**Single Lane On Connection**

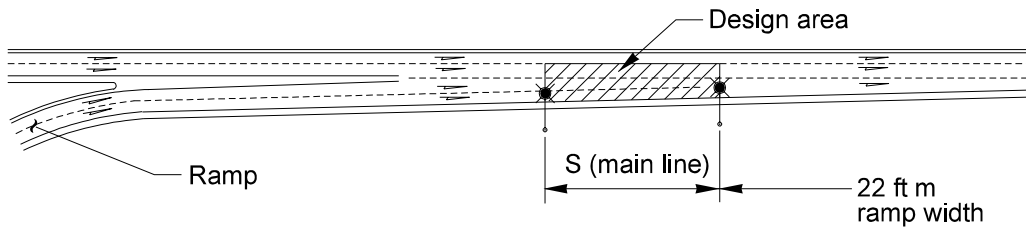

**Two Lane On Connection**

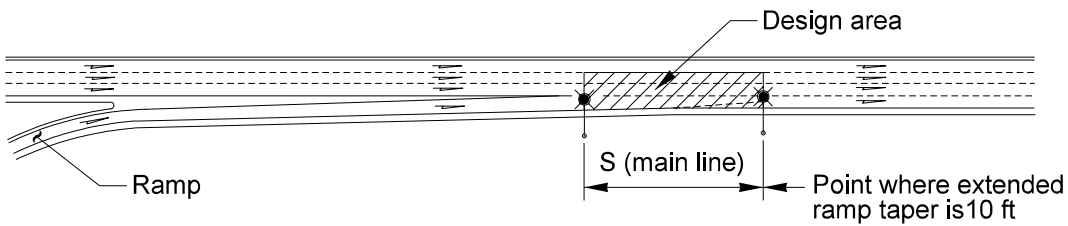

**Auxiliary Lane at On Connection**  
(Required only if significant weaving problem exists.)

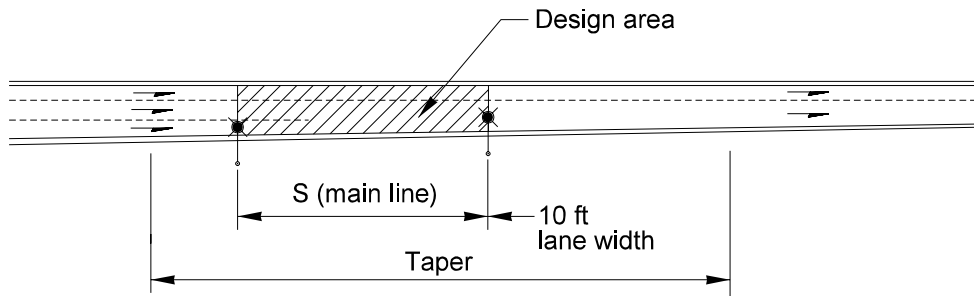

**Legend**

**Lane Reduction**

- S Distance between light standards that will result in an average light level that exceeds the requirements of figure 840-6.
- ✱ Light standards with mast arm mounted luminaire. (Locations are typical and not mandatory.)

**Freeway Lighting Applications**  
*Figure 840-2*

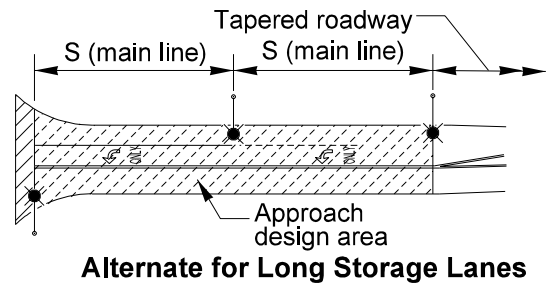
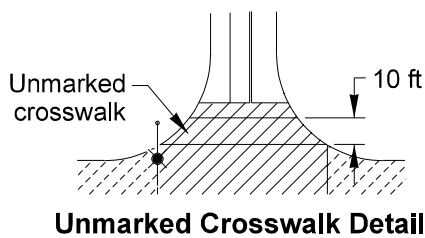
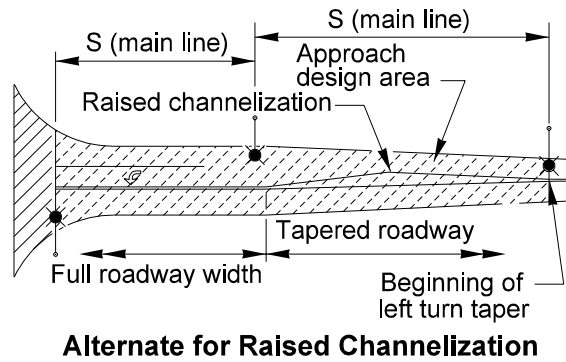
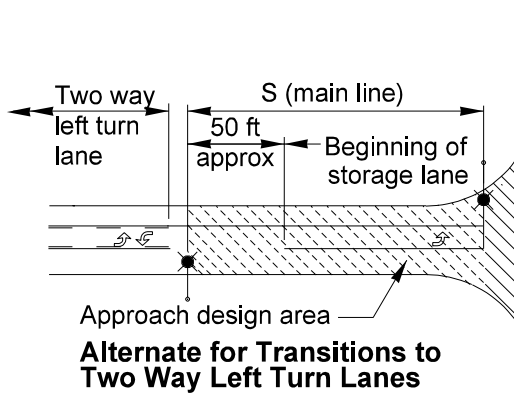
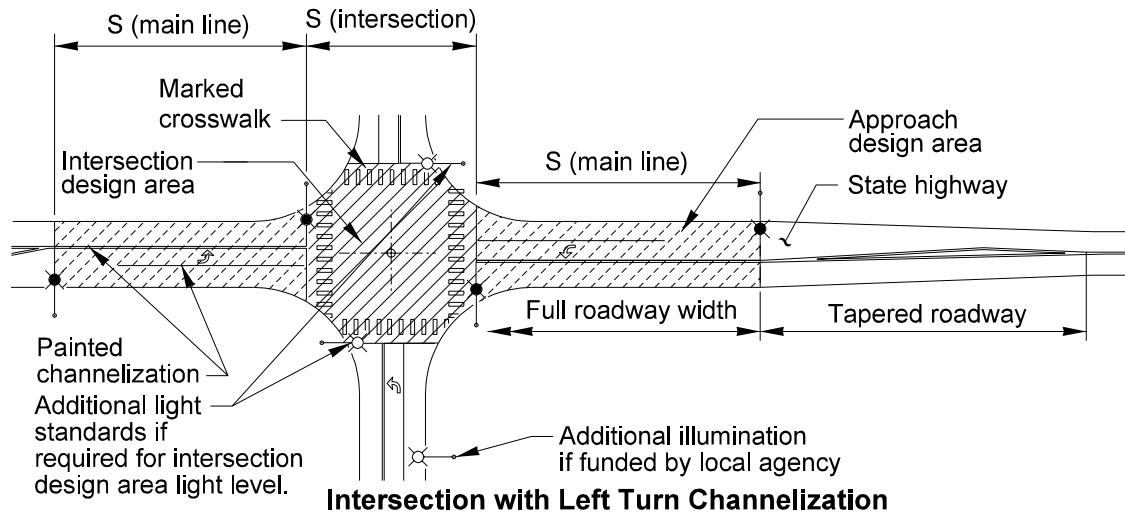

**Legend**

- S** Distance between light standards that will result in an average level that exceeds the requirements of Figure 840-6.
-  Light standard with mast arm mounted luminaire. (Locations are typical and not mandatory.)

**Roadway Lighting Applications**  
*Figure 840-3*

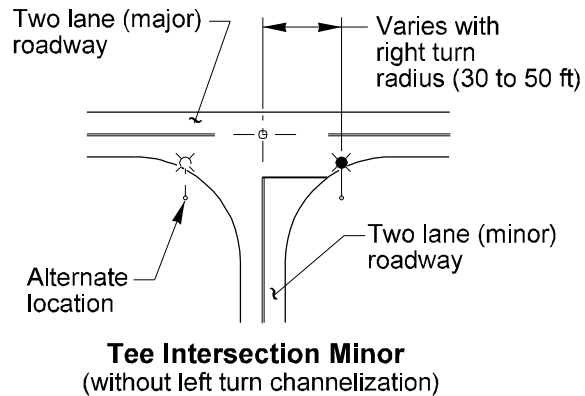
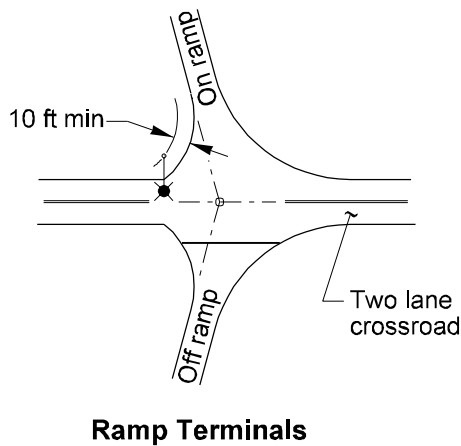
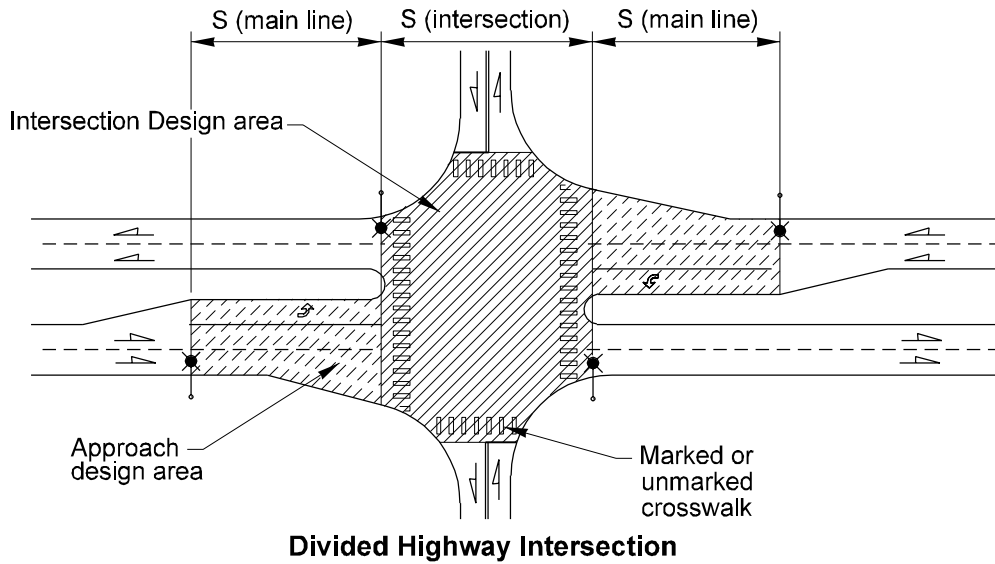

**Legend**

- S** Distance between light standards that will result in an average level that exceeds the requirements of Figure 840-6.
- ★ Light standard with mast arm mounted luminaire (Locations are typical and not mandatory.)

**Roadway Lighting Applications**  
*Figure 840-4*

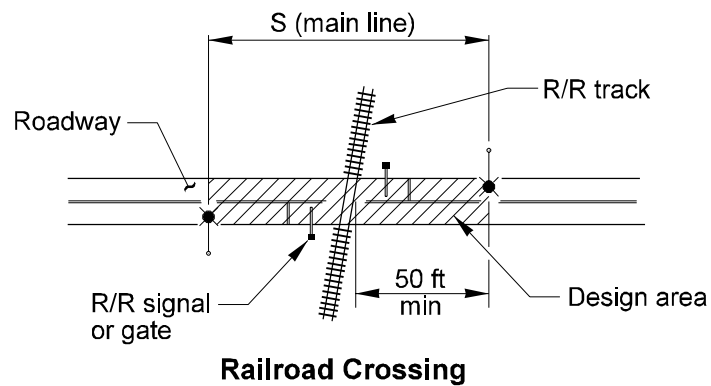
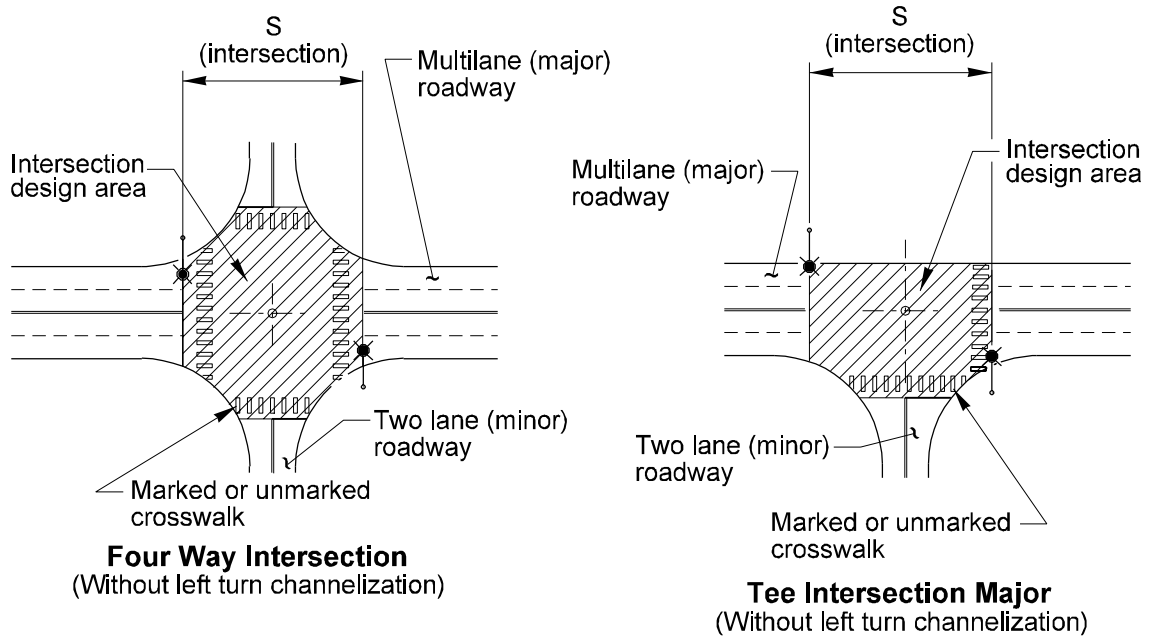

**Legend**

- S** Distance between light standards that will result in an average light level that exceeds the requirements of figure 840-6.
-  Light standard with mast arm mounted luminaire. (Locations are typical and not mandatory.)

**Roadway Lighting Applications**  
*Figure 840-5*

<b>Light Level and Uniformity Ratio Chart</b>					
<b>Highway Design Class</b>	<b>Average Maintained Horizontal Light Level</b>			<b>Maximum Uniformity Ratio<sup>(1)</sup> avg/min</b>	<b>Maximum Veiling Luminance L<sub>max</sub>/L<sub>avg</sub></b>
	<b>Pedestrian/Area Classification</b>				
	<b>High (footcandles)</b>	<b>Medium (footcandles)</b>	<b>Low (footcandles)</b>		
Highways with Full Limited Access Control					
Main Line	0.6	0.6	0.6	4 : 1	0.3 : 1
Ramps	0.6	0.6	0.6	4 : 1	0.3 : 1
Crossroads	0.6	0.6	0.6	3 : 1	0.3 : 1
Ramp Intersections <sup>(2)</sup>	0.9	0.9	0.9	3 : 1	0.3 : 1
Principal Arterials <sup>(3)</sup>					
Main Line	1.6	1.2	0.6	3 : 1	0.3 : 1
Intersections	1.6	1.2	0.9	3 : 1	0.3 : 1
Minor Arterials					
Main Line	1.1	0.8	0.6	3 : 1	0.3 : 1
Intersections	0.9	1.0	0.9	3 : 1	0.3 : 1
Collectors					
Main Line	1.1	0.8	0.6	3 : 1	0.3 : 1
Intersections	1.1	1.0	0.9	3 : 1	0.3 : 1
Construction Lanes and Detours	1.0	1.0	0.9	3 : 1	0.3 : 1
Parking Lots	0.8	0.8	0.8	3 : 1	0.3 : 1
Vehicle Inspection Areas	2.0	2.0	2.0	3 : 1	0.3 : 1
Walkways	0.8	0.8	0.8	3 : 1	0.3 : 1
Weigh Scales	0.8	0.8	0.8	3 : 1	0.3 : 1
Bus Loading Zones <sup>(4)</sup>	2.0	2.0	2.0	NA	0.3 : 1

**Notes**

- (1) The minimum light level is 0.2 fc for any application with an average light levels of 0.6fc. The minimum light levels for all other applications are controlled by the uniformity ratio.
- (2) Light level and uniformity ratio apply only when installation of more than one light standard is justified.
- (3) Light levels shown also apply to modified and partial limited access control.
- (4) Provide the light level at the location where the bus stops for riders.

**Light Levels and Uniformity Ratios**

*Figure 840-6*

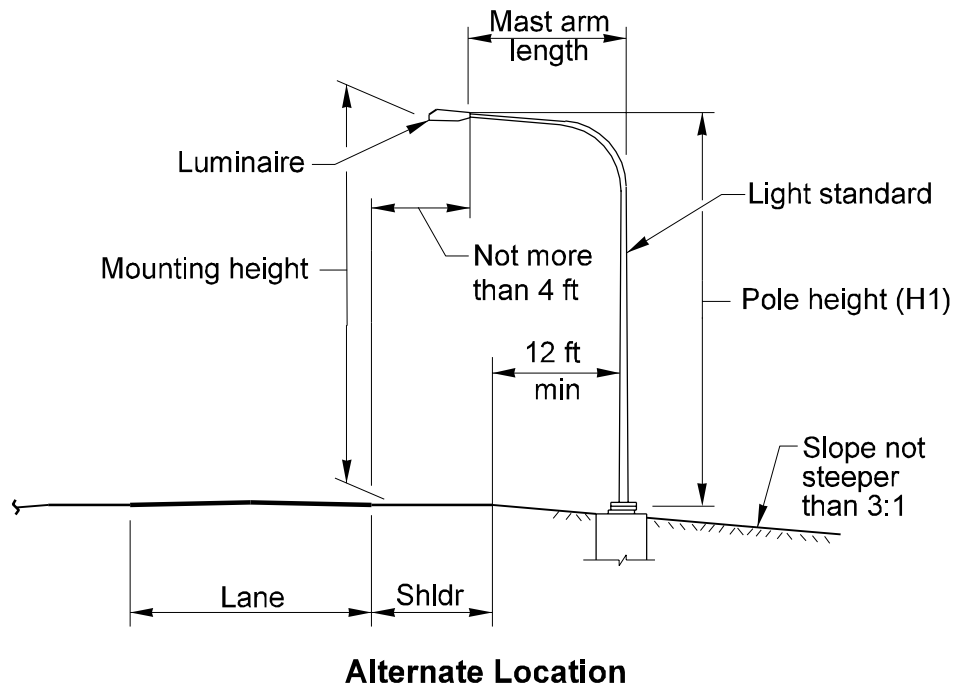
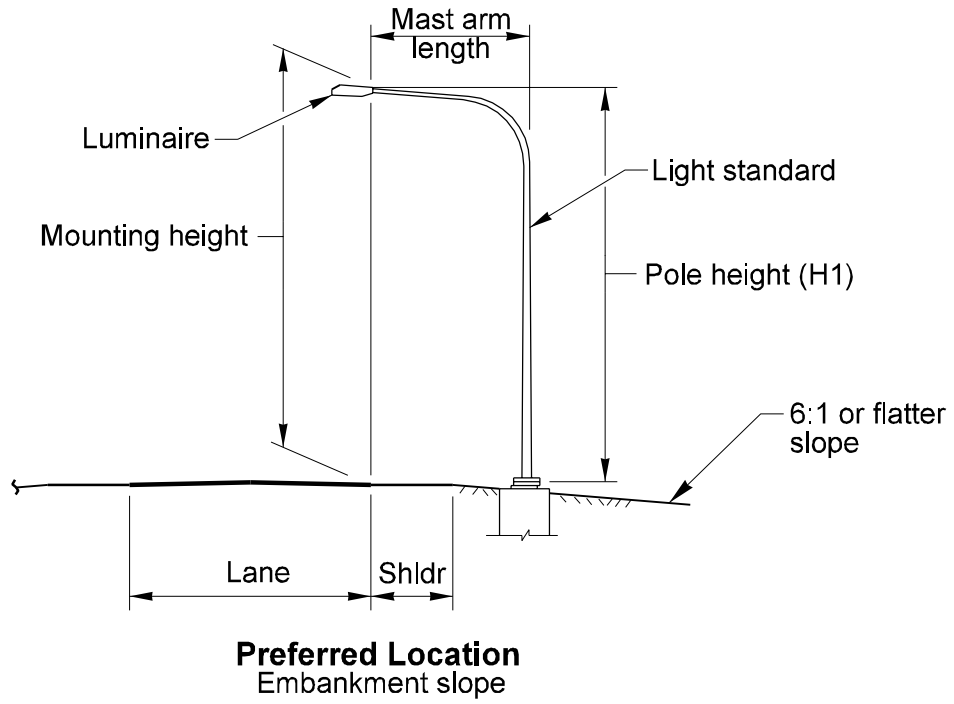

**Light Standard Locations**  
*Figure 840-7*

<b>Light Standard Heights</b>				
Luminaire Wattage	Initial Lumens*	H1	Recommended Mounting Height	
			Maximum	Minimum
200	22,000	30 ft	32 ft	28 ft
250	28,000	35 ft	38 ft	32 ft
310	37,000	40 ft	44 ft	36 ft
400	50,000	40 ft	44 ft	36 ft
400	50,000	50 ft	54 ft	46 ft
1,000	140,000	100 ft	110 ft	90 ft

\* Note: Lumens are for high pressure sodium vapor luminaires

<b>Conductor Properties Table</b>				
Size (AWG)	Area (inch <sup>2</sup> )	Ampacity (Amps)	Resistance Copper (ohms/foot)	Resistance Aluminum (ohms/foot)
# 14	0.021	15	0.003261	---
# 12	0.026	20	0.002051	---
# 10	0.033	30	0.001290	---
# 8	0.056	50	0.000809	0.001280
# 6	0.073	65	0.000510	0.000807
# 4	0.097	85	0.000321	0.000509
# 2	0.133	115	0.000201	---
# 1	0.190	130	0.000160	---
# 1/0	0.222	150	0.000127	---
# 2/0	0.262	175	0.000101	---

<b>Illumination Conduit Sizing Table</b>		
Trade Size (NEC)	Maximum Fill (inch <sup>2</sup> )	
	26%	40%
1"	0.23	0.35
1-1/4"	0.40	0.61
1-1/2"	0.54	0.83
2"	0.89	1.36
2-1/2"	1.27	1.95
3"	1.95	3.00
3-1/2"	2.60	4.00

**Light Standard Heights, Conductor, and Conduit Properties**  
*Figure 840-8*



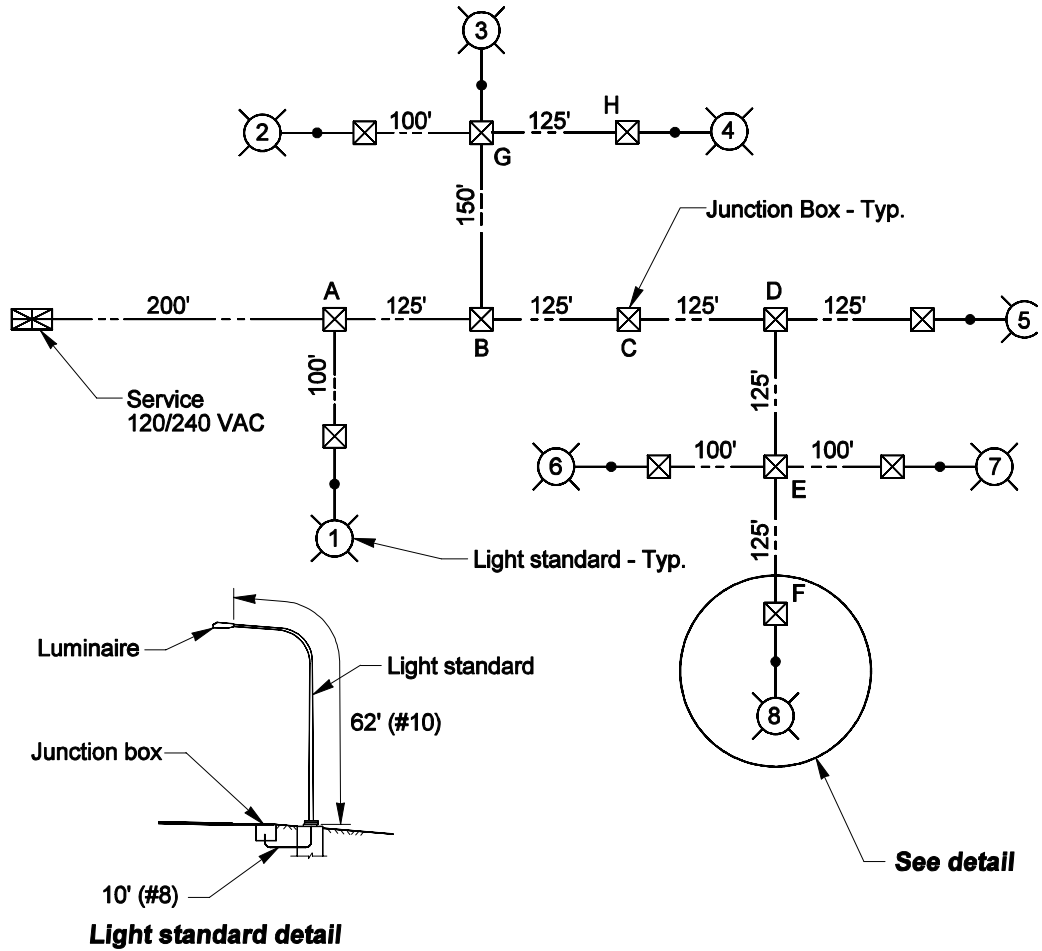

Given: 400 watt HPS luminaires 240 VAC, on 50 ft light standards with 16 ft mast arms and 120/240 VAC service.

Unit load = 400 watts / 240 VAC = 1.67 amps.

Unit load x Load Factor (1.2 for HPS) = 1.67 x 1.2 = 2 amps per unit.

Allowable Voltage Drop (5%) = 240 VAC x 5% = 12 volts

**SOLUTION**

**Step 1.** Calculate voltage drop to load furthest from service (Luminaire 8)

Circuit Segment	Conductor Size	Load on Segment	A Sum of Loads	L Length (Feet)	R Resistance	2ALR Voltage Drop	Sum of Volt Drop
Service to A	#8	8 2 amps	16	200	0.000809	5.18	5.18
A to B	#8	7 2 amps	14	125	0.000809	2.83	8.01
B to C	#8	4 2 amps	8	125	0.000809	1.62	9.63
C to D	#8	4 2 amps	8	125	0.000809	1.62	11.25
D to E	#8	3 2 amps	6	125	0.000809	1.21	12.46
E to F	#8	1 2 amps	2	135	0.000809	0.44	12.90
F to 8	#10	1 2 amps	2	62	0.001290	0.32	13.22

13.22 total voltage drop exceeds the allowed value of 12 volts

**Line Loss Calculations**  
Figure 840-9a

**Step 2.** Change conductor size to # 6 from service to A and recalculate voltage drop

Circuit Segment	Conductor Size	Load on Segment	A Sum of Loads	L Length (Feet)	R Resistance	2ALR Voltage Drop	Sum of Volt Drop
Service to A	# 6	8 @ 2 amps	16	200	0.000510	3.26	3.26
A to B	# 8	7 @ 2 amps	14	125	0.000809	2.83	6.09
B to C	# 8	4 @ 2 amps	8	125	0.000809	1.62	7.71
C to D	# 8	4 @ 2 amps	8	125	0.000809	1.62	9.33
D to E	# 8	3 @ 2 amps	6	125	0.000809	1.21	10.54
E to F	# 8	1 @ 2 amps	2	135	0.000809	0.44	10.98
F to 8	# 10	1 @ 2 amps	2	62	0.001290	0.32	<b>11.30</b>

11.30 total voltage drop is less than the allowable value of 12 volts

**Step 3.** Calculate voltage drop to Luminaire 4, using conductor sizes from Step 2

Circuit Segment	Conductor Size	Load on Segment	A Sum of Loads	L Length (Feet)	R Resistance	2ALR Voltage Drop	Sum of Volt Drop
Service to A	# 6	8 @ 2 amps	16	200	0.000510	3.26	3.26
A to B	# 8	7 @ 2 amps	14	125	0.000809	2.83	6.09
B to G	# 8	5 @ 2 amps	10	150	0.000809	2.43	8.52
G to H	# 8	1 @ 2 amps	2	135	0.000809	0.44	8.96
H to 4	# 10	1 @ 2 amps	2	62	0.001290	0.32	<b>9.28</b>

9.28 total voltage drop is less than the allowable value of 12 volts

**Branch Breaker Size** = 140% of load (16 amps) = 22.4 amps. Use 30 amp branch breaker.

**Circuit Ampacity** = The smallest conductor in the circuit is # 8 with an ampacity of 50 amps.

**Contact Size** = 30 amps, minimum size that exceeds the circuit load.

**Service Breaker Calculations**

Circuit	Load	Factor	A	N	B
Illumination - 240 VAC	16 amps	140%	22.4 amps		22.4 amps
Outlet - 120 VAC	15 amps	125%	18.75 amps		
Heat strip - 120 VAC	1 amp	125%	1.3 amps		
Total sized load			43 amps		22.4 amps

Use 60 amp main breaker (minimum allowed size)

**Line Loss Calculations**

*Figure 840-9b*

**Problem:**

Determine the light standard spacing and offset for the approach and intersection design areas for a channelized collector intersection at a location with a low pedestrian classification using the AGI 32 Lighting Design software.

**Given:**

Geometric Design:

- Design speed = 50 mph
- Design vehicle = WB-50
- Lane Width = 12 ft
- Shoulder width = 8 ft
- Sidewalk width = 6 ft
- Roadway cross slope = 2%
- Embankment section = 3:1 slopes
- Left turn storage length = 172 ft
- Right turn radius = 56 ft
- Right turn (T) = 20 ft
- Right turn (F) = 19 ft

Illumination Design:

- 50 ft light standard height (H1)
- 16 ft mast arm length
- 400 watt HPS luminaire
- Type III medium cutoff, light distribution
- 0.6 fc Avg. light level for approaches
- 0.9 fc Avg. light level for intersection
- 3:1 maximum uniformity ratio for all design areas
- 0.3:1 maximum veiling luminance

**Step 1:**

Determine the elevation of the top of the light standard slip base. Light standard is 16 ft from the edge of traveled way. Assume elevation at edge of traveled way is 3 ft.

Edge of shoulder elevation =  $3.0 - (8 \times 0.02) = 2.84$  ft.

Slip base elevation =  $2.84 - (8 \div 3) + 3.0 = 0.5$  ft.

**Step 2:**

Determine mounting height for 50 ft light standard.

Luminaire elevation =  $0.5 + 50.0 = 50.5$  ft

Edge of traveled way elevation = 3 ft

Mounting height =  $50.5 - 3.0 = 47.5$  ft

**Step 4:**

Place the calculation grid so that it adequately covers the outside limits of the desired statistical area.

**Step 3:**

Setup calculation plane.

Note: Always use 2 decimal points.

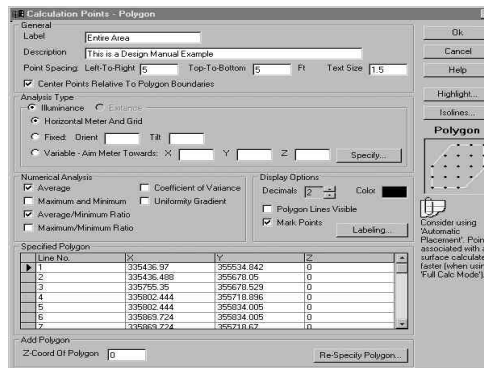
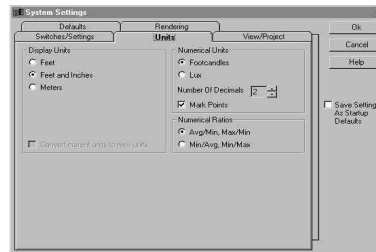

Note: Use a grid point spacing of 5 ft in both X and Y directions. Center the calculation grid between the grid boundaries. The coordinates in the Specified Polygon Section above refer to the grid points at the corners of the calculation grid area. When the CADD drawing is imported, the coordinate locations of all the points and lines are equal to the original CADD file. If desired, the imported CADD drawing can be moved closer to the grid origin of (0,0)

**Step 5:**

Place Statistical/Calculation Areas.

For the intersection, include all points within the back of shoulder and ahead of the stop bar.

For the approaches, include all points within the outside lane edge of each direction of traffic and the area between the stop bar and the end of full width in the left turn pocket.

**Illumination Calculation Example**  
*Figure 840-10a*

**Step 6:**

Define the luminaires and light standard.

Lumens for 400 watt HPS = 50,000

Tilt = 0

Light loss factor = 62%

Use photometrics file GE1002

Note: Arm length equals mast arm length plus the distance to the light source (16.0 + 1.5 = 17.5 ft)

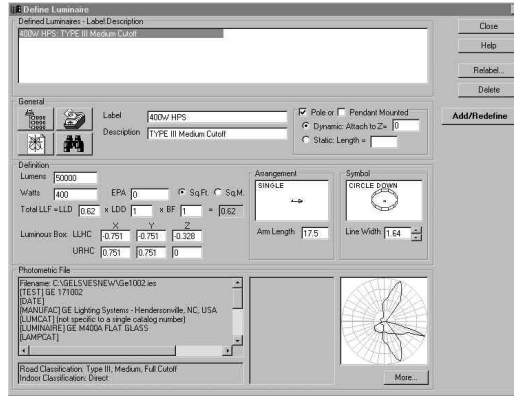

**Step 7:**

Place the luminaires. ht levels and uniformity values are obtained in their respective areas. This example uses a staggered pattern for light standard placement.

Note: The command line below describes the characteristics of the light standard and the luminaire being placed.



**Step 8:**

Calculate veiling luminance for the approaches and the intersection.

For these calculations, use the part of the program called the Roadway Optimizer.

Note: This step does not provide accurate outputs for high mast illumination.

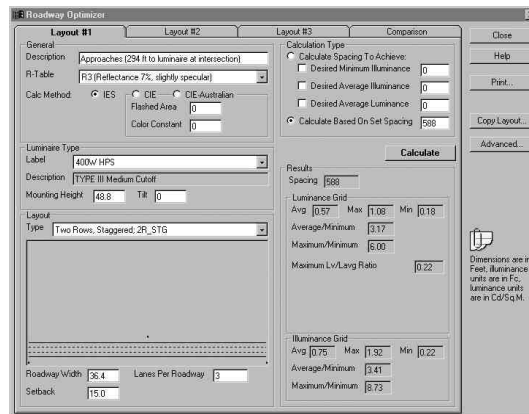

Intersection:  
 Spacing = 78 ft  
 Roadway width = 36.4 ft  
 Setback = 34.5 ft  
 Pavement type = R2  
 Number of lanes = 3  
 Luminaire mounting height = 50 ft

**Illumination Calculation Example**  
*Figure 840-10b*

**Step 8 (Continued):**

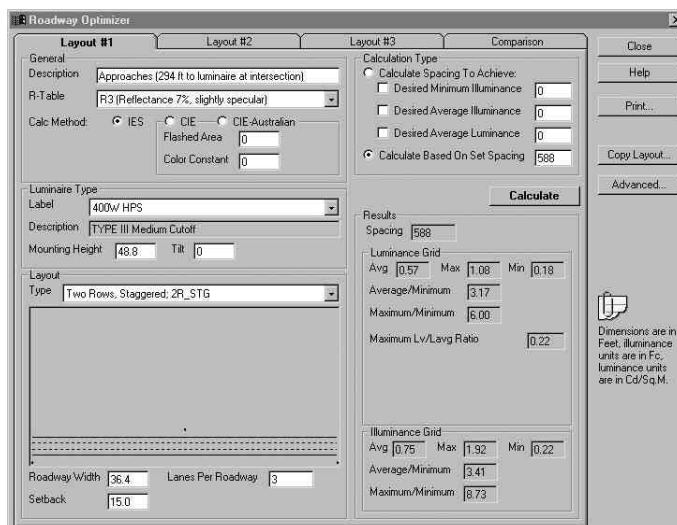

Approaches:  
 Spacing = 294 ft  
 Roadway width = 36.4 ft  
 Setback = 15.0 ft  
 Pavement type = R2  
 Number of lanes = 3  
 Luminaire mounting height = 50.0 ft

Notes: The Roadway Optimizer cannot account for differences in mounting heights between the approach and intersection luminaires. To compensate for this, use an average mounting height. An average mounting height of 14.87 m was used in these examples. The spacing of the luminaires is the distance shown in the examples. The spacing entered into the program is the distance to the next light standard on the same side of the roadway.

Program Outputs:

Statistical Area	Average fc	Minimum fc	Average/minimum	Veiling luminance
Intersection	1.51	0.50	3.00	0.11
Left Approach	0.6	0.23	2.61	0.22
Right Approach	0.6	0.23	2.61	0.22

**Results:**

Spacing on approaches = 294 ft with approximately 32.5 ft offsets from roadway centerline.  
 Spacing at intersections = 78 ft with approximately 53.0 ft offset from roadway centerline.

**Further explanation:**

Uniformity was the controlling factor in this example. By shortening the spacing on the approaches a lower value for uniformity can be obtained. The light standards at the intersection are set back to achieve the desired uniformity.

**Illumination Calculation Example**  
*Figure 840-10c*

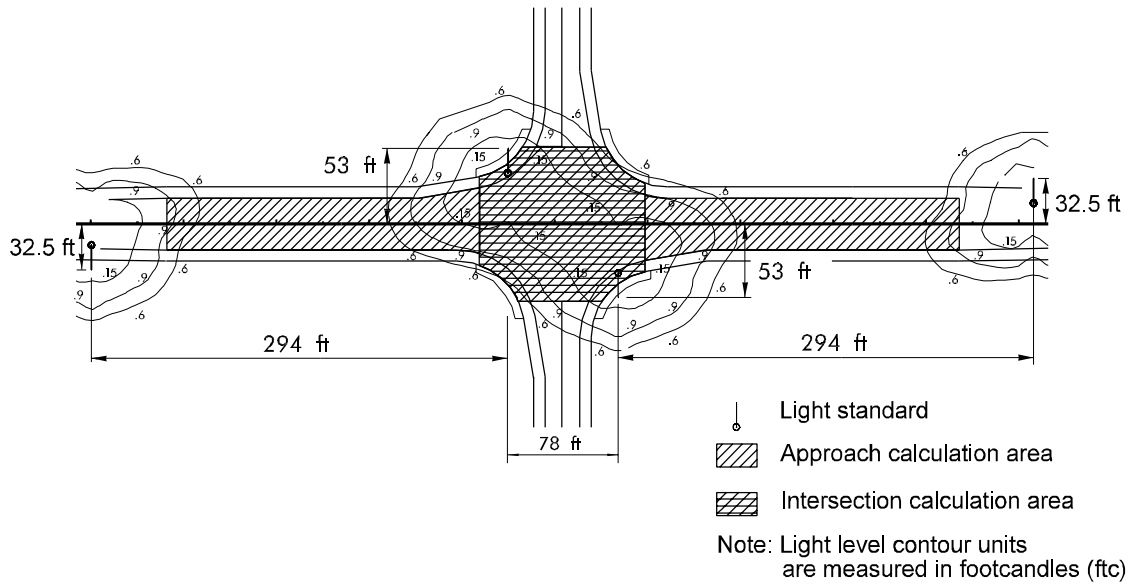

**Computer-Generated Plot (Plan View) of Light Levels**

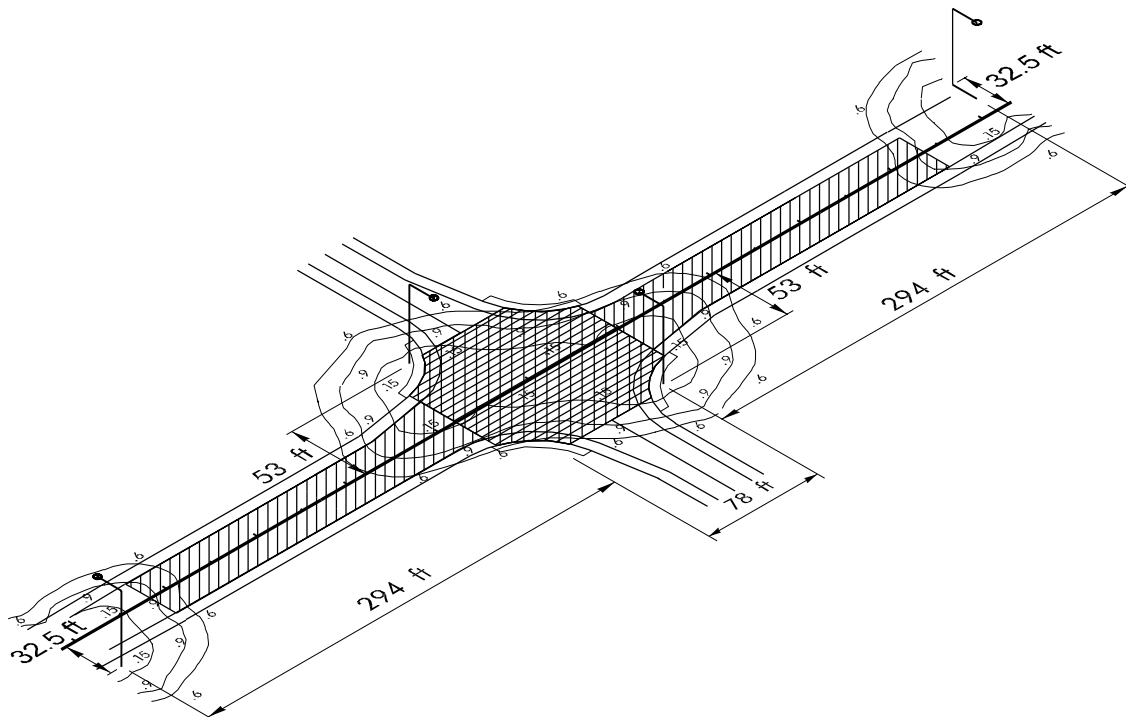

**Illumination Calculation Example**  
*Figure 840-10d*

# 850

## Traffic Control Signals

- 850.01 General
- 850.02 Policy
- 850.03 Approval Requirements
- 850.04 Signal Design
- 850.05 Contract Preparation

### 850.01 GENERAL

#### (1) Definitions

Traffic control signals are devices that warn or direct traffic to take specific action. Traffic control signals include the following types:

**Conventional Traffic Signal.** A permanent or temporary installation providing alternating right of way assignments for conflicting traffic movements.

**Emergency Vehicle Signal.** A special adaptation of a conventional traffic signal specifically installed to allow for the safe movement of authorized emergency vehicles. When not providing for the movement of emergency vehicles the signal shall either flash continuously consistent with the requirements for a conventional traffic signal or display continuous green (allowed at non-intersection locations only). At no time shall the system simply be de-energized.

**School Signal.** A special adaptation of a conventional traffic signal installed at established school crossings on the basis of a need to create adequate gaps in the vehicular stream for pedestrian crossings. When not operating as a school signal the system shall operate consistent with the requirements for an emergency vehicle signal during non-emergency intervals. At no time shall the system simply be de-energized.

**Intersection Control Beacon (Flashing Beacon).** A secondary control device supplementing "intersection" or "stop" signs. The display requirements for an intersection control beacon differ from those for a conventional traffic signal in that a minimum of one rather than two displays per approach is required. An intersection control beacon is used where high accident rates indicate a special hazard or where traffic or physical conditions do not justify conventional traffic signals. Intersection control beacons are used only at an intersection to control two or more directions of travel.

**Movable Bridge Signals (Drawbridge Signal).** A special type of signal, the purpose of which is to notify traffic to stop because of a road closure, rather than alternately assigning right of way to conflicting traffic movements.

**Lane Control Signals.** Special overhead signals having indications to permit or prohibit the use of specific lanes or to indicate the impending prohibition of use. Lane control signals are most often used for reversible lane control.

**Hazard Identification Beacon.** A hazard identification beacon is used to supplement an appropriate warning or regulation sign or marker. Display consists of circular flashing yellow. Use with "stop", "yield" or "do not enter" signs is not allowed.

**Ramp Meter Signal.** A special type of signal used to control the flow rate onto a freeway.

**Speed Limit Sign Beacon.** A speed limit sign beacon is used with a fixed or variable speed limit sign.

**Stop Sign Beacon.** A stop sign beacon is mounted above a stop sign.

#### (2) Compliance

The design, construction and operation of traffic control signals installed on state highways shall conform to the requirements contained in the following articles:

M 24-01 *Manual on Uniform Traffic Control Devices for Streets and Highways* as modified and adopted by WSDOT (MUTCD).

Revised Code of Washington (RCW):

- Chapter 35.77
- Chapter 46.61
- Chapter 47.24
- Chapter 47.36

Washington Administrative Code (WAC) 468-18-040 (DOT Resolution No. 1778).

Department Directives:

- D 55-03 *Responsibility for Traffic Control Devices, Pavement Widening, and Channelization at Existing Intersections and Two-Way Left-Turn Lanes in Cities.*

M 21-01 *Standard Plans for Road, Bridge and Municipal Construction.*

M 41-10 *Standard Specifications for Road, Bridge and Municipal Construction.*

M 22-87 *Utilities Manual.*

## 850.02 POLICY

### (1) Legal Basis

Policies regarding the installation and operation of traffic signals are based on Washington State laws, including the following:

RCW 46.61.085 Traffic control signals or devices upon city streets forming part of state highways — Approval by Department of Transportation.

RCW 47.24.020 Jurisdiction, control of such streets. 47.24.020(6) and (13)

RCW 47.36.020. Traffic control signals.

RCW 47.36.060. Traffic devices on county roads and city streets.

### (2) Valid Permit

As noted in the RCW's, the design and location of all traffic signals located on city streets forming parts of state highways must be approved by the department. By policy, approval is also required for all other traffic signals located on state highways. A valid traffic signal permit issued by the State Traffic Engineer constitutes this approval. As stipulated on the permit application, a sketch indicating the proposed operation must accompany the application. The validity and integrity of the permit is maintained by the submittal of reports of the actual construction of the signal and subsequent equipment or operational changes that occur thereafter. Permits are required for the following types of signals:

- Conventional Traffic Signals
- Emergency Vehicle Signals
- Intersection Control Beacons
- School Signals
- Reversible Lane Control Signals
- Movable Bridge Signals (Drawbridge Signals)
- Ramp Meter Signals
- Hazard Identification Beacons if installed overhead at an intersection are considered a type of intersection control beacon and will require a permit.
- Temporary or portable signals.

Emergency vehicle signals require annual permit renewal. The renewal is extended by a letter to the permit holder from the District Administrator with a copy to the State Traffic Engineer.

Hazard identification beacons, not installed overhead at an intersection, speed limit sign beacons, stop sign beacons and lane assignment signals at toll facilities do not require traffic signal permits.

When it is necessary to change the type of signal already installed at an existing intersection under valid permit, a new permit application will be required if the level of control is increased. For example, if it is necessary to

change an intersection control beacon to a conventional traffic signal, a new permit application is required. If the change results in a reduction in level of control, submit "Report of Change" Form 242-014 to the State Traffic Engineer.

### (3) Responsibility for Finance, Construction, Maintenance and Operation

Responsibility for the finance, construction, maintenance and operation of traffic signals has been defined by legislative action and commission resolutions. Figure 850-1 indicates various signal categories and agency responsibilities. The following rules are also applicable.

- (a) The Washington State Department of Transportation reserves the right to discharge any of its responsibilities through agreements with a third party. All such agreements shall be reviewed annually by all parties to determine the need for renegotiation.
- (b) At those locations where the Department of Transportation has jurisdiction but where funding schedules and priorities do not provide for the timely construction of a traffic signal which another governmental jurisdiction desires and is willing to finance, the department may permit a traffic signal to be constructed subject to the following:
  - Any signal installation so proposed shall conform to all pertinent requirements of the manuals, policies and directives identified herein.
  - A traffic signal permit application shall be submitted to and authorized by the Department of Transportation.
  - Detailed signal contract plans shall be submitted by the governmental jurisdiction to the District Administrator for forwarding to the State Traffic Engineer. The plans shall be submitted for review and approval prior to any plans being advertised for construction.
  - Final inspection of the project by the district involved will be required.
  - Subject to a formal letter of agreement, and after final inspection affirms that the installation is consistent with current design standards, the department may assume ownership, operational authority and responsibility.
- (c) Work performed under the heading "Responsibility to Maintain" is inclusive of only the physical maintenance of the equipment installed at the time of original installation and any other equipment installed at a later date due to changes in standards. When it is necessary to materially upgrade components by the addition of new signal heads, detectors, modernized signal controllers, etc., the cost associated with this work shall be proportioned in accordance with guidelines listed in Figure 850-1.



In such cases where existing signal equipment is removed, the salvage value of the removed equipment or the actual removed equipment will be distributed in accordance with guidelines listed in Figure 850-1.

- (d) The responsibility to finance the construction of conventional traffic signals, school signals, and intersection control beacons at intersections of county roads and state highways shall be consistent with Washington Administrative Code 468-18-040.
- (e) Any conventional traffic signal, school signal or intersection control beacon required at the freeway ramp terminal of a state highway shall be entirely the state's responsibility if the installation is located on state right of way.
- (f) The responsibility to finance, install, operate and maintain the components necessary to provide emergency vehicle pre-emption sequences and/or railroad pre-emption sequences at conventional traffic signal installations under state jurisdiction shall be as follows:
  - 1. The state will be responsible for all costs of pre-emption equipment, associated wiring, etc., necessary to provide railroad pre-emption where warranted by the MUTCD.
  - 2. The state will be responsible for all costs of pre-emption equipment, associated wiring, etc., that are installed permanently at the intersection necessary to provide emergency vehicle pre-emption on new signal projects or signal rebuild projects that are within an operating pre-emption system.
  - 3. All costs of equipment, associated wiring, etc., necessary to provide emergency vehicle pre-emption at existing signal installations will be the responsibility of others.
- (g) During any emergency vehicle pre-emption operation, a minimum of two displays per approach shall be provided. Emergency pre-emption of an intersection control beacon with a singular display on an approach is prohibited.
- (h) At signals inside cities with population under 15,000 where the state has responsibility for signals, the state will assume responsibility for constructing, operating and maintaining luminaires mounted on Type III or V Signal Standards. Any additional illumination will be the city's responsibility. Outside city limits or within access control, the state is responsible for intersection illumination (see Chapter 840).

### **850.03 APPROVAL REQUIREMENTS**

#### **(1) General**

For new signal proposals, approval by headquarters will be required for the permit, the preliminary signal plan,

and design reports not approved by the districts. For signal rebuilds, approval by headquarters will be required for the preliminary signal plans and design reports not approved by the districts.

The preliminary signal plan will not be approved until both the permit and design report are approved. It is preferred that these two be approved prior to the submittal of the preliminary signal plan.

#### **(2) Permit**

Items to be included with the permit application are noted on Form 242-014. The warrant analysis shall note the extent to which each warrant is met. The vehicular volume count information shall include turning movement counts and specifically note the right turn volumes. Show lane configuration, turning radii, and corner radii on the intersection sketch.

All applications shall be submitted to the State Traffic Engineer for approval.

If signalization projects are proposed by another agency, the application will be submitted to the local District Administrator, who will review the application, make a recommendation and then forward the application to the State Traffic Engineer.

Based on the calendar action of the State Maintenance Engineer, the State Traffic Engineer will either authorize the permit or will notify the District Administrator of rejection.

The permit is updated by filing "Report of Installation" and "Report of Change," both contained on Form 242-014. The turn-on date should be reported on the "Report of Installation" and any change in the type of signal or the control method should be reported on the "Report of Change."

Permits for emergency vehicle signals require annual renewal. The installations shall be reviewed by the District Administrator for compliance with state standards. Renewal is by letter from the District Administrator to the agency.

The signal permit should be approved before the design report is submitted for approval, or approved by the district. The design report will not be approved until the signal permit is approved.

#### **(3) Design Report**

(See Chapter 330)

(a) **New Installations.** The design report should include the following items:

- A statement of the problem that is being addressed by the installation of a signal.
- A discussion of what alternatives were considered, including cost estimates.

- A comparison of queue, delay and safety for all alternatives considered.
- (b) **Signal Rebuilds.** The design report should identify the specific reasons for the signal rebuild. The report should also include a warrant analysis to show that the signal is still required under both existing and proposed lane configurations.
- (c) **Intersections.** If channelization or other intersection revisions are proposed, see Chapter 330.

#### **(4) Preliminary Signal Plan**

The preliminary signal plan is submitted to the State Traffic Engineer for approval after the permit and design report are approved. If the design report was approved by the District Administrator, include a discussion of the items in (3), above. The State Traffic Engineer will notify the District Administrator of the approval or disapproval of the plan.

- (a) If the district is preparing the plans, specifications and estimates for the project, the preliminary signal plan (1 inch = 20 feet) shall include the following items:
- Turning radii, left turn and corner.
  - Stop bar locations.
  - Detector locations.
  - Signal standard type and locations.
  - Signal displays.
  - Phase diagram, including pedestrian movements.
  - Illumination treatment.
- (b) If headquarters is preparing the plans, specifications, and estimates for the project, the preliminary signal plan (1 inch = 20 feet) shall include the following items:
- Existing utilities, underground and overhead.
  - Existing and proposed intersection layout including proposed crosswalk locations, turning radii, stop bar locations and corner radii.
  - Existing and proposed illumination treatment.
  - Signal standard type and locations.
  - Signal displays.
  - Phase diagram including pedestrian movements.
  - Turning movement counts, peak hour for isolated intersections, a.m., midday, and p.m. peaks if there is another intersection within 500 feet.
  - Speed study indicating 90th and 10th percentile speeds for all approaches.
  - Detector locations.
  - Emergency vehicle pre-emption requirements.
  - Service location and power hookup requirements.

The submittal shall designate a contact person, charge numbers, and schedules. After the plans, specifications, and estimate have been prepared, the entire package will

be transmitted to the district for incorporation into the total project plans.

## **850.04 SIGNAL DESIGN**

### **(1) General**

The quality of a signal installation is a result of the knowledge, experience and decision-making ability of the designer. Throughout the development stages, the designer is required to make numerous decisions, often involving a compromise in one or more of the basic values of safety, driver comfort, efficiency, fuel consumption, maintainability and cost. Information contained herein and in previously mentioned references is intended to assist the designer in this decision-making process.

The goal of any signal design is to assign right of way in the most efficient manner possible, consistent with traffic volumes, geometrics and safety. Until recently, the predictive techniques available to the designer for evaluating the efficiency of alternate designs have been either too tedious or too inaccurate for practical use. The designer should always bear in mind that all predictive techniques are based on assumptions related to arrival rate distribution and driver behavior patterns that will vary depending on a number of factors. Techniques presented herein are most applicable for comparison of alternative designs for signals at isolated intersections. Variations in results may be significant when techniques are applied to multi-signal systems, although these techniques are still valuable for comparing the relative merits of alternative designs at individual intersections within the multi-signal system.

### **(2) Phase Analysis**

After all advanced engineering data has been collected, and after field conditions have been observed, the next step is to conduct a phase analysis. The goal of a phase analysis is to develop a timing pattern that will:

- Minimize total delay to all vehicles and pedestrians.
- Minimize delay to any single group of vehicles or pedestrians.
- Minimize accident potential and severity.
- Provide an adequate level of service on all approaches.

As a general rule, although there are exceptions, the fewer the phases, the more efficient the operation. The number of phases required for safe, efficient operation is related to intersection geometrics, traffic volumes, the composition of the traffic flow, turn demands and the level of driver comfort desired. Often, the most crucial decision encountered while conducting a phase analysis is whether or not to include protected left turn phasing. The volume output of an unprotected left turn movement is a function of the acceptable gap frequency of the opposing movement. In some cases, protected phasing can be justified

purely on this basis. In most cases, protected phasing may be justified based on a comparison of the delay for situations both with and without protected phasing. In borderline cases, the decision resolves to a comparison of the benefits of increased efficiency versus the level of driver comfort desired. As a general rule, protected left turn phasing should be considered if peak hour left turn volume exceeds 50 and the product of the turning and opposing through volume exceeds 50,000 for a single lane opposing movement and 100,000 for a double lane opposing movement. In addition, whenever left turn demand exceeds 300 vehicles per hour, installation of double left turns should be considered.

Delay is one of the more important measures of effectiveness available to the designer for evaluating the merits of alternative phase strategies. Total delay is defined as the time required for all vehicles approaching an intersection during the study period to traverse the zone of influence, minus the time required to traverse the same distance if no signal existed. Other significant measures of effectiveness include the following:

- Average queue lengths.
- Maximum queue lengths.
- Volume output.
- Total number of stops required.
- Fuel consumption.
- Number of vehicles caught in the dilemma zone.

Delay at traffic signals is related to the type of control equipment, phasing, time settings on the control equipment, the detection system and the arrival pattern. One method of evaluating alternative phase strategies is to compare levels of service. A capacity analysis will yield level of service factors. The "Webster" analysis technique offers a rational determination of the optimum cycle to minimize delay. The optimum cycle calculation with associated split determinations, when used with capacity analysis, offers a realistic common denominator for comparing alternative phasings.

The following example illustrates the "Webster" technique.

**Example Optimum Cycle and Split Calculation:** Calculate the optimum cycle and splits that will provide minimum delay for the intersection indicated in Figure 850-2, assuming the following,

- 5 phase operation.
- 7 second minimum green (G) time.
- 4 second amber (A) time.
- Minimum flashing don't walk (FDW) time is equal to the time required to walk from the curb to the center of the farthest lane at a rate of 4 feet per second.
- 20 foot average vehicle length.

- 2.1 second average saturation flow headway.
- Random arrival pattern.

(a) Formulas

- Webster Optimum Cycle Formula

$$C_o = \frac{(1.5L + 5)}{(1-Y)}$$

$C_o$  = Optimum cycle to minimize delay.

$Y$  = The total of the ratios of critical movements to saturation flows.

$L$  = Total lost time per cycle, including the time lost during queue startup, in addition to the time lost while the last vehicle in the queue travels from the stop bar to a point safely beyond the traveled way of the next conflicting movement.

- Australian Left Turn Factor Formula

$$EL = \frac{1.5}{\frac{fnSG}{(GnS-Q)} - \frac{fQC}{(GnS-Q)} + \frac{4.5}{G}}$$

$EL$  = Factor for converting unprotected left turning vehicles to equivalent passenger car units, (pcu).

$S$  = Saturation flow in vehicles per hour per lane, (vphpl).

$S$  = 3600 + average headway.

$C$  = Cycle length in seconds.

$n$  = Number of opposing lanes.

$G$  = Effective green time in seconds. Effective green time is defined as the green plus amber time for a phase, minus startup and termination losses.

$Q$  = Opposing straight through and right turning traffic in passenger car units (pcu) per hour.

$f$  = A function of the opposing flow ( $Q$ ) that varies as follows

$\frac{Q}{0}$	$\frac{f}{1.00}$
200	0.81
400	0.65
600	0.54
800	0.45

- (b) **Minimum Cycle Calculation.** The minimum cycle length, assuming considerable pedestrian activity, will be controlled by the minimum times set for phase 1 + phase 2 + phase 4 or by phase 5 + phase 6 + phase 4.

phase 1 = 7 sec. G + 4 sec. A = 11 sec.  
 phase 2 = 7 sec. W + 52/4 sec. FDW = 20 sec.  
 phase 4 = 7 sec. W + 64/4 sec. FDW = 25 sec.  
 Total = 56 sec.

The total for phase 5 + phase 6 + phase 4 is the same, since phase 5 G + A are equal to phase 1 G + A and phase 2 FDW time is equal to phase 6 FDW time.

(c) **Optimum Cycle Calculation.**

- Convert street volumes to equivalent passenger car units (pcu). Ideally, conversion factors should be developed from field measurements. Flow characteristics may vary significantly depending on local intersection conditions. For this example the following factors have been assumed:
  - Straight through passenger car = 1.0 pcu.
  - Left turning passenger car during protected phase = 1.1 pcu.
  - Right turning passenger car with turning radius 25 feet minimum and adequate lane width = 1.1 pcu.
  - Right turning passenger car with turning radius less than 25 feet or with narrow lane width = 1.3 pcu.
  - Truck or bus = 1.5 pcu.

Left turning passenger cars during a permissive phase are equal to the value obtained from the "Australian" formula. For this example an S value of 1714, a 90 second cycle and a 30 second effective green time for phase 4 have been assumed, resulting in a factor of 2.54 pcu for the north approach and 2.68 for the south approach.

Applying these factors to the traffic volumes results in the following equivalent passenger car volumes:

<u>Approach</u>	<u>Left</u>	<u>Straight</u>	<u>Right</u>
West	231	945	116
East	173	525	173
North	260	308	113
South	412	256	133

Applying the approach volumes to the intersection lane configuration results in the following hourly volumes.

<u>Approach</u>	<u>Lane</u>	<u>Phase</u>	<u>Movement</u>	<u>Volume</u>
West	A	1	1	231
West	B	6	6	530
West	C	6	6	530
South	D	4	4	412
South	E	4	4	389
East	F	5	5	173
East	G	2	2	349
East	H	2	2	349
North	I	4	8	340
North	J	4	8	341

The cycle length will be controlled by the critical lane volumes for the phase combination of phases (1 + 2 + 4) or phases (5 + 6 + 4).

Phase 1 lane A	= 231
Phase 2 lane G or H	= 349
Phase 4 lane D	= 412
<b>Total</b>	<b>= 992</b>
Phase 5 lane F	= 173
Phase 6 lane B or C	= 530
Phase 4 lane D	= 412
<b>Total</b>	<b>= 1115</b>

Phases (5 + 6 + 4) will control the cycle length. The ratio of critical flows to saturation flow can now be calculated.

$$Y = \frac{\text{Total critical flows}}{S}$$

$$S = \frac{3600 \text{ sec. per hour}}{2.1 \text{ sec. per vehicle}}$$

$$Y = (1115)/1714$$

$$Y = 0.651$$

Lost time per cycle can now be calculated. Lost time consists of the time lost during queue startup and time lost during phase termination. Startup losses vary with the queue length as follows:

<u>Queue (pcu)</u>	<u>Startup loss (seconds)</u>
1	1.7
2	2.7
3	3.3
4	3.6
5	3.7
6	3.7

Assuming a 90 second cycle, splits proportional to critical lane volumes and a uniform arrival rate, average queue length can be calculated.

Average arrival rates (g)

$$\text{Phase 5} = 173 \text{ vplph} = 0.048 \text{ vplps}$$

$$\text{Phase 6} = 530 \text{ vplph} = 0.147 \text{ vplps}$$

$$\text{Phase 4} = 412 \text{ vplph} = 0.114 \text{ vplps}$$

Red (R) times

$$\text{Phase 5} = (1115-173)/1115 \times 90 = 76 \text{ sec.}$$

$$\text{Phase 6} = (1115-530)/1115 \times 90 = 47 \text{ sec.}$$

$$\text{Phase 4} = (1115-412)/1115 \times 90 = 57 \text{ sec.}$$

Average queue length, (g)(R)

$$\text{Phase 5} = 0.048 \times 76 = 3.6 \text{ vehicles}$$

$$\text{Phase 6} = 0.147 \times 47 = 6.9 \text{ vehicles}$$

$$\text{Phase 4} = 0.114 \times 57 = 6.5 \text{ vehicles}$$

Based on average queue length, the following startup losses are determined:

- Phase 5 = 3.5 seconds
- Phase 6 = 3.7 seconds
- Phase 4 = 3.7 seconds

Phase termination losses include the time consumed while the last vehicle in the queue travels from the stop bar to a point safely beyond the traveled way of the next conflicting movement. It has been assumed that these vehicles are traveling at the approach speed, except the left turning Phase 5 vehicle where a 15 mph speed has been assumed.

- Phase 5 =  $(50' + 20') / 22'$  per sec. = 3.2 sec.
- Phase 6 =  $(60' + 20') / 44'$  per sec. = 1.8 sec.
- Phase 4 =  $(75' + 20') / 29'$  per sec. = 3.3 sec.

Combined startup and termination losses are as follows:

- Phase 5 = 3.5 sec. + 3.2 sec. = 6.7 sec.
- Phase 6 = 3.7 sec. + 1.8 sec. = 5.5 sec.
- Phase 4 = 3.7 sec. + 3.3 sec. = 7.0 sec.
- Total = 19.2 sec. = L

The optimum cycle to minimize delay can now be calculated.

$$C_o = \frac{(1.5L + 5)}{(1 - Y)}$$

$$C_o = \frac{(1.5 \times 19.2 + 5)}{(1 - 0.651)}$$

$$C_o = 97 \text{ seconds}$$

Splits are as follows:

- Phase 5 =  $173 / 1115 \times 97 = 15 \text{ sec. (G+A)}$
- Phase 6 =  $530 / 1115 \times 97 = 46 \text{ sec. (G+A)}$
- Phase 4 =  $412 / 1115 \times 97 = 36 \text{ sec. (G+A)}$

Based on a 97 second cycle and a G of 29 sec. (36 sec. - 7 sec. losses) for Phase 4 a new equivalent car factor for the south approach of 2.8 pcu results in a critical volume for lane D of 431 uph. Adjusting the calculations for this volume results in an optimum cycle of 100 seconds. Final splits are:

- Phase 1 = 25 sec. Phase 5 = 15 sec.
- Phase 2 = 37 sec. Phase 6 = 47 sec.
- Phase 4 = 38 sec. Phase 4 = 38 sec.

Based on these splits and cycle length, volume to capacity ratio and level of service can be determined as follows:

$$V/CP = \frac{Y}{1 - L/C_o}$$

$$V/CP = \frac{0.651}{1 - 19.2/97}$$

$$V/CP = 0.81$$

Level of service is selected from the following table:

V/CP	Level of Service
0 - 0.60	A
0.60 - 0.70	B
0.70 - 0.80	C
0.80 - 0.90	D
0.90 - 1.00	E

For these conditions, level of service is D.

Optimum cycle length also relates to level of service although the correlation is not nearly as accurate as that provided by "Y". As a general rule, if the optimum cycle calculation yields a cycle length in excess of 75 seconds for two critical phases, 100 seconds for three critical phases, or 140 seconds for four critical phases, the intersection warrants more study and measures to increase capacity should be considered.

Assuming the example intersection as the base condition, other alternatives have been investigated in an effort to increase capacity. Each case is identified as follows:

- Case 1 - Example intersection, 5 phase operation.
- Case 2 - Example intersection, 5 phase operation, add right turn lane on west approach.
- Case 3 - Example intersection, 6 phase split side street operation.
- Case 4 - Example intersection, 6 phase split side street operation, add right turn lane on west approach.
- Case 5 - Example intersection, 6 phase split side street operation, add right turn lane on west approach, widen side streets to provide left turn lane and two through lanes.
- Case 6 - Example intersection, 8 phase operation, add right turn lane on west approach, widen cross streets to provide left turn lane and two through lanes.

Results of each investigation are as follows:

Case	Con. Phases	Crit. Phases	Min. Cycle (sec.)	L.	Opt. Cycle (sec.)	"Y"	V/CP	LOS
1	5	3	56	19.2	97	0.65	0.81	D
2	5	3	59	19.2	89	0.62	0.79	C
3	6	4	81	26.1	164	0.73	0.87	D
4	6	4	84	26.2	143	0.69	0.84	D
5	6	4	87	26.3	114	0.61	0.79	C
6	8	4	73	26.2	111	0.60	0.78	C

Cases 2, 5 and 6 should be considered for improving intersection efficiency. Cases 3 and 4 should be rejected as viable alternatives.

(d) **Queue.** Queue lengths should be determined for all turn movements to ensure that adequate storage is available. A program is available through the State Traffic Engineer for computing average queue lengths. The program is based on Webster's methodology and uses an IBM PC. A program is also available for the T1-59 calculator. Average queue lengths should be adjusted to a 95% confidence level using the Poisson curve shown on Figure 3, page 558, *Traffic System Analysis for Engineers and Planners*, Martin Wohl and Brian V. Martin, McGraw-Hall, 1967.

Inputting a cycle length of 98 seconds, a three second amber time, a 3.7 second queue start up delay, a 3.2 second last car delay and an approach rate of 231 vehicles per hour for phase 1 yields an average queue of 5 vehicles and a 95% confidence level queue of 8 vehicles or 200 foot storage requirement.

### (3) Control equipment selection

After the phase analysis has been completed, the next step is to select control equipment. In most cases traffic actuated equipment is justified.

Actuated controllers are structured for either single timing ring or dual timing ring operation. See Figure 850-3.

Under fully loaded conditions the phases in any ring will time sequentially. Dual ring controllers offer the advantage of independent timing on non-conflicting movements.

At some intersections the required traffic patterns can be provided by different controller configurations or by utilizing different overlaps. An overlap is a control feature that can be used to provide a green display to an identified movement when any one of the phases included in the overlap is active. The NEMA Standard 4 phase and 8 phase controllers each provide 4 overlaps. Up to 4 phases can be included in an overlap on a 4 phase controller and up to 8 phases can be included in an overlap on an 8 phase controller, although this would result in a continuous display that should be accomplished by other means. Overlaps are identified by letter, A, B, C and D. It is the designer's responsibility to designate which phases are associated with each overlap. Figure 850-4 illustrates a tee intersection phase strategy that could be accomplished by three different methods. Controller I is a 4 phase frame, 4 phases and three overlaps. Controller II replaces Controller I overlap C with an independently timed phase. Controller II provides the flexibility and efficiency of dual ring independent timing. Controller III offers independent timing for movement 8 although it is doubtful if any efficiency can be gained since this movement receives green in any application except when movements 2 and 6 time.

### (4) Detection Systems

The detection system at an actuated traffic signal installation provides the control unit with information regarding the presence or movement of vehicles. Detection performs three basic functions: queue clearance, the calling of phases, and the termination of phases. Depending on the specific intersection characteristics, any one of these functions may take priority and a compromise must be reached that will weigh the merits of each function.

Queue clearance is the clearing of all vehicles that are waiting on an approach by continuous detection from the stop bar to a point between 30 feet and 50 feet from the stop bar. The detection zone must be long enough to insure that any gaps that may develop in the queue as it clears the intersection will not occur over the detection zone.

In some instances the calling and termination of phases will take priority over queue clearance. The call function is best served by detection that is placed such that the first vehicle waiting for green will be detected. During heavy traffic conditions this will occur at the stop bar and detection located for queue clearance will serve adequately. Under light traffic conditions, detection located well in advance of the stop bar will do a better job of calling the phase. With enough distance between the stop bar and the calling detector, a driver can receive a green indication before deceleration is required. The stop bar to detector distance in this situation is based on approach speed and side street clearance time.

The phase termination function assumes critical importance on high speed approaches, usually in excess of 35 mph. The exact detector location is often a compromise involving the values of safety and efficiency. A motorist approaching a signal during phase termination is forced to choose between two equally unattractive courses of action: proceed and risk collision at the intersection, or decelerate and risk rear end collision. This "indecision" or "dilemma" zone is normally assumed to occur between those distances from stop bar<sup>2</sup> that would require deceleration rates between 8 ft/sec<sup>2</sup> and 12 ft/sec<sup>2</sup>. Elimination of this "dilemma" zone requires detector placement in advance of this zone. Complete elimination of the "dilemma" zone could result in inefficient operation. In order to minimize phase termination delay, and thereby increase efficiency, green time should end as soon as the last vehicle can safely proceed through the intersection. This is usually taken to be when the last car reaches the stop bar, thus requiring detector location from the stop bar equal in travel time to the gap set on the phase module for that approach. As a general rule, assuming normal surface conditions and flat grade, a deceleration rate of 10 ft/sec<sup>2</sup> and one second perception reaction time may be assumed. For a 40 mph approach, the detector location would be  $S = V^2/2a + V$  or  $58.72/2 \times 10 + 58.7 = 231$  feet from stop bar.

In those instances where phase termination is being accomplished with advance detection but where stop bar detection is required because access to the approach is allowed between the advance detection location and stop bar, equipment should be provided to drop stop bar detection out of the controller input circuitry after queue clearance.

At locations where turn on red is heavy, the detection equipment for this movement should be provided with delay timers to prevent unnecessary call and extension.

After detector locations and type of control have been determined, the actual design of the detection system can begin. The detection provided on any approach should be sensitive enough to detect all classes of motor vehicles, including motorcycles. In addition, bicycle detection should be provided unless bicycles are prohibited on the approach or the control for the approach is planned to be operated in the recall mode.

In most cases, detection can best be accomplished with induction loops; however, at certain locations where significant amounts of horizontal steel exist, induction loops may not provide satisfactory operation and other types of detection such as magnetometers should be considered.

#### **(5) Pedestrian considerations**

The needs of the pedestrian shall be considered at all traffic signal installations where pedestrian activity might be expected. The pedestrian has the legal right to cross the roadway within any marked or unmarked crosswalk during the display of a vehicular green indication unless one or more of the following conditions exist:

- The vehicular green indicator consists of a sole green arrow controlling a vehicular movement in conflict with the pedestrian movement.
- The pedestrian has been otherwise directed by a pedestrian signal.
- Pedestrian crossing has been specifically prohibited by appropriate signing.

Pedestrian detection shall be provided for pedestrian movements when the associated vehicular movement is controlled by actuated equipment, unless pedestrian crossings have been prohibited.

Pedestrian signals shall be provided when one or more of the following conditions exist:

- Pedestrian warrants are satisfied.
- Potential pedestrian-vehicle conflicts exist due to split phase signal controls.
- Vehicular displays controlling pedestrian movements are not adequately visible to the pedestrian.

When pedestrian signals are not installed and vehicular signals provide sole pedestrian control, the displays should be carefully evaluated to insure that the control indications, especially if louvered or optically

programmed, are adequately visible to the pedestrian. All conventional vehicular signal heads that also function as pedestrian controls should be provided with cadet visors.

In consideration of the physically handicapped, curb ramps are now required on or near crosswalks at intersections. The law specifically requires location and construction of ramps to allow reasonable access to the crosswalk for physically handicapped persons without uniquely endangering blind persons. The law also requires that any ramp constructed at one end of a crosswalk shall be matched by a ramp at the other end of the crosswalk unless there is no curb or sidewalk at the other end. See WAC 236-60 and Chapter 1020.

Special attention should be directed to the location of pedestrian related facilities. Basic considerations include the following:

- Crosswalks should be located to minimize walk time and to minimize potential pedestrian-vehicular conflicts. In some cases, the complete elimination of an excessively long or high-potential-conflict crosswalk should be considered in the interest of safety and operating efficiency.
- Pedestrian detector locations should provide convenient access to pedestrians, including the handicapped. As a general rule, the pedestrian should not be required to deviate more than 5 feet from the normal path of travel in order to actuate the detector.
- The purpose and use of pedestrian detectors should be clearly identified.
- A detector should clearly identify which crosswalk it operates with.
- Pedestrian signals should be located in the line of the pedestrian's vision which pertains to the crosswalk being used.
- Pedestrian signal heads shall be positioned to provide maximum visibility at the beginning of the controlled crossings.

#### **(6) Signal Displays**

Signal displays are the devices used to relay right of way assignments and warnings from the control mechanism to the motorist and pedestrian. The most important objective to be considered when selecting display configurations and locations is the need to convey to the motorist and pedestrian in a clear and concise manner the nature of the right of way assignment. It is essential that display applications which imply false security be avoided. Typical display applications and time interval block are shown in Figures 850-5a and 5b. The time interval block diagrams include all intervals where any movement on the approach receives a green indication. In addition to the display requirements of the MUTCD, the following shall also apply:

- Vertical display configurations shall be used unless there are height restrictions.
- Conventional vehicle displays that control both vehicles and pedestrians shall be installed with cadet visors.
- Conventional vehicle displays that control only vehicle movements will normally be provided with tunnel visors.
- The special provisions or plans should specifically address the responsibility for programming and adjusting all optically programmed heads.
- If one section of a display warrants a 12 inch size, all sections should be 12 inches.

### **(7) Signal Supports**

Permanent traffic signal supports will consist of either metal mast arm supports or metal cable-strain pole supports. Timber strain poles are allowed only on temporary systems. Cable-strain pole supports should be considered if any of the following conditions exist.

- Where installation of aerial wiring will have an insignificant effect on the overall visual appearance of the intersection.
- Where it is difficult or impossible to obtain optimum signal display locations using conventional mast arm supports.

See Figures 850-6a and 6b to select strain pole class.

In the placement of signal supports, give primary consideration to ensuring proper visibility of signal faces. However, in the interest of safety, place signal supports and controller cabinets as far as practicable from the edge of the traveled way without adversely affecting signal visibility. (See the MUTCD for guidance in locating signal supports.)

Initial layouts for supports for vehicle display systems, pedestrian detection systems and pedestrian display systems should be accomplished independently to determine the optimal location of supports. If conditions allow and optimal locations are not compromised, pedestrian displays and pedestrian detectors can be installed on the vehicular display support.

If soil conditions are questionable, undertake an in-depth soils investigation.

### **(8) Controller Cabinets**

The selection of the controller cabinet location must be made in the early stages of plan development. The cabinet location should not restrict the lateral visibility of vehicular traffic. Ideally, the cabinet location should provide easy access for maintenance operations. The cabinet should be oriented to allow simultaneous reviewing of the controller and signal displays. Other considerations include the location of the power source and possible future widening.

### **(9) Miscellaneous Consideration**

- Underground Raceway Layout.** Cost, flexibility, ease of construction and ease of maintenance should be considered when laying out an underground raceway system. Cross-roadway runs should be minimized whenever possible. Cross-roadway runs should be located so that adequate room is available on both sides of the roadway for the required jacking or drilling operations.
- Junction Boxes.** Junction boxes should be provided at each end of cross-roadway runs, where conduit changes size, where detection circuit splices are required and at other locations that will facilitate ease of construction or maintenance. A signal standard or strain pole base should not be used as a junction box. Design capacities for various size junction boxes are shown in the standard plans.
- Conduit.** All underground raceways for a traffic signal installation shall be galvanized steel conduit. With the exception of the 1/2 inch conduit for the service ground conductor, the minimum size conduit for off-roadway runs is 1 inch. The minimum size conduit for cross-roadway runs is 1 1/4 inches. All conduits should be sized to provide 26 percent maximum conductor fill. See Figure 850-7.

## **850.05 CONTRACT PREPARATION**

### **(1) Plans**

Typical traffic signal plans are prepared to a scale of 1 inch = 10 feet or 1 inch = 20 feet. Elements that should be contained in the plans include the following:

- Existing Intersection Plan.** This plan depicts existing features including all known above ground and below ground appurtenances such as channelization, utilities, illumination systems, signal systems, drainage, items requiring removal, etc. In many cases the existing intersection plans can be combined with the signal plan.
- Signal Plan.** The signal plan identifies and locates all elements that are to be installed or modified. See Figure 850-8.
- Legend.** The legend identifies with symbols all elements shown on the existing intersection plan and the signal plan that are not identified by separate note. See Figure 850-8.
- Signal Display Identification.** The signal display identification consists of a schematic representation of each different type of vehicular and pedestrian signal display to be installed or modified on the project. Included with the signal display identification or in the special provisions are type, size, mounting, door, visor, backplate, and programming requirements. Backplates are required on all signals.



Signal head numbering consistent with Figure 850-9 is recommended.

- (e) **Phase Sequence Diagram.** Typical phase sequence diagrams are indicated in Figure 850-10a through 10d. Individual movements are identified within each phase block consistent with Figure 850-9.
- (f) **Signal Sequence Chart.** A signal sequence chart will be required for non-standard phasing or when overlaps are utilized. Standard applications will not require a sequence chart. A signal sequence chart for the example signal plan presented in Figure 850-8 is shown in Figure 850-11. The signal sequence chart identifies all displays and switching sequences for 100 percent of the time, including normal, pre-empt, and flash operation. The chart should indicate all displays, including arrow displays. The only exception to this rule is when a green arrow is electrically paralleled to a green ball display, only the green ball need be shown on the signal sequence chart. If state furnished controls are to be provided, a signal sequence chart will not be required as part of the contract.
- (g) **Wiring Schedule.** The wiring schedule identifies all raceways for size, type of wiring, and number of individual conductors and cables. See Figure 850-8.
- (h) **Wiring Schematic.** The wiring schematic relates circuitry to the physical components of the system. See Figure 850-12. Each conductor should be identified by a number code or a combination number-color code. Circuit numbering should correspond with the movement designations shown in Figure

850-9. All terminations should be identified and provision should be made for all spare wiring identified in the wiring schedule.

- (i) **Signal Standard Detail Chart.** The signal standard detail chart identifies mounting heights and orientations for all pole mounted appurtenances; in addition, all offset distances to mast arm mounted appurtenances are identified. The chart also identifies projected windload areas for all mast arm mounted appurtenances. Windload areas for 12-inch vehicle signal heads are computed as follows: single section, 4.4 square feet; add 2.4 square feet for each additional section. See Figure 850-13.
- (j) **Construction Notes.** The construction notes should provide all signal standard, controller cabinet and service locations and should reference any necessary details required for proper construction of the appurtenance. See Figure 850-8.

## **(2) Special Provisions**

Special provisions should include specifications covering materials, equipment, operational requirements or installation procedures that are not adequately covered in the plans or standard specifications.

## **(3) Estimate**

The cost estimate should be based on an itemized estimate of both material and labor costs. Since both material and labor charges are variable, it is essential that these prices be verified prior to estimate preparation.

**RESPONSIBILITY FOR VARIOUS TYPES OF FACILITIES ON STATE HIGHWAYS**

Figure 850-1

AREA	RESPONSIBILITY	EMERGENCY VEHICLE SIGNALS	TRAFFIC SIGNALS, SCHOOL SIGNALS & INTERSECTION CONTROL BEACONS	REVERSIBLE LANE SIGNALS, MOVEABLE BRIDGE SIGNALS
CITIES LESS THAN 15,000 POPULATION	FINANCE CONSTRUCT MAINTAIN OPERATE	ESA (1) ESA (1) ESA (1) ESA (1)	STATE STATE STATE STATE	STATE STATE STATE STATE
CITIES GREATER THAN 15,000 POPULATION	FINANCE CONSTRUCT MAINTAIN OPERATE	ESA (1) ESA (1) ESA (1) ESA (1)	CITY (2) CITY (2) CITY (2) CITY (2)	CITY (2) CITY (2) CITY (2) CITY (2)
BEYOND CORPORATE LIMITS	FINANCE  CONSTRUCT MAINTAIN OPERATE	ESA (1)  ESA (1) ESA (1) ESA (1)	STATE COUNTY STATE STATE STATE	STATE  STATE STATE STATE
FREEWAY RAMP TERMINALS	FINANCE CONSTRUCT MAINTAIN OPERATE	ESA (1) ESA (1) ESA (1) ESA (1)	STATE STATE STATE STATE	NOT APPLICABLE

(1.) ESA refers to the applicable Emergency Service Agency.

(2.) Applies to non-access controlled state highways only.  
For access controlled highways, see Design Manual Chapter 850.02(3)(h).

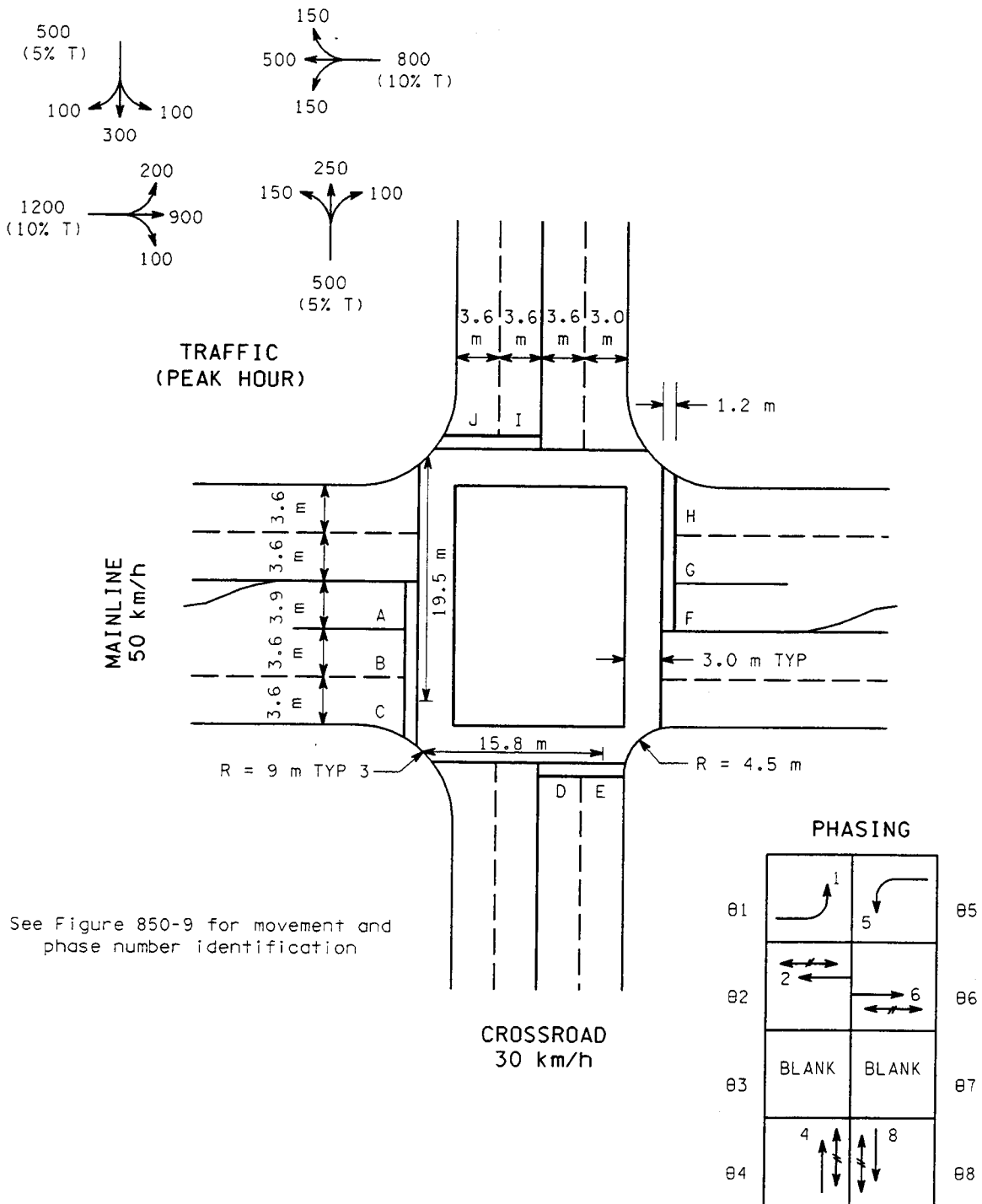

See Figure 850-9 for movement and phase number identification

**EXAMPLE OPTIMUM CYCLE AND SPLIT CALCULATION**

Figure 850-2  
(Metric)

**SINGLE RING FRAMES**

PHASES IN SINGLE RING CONTROLLERS TIME SEQUENTIALLY

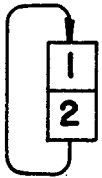

NEMA STD.

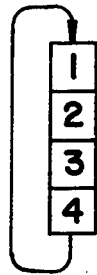

NEMA STD.

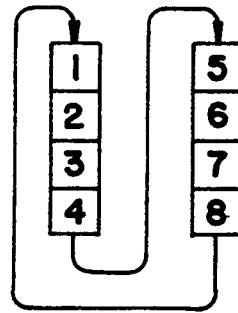

SPECIAL

**DUAL RING FRAMES**

PHASES IN EACH RING TIME SEQUENTIALLY. BOTH RINGS MUST ALWAYS CROSS THE BARRIER SIMULTANEOUSLY.

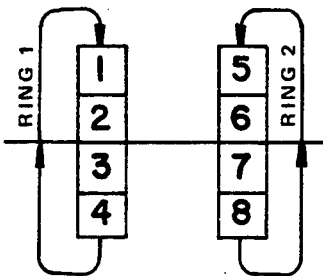

NEMA STD.

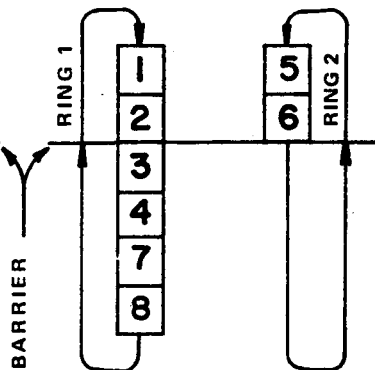

SPECIAL

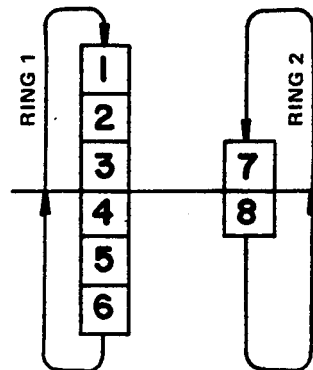

SPECIAL

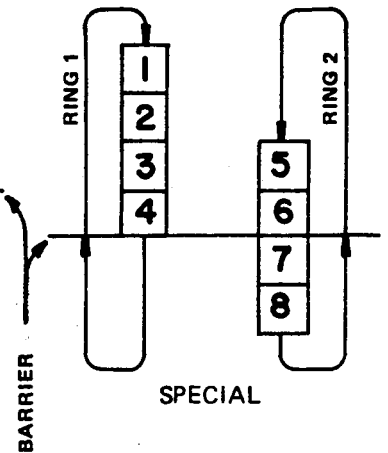

SPECIAL

**CONTROLLER FRAME CONFIGURATIONS**

Figure 850-3

TEE INTERSECTION - REQUIRED TRAFFIC PATTERN

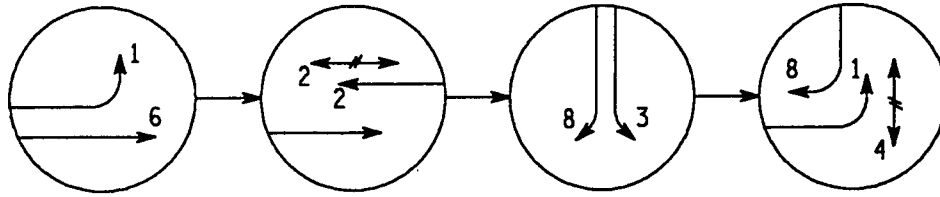

NOTE: See Figure 850-9 for movement identification

**CONTROLLER I**

FRAME - 4 Ø  
 PHASES - 4  
 OVERLAPS - 3  
 A (Ø1 + Ø4)  
 B (Ø1 + Ø3 + Ø4)  
 C (Ø1 + Ø2)

**CONTROLLER II**

FRAME - 8 Ø  
 PHASES - 5  
 OVERLAPS - 2  
 A (Ø1 + Ø4)  
 B (Ø1 + Ø3 + Ø4)

**CONTROLLER III**

FRAME - 8 Ø  
 PHASES - 6  
 OVERLAPS - 2  
 A (Ø1 + Ø4)  
 B (Ø1 + Ø8)

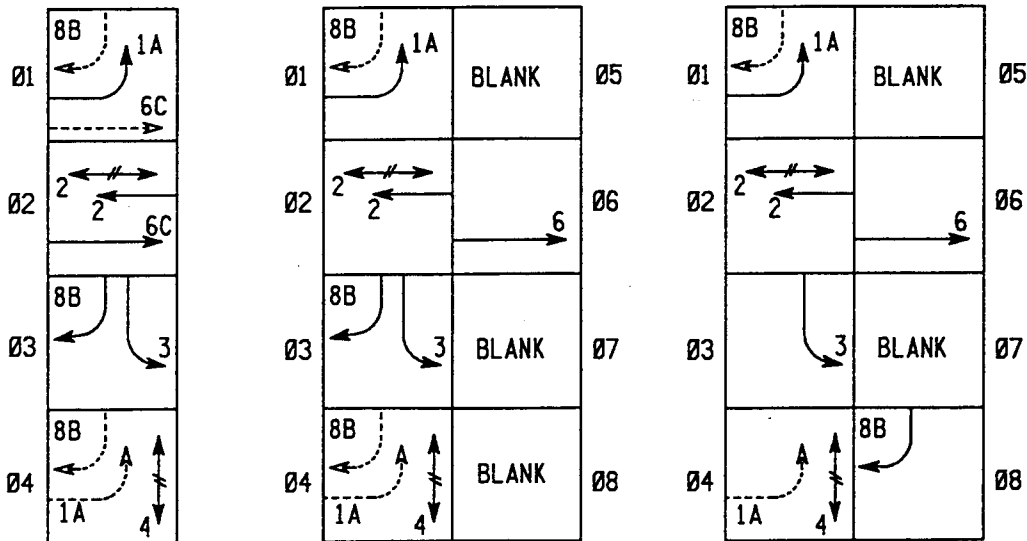

—————> TIMED DISPLAY, DETECTION FOR THIS MOVEMENT CONNECTED TO THIS PHASE.  
 - - - - -> OVERLAPPED DISPLAY, DETECTION FOR THIS MOVEMENT NOT CONNECTED TO THIS PHASE.

**CONTROL APPLICATION VARIATIONS**

Figure 850-4

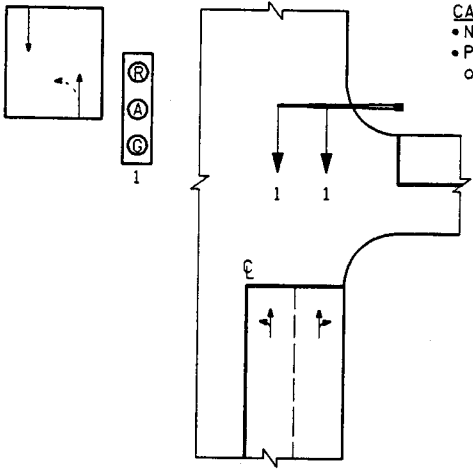

**CASE 1**  
 • No turn lane  
 • Permissive turns only

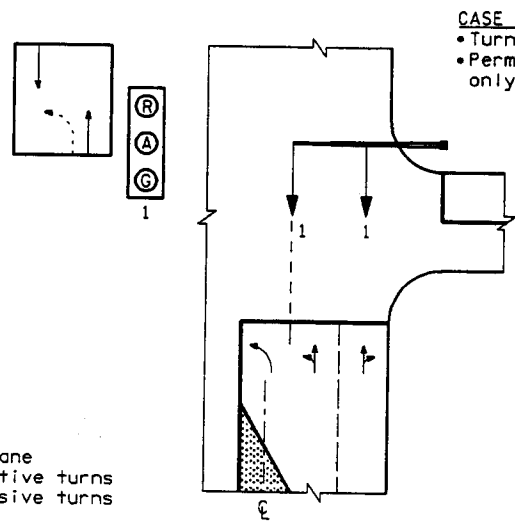

**CASE 2**  
 • Turn lane  
 • Permissive turns only

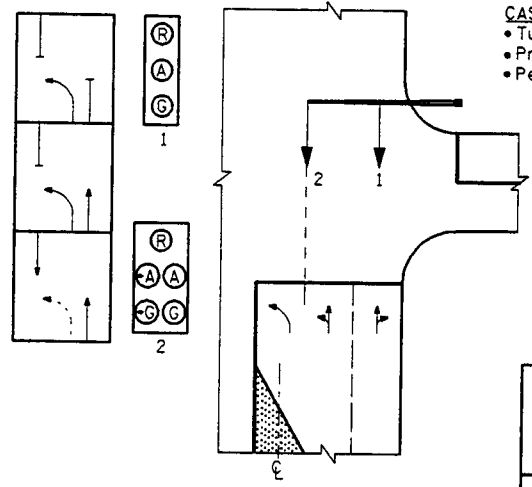

**CASE 3**  
 • Turn lane  
 • Protective turns  
 • Permissive turns

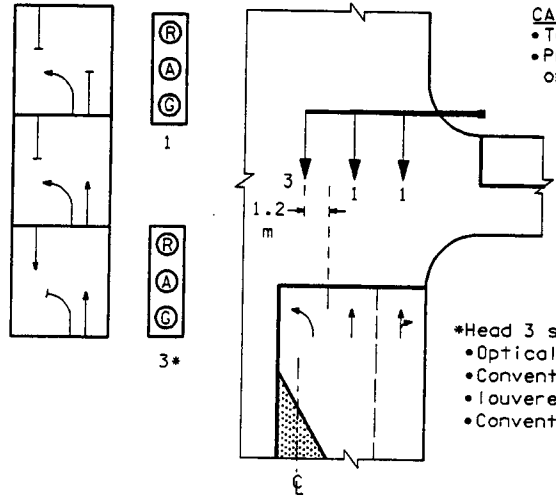

**CASE 4**  
 • Turn lane  
 • Protective turns only

\*Head 3 shall be:  
 • Optically programmed  
 • Conventional with  
 • Louvered red  
 • Conventional with sign

**SIGNAL DISPLAYS**

Figure 850-5a  
 (Metric)

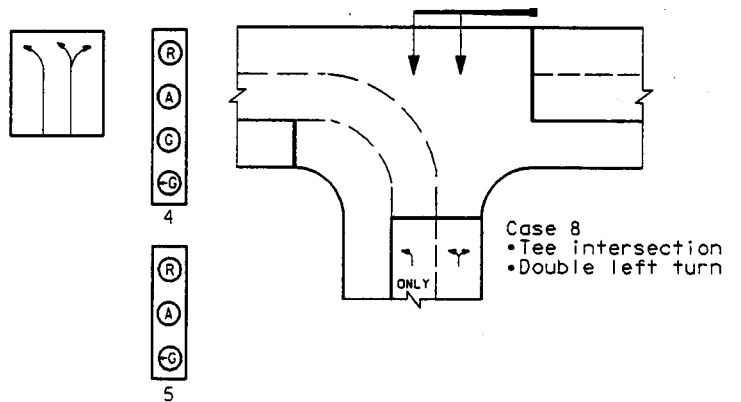
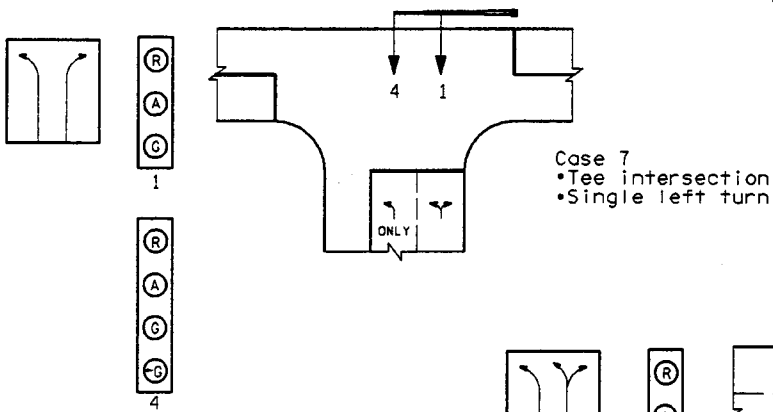
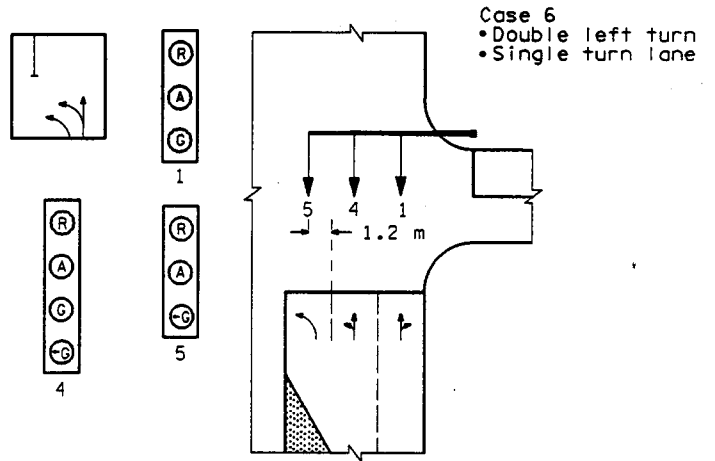
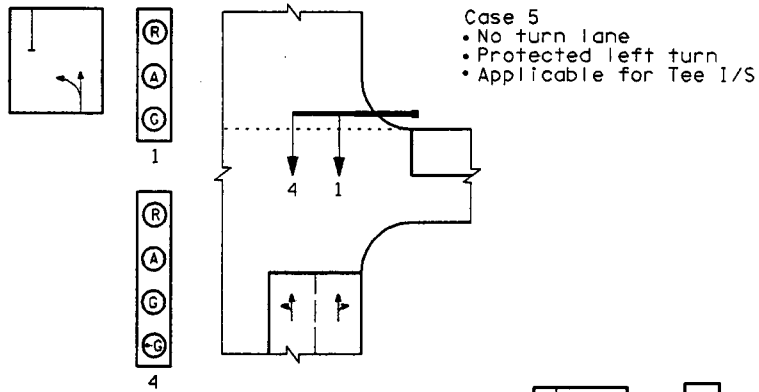

## SIGNAL DISPLAYS

Figure 850-5b  
(Metric)

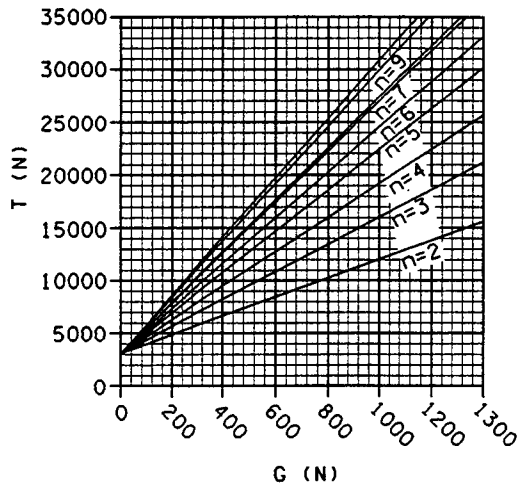

CHART 1 - Span Length 27 m and Less

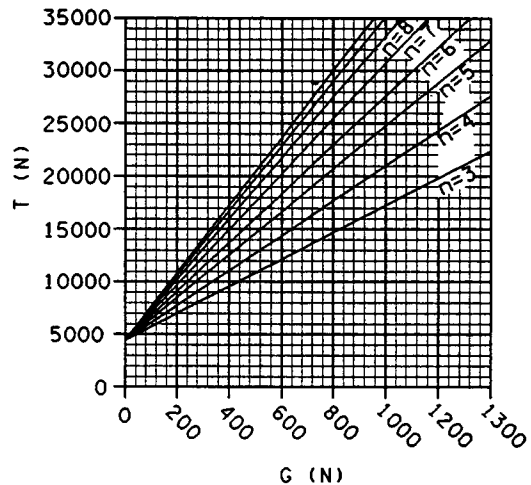

CHART 2 - Span Length 27.1 m to 36 m

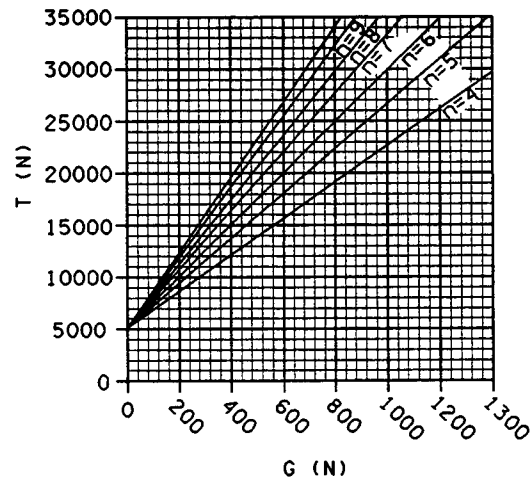

CHART 3 - Span Length 36.1 m to 45 m

### Strain Pole and Foundation Selection Procedure

1. Determine span length.
2. Calculate the total dead load (P) per span. Use 178 newtons per signal section and 300 newtons per square meter of sign area.
3. Calculate the average load (G) per span.  $G = P/n$  where n is the number of signal head assemblies plus the number of signs.
4. Determine cable tension (T) per span. Enter the proper chart with the average load (G) and number of loads (n). If (n) is less than minimum (n) allowed on chart, use minimum (n) on chart.
5. Calculate the pole load (PL) per pole. If only one cable is attached to the pole, the pole load (PL) equals the cable tension (T). If more than one cable is attached, (PL) is obtained by computing the vector resultant of the (T) values.
6. Select the pole class from the "Design Table." Choose the pole class closest to but greater than the (PL) value.
7. Calculate the required foundation depth (D). Use the

formula: 
$$D = a \frac{D_T}{\sqrt{S}}$$

Select the table foundation depth ( $D_T$ ) from the "Design Table." Soil bearing pressure (S) is measure in Pa. The foundation formula variable (a) is for  
 1 m round foundation, a=350  
 1.3 m round foundation, a=300  
 1 m square foundation, a=290

Round (D) upwards to nearest whole number if 30 mm or greater.

8. Check vertical clearance (5 m minimum) assuming 8.7 m maximum cable attachment height and 5% minimum span sag.

Notes: A special design by Office of Bridge and Structures will be required if:

1. Span length exceeds 45 m.
2. (PL) value exceeds 32000 N.
3. Distance between base plate and first cable attachment exceeds 8.7 m.

Charts are based on a cable weight of 44 newtons per meter (18 N/m and conductors, 26 N/m ice). Total dead load (P) includes weight of ice on sign or signal selection.

On Timber Strain Pole Designs, specify two guy wires when the (PL) value exceeds 20000 N.

Design Table	
Pole Class (Newtons)	Foundation Depth ( $D_T$ )
8450	1.9 m
12000	2.2 m
16450	2.5 m
21350	2.9 m
24900	3.1 m
28000	3.4 m
32000	3.7 m

### STRAIN POLE AND FOUNDATION SELECTION PROCEDURE

Figure 850-6a  
(Metric)



**Example Application:**

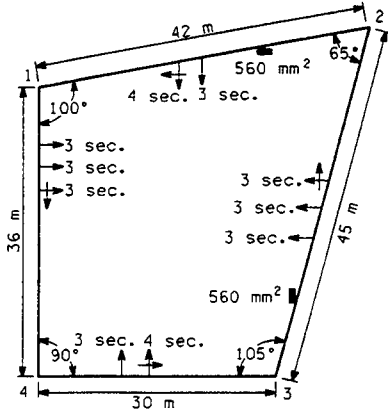

Determine the following:

- Cable Tensions (T)
- Pole Loads (PL)
- Pole Classes
- Foundation Depths (D)

1. Span lengths given above.
2. & 3. Calculate (P) and (G) values.

Span 1-2, n=3  
 7 sections x 178 N/sec = 1246 newtons  
 560 mm<sup>2</sup> sign x 0.3 N/mm<sup>2</sup> = 168 newtons  
 Total (P) = 1414 newtons  
 G = P/n = 1414/3 = 471 newtons

Span 2-3, n=4  
 9 sections x 178 N/sec = 1602 newtons  
 560 mm<sup>2</sup> sign x 0.3 N/mm<sup>2</sup> = 168 newtons  
 Total (P) = 1770 newtons  
 G = P/n = 1770/4 = 443 newtons

Span 3-4, n=2  
 7 sections x 178 N/sec = 1246 newtons  
 Total (P) = 1246 newtons  
 G = P/n = 1246/2 = 623 newtons

Span 4-1, n=3  
 9 sections x 178 N/sec = 1602 newtons  
 Total (P) = 1602 newtons  
 G = P/n = 1602/3 = 534 newtons

4. Determine (T) values.

Span	Length	G	Chart	n	min n	T
1-2	42 m	471 N	III	3	4	13400 N
2-3	45 m	443 N	III	4	4	12900 N
3-4	30 m	623 N	II	2	3	12500 N
4-1	36 m	534 N	II	3	3	11100 N

5. Calculate (PL) values by computing the vector resultant of the (T) values.

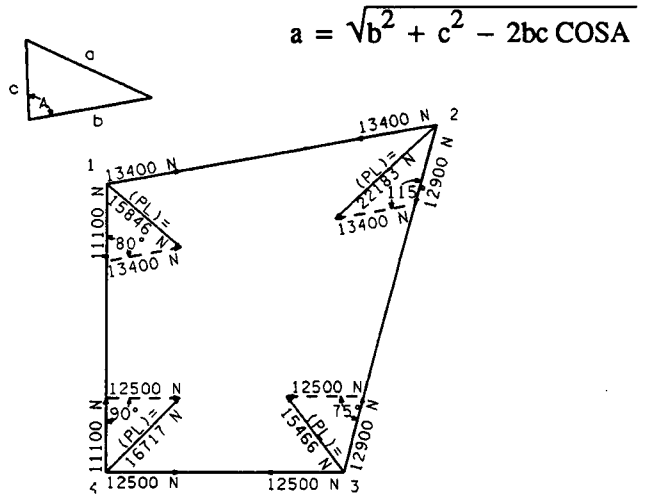

6. Select the pole class from the "Design Table."

Pole Number	(PL)	Pole Class
1	15847 N	16450 N
2	22183 N	24900 N
3	15466 N	16450 N
4	16717 N	21350 N

7. Calculate the required foundation depths.  
 Given: (S) = 47900 Pa.

$$D = a \frac{DT}{\sqrt{S}}$$

Pole No.	Pole Class	DT	Foundation Depths (D)		
			1 m Rd (a=350)	1.3 m Rd (a=300)	1 m Sq (a=290)
1	16450 N	2.5 m	4.0 m	3.5 m	3.3 m
2	24900 N	3.1 m	5.0 m	4.3 m	4.1 m
3	16450 N	2.5 m	4.0 m	3.5 m	3.3 m
4	21350 N	2.9 m	4.7 m	4.0 m	3.9 m

**STRAIN POLE AND FOUNDATION SELECTION EXAMPLE**

Figure 850-6b  
 (Metric)

<b>Conductor Size Table</b>	
Type	X-Section Area (mm <sup>2</sup> )
#14	12.9
#12	16.1
#10	20.0
#8	38.7
#6	52.9
#4	70.3
2cs (#14)	58.0
3cs (#20)	45.2
4csm	38.7
3c	77.4
5c	200.0
8c	290.0
11c	380.0
20c	593.0

cs = conductor shielded  
 cms = conductor shielded magnetometer

<b>Available Conduit Area</b>	
Size	26% Fill (mm <sup>2</sup> )
25 mm	128
32 mm	129-209
40 mm	210-327
50 mm	328-510
65 mm	511-863
80 mm	864-1307
90 mm	1308-1654

**CONDUIT**

Figure 850-7  
 (Metric)

**SIGNAL DISPLAYS**

	300 mm		300mm		300mm
	300 mm		300mm		300mm
	300 mm		300mm		28.29
11.51		21.22		48.49	
		41.42		68.69	
		61.62		88.89	
		81.82			

- 1. ALL VEHICLE HEADS SHALL HAVE TYPE M MOUNTS, J-60.
- 2. ALL PED HEADS SHALL HAVE TYPE A MOUNTS, J-61.

**PHASING**

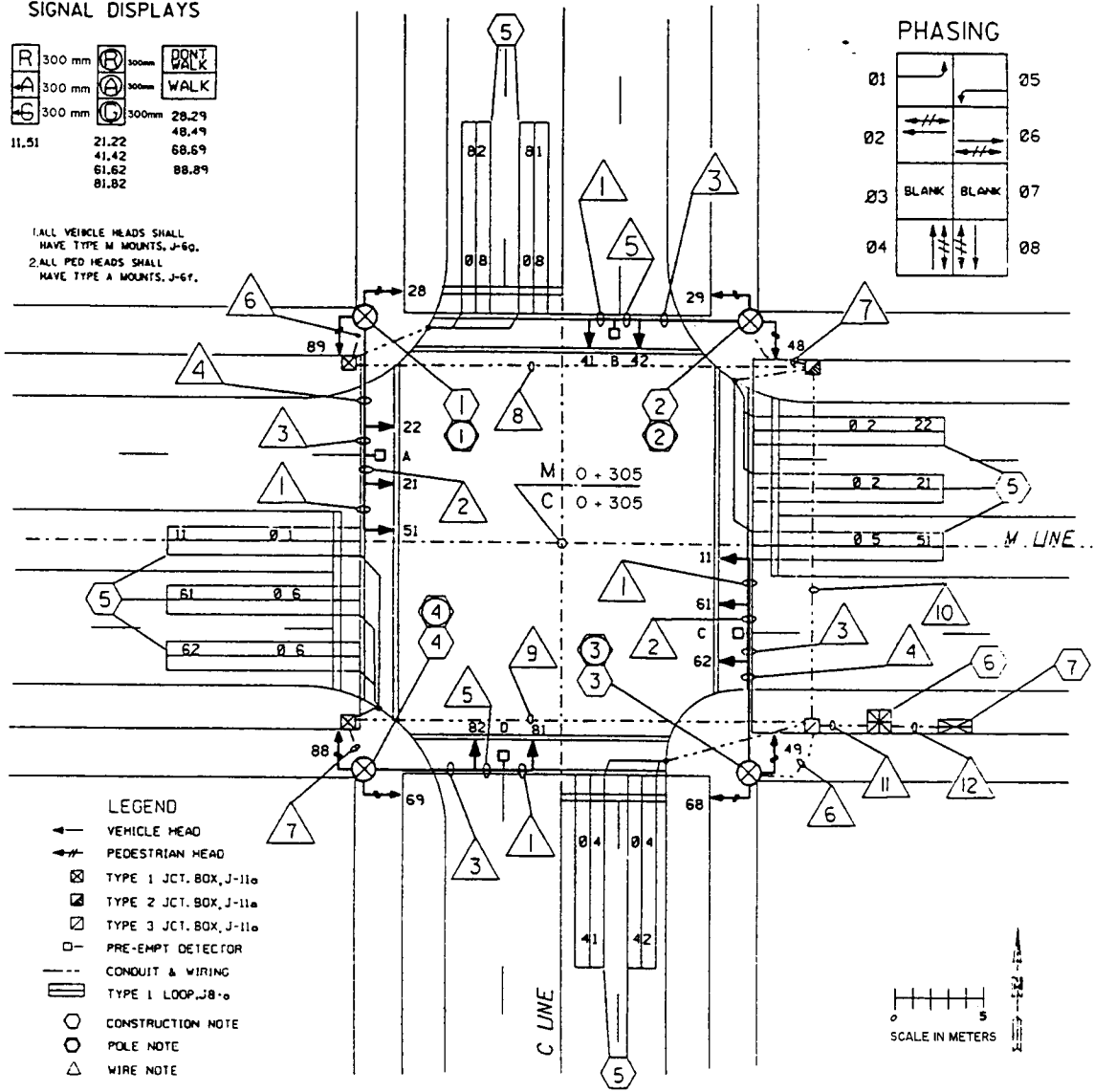
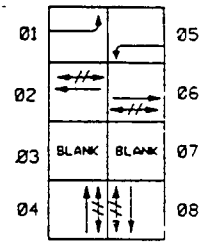

**LEGEND**

- VEHICLE HEAD
- PEDESTRIAN HEAD
- TYPE 1 JCT. BOX, J-110
- TYPE 2 JCT. BOX, J-110a
- TYPE 3 JCT. BOX, J-110
- PRE-EMPT DETECTOR
- CONDUIT & WIRING
- TYPE 1 LOOP, J-80
- CONSTRUCTION NOTE
- POLE NOTE
- WIRE NOTE

**CONSTRUCTION NOTES**

- ① INSTALL WITH SIGNAL DISPLAYS, PRE-EMPT DETECTOR, 2-PPB-1m AND TERMINAL CABINET.
- ② INSTALL WITH SIGNAL DISPLAYS, PRE-EMPT DETECTOR, 2-PPB-1m AND TERMINAL CABINET.
- ③ INSTALL WITH SIGNAL DISPLAYS, PRE-EMPT DETECTOR, 2-PPB-1m AND TERMINAL CABINET.
- ④ INSTALL WITH SIGNAL DISPLAYS, PRE-EMPT DETECTOR, 2-PPB-1A8 AND TERMINAL CABINET.
- ⑤ INSTALL 2m x 10m TYPE 1 LOOP, SEE J-80.
- ⑥ INSTALL CONTROLLER CABINET ON PAD FOUNDATION, J-60.
- ⑦ INSTALL MODIFIED TYPE D SERVICE. SEE DETAIL ...

		WIRING SCHEDULE				
	RACEWAY	2cs	3cs	3C	5C	NOTES
1	MASTARM				1	
2	MASTARM				2	
3	MASTARM		1		2	
4	MASTARM		1		3	
5	MASTARM		1		1	
6	65 mm	2	1	2	2	
7	65 mm	2	1	2	1	
8	65 mm	4	1	2	2	
9	65 mm	5	1	2	1	
10	65 mm	4	1	2	2	
	65 mm	5	1	2	1	
11	65 mm	4	1	2	2	
	65 mm	5	1	2	1	
	65 mm	4	1	2	2	
12	65 mm	5	1	2	1	
	25 mm	SIGNAL POWER	2			2

**EXAMPLE SIGNAL PLAN**

Figure 850-8  
(Metric)

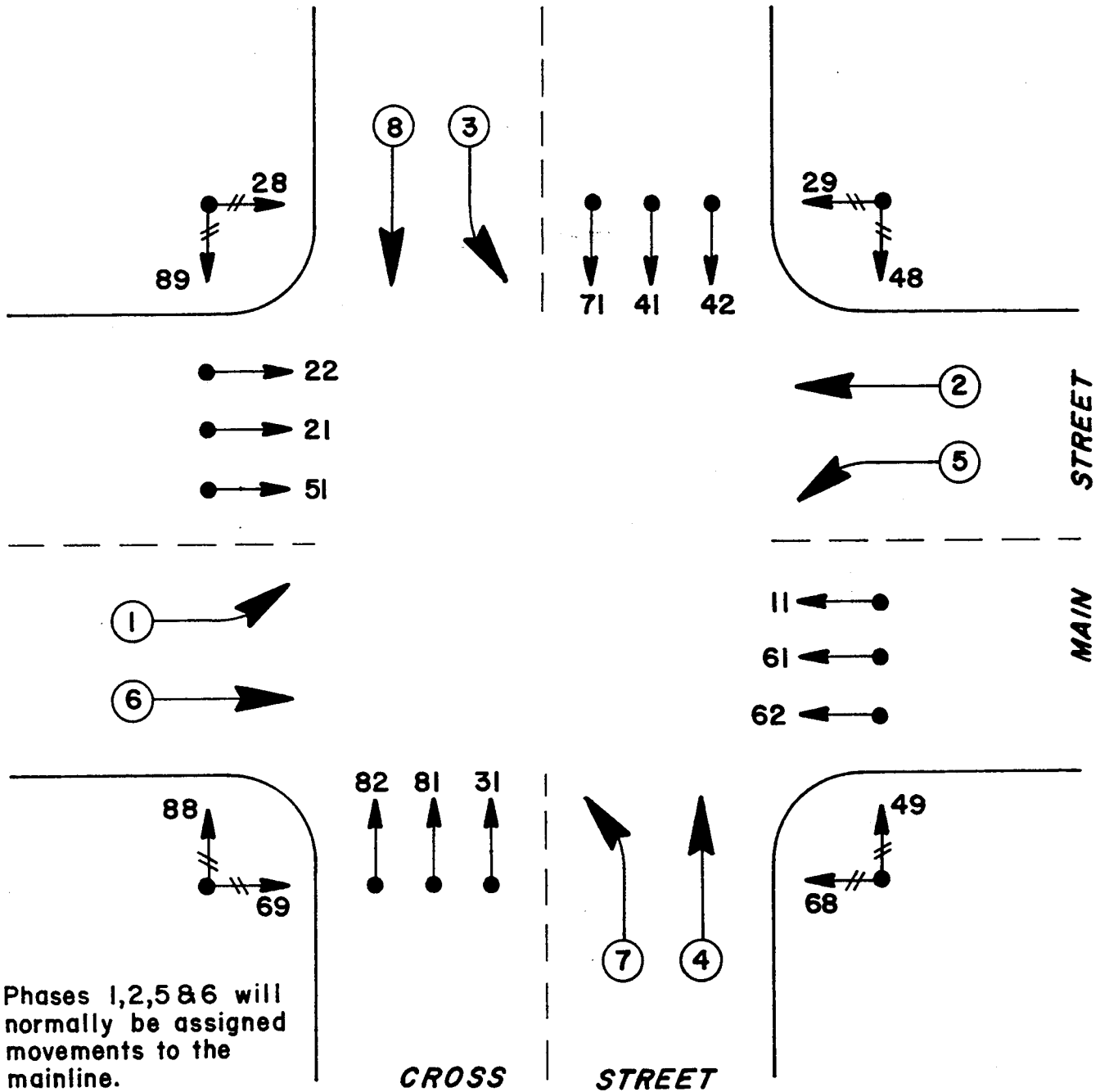

**STANDARD INTERSECTION MOVEMENTS AND HEAD NUMBERS**

Figure 850-9

2Ø

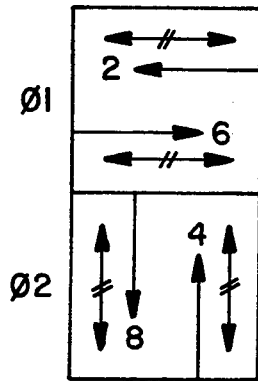

FRAME - 2Ø  
PHASES - 2

LOAD SWITCHES - 4



Detection for this movement  
connected to this Ø.

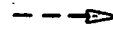

Detection for this movement  
not connected to this Ø. Display  
is overlapped.

3Ø

**Split Approach**

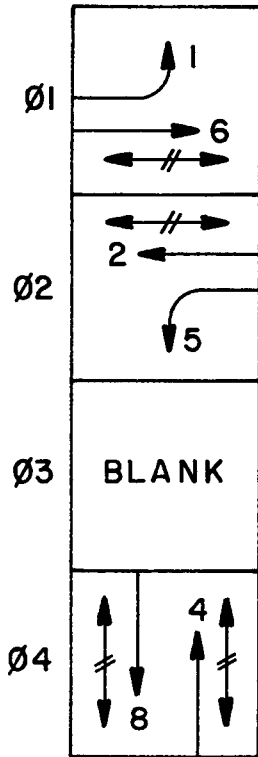

FRAME - 4Ø  
PHASES - 3  
OVERLAPS -  
LOAD SWITCHES - 6

**Dual Lefts**

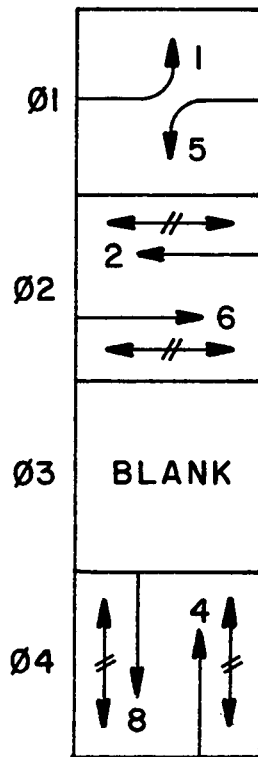

FRAME - 4Ø  
PHASES - 3  
OVERLAPS -  
LOAD SWITCHES - 5

**Ramp Terminal**

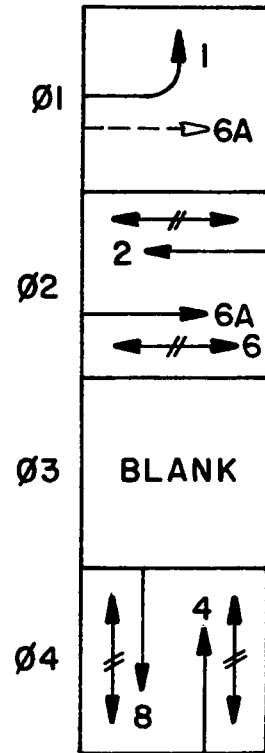

FRAME - 4Ø  
PHASES - 3  
OVERLAPS - 1  
A(Ø 1 + Ø 2)  
LOAD SWITCHES - 6

**TYPICAL PHASE SEQUENCE DIAGRAMS**

Figure 850-10a

# 4Ø OPERATION

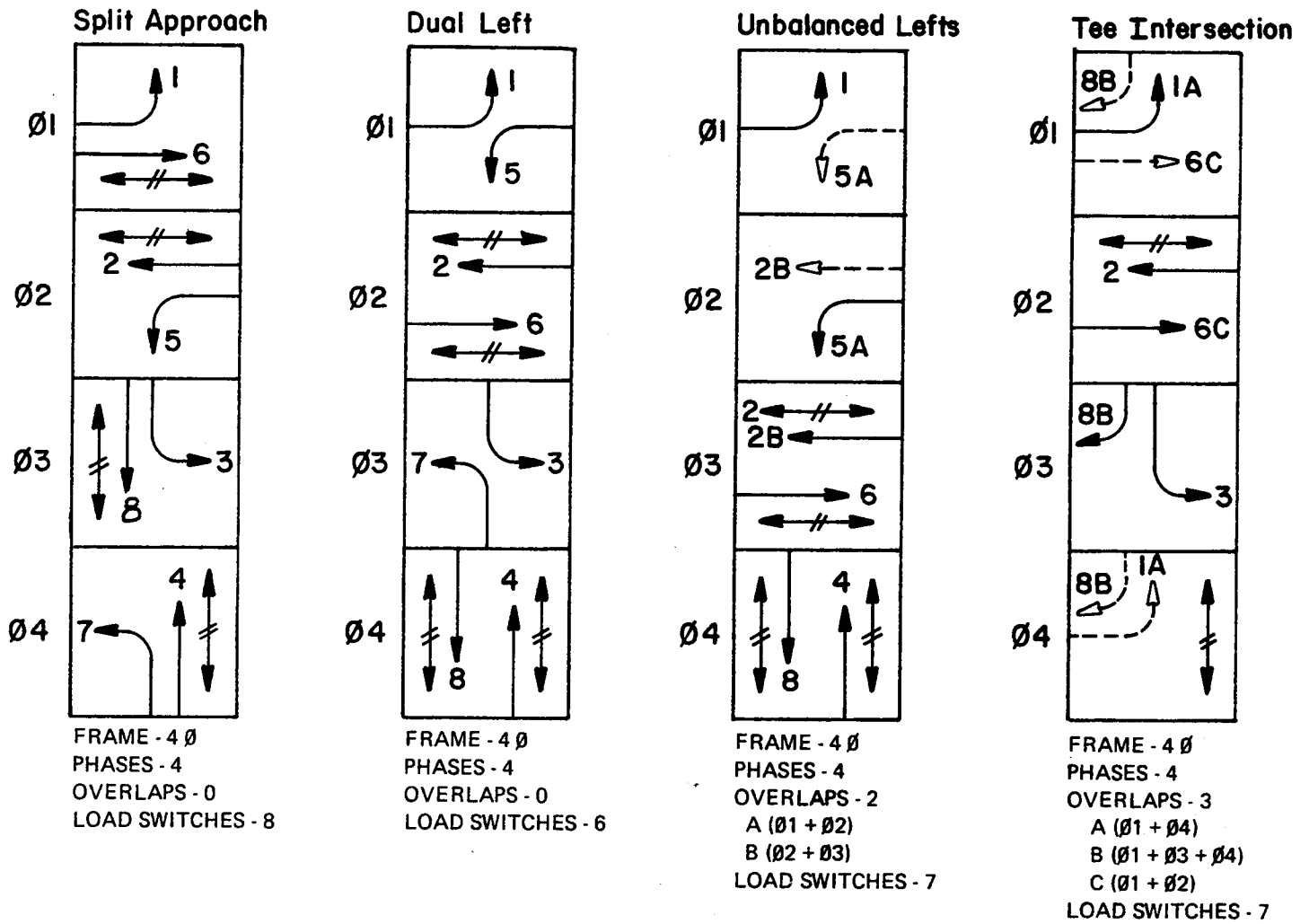

**TYPICAL PHASE SEQUENCE DIAGRAMS**

Figure 850-10b

# 5Ø OPERATION

## Concurrently Timed Crossroad

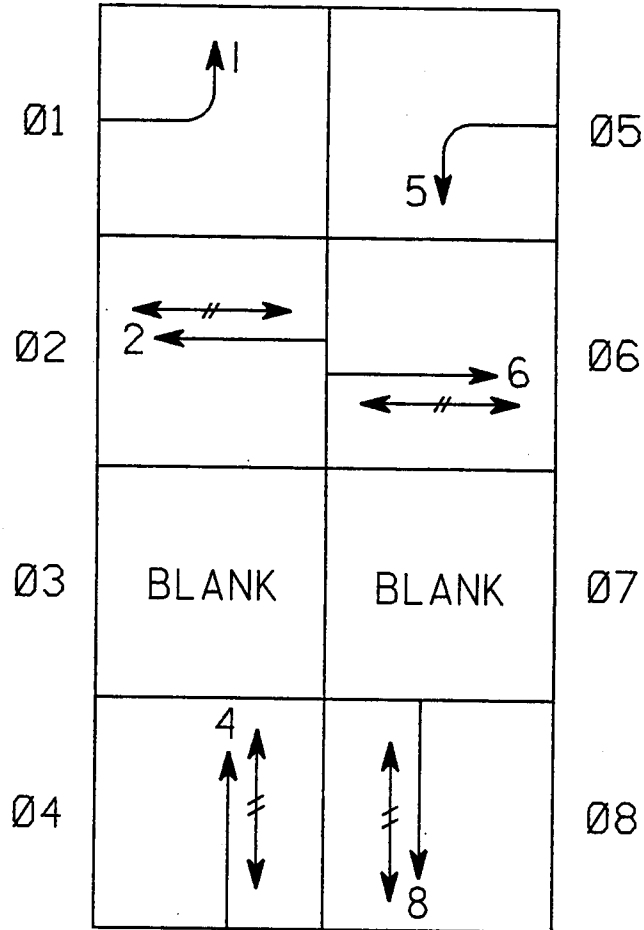

FRAME - 8 Ø  
 PHASES - 6  
 OVERLAPS - 0  
 LOAD SWITCHES - 10

### TYPICAL PHASE SEQUENCE DIAGRAMS

Figure 850-10c

6Ø Split Crossroad

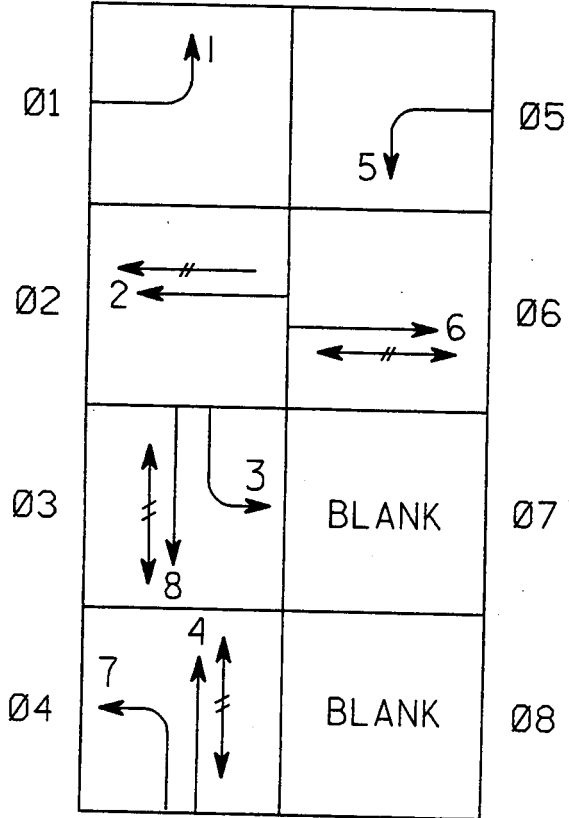

FRAME - 8 Ø  
 PHASES - 6  
 OVERLAPS - 0  
 LOAD SWITCHES - 10

8Ø Full Quad

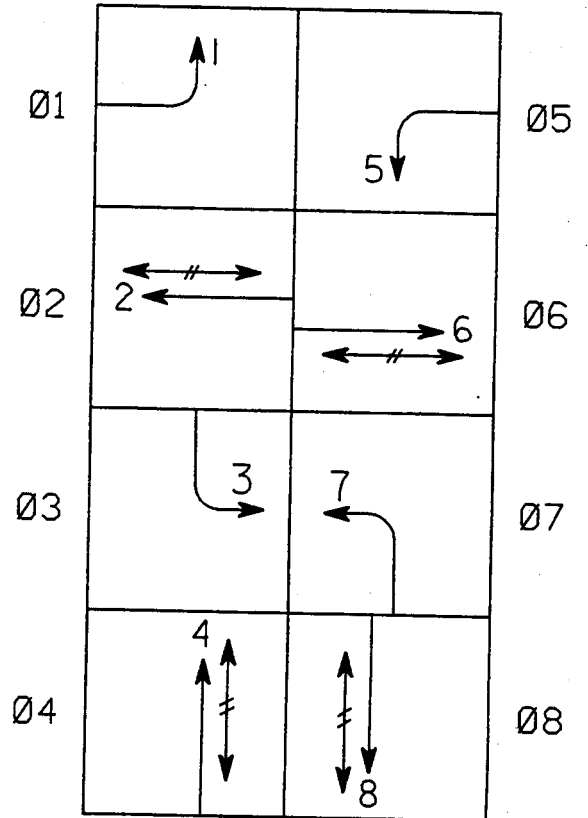

FRAME - 8 Ø  
 PHASES - 8  
 OVERLAPS - 0  
 LOAD SWITCHES - 12

**TYPICAL PHASE SEQUENCE DIAGRAMS**

Figure 850-10d



## SIGNAL SEQUENCE CHART

Ø OR OVERLAP	HEAD NUMBER	Ø1+Ø5						Ø1+Ø6						Ø2+Ø5						Ø2+Ø6						Ø4+Ø8						PE 1			PE 2		F							
		CHANGE TO						CHANGE TO						CHANGE TO						CHANGE TO						CHANGE TO						INTERVAL NO.			CT		CT							
		R/W	Ø1+Ø6	Ø2+Ø5	Ø2+Ø6	Ø4+Ø8	PE 1	PE 2	R/W	Ø1+Ø5	Ø2+Ø6	Ø2+Ø8	PE 1	PE 2	R/W	Ø1+Ø5	Ø1+Ø6	Ø2+Ø8	PE 1	PE 2	R/W	Ø1+Ø5	Ø1+Ø6	Ø2+Ø5	Ø4+Ø8	PE 1	PE 2	R/W	Ø1+Ø5	Ø1+Ø6	Ø2+Ø5	Ø2+Ø6	PE 1	PE 2	F	1 2 3			Ø4	R/W	Ø2+Ø6	R/W	Ø2+Ø6	
		Ø	Ø	Ø	Ø	Ø	Ø	Ø	Ø	Ø	Ø	Ø	Ø	Ø	Ø	Ø	Ø	Ø	Ø	Ø	Ø	Ø	Ø	Ø	Ø	Ø	Ø	Ø	Ø	Ø	Ø	Ø	Ø	Ø	Ø									
1	II	Ø	Ø	Ø	Ø	Ø	Ø	Ø	Ø	Ø	Ø	Ø	Ø																						R						R			
2	21,22													G	A	A	G	A	A	G	G	A	A	G	A	A	G									R			A	A	G	G	A	G
4	41,42																										G	A	A	A	A	A	A	A	R						R			
5	51	Ø	A	Ø	A	Ø	A							Ø	Ø	A	A	A	Ø															R			Ø	A	R	R				
6	61,62							G	A	A	G	A	A							G	A	G	A	A	A	A									R			A			A	G		
8	81,82																																	R						R				
2	28,29													W/Ø						W/Ø														I						I				
4	48,49																																	I						I				
6	68,69							W/Ø											W/Ø	W/Ø													I						I					
8	88,89																									W/Ø								I						I				

BLANK=RED BALL OR "DONT WALK" AS APPLICABLE

- A-AMBER BALL
- Ø-A-AMBER ARROW
- G-GREEN BALL
- Ø-G-GREEN ARROW

- W-WALK
- D-DONT WALK
- I-INOPERATIVE
- R-FLASHING RED BALL

- Ø-FLASHING AMBER BALL
- Ø-D-FLASHING "DONT WALK"
- PE1-RAILROAD PRE-EMPT
- PE2-FIRE PRE-EMPT
- F-FLASH

SIGNAL SEQUENCE CHART  
Figure 850-11

- LEGEND**
- ← VEHICLE HEAD
  - ←# PEDESTRIAN HEAD
  - PRE-EMPT DETECTOR
  - WIRING
  - TERMINAL BAR
  - PEDESTRIAN DETECTOR
  - ▬ TYPE 1 LOOP SEE J-8a
  - POLE NOTE

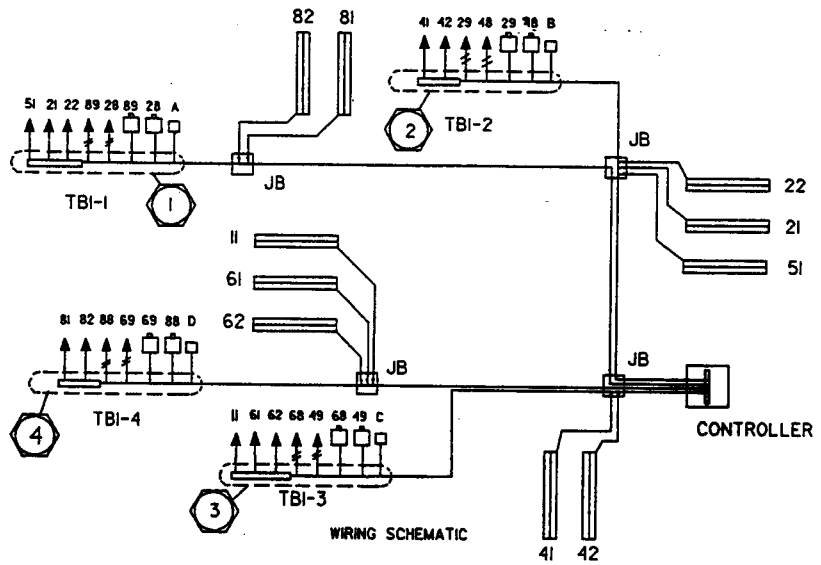

**CONTROLLER TERMINALS**

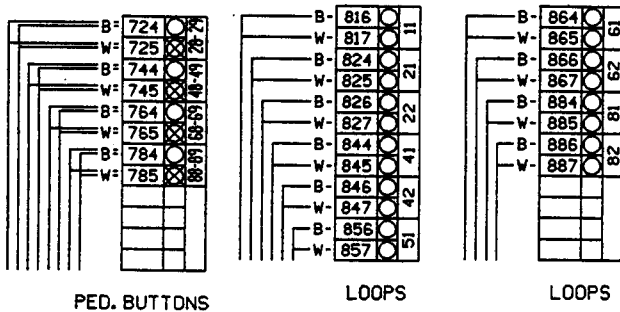
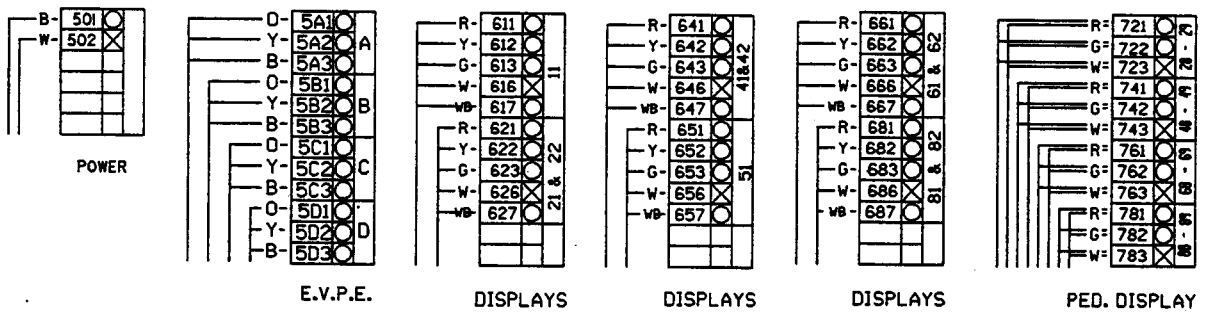

- ⊗ CONNECT TO NEUTRAL BUSS
- ⊠ CONTROL SIDE TERMINAL CONNECTION
- ⊞ CONNECT TO DETECTOR COMMON BUSS
- SPARE

**TYPICAL LOAD CONNECTIONS**

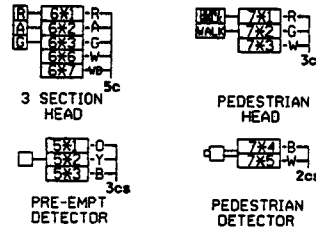

\* FIRST DIGIT OF HEAD NUMBER FOR HEADS AND BUTTONS, CHANNEL LETTER FOR PRE-EMPT DETECTOR.

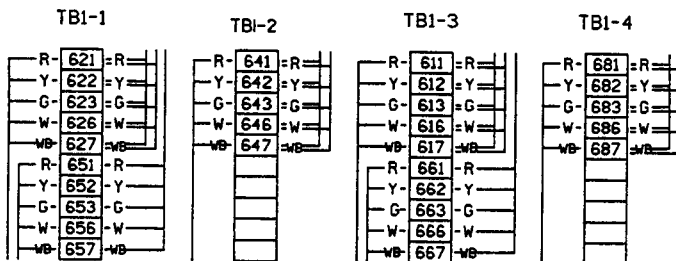

**TYPICAL WIRING SCHEMATIC**

Figure 850-12

**TYPICAL SIGNAL STANDARD DETAIL CHART**

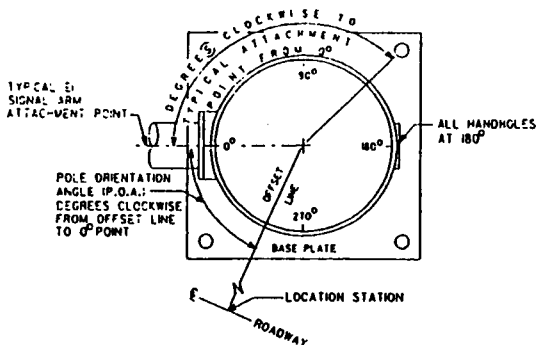

POLE ORIENTATION AND ATTACHMENT POINT DETAIL  
PLAN VIEW

**LEGEND**

- a. Vehicle Signal Head
- b. Internally Illuminated Sign
- c. Street Name Sign
- d. Pre-empt Detector
- e. Pre-empt Indicator
- f. Luminaire
- g. Pedestrian Signal Head
- h. Cabinet
- i. Pedestrian Push Button Assembly, J-5a
- j. Handhole

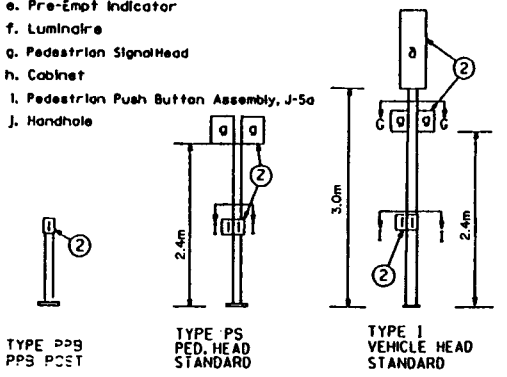

TYPE PS  
PED. HEAD  
STANDARD

TYPE I  
VEHICLE HEAD  
STANDARD

**NOTES**

- ① Mounting coupling installed by fabricator at offset distance indicated in chart. Field installed.
- ② See Special Provisions for luminaire arm type.
- ③ Foundations shall conform to the foundation detail on Standard Plan J-1c, except anchor bolt size, material and bolt circle shall conform to details on pre-approved plans or shall be as approved by the Bridge and Structures Office. All vertical rebar shall be No. 7.
- ④ Mount phase D pre-empt detector 4.5m above base plate on pole shaft. Orientation shall be per manufacturer's recommendation.
- ⑤ Mount phase B pre-empt detector 4.5m above base plate on pole shaft. Orientation shall be per manufacturer's recommendation.

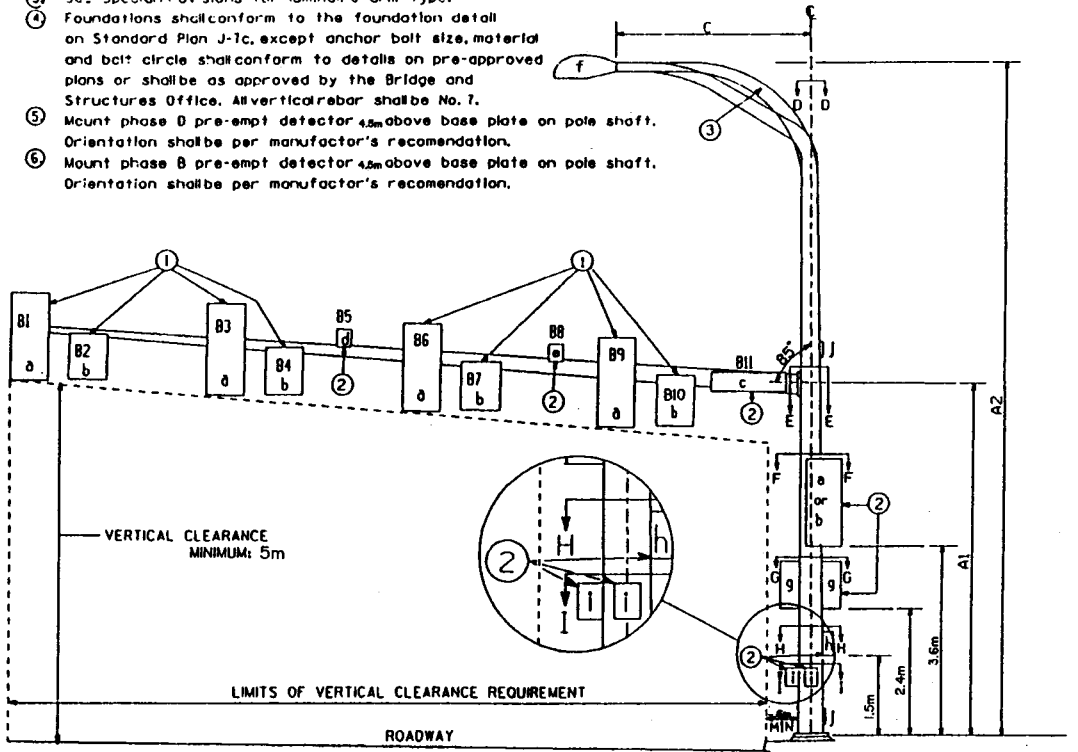

TYPE II  
MAST ARM  
SIGNAL STANDARD

TYPE III  
COMBINATION LIGHTING  
AND MAST ARM  
SIGNAL STANDARD

TYPE IV  
STRAIN POLE  
STANDARD

TYPE V  
COMBINATION LIGHTING  
AND STRAIN  
POLE STANDARD

TYPE SD  
SPECIAL DESIGN STANDARD

**SIGNAL STANDARD DETAIL CHART**

STANDARD	FIELD LOCATION	STRAIN POLE CLASS	TYPE	MOUNTING HEIGHT (m)		SIGNAL MAST ARM DATA															LUMINAIRE ARM (m)	POLE ATTACHMENT POINT ANGLES (deg)								FOUNDATION DEPTH (m)	REMARKS																
						OFFSET DISTANCES (m) LE POLE TO ATTACHMENT POINT										WINDLOAD AREAS (m <sup>2</sup> ) (XNY)						ANGLE																									
						A1	A2	B1	B2	B3	B4	B5	B6	B7	B8	B9	B10	B11	B1	B2		B3	B4	B5	B6	B7	B8	B9	B10			B11	TOTAL (m <sup>2</sup> )	C	D	E	F	G	H	I	J						
1	M 0-288	14.4	0	II	5.5	13.5	10.5	9.0	6.9															0.85	0.85	0.85												26.3	135	90	270	0					
2	C 0-317	11.4	0	II	5.5	9.9	6.0	7.8																0.85	0.85													13.9	135	90	270	0					
3	M 0-317	14.4	0	II	5.5	13.5	10.5	9.0	6.9															0.85	0.85	0.85												26.3	135	90	270	0					See Note 5
4	C 0-288	11.4	0	II	5.5	9.9	6.0	7.8																0.85	0.85													13.9	135	90	270	0					See Note 6



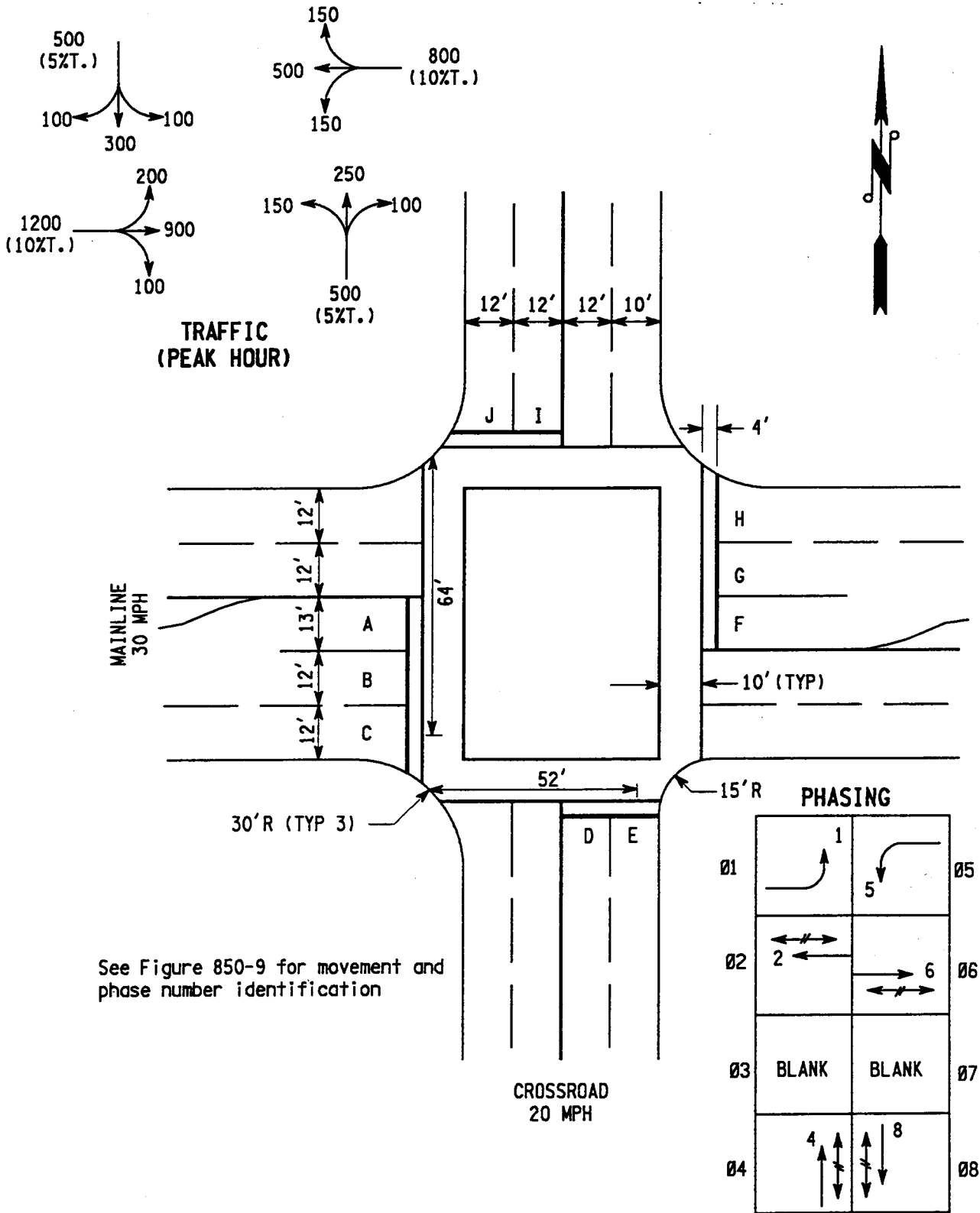

**EXAMPLE OPTIMUM CYCLE AND SPLIT CALCULATION**

Figure 850-2

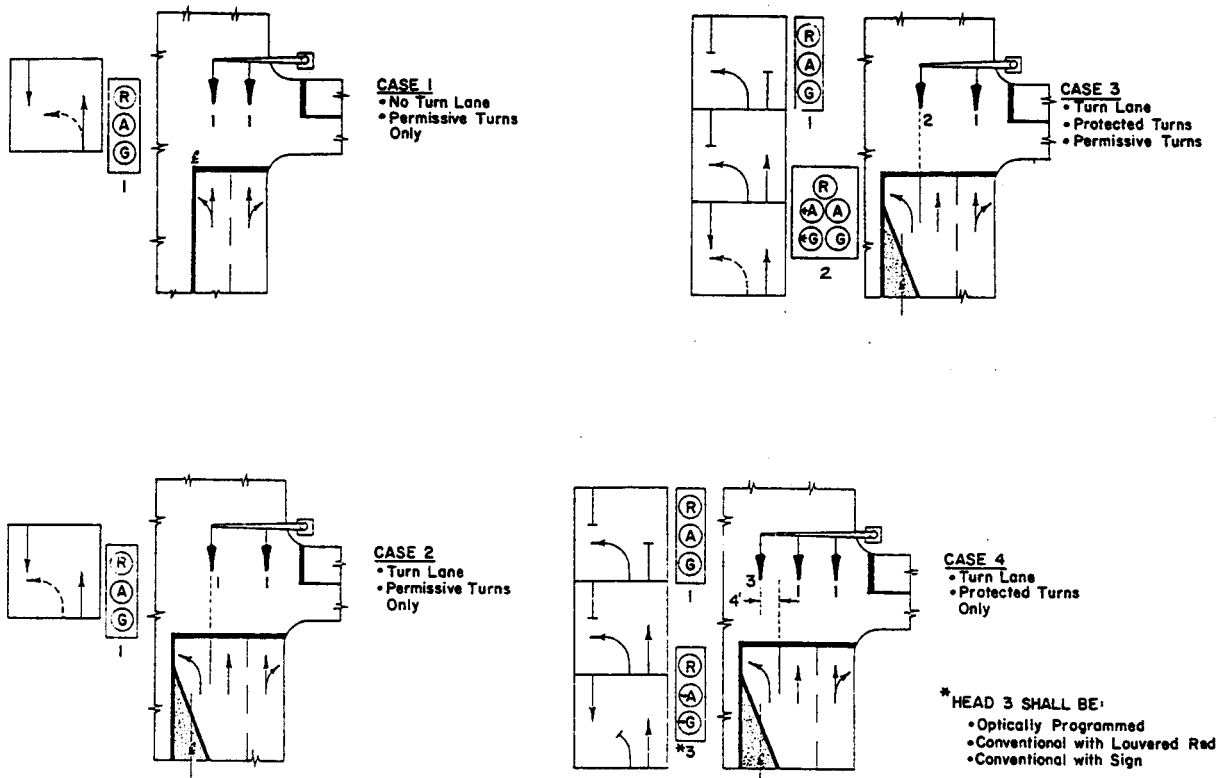

**SIGNAL DISPLAYS**

Figure 850-5a

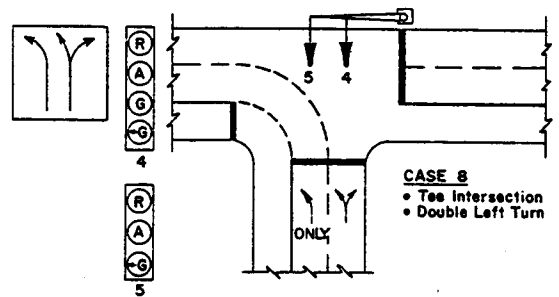
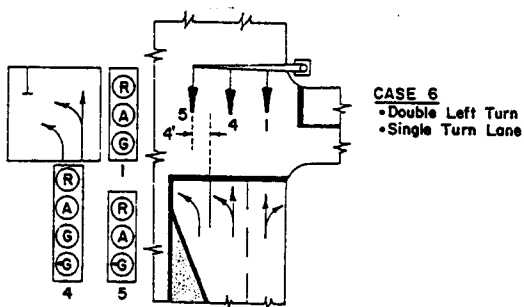
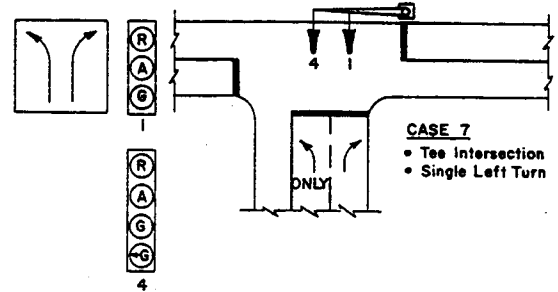
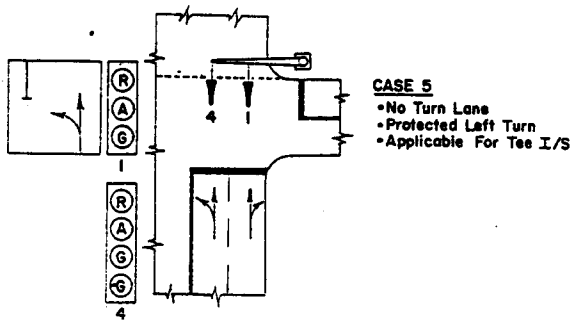

## SIGNAL DISPLAYS

Figure 850-5b

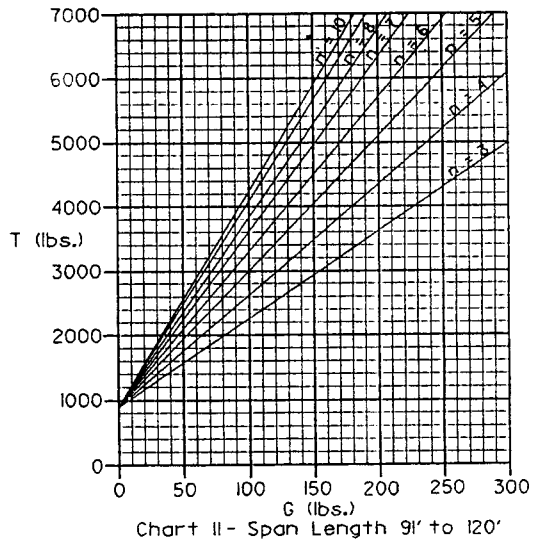
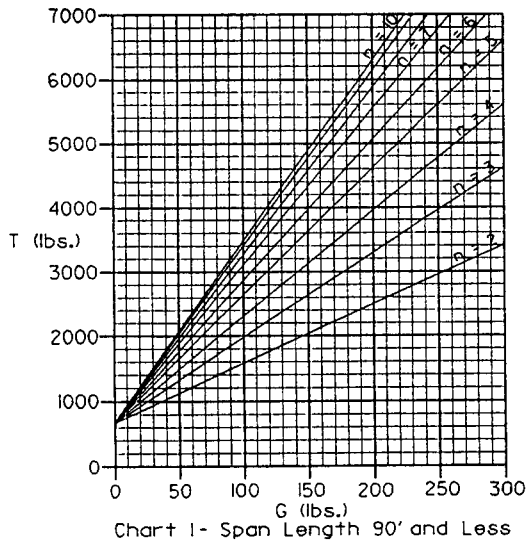

### STRAIN POLE AND FOUNDATION SELECTION PROCEDURE

1. Determine span length.
2. Calculate the total dead load (P) per span. Use 40 pounds per signal section and 6.25 pounds per square foot of sign area.
3. Calculate the average load (G) per span.  $G = P/n$  where n is the number of signal head assemblies plus the number of signs.
4. Determine cable tension (T) per span. Enter the proper chart with the average load (G) and number of loads (n). If (n) is less than minimum (n) allowed on chart, use minimum (n) on chart.
5. Calculate the pole load (PL) per pole. If only one cable is attached to the pole, the pole load (PL) equals the cable tension (T). If more than one cable is attached, (PL) is obtained by computing the vector resultant of the (T) values.
6. Select the pole class from the 'Design Table'. Choose the pole class closest to but greater than the (PL) value.
7. Calculate the required foundation depth (D). Use the formula:

$$D = a \cdot \frac{D_T}{\sqrt{S}}$$

Select the table foundation depth ( $D_T$ ) from the 'Design Table'. Soil bearing pressure (S) is measured in psf. The foundation formula variable (a) is for 3' round foundation, a=50  
4' round foundation, a=43  
3' square foundation, a=41

Round (D) upwards to nearest whole number if 0.10 foot or greater.

8. Check vertical clearance (16.5 minimum) assuming 29' maximum cable attachment height and 5% minimum span sag.

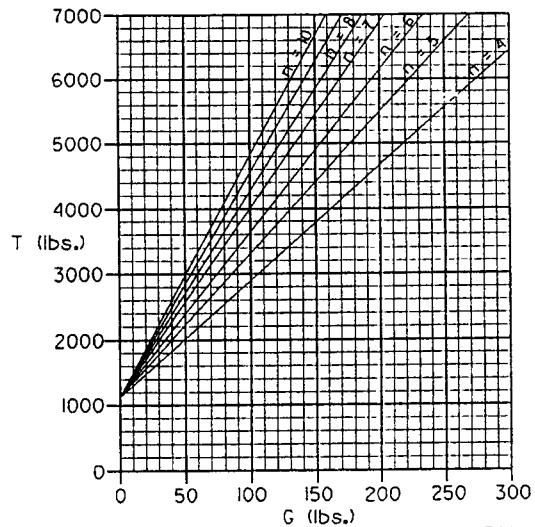

- Notes:
- A special design by Office of Bridge & Structures will be required if:
    - (1) span length exceeds 150'
    - (2) (PL) value exceeds 7200 lbs.
    - (3) distance between base plate and first cable attachment exceeds 29'

Charts are based on a cable weight of 3 pounds per foot (1.25 LBS./FT. and conductors, 1.75 LBS./FT. ice). Total dead load (P) includes weight of ice on sign or signal section.

On Timber Strain Pole Designs specify 2 guy wires when the (PL) value exceeds 4500 lbs.

DESIGN TABLE	
Pole Class (pounds)	Foundation Depth ( $D_T$ )
1900	6' - 0"
2700	7' - 0"
3700	8' - 0"
4800	9' - 6"
5600	10' - 0"
6300	11' - 0"
7200	12' - 0"

### STRAIN POLE AND FOUNDATION SELECTION PROCEDURE

Figure 850-6a



**Example Application:**

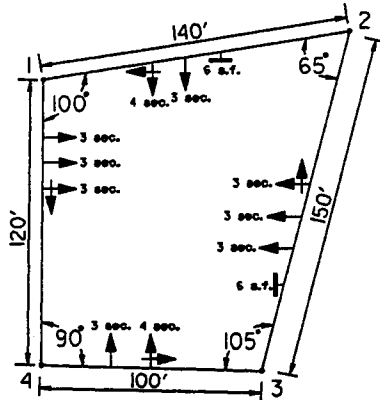

- Determine the following:  
 Cable Tensions (T)  
 Pole Loads (PL)  
 Pole Classes  
 Foundation Depths (D)

1. Span lengths given above.

2. & 3. Calculate (P) and (G) values.

Span 1-2, n=3  
 7 sections x 40 lbs./sec. = 280 pounds  
 6 s.f. sign x 6.25 lbs./s.f. = 38 pounds  
 total (P) = 318 pounds  
 $G = P/n = 318/3 = 106$  pounds

Span 2-3, n=4  
 9 sections x 40 lbs./sec. = 360 pounds  
 6 s.f. sign x 6.25 lbs./s.f. = 38 pounds  
 total (P) = 398 pounds  
 $G = P/n = 398/4 = 100$  pounds

Span 3-4, n=2  
 7 sections x 40 lbs./sec. = 280 pounds  
 total (P) = 280 pounds  
 $G = P/n = 280/2 = 140$  pounds

Span 4-1, n=3  
 9 sections x 40 lbs./sec. = 360 pounds  
 total (P) = 360 pounds  
 $G = P/n = 360/3 = 120$  pounds

4. Determine (T) values.

Span Length	G	Chart	n	min n	T	
1-2	140'	106 lbs.	III	3	4	3000 lbs.
2-3	150'	100 lbs.	III	4	4	2900 lbs.
3-4	100'	140 lbs.	II	2	3	2800 lbs.
4-1	120'	120 lbs.	II	3	3	2500 lbs.

5. Calculate (PL) values by computing the vector resultant of the (T) values.

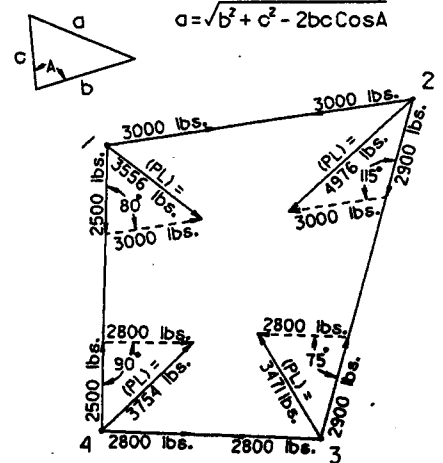

6. Select the pole class from the 'Design Table'.

Pole Number	(PL)	Pole Class
1	3556 lbs.	3700 lbs.
2	4976 lbs.	5600 lbs.
3	3471 lbs.	3700 lbs.
4	3754 lbs.	4800 lbs.

7. Calculate the required foundation depths.  
 Given: (S)=1000 psf.

$$D = a \cdot \frac{D_T}{\sqrt{S}}$$

Pole Number	Pole Class	D <sub>T</sub>	Foundation Depths (D)		
			3' Rd. (a=50)	4' Rd. (a=43)	3' Sq. (a=41)
1	3700 lbs.	8'	13'	11'	11'
2	5600 lbs.	10'	16'	14'	13'
3	3700 lbs.	8'	13'	11'	11'
4	4800 lbs.	9' - 6"	15'	13'	13'

**STRAIN POLE AND FOUNDATION SELECTION EXAMPLE**

Figure 850-6b

CONDUCTOR SIZE TABLE	
TYPE	X-SECTION AREA (IN <sup>2</sup> )
#14	0.020
#12	0.025
#10	0.031
#8	0.060
#6	0.082
#4	0.109
2cs (#14)	0.090
3cs (#20)	0.070
4csm	0.060
3c	0.120
5c	0.310
8c	0.450
11c	0.590
20c	0.920

cs = conductor shielded

csm = conductor shielded magnetometer

AVAILABLE CONDUIT AREA	
SIZE	26% FILL (IN <sup>2</sup> )
1"	0 - 0.23
1 1/4"	0.24 - 0.39
1 1/2"	0.40 - 0.53
2"	0.54 - 0.87
2 1/2"	0.88 - 1.24
3"	1.25 - 1.92
3 1/2"	1.93 - 2.57

### CONDUIT

Figure 850-7

**SIGNAL DISPLAYS**

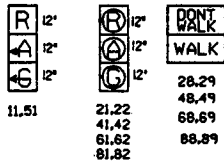

1. HEADS 1 & 51 SHALL BE OPTICALLY PROGRAMMED.
2. ALL VEHICLE HEADS SHALL HAVE TYPE M MOUNTS, J-60.
3. ALL PED HEADS SHALL HAVE TYPE A MOUNTS, J-61.

**PHASING**

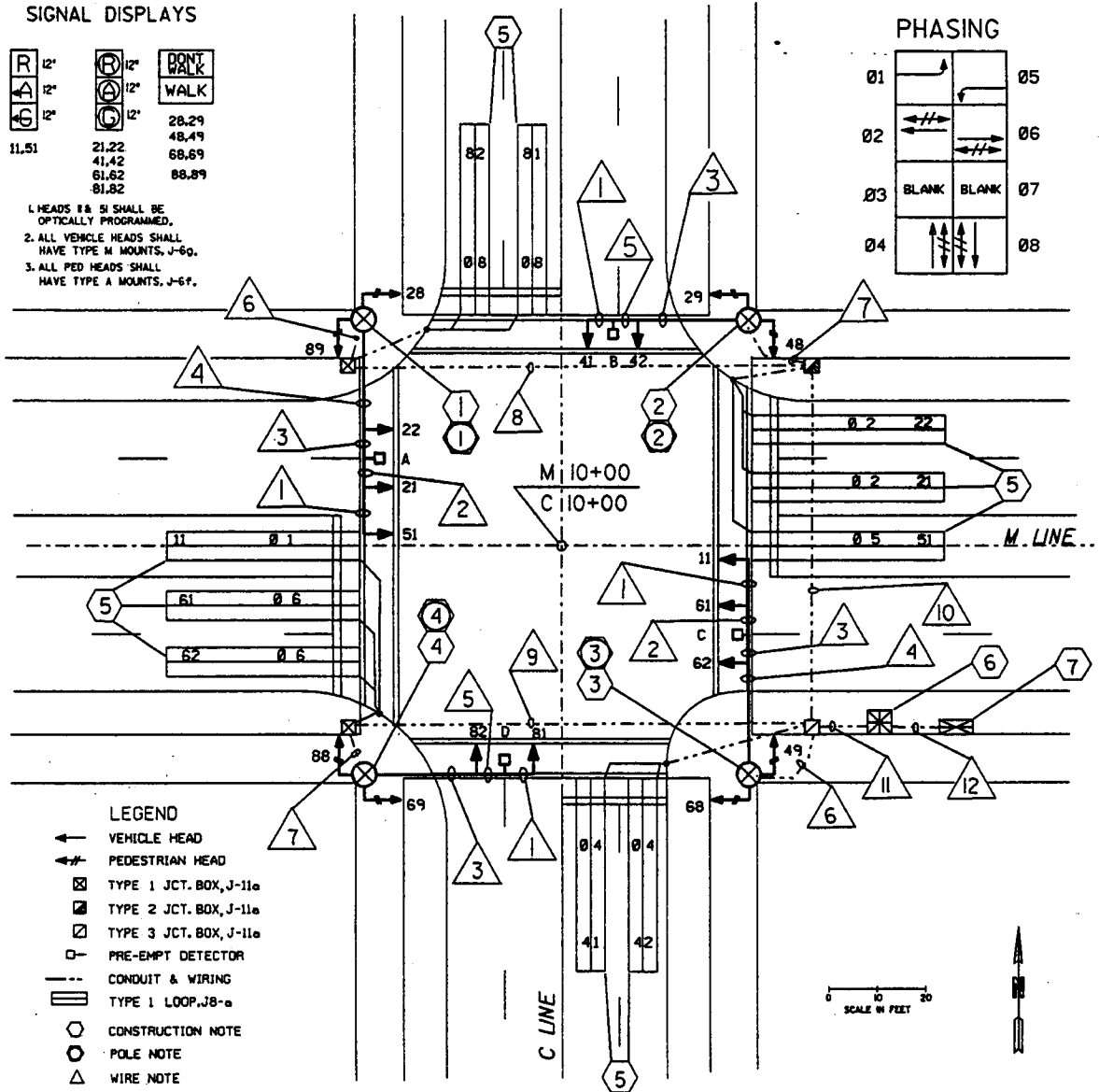
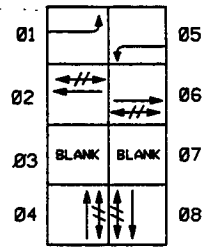

**LEGEND**

- ← VEHICLE HEAD
- ↔ PEDESTRIAN HEAD
- ☒ TYPE 1 JCT. BOX, J-11a
- ☑ TYPE 2 JCT. BOX, J-11a
- ☒ TYPE 3 JCT. BOX, J-11a
- PRE-EMPT DETECTOR
- CONDUIT & WIRING
- ▭ TYPE 1 LOOP, J8-a
- CONSTRUCTION NOTE
- POLE NOTE
- △ WIRE NOTE

**CONSTRUCTION NOTES**

- ① INSTALL ① WITH SIGNAL DISPLAYS, PRE-EMPT DETECTOR, 2-PPB-1AB AND TERMINAL CABINET.
- ② INSTALL ② WITH SIGNAL DISPLAYS, PRE-EMPT DETECTOR, 2-PPB-1AB AND TERMINAL CABINET.
- ③ INSTALL ③ WITH SIGNAL DISPLAYS, PRE-EMPT DETECTOR, 2-PPB-1AB AND TERMINAL CABINET.
- ④ INSTALL ④ WITH SIGNAL DISPLAYS, PRE-EMPT DETECTOR, 2-PPB-1AB AND TERMINAL CABINET.
- ⑤ INSTALL 6' X 40' TYPE 1 LOOP, SEE J-8a.
- ⑥ INSTALL CONTROLLER CABINET ON PAD FOUNDATION, J-6c.
- ⑦ INSTALL MODIFIED TYPE D SERVICE. SEE DETAIL ---.

Δ	RACEWAY	WIRING			SCHEDULE		NOTES
		2cs	3cs	3C	5C		
1	MASTARM					1	
2	MASTARM					2	
3	MASTARM		1			2	
4	MASTARM		1			3	
5	MASTARM		1			1	
6	2½"	2	1	2	2		
7	2½"	2	1	2	1		
8	2½"	4	1	2	2		
9	2½"	5	1	2	1		
10	2½"	4	1	2	2		
	2½"	5	1	2	1		
11	2½"	4	1	2	2		
	2½"	5	1	2	1		
	2½"	4	1	2	2		
12	1"	SIGNAL POWER			2 #8		

**EXAMPLE SIGNAL PLAN**

Figure 850-8

TYPICAL SIGNAL STANDARD DETAIL CHART

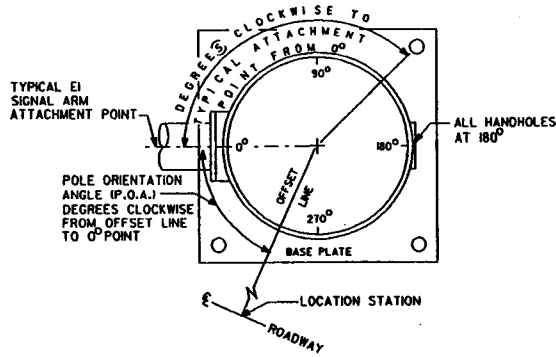

POLE ORIENTATION AND ATTACHMENT POINT DETAIL PLAN VIEW

LEGEND

- a. Vehicle Signal Head
- b. Internally Illuminated Sign
- c. Street Name Sign
- d. Pre-Empt Detector
- e. Pre-Empt Indicator
- f. Luminaire
- g. Pedestrian Signal Head
- h. Cabinet
- i. Pedestrian Push Button Assembly, J-5a
- J. Handhole

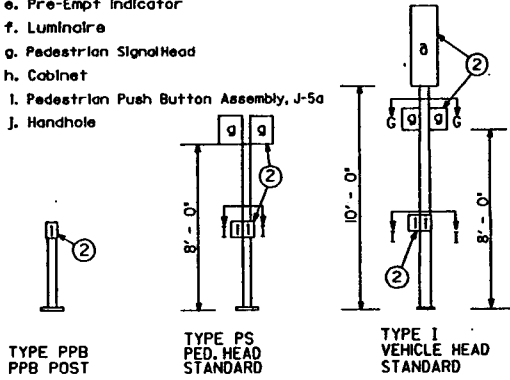

NOTES

- ① Mounting coupling installed by fabricator at offset distance indicated in chart.
- ② Field installed.
- ③ See Special Provisions for luminaire arm type.
- ④ Foundations shall conform to the foundation detail on Standard Plan J-7c, except anchor bolt size, material and bolt circle shall conform to details on pre-approved plans or shall be as approved by the Bridge and Structures Office. All vertical rebar shall be No. 7.
- ⑤ Mount phase D pre-empt detector 15' above base plate on pole shaft. Orientation shall be per manufacturer's recommendation.
- ⑥ Mount phase B pre-empt detector 15' above base plate on pole shaft. Orientation shall be per manufacturer's recommendation.

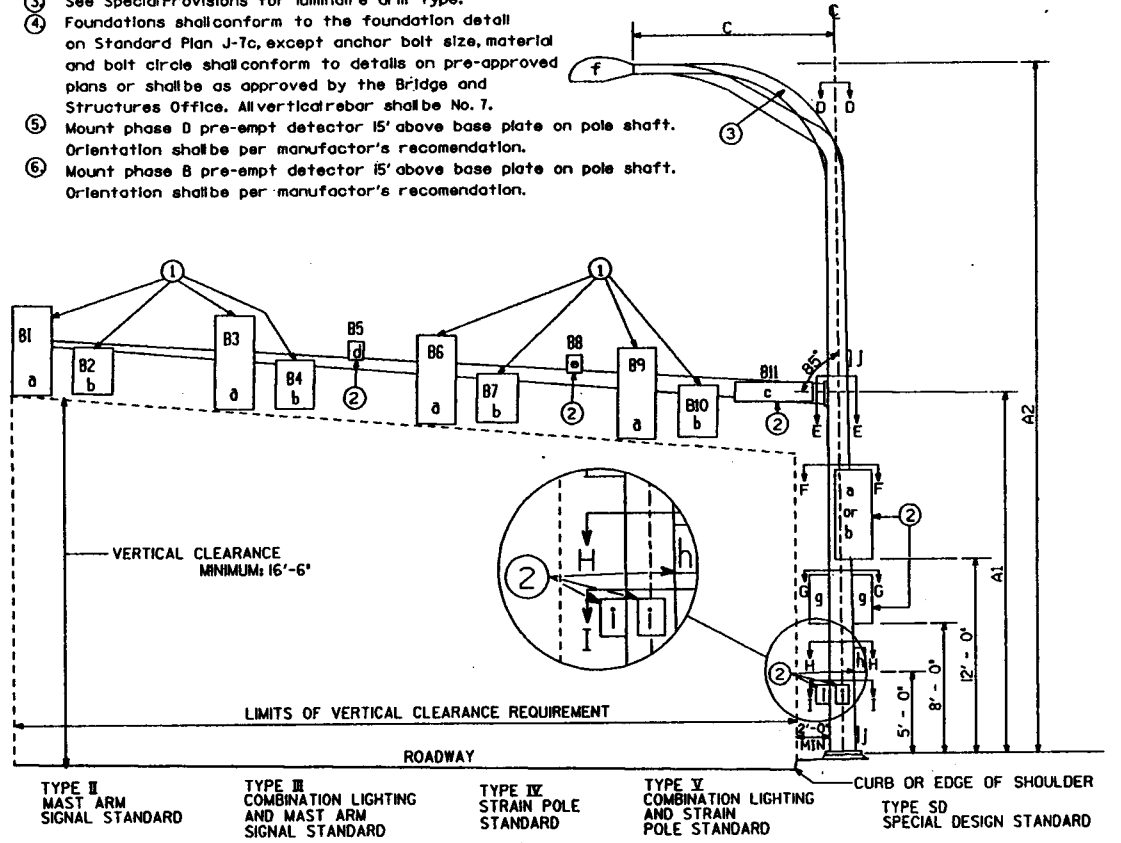

STATION	FIELD LOCATION		STRAIN POLE	TYPE	MOUNTING HEIGHT (FT)	SIGNAL MAST ARM DATA																LUMINAIRE ARM (FT)	POLE ATTACHMENT POINT ANGLES (deg)					FOUNDATION DEPTH (FT)	REMARKS *													
						OFFSET DISTANCES (FT)		TO POLE (° TO ATTACHMENT POINT)										WINDLOAD AREAS (FT <sup>2</sup> ) (KX)		TOTAL (FT <sup>2</sup> )	C		D	E1	E2	F	G			H	I1	I2										
						A1	A2	B1	B2	B3	B4	B5	B6	B7	B8	B9	B10	B11	B1														B2	B3	B4	B5	B6	B7	B8	B9	B10	B11
						18.5	45	35	35	30	23	9.2	9.2	9.2																												
1	M	9+53	48'	0	X	18.5	45	35	35	30	23	9.2	9.2	9.2										948	0					135	90	270	0									
2	C	10+47	38'	0	X	18.5	33	20	26			9.2	9.2											488	0				135	90	270	0										
3	M	10+47	48'	0	X	18.5	45	35	30	23		9.2	9.2	9.2										948	0				135	90	270	0		See Note 5								
4	C	9+53	38'	0	X	18.5	33	20	26			9.2	9.2											488	0				135	90	270	0		See Note 6								

860.01	General
860.02	References
860.03	Traffic Data Collection
860.04	Traffic Flow Control
860.05	Motorist information
860.06	Documentation

### **860.01 General**

Intelligent Transportation Systems (ITS) apply advanced technologies in communications and computer science to optimize the safety and efficiency of the existing surface transportation network. In highway design, this goal is achieved by collecting and using traffic data to develop predictive models, regulating access to the freeway system, and providing timely information on traffic conditions to motorists. Previously, this technology was called Surveillance, Control, and Driver Information (SC&DI). In the context of highway design, ITS and SC&DI are synonymous.

The Transportation Equity Act (TEA-21) requires ITS projects to comply with the standards being developed in association with the federal government and private industry. These standards will be known as the National ITS Architecture. These standards are intended to ensure interoperability and efficiency to the maximum extent practicable for the many different types of ITS devices under development. The National ITS Architecture organizes a “system of sub-systems” and makes managing ITS deployment easier. The Architecture helps agencies communicate complex ideas by providing a common language and definitions. One benefit of using the National ITS Architecture is that it helps identify all agencies and jurisdictions that should be included in ITS projects.

The ITS program in Washington State is known as “Venture Washington.” It focuses on five areas within Washington State. These areas were chosen because they each have unique characteristics and problems associated with traffic. These five areas are:

- The Greater Puget Sound Region
- The Spokane Area
- The Vancouver Area
- Other Statewide Urban Areas
- Rural Areas and Intercity Corridors

An intelligent transportation system can be implemented in stages, starting with a small project for immediate benefit and then expanding the system as needed. Consider installing an ITS at any of the following locations:

- Where congestion frequently causes accidents.
- At freeway on-ramps where merging problems routinely occur.
- Where heavy traffic volumes occur between closely spaced on-ramps.
- Where the motorist would benefit from information on traffic conditions or alternative routes.

The initial stage of an intelligent transportation system can be as simple as installing a dynamic message sign that warns motorists of unusual driving conditions. Appropriate messages can be displayed on the sign using information obtained by direct observation of road conditions or by reports from law enforcement agencies.

Automated systems incorporate a traffic data collection system. The data collection system provides basic data to determine traffic volumes, vehicular speeds, and levels of congestion. The traffic data can be analyzed and used to verify the locations of traffic problems. This data can also be used in freeway computer models to predict the impacts of proposed improvements.

Design each stage of the system so that the associated technology can be used in subsequent, more sophisticated stages. For example, the stage following data collection could be the installation of closed circuit television cameras (CCTV) to

monitor freeway locations where congestion is commonplace. The CCTV monitoring is used to detect or confirm incidents noted by other forms of data collection. The installation of motorist information devices such as dynamic message signs or highway advisory radio provides a means of transmitting this information to the motorist. Eventually, as traffic congestion increases, ramp meters are installed to control the traffic flow entering the facility.

When planning a staged system, attempt to determine the ultimate communication system to the degree that underground conduit size and quantity are known and can be installed in the initial construction. Consider long-term maintenance issues and component standardization.

The Northwest Region Traffic Systems Management Center (TSMC) is an example of a traffic operations center (TOC). Because a TOC usually works best with existing radio communication, it is located adjacent to or as part of a radio communication office. In addition to the location of a TOC, consider the work force and equipment costs required to operate and maintain the entire system. The size of a TOC is dependent on the complexity of the system and can vary from a single person at a desk to a large room with advanced equipment requiring continuous staffing.

## 860.02 References

Transportation Equity Act (TEA-21) of 1998

*Manual on Uniform Traffic Control Devices for Streets and Highways* (MUTCD), USDOT,

*SC&DI Design Guide*, WSDOT Northwest Region

*SC&DI Operations Guide*, WSDOT Northwest Region

*I-90 Seattle to Spokane, ITS Corridor Study*, WSDOT Advanced Technology Branch

*I-5 Seattle to Vancouver, BC, ITS Corridor Study*, WSDOT Advanced Technology Branch

*Portland/Vancouver to Boise, ITS Corridor Study Plan*, WSDOT Advanced Technology Branch

*Application of Advanced Transportation Technology Within Washington State: Discussion and Policy Recommendations*, WSDOT Advanced Technology Branch

*State-Wide Communications Strategic Plan*, WSDOT Advanced Technology Branch

*Seattle to Portland Inter-City ITS Corridor Study and Communications Plan*, WSDOT Advanced Technology Branch

*Venture Washington*, WSDOT Advanced Technology Branch

## 860.03 Traffic Data Collection

Loop detectors, placed in traffic lanes, are the most common devices used to collect traffic data. In general, data stations are spaced at  $\frac{1}{2}$  mile intervals between interchanges. Alternative methods of detection include video detection cameras, microwave detectors, and other newer technologies. This information can be augmented with cellular phone calls from motorists, Washington State Patrol (WSP) reports, and commercial traffic reporters.

The loops sense the amount of time a vehicle is over them. This is called *occupancy* and is recorded by a data station in a nearby roadside cabinet. The data station periodically transmits the data to a central computer. The information from the detection system is transmitted over leased phone lines, WSDOT phone lines, fiber optic lines, or microwave transmitters to a traffic operations center. A spread spectrum radio is another method of transmitting data. The central computer translates these data into an indication of traffic congestion for incident detection and traffic flow information.

A single loop provides traffic volumes and lane occupancy from which, given some basic assumptions, speeds can be computed. Two loops spaced a known distance apart, longitudinally, provide better determinations of traffic speeds.

CCTV is used by the department to manage the freeway system. It is not usually used as a traffic law enforcement tool. The primary function of CCTV is to confirm or detect incidents. As a

secondary function, this information can be provided to the WSP, incident response teams, maintenance forces, and the local media.

## 860.04 Traffic Flow Control

During peak traffic volume periods, freeway on-ramps are metered with either roadside or overhead traffic signals. These ramp meters control or regulate the flow of traffic entering the freeway. The metering prevents the entering traffic from exceeding freeway capacity by limiting the number of vehicles that enter within a specific time period. The meters also keep long platoons of cars from merging onto the freeway. This process makes on-ramp merges safer and allows freeway traffic to move at a more efficient speed.

Ramp meters are traffic control signals and an approved traffic signal permit is required. The approval procedures for traffic signal permits are noted in Chapter 850.

Consider the available area for vehicle storage on the ramp when locating a ramp meter. If the arrival rate of the entering traffic exceeds the metered flow rate, traffic queues will develop. A common concern is that this queue might extend onto the crossroads and interfere with local traffic. Chapter 1050 provides guidance on the placement of the ramp meter. This guidance, however, only addresses the required acceleration needed to merge onto the freeway. The storage area needed at the meter varies at each location and is determined separately. If it is not possible to provide an adequate storage length on the ramp, consider alternate methods of addressing the problem.

- (1) Adjust the ramp metering rate to temporarily increase the rate.
- (2) Allow two vehicles to pass the meter at a time.
- (3) Widen to two metered lanes.
- (4) Provide storage lanes on the crossroad.
- (5) Provide alternate routes for local traffic.
- (6) Provide HOV bypass lanes.

(1) **Adjust Rate.** Ramp metering uses information from the detection loops to determine freeway congestion adjacent to and downstream from the ramps. Data from the loops are sent to a central computer or a local computer that adjusts the metering rate for the traffic congestion and transmits this rate to the ramp meter controllers. The ramp controllers implement the metering rate and control the signal. A ramp metering rate can be determined in two ways: remote metering and standby metering.

For remote metering, the metering rates of all ramp meter locations are determined by the local controller and adjusted by the central computer at the TOC. This is the normal mode of operation for the Seattle system. The central computer is capable of adjusting upstream metering rates on the basis of downstream conditions. A metering rate at an upstream location is decreased if traffic congestion develops downstream. Metering start and end times, as well as metering rates, can be remotely adjusted from the TOC with an override function.

Standby metering, also called local control, is used when communications with the central computer are interrupted or when that computer is not in service. In these cases, each ramp meter determines a metering rate for its on-ramp according to local traffic conditions or by a predetermined rate based on a time of day table. These time of day tables are developed to predict averages of the actual traffic volume peaking characteristics of the on-ramp. In standby metering, each ramp meter operates independently without coordinating with other controllers.

Single lane metering rates normally vary between 4 and 15 vehicles per minute (240 and 900 vehicles per hour). If a ramp has heavier traffic volumes and queue storage is not adequate, several actions can be taken.

(2) **Two Vehicles.** The metering capacity can be increased by allowing two vehicles to enter during each green cycle. This can increase a single lane ramp meter maximum capacity to about 1,100 vehicles per hour. This procedure is a temporary, operational solution and is not a recommended design practice.

(3) **Widen.** The metering capacity can be increased by widening the ramp to install additional lanes. Widening a single-lane on-ramp to create two lanes can double the metered traffic volume to 1,800 vehicles per hour, provided no downstream traffic congestion develops. Changes in ramp access to the freeway might require an access point decision report. (See Chapter 1425.)

(4) **Storage Lanes.** If adequate storage length cannot be provided on the ramp, it might be possible to provide storage as turn lanes on the crossroad and adjust the ramp terminal traffic signal timing to limit freeway access movements.

(5) **Diversion.** Diversion of some ramp traffic to local arterial streets might be desirable, assuming a suitable alternate route is available. When diversion occurs, modification of traffic signal timing and coordination plans on the alternative routes might be necessary. Coordinate efforts with the local agency and, if appropriate, initiate public meetings to identify needs and impacts.

(6) **HOV Bypass.** Wherever possible, provide bypass lanes for high occupancy vehicles (HOV) around the traffic queue at the ramp meter. The HOV bypass allows transit vehicles to maintain schedules and indirectly provides an incentive for carpooling. (See Chapter 1050.)

## 860.05 Motorist Information

Motorist information includes dynamic message signs, highway advisory radio, telephone traffic information lines, commercial radio and television messages, and Internet access for personal computers. These are all used to transmit traffic conditions to freeway users. The motorist information system is also used to alert drivers to short term construction and maintenance activities that might affect normal travel patterns. It can also be used to suggest alternative travel routes.

### (1) Dynamic Message Signs

Dynamic message signs (DMS) are used to provide motorists with current road and traffic conditions. Accidents, incidents, construction and maintenance activities, reversible lane status, traffic congestion, and traction device require-

ments are examples of this information. Because motorists receive many distractions while driving, consider the location of the DMS. The best location for a DMS is on a tangent section of roadway with few roadside distractions. Overhead installations have more visual impact. When possible, use sign bridges, cantilever sign structures, or bridge mounts on existing overcrossings for DMSs. Use the message displays and sign location requirements contained in the *Manual on Uniform Traffic Control Devices for Streets and Highways* (MUTCD) and Chapter 820.

### (2) Highway Advisory Radio

The highway advisory radio (HAR) system uses car radios to provide information to motorists. Warning signs, usually with flashing beacons, direct motorists to select a specific AM radio station for information. HAR has an advantage over DMS because longer messages with more detailed information can be relayed to the motorist. The major disadvantages are that not all vehicles have radios that can receive HAR frequencies, and some motorists might not use the radio for this information. HAR works best when used in conjunction with DMS.

HAR locations and assigned radio frequencies are restricted to prevent interference with other frequencies in use. HAR message content is restricted by federal regulations and WSDOT restricts HAR messages to noncommercial voice information pertaining to roadway and mountain pass conditions, major incidents, traffic hazards, and travel advisories.

### (3) Additional Public Information Components

A telephone number can be provided to give the same prerecorded messages as the HAR and can also include transit and carpool information. A computer generated flow map can be developed, using the data collection system, to graphically depict actual traffic flows within a geographical area. The flow map can be made accessible to the public by providing links to a WSDOT web site.



## **860.06 Documentation**

Preserve the following documents in the project file: See Chapter 330.

- Justification for the installation of ramp meters.
- Approved traffic signal permit for ramp meters.
- All correspondence and coordination with local agencies.
- Designs for the ultimate system when staged implementation is used.

*P65:DP/DMM*

910.01	General	FHWA; including the <i>Washington State Modifications to the MUTCD</i> , M 24-01, WSDOT
910.02	References	
910.03	Definitions	
910.04	Design Considerations	<i>Standard Plans for Road, Bridge, and Municipal Construction</i> (Standard Plans), M 21-01, WSDOT
910.05	Design Vehicle	
910.06	Right-Turn Corners	
910.07	Channelization	<i>A Policy on Geometric Design of Highways and Streets</i> (Green Book), AASHTO
910.08	Roundabouts	
910.09	U-Turns	NCHRP 279
910.10	Sight Distance at Intersections	<i>Intersection Channelization Design Guide</i>
910.11	Traffic Control at Intersections	Highway Research Record No. 211
910.12	Interchange Ramp Terminals	<i>Aspects of Traffic Control Devices</i> , pp 1-18, "Volume Warrants for Left-Turn Storage Lanes at Unsignalized Grade Intersections."
910.13	Procedures	Harmelink, M. D.
910.14	Documentation	

### 910.01 General

Intersections are a critical part of highway design because of increased conflict potential. Traffic and driver characteristics, bicycle and pedestrian needs, physical features, and economics are considered during the design stage to develop channelization and traffic control to enhance safe and efficient multimodal traffic flow through intersections.

This chapter provides guidance for designing intersections at grade, including at-grade ramp terminals. Guidelines for road approaches are in Chapter 920 and interchanges are in Chapter 940.

If an intersection design situation is not covered in this chapter, contact the Olympic Service Center (OSC) Design Office, for assistance.

### 910.02 References

*Americans with Disabilities Act of 1990* (ADA)

*Washington Administrative Code* (WAC) 468-18-040, "Design standards for rearranged county roads, frontage roads, access roads, intersections, ramps and crossings"

*Local Agency Guidelines* (LAG), M 36-63, WSDOT

*Manual on Uniform Traffic Control Devices for Streets and Highways* (MUTCD), USDOT,

FHWA; including the *Washington State Modifications to the MUTCD*, M 24-01, WSDOT

*Standard Plans for Road, Bridge, and Municipal Construction* (Standard Plans), M 21-01, WSDOT

*A Policy on Geometric Design of Highways and Streets* (Green Book), AASHTO

NCHRP 279

*Intersection Channelization Design Guide*

Highway Research Record No. 211

*Aspects of Traffic Control Devices*, pp 1-18,

"Volume Warrants for Left-Turn Storage Lanes at Unsignalized Grade Intersections."

Harmelink, M. D.

### 910.03 Definitions

**conflict** An event involving two or more road users, in which the action of one user causes the other user to make an evasive maneuver to avoid a collision.

**crossroad** The minor roadway at an intersection; at a stopped controlled intersection, the crossroad has the stop.

**intersection angle** The angle between any two intersection legs at the point that the center lines intersect.

**intersection at grade** The general area where a state highway or ramp terminal is met or crossed at a common grade or elevation by another state highway, a county road, or a city street

**four leg intersection** An intersection with four legs, as where two highways cross.

**tee (T) intersection** An intersection with three legs in the general form of a "T."

**wye (Y) intersection** An intersection with three legs in the general form of a "Y" and the angle between two legs is less than 60°.

**intersection leg** Any one of the roadways radiating from and forming part of an intersection.

**entrance leg** The intersection leg for traffic entering the intersection.

**exit leg** The intersection leg for traffic leaving the intersection.

Whether an intersection leg is an entrance leg or an exit leg depends on which movement is being analyzed. For two way roadways, each leg is an entrance leg for some movements and an exit leg for other movements.

**intersection sight distance** The distance that the driver of a vehicle on the crossroad can see along the main roadway, as compared to the distance required for safe operation.

**intersection turning radii** The geometric design of the intersection to allow the design vehicle for each turning movement to complete the turn without encroachment.

**island** A defined area within an intersection between traffic lanes for the separation of vehicle movements or for pedestrian refuge. It may be outlined with pavement markings or delineated by curbs. Within an intersection, a median is considered an island.

**median crossover** An opening in a median provided for crossings by maintenance, law enforcement, emergency, and traffic service vehicles

**roundabout** A circular intersection at which all traffic moves counterclockwise around a central island

## 910.04 Design Considerations

Intersection design requires consideration of all potential users of the facility. This involves addressing the needs of a diverse mix of user groups including passenger cars, heavy vehicles of varying classifications, bicycles, and pedestrians. Often, meeting the needs of one user group requires a compromise in service to others. Intersection design balances these competing needs, resulting in appropriate levels of operation for all users.

In addition to reducing the number of conflicts, minimize the conflict area as much as possible while still providing for the required design

vehicle (910.05). This is done to control the speed of turning vehicles and reduce vehicle, bicyclist, and pedestrian exposure.

### (1) Traffic Analysis

Conduct a traffic analysis and an accident analysis to determine the design characteristics of each intersection. Include recommendations for channelization, turn lanes, acceleration and deceleration lanes, intersection configurations, illumination, bicycle and pedestrian accommodations, ADA requirements, and traffic control devices in the traffic analysis.

### (2) Intersection Configurations

An important intersection design characteristic is the intersection angle. The intersection angle is the angle between any two intersection legs. The allowable intersection angles are 75° to 105°.

An approved deviation is required when the following intersection configurations cannot be avoided:

- Intersections with offset legs.
- Intersections with more than four legs.
- Tee intersections with the major traffic movement making a turn.
- Wye intersections that are not a one-way merge or diverge.
- Angle points or short radius curves within the intersection.
- Other nonstandard intersection design.

### (3) Crossroads

When the crossroad is a city street or county road, design the crossroad according to the applicable standards shown in:

- Chapter 468-18 WAC.
- The LAG manual.
- The standards of the local agency that will be requested to accept the facility.

When the crossroad is a state facility, design the crossroad according to the applicable design level and functional class (Chapters 325, 430, and 440)

Continue the cross slope of the through roadway shoulder as the grade for the crossroad. Use a vertical curve that is at least 60 ft long to connect to the grade of the crossroad.

In areas that experience accumulations of snow and ice and for all legs that will require traffic to stop, design a maximum grade of  $\pm 6$  percent for a length equal to the anticipated queue length for stopped vehicles.

### 910.05 Design Vehicle

The physical characteristics of the design vehicle control the geometric design of the intersection. The following design vehicle types are commonly used:

Design Symbol	Vehicle Type
P	Passenger car, including light delivery trucks.
BUS	Single unit bus
A-BUS	Articulated bus
SU	Single unit truck.
WB-40	Semitrailer truck, overall wheelbase of 40 ft.
WB-50	Semitrailer truck, overall wheelbase of 50 ft.
WB-67	Semitrailer truck, overall wheelbase of 67 ft.

**Design Vehicle Types**  
*Figure 910-1*

The design vehicle for any intersection is the largest vehicle that normally uses the intersection. The primary use of the design vehicle is to determine turning radii requirements for each leg of the intersection. It is possible for each leg to have a different design vehicle. Figure 910-2 shows the recommended minimum design vehicles. An approved deviation is required for the use of a smaller vehicle, except as noted. As justification for a deviation, include a traffic analysis showing that the proposed vehicle is appropriate.

Intersection Type	Design Vehicle
Junction of Major Truck Routes	WB-67
Junction of State Routes	WB-50
Ramp Terminals	WB-50
Other Rural	WB-50
Urban Industrial	WB-40
Urban Commercial	SU <sup>1</sup> 2
Residential	SU <sup>1</sup> 2

1. To accommodate pedestrians, the P vehicle may be used as the design vehicle if justification, with a traffic analysis, is documented.
2. When the intersection is on a transit route, use the BUS design vehicle as a minimum. See Chapter 1060 for additional guidance for transit facilities and for the BUS turning path templates.

**Intersection Design Vehicle**  
*Figure 910-2*

To minimize the disruption to other traffic, design the intersection to allow the design vehicle to make all legal movements without encroaching on curbs, shoulders, or opposing lanes. An approved deviation is required for a design that allows encroachment on adjacent same-direction lanes at the entrance leg.

Encroachment on same-direction lanes of the exit leg may be necessary to minimize crosswalk distances; however, this might negatively impact vehicular operations. Document and justify the operational trade-offs associated with this encroachment.

Design each turning movement so the largest vehicle that is legal on both legs can make the turn without leaving the paved shoulders or encroaching on a sidewalk. Use the WB-67 as the largest legal vehicle at all state route to state route junctions. Document any required encroachment into other lanes, and any

degradation of intersection operation. Use the vehicle turning path templates in Figures 910-6a and 6b, or templates from another published source, to verify that this vehicle can make the turning movements.

### 910.06 Right-Turn Corners

The geometric design of an intersection requires identifying and addressing the needs of all intersection users. For the design of right turn corners, there may be competing design objectives when considering the turning requirements of the design vehicle and the crossing requirements of pedestrians. To reduce the operational impacts of large trucks, right-turn radii are designed so that the truck can complete its turn without encroaching on the adjacent lanes at either the entrance or the exit legs of the curve. This results in larger corner radii which increases pavement area and pedestrian crossing distance, resulting in a larger conflict area and higher vehicle turning speeds.

When pedestrian issues are a primary concern, the design objectives become one of reducing the potential for vehicle/pedestrian conflicts. This is done by minimizing pedestrian crossing distance and controlling speeds of concurrently turning vehicles. This normally leads to right-corner designs with smaller turning radii. The negative impacts include capacity reductions and greater speed differences between turning vehicles and through vehicles.

Pedestrian refuge islands can also improve pedestrian safety. Pedestrian refuge islands minimize the crossing distance, reduce the conflict area, and minimize the impacts on vehicular traffic. When designing islands, speeds can be reduced by designing the turning roadway with a taper or large radius curve at the beginning of the turn and a small radius curve at the end. This allows larger islands while forcing the turning traffic to slow down.

Figure 910-7 shows typical right-turn corner designs for the design vehicles at intersections. These are considered the minimum pavement area to accommodate the design vehicles without

their encroaching on the adjacent lane at either leg of the curve. Using the taper at the exit of the right-turn corner reduces the pavement area when compared to a simple radius.

When pedestrians are of primary concern and the exit leg of a turning movement contains multiple lanes, a smaller radius than given in Figure 910-7 may be used to reduce crosswalk distances. However, this requires the design vehicle to encroach on the adjacent same direction lane at the exit leg. This may degrade intersection operations. Document the impacts of this design, including anticipated pedestrian activity, capacity restrictions for right-turning vehicles, and the effects on other traffic movements.

Use a turning template for the design vehicle with a turning radius of 59 ft or larger to determine the vehicle path. When the operational impacts continue for more than one signal cycle, consider a larger turning radius with a raised pedestrian refuge island or elimination of the pedestrian crossing.

### 910.07 Channelization

Channelization is the separation or regulation of traffic movements into definite paths of travel to facilitate the safe and orderly movement of vehicles, bicycles, and pedestrians.

Painted or plastic pavement markings are normally used to delineate travel paths. (Refer to Chapter 830 and the standard plans for details.)

Nonstandard channelization requires an approved deviation.

#### (1) Left-Turn Lanes

Left-turn lanes provide storage, out of the through lanes, for left-turning vehicles waiting for a signal to change or for a gap in opposing traffic. (See 910.07(3) for a discussion on speed change lanes.)

Design left-turn channelization to provide sufficient operational flexibility to function under peak loads and adverse conditions.

(a) **One-Way Left-Turn Lanes** are separate storage lanes for vehicles turning left from one roadway onto another. When recommended,

one-way left-turn lanes are an economical way to lessen delays, accidents, and accident potential involving left-turning vehicles. In addition, they may provide for deceleration clear of the through traffic lanes.

At unsignalized intersections on two-lane highways, use the following as a guide to determine whether or not to consider one-way left-turn lanes:

- Recommendation from Figure 910-8 based on total traffic volume (DHV) for both directions and percent left-turn traffic.
- An accident study indicates that a left-turn lane will reduce accidents.
- Restrictive geometrics that require left-turning vehicles to slow greatly below the speed of the through traffic.
- Less than decision sight distance at the approach to the intersection.

Where left-turn lanes are to be used, determine the storage length required using Figures 910-9a through 9d. For those cases that do not fall within range of the charts, where conditions preclude use of the charts, or for design of left-turn storage on four lane highways, contact the OSC Design Office.

At signalized intersections, one-way left-turn lanes are normally provided on each main line approach.

Where one-way left-turn channelization with curbing is to be provided, ensure that surface water will drain.

Provide illumination at left-turn lanes in accordance with the guidelines in Chapter 840.

Figures 910-10a through 10d show typical one-way left-turn geometrics. Figure 910-10a shows widening to accommodate the new lane. Figures 910-10b and 10c show the use of a median.

1. **Widening (Figure 910-10a).** It is desirable that offsets and pavement widening be symmetrical about the center line or base line. Where right of way or topographic restrictions, unfavorable alignment of

crossroads, or other circumstances preclude symmetrical widening, pavement widening may be on one side only.

2. **Divided Highways (Figure 910-10b and 10c).** Widening is not required for left-turn lane channelization where medians are 13 ft wide or wider. The median acceleration lane shown on the figure can also be provided where the median is 23 ft or wider. The median acceleration lane may not be necessary at a signalized intersection. When a median acceleration lane is to be used, design it in accordance with 910.07(3) Speed Change Lanes.

At intersections on divided highways where channelized left turn lanes are not provided, consider a minimum protected storage area as shown on Figure 910-10d.

(b) **Two-Way Left-Turn Lanes (TWLTL)** are located between opposing lanes of traffic. They are used by vehicles making left turns from either direction, either from or onto the roadway.

In general, use TWLTLs only in an urban setting where there are no more than two through lanes in each direction. Consider installation of TWLTLs where:

- An accident study indicates that a TWLTL will reduce accidents.
- There are closely spaced access points or minor street intersections.
- There are unacceptable through traffic delays or capacity reductions because of left turning vehicles.

The basic guidelines necessary to develop a TWLTL plan are illustrated on Figure 910-10e. Additional criteria are:

- The desirable length of a TWLTL is not less than 250 ft.
- Illumination may be provided in accordance with the guidelines in Chapter 840.
- Pavement markings, signs, and other traffic control devices must be in accordance with the MUTCD and the Standard Plans.

## **(2) Right-Turn Lanes**

Right-turn movements influence intersection capacity even though there is no conflict between right-turning vehicles and opposing traffic. Right-turn lanes may be required to maintain efficient intersection operation. Use the following as guidelines to determine when to consider right-turn lanes:

- Recommendation from Figure 910-11 based on approach and right-turn traffic volumes.
- An accident study indicates that a right-turn lane will reduce accidents.
- Presence of pedestrians who would require right-turning vehicles to stop in the through lanes.
- Restrictive geometrics that require right-turning vehicles to slow greatly below the speed of the through traffic.
- Less than decision sight distance at the approach to the intersection.

For unsignalized intersections, see 910.07(3) Speed Change Lanes for guidance on right-turn lane lengths. For signalized intersections, use queue analysis to determine the right-turn lane lengths. If possible, make the right-turn lane equal to the longest queue (the right-turn queue or the through queue).

A capacity analysis may be used to determine if right-turn lanes are necessary to maintain the desired level of service.

When designing right-turn lanes at signalized intersections, consider reducing the shoulder width to not more than 4 ft. This reduces the pavement widening for the turn lane and removes the temptation for vehicles to use the shoulder to bypass the other vehicles in the turn lane.

Where adequate right of way exists, providing right-turn lanes is relatively inexpensive and can provide increased safety and operational efficiency.

The right-turn pocket or the right-turn taper (Figure 910-12a) may be used at any minor intersection where a deceleration lane is not required and turning volumes indicate a need as

set forth in Figure 910-11. These designs will cause less interference and delay to the through movement by offering an earlier exit to right-turning vehicles.

If the right-turn pocket is used, Figure 910-12a shows taper lengths for posted speeds below 40 mph and for 40 mph or above.

A lane may be dropped at an intersection with a turn-only lane or beyond the intersection with an acceleration lane. Minimum acceleration lane lengths are shown on Figure 910-13.

## **(3) Speed Change Lanes**

A speed change lane is an auxiliary lane primarily for the acceleration or deceleration of vehicles entering or leaving the through traveled way. Speed change lanes are normally provided for at-grade intersections on multilane divided highways with access control. Where roadside conditions and right of way allow, speed change lanes may be provided on other main highways. Justification for a speed change lane depends on many factors, such as speed, traffic volumes, capacity, type of highway, the design and frequency of intersections, and accident experience.

A deceleration lane is advantageous because, if a deceleration lane is not provided, the driver leaving the highway must slow down in the through lane regardless of following traffic. An acceleration lane is not as advantageous because entering drivers can wait for an opportunity to merge without disrupting through traffic.

When either deceleration or acceleration lanes are to be used, design them in accordance with Figures 910-12b and 13. When the design speed of the turning traffic is greater than 20 mph, design the speed change lane as a ramp in accordance with Chapter 940. When a deceleration lane is used with a left-turn lane, add the deceleration length to the storage length.

## **(4) Curbing**

Consider channelization with curbing for situations such as:

- Divisional and channelizing islands.
- Islands with luminaires, signals, or other traffic control devices.

- Pedestrian refuge islands.
- Landscaped areas within the roadway.
- Prevention of mid-block left turns.

Avoid using curbs if the same objective can be attained with pavement markings. When prohibiting left turns, an 18-in barrier stripe with appropriate signing is an alternative.

Snow removal operations can be hampered by curbs and raised islands. Contact the regional Operations Engineer when considering raised channelization in areas of heavy snowfall.

In general, neither mountable nor barrier curbs are used on facilities with a posted speed greater than 40 mph. The exceptions are for predominantly urban or rapidly developing areas where sidewalks are provided or where traffic movements are to be restricted.

The two general classes of curbs are mountable curbs and barrier curbs (see the standard plans for designs). Precast traffic curb, precast block curb, and all extruded curbs are considered mountable.

Barrier curbs are 6 in or more high with a face batter not flatter than 1H:3V. They are used:

- to inhibit or at least discourage vehicles from leaving the roadway;
- for walkway and pedestrian refuge separations; and
- for raised islands on which a traffic signal, or traffic signal hardware, is located

Mountable curbs have a height of 6 in or less, preferably 4 in or less, with a sloping face that is more readily traversed. When the face slope is steeper than 1:1, the height of a mountable curb is limited to 4 in or less. They are used where a curb is needed but barrier curb is not justified.

When curbing is used, provide the minimum shy distances shown in Figure 910-3. Where mountable curb is used on the left, the shy distance may be omitted. (For traffic islands, also see 910.07(5).)

	Shy Distance		
	On Left		On Right
Lane Width	Rural	Urban	Rural and Urban
12 ft	1 ft	1 ft	2 ft min*
11 ft	2 ft	1 ft	2 ft min*
10 ft	3 ft	2 ft	2 ft min*

\*For noncontinuous curbs or where bicycles are anticipated, the minimum shy distance to the face of the curb is 3 ft.

**Shy Distance for Barrier Curb**  
Figure 910-3

### (5) Islands

An island is a defined area within an intersection between traffic lanes for the separation of vehicle movements or for pedestrian refuge. Within an intersection, a median is considered an island. Design islands to clearly delineate the traffic channels to drivers and pedestrians.

Traffic islands perform these functions:

- Channelization islands control and direct traffic movement.
- Divisional islands separate opposing or same-direction traffic movements.
- Refuge islands provide refuge for pedestrians.
- Islands can provide for the placement of traffic control devices and luminaires.
- Islands can provide areas within the roadway for landscaping.

(a) **Size and Shape.** Divisional and refuge islands are normally elongated and at least 4 ft wide and 20 ft long. Mountable curb used to discourage turn movements is not considered a divisional island.

Channelization islands are normally triangular. In rural areas, 75 ft<sup>2</sup> is the minimum island area and 100 ft<sup>2</sup> is desirable. In urban areas where posted



speeds are 25 mph or less, smaller islands may be acceptable. Use islands with at least 200 ft<sup>2</sup> of area if pedestrians will be crossing or traffic control devices or luminaires will be installed.

Design triangular shaped islands as shown on Figure 910-14a through 14c. The shy distances illustrated are for islands constructed with barrier curbs. Where painted islands are used, such as in rural areas, these shy distances are desirable but may be omitted. Where barrier curbing is used, provide the minimum shy distances as shown in Figures 910-3 and 14b.

Avoid shy distances wider than 6 ft because the wider distances can appear to be another lane.

Island markings may be supplemented with reflective raised pavement markers.

Barrier-free access must be provided at crosswalk locations where raised islands are used. This can be accomplished by one of three methods:

- Reroute pedestrian traffic if feasible.
- For islands 17 ft wide or wider at the crosswalk location, provide ramps as shown in Figure 910-14b.
- For islands less than 17 ft wide at the crosswalk location, provide a passageway through the island.

The 17 ft dimension is for curbs 6 in high. For curbs at any other height, the maximum slope of the ramps is not steeper than 12H:1V. The maximum cross slope of any ramp, passageway, or sidewalk is 2 percent.

(b) **Location.** Design the approach ends of islands to provide adequate visibility to alert the motorist of their presence. Position the island so that a smooth transition in vehicle speed and direction is attained. Begin transverse lane shifts far enough in advance of the intersection to allow gradual transitions. Avoid introducing islands on a horizontal or vertical curve. If the use of an island on a curve cannot be avoided, provide adequate sight distance, illumination, or extension of the island .

(c) **Compound Right-Turn Lane.** To design large islands, the common method is to use a large radius curve for the turning traffic. While

this does provide a larger island, it also encourages higher turning speeds. Where pedestrians are a concern, higher turning speeds are undesirable. An alternative is a compound curve with a large radius followed by a small radius (Figure 910-14c). This design forces the turning traffic to slow down.

## 910.08 Roundabouts

Modern roundabouts are circular intersections. They can be an effective intersection type.

Modern roundabouts differs from the old rotaries and traffic circles in two important respects: they have a smaller diameter which lowers speeds; and they have splitter islands that provide entry constraints, slowing down the entering speeds.

When well designed roundabouts are an efficient form of intersection control, they have fewer conflict points, lower speeds, easier decision making, and they require less maintenance. They have been found to reduce injury accidents, traffic delays, fuel consumption, and air pollution. Roundabouts also permit U-turns.

Consider roundabouts at the following intersections:

- Where stop signs result in unacceptable delays for the crossroad traffic. Roundabouts reduce the delays for the cross road, but increase the delays for the through roadway.
- With a high left-turn percentage. Unlike most intersection types, roundabouts can operate efficiently with high volumes of left-turning traffic.
- With more than four legs. When the intersection cannot be modified by closing or relocating legs, a roundabout can provide a solution.
- Where a disproportionately high number of accidents involve crossing or turning traffic.
- Where the major traffic movement makes a turn.
- Where traffic growth is expected to be high and future traffic patterns are uncertain.
- Where it is not desirable to give priority to either roadway.

There are some disadvantages with roundabouts. Roundabouts do not allow for a primary roadway to have priority because all legs entering a roundabout are treated the same. Also, all traffic entering a roundabout is required to reduce speed. Therefore, roundabouts are not appropriate on high speed facilities, where traffic flows are unbalanced, or where an arterial intersects a collector or local road.

When considering a roundabout, contact the OSC Design Office for additional information, design assistance and intersection approval.

When a roundabout is being considered, submit advance engineering data and a preliminary intersection plan to the OSC Design Office.

### 910.09 U-turns

For divided highways without full access control that have access points where a median prevents left turns, consider providing locations designed to allow U-turns. Normally, the U-turn opportunities are provided at intersections; however, where intersections are spaced far apart, consider median openings between intersections to accommodate U-turns. Use the desirable U-turn spacing (Figure 910-4) as a guide to determine when to consider U-turn locations between intersections. When the U-turning volumes are low, use longer spacing.

	U-Turn Spacing	
	Desirable	Minimum
Urban <sup>(1)</sup>	1,000 ft	<sup>(2)</sup>
Suburban	3,300 ft	1,300 ft <sup>(3)</sup>
Rural	6,600 ft	2,600 ft

1 For design speeds greater than 45 mph use suburban spacing.  
 2 The minimum spacing is the acceleration lane length from a stop plus 300 ft.  
 3 For design speeds greater than 50 mph, the minimum spacing is the acceleration lane length from a stop plus 300 ft.

### U-Turn Spacing

Figure 910-4

When designing U-turn locations, use Figure 910-15 as a guide. Where the median is less than 40 ft wide and a large design vehicle is required, consider the use of a U-turn roadway.

Document the need for U-turn locations, the spacing used, and justify the selected design vehicle.

### 910.10 Sight Distance at Intersections

For traffic to move safely through intersections, drivers need to be able to see stop signs, traffic signals, and oncoming traffic in time to react accordingly.

Provide decision sight distance, where practical, in advance of stop signs and traffic signals. See Chapter 630 for guidance.

The driver of a vehicle stopped, waiting to cross or enter a through roadway, needs obstruction-free sight triangles in order to see enough of the through roadway to safely complete all legal maneuvers before an approaching vehicle on the through roadway can reach the intersection. Calculate the length of travel for the design vehicles to clear the intersection and, using Figures 910-16a and 16b, determine minimum sight distance along the through roadway.

The sight triangle is determined as shown in Figures 910-16a through 910-16c. Within the sight triangle, lay back the cut slopes and remove, lower, or move hedges, trees, signs, utility poles, and anything else large enough to be a sight obstruction. Consider eliminating parking so sight distance is not obstructed.

Provide a clear sight triangle for a P vehicle at all intersections. In addition to this, provide a clear sight triangle for the SU vehicle for most rural highway conditions. Consider including a school bus in rural areas where they play an important part in the traffic operations. If there is significant combination truck traffic, use the WB-50 or WB-67 rather than the SU. In areas where SU or WB vehicles are minimal, and right of way restrictions prohibit adequate sight triangle clearing, only the P vehicle need be considered.

At some intersections, the turning volume from a stop-controlled crossroad is significant enough to conflict with vehicles on the through roadway. Consider sight distances as shown on Figure 910-5 at these intersections. This is the sight distance required for a P vehicle to turn left or right onto a two-lane highway and attain average running speed without being overtaken by an approaching vehicle going the same direction at the average running speed.

Design Speed (mph)	Sight Distance (ft)
25	300
30	380
35	480
40	590
45	730
50	860
60	1,150
70	1,560

**Sight Distance for Turning Vehicles**

*Figure 910-5*

Designs for movements across divided highways are influenced by the median widths. If the median is wide enough to store the design vehicle, sight distances are determined in two steps. The first step is for crossing from a stopped position to the median storage; the second step is for the movement, either across, or left into the through roadway.

Design ramp terminal sight distance as for at-grade intersections with a turning movement. An added element at ramp terminals is the grade separation structure between the main line and the crossroad. Figure 910-16c gives the sight distance considerations in the vicinity of a structure. In addition, when the crossroad is an undercrossing, check the sight distance under the structure graphically using a truck eye height of 6 ft and an object height of 1.5 ft.

Document a brief description of the intersection area, sight distance restrictions, and traffic characteristics to support the design vehicle and sight distances chosen.

## 910.11 Traffic Control at Intersections

Intersection control is the process of moving traffic safely through areas of potential conflict where two or more roadways meet. Signs, signals, channelization, and physical layout are the major tools used to establish intersection control.

There are three objectives to intersection control that can greatly improve intersection operations.

- **Maximize Intersection Capacity.** Since two or more traffic streams cross, converge, or diverge at intersections, capacity of an intersection is normally less than the roadway between intersections. It is usually necessary to assign right of way through the use of traffic control devices to maximize capacity for all users of the intersection. Turn prohibitions may be used to increase intersection capacity.
- **Reduce Conflict Points.** The crossing, converging, and diverging of traffic creates conflicts which increase the potential for

accidents involving turning vehicles. Establishing appropriate controls can reduce the possibility of two cars attempting to occupy the same space at the same time. Pedestrian accident potential can also be reduced by appropriate controls.

- **Priority of Major Streets.** Traffic on major routes is normally given the right of way over traffic on minor streets to increase intersection operational efficiency.

If a signal is being considered or exists at an intersection that is to be modified, submit advance engineering data and a preliminary signal plan to the Olympia Service Center Traffic Office (Chapter 850). If a new permit is required, it must be approved before the design is approved.

### 910.12 Interchange Ramp Terminals

On one-way ramp terminals with stop or traffic signal control at the local road, the design to be used or modified for use is shown on Figure 910-17. Higher volume intersections with multiple ramp lanes are designed individually.

Due to probable development of large traffic generators adjacent to an interchange, width for a median on the local road is desirable whenever such development is believed imminent. This allows for future left-turn channelization. Median channelization is always provided when justified by capacity determination and analysis of the intersection, or by the need to provide a smooth traffic flow.

Determine the number of lanes for each leg by capacity analysis methods assuming a traffic signal cycle, preferably 45 or 60 seconds in length, regardless of whether a signal is used or not. Consider all terminals in the analysis.

Adjust the alignment of the intersection legs to fit the traffic movements and to discourage wrong way movements. Use the allowed intersecting angles of 75° to 105° (60° to 120° for modified design level) to avoid broken back or reverse curves in the ramp alignment.

### 910.13 Procedures

Document design considerations and conclusions in accordance with Chapter 330. For highways with access control, see Chapter 1420 for access control requirements.

#### (1) Approval

An intersection is approved in accordance with Chapter 330. When required, the following items must be in the project file before an intersection may be approved:

- Traffic analysis
- Deviations approved in accordance with Chapter 330
- Preliminary traffic signal plan approved by the OSC Traffic Office. (See Chapter 850.)
- Intersections with roundabouts require OSC Design Office approval. See 910.08 for approval procedures.

#### (2) Intersection Plans

Intersection plans are required for any increases in capacity (turn lanes) of an intersection, modification of channelization, or change of intersection geometrics. Support the need for intersection or channelization modifications with history, school bus and mail route studies, hazardous materials route studies, public meeting comments, and so forth.

Include the following as applicable:

- Drawing of the crossroad, existing and realigned.
- Main line stationing of the intersection and angle between intersection legs.
- Curve data on main line and crossroads.
- Right of way lines.
- Location and type of channelization.
- Numbers of lanes; width of lanes and shoulders on main line and crossroads (Chapter 620).
- Proposed access control treatment (Chapter 1420).

- Traffic data including volumes for all movements and vehicle classification.
- Classes of highway for main line and crossroads and design speeds (Chapter 440).
- Traffic signals.

### **(3) Local Agency or Developer Initiated Intersections**

There is a separate procedure for local agency or developer-initiated projects at intersections with state highways. The project initiator submits an intersection plan, and the documentation of design considerations that led to the plan, to the region for approval. For those plans requiring a deviation, the deviation must be approved in accordance with Chapter 330 prior to approval of the plan. After the plan approval, the region prepares a construction agreement with the project initiator. (See the *Utilities Manual*.)

#### **910.14 Documentation**

The following documents are to be preserved for future reference in the project file. See Chapter 330.

- Design vehicle selection justifications
- Traffic analyses
- Accident studies
- Approved deviations
- Approved traffic signal plans
- Intersection plans and supporting information
- Justification for encroachment on other lanes
- Sight distance documentation
- U-turn documentation

P65:DP/DM9

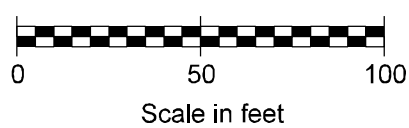
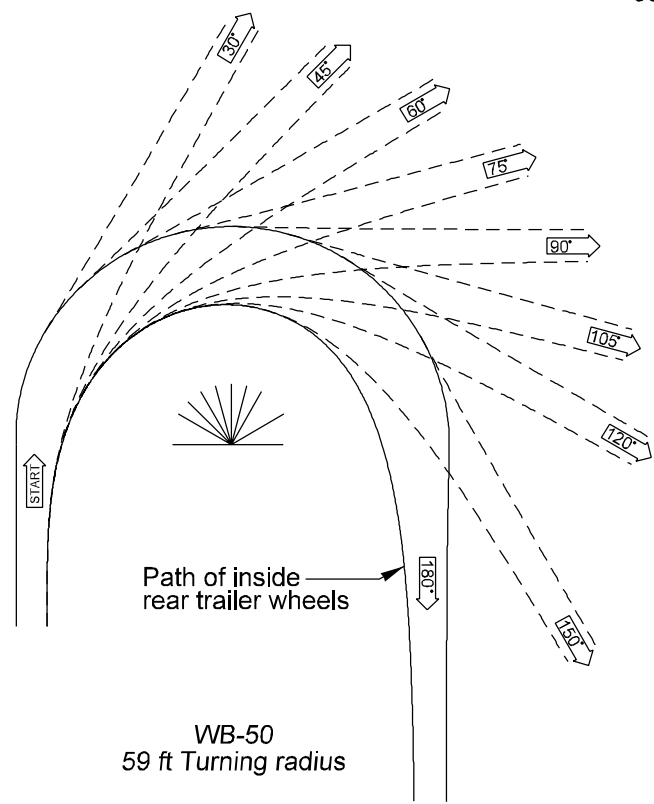
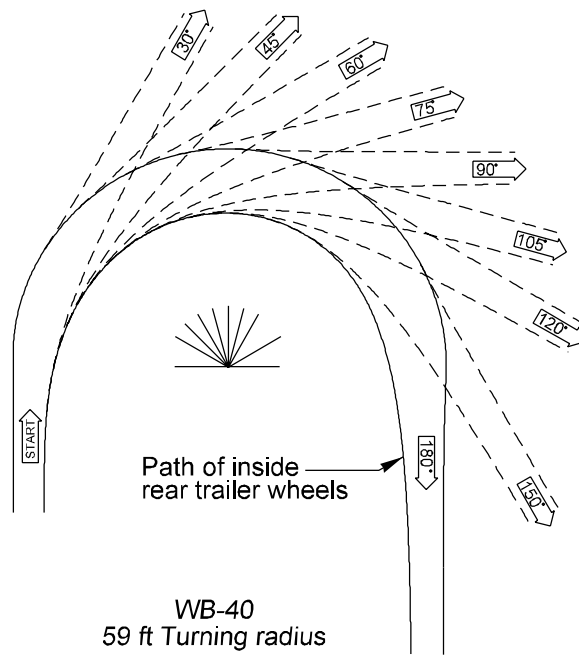

**Turning Path Template**  
Figure 910-6a

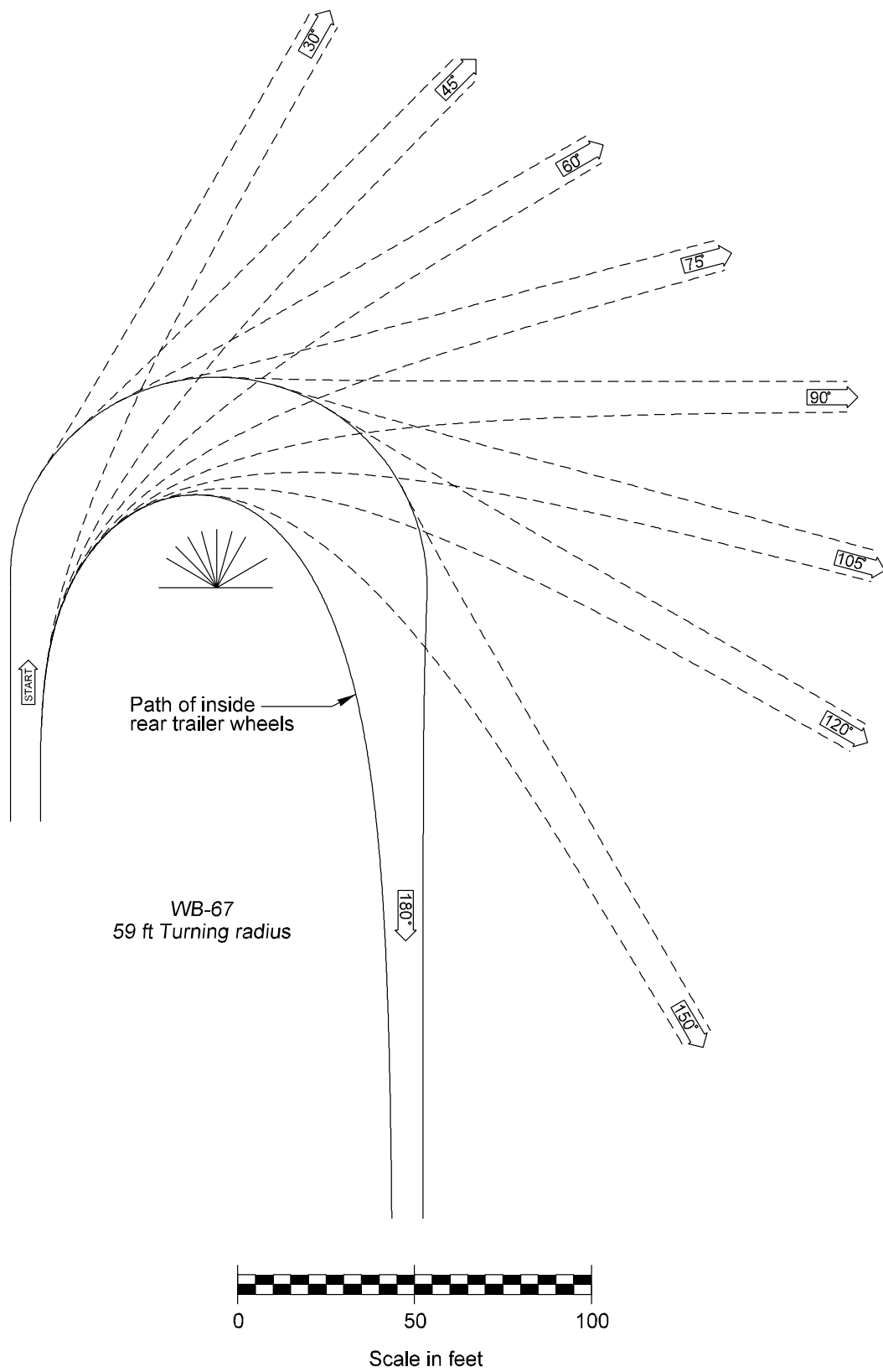

**Turning Path Template**  
*Figure 910-6b*

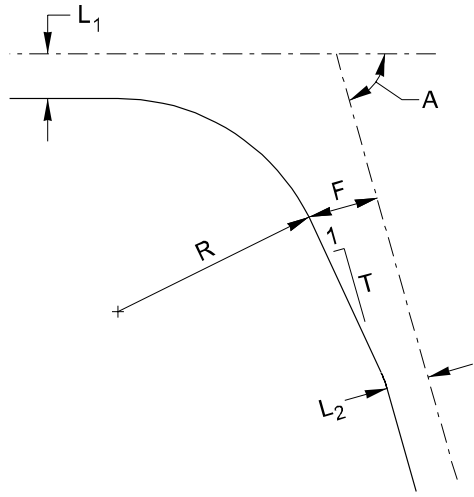

- $L_1$  = Width of the lane that the vehicle is turning from (ft).
- $L_2$  = Width of the lane that the vehicle is turning into (ft).
- $R$  = Radius to the edge of traveled way (ft).
- $F$  = Width of roadway at the end of curve (ft).
- $T$  = Taper rate (length per unit of width of widening).
- $A$  = Delta angle of the turning vehicle.

Vehicle	A	R	L <sub>1</sub>	L <sub>2</sub>	F	T	Vehicle	A	R	L <sub>1</sub>	L <sub>2</sub>	F	T
WB-67	60	175	11	12 <sup>1</sup>			WB-40	60	80	11	11		
		85	11		22	10			55	12		16	7.5
	75	155	11	12				75	75	12	12		
		75	11		23	10			55	12		16	7.5
	90	135	11	12				90	75	11	12		
		70	11		23	10			55	11		16	7.5
	105	115	11	12				105	75	11	11		
		65	11		23	10			55	11		16	7.5
120	100	11	12			120	70	11	11				
	55	12		25	10		55	11		14.5	7.5		
WB-50	60	105	12	12			SU	All	55	11	12 <sup>2</sup>		
		55	12		20	6	P	All	35	11	11		
	75	95	11	12									
		55	12		20	6							
	90	85	11	12									
		55	12		19	6							
	105	80	11	12									
		55	11		18.5	6							
120	75	11	11										
	50	11		19.5	8								

When the lane width ( $L_1$  or  $L_2$ ) is less the values given, widen to the given value at 25:1.  
<sup>1</sup>12.5 ft when widening is required.  
<sup>2</sup>11 ft at 120°.

**Right-Turn Corner**  
**Figure 910-7**



**LEFT TURN STORAGE GUIDELINES**  
 Unsignalized intersection  
 Two - lane highway

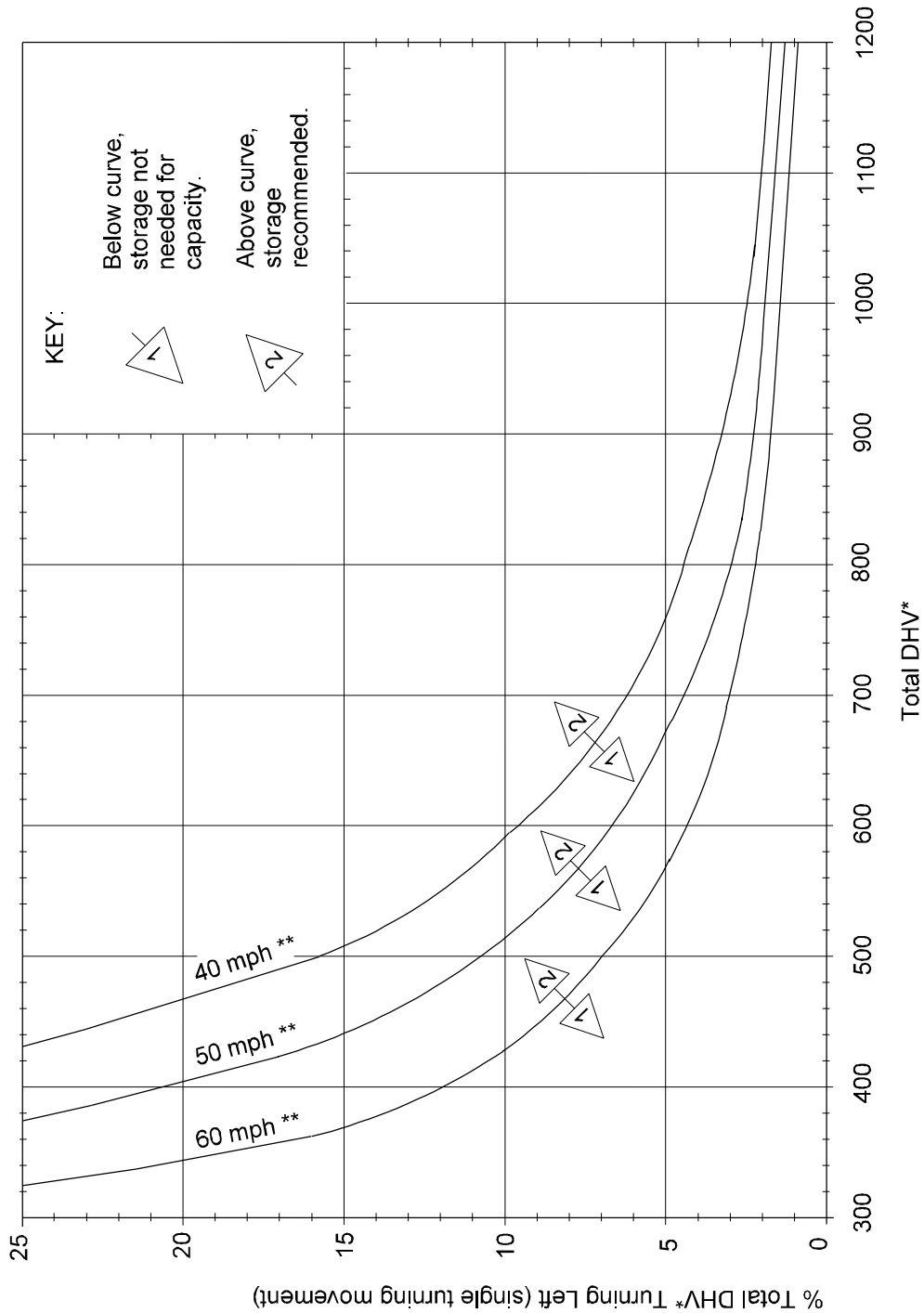

\*DHV is total volume from both directions.  
 \*\*Speeds are posted speed limits.

**Left-Turn Storage Guidelines**  
 Figure 910-8

40 mph Posted speed  
 Unsignalized intersection  
 Two-lane highway

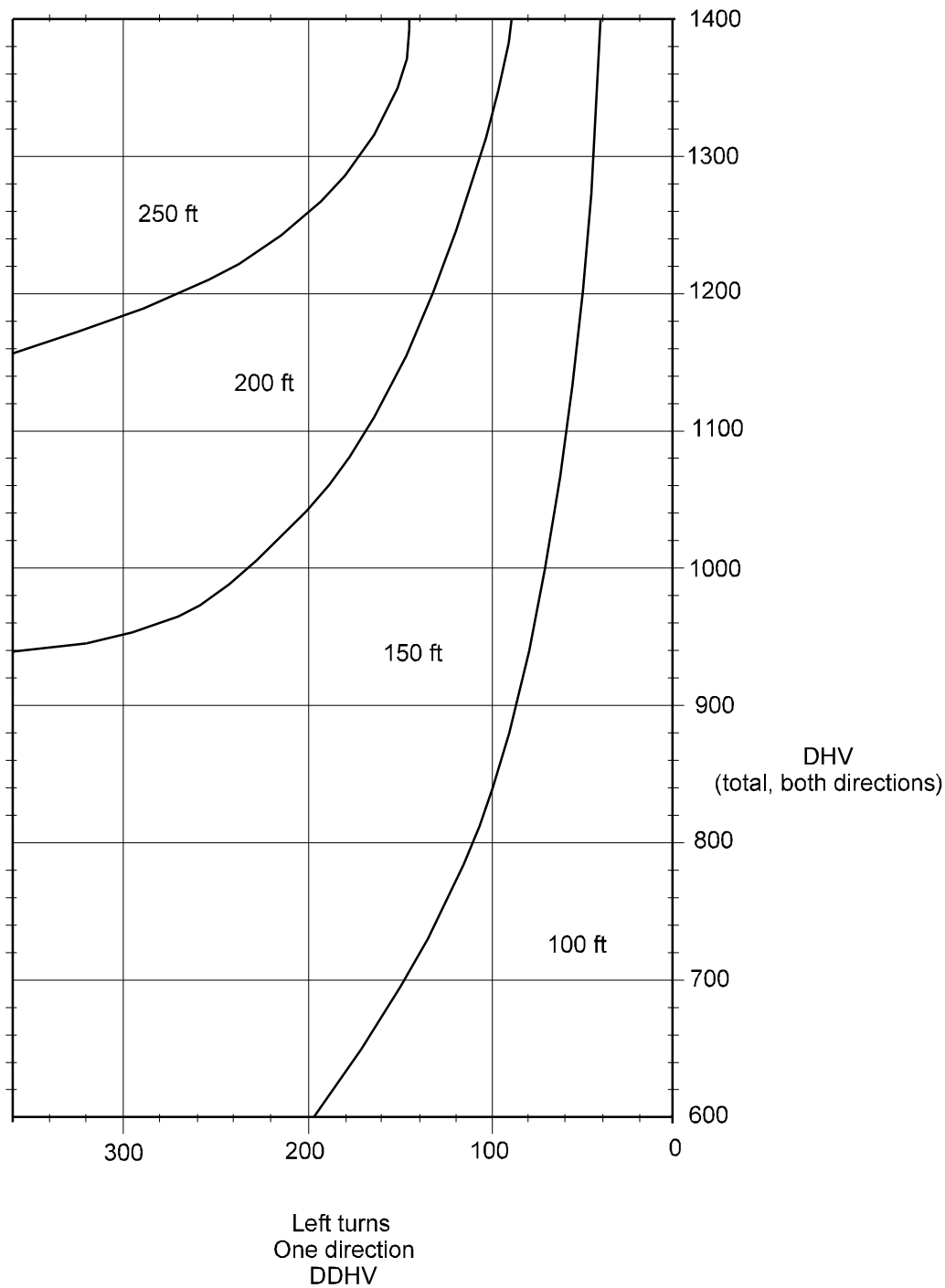

**Left-Turn Storage Length**  
*Figure 910-9a*

50 mph Posted speed  
 Unsignalized intersection  
 Two-lane highway

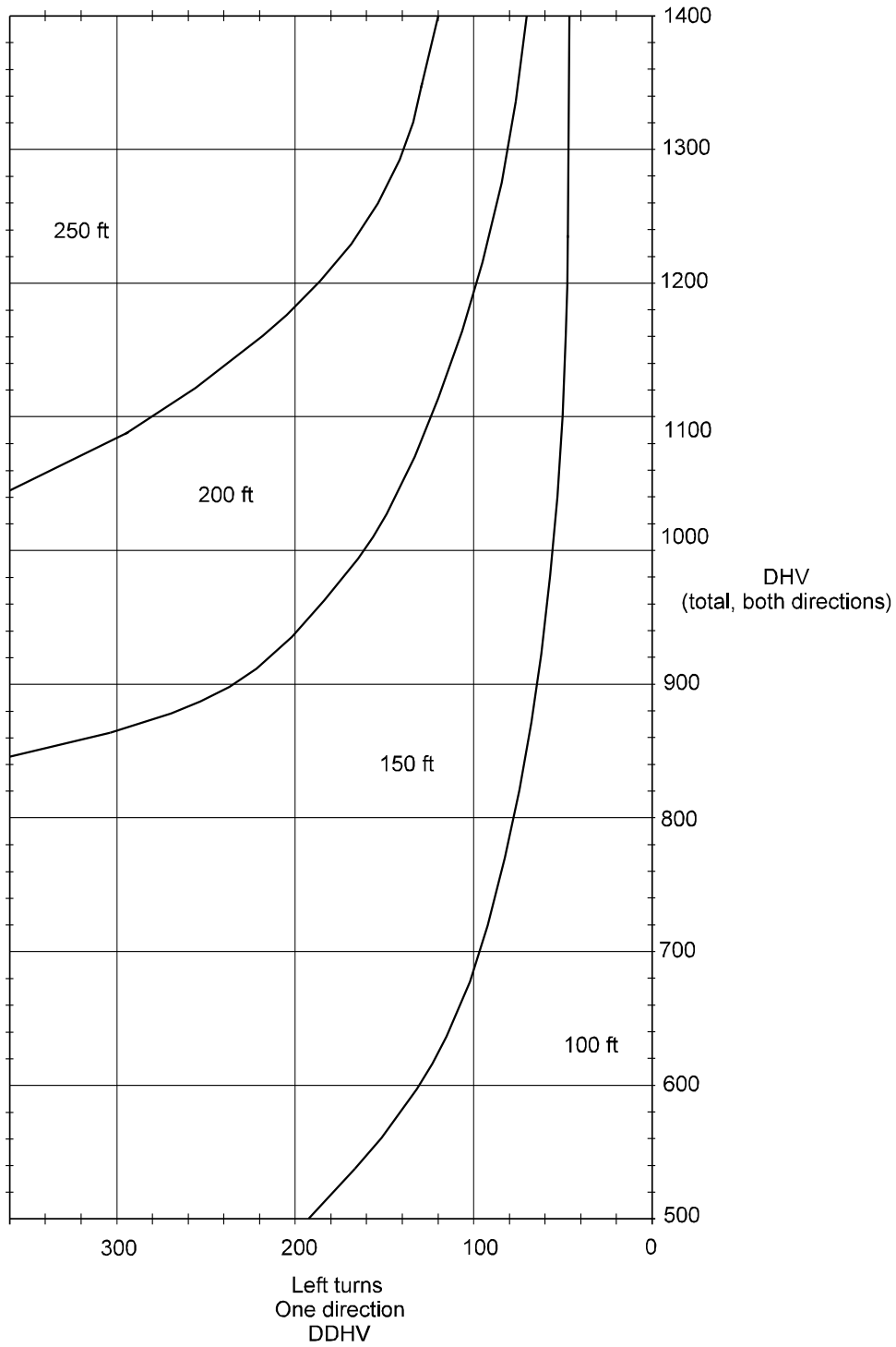

**Left-Turn Storage Length**  
*Figure 910-9b*

60 mph posted speed  
 Unsignalized intersection  
 Two-lane highway

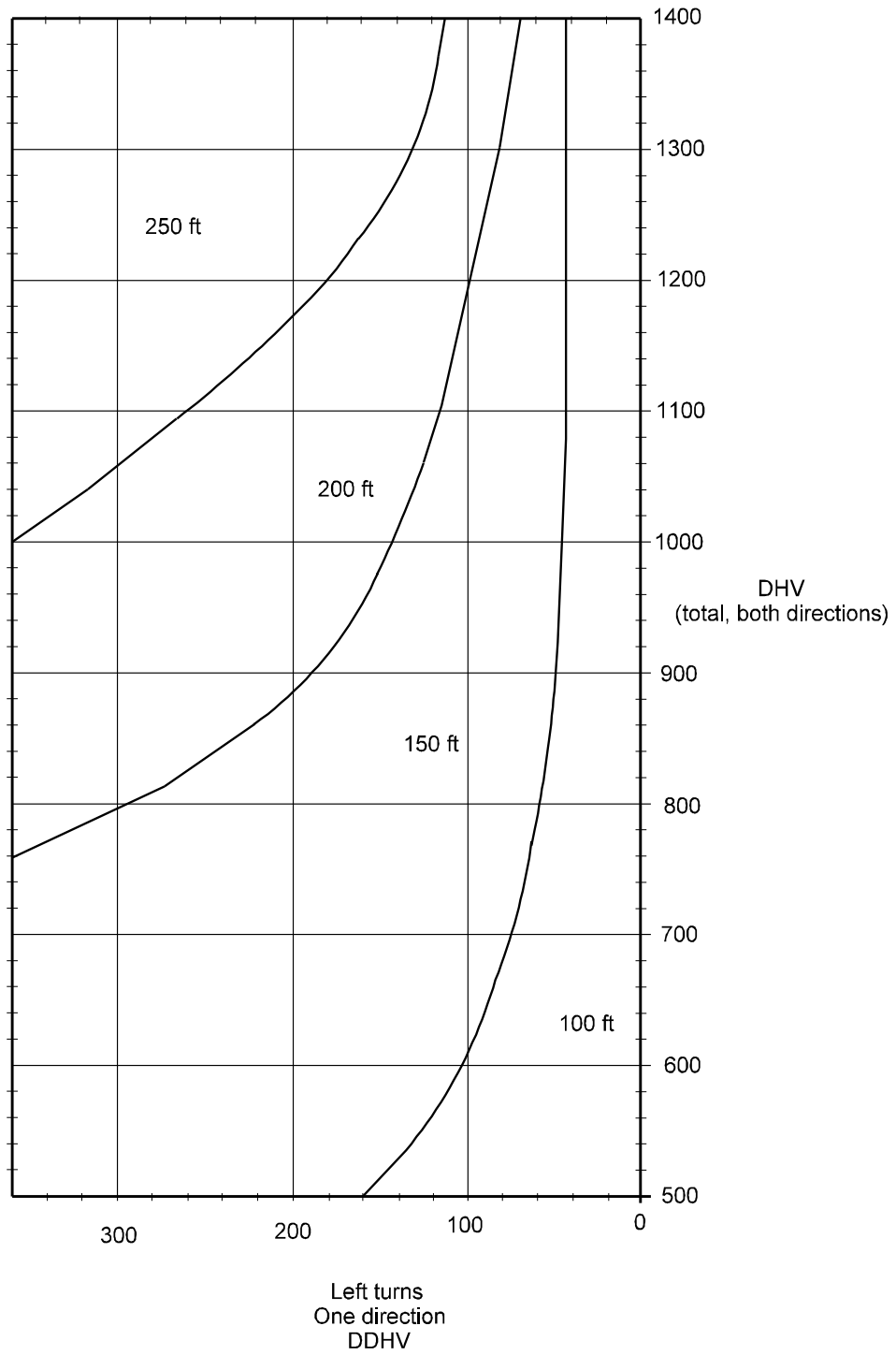

**Left-Turn Storage Length**  
*Figure 910-9c*

Storage length to be added to charts of  
left-turn storage lengths (feet).

Storage Length Required from Chart	Percent Trucks in Left-Turn Movement				
	10	20	30	40	50
100 ft	25	25	50	50	50
150 ft	25	50	50	75	75
200 ft	25	50	75	100	100

**Additional Left-Turn Storage for Trucks  
Unsignalized Intersection Two-Lane Highway**  
*Figure 910-9d*

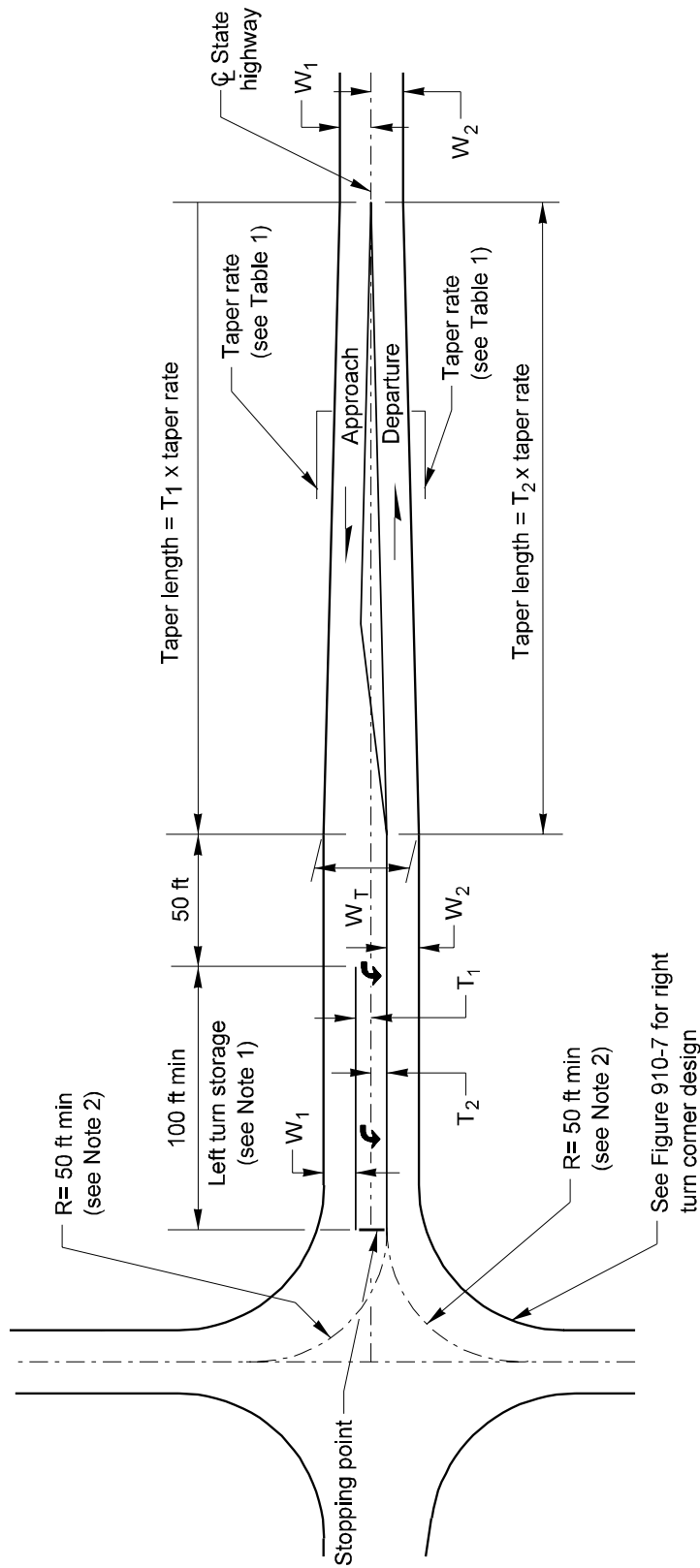

**Channelization Widening**  
**Figure 910-10a**

Table 1

Posted Speed	Taper Rate
55 mph	55:1
50 mph	50:1
45 mph	45:1
40 mph	40:1
35 mph	35:1
30 mph	30:1
25 mph	25:1

Notes:

1. The minimum width of the left turn storage lane ( $T_1 + T_2$ ) is 11 ft. The desirable width is 12 ft. See Figures 910-9a-9d for left turn storage length.
2. Use templates for WB-20 design vehicles.
3. See Standard Plans and MUTCD for striping details.

- $W_1$  = Approaching through lane
- $W_2$  = Departing lane
- $T_1$  = Width of left turn lane on approach side of  $\phi$
- $T_2$  = Width of left turn lane on departure side of  $\phi$
- $W_T$  = Total width of channelization ( $W_1 + W_2 + T_1 + T_2$ )

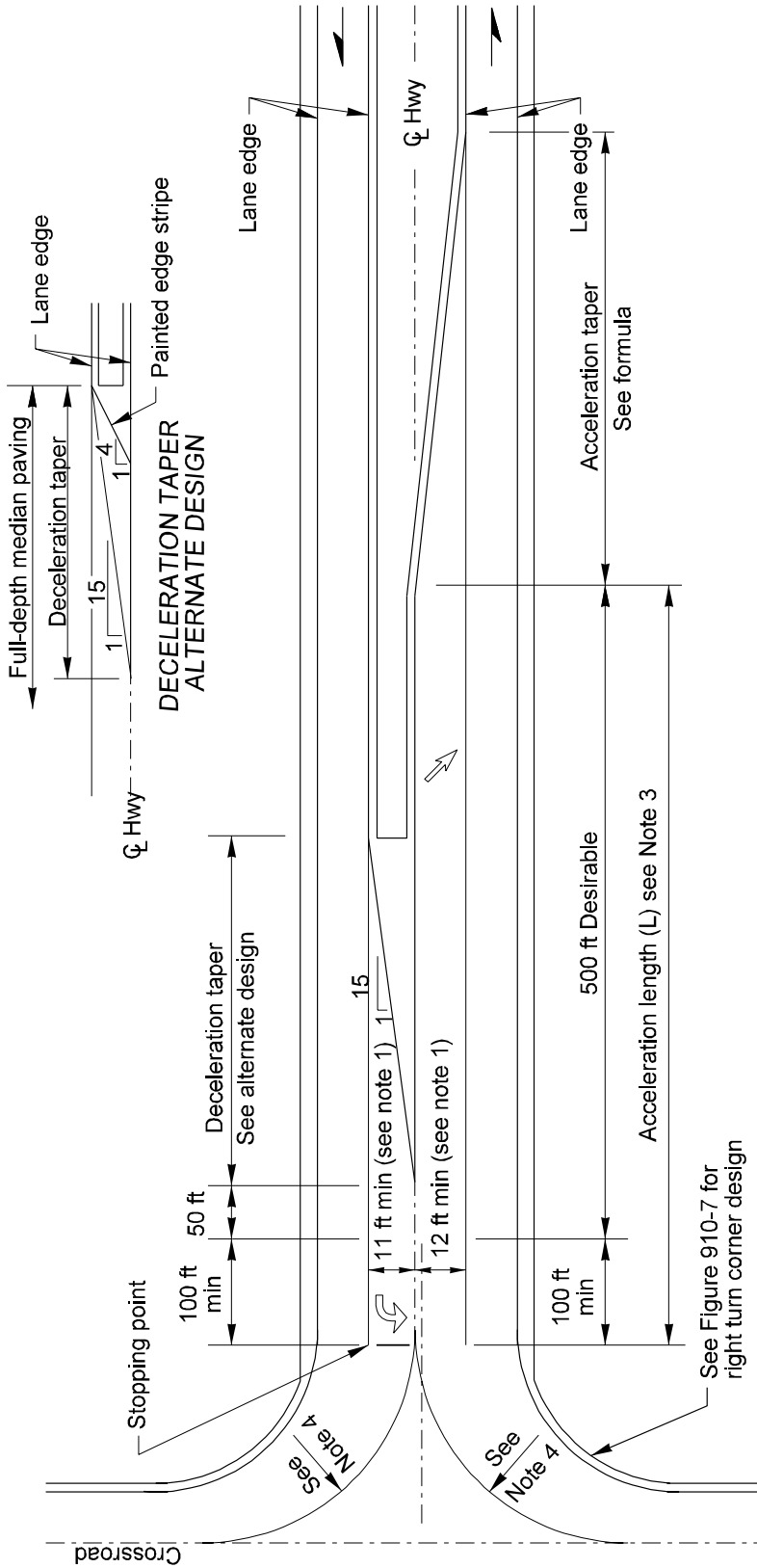

**Median Channelization — Median Width 23 ft to 26 ft**

*Figure 910-10b*

**NOTES:**

1. Lane widths of 13 ft are desirable for both the left turn storage lane and the median acceleration lane.
2. For increased storage capacity, the left turn deceleration taper alternate design should be considered.
3. The total length of the median acceleration lane shall not be less than the minimum acceleration lane length shown in Figure 910-13.
4. R = 50 ft min; use templates for WB-67 design vehicles.

**ACCELERATION TAPER FORMULA**

When posted speed is 45 mph or higher:  
 Taper length =  $\frac{\text{lane width} \times \text{posted speed (mph)}}{60}$   
 When posted speed is less than 45 mph:  
 Taper length =  $\frac{\text{Lane width} \times (\text{posted speed})^2}{60}$

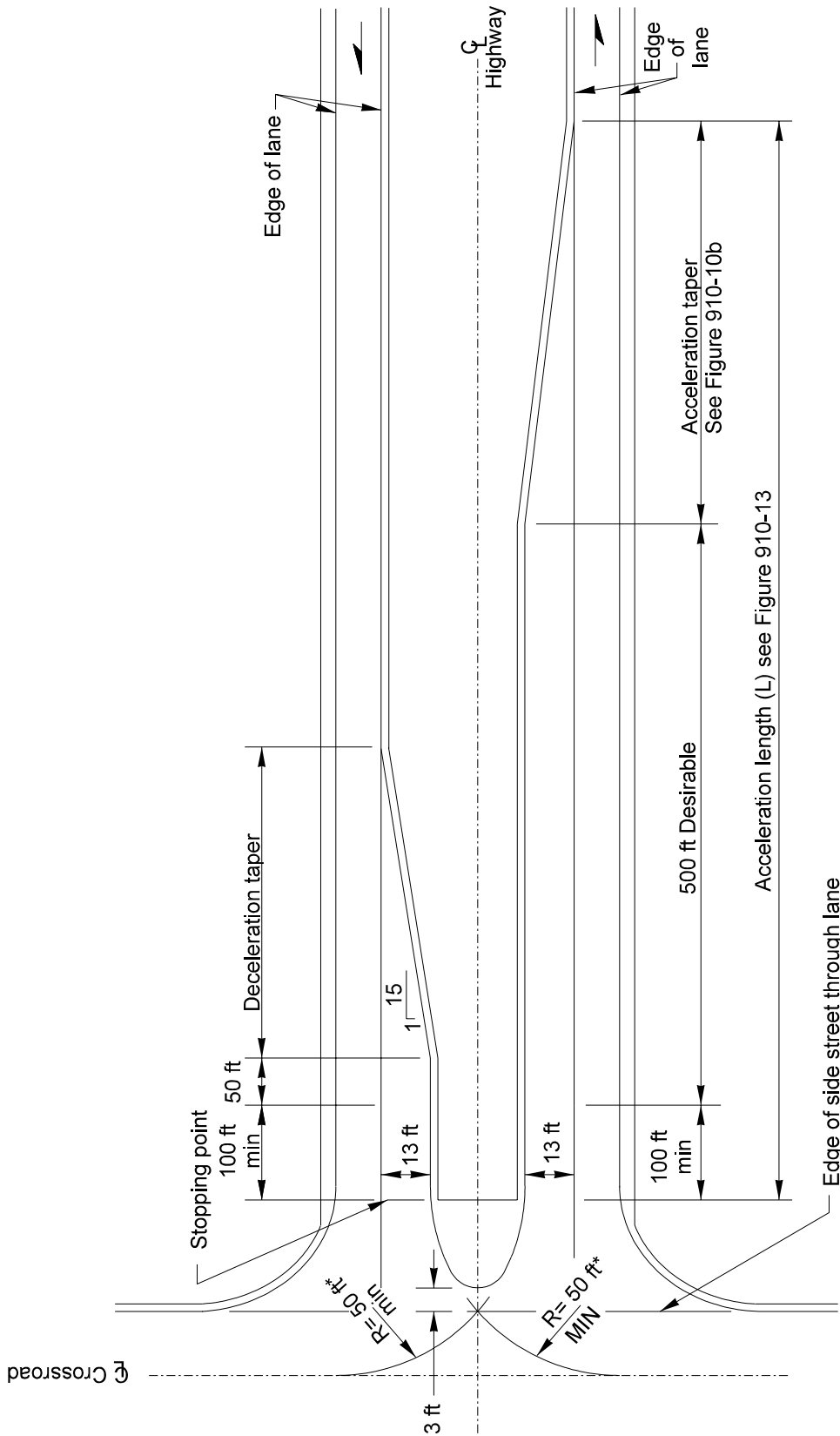

**Median Channelization — Median Width of More Than 26 ft**  
*Figure 910-10c*

\* Use templates for WB-67 design vehicles.



**NOTES**

- 1. Use templates for WB-67 design vehicle.
- 2. See Figure 910-7 for right-turn corner design.
- 3. For median width 17 ft or more. For median width less than 17 ft widen to 17 ft or use figure 910-10b without median acceleration lane.

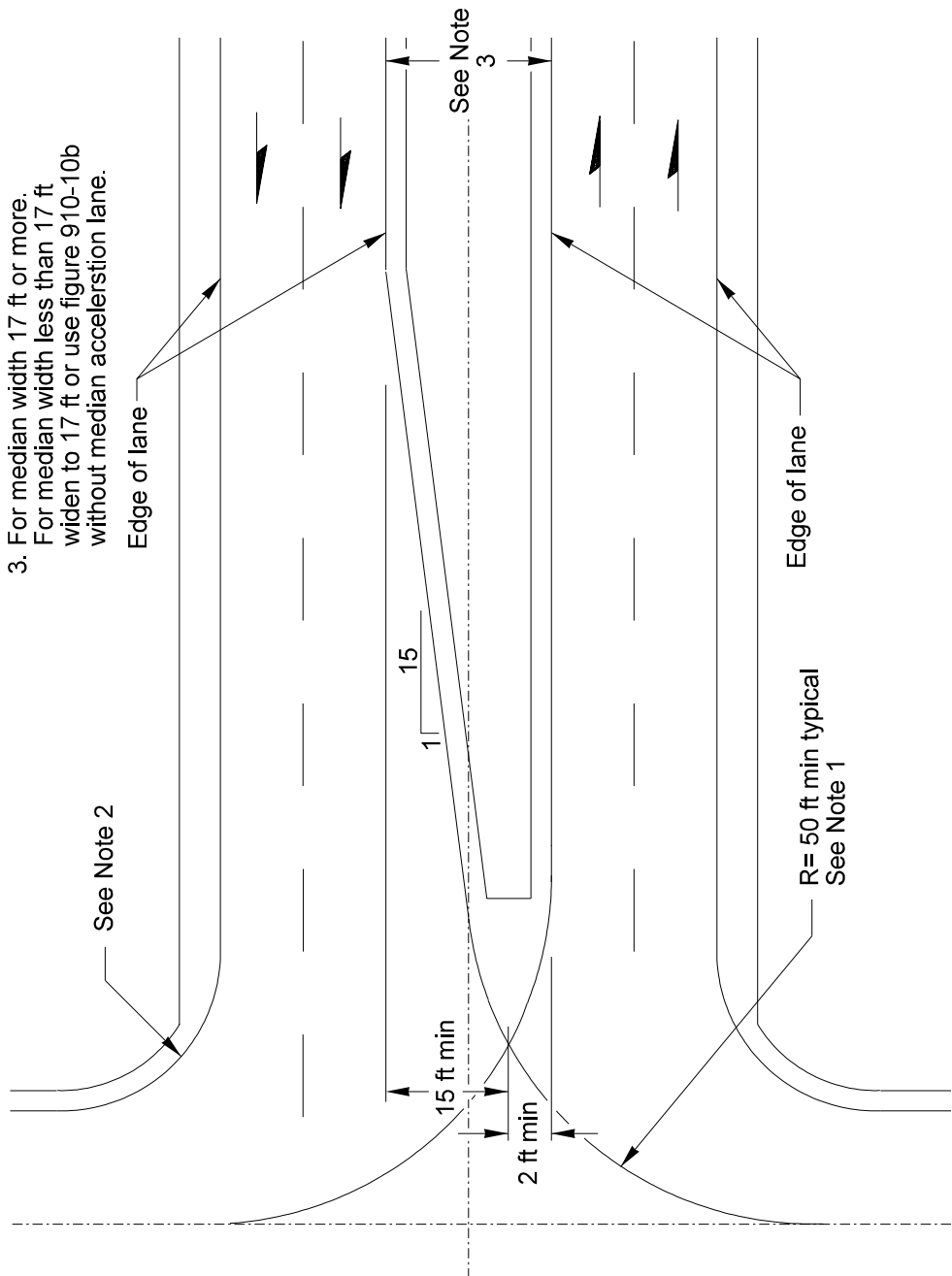

**Minor Intersection on Divided Highway**  
*Figure 910-10d*

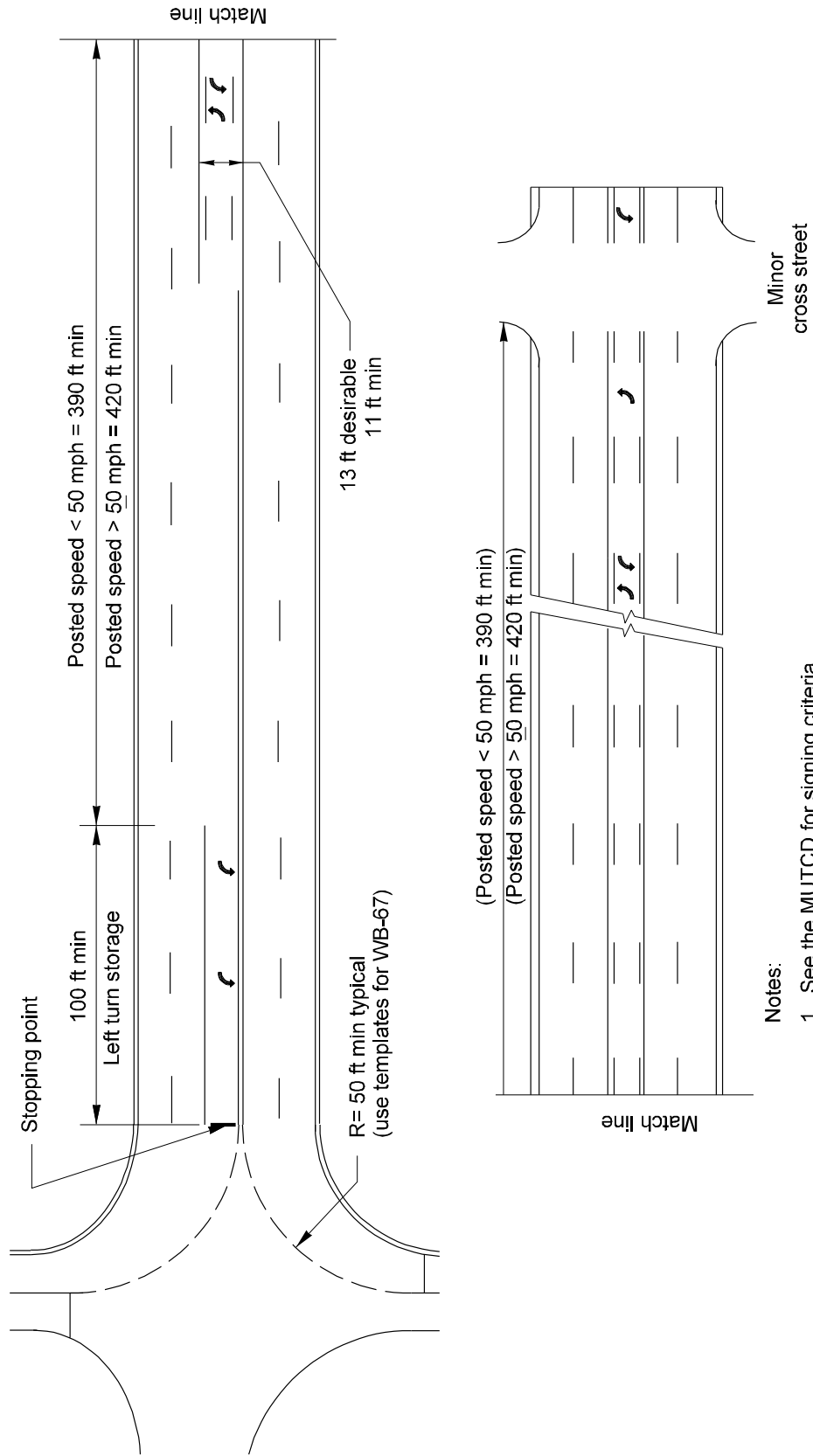

**Two-Way Left-Turn Lane**  
*Figure 910-10e*

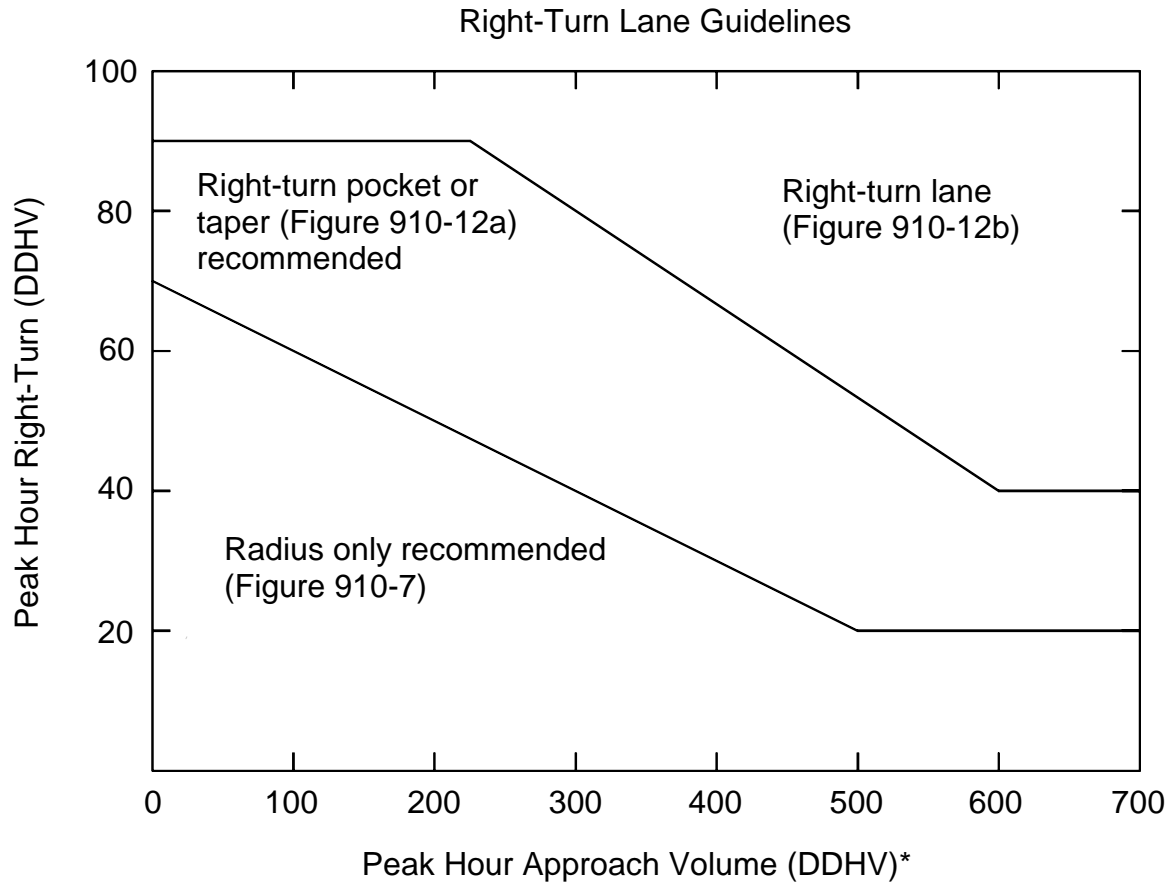

\* For two-lane highways, use the peak hour approach volume (through + right-turn).

For multilane, high speed highways (posted speed 45 mph or above), use the right-lane peak hour approach volume (through + right-turn).

For multilane, low speed highways (posted speed less than 45 mph), no right-turn lane or taper is required.

Note: When all three of the following conditions are met, reduce the right-turn DDHV by 20.

1. The posted speed is 45 mph or less
2. The right-turn volume is greater than 40 VPH.
3. The total approach volume is less than 300 VPH.

### Right-Turn Lane Guidelines

*Figure 910-11*

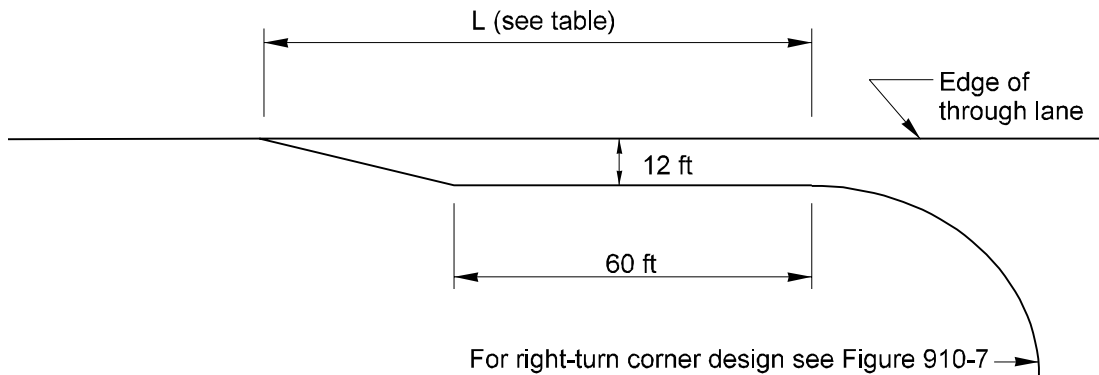

**RIGHT-TURN POCKET**

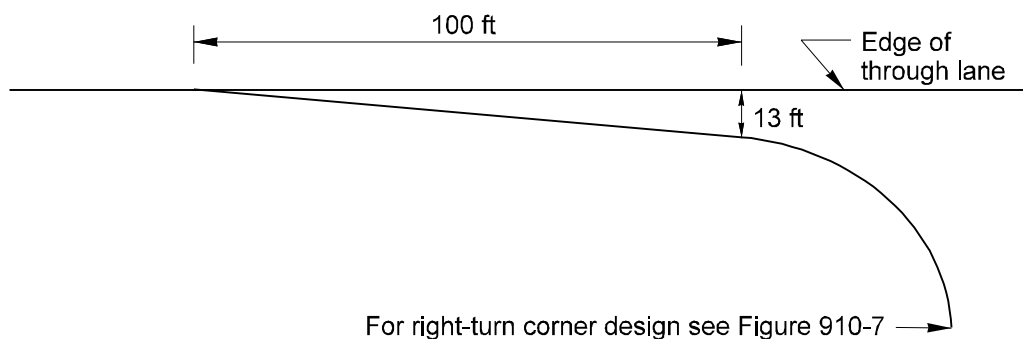

**RIGHT-TURN TAPER**

Posted Speed limit	L
Below 40 mph	100 ft
40 mph or above	165 ft

**Right-Turn Pocket and Right-Turn Taper**  
*Figure 910-12a*

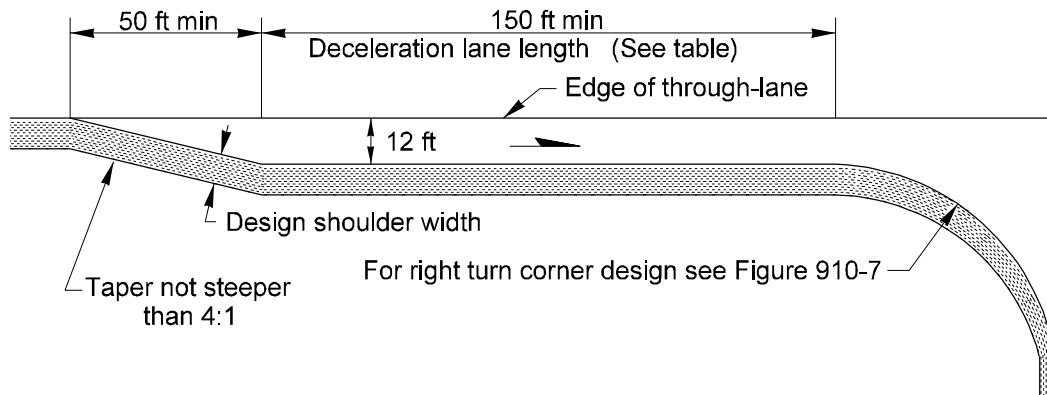

Minimum Deceleration Lane Length (ft)			
Highway Design Speed (mph)	Turning Traffic Design Speed (mph)		
	Stop*	15	20
30	235	185	160
40	335	305	275
50	425	390	365
60	530	490	470
70	605	580	565

Adjustment Multiplier for Grades Greater Than 3%		
Percent Grade	Upgrade	Downgrade
3% to less than 5%	0.9	1.2
5% or more	0.8	1.35

\*For use when the turning traffic is likely to stop before completing the turn. (for example - where pedestrians are present.)

**Right-Turn Lane**  
*Figure 910-12b*

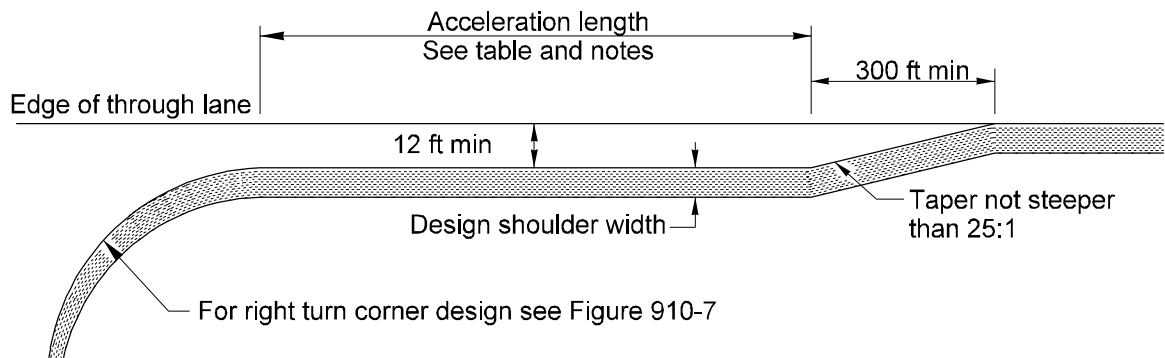

Minimum Acceleration Lane Length (feet)			
Highway Design Speed (mph)	Turning Roadway Design Speed (mph)		
	Stop	15	20
30	180		
40	395	320	270
50	640	560	510
60	1115	1015	955
70	1495	1415	1350

Adjustment Multiplier for Grades Greater Than 3%			
Highway Design Speed	Percent Grade	Upgrade	Downgrade
40	3% to less than 5%	1.3	0.7
50		1.3	0.65
60		1.4	0.6
70		1.5	0.6
40	5% or more	1.5	0.6
50		1.5	0.55
60		1.7	0.5
70		2.0	0.5

**NOTES:**

1. The minimum acceleration lane length for freeway or expressway is 900 ft.

**Acceleration Lane**  
Figure 910-13

**NOTES:**

1. Widened shoulders, indicated by hachures, are used when adequate right turn radii cannot be provided for long wheelbase trucks.
2. Use the truck turning path templates to determine the width of the widened shoulder.
3. Design widened shoulder pavements the same depths as the right turn lane.
4. See Chapter 640 for turning roadway widths.

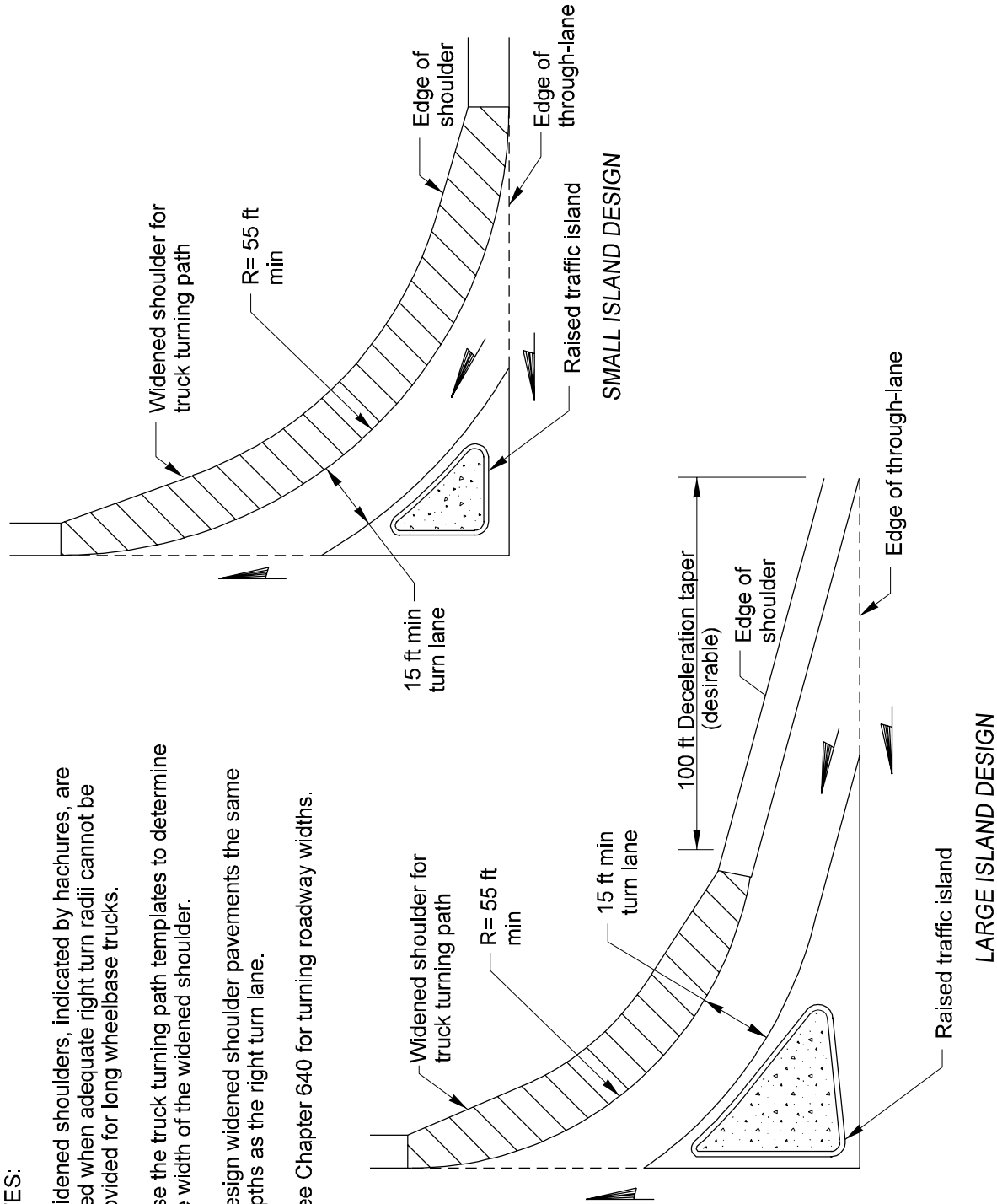

**Traffic Island Designs**  
*Figure 910-14a*

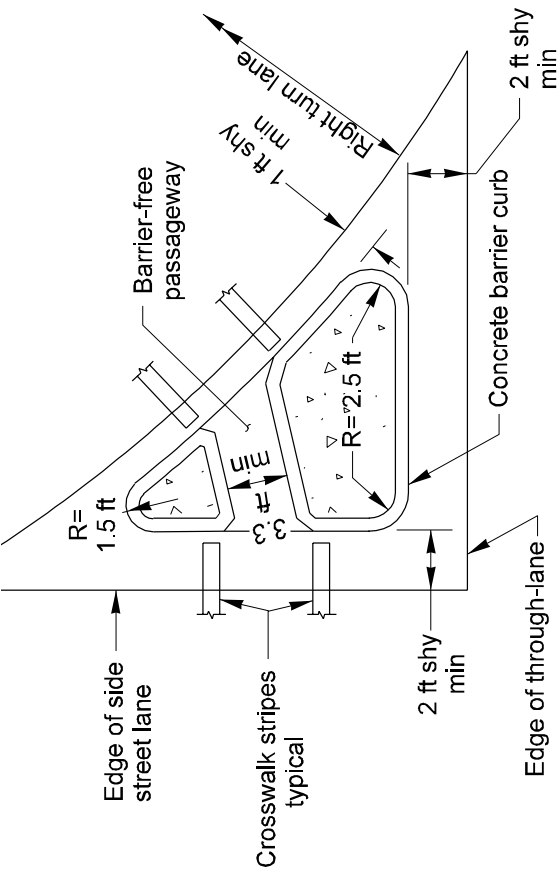

**Small Raised Traffic Island**

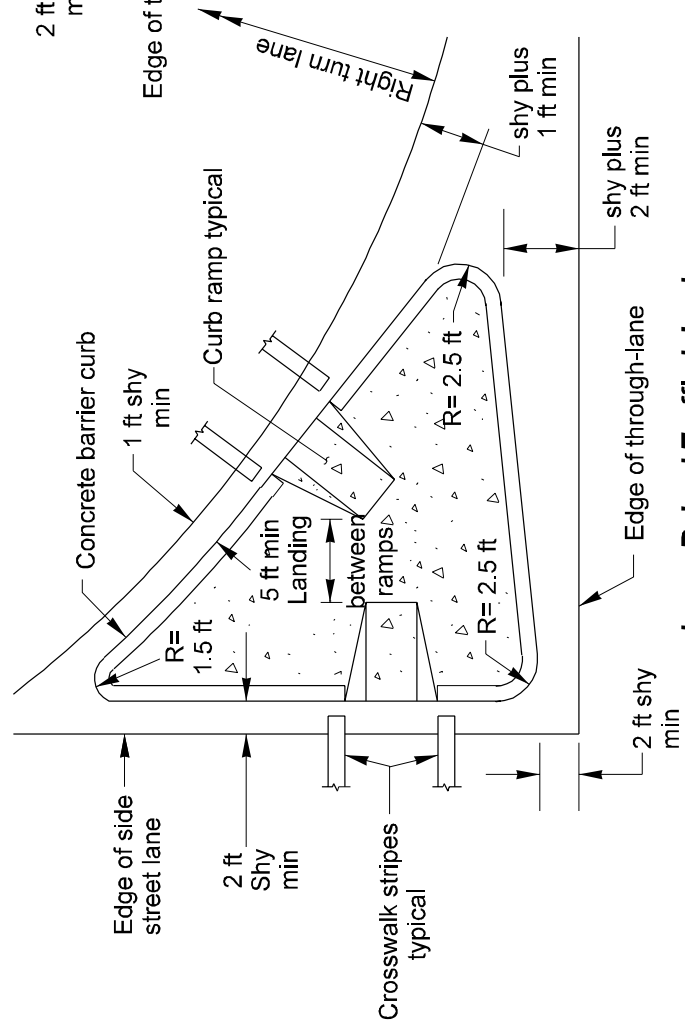

**Large Raised Traffic Island**

**NOTES:**

1. The 5 ft min landing between the curb ramps shall be clear of obstructions.
2. Curb ramp details are shown in the Standard Plans.
3. Crosswalk types and locations may vary.

**Traffic Island Designs**

*Figure 910-14b*



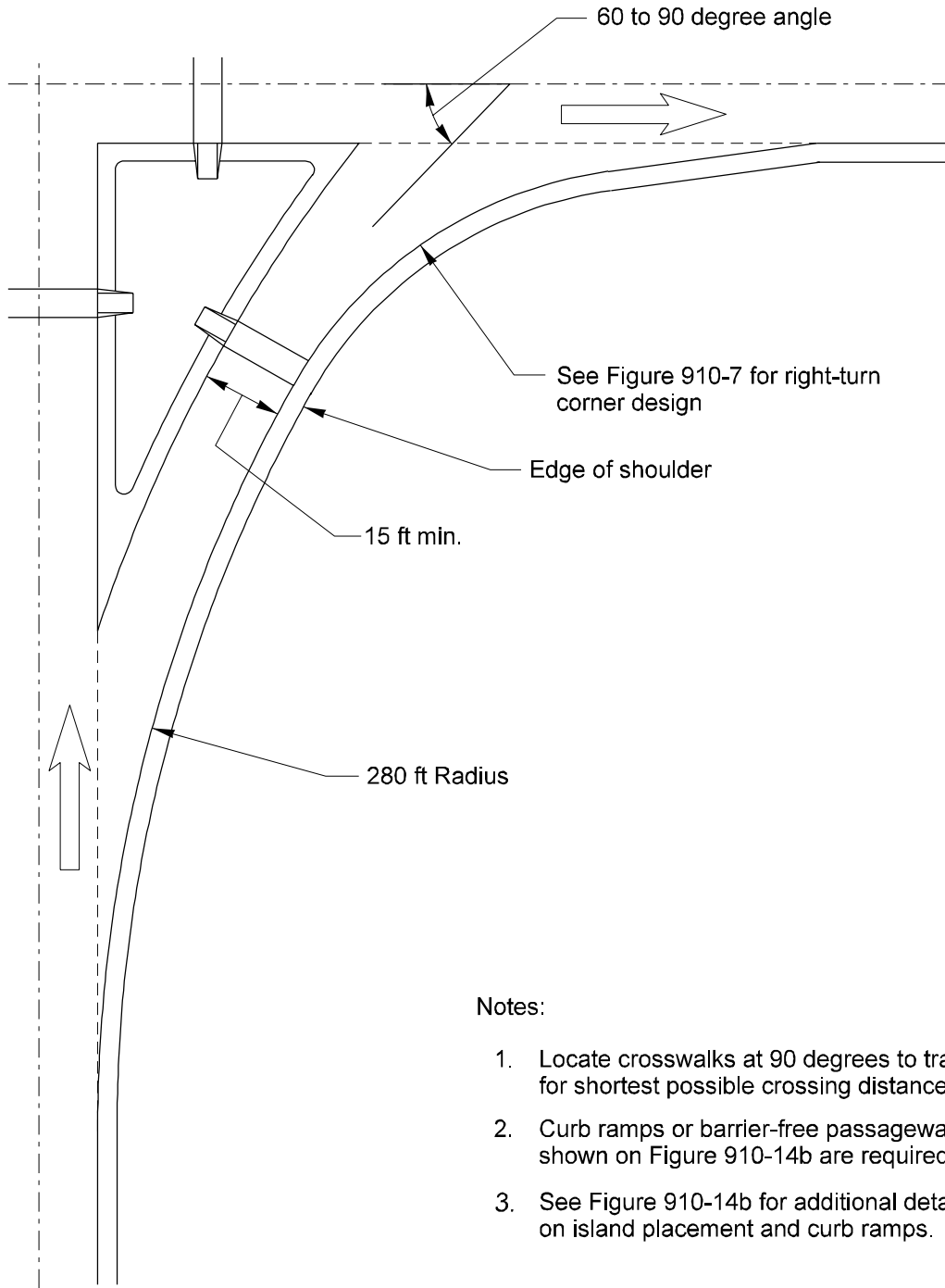

Notes:

1. Locate crosswalks at 90 degrees to traffic for shortest possible crossing distance.
2. Curb ramps or barrier-free passageways as shown on Figure 910-14b are required
3. See Figure 910-14b for additional details on island placement and curb ramps.

COMPOUND CURVE TRAFFIC ISLAND

**Traffic Island Designs**  
*Figure 910-14c*

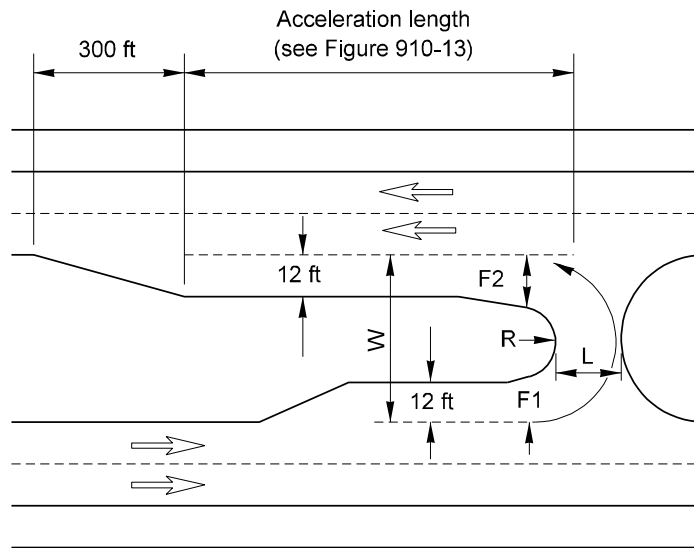
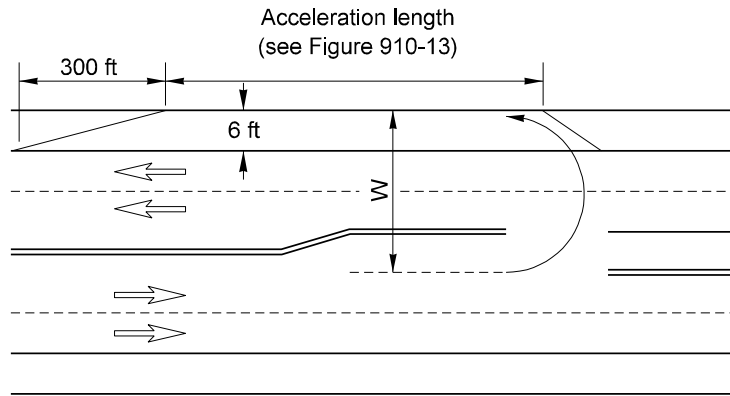

Vehicle	W	R	L	F1	F2	Taper
P	52.0	14.0	14.0	12.0	12.0	—
SU	87.0	29.5	19.5	13.0	15.0	10:1
BUS	87.0	27.8	23.0	13.4	18.0	10:1
WB-40	84.0	24.6	26.5	14.5	20.3	6:1
WB-50	94.0	26.3	31.0	16.1	25.3	6:1
WB-67	94.0	22.4	48.5	14.8	34.4	6:1
MH	84.0	26.5	19.5	14.8	16.2	10:1
P/T	52.0	11.0	12.5	12.0	18.0	6:1
MH/B	103.0	36.0	21.5	14.7	16.3	10:1

**U-Turn Locations**  
*Figure 910-15*

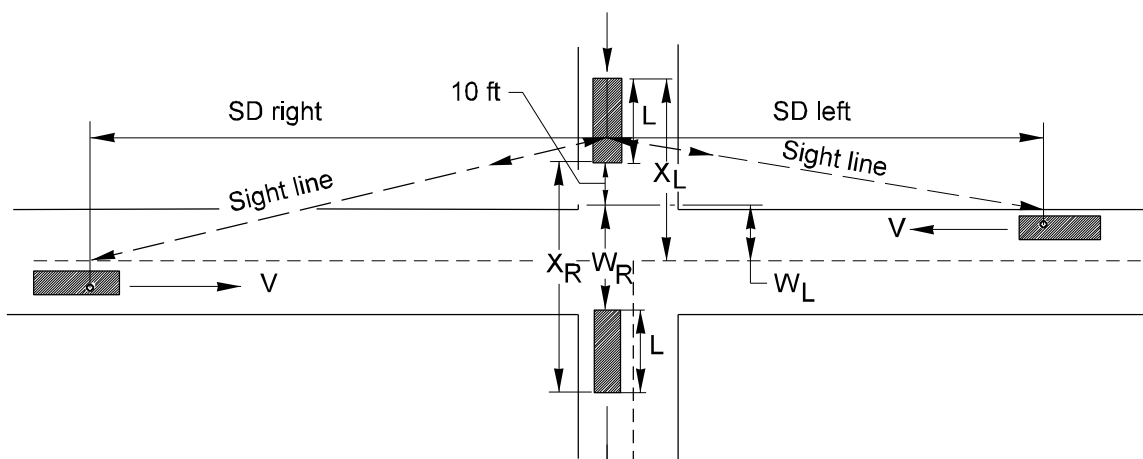

SD = Sight Distance  
 ta = Time for acceleration  
 V = Design speed on the through highway  
 L = Length of vehicle  
 X = Length of vehicle travel

Note: If the crossroad is not level, multiply by the adjustment factor to consider the grade.

L Values	
P	= 19 ft
SU	= 30 ft
WB-50	= 55 ft
WB-67	= 69 ft

Sight Distance Adjustment Factor					
Design Vehicle	Crossroad Grade, Percent				
	-4	-2	0	+2	+4
P	0.7	0.9	1.0	1.1	1.3
SU	0.8	0.9	1.0	1.1	1.3
WB-40	0.8	0.9	1.0	1.2	1.7

#### EXAMPLE

Given:

Two - 12 ft lanes to be crossed by a WB-50  
 Intersection angle approximately 90°.  
 Through highway design speed = 70 mph

Find:

The minimum required sight distance.

Solution:

$$X_{\text{right}} = 10 \text{ ft} + W_R + L = 10 \text{ ft} + 24 \text{ ft} + 55 \text{ ft} = 89 \text{ ft}$$

$$X_{\text{left}} = 10 \text{ ft} + W_L + L = 10 \text{ ft} + 12 \text{ ft} + 55 \text{ ft} = 77 \text{ ft}$$

From the charts as shown, the required minimum SD = 1,260 ft right and 1,180 ft left.

### Sight Distance for Grade Intersection With Stop Control

Figure 910-16a

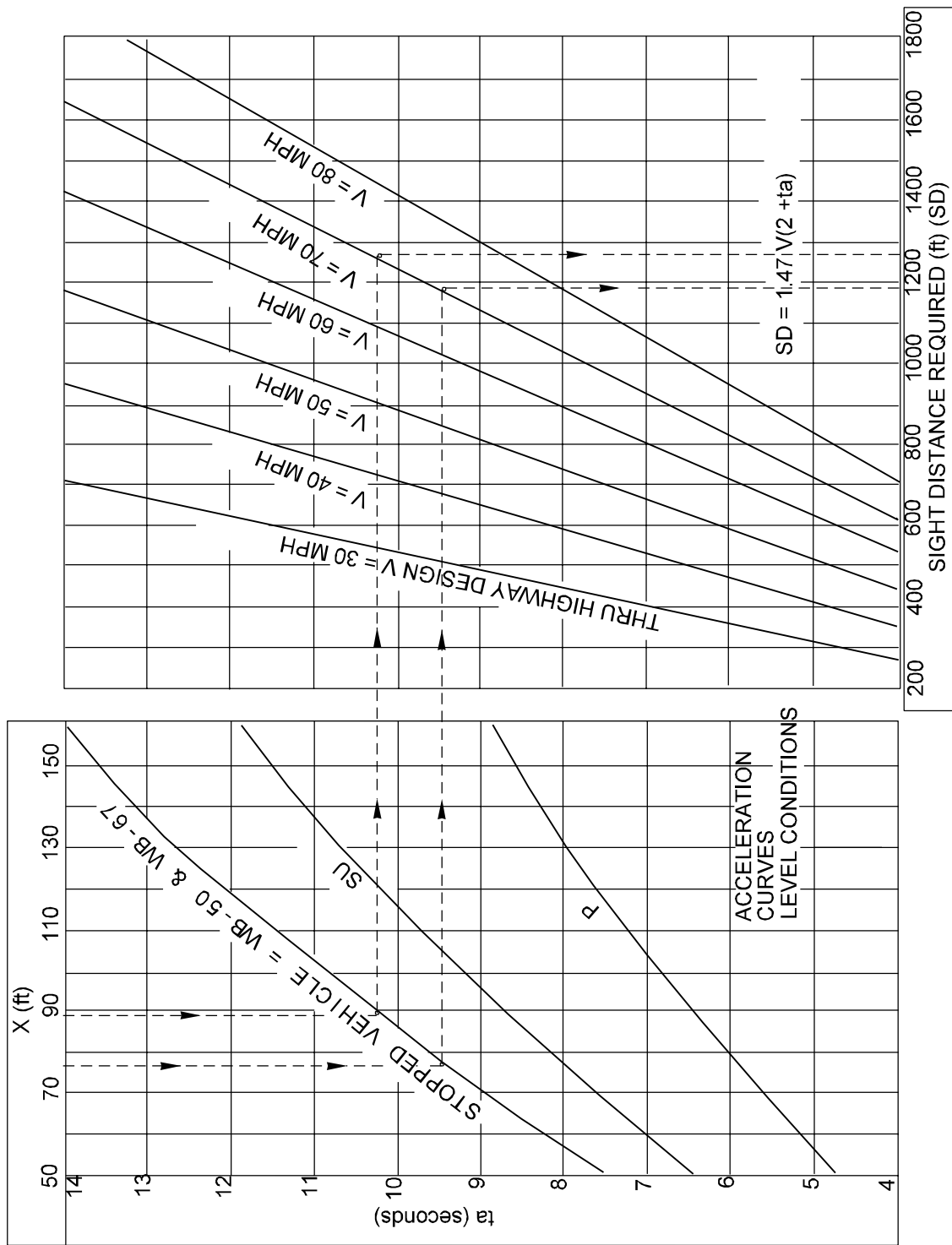

**Sight Distance for Grade Intersection With Stop Control**

*Figure 910-16b*

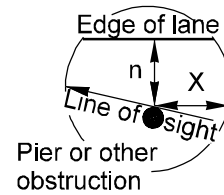
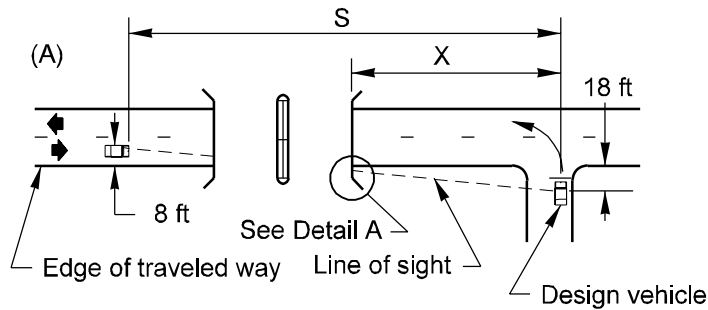

DETAIL A

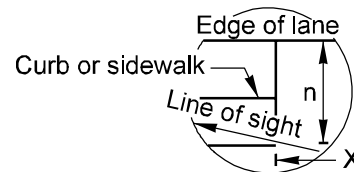
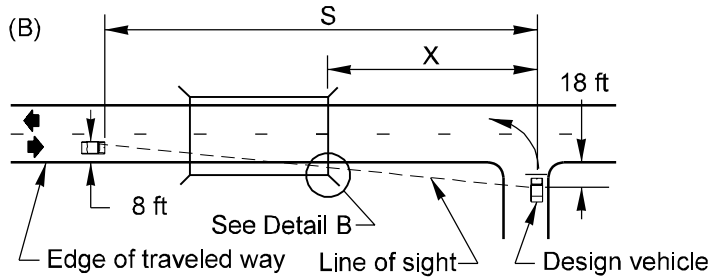

DETAIL B

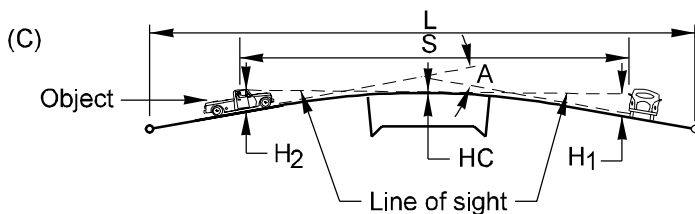

For bridge pier or bridge rail:

$$S = \frac{26(X)}{18 - n}$$

Where:

- S = Available sight distance (ft)
- n = Offset from sight obstruction to edge of lane (ft)
- X = Distance from center line of lane to sight obstruction (ft)

For crest vertical curve over a curb where  $S < L$ :

$$S = \sqrt{\frac{100L \left[ \sqrt{2(H_1 - HC)} + \sqrt{2(H_2 - HC)} \right]^2}{A}}$$

$$L = \frac{AS^2}{100 \left[ \sqrt{2(H_1 - HC)} + \sqrt{2(H_2 - HC)} \right]^2}$$

Where:

- S = Available sight distance (ft)
- $H_1$  = Eye height (3.5 ft)
- $H_2$  = Object height (4.25 ft)
- HC = Curb height (ft)
- L = Vertical curve length (ft)
- A = Algebraic difference in grades (%)

### Sight Distance at Intersections

Figure 910-16c

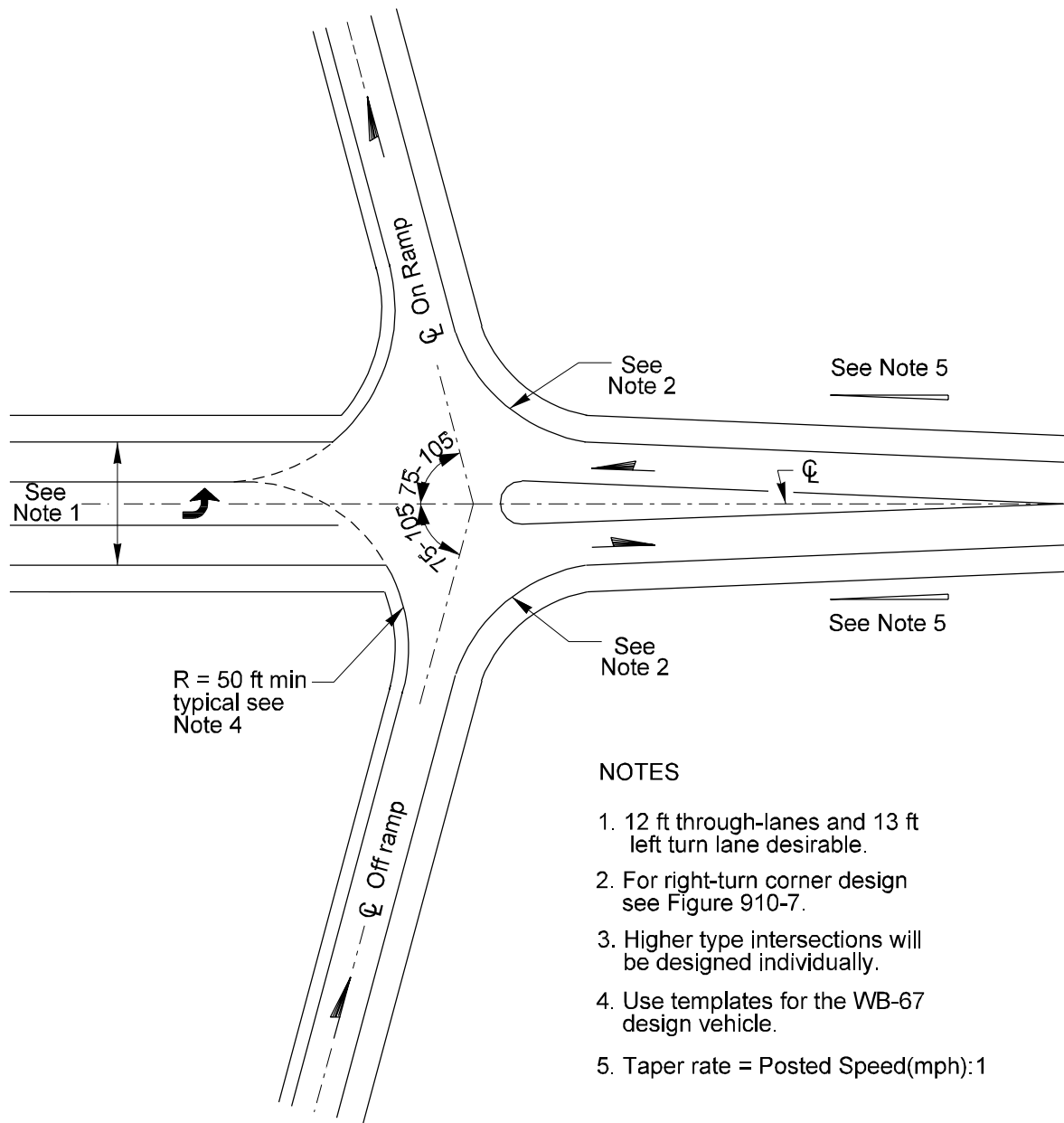

**Interchange Ramp Details**  
*Figure 910-17*

920.01	General
920.02	References
920.03	Definitions
920.04	Design Considerations
920.05	Road Approach Category
920.06	Road Approach Design Template
920.07	Sight Distance
920.08	Road Approach Spacing
920.09	Drainage Requirements
920.10	Procedures
920.11	Documentation

### 920.01 General

Every owner of property that abuts the state highway system where limited access rights have not been acquired has a right to reasonable access to the state highway system. The right of access to the state highway system may be restricted if reasonable access can be provided by way of another public road that abuts the property. General restrictions concerning road approaches are in RCWs, WACs, and amendments thereto. For considerations, requirements, and restrictions concerning road approaches on state highways where limited access rights have been acquired, see Chapters 1410 and 1420.

This chapter applies to road approaches on state highways in unincorporated areas. Road approaches on state highways within incorporated areas where limited access rights have not been acquired are the jurisdiction of the local agency, but conformance to these standards is encouraged.

### 920.02 References

*Revised Code of Washington (RCW) 47.32.150, "Approach roads, other appurtenances — Permit"*

*Revised Code of Washington (RCW) 47.32.160, "Approach roads, other appurtenances — Rules — Construction, maintenance of approach roads"*

*Revised Code of Washington (RCW) 47.32.170, "Approach roads, other appurtenances — Removal of installations from right of way for default"*

*Revised Code of Washington (RCW) 47.50, "Highway Access Management"*

*Washington Administrative Code (WAC) 468-51, "Highway Access Management Access Permits — Administrative Process"*

*Washington Administrative Code (WAC) 468-52, "Highway Access Management — Access Control Classification System And Standards"*

*Washington Administrative Code (WAC) 468-58, "Limited Access Highways"*

*Right of Way Manual, M 26-01, WSDOT*

*Standard Plans for Road, Bridge, and Municipal Construction (Standard Plans), M 21-01, WSDOT*

### 920.03 Definitions

**authorized road approach** A road approach or the replacement for a road approach that has been permitted or was open to use prior to July 1, 1990.

**average weekday vehicle trip ends (AWDVTE)** The estimated total of all trips entering plus all trips leaving a road approach on a weekday for the final stage of development of the property served by the road approach

**conforming road approach** A road approach that meets all current requirements for location, quantity, spacing, sight distance, and geometric elements

**corner clearance** The distance from an intersection at grade to the nearest road approach. The distance is measured from the closest edge of the traveled way of the crossroad to the closest edge of the traveled way of the road approach measured along the edge of the traveled way of the highway

**intersection at grade** The general area where a state highway or ramp terminal is met or crossed at a common grade or elevation by another state highway, a county road, or a city street

**joint use approach** A single approach that serves more than one property

**nonconforming road approach** A road approach that does not meet current requirements for location, quantity, spacing, sight distance, or geometric elements

**permit** The written approval issued by WSDOT authorizing construction, reconstruction, maintenance, or change of category of a road approach

**road approach** A connection providing private access to or from the state highway system

**road approach connection category** A category of road approach based on the estimated traffic generated

**road approach design template** The design geometric standards for a road approach based on the approach usage, types of vehicles that use the approach, and the traffic volume

**road approach type** The designation of road approaches on limited access facilities based on use of the property served

**temporary road approach** A road approach for a specific property use, conditioned to be open for a specific purpose and traffic volume for a specific period of time with the right of way to be restored to its original condition upon road approach closure

## 920.4 Design Considerations

When a highway project impacts existing road approaches, replace all conforming authorized road approaches. Evaluate existing nonconforming authorized road approaches for ways to bring them into conformance. Solutions may include relocation, combining with the road approach of the adjacent property as a joint use approach alteration, closure to the highway system, or addition of access to another public road.

When the evaluation determines that a nonconforming road approach cannot be made conforming and that closure of the road approach would leave the property without a reasonable means of access, issue a nonconforming access connection permit. Document the evaluation

that justifies the use of a nonconforming road approach and how it is nonconforming. List these nonconforming road approaches as Design Exceptions (DE).

New road approaches or upgrades to existing road approaches, requested by the property owner, may be included in the project at the expense of the property owner.

Design road approaches at transit facilities in accordance with Chapter 1060.

## 920.05 Road Approach Connection Category

**Category I — minimum connection** provides access for up to ten (10) dwelling units of single family residences, duplexes, or other small multifamily complexes; permanent agricultural or forest lands road approaches; the operation, maintenance, and repair of utilities; and road approaches serving other low volume traffic generators with an AWDVTE of 100 or less.

**Category II — minor connection** provides access to the state highway system for medium volume traffic generators with an AWDVTE of 1500 or less, that are not included in Category I.

**Category III — major connection** provides access to the state highway system for high volume traffic generators with an AWDVTE exceeding 1500.

**Category IV — temporary connection** provides access to the state highway system for a limited time.

## 920.06 Road Approach Design Template

The road approach design template is dependent upon the approach usage, types of vehicles that use the approach, and the traffic volume.

Figure 920-1 lists the road approach design templates, the approach usage, and the largest vehicle that Figures 920-3 through 5 provide for. When a larger design vehicle is required, use the turning path templates in Chapter 910, or from another source, to determine what adjustments to make.



Design Template	Property Usage	Design Vehicle
A	Residential	P
B	Farm	SU & BUS
C	Utility and special use	SU & BUS
D	Single Commercial	WB-50

### Road Approach Design Templates

Figure 920-1

The approach type on limited access facilities uses the design template with the same designation. For example a Type B approach will be designed using Design Template B.

#### (1) Noncommercial Approaches

Design noncommercial road approaches for rural highways in accordance with Figures 920-3 and 4. Template C is the same basic design as Template B with an added option for a locked gate. If there is a predominance of semitrailer traffic for Templates B and C, the design can be modified to accommodate larger vehicles. Design road approaches to fit the conditions within the limits shown in Figures 920-3 and 4

Noncommercial road approaches are normally Category I connections. When they are Category II or III, the use of one of the commercial road approach design templates is desirable.

#### (2) Commercial Approaches

Determine the predominant type of vehicle using the approach and design the commercial approach in accordance with Figure 920-5. If the width of the frontage precludes such an approach, use the turning path templates in Chapter 910, or from another source, to determine what adjustments may be made to provide safe and efficient access and to avoid encroachment upon the frontage of abutting property.

Commercial approaches are normally Category II or III connections.

Commercial approaches are allowed only on access managed or modified limited access state highways. They must not cause undue interference or hazard to the free movement of highway

traffic and, when not joint use approaches, they must not infringe on the frontage of adjoining property. For further restrictions, see the RCWs referenced in 920.02 and Chapter 1420.

Where traffic volumes are heavy, such as for a shopping center or an industrial park, design the road approach as an intersection. (See Chapter 910.)

### 920.07 Sight Distance

The driver of a vehicle entering a roadway from a road approach needs obstruction-free sight triangles in order to see enough of the roadway to safely enter before an approaching vehicle can reach the road approach.

Locate the road approach where the sight distances shown on Figure 920-6 are available. Road approaches with sight distances less than indicated are considered nonconforming road approaches.

### 920.08 Road Approach Spacing and Corner Clearance

#### (1) Road Approach Spacing

The minimum distance, measured along the edge of the traveled way, from the closest edge of the traveled way of one road approach to the closest edge of the traveled way of an adjacent road approach, is determined by the Highway Access Management Class. The minimums to be used are shown in Figure 920-7.

Road approach spacing less than these minimums may be required to provide access to properties where highway frontage, topography, or location would otherwise preclude access. Where a joint use approach or access to another public road meeting or exceeding these minimums cannot be obtained or is determined not to be feasible, less than minimum spacing may be necessary. Closely spaced road approaches are nonconforming road approaches and require listing as Design Exceptions (DE).

#### (2) Corner Clearance

Corner clearances shall meet or exceed the minimums shown in Figure 920-7. If, due to property size, corner clearance requirements

cannot be met, and where a joint use approach or access to another public road meeting or exceeding the minimum corner clearance cannot be obtained or is determined not to be feasible, then the following minimum S values may be used:

Position	Access Allowed	S Min
<b>With Restrictive Medians</b>		
Approaching Intersection	Right In/ Right Out	115 ft
Approaching Intersection	Right In Only	75 ft
Departing Intersection	Right In/ Right Out	230 ft*
Departing Intersection	Right Out Only	100 ft
<b>Without Restrictive Medians</b>		
Approaching Intersection	Full Access	230 ft*
Approaching Intersection	Right In Only	100 ft
Departing Intersection	Full Access	230 ft*
Departing Intersection	Right Out Only	100 ft
*For Highway Access Management Class 5 or for speeds less than 35 mph, 125 ft may be used.		

**Minimum Corner Clearance**  
*Figure 920-2*

## 920.09 Drainage Requirements

In a roadway section with a drainage ditch, a culvert pipe is placed under the approach. The approach is graded as shown in Figure 920-5. Be careful that roadway runoff is not a problem in the case of a minus grade to the right of way line.

Design foreslopes not steeper than 6H:1V. Bevel the culvert ends in accordance with Chapter 700.

Locate culverts as far from the traveled way as possible. Minimum distances are shown in Figures 920-3 through 5.

A turnpike section (a standard roadway section with a shallow V-shaped paved gutter at the shoulder edge) may be used. Consider continuing the turnpike section throughout the area between the shoulder and the backslope. In the profile controls on Figure 920-5, if the grade from the edge of shoulder to the right of way line is a flat or minus grade and roadway runoff is a consideration, curb may be placed as shown.

Approaches and related areas must be constructed so they do not impair drainage within the right of way or alter the stability of the roadway subgrade.

## 920.10 Procedures

Verify the validity of all road approaches. Show on a plan or a list the location, template, validity, and justification for all road approaches. Where road approaches are to be included in a project, consider location and function as early as possible, preferably in the preliminary planning stage.

## 920.11 Documentation

The following documents are to be preserved in the project file. See Chapter 330.

- Plan or list of the road approaches
- Evaluation of nonconforming authorized road approaches

P65:DP/DM9

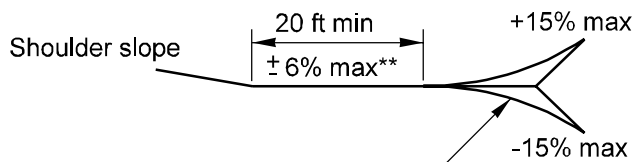
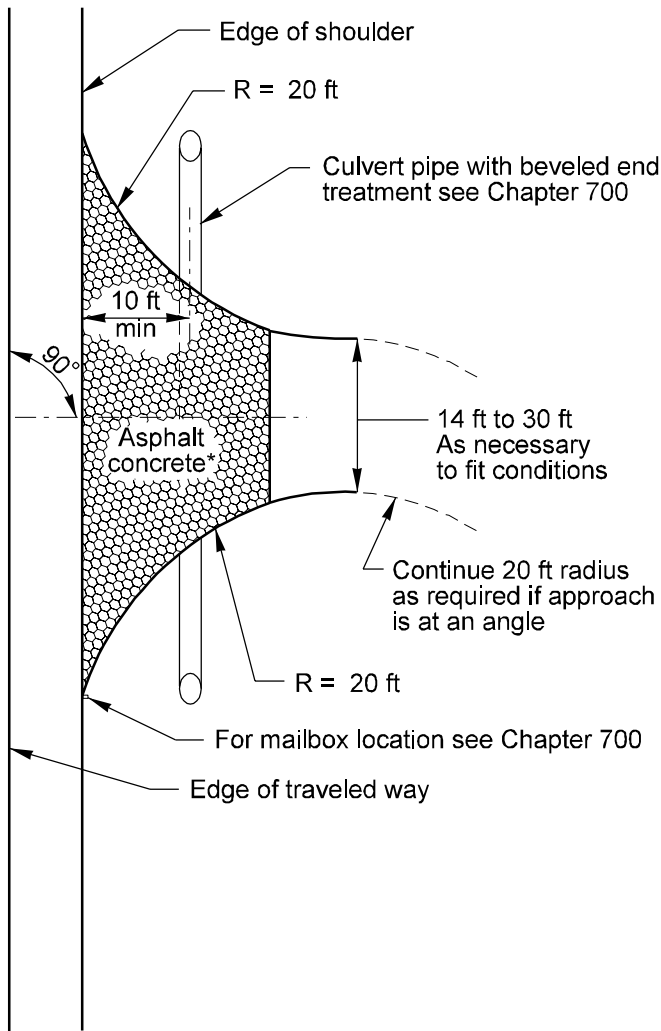

Vertical curves not to exceed a 3 1/4 inch hump or a 2 inch depression in a 10 ft chord.

\*When the travel lanes are bituminous, a similar type may be used on the approaches.

\*\* ± 8% max difference from shoulder slope.

### Noncommercial Approach Design Template A

Figure 920-3

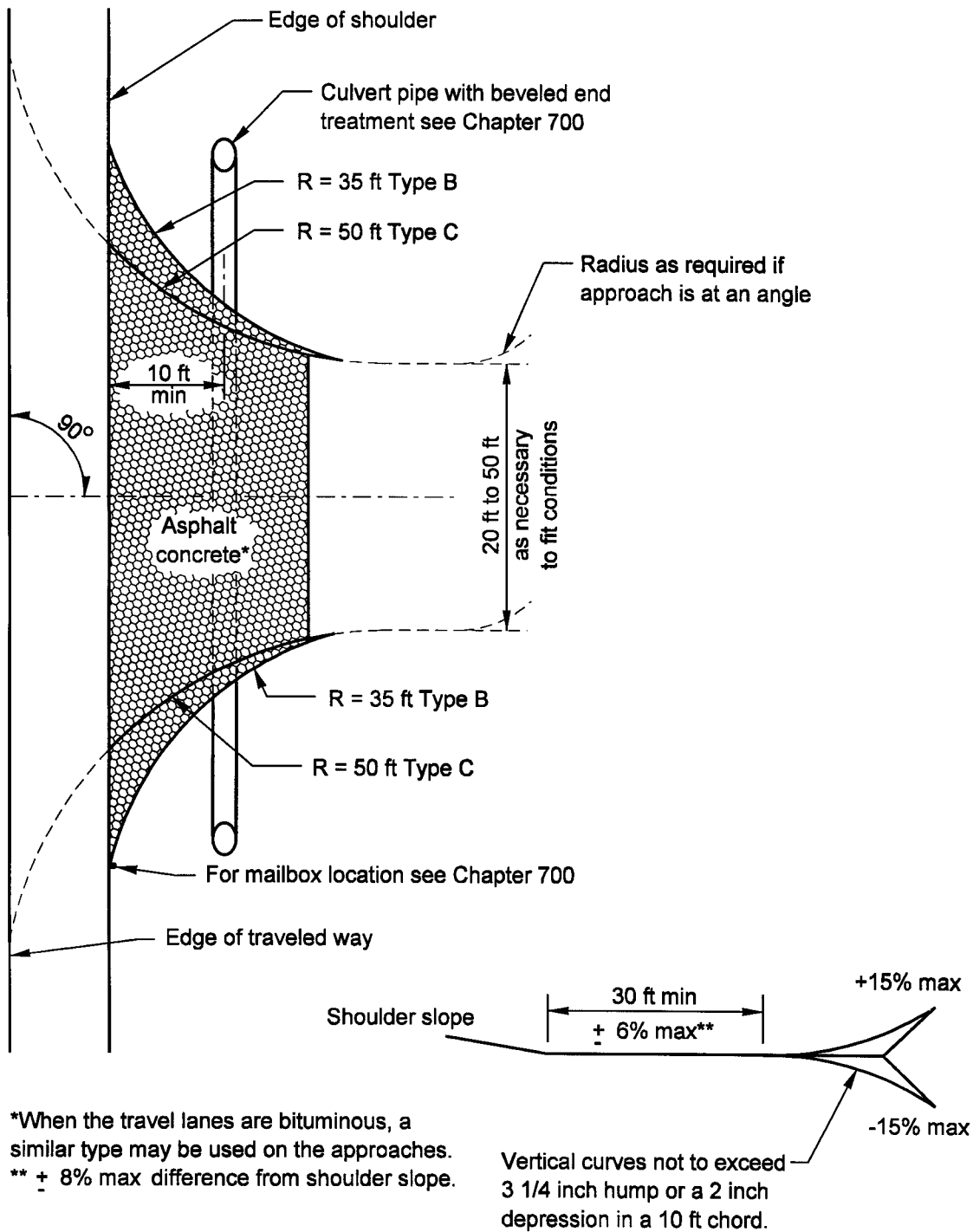

**Noncommercial Approach Design Template B and C**  
Figure 920-4

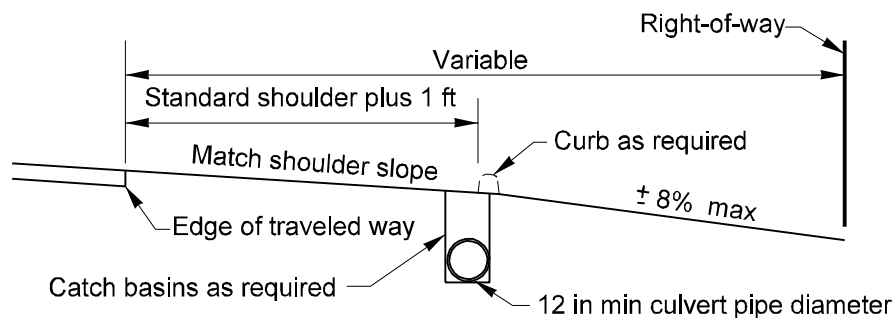

### Profile Controls

Condition	A	B	C	D	E	F	G	H	J
Primary SU and less	—	—	10	30	15	—	—	30	10
Primary combination vehicle WB 40	4	25	6	50	15	7	25	45	10
Primary combination vehicle WB 50 and doubles	4	25	6	55	20	—	—	50	10

All values in feet  
For larger vehicles, use turning templates

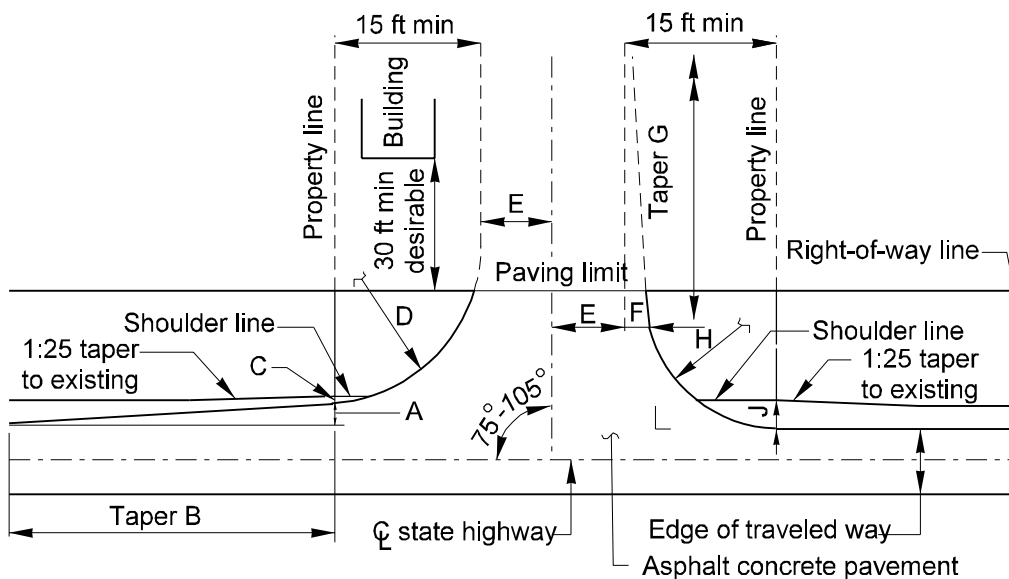

Note: Vertical curves between the shoulder slope and the approach grade not to exceed a 3 1/4 inch hump or a 2 inch depression in a 10 ft chord.

**Commercial Approach — Single Approach Design Template D**  
Figure 920-5

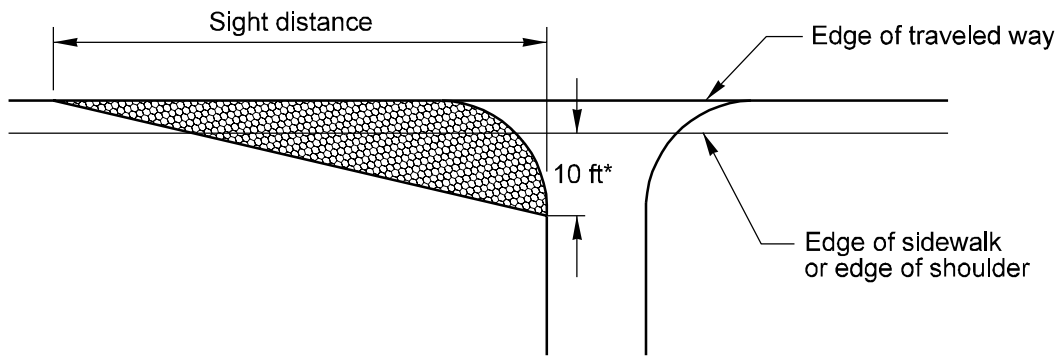

\*Not to exceed 18 ft from the edge of traveled way.

Posted Speed Limit (mph)	25	30	35	40	50	60	70
Category I Road Approach	150	180	230	280	380	510	630
Category II Road Approach	150	200	270	330	480	640	860

Road Approach Sight Distance (ft)

These distances require an approaching vehicle to reduce speed or stop to prevent a collision.

Design Category III road approach sight distance as an intersection (see Chapter 910).

For road approaches where left turns are not allowed, a sight triangle need only be provided to the left, as shown.

For road approaches where left turns are allowed, provide a sight triangle to the right in addition to the one to the left. The sight distance to the right is measured along the center line of the roadway.

For additional information on calculating the sight triangle, see Chapter 910.

### Road Approach Sight Distance

Figure 920-6

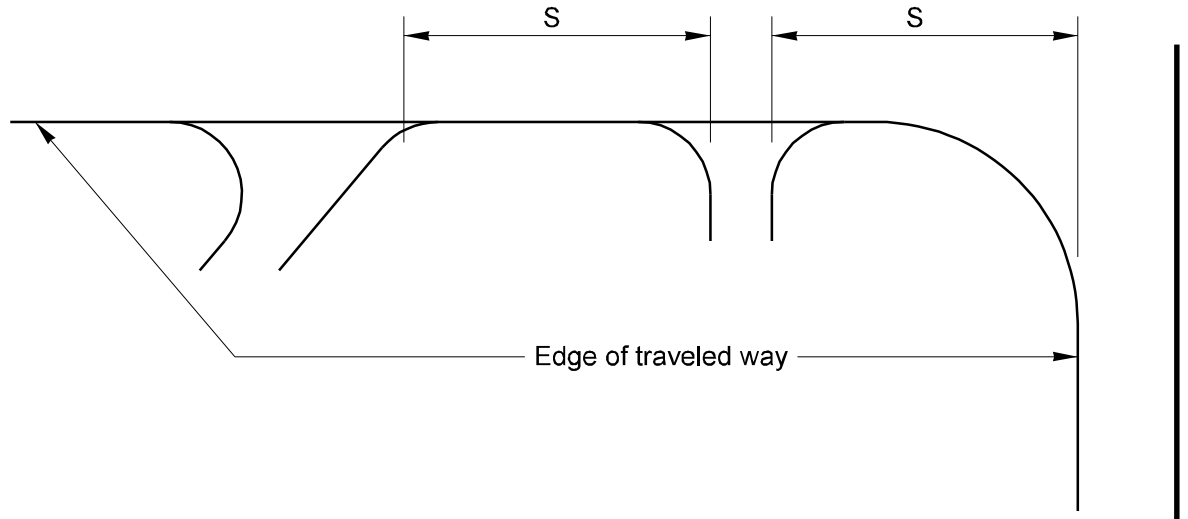

Highway Access Management Class	1	2	3	4	5
S	1320 ft	660 ft	330 ft	250 ft	125 ft

Road Approach Spacing and Corner Clearance

Note:

For Road Approach Spacing, S is the distance between closest edge of the traveled way of the two road approaches, measured along the edge of the traveled way of the highway.

For corner clearance, S is measured from the closest edge of the traveled way of the crossroad to the closest edge of the traveled way of the road approach, measured along the edge of the traveled way of the highway.

**Road Approach Spacing and Corner Clearance**

*Figure 920-7*

# 930

## Railroad Grade Crossings

- 930.01 General
- 930.02 References
- 930.03 Plans
- 930.04 Traffic Control Systems
- 930.05 Stopping Lanes
- 930.06 Types of Crossing Surfaces
- 930.07 Crossing Closure
- 930.08 Traffic Controls During Construction and Maintenance
- 930.09 Railroad Grade Crossing Orders
- 930.10 Longitudinal Easements from Railroad

### 930.01 GENERAL

An at-grade railroad crossing is, in effect, a traffic crossing and due consideration must be given to the design and traffic control of the intersection.

### 930.02 REFERENCES

*Manual on Uniform Traffic Control Devices (MUTCD), Part VIII - Traffic Control Systems for Railroad-Highway Grade Crossings.*

FHWA TS-86-215, Railroad-Highway Grade Crossing Handbook.

WSDOT *Utilities Manual* (M 22-87) Chapter 3, Railroads. (Explains the details for agreements with the railroads and the responsibilities of WSDOT district and headquarters personnel.)

RCW 81.53 Railroad - Crossings.

FHWA, Traffic Control Devices Handbook, Part VIII, Traffic Control Systems for Railroad-Highway Grade Crossings, 1983.

### 930.03 PLANS

Provide design plans for all improvements of existing crossings and for all new crossings. These plans normally are included in the design report. (See Chapter 330.)

Indicate on the preliminary design plan the basic roadway dimensions of shoulders, medians, traffic lanes, stopping lanes, acceleration lanes, guardrail, attenuation, advance warning devices, etc., for existing facilities. Show the angle of crossing, number of tracks, location of signals, and any other railway facilities such as signal power lines, signal control boxes, switch control boxes, etc. on existing facilities. On proposed railroad crossings show the location of the improvement on the plan.

Sight distance is of primary consideration at grade crossings. The condition at a railroad grade crossing is comparable to that of intersecting highways where a corner sight triangle must be kept clear of obstructions. The desirable corner sight distance arrangement is that

which allows a driver approaching the grade crossing to see a train at such a distance that if the train proceeded without slowing down it would reach the crossing at about the time the highway vehicle can be brought to a stop in advance of the crossing. See Figure 930-1, Case 2. Sight distances of the order shown are desirable at any railroad crossing not controlled by active warning devices. Their attainment, however, is difficult and often impracticable except in flat open terrain.

For safety, the driver of a stopped vehicle at a crossing should be able to see down the tracks far enough to be able to cross it before the train reaches the crossing. See Figure 930-1, Case 1.

When it is unreasonable to achieve the minimum sight triangle, installation of active control devices should be considered.

Plan and profile on both the railroad and highway should be shown for a minimum of 500 feet on both sides of the crossing. The roadway profile should be extended as necessary to show all important vertical alignment data. Show other important features that may affect the design or traffic operation of the crossings, such as proximity of crossroads or city street intersections, nearby driveways or entrances, highway structures, vehicular ADT (including percentage of trucks and number of school buses), and train ADT.

When a highway crosses a railroad at grade, the highway grade should be constructed so that a low-hung vehicle will not damage the tracks or get hung up on the tracks. The highway surface should be no more than 3 inches higher nor 6 inches lower than the top of the nearest rail in the plane of the rails at a point 30 feet from the rail, measured at right angles to the railroad. See Chapter 630.

The skew angle of all at-grade crossings shall be as safe as is practicable. For motorized traffic, wherever possible, the crossing should be at right angles to the rails.

Whenever it is necessary to cross railroad tracks with a bikeway, the crossing should be at least as wide as the approaches of the bikeway and at right angles to the rails. Where a skew is unavoidable, the shoulder should be widened to permit the bicycles to cross at right angles. See Chapter 1020.

### 930.04 TRAFFIC CONTROL SYSTEMS

The function of traffic control systems is to permit safe and efficient operation of railroad and highway traffic crossings. These systems along highways approaching at-grade railroad crossings may include one or more of the following:



(a) Signing is a part of the Passive Traffic Control System which also includes pavement markings and grade crossing illumination. Signing used at railroad grade crossings includes one or more of the following:

- Railroad Crossing Sign, commonly identified as the "crossbuck" sign. The railroad is responsible for placement and maintenance of the crossbuck sign.
- Railroad Crossing Auxiliary Sign of an inverted T shape mounted below the crossbuck sign to indicate the number of tracks when two or more tracks are between the signs.
- Railroad Advance Warning Sign.
- Exempt Crossing Sign. A supplemental sign that, when authorized by law or regulation, may be mounted below the crossbuck and railroad advance warning signs. See Part 8 of the MUTCD.
- Do Not Stop on Tracks Sign.

Signing design elements are shown in Chapter 820 and the *Manual on Uniform Traffic Control Devices* (MUTCD).

(b) Pavement markings placed in advance of a grade crossing on all paved approaches shall consist of railroad pavement markings, no passing marking (two-lane roads), and stopping lanes (if needed). Generally, other pavement markings will be used as shown in Chapter 830.

(c) Illumination at and adjacent to railroad crossings should be installed to supplement other traffic control devices where railroad operations are conducted at night. Railroad crossings of state highways warrant illumination if warrants for gates or signals are met. Other crossings with a nighttime accident pattern may be considered for illumination. See Chapter 840.

Deviations will be considered for not illuminating crossings with gates or signals if there is no nighttime activity and if the crossing is not used as a school bus route.

(d) Signals and gates are considered part of the active grade crossing traffic control system. Signals consist of post mounted flashing light signals and cantilever flashing light signals, and where warranted, the addition of automatic gates. Any of the foregoing may incorporate a bell.

Due to the large number of significant variables that must be considered, there is no single standard system of active traffic control devices universally applicable for grade crossings. Based on an engineering and traffic investigation, a determination is made as to what type of active traffic control system is appropriate.

Figure 930-2 gives guidelines for determining the amount of crossing protection to be provided. The district's

recommendations and support data are to be forwarded to the headquarters Project Development Office as part of the design report. (See Chapter 330.)

Signal installations will use the signals shown in the current edition of the MUTCD and the Railroad-Highway Grade Crossing Handbook published by the FHWA.

The locations of signals and automatic gates are shown in the MUTCD.

A railroad signal may be a point hazard warranting the use of a traffic barrier or a crash cushion. Traffic barrier and crash cushion guidelines are shown in Chapters 710 and 720. Traffic barriers or crash cushions shall be placed outside the minimum railroad clearance as shown in the MUTCD.

Railroad crossing improvements are usually funded as separate projects. When separately funded projects are combined into a single contract, the railroad improvements shall be separated out.

### **930.05 STOPPING LANES**

Stopping lanes for certain vehicles (school buses, vehicles carrying hazardous materials, etc.) shall be provided when constructing all railroad grade crossings except:

- Any railroad grade crossing at which traffic is controlled by a police officer or a duly authorized flagman.
- Any railroad grade crossing at which traffic is regulated by a traffic control signal.
- Any railroad grade crossing protected by signals with or without an automatic gate, intended to give warning of the approach of a railroad train.
- Any railroad grade crossing for which the Utilities and Transportation Commission, pursuant to RCW 81.53.060, gives notice that the stopping requirement imposed by this section does not apply (Exempt Signing).

The stopping lane geometrics shall be in accordance with Figure 930-3. The shoulder along the stopping lane shall be a minimum of 3 feet.

### **930.06 TYPES OF CROSSING SURFACES**

A smooth surface is an important part of any railroad-highway grade crossing; it contributes to the safety of vehicles. Typical types of crossing surfaces for railroad-highway grade crossing are:

- Asphalt or bituminous.
- Concrete.
- Steel.
- Timber.
- Rubber (elastomeric) panels.
- Linear high density polyethylene modules.

- Epoxy-rubber mix cast-in-place.

Railroad Highway Grade Crossing Handbook (FHWA), and Implementation Package 798 (Railroad-Highway Grade Crossing Surfaces), although neither constitutes a standard, specification, or regulation, detail a number of crossing surfaces, some of which are a modification of those listed above.

When the highway is resurfaced, each crossing may require removal and reinstallation. Hence, the crossing surface installation must be compatible with railroad operations and maintenance requirements.

### **930.07 CROSSING CLOSURE**

Any railroad grade crossing for which there is not a demonstrated need should be closed.

Where a railroad track has been abandoned or its use discontinued, all related traffic control devices shall be removed, and the tracks should be removed or paved over.

Recommendations for crossing closures are sent to the headquarters Utilities/Railroad Engineer.

### **930.08 TRAFFIC CONTROLS DURING CONSTRUCTION AND MAINTENANCE**

Traffic controls for street and highway construction and maintenance operations are discussed in Chapter 810. Similar traffic control methods should be used where highway traffic is affected by construction and maintenance at railroad grade crossings.

### **930.09 RAILROAD GRADE CROSSING ORDERS**

The Utilities and Transportation Commission issues the necessary orders authorizing highway-railroad grade crossings. Petition and interrogatory form issued by the Utilities and Transportation Commission provides guidance to obtain the necessary order. Figure 930-4 shows the format. The plan should be drawn on 8 1/2 x 11 inch or 8 1/2 x 13 inch sheets or multiples of these sizes.

Show the information required for preliminary plans noted above and submit the tracing and one copy of the interrogatory form to the headquarters Project Development Office with the right of way plans.

### **930.10 LONGITUDINAL EASEMENTS FROM RAILROAD**

In general, right of way is not acquired in fee from a railroad company. Instead, the state acquires easements, access rights, construction permits, encroachments, etc. Refer to the *Utilities Manual* Chapter 3, Railroads for details.

Longitudinal cross sections are required. Figure 930-5 shows some typical encroachment cross sections.

Prepare the cross sections on 24 x 36 inch transparent 10 x 10 cross section paper. Draw the sections to a scale of 1 inch equals 10 feet. Identify each sheet by penciling project name, county, and sign route, sheet, control section, and project number on the left margin.

Each cross section is to show the following data:

- Distance between the highway and railway center line taken normal to the highway center line at each highway station.
- The highway station and the equivalent railway station.
- The finished highway profile grade.
- Existing ground elevation at highway center line.
- Distances from the highway center line to the encroachment lines and to existing right of way lines.
- Highway and railway stationing for the beginning and end of the encroachment.

Cross section measurements and location must agree with those shown on the right of way plans and as outlined in the *Plans Preparation Manual*.

Longitudinal cross sections shall be submitted with the right of way plans.

Case 1 Departure From Stop		Case 2 Moving Vehicle									
Train Speed (km/h) $V_T$	0	Vehicle Speed (km/h) $V_V$									
		20	30	40	50	60	70	80	90	100	110
		$f = 0.40$	0.40	0.38	0.35	0.33	0.31	0.30	0.30	0.29	0.28
		Distance along railroad from crossing - $d_T$ (meters)									
20	95	50	40	40	40	40	40	45	45	50	50
40	185	100	80	75	75	80	85	85	90	95	100
60	275	145	120	115	115	115	125	130	135	145	155
80	355	195	160	150	150	155	165	170	180	190	205
100	455	240	200	190	190	195	205	215	225	235	255
120	550	290	240	225	225	230	245	255	265	285	305
140	640	335	285	265	260	270	285	300	310	330	355
		Distance along highway from crossing - $d_H$ (meters)									
		25	40	55	70	95	120	150	180	215	255

Required design sight distance for combination of highway and train vehicle speeds; 19.5 m truck crossing a single set of tracks at 90°.

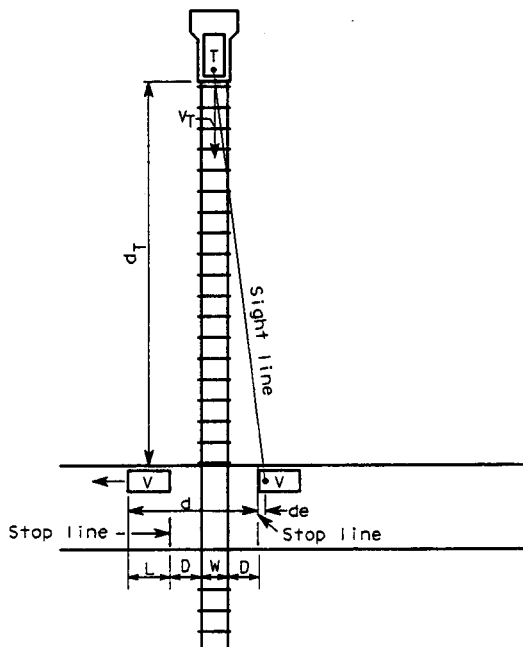

CASE 1  
(stopped vehicle)

Adjustments must be made for skew crossings.  
Assumed flat highway grades adjacent to and at crossings.  
 $W$  = Distance between outer rails (single track  $W = 1.5$  m)  
 $D$  = Distance from stop line to nearest rail (assumed 4.5 m)  
 $d_e$  = Distance from driver to front of vehicle (assumed 3.0 m)

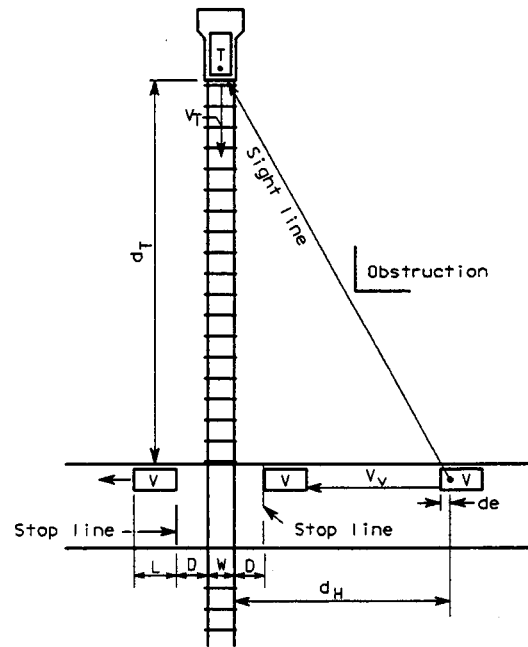

CASE 2  
(moving vehicle)

$d_H$  = Sight distance along highway  
 $d_T$  = Sight distance along railroad tracks  
 $V_V$  = Velocity of vehicle  
 $f$  = Coefficient of friction  
 $V_T$  = Velocity of train  
 $L$  = Length of vehicle (assumed 19.5 m)

## SIGHT DISTANCE AT RAILROAD CROSSING

Figure 930-1  
(Metric)

All conditions not covered in this chart, or marginal situations, are to be referred to headquarters, Project Development Office with the district's recommendation and support data.

TYPE OF HIGHWAY	EXPOSURE FACTOR x	TYPE OF RAILROAD FACILITY		
		NONMAIN LINE	SINGLE MAIN LINE (UNDER 60 MPH)	DOUBLE TRACK OR HIGH SPEED SINGLE MAIN LINE
Two Lane	Under 1,500	Reflectorized Signs	Flashing Lights	Flashing Lights
	1,500 - 5,000	Flashing Lights	Flashing Lights	Flashing Lights
	5,000 - 50,000	Auto. Gates xx	Auto. Gates xx	Auto. Gates xx
	Over 50,000	Separation	Separation	Separation
Multi-Lane	Under 50,000	Auto. Gates	Auto. Gates	Auto. Gates
	Over 50,000	Separation	Separation	Separation
All Fully Controlled Access	In All Cases	Separation	Separation	Separation

x Exposure Factor = Trains per day x vehicle ADT.

xx Automatic Gates to be used in urban areas and flashing lights in rural areas, unless conditions warrant otherwise.

### GUIDELINES FOR RAILROAD CROSSING PROTECTION

Figure 930-2

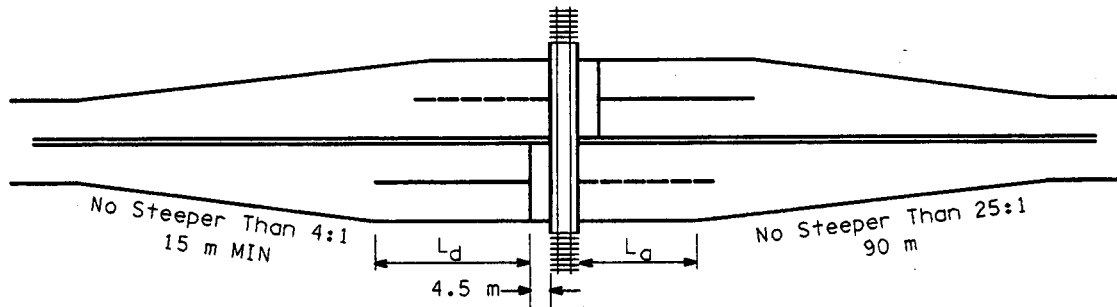

$L_d$  = Total length of pullout lane, approach  
 $L_a$  = Total length of pullout lane, exit

Approach Length of Pullout Lane, $L_d$		Downstream Length of Pullout Lane, $L_a$	
Vehicle Speed (km/h)	Length (m)	Vehicle Speed (km/h)	Length (m)
50	55	50	0
60	85	60	25
70	100	70	80
80	115	80	130
90	130	90	200
100	145	100	265

### TYPICAL PULLOUT LANE AT RAILROAD CROSSING

Figure 930-3  
(Metric)

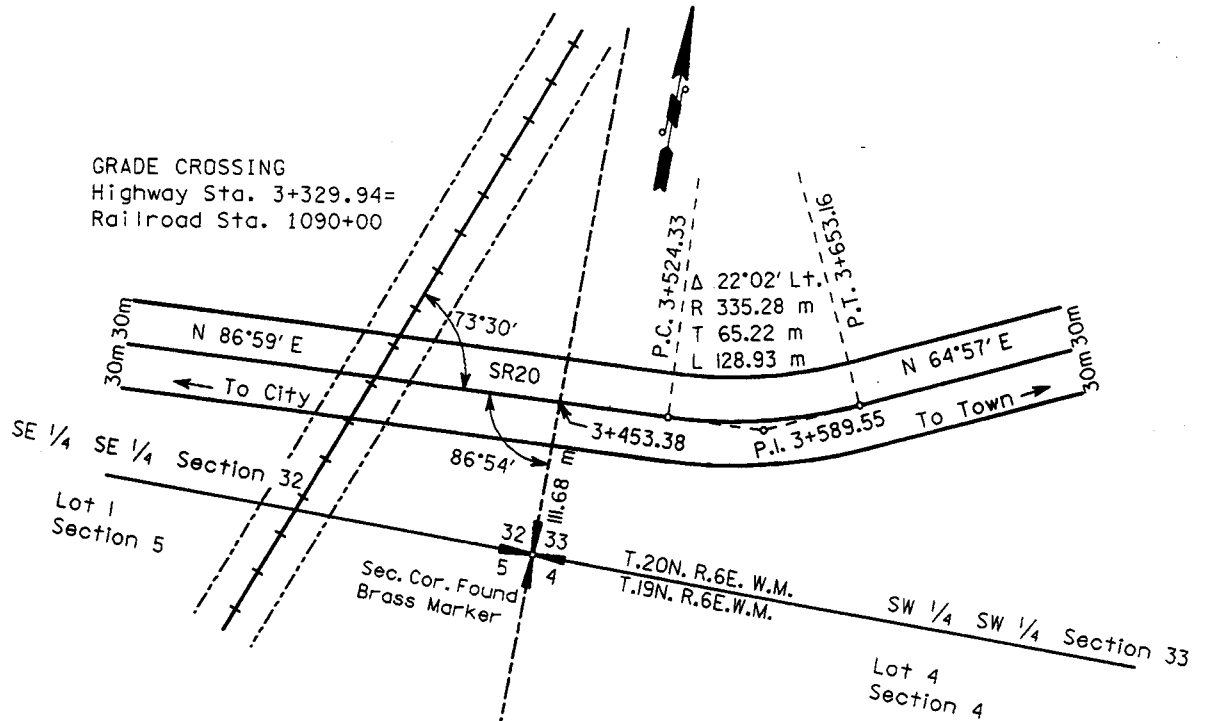

- NOTES:
1. Minimum scale to be used: Horizontal 1:4800  
Vertical 1:480
  2. Railroad stationing in units designated by the railroad.

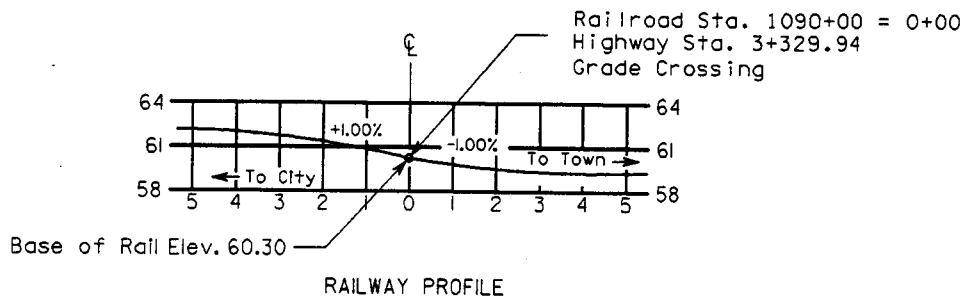
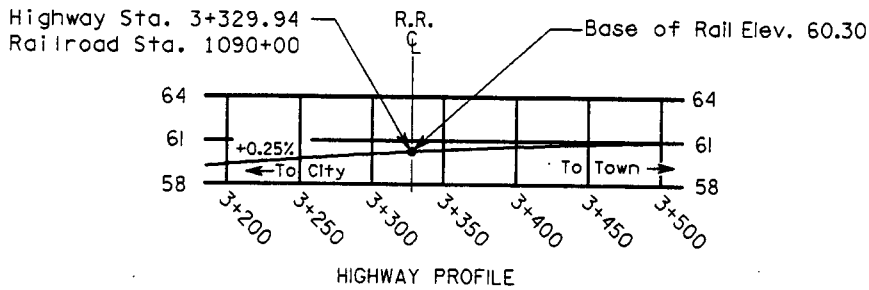

**RAILROAD CROSSING PLAN FOR  
WASHINGTON UTILITIES AND TRANSPORTATION COMMISSION**

Figure 930-4  
(Metric)

BEGINNING OF EASEMENT - HIGHWAY STATION 3+855.80 - RAILWAY STATION 57294+57.6

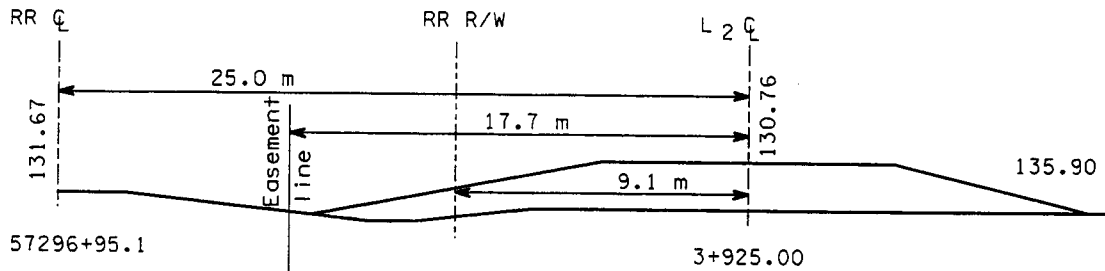
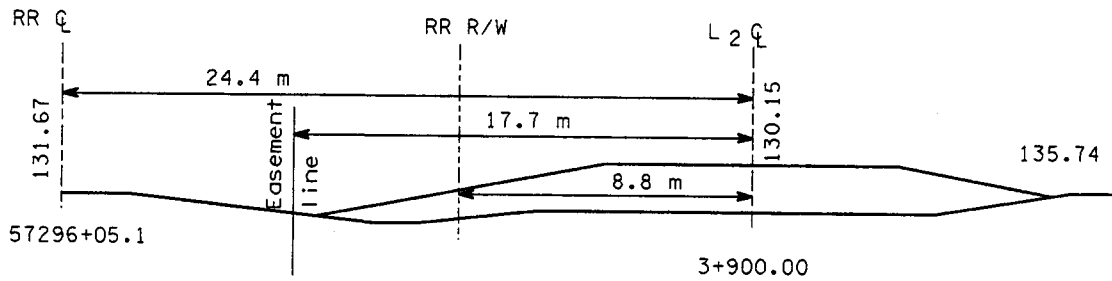
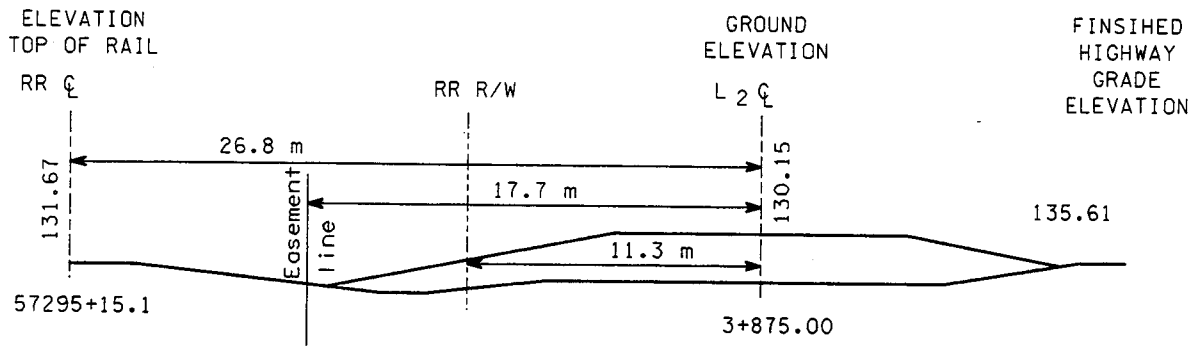

END OF EASEMENT - HIGHWAY STATION 3+932.70 - RAILROAD STATION 57297+73.1

NOTE:

1. All measurements between Railroad and Highway Center Lines shall be taken NORMAL TO HIGHWAY CENTER LINE.
2. Measurements on Cross Sections shall agree on Right of Way Plans.
3. Railroad stationing in units designated by the railroad.

**LONGITUDINAL EASEMENT CROSS SECTIONS**

Figure 930-5  
(Metric)

Case 1 Departure from stop		Case 2 Moving vehicle						
Train Speed (MPH) $V_T$	0	Vehicle Speed (MPH) $V_v$						
		10	20	30	40	50	60	70
		$f=0.40$	0.40	0.35	0.32	0.30	0.29	0.28
		Distance Along Railroad from Crossing $d_T$ (ft)						
10	240	145	105	100	105	115	125	135
20	480	290	210	200	210	225	245	270
30	720	435	310	300	310	340	370	405
40	960	580	415	400	415	450	490	540
50	1160	725	520	500	520	565	615	675
60	1440	870	620	600	620	675	735	810
70	1680	1015	725	700	725	790	860	940
80	1920	1160	830	800	830	900	980	1075
90	2160	1305	930	900	930	1010	1100	1210
		Distance Along Highway from Crossing (ft) $d_H$						
		70	135	225	340	490	660	865

Required design sight distance for combination of highway and train vehicle speeds: 65 ft truck crossing a single set of tracks at 90°.

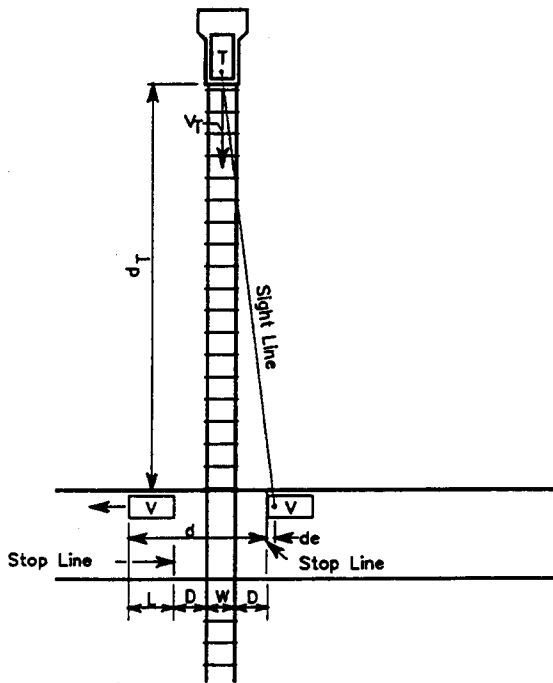

CASE 1 (stopped vehicle)

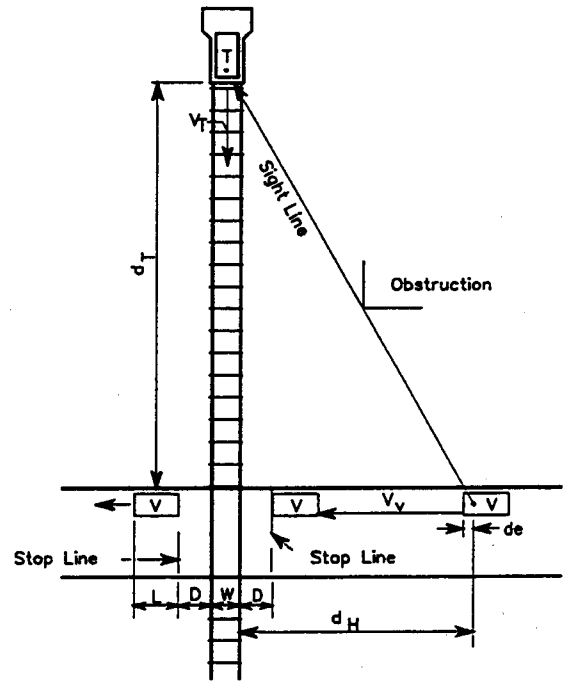

CASE 2 (moving vehicle)

Adjustments must be made for skew crossings.  
 Assumed flat highway grades adjacent to and at crossings.  
 $W$  = Distance between outer rails (single track  $W=5$  ft.)  
 $D$  = Distance from stop line to nearest rail (assumed 15 ft.)  
 $d_e$  = Distance from driver to front of vehicle (assumed 10 ft.)

$d_H$  = Sight distance along highway  
 $d_T$  = Sight distance along railroad tracks  
 $V_v$  = Velocity of vehicle  
 $f$  = Coefficient of friction  
 $V_T$  = Velocity of train  
 $L$  = Length of vehicle (assumed 65 ft.)

## SIGHT DISTANCE AT RAILROAD CROSSING

Figure 930-1



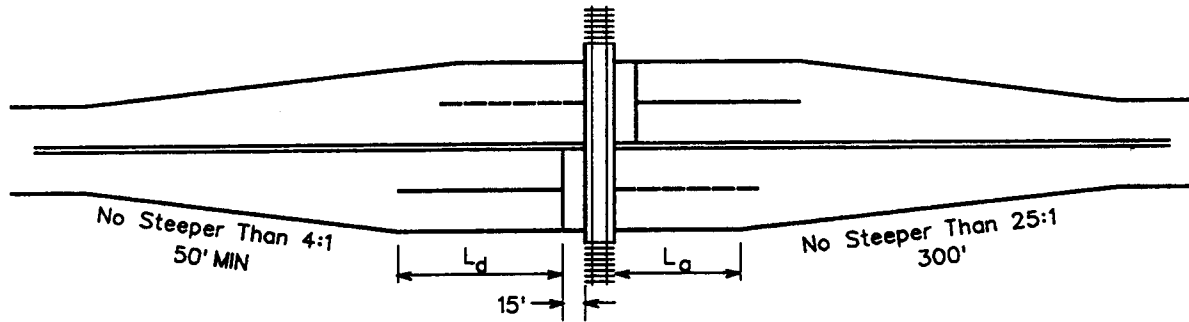

$L_d$  = Total length of pullout lane, approach  
 $L_a$  = Total length of pullout lane, exit

Approach Length of Pullout Lane, $L_d$		Downstream Length of Pullout Lane, $L_a$	
Vehicle Speed (MPH)	Length (FT)	Vehicle Speed (MPH)	Length (FT)
30	175	30	0
40	265	40	80
50	385	50	460
60	480	60	870

### TYPICAL PULLOUT LANE AT RAILROAD CROSSING

Figure 930-3

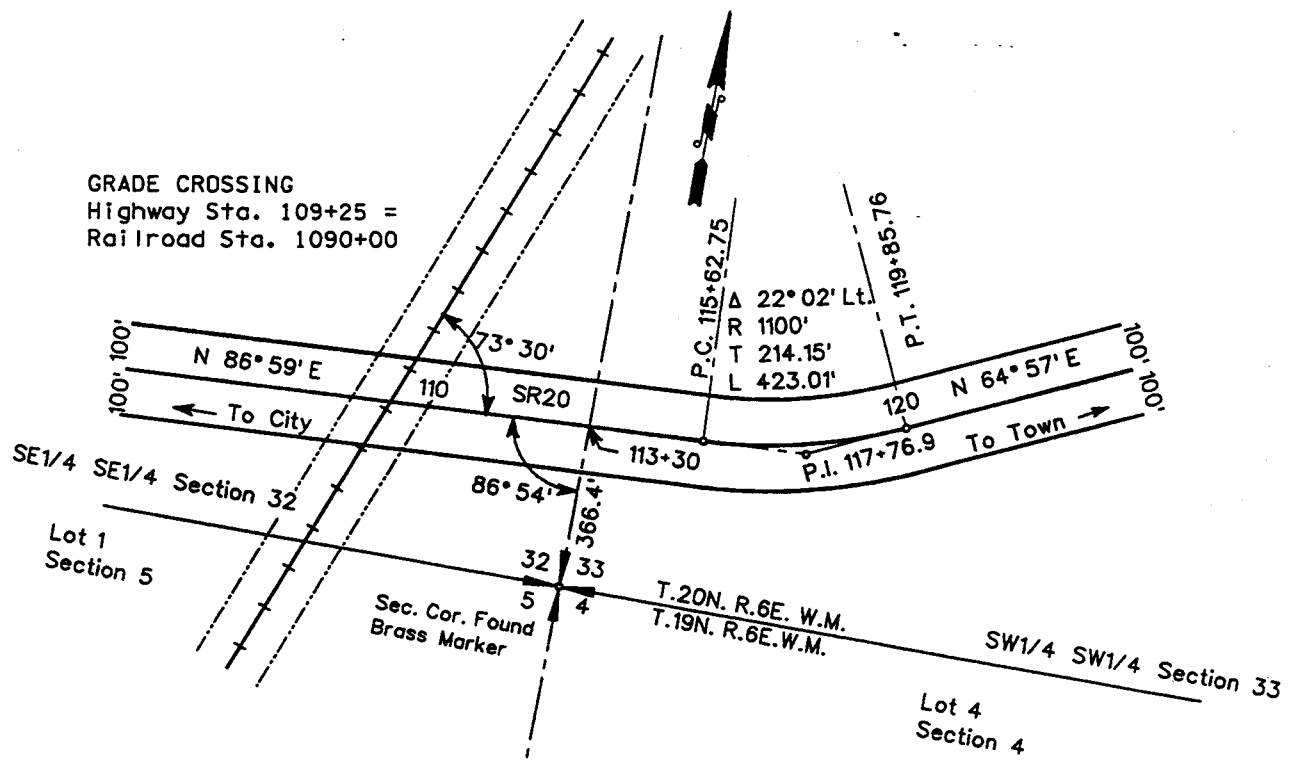

NOTE:  
 Minimum scale to be used: Horizontal 1"=400'  
 Vertical 1"=40'

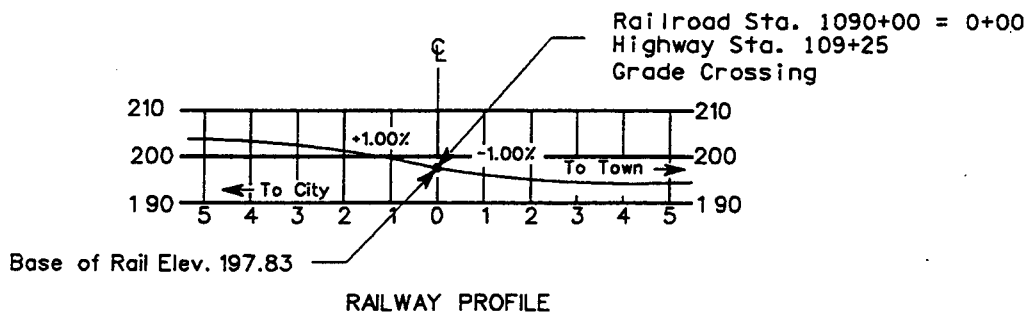
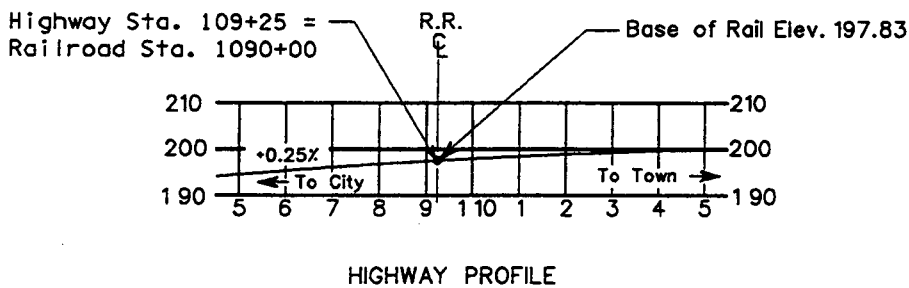

**RAILROAD CROSSING PLAN FOR  
 WASHINGTON UTILITIES AND TRANSPORTATION COMMISSION**

Figure 930-4

BEGINNING OF EASEMENT - HIGHWAY STATION 126+32.5 - RAILWAY STATION 57294+57.6

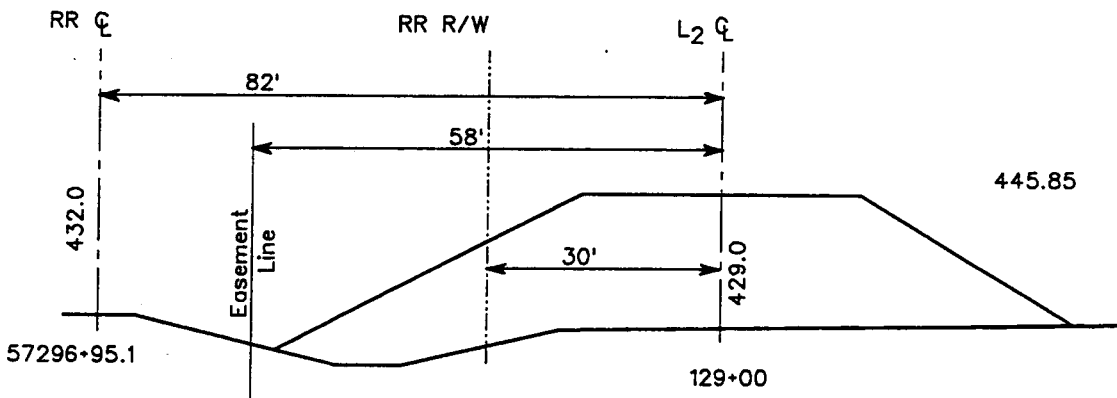
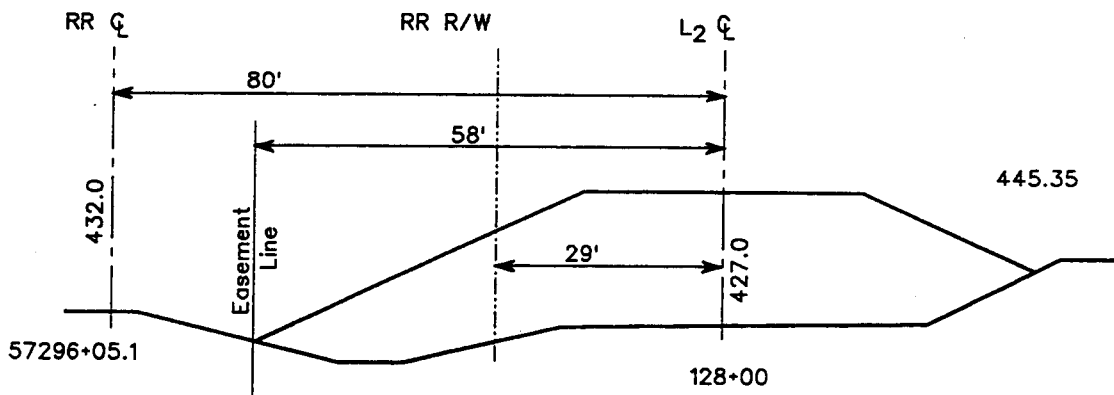
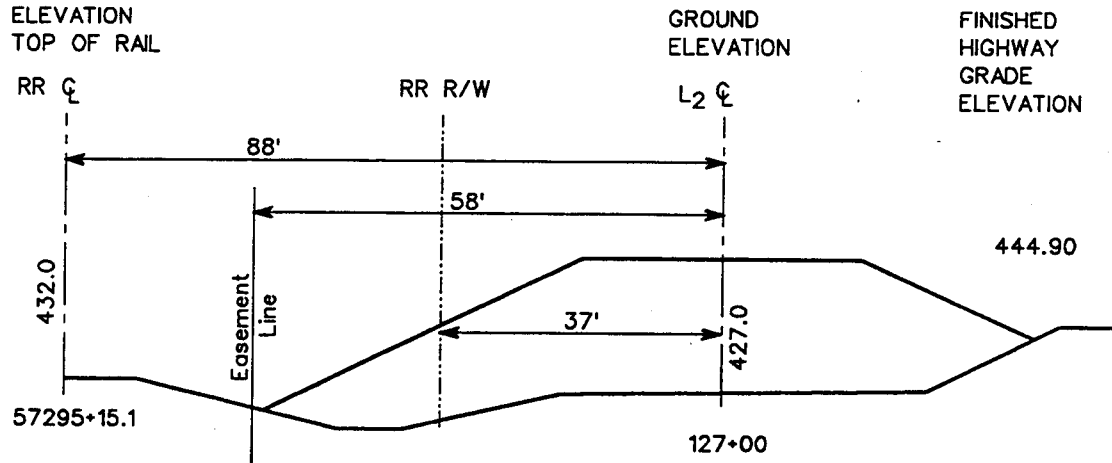

END OF EASEMENT - HIGHWAY STATION 129+58.0 - RAILROAD STATION 57297+73.1

NOTES:

All measurements between Railroad and Highway Center Lines shall be taken NORMAL TO HIGHWAY CENTER LINE.

Measurements on Cross Sections shall agree with those shown on Right of Way Plans.

**LONGITUDINAL EASEMENT CROSS SECTIONS**

Figure 930-5

940.01	General
940.02	References
940.03	Definitions
940.04	Interchange Design
940.05	Ramps
940.06	Interchange Connections
940.07	Ramp Terminal Intersections at Crossroads
940.08	Interchanges on Two-Lane Highways
940.09	Interchange Plans
940.10	Documentation

### 940.01 General

The primary purpose of an interchange is to eliminate conflicts caused by vehicle crossings and to minimize conflicting left-turn movements. Interchanges are provided on all Interstate highways, freeways, other routes on which full access control is required, and at other locations where traffic cannot be controlled safely and efficiently by intersections at grade.

See the following chapters for additional information:

Chapter	Subject
640	Superelevation
640	Turning Widths
640	Ramp Sections
910	Intersections
1050	HOV Lanes
1420	Access Control
1425	Access Point Decision Report

### 940.02 References

*Standard Plans for Road, Bridge, and Municipal Construction* (Standard Plans), M 21-01, WSDOT

*Plans Preparation Manual*, M 22-31, WSDOT

*HOV Direct Access Design Guide*, Draft M 22-98, WSDOT

*Standard Specifications for Road, Bridge, and Municipal Construction* (Standard Specifications), M 41-10, WSDOT.

*A Policy on Geometric Design of Highways and Streets* (Green Book), 1994, AASHTO

*A Policy on Design Standards - Interstate System*, 1991, AASHTO

*Highway Capacity Manual* (Special Report 209), Transportation Research Board

*Procedure for Analysis and Design of Weaving Sections, A User's Guide*, October 1985, Jack E. Leisch.

### 940.03 Definitions

**auxiliary lane** The portion of the roadway adjoining the traveled way for parking, speed change, turning, storage for turning, weaving, truck climbing, passing, and other purposes supplementary to through traffic movement

**basic number of lanes** The minimum number of general purpose lanes designated and maintained over a significant length of highway.

**collector distributor road (C-D road)** A parallel roadway designed to remove weaving from the main line and to reduce the number of main line entrances and exits.

**decision sight distance** The sight distance required for a driver to detect an unexpected or difficult-to-perceive information source or hazard, interpret the information, recognize the hazard, select an appropriate maneuver, and complete it safely and efficiently.

**frontage road** An auxiliary road that is a local road or street located on the side of a highway for service to abutting property and adjacent areas, and for control of access.

**gore** The area downstream from the intersection of the main line and exit ramp shoulders.

**intersection at grade** The general area where a state highway or ramp terminal is met or crossed at a common grade or elevation by another state highway, a county road, or a city street.

**Interstate System** A network of routes selected by the state and the FHWA under terms of the

federal aid acts as being the most important to the development of a national transportation system. The Interstate System is part of the principal arterial system.

**lane** A strip of roadway used for a single line of vehicles.

**median** The portion of a divided highway separating the traveled ways for traffic in opposite directions.

**outer separation** The area between the outside edge of traveled way for through traffic and the nearest edge of traveled way of a frontage road.

**physical nose** The point, upstream of the gore, where the separation between the roadways equals the sum of the shoulder widths, but not less than 10 ft.

**ramp** A short roadway connecting a main lane of a freeway with another facility for vehicular use such as a local road or another freeway.

**ramp connection** The pavement at the end of a ramp, connecting it to a main lane of a freeway.

**ramp meter** A traffic signal at a freeway entrance ramp that allows a measured or regulated amount of traffic to enter the freeway.

**ramp terminal** The end of a ramp at a local road.

**roadway** The portion of a highway, including shoulders, for vehicular use. A divided highway has two or more roadways.

**sight distance** The length of highway visible to the driver.

**shoulder** The portion of the roadway contiguous with the traveled way, primarily for accommodation of stopped vehicles, emergency use, lateral support of the traveled way, and where permitted use by bicyclists and pedestrians.

**stopping sight distance** The sight distance required to detect a hazard and safely stop a vehicle traveling at design speed.

**traffic interchange** A system of interconnecting roadways, in conjunction with one or more grade separations, providing for the exchange of

traffic between two or more intersecting highways or roadways.

**traveled way** The portion of the roadway intended for the movement of vehicles, exclusive of shoulders and lanes for parking, turning, and storage for turning.

## 940.04 Interchange Design

### (1) General

All freeway exits and entrances are to connect on the right of through traffic. Deviations from this requirement will be considered for special conditions with an approved deviation.

Provide complete ramp facilities for all directions of travel wherever possible. However, give primary consideration to the basic traffic movement function that the interchange is to fulfill.

Few complications will be encountered in the design and location of rural interchanges that simply provide a means of exchanging traffic between a limited access freeway and a local crossroad. The economic and operational effects of locating traffic interchanges along a freeway through a community requires more careful consideration, particularly with respect to local access, to provide the best local service possible without reducing the capacity of the major route or routes.

Where freeway to freeway interchanges are involved, do not provide ramps for local access unless they can be added conveniently and without detriment to safety or reduction of ramp and through-roadway capacity. When exchange of traffic between freeways is the basic function and local access is prohibited by access control restrictions or traffic volume, it may be necessary to provide separate interchanges for local service.

### (2) Interchange Patterns

Basic interchange patterns have been established that can be used under certain general conditions and modified or combined to apply to many more. Alternatives must be considered in the design of a specific facility, but the conditions in the area and on the highway involved must govern and rigid patterns must not be indiscriminately imposed.

Selection of the final design must be based on a study of projected traffic volumes, site conditions, geometric controls, criteria for intersecting legs and turning roadways, driver expectancy, consistent ramp patterns, continuity, and cost.

The patterns most frequently used for interchange design are those commonly described as directional, semidirectional, cloverleaf, partial cloverleaf, diamond, and single point (urban) interchange. (See Figure 940-4.)

(a) **Directional** A directional interchange is the most effective design for connection of intersecting freeways. The directional pattern has the advantage of reduced travel distance, increased speed of operation, and higher capacity. These designs eliminate weaving and have a further advantage over cloverleaf designs in avoiding the loss of sense of direction drivers experience in traveling a loop. This type of interchange is costly to construct, commonly using a four-level structure.

(b) **Semidirectional** A semidirectional interchange has ramps that loop around the intersection of the highways. This requires multiple single-level structures and more area than the directional interchange.

(c) **Cloverleaf** The full cloverleaf interchange has four loop ramps that eliminate all the left-turn conflicts. Outer ramps provide for the right turns. A full cloverleaf is the minimum type interchange that will suffice for a freeway-to-freeway interchange. Cloverleaf designs often incorporate a C-D road to minimize signing difficulties and to remove weaving conflicts from the main roadway.

The principal advantage of this design is the elimination of all left-turn conflicts with one single-level structure. Because all movements are merging movements, it is adaptable to any grade line arrangement.

The cloverleaf has some major disadvantages. The left-turn movement has a circuitous route on the loop ramp, the speeds are low on the loop ramp, and there are weaving conflicts between the loop ramps. The cloverleaf also requires a large area. The weaving and the radius of the

loop ramps are a capacity constraint on the left-turn movements.

(d) **Partial Cloverleaf (PARCLO)** A partial cloverleaf has loop ramps in one, two, or three quadrants that are used to eliminate the major left-turn conflicts. These loops may also serve right turns for interchanges that have one or two quadrants that must remain undeveloped. Outer ramps are provided for the remaining turns. Design the grades to provide sight distance between vehicles approaching these ramps.

(e) **Diamond** A diamond interchange has four ramps that are essentially parallel to the major arterial. Each ramp provides for one right and one left-turn movement. Because left-turns are made at grade across conflicting traffic on the crossroad, intersection sight distance is a primary consideration.

The diamond design is the most generally applicable and serviceable interchange configuration and usually requires less space than any other type. Consider this design first when a semidirectional interchange is required unless another design is clearly dictated by traffic, topography, or special conditions.

(f) **Single Point (Urban)** A single point urban interchange is a modified diamond with all of its ramp terminals on the crossroad combined into one signalized at-grade intersection. This single intersection accommodates all interchange and through movements.

A single point urban interchange can improve the traffic operation on the crossroad with less right of way than a standard diamond interchange; however, a larger structure is required.

### (3) **Spacing**

To avoid excessive interruption of main line traffic, consider each proposed facility in conjunction with adjacent interchanges, intersections, and other points of access along the route as a whole.

The minimum spacing between adjacent interchanges is 1 mi in urban areas and 2 mi in rural areas. In urban areas, spacing less than 1 mi may be used with C-D roads or grade

separated (braided) ramps. Generally, the average interchange spacing is not less than 2 mi in urban areas and not less than 4 mi in suburban areas. Interchange spacing is measured along the freeway center line between the center lines of the crossroads.

The spacing between interchanges may also be dependent on the spacing between ramps. The minimum spacing between the noses of adjacent ramps is given on Figure 940-5.

Consider either frontage roads or C-D roads when it is necessary to facilitate the operation of near-capacity volumes between closely spaced interchanges or ramp terminals. C-D roads may be required where cloverleaf loop ramps are involved or where a series of interchange ramps that require overlapping of the speed change lanes. Base the distance between successive ramp terminals on capacity requirements and check the intervening sections by weaving analysis to determine whether adequate capacity, sight distance, and effective signing can be ensured without the use of auxiliary lanes or C-D roads.

#### **(4) Route Continuity**

Route continuity refers to the providing of a directional path along the length of a route designated by state route number. Provide the driver of a through route a path on which lane changes are minimized and other traffic operations occur to the right.

In maintaining route continuity, interchange configuration may not always favor the heavy traffic movement, but rather the through route. In this case, design the heavy traffic movements with multilane ramps, flat curves, and reasonably direct alignment.

#### **(5) Drainage**

Avoid interchanges located in proximity to natural drainage courses. These locations often result in complex and unnecessarily costly hydraulic structures.

The open areas within an interchange can be used for storm water detention facilities when these facilities are required.

#### **(6) Uniformity of Exit Pattern**

While interchanges are of necessity custom designed to fit specific conditions, it is desirable that the pattern of exits along a freeway have some degree of uniformity. From the standpoint of driver expectancy, it is desirable that each interchange have only one point of exit, located in advance of the crossroad.

### **940.05 Ramps**

#### **(1) Ramp Design Speed**

The design speed for a ramp is based on the design speed for the freeway main line. Use the design speeds shown in Figure 940-1 for ramps.

Main Line Design Speed mph	40	50	60	70	80
Ramp Design Speed (mph)	35	45	50	60	70

#### **Ramp Design Speed**

*Figure 940-1*

These guidelines are for the ramp at the interchange connection. Vary the ramp design speed to provide a smooth speed transition from the interchange connection to the crossroad speed or the stop at the intersection. Variations in curvature may prevent design of an interchange ramp for a constant design speed, but under no conditions may design speed be reduced below 35 mph for freeway to freeway ramps and 25 mph for other ramps. For loop ramps the design speed may be reduced to 25 mph; however, it is desirable that the design speed be as high as practical. For C-D roads the design speed is 10 mph below the main line design speed. Use the allowed skew at the crossroad intersection to minimize ramp curvature.

#### **(2) Sight Distance**

Design ramps in accordance with provisions in Chapter 650 for stopping sight distances.

#### **(3) Grade**

The maximum grade for ramps for various design speeds is given in Figure 940-2.

Ramp Design Speed (mph)	25-30	35-40	45 and above
Desirable Grade (%)	5	4	3
Maximum Grade (%)	7	6	5
On one-way ramps down grades may be 2% greater.			

### Maximum Ramp Grade

Figure 940-2

#### (4) Cross Section

Provide the minimum ramp widths given in Figure 940-3. Ramp traveled ways may require additional width to these minimums as one-way turning roadways. See Chapter 640 for additional information and roadway sections.

Number of Lanes	1	2
Traveled Way <sup>(1)</sup>	15 <sup>(2)</sup>	25 <sup>(3)</sup>
Shoulders Right Left	8 2	8 4
Medians <sup>(4)</sup>	6	6
<p>(1)See Chapter 1050 for additional width when an HOV lane is present.  (2)May be reduced to 12 ft on tangents.  (3)Add 12 ft for each additional lane.  (4)In addition to shoulder width.</p>		

### Ramp Widths (ft)

Figure 940-3

Cross slope and superelevation requirements for ramp traveled way and shoulders are as given in Chapter 640 for roadways.

Whenever feasible, make the ramp cross slope at the ramp beginning or ending station equal to the cross slope of the through lane pavement. Where space is limited and superelevation runoff is long or when parallel connections are used, the superelevation transition may be ended beyond (for on-ramps) or begun in advance of (for off-ramps) the ramp beginning or ending station, provided that the algebraic difference in cross

slope at the edge of the through lane and the cross slope of the ramp does not exceed 4%. In such cases, ensure smooth transitions for the edge of traveled way.

#### (5) Ramp Lane Increases

When off-ramp traffic and left-turn movements volume at a crossroad terminal cause congestion, it may be desirable to add lanes to the ramp to reduce the queue length caused by turning conflicts. Make provision for the addition of ramp lanes whenever ramp exit or entrance volumes, after the design year, are expected to result in poor service. See Chapter 620 for width transition design.

#### (6) Ramp Meters

Ramp meters are used to allow a measured or regulated amount of traffic to enter the freeway. When operating in the “measured” mode, they release traffic at a measured rate to keep downstream demand below capacity and improve system travel times. In the “regulated” mode, they break up platoons of vehicles that occur naturally or result from nearby traffic signals. Even when operating at near capacity, a freeway main line can accommodate merging vehicles one or two at a time, while groups of vehicles will cause main line flow to break down.

The location of the ramp meter is a balance between the storage and acceleration requirements. Locate the ramp meter to maximize the available storage and so that the acceleration lane length, from a stop to the freeway main line design speed, is available from the stop bar to the merging point. With justification, the average main line running speed during the hours of meter operation may be used for the highway design speed to determine the minimum acceleration lane length from the ramp meter. See 940.06(4) for information on the design of on-connection acceleration lanes. See Chapter 860 for additional information on the design of ramp meters.

Driver compliance with the signal is required for the ramp meter to have the desired results. Consider enforcement areas with ramp meters.



Consider HOV bypass lanes with ramp meters. See Chapter 1050 for design data for ramp meter bypass lanes.

## **940.06 Interchange Connections**

Provide uniform geometric design and uniform signing for exits and entrances, to the extent possible, in the design of a continuous freeway. Do not design exit ramps as an extension of a main line tangent at the beginning of a main line horizontal curve.

Provide spacing between interchange connections as given by Figure 940-5.

Avoid on-connections on the inside of a main line curve, particularly when the ramp approach angle is accentuated by the main line curve, the ramp approach requires a reverse curve to connect to the main line, or the elevation difference will cause the cross slope to be steep at the nose.

Keep the use of mountable curb at interchange connections to a minimum. Justification is required when it is used adjacent to traffic expected to exceed 40 mph.

### **(1) Lane Balance**

Design interchanges to the following principles of lane balance:

- (a) At entrances, make the number of lanes beyond the merging of two traffic streams not less than the sum of all the lanes on the merging roadways less one. (See Figure 940-6a.)
- (b) At exits, make the number of approach lanes equal the number of highway lanes beyond the exit plus the number of exit lanes less one. (See Figure 940-6b.) Exceptions to this would be at a cloverleaf or at closely spaced interchanges with a continuous auxiliary lane between the entrance and exit. In these cases the auxiliary lane may be dropped at a single-lane, one lane reduction, off-connection with the number of approach lanes being equal to the sum of the highway lanes beyond the exit and the number of exit lanes. Closely spaced interchanges have a distance of less than 2,100 ft between the end of the acceleration lane and the beginning of the deceleration lane.

Maintain the basic number of lanes, as described in Chapter 620, through interchanges. When a two-lane exit or entrance is used, maintain lane balance with an auxiliary lane. The only exception to this is when the basic number of lanes is changed at an interchange.

### **(2) Main Line Lane Reduction**

The reduction of a basic lane or an auxiliary lane may be made at a two-lane exit or may be made between interchanges. When a two-lane exit is used, provide a recovery area with a normal acceleration taper. When a lane is dropped between interchanges, drop it 1,500 to 3,000 ft from the end of the acceleration taper of the previous interchange. This will allow for adequate signing but not be so far that the driver will become accustomed to the number of lanes and be surprised by the reduction. (See Figure 940-7.)

Reduce the traveled way width of the freeway by only one lane at a time.

### **(3) Sight Distance**

Locate off-connections and on-connections on the main line to provide decision sight distance for a speed/path/direction change as described in Chapter 650.

### **(4) On-Connections**

On-connections are the pavement at the end of on-ramps, connecting them to the main lane of a freeway. They have two parts, an acceleration lane and a taper. The acceleration lane allows entering traffic to accelerate to the freeway speed and evaluate gaps in the freeway traffic. The taper is for the entering vehicle to maneuver into the through lane.

On-connections are either taper type or parallel type. The tapered on-connection provides direct entry at a flat angle, reducing the steering control needed. The parallel on-connection adds a lane adjacent to the through lane for acceleration with a taper at the end. Vehicles merge with the through traffic with a reverse curve maneuver similar to a lane change. While the taper requires less steering control, the parallel is narrower at the end of the ramp and has a shorter taper at the end of the acceleration lane.

(a) Provide the minimum acceleration lane length given on Figure 940-8 for all on-ramps. When the grade of the acceleration lane is 3% or greater, multiply the distance from the Minimum Acceleration Lane Length table by the factor from the Adjustment Factor for Grades table. Design the acceleration lane for a higher speed than the ramp to accommodate the increasing speed of the entering traffic.

The acceleration lane is measured from the last point designed at the ramp design speed (usually the PT of the last curve) to the last point with a ramp width of 12 ft. When the transition curve is designed for at least the posted speed of the freeway, its length may be included as part of the acceleration length.

(b) Provide the minimum gap acceptance length to allow entering traffic to evaluate gaps in the freeway traffic and position the vehicle to use the gap. The length is measured beginning at the point that the left edge of traveled way for the ramp is 10 ft from the right edge of traveled way of the main line to the ending of the acceleration lane. The gap acceptance length and the acceleration length overlap with the ending point controlled by the longer of the two.

(c) Single-lane on-connections may be either taper type or parallel type. The taper type is preferred; however, the parallel may be used with justification. Design single-lane taper type on-connections as shown on Figure 940-9a and single lane parallel type on-connections as shown on Figure 940-9b.

(d) For two-lane on-connections, the parallel type is preferred. Design two-lane parallel on-connections as shown on Figure 940-9c. A capacity analysis will normally be the basis for determining whether a freeway lane or an auxiliary lane is to be provided.

When justification is documented, a two-lane tapered on-connection may be used. Design two-lane tapered on-connections in accordance with Figure 940-9d.

### **(5) Off-Connections**

Off-connections are the pavement at the beginning of an off-ramp, connecting it to a main lane of a freeway. They have two parts, a taper for

maneuvering out of the through traffic and a deceleration lane to slow to the speed of the first curve on the ramp. Deceleration is not assumed to take place in the taper.

Off-connections are either taper type or parallel type. The taper type is preferred because it fits the path preferred by most drivers. When a parallel type connection is used, drivers tend to drive directly for the ramp and not use the parallel lane. However, when a ramp is required on the outside of a curve, the parallel off-connection is preferred. An advantage of the parallel connection is that it is narrower at the beginning of the ramp.

(a) Provide the minimum deceleration lane length given on Figure 940-10 for all off-ramps. When the grade of the deceleration lane is 3% or greater, multiply the distance from the Minimum Deceleration Lane Length table by the factor from the Adjustment Factor for Grades table. Design the deceleration lane to provide a higher speed than the ramp to accommodate the changing speed of the exiting traffic.

The deceleration lane is measured from the point where the taper reaches a width of 12 ft to the first point designed at the ramp design speed (often the PC of the first ramp curve). When the first curve is designed for at least the posted speed of the freeway, its length may be included as part of the deceleration length.

(b) Gores, Figure 940-11, are decision points that must be clearly seen and understood by approaching drivers. In a series of interchanges along a freeway, it is desirable that the gores be uniform and have the same appearance to the drivers.

The minimum distance from the physical nose to the gore nose is 90 ft (see figure 940-11).

In addition to striping, raised pavement marker rumble strips may be placed for additional warning and delineation at gores. See the Standard Plans for striping and rumble strip details.

The accident rate in the gore area is greater than at other locations. Keep the unpaved area beyond the gore nose as free of obstructions as possible to provide a clear recovery area. Grade this unpaved area as nearly level with the roadways

as possible. Avoid placing obstructions such as heavy sign supports, luminaire poles, and structure supports in the gore area.

When a major obstruction must be placed in a gore area, provide an impact attenuator (Chapter 720) and barrier (Chapter 710). Place the beginning of the attenuator as far back as possible, preferably after the gore nose.

(c) For single-lane off-connections, the taper type is preferred. Use the design shown on Figure 940-12a for tapered single-lane off-connections. When justification is documented, a parallel single-lane off-connection, as shown on Figure 940-12b, may be used.

(d) The single-lane off-connection with one lane reduction, Figure 940-12c, is only used when the conditions from lane balance for a single lane exit, one lane reduction, are met.

(e) The tapered two-lane off-connection design shown on Figure 940-12d is preferred where the number of freeway lanes is to be reduced, or where high volume traffic operations will be improved by the provision of a parallel auxiliary lane and the number of freeway lanes is to be unchanged.

The parallel two-lane off-connection, Figure 940-12e, allows less operational flexibility than the taper, requiring more lane changes. Use a parallel two-lane off-connection only with justification.

### **(6) Collector Distributor Roads**

A C-D road can be within a single interchange, through two closely spaced interchanges, or continuous through several interchanges. Design C-D roads that connect three or more interchanges to be two lanes wide. All others may be one or two lanes in width, depending on capacity requirements. Consider intermediate connections to the main line for long C-D roads. See Figure 940-13a for designs of collector distributor outer separations. Use Design A, with concrete barrier, when adjacent traffic in either roadway is expected to exceed 40 mph. Design B, with mountable curb, may be used only when adjacent traffic will not exceed 40 mph.

(a) The details shown in Figure 940-13b apply to all single-lane C-D road off-connections.

Where conditions require two-lane C-D road off-connections, a reduction in the number of freeway lanes, the use of an auxiliary lane, or a combination of these, design it as a standard off-connection per 940.06(5).

(b) Design C-D road on-connections as required by Figure 940-13c.

### **(7) Loop Ramp Connections**

Loop ramp connections at cloverleaf interchanges are distinguished from other ramp connections by a low speed ramp on-connection followed closely by an off-connection for another low speed ramp. The loop ramp connection design is shown on Figure 940-14. The minimum distance between the ramp connections is dependent on a weaving analysis. When the connections are spaced far enough apart that weaving is not a consideration, design the on-connection per 940.06(4) and off-connection per 940.06(5).

### **(8) Weaving Sections**

Weaving sections are highway segments where one-way traffic streams cross by merging and diverging. Weaving sections may occur within an interchange, between closely spaced interchanges, or on segments of overlapping routes. Figure 940-15 gives the length of the weaving section required for the total weaving traffic in equivalent passenger cars. The total weaving traffic is the sum of the traffic entering from the ramp to the main line and the traffic leaving the main line to the exit ramp. For trucks, a passenger car equivalent of two may be estimated. Design weaving sections in accordance with the *Highway Capacity Manual*.

Because weaving sections cause considerable turbulence, interchange designs that eliminate weaving or remove it from the main roadway are desirable. Use C-D roads for weaving between closely spaced ramps when adjacent to high speed highways. C-D roads are not required for weaving on low speed roads.

## 940.07 Ramp Terminal Intersections at Crossroads

Design ramp terminal intersections at grade with crossroads as intersections at grade. (See Chapter 910.) Whenever possible, design ramp terminals to discourage wrong way movements. Review the location of ramp intersections at grade with crossroads to ensure signal progression if the intersection becomes signalized in the future. Provide intersection sight distance as described in Chapter 910.

In urban and suburban areas match design speed at ramp terminal to the speed of the crossroad. Provide steeper intersection angles between the ramp terminal and crossroad to slow motor vehicle traffic speeds and reduce crossing distances for bicyclists and pedestrians.

The intersection configuration requirements for ramp terminals is normally the same as for other intersections. One exception to this is an angle point is allowed between an off ramp and an on ramp. This is because the through movement of traffic getting off the freeway, going through the intersection, and back on the freeway is minor.

Another exception is at ramp terminals where the through movement is eliminated (for example at a Single Point interchange). For ramp terminals that have two wye connections, one for right turns and the other for left turns, and no through movement the intersection angle has little meaning and does not need to be considered.

## 940.08 Interchanges on Two-Lane Highways

Occasionally, the first stage of a conventional interchange will be built with only one direction of the main roadway and operated as a two-lane two-way roadway until the ultimate roadway is warranted and construction completed.

The design of interchanges on two-lane two-way highways may vary considerably from traditional concepts due to the following conditions:

- The potential for center-line-crossing related accidents due to merge conflicts or motorist confusion.

- The potential for wrong way or U-turn movements.
- Future construction considerations.
- Traffic type and volume.
- The proximity to multilane highway sections that might influence the driver's impression that these roads are also multilane.

The deceleration taper is required for all exit conditions. Design the entering connection with either the standard acceleration taper or a "button hook" type configuration with a stop condition before entering the main line. Consider the following items:

- Design the stop condition connection in accordance with the requirements for a Tee intersection in Chapter 910. Use this type of connection only when an acceleration lane is not possible. Provide decision sight distance as described in Chapter 650.
- Since each design will probably vary from project to project, analyze each project for most efficient signing placement such as one way, two way, no passing, do not enter, directional arrows, guide posts, and traffic buttons.
- Prohibit passing through the interchange area on two lane highways by means of signing, pavement marking, or a combination of both. A 4 ft median island highlighted with raised pavement markers and diagonal stripes is the preferred treatment. When using a 4 ft median system, extend the island 500 ft beyond any merging ramp traffic acceleration taper. The width for the median can be provided by reducing each shoulder 2 ft through the interchange. (See Figure 940-16.)
- Inform both the entering and through motorists of the two-lane two-way characteristic of the main line. Include signing and pavement markings.
- Use as much of the ultimate ramp and throughway roadway system as possible. Where this is not possible, leave the area for future lanes and roadway ungraded.

- Design and construct temporary ramps as if they were permanent unless second stage construction is planned to rapidly follow the first. In all cases, design the connection to meet the safety needs of the traffic. (See Figure 940-16.)

### 940.09 Interchange Plans

Figure 940-17 is a sample showing the general format and data required for interchange design plans.

Compass directions (W-S Ramp) or crossroad names (E-C Street) may be used for ramp designation to realize the most clarity for each particular interchange configuration and circumstance.

Include the following as applicable:

- Classes of highway and design speeds for main line and crossroads (Chapter 440).
- Curve data on main line, ramps, and crossroads.
- Numbers of lanes and widths of lanes and shoulders on main line, crossroads, and ramps.
- Superelevation diagrams for the main line, the crossroad, and all ramps (may be submitted on separate sheets).
- Channelization (Chapter 910).
- Stationing of ramp connections and channelization.
- Proposed right of way and access control treatment (Chapter 1420).
- Delineation of all crossroads, existing and realigned (Chapter 910).
- Traffic data necessary to justify the proposed design. Include all movements.

Prepare a preliminary contour grading plan for each completed interchange. Show the desired contours of the completed interchange including details of basic land formation, slopes, graded areas or other special features. Coordinate the contour grading with the drainage design and the roadside development plan.

Alternative designs considered, studied, and rejected may be shown as reduced scale diagrams with a brief explanation of the advantages and disadvantages of the alternative designs, including the recommended design.

### 940.10 Documentation

The following documents are to be preserved in the project file. See Chapter 330.

- Interchange plan
- Access Point Decision Report (Chapter 1425)
- On-connection type justification
- Off-connection type justification
- Justification for ramp metering main line speed reduction
- Weaving analysis and design
- Alternative discussion and analysis

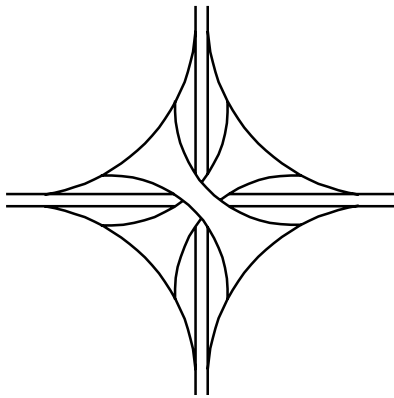

Directional

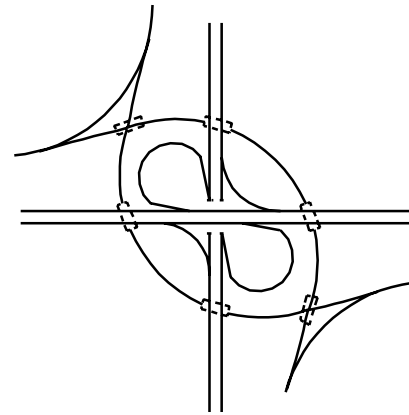

Semidirectional

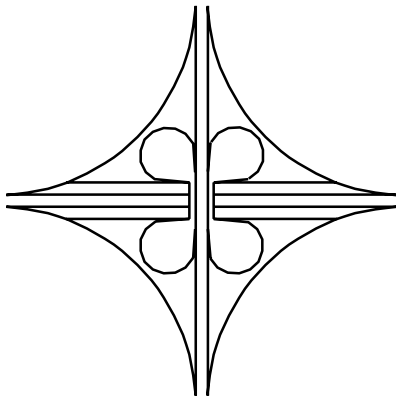

Cloverleaf with C-D Roads

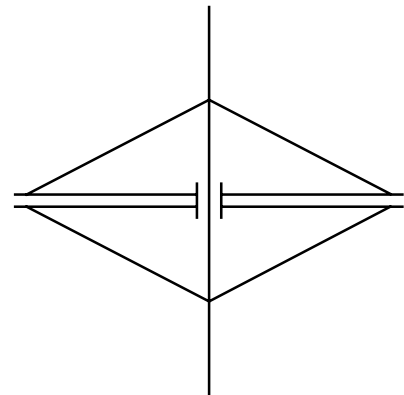

Diamond

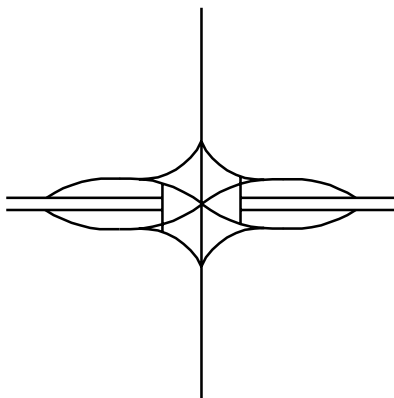

Single Point (Urban)

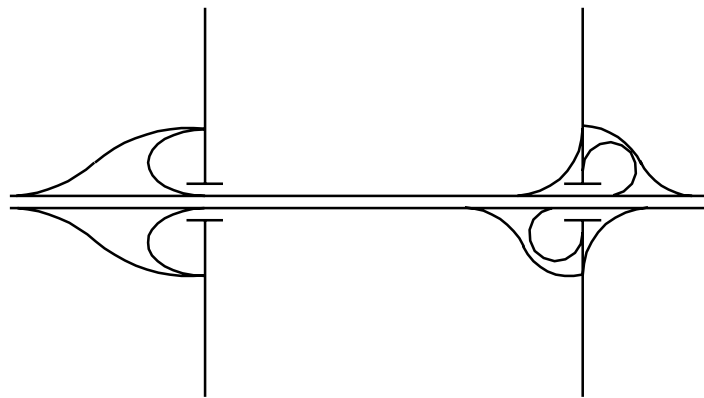

Partial Cloverleaf

**Basic Interchange Patterns**  
*Figure 940-4*

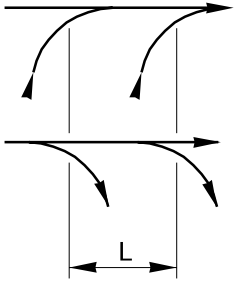
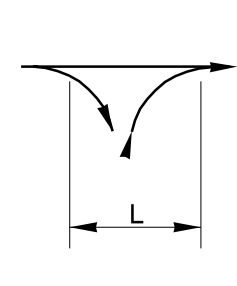
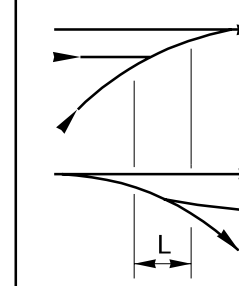
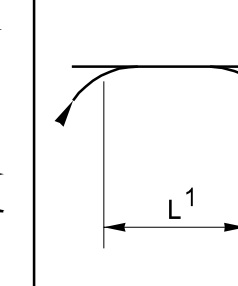
On - On or Off - Off		Off - On		Turning Roadways		On - Off (weaving)			
									
Freeway	C-D Road	Freeway	C-D Road	System <sup>2</sup> Interchange	Service <sup>3</sup> Interchange	A	B	C	D
1000	800	500	400	800	600	2000	1600	1600	1000

L = Minimum distance in feet from nose to nose. The nose is the beginning of the unpaved area within the gore for an exit and the ending of the unpaved area for an entrance.

- A Between two interchanges connected to a freeway, a system interchange<sup>2</sup> and a service interchange<sup>3</sup>.
- B Between two interchanges connected to a C-D road, a system interchange<sup>2</sup> and a service interchange<sup>3</sup>.
- C Between two interchanges connected to a freeway, both service interchanges<sup>3</sup>.
- D Between two interchanges connected to a C-D road, both service interchanges<sup>3</sup>.

Notes:

These recommendations are based on operational experience, need for flexibility, and adequate signing. Check them in accordance with Figure 940-15 and the procedures outlined in the Highway Capacity Manual and use the larger value.

- 1 With justification, these values may be reduced for cloverleaf ramps.
- 2 A system interchange is a freeway to freeway interchange.
- 3 A service interchange is a freeway to local road interchange.

### Minimum Ramp Terminal Spacing

Figure 940-5

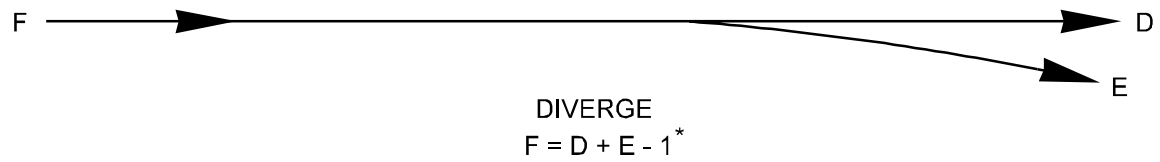
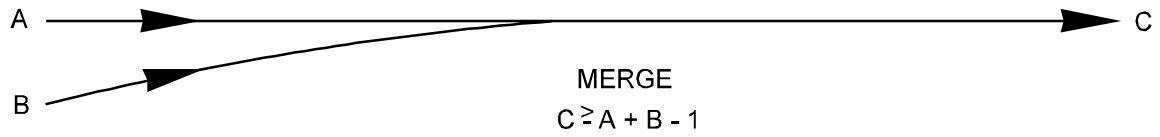

\* Number of lanes, F, may be more by one lane only, provided the lane dropped is an auxiliary lane between closely spaced entrance and exit ramps.

**Lane Balance**  
*Figure 940-6a*



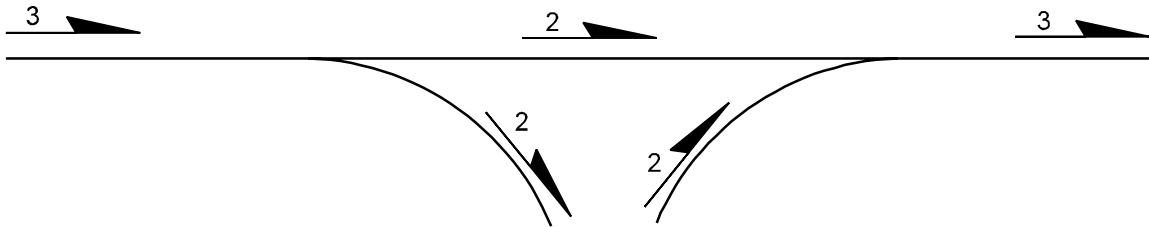

UNDESIRABLE Lane balance but no compliance with basic number of lanes.

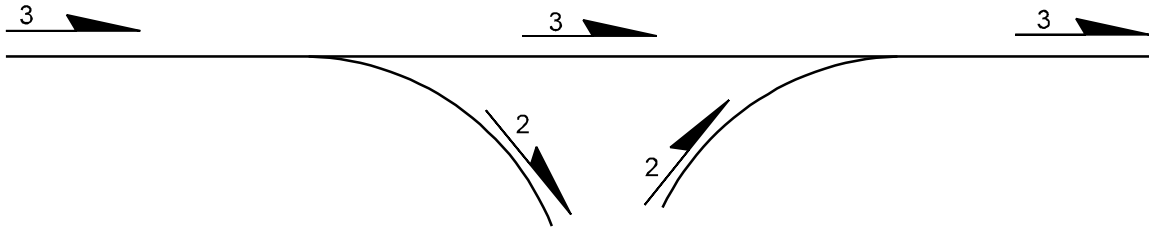

UNDESIRABLE No lane balance but compliance with basic number of lanes.

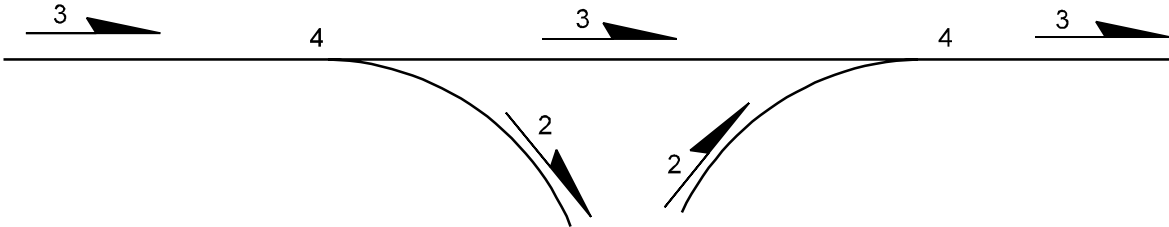

DESIRABLE Compliance with both lane balance and number of lanes.

**Lane Balance**  
*Figure 940-6b*

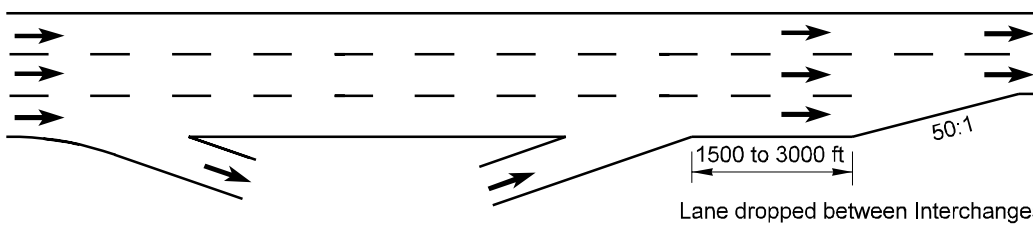
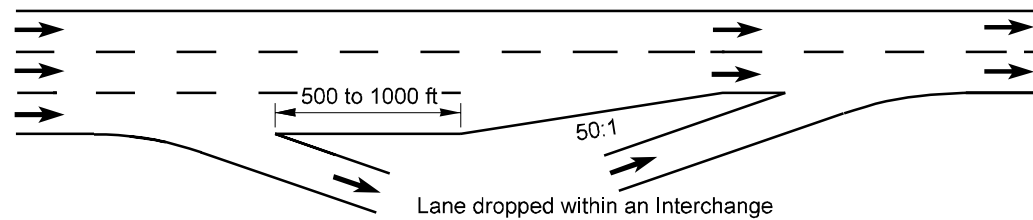
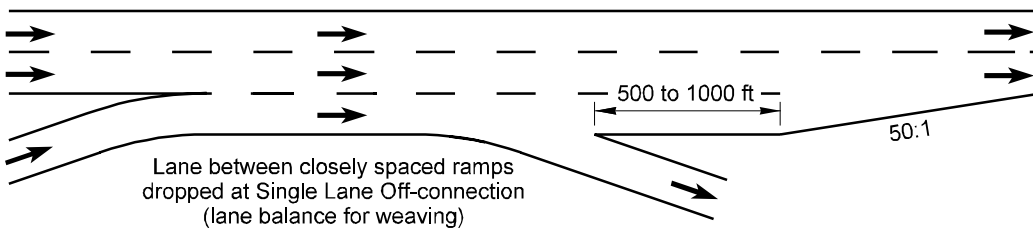
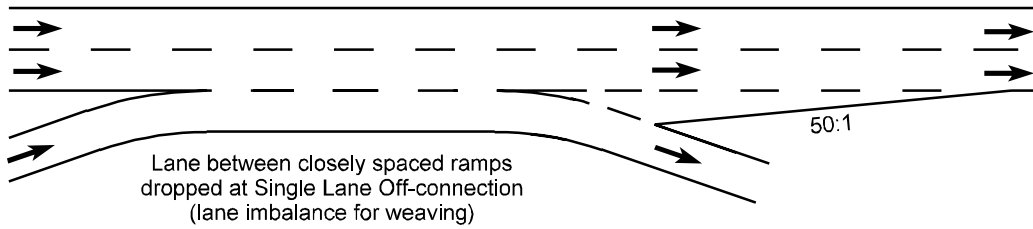
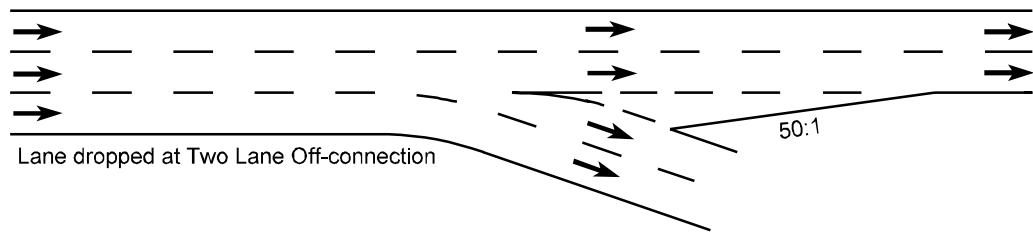

**Main Line Lane Reduction Alternatives**  
*Figure 940-7*

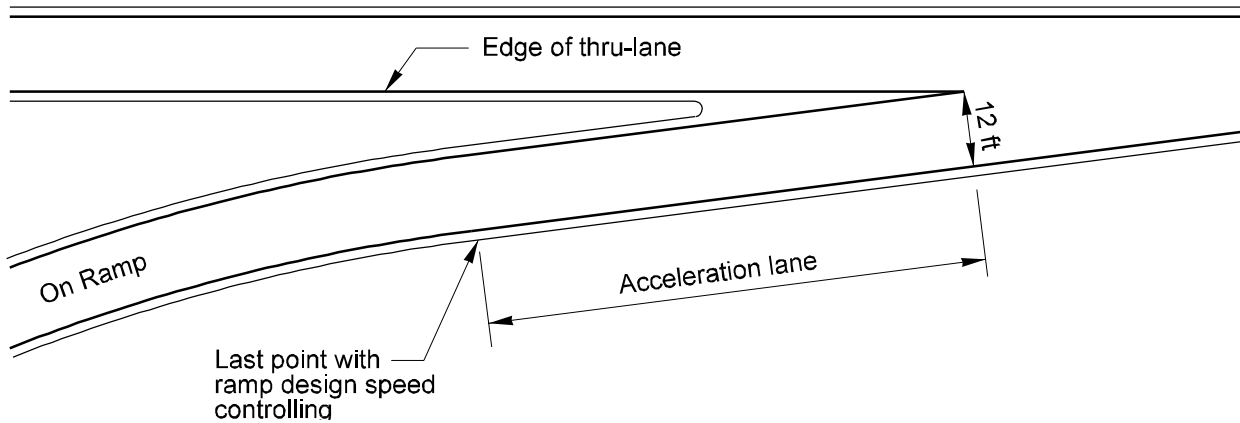

Highway Design Speed (mph)	Ramp Design Speed (mph)									
	0	15	20	25	30	35	40	45	50	60
30	180									
40	395	320	270	205						
50	640	560	510	445	345	250				
60	1115	1015	955	885	775	665	500	340	155	
70	1495	1415	1350	1280	1155	1035	860	695	510	
80	1885	1820	1755	1680	1565	1440	1265	1105	920	485

**Minimum Acceleration Lane Length (ft)**

Highway Design Speed (mph)	Grade	Up Grade				Down Grade
		Ramp Design Speed				All Ramp Design Speeds
		20	30	40	50	
40	3% to less than 5%	1.3	1.3			0.7
50		1.3	1.4	1.4		0.65
60		1.4	1.5	1.5	1.6	0.6
70		1.5	1.6	1.7	1.8	0.6
40	5% or more	1.5	1.5			0.6
50		1.5	1.7	1.9		0.55
60		1.7	1.9	2.2	2.5	0.5
70		2.0	2.2	2.6	3.0	0.5

**Adjustment Factors for Grades Greater than 3%**

**Acceleration Lane Length**

*Figure 940-8*

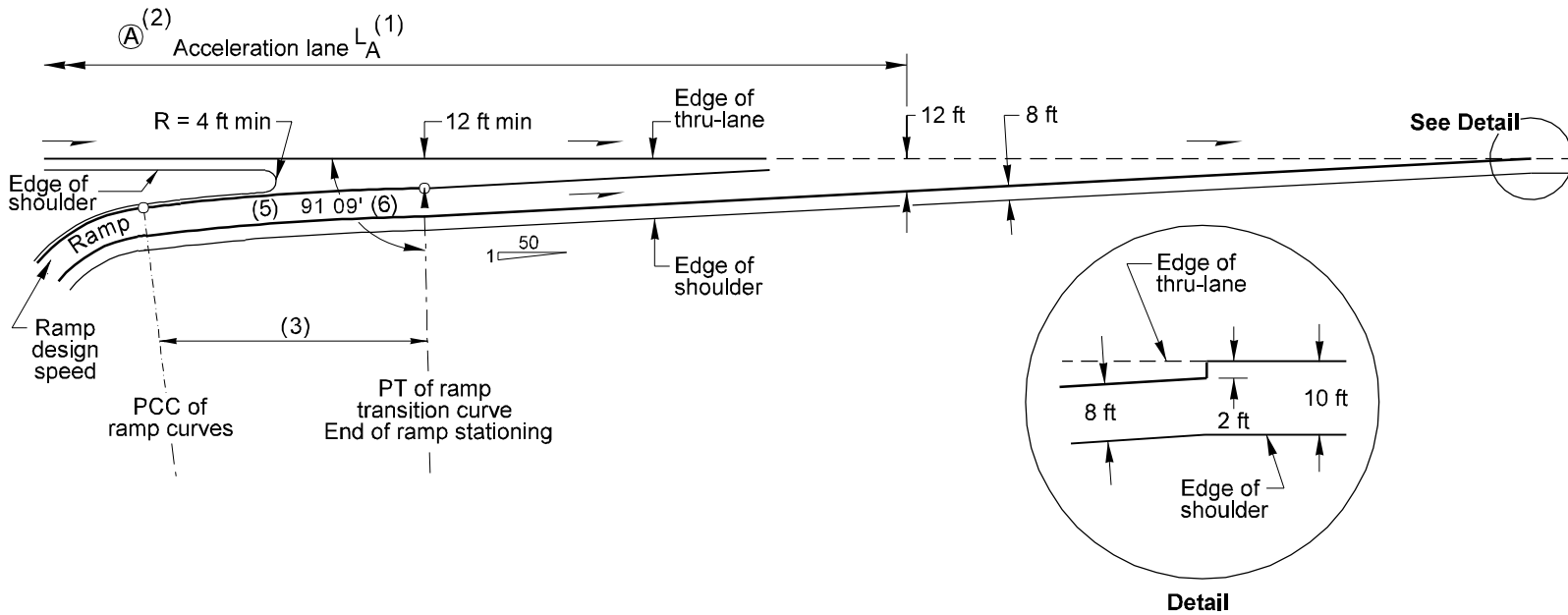

Notes:

- (1) See Figure 940-8 for acceleration lane length  $L_A$ .
- (2) Point (A) is the point controlling the ramp design speed.
- (3) A transition curve with a minimum radius of 3,000 ft is desirable. The desirable length is 300 ft. When the main line is on a curve to the left, the transition may vary from a 3,000 ft radius to tangent to the main line.
- (4) For striping, see the Standard Plans.
- (5) For ramp lane and shoulder widths, see Figure 940-3.
- (6) Approximate angle to establish ramp alignment.

**On-Connection (Single-Lane, Taper Type)**

Figure 940-9a

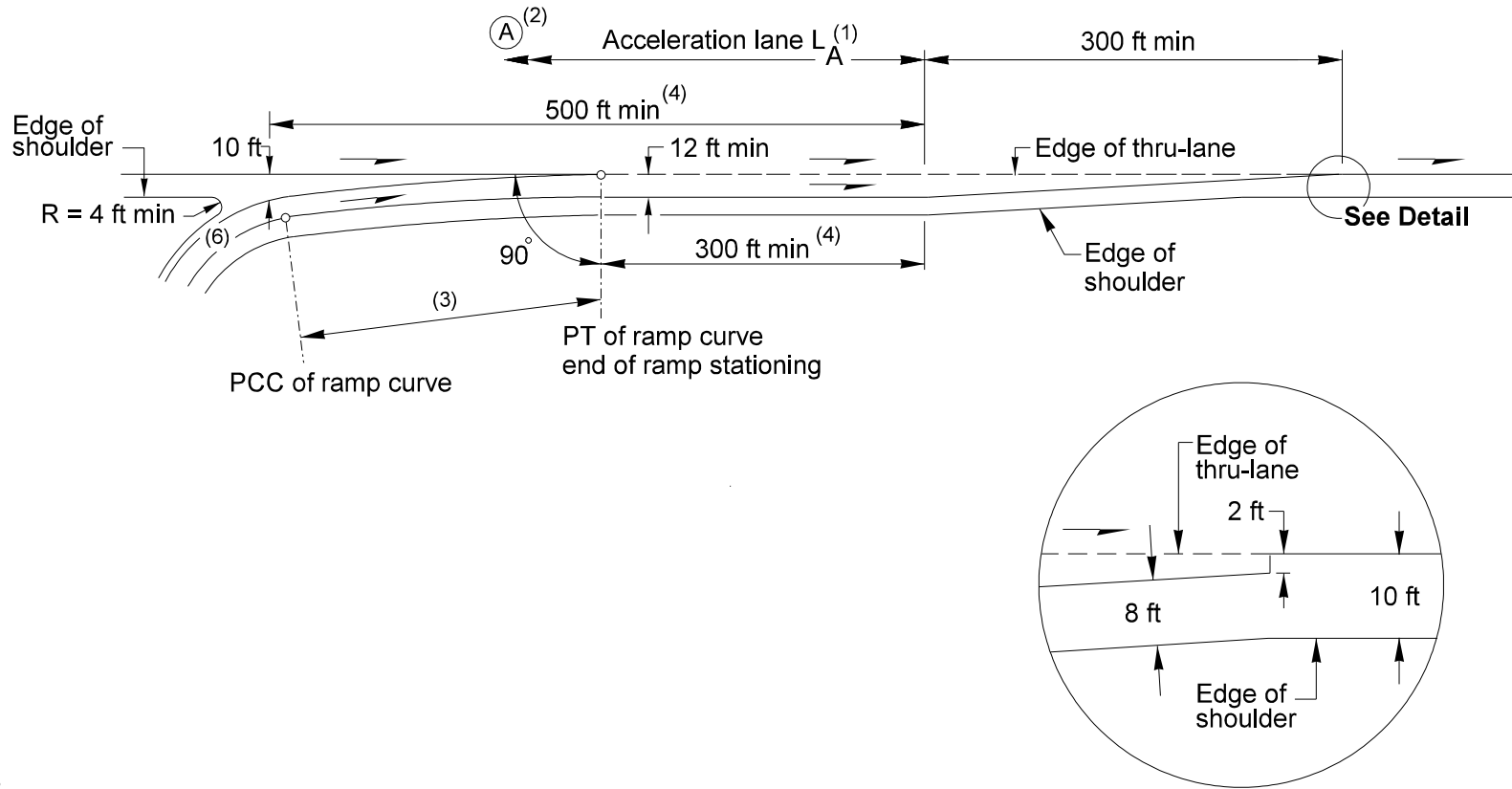

Notes:

- (1) See Figure 940-8 for acceleration lane length  $L_A$ .
- (2) Point (A) is the point controlling the ramp design speed.
- (3) A transition curve with a minimum radius of 3,000 ft is desirable. The desirable length is 300 ft. When the main line is on a curve to the left, the transition may vary from a 3,000 ft radius to tangent to the main line.
- (4) Gap acceptance length  $L_G$ .
- (5) For striping, see the Standard Plans
- (6) For ramp lane and shoulder widths, see Figure 940-3.

**On-Connection (Single-Lane, Parallel Type)**  
*Figure 940-9b*

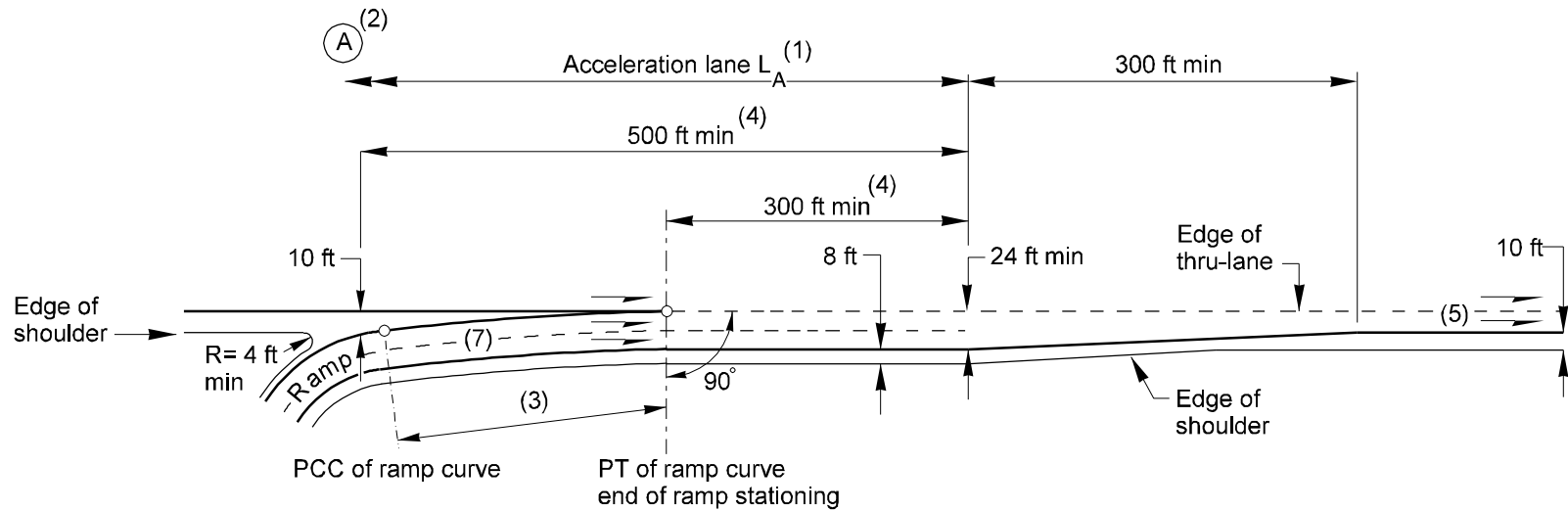

Notes:

- (1) See Figure 940-8 for acceleration lane length  $L_A$ .
- (2) Point (A) is the point controlling the ramp design speed.
- (3) A transition curve with a minimum radius of 3,000 ft is desirable. The desirable length is 300 ft. When the main line is on a curve to the left, the transition may vary from a 3,000 ft radius to tangent to the main line.
- (4) Gap acceptance length  $L_g$ .
- (5) Added lane or 1,500 ft auxiliary lane, plus 600 ft taper.
- (6) For striping, see the Standard Plans
- (7) For ramp lane and shoulder widths, see Figure 940-3.

**On-Connection (Two-Lane, Parallel Type)**  
*Figure 940-9c*

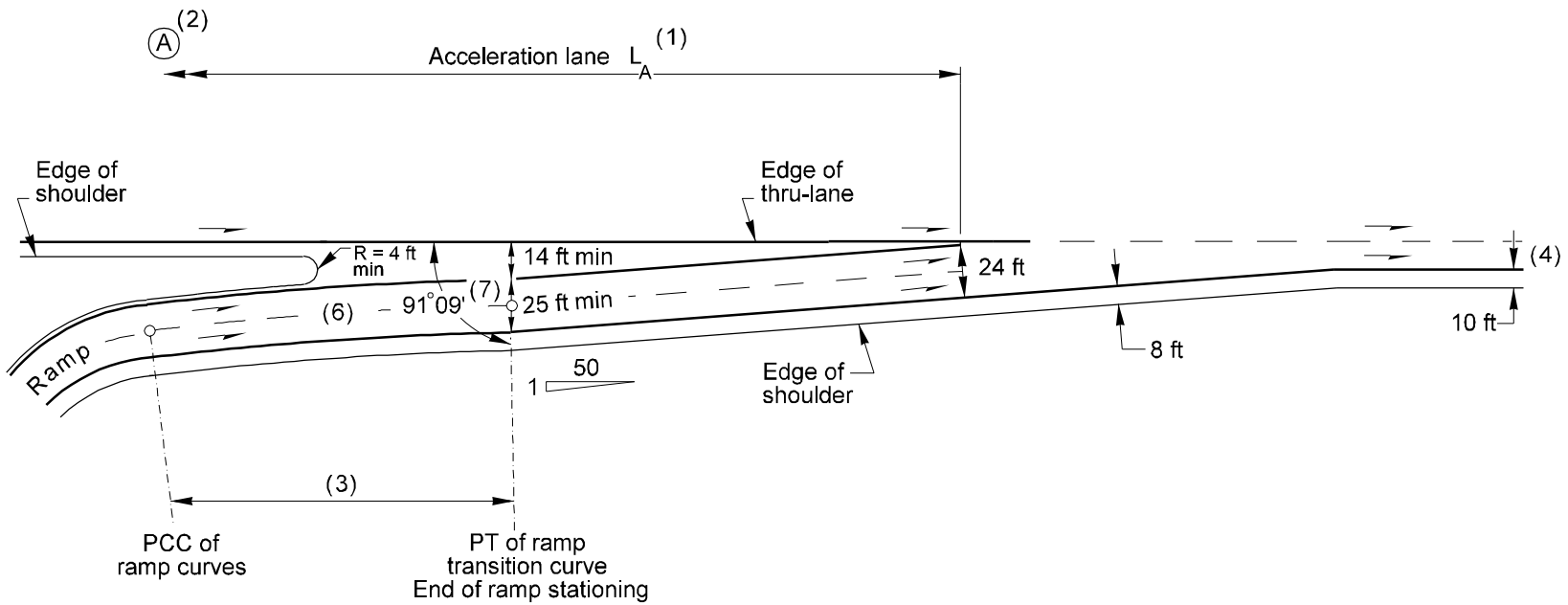

Notes:

- (1) See Figure 940-8 for acceleration lane length  $L_A$ .
- (2) Point (A) is the point controlling the ramp design speed.
- (3) A transition curve with a minimum radius of 3,000 ft is desirable. The desirable length is 300 ft. When the main line is on a curve to the left, the transition may vary from a 3,000 ft radius to tangent to the main line.
- (4) Added lane or 1,500 ft auxiliary lane, plus 600 ft taper.
- (5) For striping, see the Standard Plans
- (6) For ramp lane and shoulder widths, see Figure 940-3.
- (7) Approximate angle to establish ramp alignment.

**On-Connection (Two-Lane, Taper Type)**

Figure 940-9d

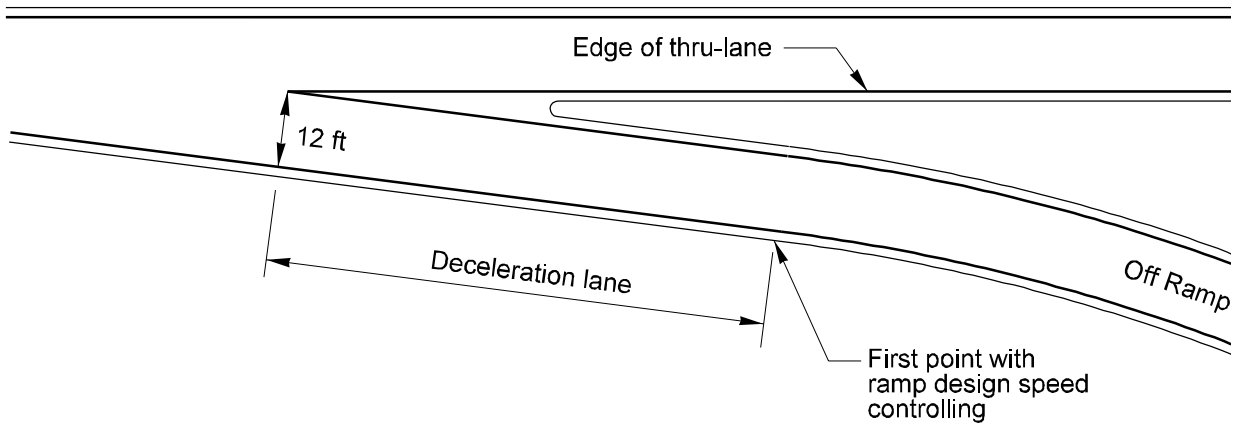

Highway Design Speed (mph)	Ramp Design Speed (mph)											
	0	15	20	25	30	35	40	45	50	60	70	
30	235	185	160									
40	335	305	275	245	195	155						
50	425	390	365	330	285	245	195					
60	530	490	470	445	410	380	335	290	250			
70	605	580	565	540	505	480	435	390	345	200		
80	710	685	675	655	620	595	550	510	470	370	290	

**Minimum Deceleration Length (ft)**

Grade	Up Grade	Down Grade
3% to less than 5%	0.9	1.2
5% or more	0.8	1.35

**Adjustment Factors for Grades Greater than 3%**

**Deceleration Lane length**

*Figure 940-10*



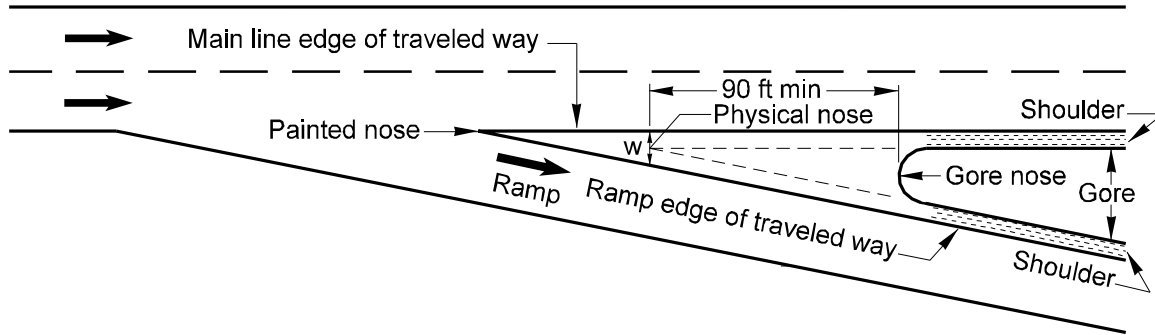

W = The sum of the main line shoulder width and the ramp shoulder width, but not less than 10 ft

**Gore Area Characteristics**  
*Figure 940-11*

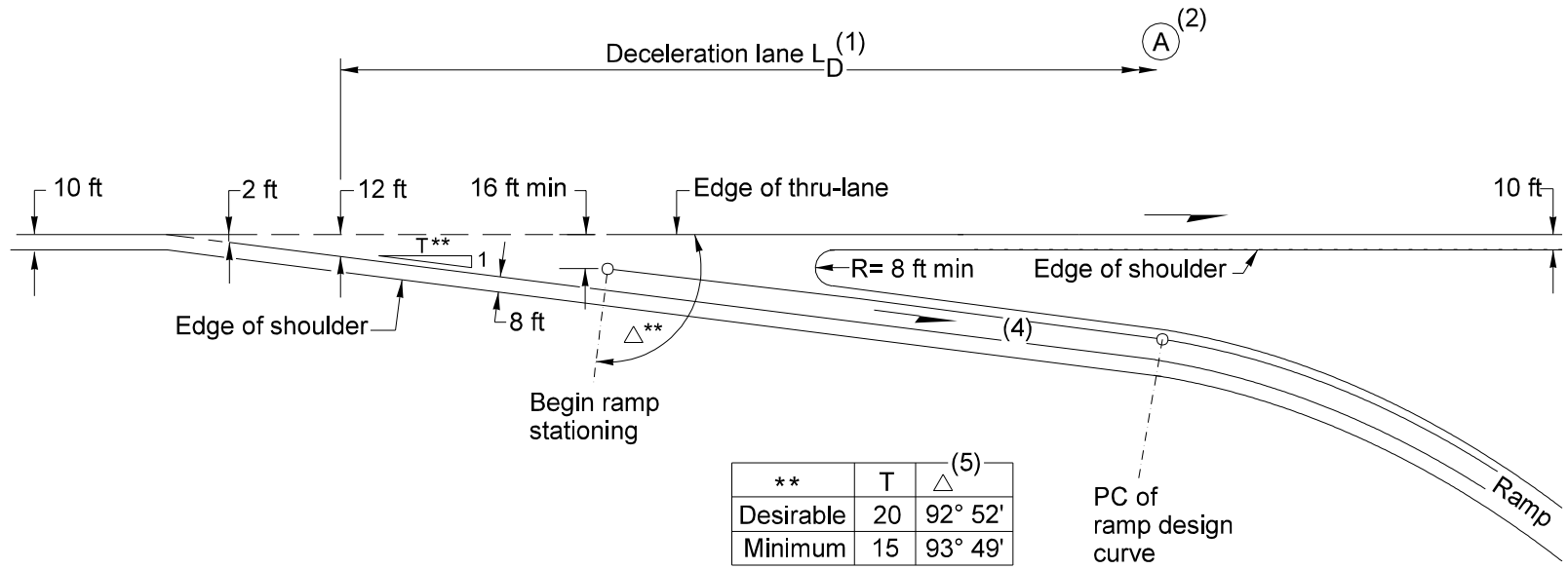

Notes:

- (1) See Figure 940-10 for deceleration lane length  $L_D$ .
- (2) Point (A) is the point controlling the ramp design speed.
- (3) For striping, see the Standard Plans
- (4) For ramp lane and shoulder widths, see Figure 940-3.
- (5) Approximate angle to establish ramp alignment.

**Off-Connection (Single-Lane, Taper Type)**  
*Figure 940-12a*

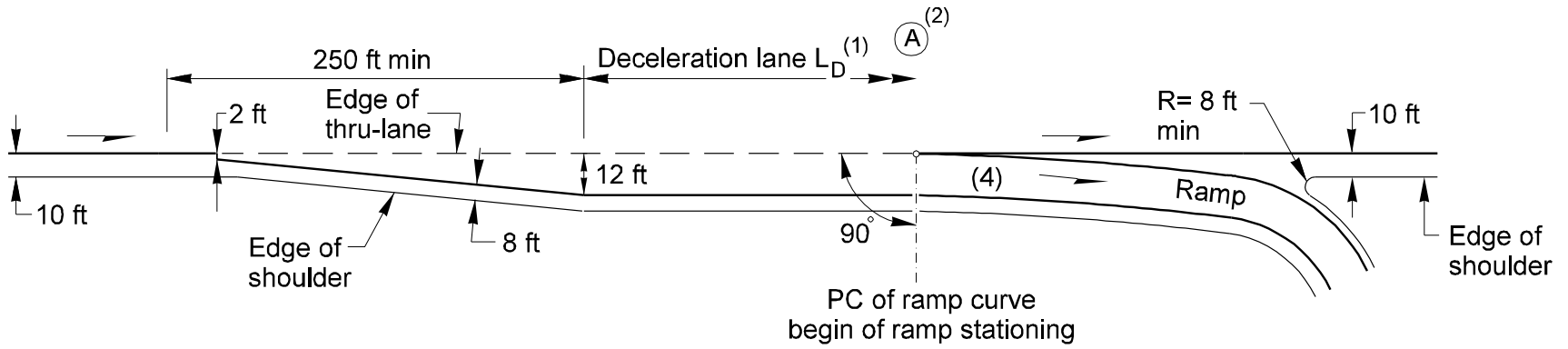

Notes:

- (1) See Figure 940-10 for deceleration lane length  $L_D$ .
- (2) Point (A) is the point controlling the ramp design speed.
- (3) For striping, see the Standard Plans.
- (4) For ramp lane and shoulder widths, see Figure 940-3.

**Off-Connection (Single Lane, Parallel Type)**

*Figure 940-12b*

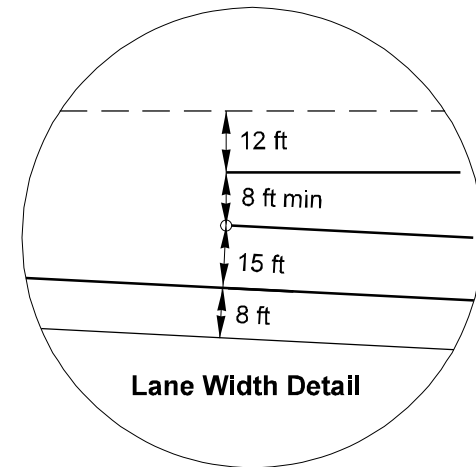
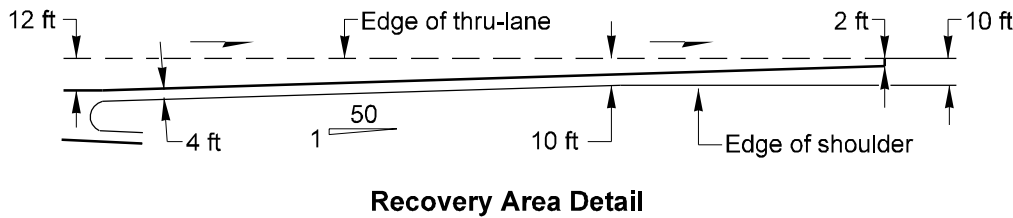
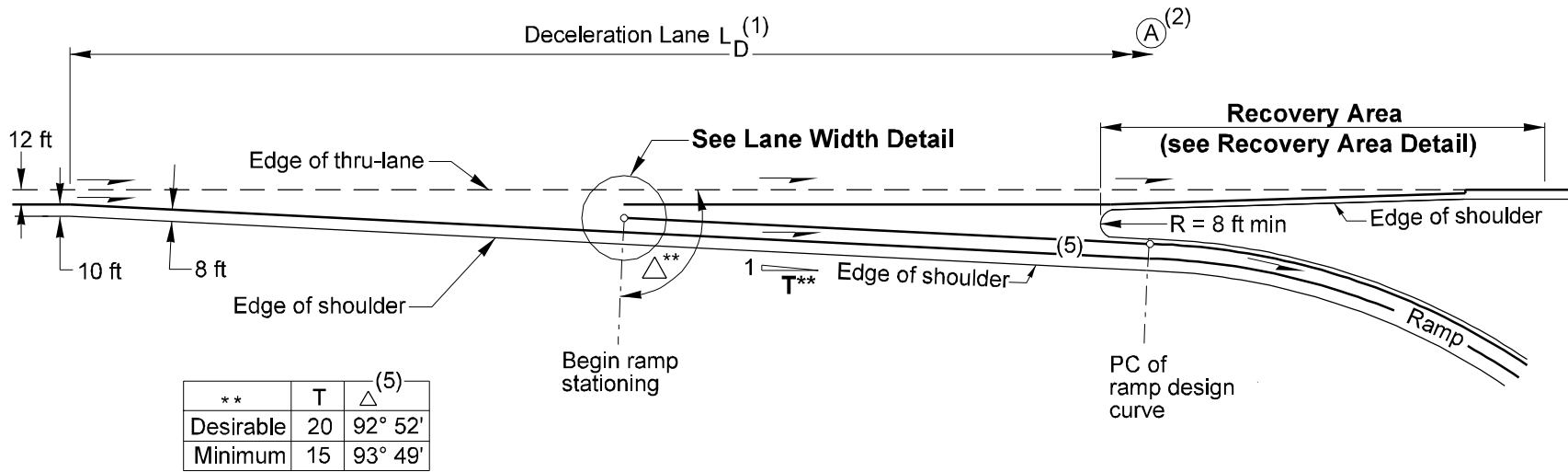

Notes:

- (1) See Figure 940-10 for deceleration lane length  $L_D$ .
- (2) Point (A) is the point controlling the ramp design speed.
- (3) Auxiliary lane between closely spaced interchanges to be dropped.
- (4) For striping, see the Standard Plans.
- (5) For ramp lane and shoulder widths, see Figure 940-3.
- (6) Approximate angle to establish ramp alignment.

**Off-Connection (Single-Lane, One-Lane Reduction)**

Figure 940-12c

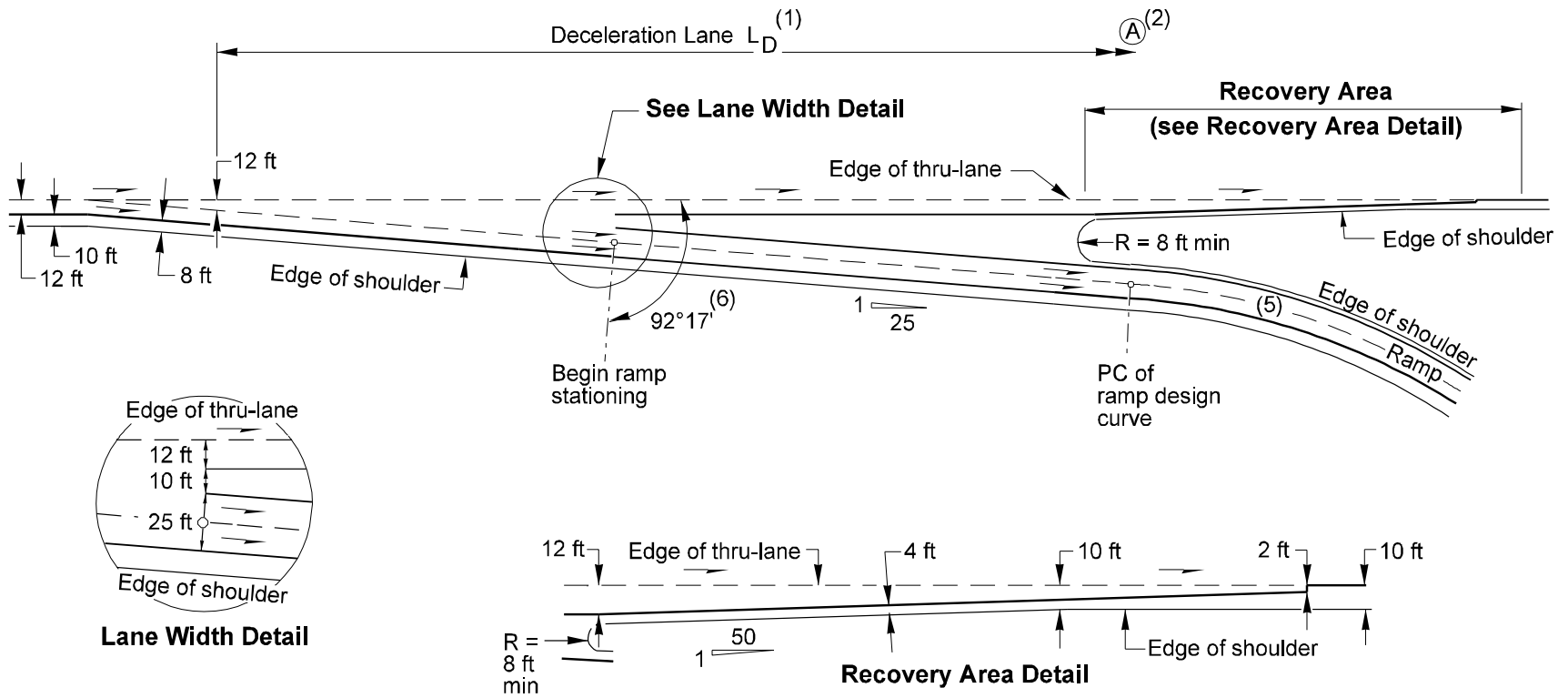

Notes:

- (1) See Figure 940-10 for deceleration lane length  $L_D$ .
- (2) Point (A) is the point controlling the ramp design speed.
- (3) Lane to be dropped or auxiliary lane with a minimum length of 1,500 ft with a 300 ft taper.
- (4) For striping, see the Standard Plans.
- (5) For ramp lane and shoulder widths, see Figure 940-3.
- (6) Approximate angle to establish ramp alignment.

**Off-Connection (Two-Lane, Taper Type)**

Figure 940-12d

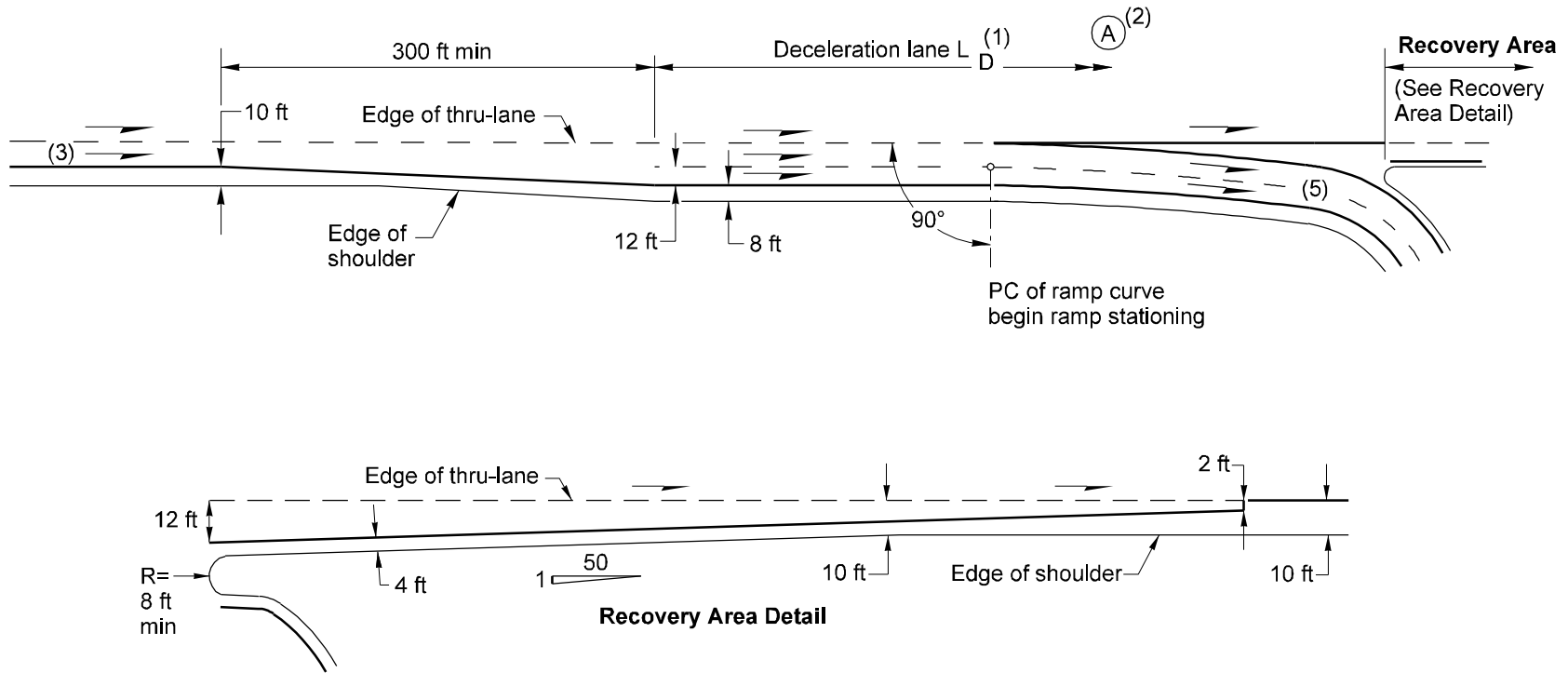

Notes:

- (1) See Figure 940-10 for deceleration lane length  $L_D$ .
- (2) Point (A) is the point controlling the ramp design speed.
- (3) Lane to be dropped or auxiliary lane with a minimum length of 1,300 ft with a 300 ft taper.
- (4) For striping, see the Standard Plans.
- (5) For ramp lane and shoulder widths, see Figure 940-3.

**Off-Connection (Two-Lane, Parallel Type)**  
*Figure 940-12e*

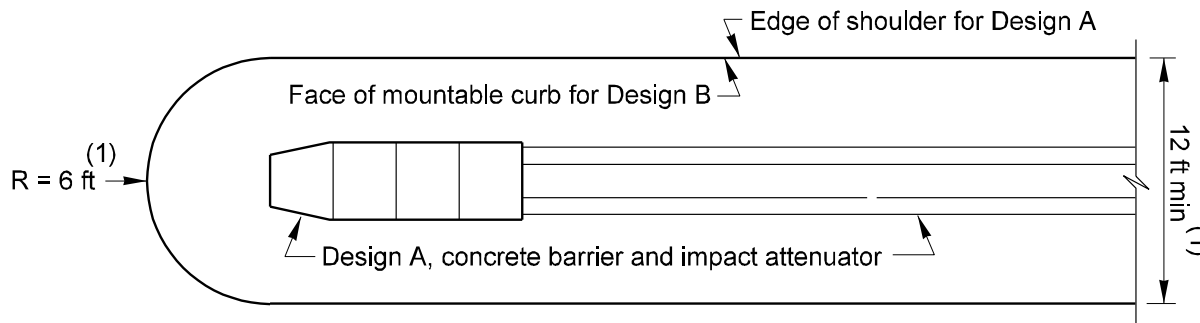
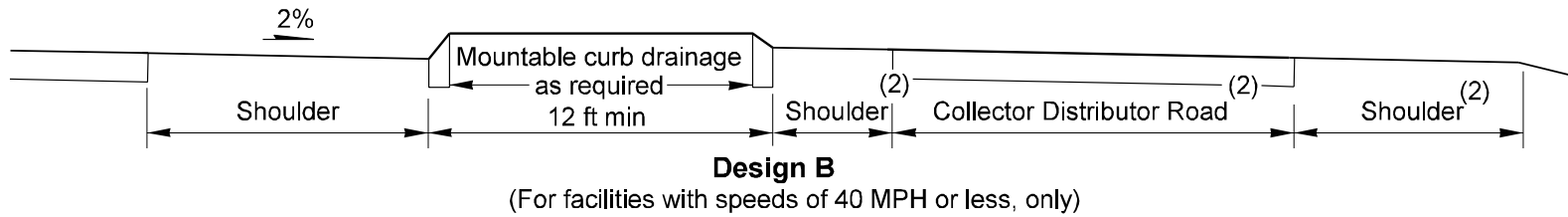
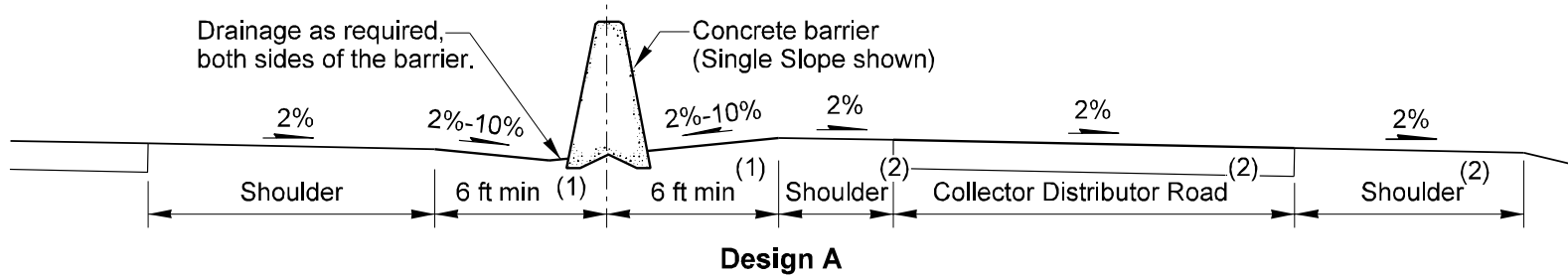

Notes:

- (1) With justification, the concrete barrier may be placed with 2 ft shy distance from the edge of either shoulder to the face of barrier. The minimum width between the edge of through-shoulder and the edge of C-D road shoulder will be reduced to 6 ft, and the radius at the nose will be reduced to 3 ft.
- (2) For collector distributor road lane and shoulder widths, see ramp lane and shoulder widths, Figure 940-3.

**Collector Distributor (Outer Separations)**  
*Figure 940-13a*

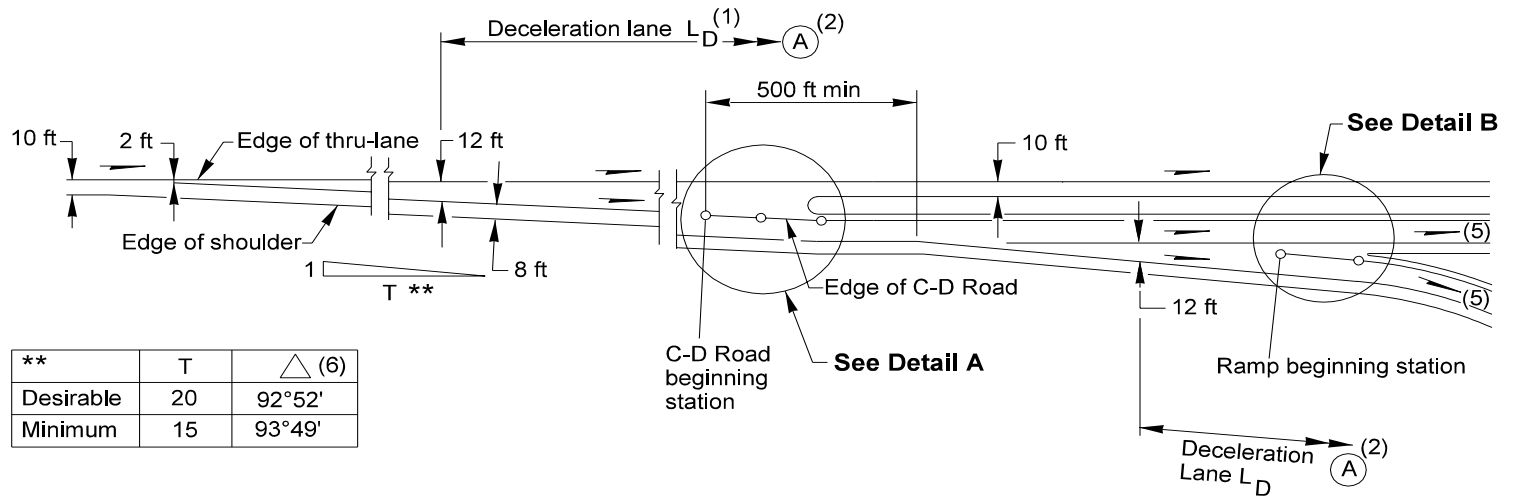

**	T	$\triangle$ (6)
Desirable	20	92°52'
Minimum	15	93°49'

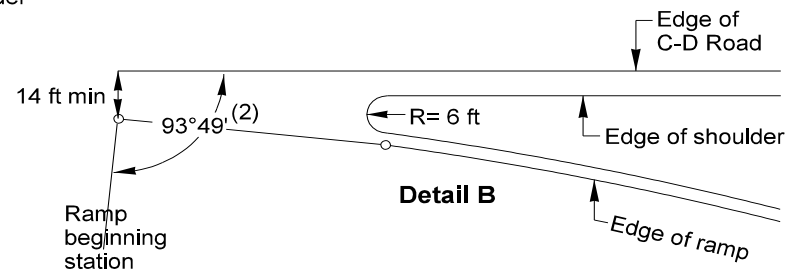
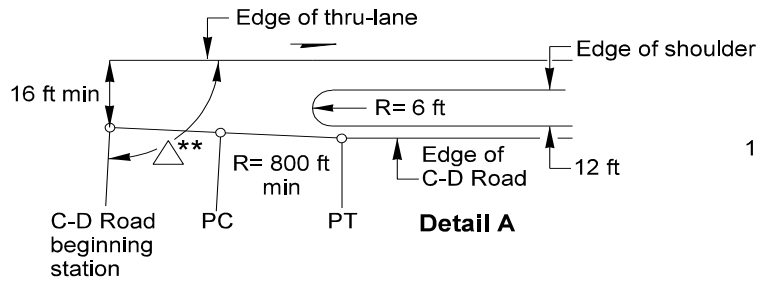

Notes:

- (1) See Figure 940-10 for deceleration lane length  $L_D$ .
- (2) Point (A) is the point controlling the ramp design speed.
- (3) For striping, see the Standard Plans.
- (4) May be reduced to 6 ft with justification.
- (5) For C-D road and ramp lane and shoulder widths, see Figure 940-3.
- (6) Approximate angle to establish alignment.

**Collector Distributor (Off-Connections)**

*Figure 940-13b*



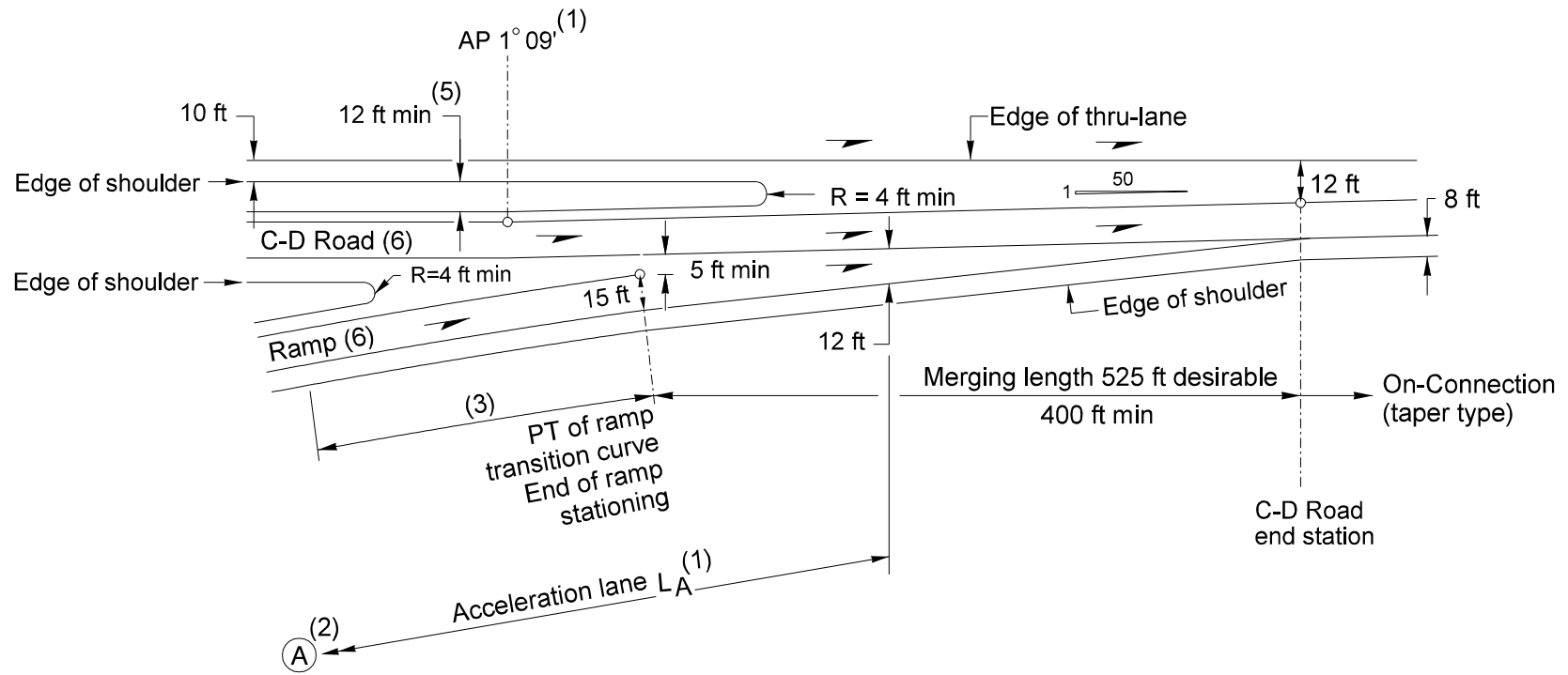

Notes:

- (1) See Figure 940-8 for acceleration lane length  $L_A$ .
- (2) Point (A) is the point controlling the ramp design speed.
- (3) A transition curve with a minimum radius of 3,000 ft is desirable. The desirable length is 300 ft. When the main line is on a curve to the left, the transition may vary from a 3,000 ft radius to tangent to the main line.
- (4) For striping, see the Standard Plans
- (5) May be reduced to 6 ft with justification.
- (6) For C-D road and ramp lane and shoulder widths, see Figure 940-3.
- (7) Approximate angle to establish alignment.

**Collector Distributor (On-Connections)**

Figure 940-13c

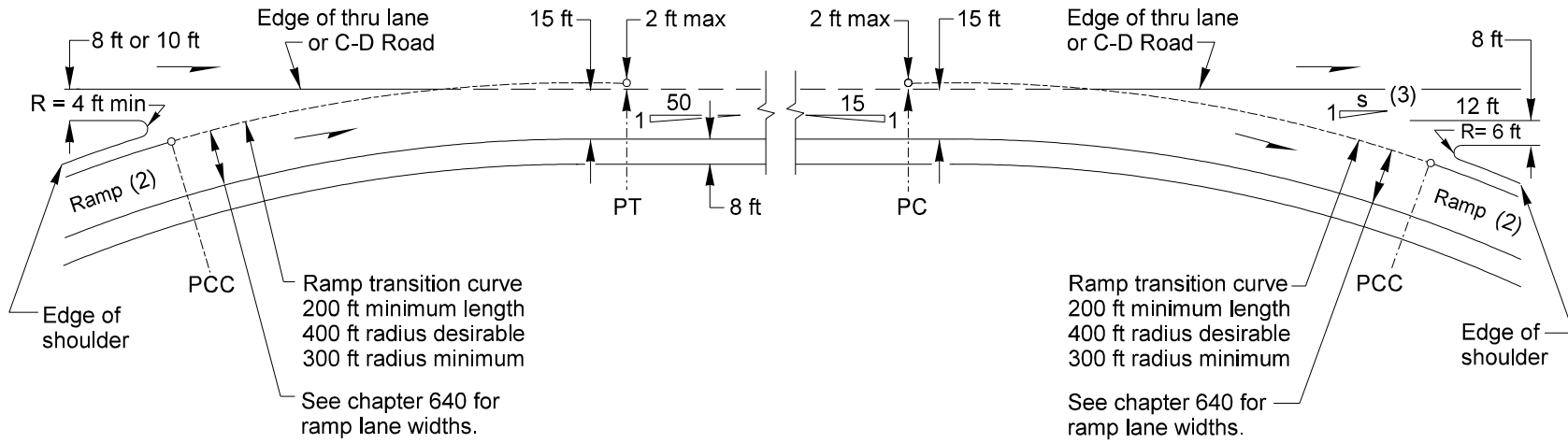

Notes:

- (1) See Figure 940-15 for required minimum weaving length.
- (2) For minimum ramp lane and shoulder widths, see Figure 940-3.
- (3) Accleration taper:
  - S = 50:1 adjacent to a freeway
  - S = 40:1 adjacent to a C-D road

**Loop Ramps Connections**  
*Figure 940-14*

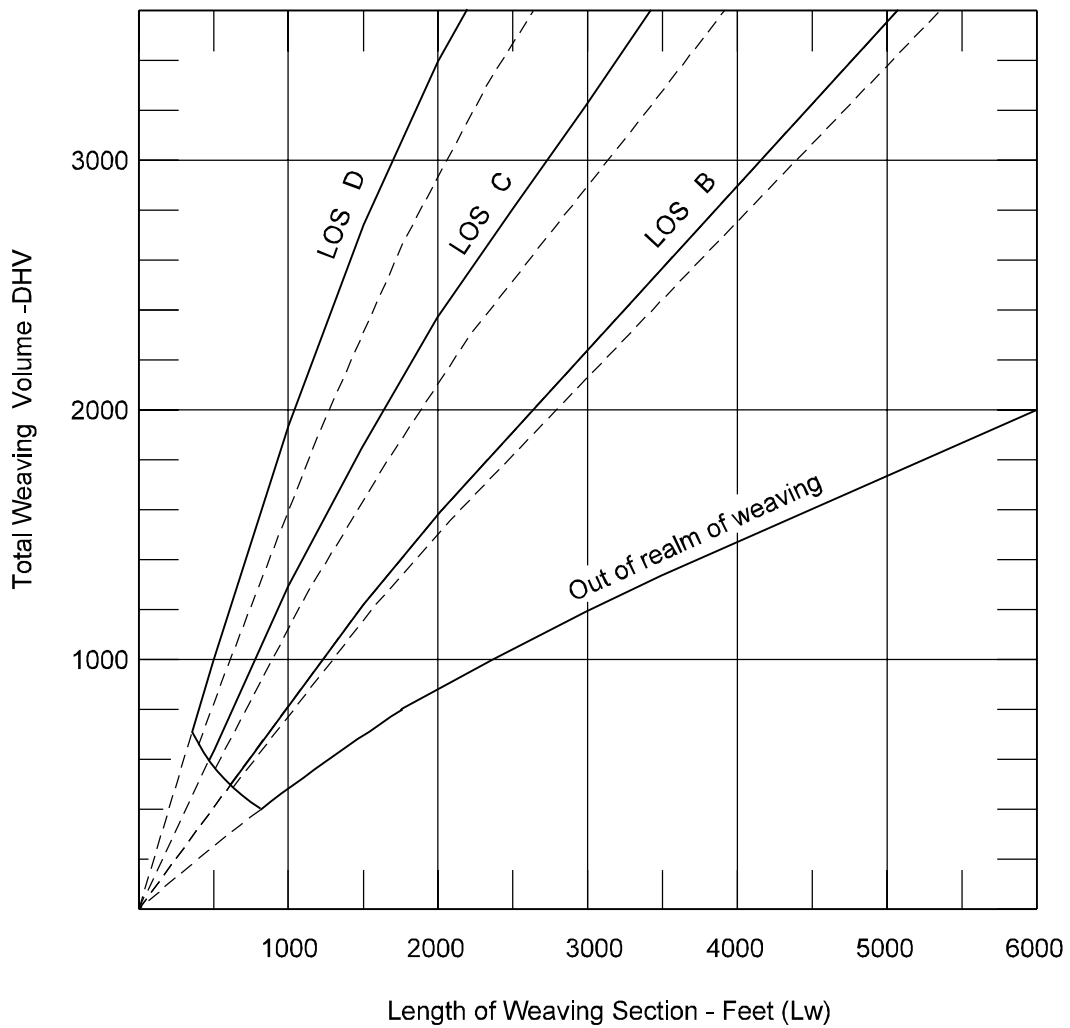
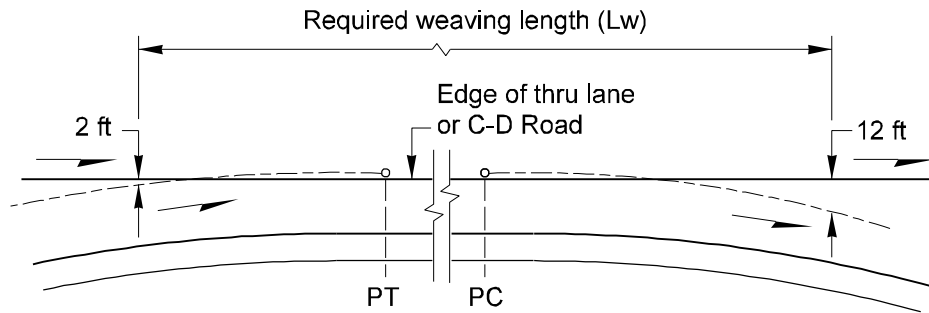

———— Lane balanced weaving sections  
 - - - - - Lane imbalanced weaving sections

See Figure 940-7 to determine whether or not lane balance exists

**Length of Weaving Sections**  
*Figure 940-15*

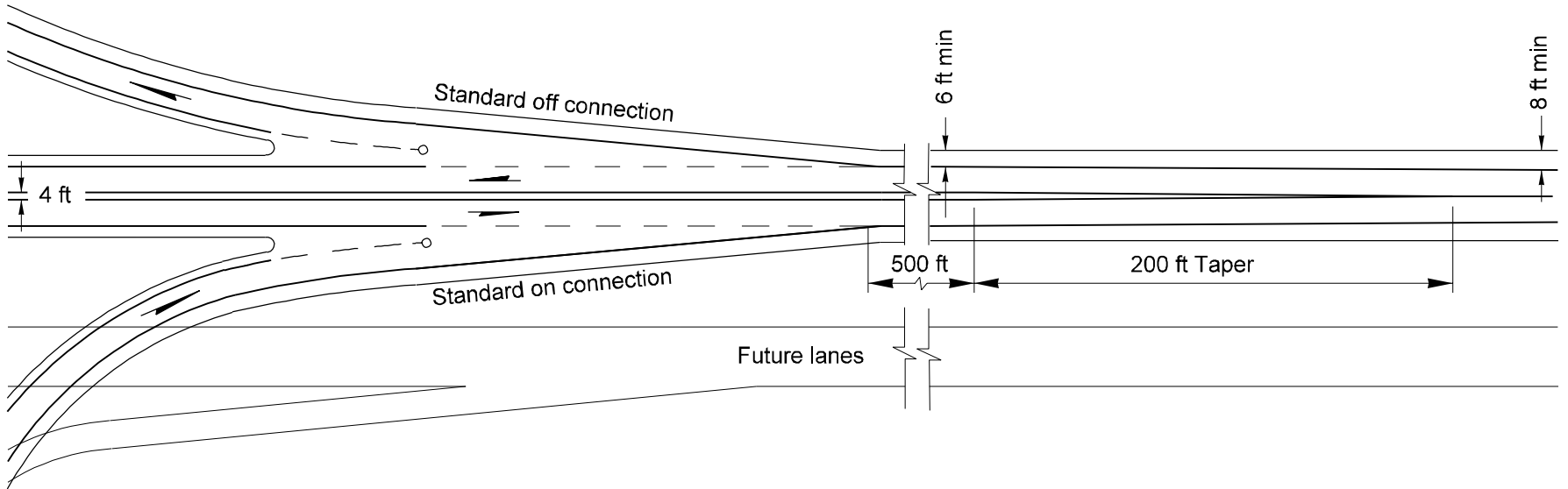

Temporary Ramps  
Figure 940-16

P. I. STATION	CURVE DATA	DELTA	RADIUS	TANGENT	LENGTH	LENGTH
EW-S 8+54.14	83°49'11" L.T.	4500.00	150.00	300.00	0.84	
EW-S 17+78.33	30°41'53" L.T.	750.00	205.87	401.84	0.05	
N-EW 20+49.42	15°00'00" RT.	75.00	4.87	14.64	-----	
R/W N-EW 22+88.38	55°00'00" LT.	450.00	234.26	431.97		
N-EW 23+63.37	40°00'00" RT.	412.68	150.20	288.11	0.06	
N-EW 32+88.06	30°16'32" LT.	1600.00	432.85	845.45	0.05	
S-EW 11+68.99	24°08'24" RT.	892.91	197.74	389.19	0.05	
S-EW 17+78.48	30°51'30" L.T.	311.80	118.80	211.58	0.05	
S-EW 19+53.87	5°00'00" L.T.	75.00	3.28	6.55	-----	
R/W S-EW 11+61.10	36°29'56" RT.	600.00	197.84	382.22		
R/W S-EW 18+86.28	55°23'00" LT.	450.00	235.17	434.98		
EW-N 26+02.65	11°11'50" RT.	2800.00	196.87	398.80	0.05	
HR 2+50.00	68°00'00" LT.	400.00	238.94	418.88	0.06	
HR 7+46.86	19°39'00" RT.	1000.00	173.18	342.96	0.05	
LL 30+08.24	25°13'18" L.T.	1546.00	283.15	2495.38	0.04	
LR 36+99.83	25°13'18" L.T.	1573.00	281.44	2522.35	0.04	

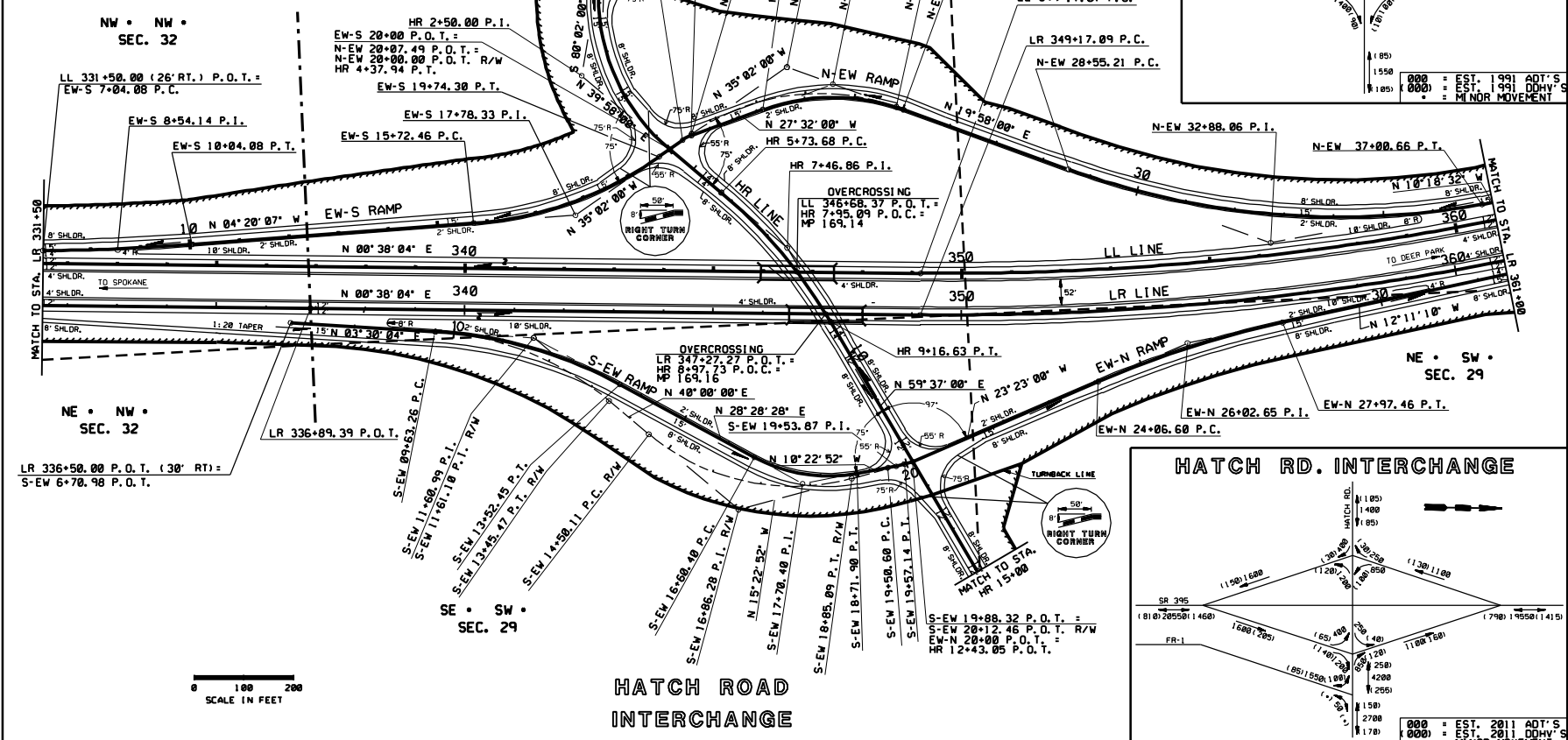

SCALE IN FEET  
0 100 200

DESIGNED BY G. WAGEMANN	REGION 10	STATE WASH	FED. AID PROJ. NO.	PROGRAM DEVELOPMENT DIVISION	Washington State Department of Transportation	HATCH RD. INTERCHANGE MP 109.15	SHEET OF 1
ENTERED BY SPIES/BURKE	JOB NUMBER	CONTRACT NO.	DATE	REVISION	DATE	BY	

Interchange Plan  
Figure 940-17

- 960.01 General
- 960.02 Analysis
- 960.03 Design
- 960.04 Approval
- 960.05 Documentation

### 960.01 General

Median crossovers are provided at selected locations on divided highways for crossing by maintenance, traffic service, emergency, and law enforcement vehicles. Crossovers may be provided:

- Where they appear on the master plan of crossovers for the corridor
- Where analysis demonstrates that access through interchanges or intersections is not practical
- As part of a law-enforcement plan

This chapter provides guidance for locating and designing median openings not located at an intersection and for which use is restricted to maintenance, traffic service, emergency, and law enforcement vehicles. For median openings to provide unrestricted U-turns to allow public access to both sides of the roadway, see Chapter 910, Intersections At Grade.

### 960.02 Analysis

A list of existing and preapproved median crossovers is available from the Transportation Data Office of the Planning and Programming Service Center.

Two general categories of vehicles are recognized as legitimate users of median crossovers. One category is law enforcement vehicles and the other is governmental services vehicles (emergency, traffic service, and maintenance vehicles).

In an urban area with a high occupancy vehicle lane adjacent to the median, crossovers may be used in conjunction with law enforcement observation points, and downstream enforcement (widened shoulder) areas, as part of the law enforcement plan.

In other urban areas and in rural areas, crossovers may be necessary to a law enforcement plan.

A crossover that is primarily for governmental service vehicles may be justified on the basis that access through interchanges or intersections is not practical. In urban areas where there are 3 or more miles between access points, providing an unobtrusive crossover may improve emergency service or improve efficiency for traffic service and maintenance forces.

Locate rural crossovers 3 or more miles from an interchange.

Where crossovers are justified and used for winter maintenance operations such as snow and ice removal, the interchange or intersection spacing rule does not apply and the distance from the ramp merge or diverge points may be decreased to a 500-ft minimum with 1,000 ft the desirable minimum.

Minimize visibility of the crossover to the traveling public.

### 960.03 Design

Consider the following design criteria for all median crossovers. However, taking into consideration the intended vehicle usage, some of the criteria may not apply to crossovers intended primarily for enforcement.

- Adequate median width at the crossover location is required to allow the design vehicle to complete a U-turn maneuver without encroaching within 8 ft of the traffic lanes, and without backing. The common design vehicles for this determination are a passenger car and a single unit truck depending upon the intended use of the crossover. Generally the minimum recommended median width is 40 ft.
- Use grades and radii that are suitable for all authorized user vehicles.
- Provide adequate inside shoulders to allow vehicle deceleration and acceleration to occur off the traffic lanes. Ten-foot inside

shoulders are adequate for most cases. Provide full 10-foot shoulders for a distance of 450 ft upstream of the crossover area to accommodate deceleration, and extend downstream of the crossover area for a distance of 600 ft to allow acceleration prior to entering the traffic lane.

- Provide adequate stopping sight distance for vehicles approaching the crossover area. Because of the unexpected maneuvers associated with these inside access points and higher operating speeds commonly experienced in the inside traffic lanes, use conservative values for stopping sight distance. (See the Roadside Classification Plan.)
- Use side slopes of the crossing no steeper than 10H:1V. Grade for a relatively flat and gently contoured appearance that is inconspicuous to the public.
- Do not use curbs or pavement markings.
- Flexible guide posts may be provided for night reference. (See the standard plans.)
- Consider the terrain and locate the crossover to minimize visibility to the public.
- Vegetation may be used to minimize visibility. Low vegetation, with a 3-ft year-round maximum height is recommended for this purpose. (See Chapter 1300).
- In locations where vegetation cannot be used to minimize visibility and there is a high incidence of unauthorized use, appropriate signing ( No U-Turns) may be used to discourage unauthorized use.

A stabilized all-weather surface is required. Urban crossovers for a high occupancy vehicle enforcement plan are usually paved. Other urban crossovers may be paved if unauthorized use is minimized. Rural crossovers are not usually paved in order to be inconspicuous.

## 960.04 Approval

All existing and planned crossover locations will be designated on a corridor or regional Master Plan for Median Crossovers. A committee consisting of the Assistant Regional Administrator for Operations or Project Development, the Washington State Patrol Assistant District Commander, the Olympia Service Center Access Engineer and the FHWA Safety and Operations Engineer or equivalents will be responsible for establishing and updating this plan yearly with proposed new crossings and removal of crossings that are no longer necessary.

Regional Administrators are responsible for the design and construction of median crossovers. Prior to construction of the opening, submit the documentation of crossover and the design data (together with a right-of-way print showing the opening in red) to the State Design Engineer for right of way or limited access plan approval. Construction should not proceed until approval is received.

After notification of approval, the Olympic Service Center (OSC) Right of Way Plans Section sends the region a revised reproducible right-of-way or limited access plan which includes the approved crossover location.

## 960.05 Documentation

- Applicable Master Plan for Median Crossovers
- Right of way or limited access plans showing approved median crossovers and supporting documents

P65:DP/DM9

1010.01	General
1010.02	References
1010.03	Definitions
1010.04	Climbing Lanes
1010.05	Passing Lanes
1010.06	Slow Moving Vehicle Turnouts
1010.07	Shoulder Driving for Slow Vehicles
1010.08	Emergency Escape Ramps
1010.09	Chain-Up Areas
1010.10	Documentation

### 1010.01 General

Auxiliary lanes are used to comply with capacity requirements; to maintain lane balance; to accommodate speed change, weaving, and maneuvering for entering and exiting traffic; or to encourage carpools, vanpools, and the use of transit.

See the Traffic Manual and the MUTCD for signing of auxiliary lanes.

Although slow vehicle turnouts, shoulder driving for slow vehicles, and chain-up areas are not auxiliary lanes they are covered in this chapter because they perform a similar function.

See the following chapters for additional information:

Chapter	Subject
910	Turn lanes
910	Speed change lanes at intersections
940	Speed change lanes at interchanges
940	Collector distributor roads
940	Weaving lanes
1050	High occupancy vehicle lanes

### 1010.02 References

*Revised Code of Washington (RCW) 46.61, Rules of the Road.*

*Manual on Uniform Traffic Control Devices for Streets and Highways (MUTCD), USDOT, FHWA; including the Washington State Modifications to the MUTCD, M 24-01. WSDOT*

*Traffic Manual, M 51-02, WSDOT.*

*A Policy on Geometric Design of Highways and Streets (Green Book), AASHTO, 1994*

*Emergency Escape Ramps for Runaway Heavy Vehicles, FHWA-T5-79-201, March 1978*

*Highway Capacity Manual (Special Report 209), Transportation Research Board*

*NCHRP Synthesis 178, Truck Escape Ramps, Transportation Research Board*

### 1010.03 Definitions

**auxiliary lane** The portion of the roadway adjoining the through lanes for parking, speed change, turning, storage for turning, weaving, truck climbing, passing, and other purposes supplementary to through-traffic movement.

**climbing lane** An auxiliary lane used for the diversion of slow traffic from the through lane.

**emergency escape ramp** A roadway leaving the main roadway designed for the purpose of slowing and stopping out-of-control vehicles away from the main traffic stream.

**lane** A strip of roadway used for a single line of vehicles.

**lateral clearance** The distance from the edge of traveled way to a roadside object.

**posted speed** The maximum legal speed as posted on a section of highway using regulatory signs.

**passing lane** An auxiliary lane on a two-lane highway used to provide the desired frequency of safe passing zones.

**roadway** The portion of a highway, including shoulders, for vehicular use. A divided highway has two or more roadways.

**shoulder** The portion of the roadway contiguous with the traveled way, primarily for accommodation of stopped vehicles, emergency use, lateral support of the traveled way, and use by pedestrians and bicycles.



**slow moving vehicle turnouts** A widened shoulder area to provide room for a slow moving vehicle to pull safely out of the through traffic, allow vehicles following to pass, and return to the through lane.

**traveled way** The portion of the roadway intended for the movement of vehicles, exclusive of shoulders and lanes for parking, turning, and storage for turning.

## 1010.04 Climbing Lanes

### (1) General

Normally, climbing lanes are associated with truck traffic, but they may also be considered in recreational or other areas that are subject to slow moving traffic. Climbing lanes are designed independently for each direction of travel.

Generally, climbing lanes are provided when the requirements of two warrants - speed reduction and level of service - are exceeded. The requirements of either warrant may be waived if, for example, slow moving traffic is demonstrably causing a high accident rate or congestion that could be corrected by the addition of a climbing lane. However, under most conditions climbing lanes are built when the requirements of both warrants are satisfied.

### (2) Warrant No. 1 — Speed Reduction

Figure 1010-2a shows how the percent and length of grade affect vehicle speeds. The data is based on a typical heavy truck.

The maximum allowable entrance speed, as reflected on the graphs, is 55 mph. Note that this is the maximum value to be used regardless of the posted speed of the highway. When the posted speed is above 55 mph, use 55 mph in place of the posted speed. Examine the profile at least  $\frac{1}{4}$  mi preceding the grade to obtain a reasonable approach speed.

If a vertical curve makes up part of the length of grade, approximate the equivalent uniform grade length.

Whenever the gradient causes a 15 mph speed reduction below the posted speed limit for typical heavy truck for either two-lane or multilane highways, the speed reduction warrant is satisfied (see Figure 1010-2b for an example).

### (3) Warrant No. 2 — Level of Service (LOS)

The level of service warrant for two-lane highways is fulfilled when the up-grade traffic volume exceeds 200 VPH and the up-grade truck volume exceeds 20 VPH. On multilane highways, use Figure 1010-3.

### (4) Design

When a climbing lane is justified, design it in accordance with Figure 1010-4. Provide signing and delineation to identify the presence of the auxiliary lane. Begin climbing lanes at the point where the speed reduction warrant is met and end them where the warrant ends for multilane and 300 ft beyond for 2-lane highways. Consider extending the auxiliary lane over the crest to improve vehicle acceleration and the sight distance.

Design climbing lane width equal to that of the adjoining through lane and at the same cross slope as the adjoining lanes. When ever possible, maintain the shoulders at standard width for the class of highway. However, on two-way two-lane highways, the shoulder may be reduced to 4 ft with justification.

## 1010.05 Passing Lanes

### (1) General

Passing lanes are desirable where a sufficient number and length of safe passing zones do not exist and the speed reduction warrant for a climbing lane is not satisfied. Figure 1010-5 may be used to determine if a passing lane is recommended.

### (2) Design

When a passing lane is justified, design it in accordance with Figure 1010-6. Make the lane long enough to permit several vehicles to pass. Passing lanes longer than 2 mi can cause the driver to lose the sense that the highway is basically a two-lane facility.

Passing lanes are preferably four-lane sections.

A three-lane section may be used, however. Alternate the direction of the passing lane at short intervals to ensure passing opportunities for both directions and to discourage illegal actions of frustrated drivers.

Make the passing lane width equal to the adjoining through lane and at the same cross slope. Full-width shoulders for the highway class are preferred; however, with justification, the shoulders may be reduced to 4 ft. Provide adequate signing and delineation to identify the presence of an auxiliary lane.

## **1010.06 Slow Moving Vehicle Turnouts**

### **(1) General**

On a two-lane highway where passing is unsafe, a slow moving vehicle is required, by RCW 46.61.427, to turn off the through lane wherever a safe turnout exists, in order to permit the following vehicles to proceed. A slow moving vehicle is one that is traveling at a speed less than the normal flow of traffic, behind which five or more vehicles are formed in a line.

A slow moving vehicle turnout is not an auxiliary lane. Its purpose is to provide sufficient room for a slow moving vehicle to safely pull out of through traffic and stop if necessary, allow vehicles following to pass, then return to the through lane. Generally, a slow moving vehicle turnout is provided on existing roadways where passing opportunities are limited, where slow moving vehicles such as trucks and recreational vehicles are predominant, and where the cost to provide a full auxiliary lane would be prohibitive.

### **(2) Design**

Base the design of a slow moving vehicle turnout primarily on sound engineering judgment and Figure 1010-7. Design may vary from one location to another. A minimum length of 100 ft provides adequate storage, since additional storage is provided within the tapers and shoulders. The maximum length is  $\frac{1}{4}$  mi including tapers. Surface turnouts with a stable unyielding material such as BST or ACP with adequate structural strength to support the heavier traffic.

Locate slow vehicle turnouts where at least Design Stopping Sight Distance (Chapter 650) is available, decision sight distance is preferred, so that vehicles can safely reenter the through traffic. Sign slow moving vehicle turnouts to identify their presence.

When a slow moving vehicle turnout is to be built, document the location and why it was selected.

## **1010.07 Shoulder Driving for Slow Vehicles**

### **(1) General**

For projects where climbing or passing lanes are justified, but are not within the scope of the project, or where meeting the warrants for these lanes are borderline, the use of a shoulder driving section is an alternative.

Review the following when considering a shoulder driving section:

- Horizontal and vertical alignment
- Character of traffic
- Presence of bicycles
- Clear zone (Chapter 700)

### **(2) Design**

When designing a shoulder for shoulder driving, use a minimum length of 600 ft. The minimum shoulder width is 8 ft with 10 ft preferred. When barrier is present, the minimum width is 10 ft with 12 ft preferred. Adequate structural strength for the anticipated traffic is necessary and may require reconstruction. Select locations where the side slope meets the requirements of Chapter 640 for new construction and Chapter 430 for existing roadways. When a transition is required at the end of a shoulder driving section, use a 50:1 taper.

Signing for shoulder driving is required. Install guideposts when shoulder driving is to be permitted at night.

Document the need for shoulder driving and why a lane is not being built.

## 1010.08 Emergency Escape Ramps

### (1) General

Consider an emergency escape ramp whenever long steep down grades are encountered. In this situation the possibility exists of a truck losing its brakes and going out of control at a high speed. Consult local maintenance personnel and check traffic accident records to determine if an escape ramp is justified.

### (2) Design

(a) **Type.** Escape ramps are one of the following types:

- Gravity escape ramps are ascending grade ramps paralleling the traveled way. They are commonly built on old roadways. Their long length and steep grade can present the driver with control problems, not only in stopping, but with rollback after stopping. Gravity escape ramps are the least desirable design.
- Sand pile escape ramps are piles of loose, dry sand dumped at the ramp site, usually not more than 400 ft in length. The deceleration is usually high and the sand can be affected by weather conditions; therefore, they are less desirable than arrester beds. However, where space is limited they may be suitable.
- Arrester beds are parallel ramps filled with a smooth, coarse, free-draining gravel. They stop the out-of-control vehicle by increasing the rolling resistance. Arrester beds are commonly built on an up grade to add the benefits of gravity to the rolling resistance. However, successful arrester beds have been built on a level or descending grade.

(b) **Location.** The location of an escape ramp will vary depending on terrain, length of grade, and roadway geometrics. The best locations include in advance of a critical curve, near the bottom of grade, or before a stop. It is desirable that the ramp leave the roadway on a tangent at least 3 mi from the beginning of the down-grade.

(c) **Length.** Lengths will vary depending on speed, grade, and type of design used. The minimum length is 200 ft. Calculate the stopping length using the following equation:

$$L = \frac{V^2}{0.3(R \pm G)}$$

Where:

- L = stopping distance (ft)
- V = entering speed (mph)
- R = rolling resistance (see Figure 1010-1)
- G = grade of the escape ramp (%)

Speeds of out-of control trucks rarely exceed 90 mph; therefore, an entering speed of 90 mph is preferred. Other entry speeds may be used when justification and the method used to determine the speed is documented.

Material	R
Roadway	1
Loose crushed aggregate	5
Loose noncrushed gravel	10
Sand	15
Pea gravel	25

### Rolling Resistance (R)

Figure 1010-1

- (d) **Width.** The width of each escape ramp will vary depending on the needs of the individual situation. It is desirable for the ramp to be wide enough to accommodate more than one vehicle. The desirable width of an escape ramp to accommodate two out-of-control vehicles is 40 ft and the minimum width is 26 ft.
- (e) The following items are additional considerations in the design of emergency escape ramps:
- If possible, at or near the summit, provide a pull-off brake-check area. Also, include informative signing about the upcoming escape ramp in this area.
  - A free draining, smooth, noncrushed gravel is preferred for an arrester bed. To assist in smooth deceleration of the vehicle, taper the depth of the bed from 3 in at the entry to a full depth of 18 to 30 in in not less than 100 ft.
  - Mark and sign in advance of the ramp. Discourage normal traffic from using or parking in the ramp. Sign escape ramps in accordance with the guidance contained in the MUTCD for runaway truck ramps.

- Provide drainage adequate to prevent the bed from freezing or compacting.
- Consider including an impact attenuator at the end of the ramp if space is limited.
- A surfaced service road adjacent to the arrester bed is needed for wreckers and maintenance vehicles to remove vehicles and make repairs to the arrester bed. Anchors are desirable at 300 ft intervals to secure the wrecker when removing vehicles from the bed.

A typical example of an arrester bed is shown in Figure 1010-8.

Include justification, all calculations, and any other design considerations in the documentation of an emergency escape ramp documentation.

### 1010.09 Chain-Up Area

Provide chain-up areas to allow chains to be put on vehicles out of the through lanes at locations where traffic enters chain enforcement areas. Provide chain-off areas to remove chains out of the through lanes for traffic leaving chain enforcement areas.

Chain-up or chain-off areas are widened shoulders, designed as shown in Figure 1010-9. Locate chain-up and chain-off areas where the grade is 6% or less and preferably on a tangent section.

Consider illumination for chain-up and chain-off areas on multilane highways. When deciding whether or not to install illumination, consider traffic volumes during the hours of darkness and the availability of power.

### 1010.10 Documentation

The following documents are to be preserved in the project file. See Chapter 330.

- Documentation that climbing lane warrant 1 has been met
- Documentation that climbing lane warrant 2 has been met
- Justification for waiving climbing lane warrant 1 or 2
- Justification for passing lanes
- Slow moving vehicle turnout documentation
- Emergency escape ramp documentation

*P65:DP/DMM*

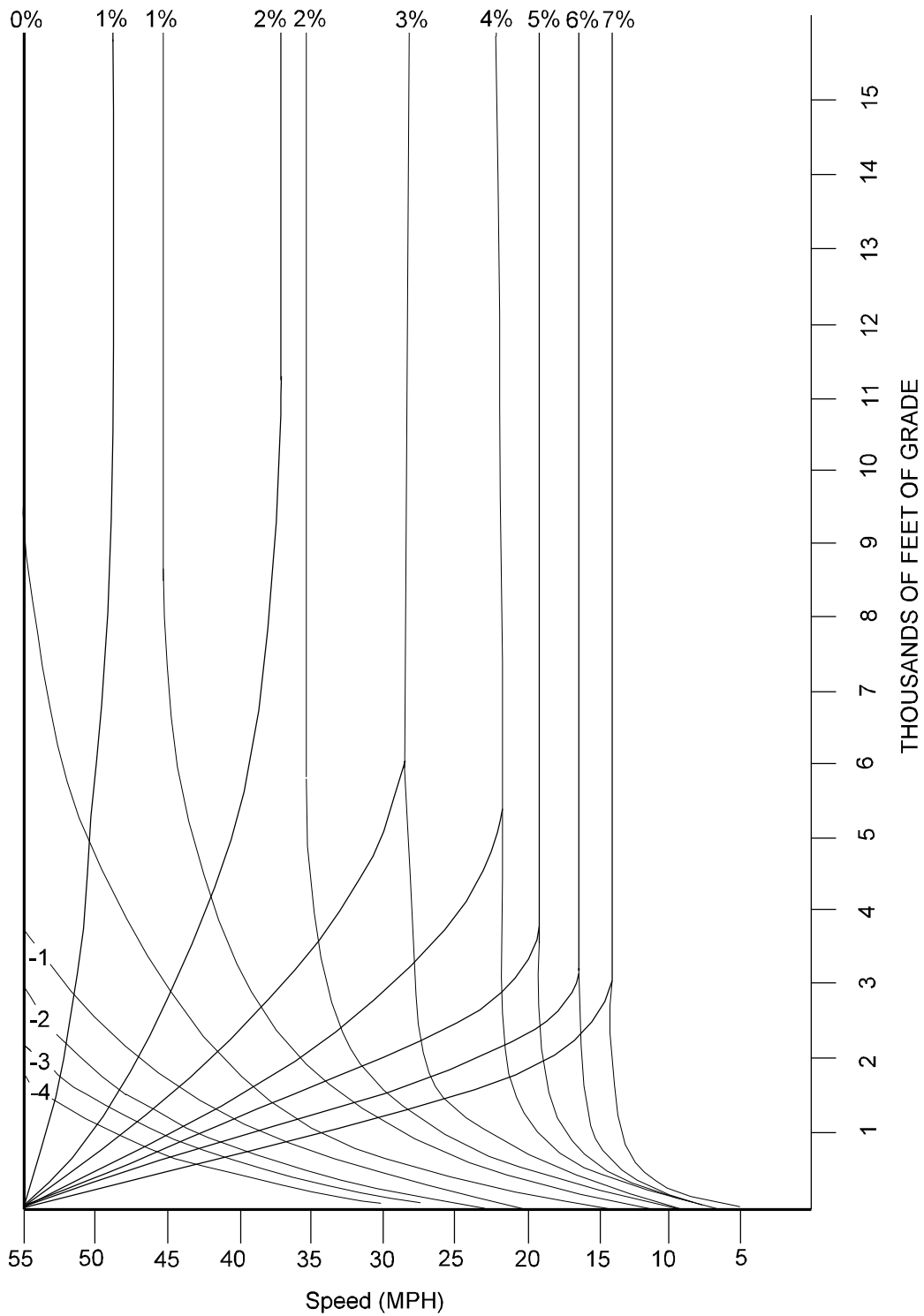

Acceleration curve ———  
 Deceleration curve - - - - -

**Performance For Heavy Truck**  
*Figure 1010-2a*

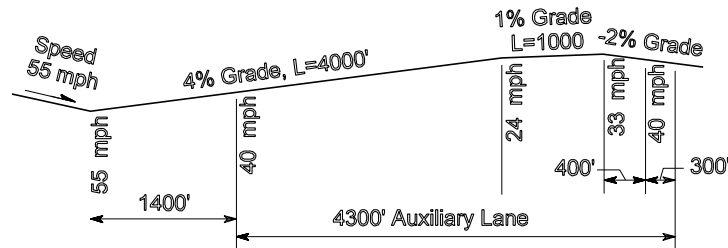
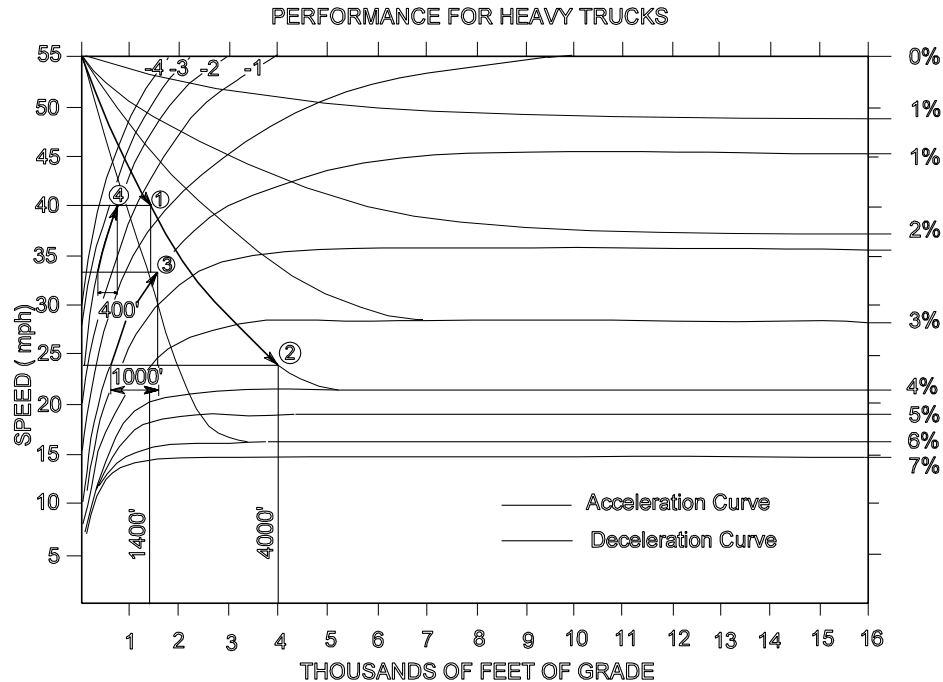

Given: A 2-lane highway meeting the level of service warrant, with the above profile, and a 55 mph posted speed.

Determine: Is the climbing lane warranted and, if so, how long?

Solution:

1. Follow the 4% grade deceleration curve from a speed of 55 mph to a speed of 40 mph at 1,400 ft. The speed reduction warrant is met and a climbing lane is needed.
2. Continue on the 4% grade deceleration curve to 4,000 ft. Note that the speed at the end of the 4% grade is 25 mph.
3. Follow the 1% grade acceleration curve from a speed of 25 mph for 1,000 ft. Note that the speed at the end of the 1% grade is 34 mph.
4. Follow the -2% grade acceleration curve from a speed of 34 mph to a speed of 40 mph, ending the speed reduction warrant. Note the distance required is 400 ft.
5. The total auxiliary lane length is  $(4,000-1,400)+1,000+400+300=4,300$  ft. 300 ft is added to the speed reduction warrant for a 2-lane highway, see the text and Figure 1010-4.

### Speed Reduction Example

*Figure 1010-2b*

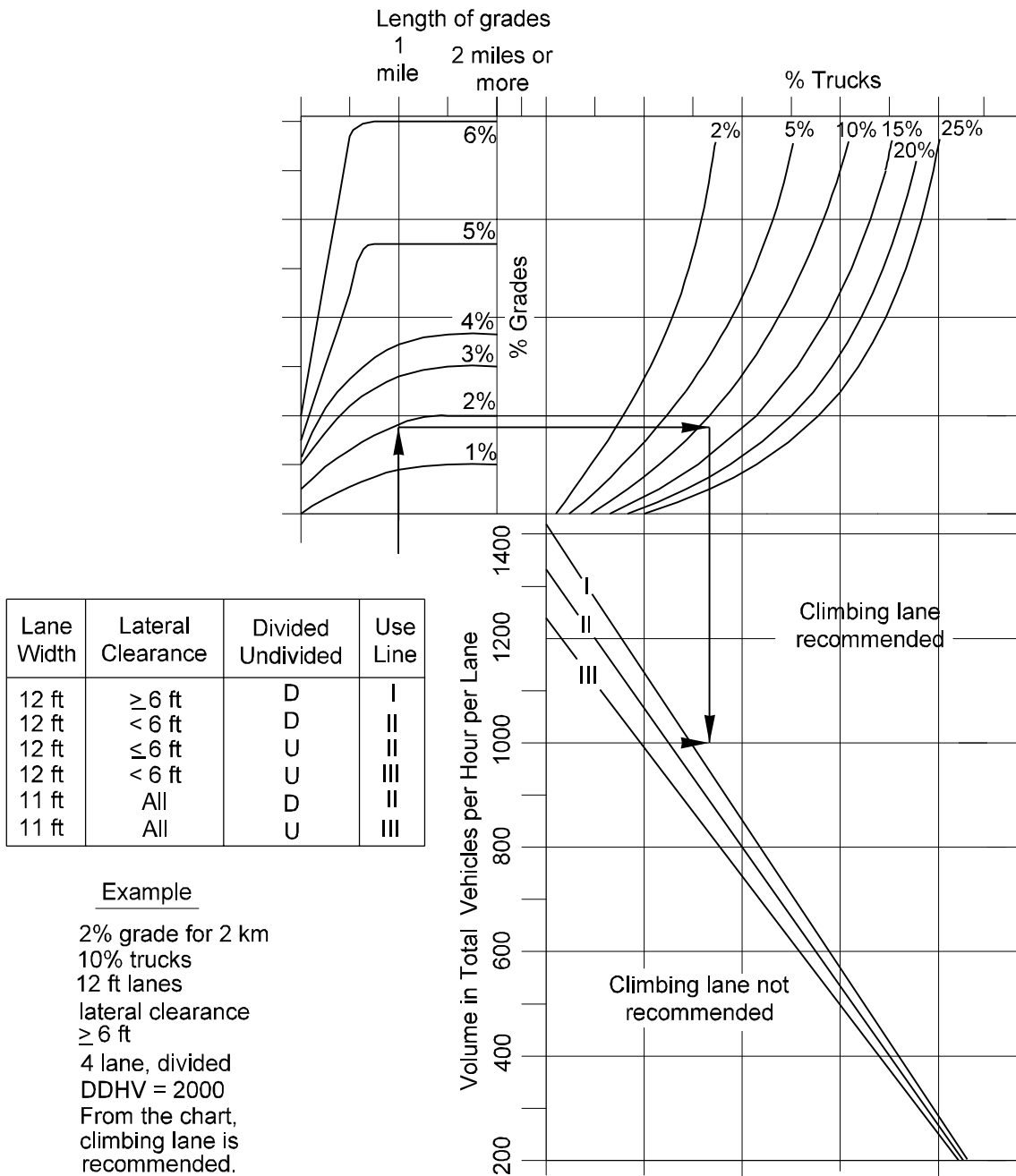

**Level of Service — Multilane**  
*Figure 1010-3*

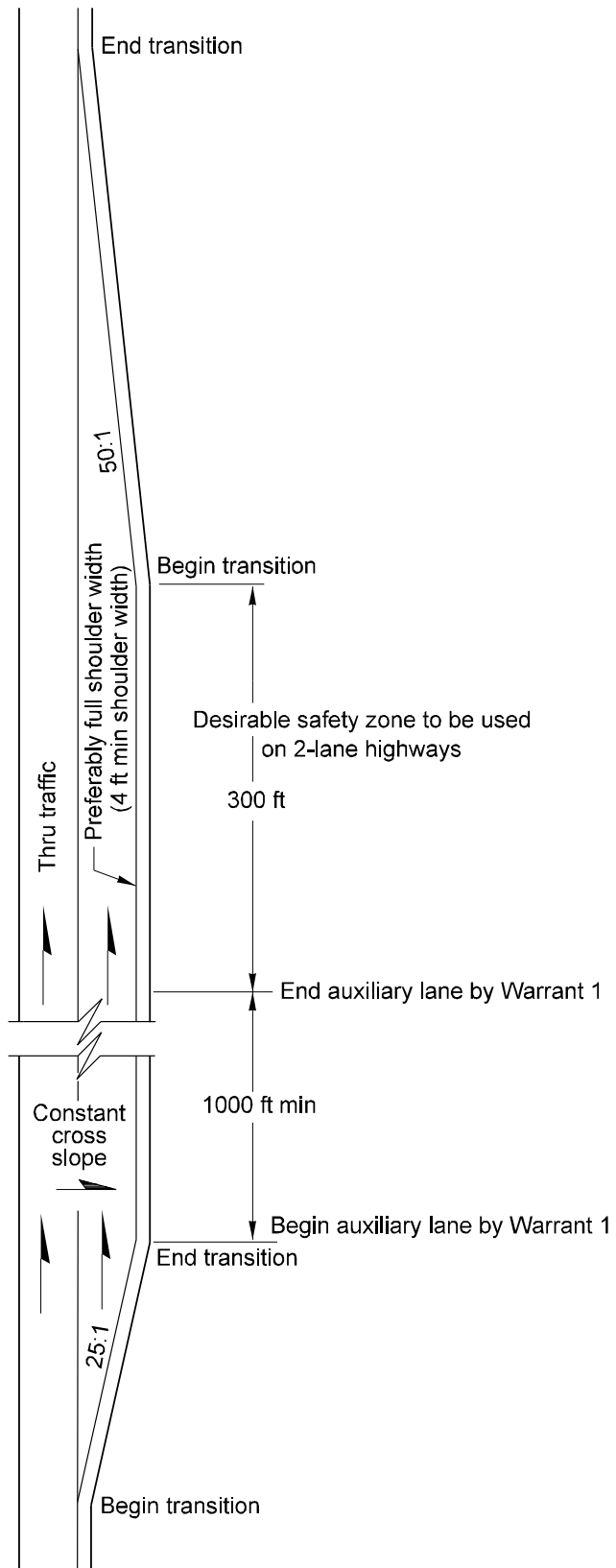

**Auxiliary Climbing Lane**  
*Figure 1010-4*



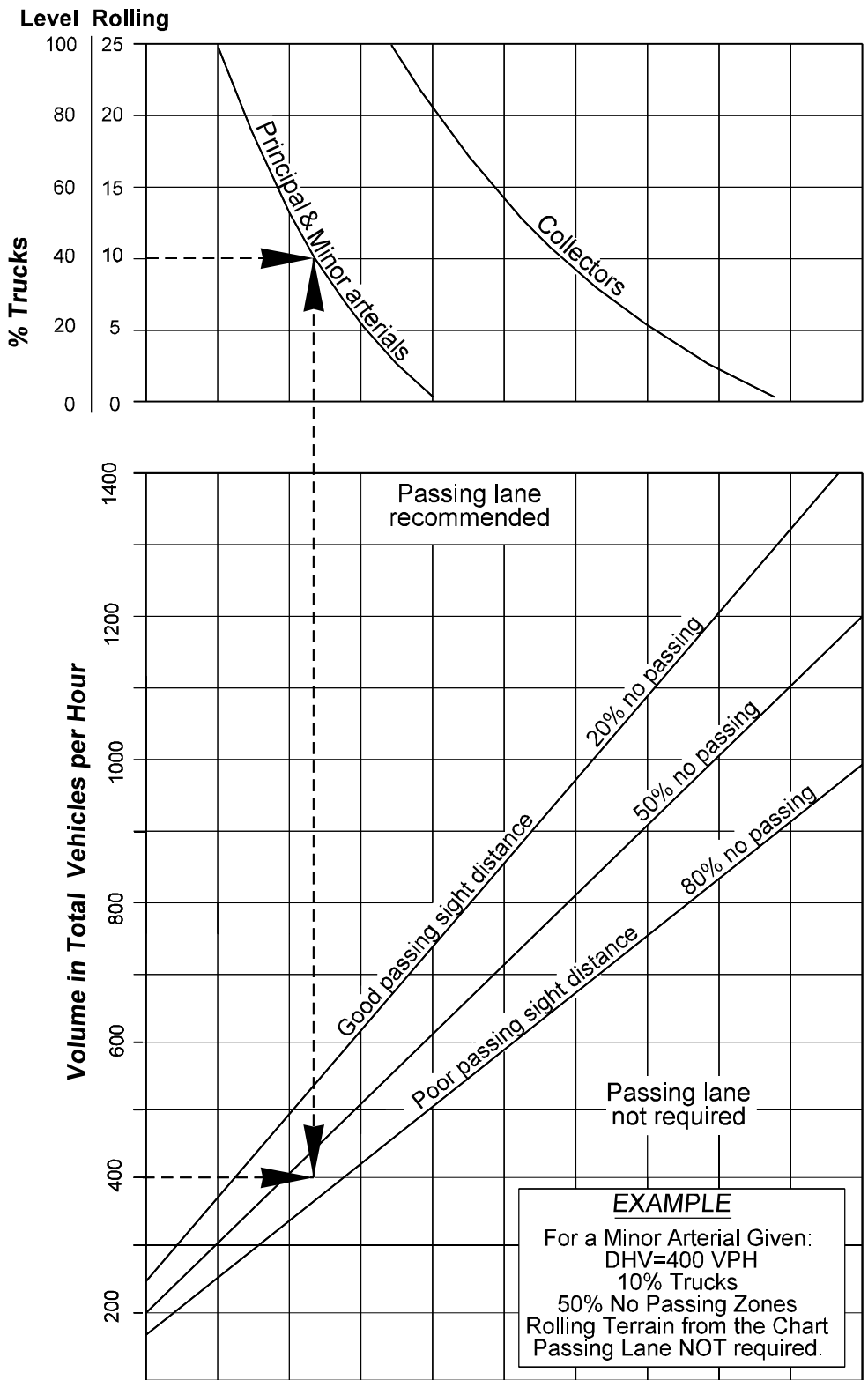

**Warrant For Passing Lanes**  
*Figure 1010-5*

### 4-Lane Design

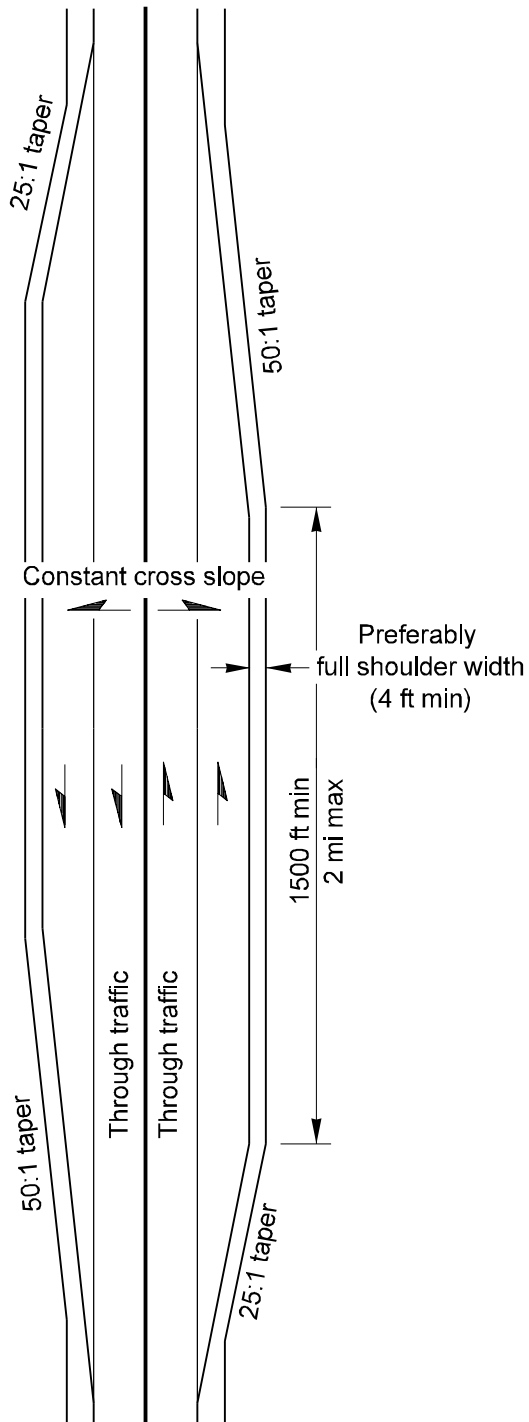

### 3-Lane Design

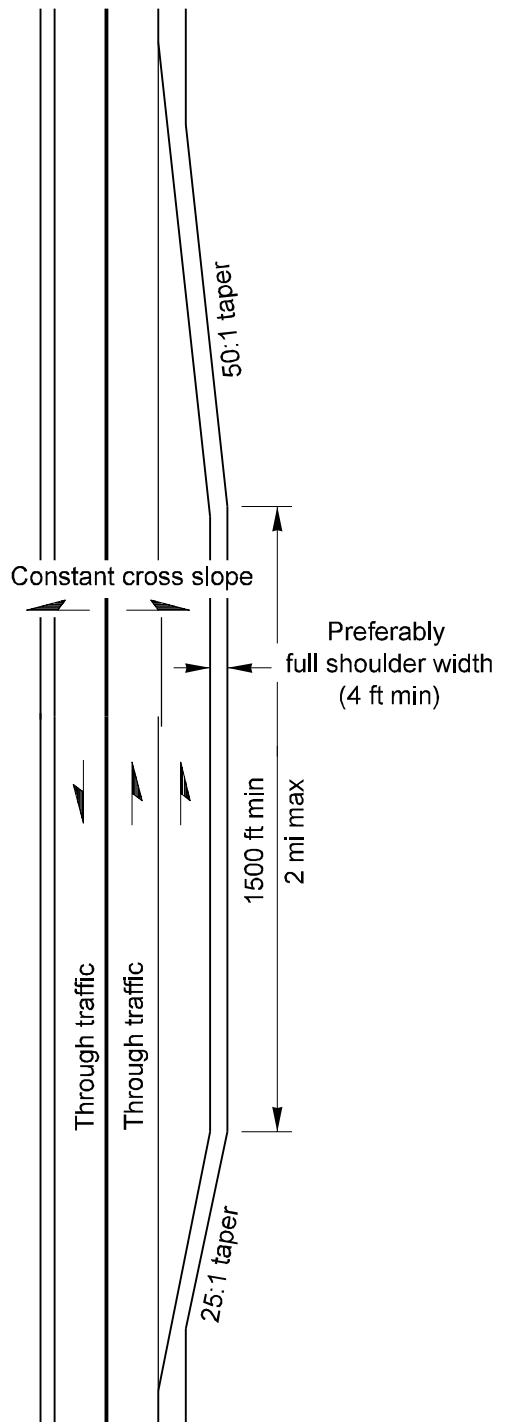

**Auxiliary Passing Lane**  
*Figure 1010-6*

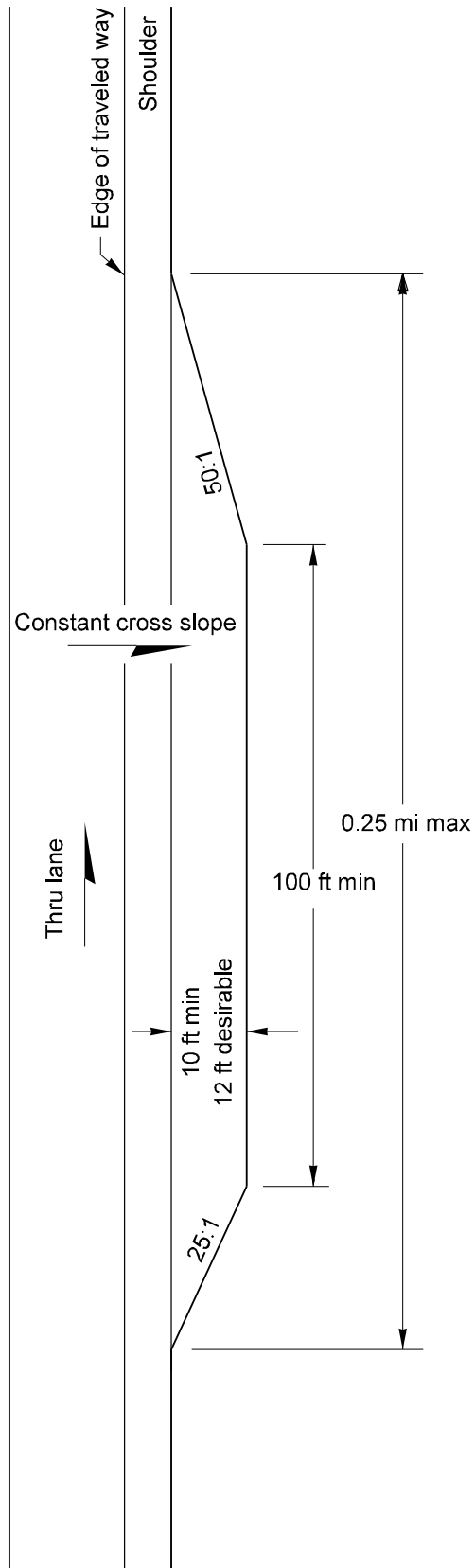

**Slow Moving Vehicle Turnout**  
*Figure 1010-7*

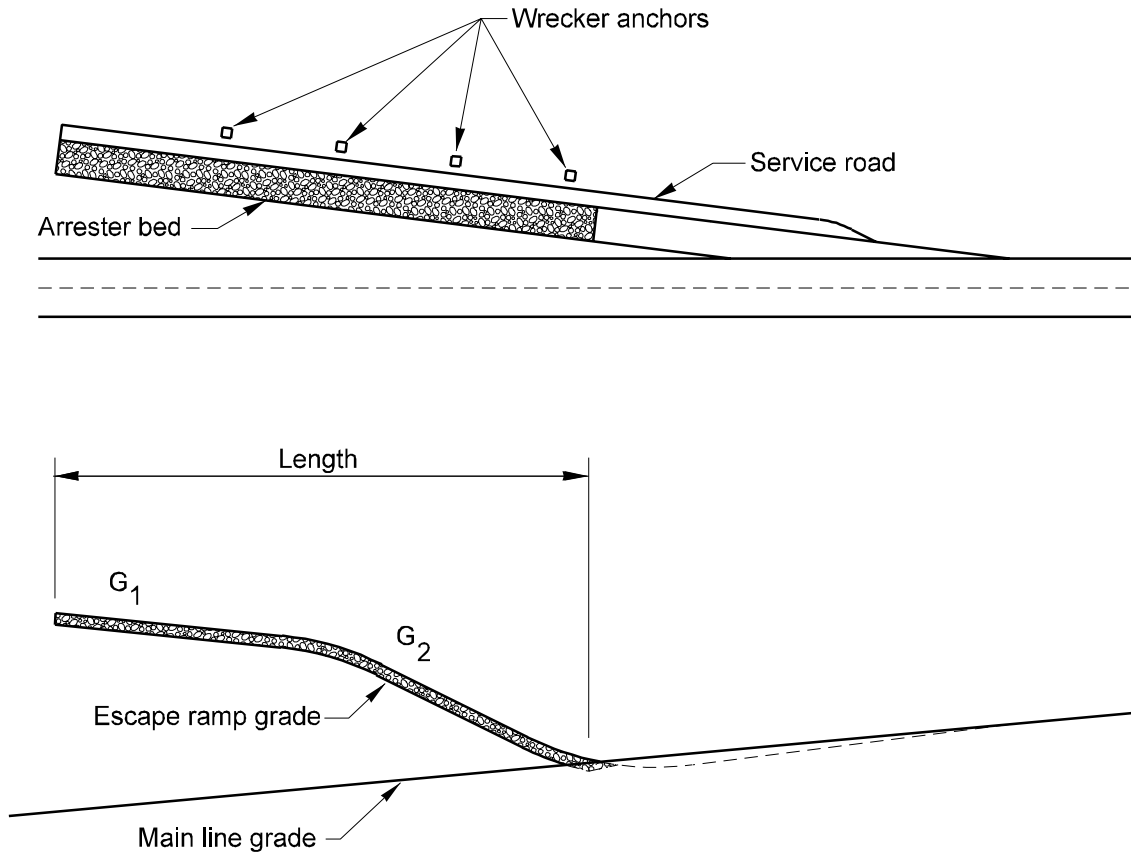

**Typical Emergency Escape Ramp**  
*Figure 1010-8*

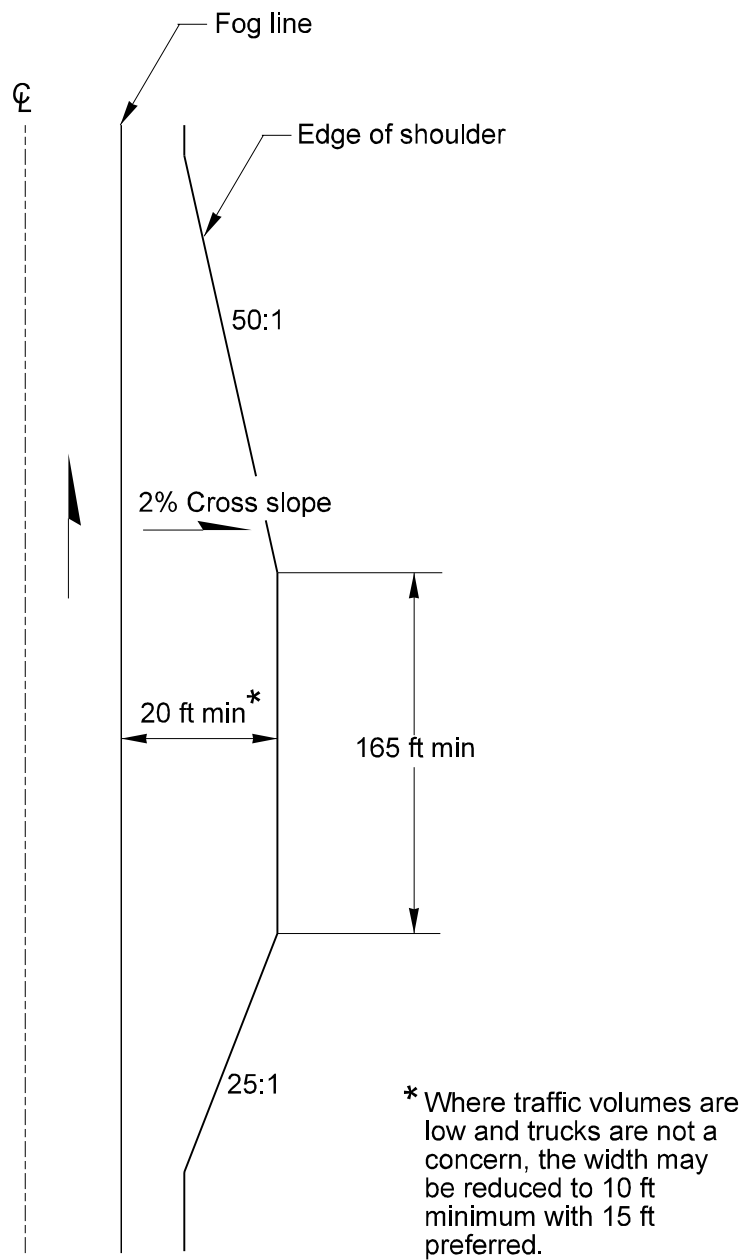

**Chain-Up/Chain-Off Area**  
*Figure 1010-9*

# 1020

## Facilities for Nonmotorized Transportation

- 1020.01 General
- 1020.02 Definitions
- 1020.03 Bicycle Facilities
- 1020.04 Pedestrian Facilities (Walkways)
- 1020.05 Equestrian and Watercraft Facilities

### 1020.01 GENERAL

Nonmotorized transportation includes travel by bicyclists, pedestrians, equestrians, and watercraft. Provisions for these travel modes are considered during the project development stage and included where there is demonstrated need. If sufficient funding is available, provisions for nonmotorized transportation may be included where there is the likelihood of substantial use.

These guidelines apply to normal situations encountered during project development. Unique design problems are resolved on a project-by-project basis using other relevant publications or appropriate methods.

State law (46.61.710 RCW) prohibits the operation of mopeds on facilities specifically designed for bicyclists, pedestrians, and equestrians. Mopeds are not considered in the design process for the purposes of this chapter.

### 1020.02 DEFINITIONS

**Bikeway** Any trail, path, part of a highway or shoulder, sidewalk, or any other travelway specifically signed and/or marked for bicycle travel.

**Class I Bikeway (Bike Path)** A separate trail for the principal use of bicycles.

**Class II Bikeway (Bike Lane)** A portion of a highway that is designated by signs and/or pavement markings for preferential bicycle use.

**Class III Bikeway (Bike Route)** A highway that is designated with signs as a bicycle route and is shared with other transportation modes.

**Class IV Bikeway (Shared Roadway With No Designation)** A publicly maintained facility that is not designated with signs and/or pavement markings as a bikeway, but is accessible to bicyclists.

**Equestrian Trail** Any designated trail on which horses are permitted to travel.

**Pedestrian Walkway** A continuous way designated for pedestrians and separated from the through lanes for motor vehicles by a physical barrier or space.

**Water Trail** A water-oriented trail which provides a designated route to, on, or along fresh and/or salt water in which the water is the primary point of interest.

### 1020.03 BICYCLE FACILITIES

#### (1) General

Normally, bikeways are shared with other transportation modes, although they may be provided exclusively for bicycle use. Bicycle facilities are designed to the standards for low speed roadways.

Properly designed facilities can accommodate bicyclists of all levels of skill, whereas an improperly designed facility will frequently be avoided by bicyclists.

In the development of shoulder widening projects along existing highways with short areas of restricted width, such as bridges, cuts, or fills, the widening can be quite costly. However, the presence of these short areas does not diminish the importance of widening the adjoining shoulder sections.

#### (2) Planning

Bikeway planning is an effort to provide for safe and efficient bicycle travel. An effective program recognizes that most highways can be upgraded to accommodate shared use by bicyclists and motorists.

The important consideration in an effort to enhance bicycle travel is the upgrading of existing networks of roads that are used regularly by bicyclists, regardless of whether bikeways are designated. The upgrading includes improving the width and quality of the surface and maintaining the right-hand portion in a condition suitable for bicycle riding. Consideration of bicycle needs is also important in the design of major construction projects and normal safety and operational improvements.

Bikeway planning is an integral part of the planning for other transportation modes and land use development. The location criteria and miscellaneous bikeway criteria that follow are to be used for long-term planning and project development as applicable.

#### (3) Selection of the Type of Facility

The type of facility to select in meeting the bicycle need is dependent on many factors, but the following applications are the most common for each type:

- (a) **Class I Bikeway (Bike Path).** Generally, bike paths are used to serve corridors not served by streets and highways or where wide rights of way exist, permitting such facilities to be constructed away from the influence of parallel streets. Bike paths should offer opportunities not provided by the road system. They can either provide a recreational opportunity or, in some instances, can serve as direct high-speed commute routes, if cross-flow by motor vehicles can be

minimized. The most common applications are along rivers, ocean fronts, canals, utility rights of way, abandoned railroad rights of way, within college campuses, or within and between parks. There may also be situations where such facilities can be provided as part of planned developments. Another common application of Class I facilities is to close gaps to bicycle travel caused by construction of freeways, or because of the existence of natural barriers (rivers, mountains, etc.).

- (b) **Class II Bikeway (Bike Lane).** Bike lanes are established along streets in corridors where there is significant bicycle demand, and where there are distinct needs that can be served by them. The purpose is to improve conditions for bicyclists in the corridors. Bike lanes are intended to delineate the rights of way assigned to bicyclists and motorists and to provide for more predictable movements by each. An important reason for constructing bike lanes is to better accommodate bicyclists through corridors where insufficient room exists for safe bicycling on existing streets. This can be accomplished by reducing the number of lanes, or prohibiting parking on given streets in order to delineate bike lanes. The number of vehicular traffic lanes may be reduced only if it does not reduce the highway's level of service below that appropriate for the highway class. Also, parking may be prohibited if it can be demonstrated that sufficient alternative parking is available to serve the needs of the motorized traffic. In addition, other things can be done on bike lane streets to improve the situation for bicyclists, that might not be possible on all streets (e.g., improvements to the surface; augmented sweeping programs, special signal facilities, etc.). Generally, stripes alone will not measurably enhance bicycling.

When selecting appropriate streets for bike lanes, refer to the location criteria discussed in 1020.03(4) for factors to be considered.

- (c) **Class III Bikeway (Bike Route).** Bike routes are shared facilities that serve either to provide continuity to other bicycle facilities (Class II bikeways), or to designate preferred routes through high bicycle-demand corridors. As with bike lanes, designation of bike routes is an indication to bicyclists that there are particular advantages to using these routes as compared with alternative routes. This means that responsible agencies have taken action to assure that these routes are suitable as shared routes and will be maintained in a manner consistent with the needs of bicyclists. Normally, bike routes are shared with motor vehicles. The use of sidewalks as Class II or III bikeways is strongly discouraged.
- (d) **Class IV, Shared Roadway (Shared Roadway With No Bikeway Designation).** In some instances,

entire street systems are fully adequate for safe and efficient bicycle travel, and signing and striping for bicycle use would be unnecessary. In other cases, routes are inherently unsafe for bicycle travel and it would be inappropriate to encourage additional bicycle travel by designating the routes as bikeways. Finally, if the routes are not along high bicycle-demand corridors, it would be inappropriate to designate bikeways regardless of roadway conditions (e.g., on minor residential streets).

Many rural highways are used by experienced bicyclists for intercity and recreational travel. The development and maintenance of 4-foot paved roadway shoulders with a standard edge stripe can significantly improve the safety and convenience for bicyclists and motorists along such routes. This should be a goal to work towards. However, in most cases, it would be inappropriate to designate the highways as bikeways because of the limited use and the lack of continuity with other bike routes.

It is emphasized that the designation of bikeways as Class I, II, III, and IV should not be construed as a hierarchy of bikeways - that one is better than the other. Each class of bikeway has its appropriate application.

In selecting the proper facility, an overriding concern is to assure that the proposed facility will not encourage or require bicyclists or motorists to operate in a manner that is inconsistent with the rules of the road.

An important consideration in selecting the type of facility is continuity. Alternating segments of Class I and Class II (or Class III) bikeways along a route are generally incompatible, as street crossings by bicyclists are required when the route changes character. Also, wrong-way bicycle travel will occur on the street beyond the ends of bike paths because of the inconvenience of having to cross the street.

#### **(4) Location Criteria**

Among the factors to consider in determining proper location of a Class I, II, or III bikeway are the following:

- (a) **Potential Use.** Locate bikeways along corridors where use is or can be maximized. Along highways with high vehicular traffic, a close parallel street or road should be used unless there is adequate width to develop a separate bikeway. However, to be attractive to commuting bicyclists, the street must offer through route conditions.
- (b) **Directness.** Locate facilities along a direct line and in such a way that they connect traffic generators for the convenience of the users.
- (c) **Access.** When locating a Bike Path (Class I bikeway), consideration should be given to providing adequate access points. The more frequent and convenient the access points, the more the facility

will be used. Adequate access for emergency and service vehicles is also necessary.

- (d) **Available Width.** For an on-street bikeway (Class II or III bikeway), the overall roadway width must meet or exceed the highway minimum design criteria (Chapters 430 and 440).
- (e) **On-Street Motor Vehicle Parking.** Consider the density of on-street parking and the safety implications, such as opening car doors. If possible, select a route where on-street parking is light or where it can be prohibited.
- (f) **Delays.** Bicyclists have a strong desire to maintain momentum. If bicyclists are required to make frequent stops they may tend to avoid the route.
- (g) **Traffic Volumes and Speeds.** For an on-street bikeway the speed and volume of auto traffic, along with the available width, are factors in determining the best location. Commuting bicyclists generally ride on arterial streets to minimize delay and because they are normally the only streets offering continuity for trips of several miles.
- (h) **Truck and Bus Traffic.** High-speed truck, bus, and recreational vehicle traffic can cause problems along a Class II or III bikeway because of aerodynamic effects and vehicle widths.
- (i) **Existing Barriers.** In some areas there are physical barriers to bicycle travel, caused by topographical features such as rivers, limited access highways, or other impediments. In such cases, developing a bikeway crossing of an existing barrier can provide access opportunities for bicyclists.
- (j) **Accident History.** It is important to check the accident experiences at a prospective bicycle route to determine its relative safety compared to other candidate routes. This involves careful analysis of the accident types to determine which of them might be reduced. (See 1020.03(4)(o).) Also, the potential for introducing new accident problems needs to be considered.
- (k) **Grades.** Steep grades on bikeways are to be avoided if possible. Refer to 1020.03(6) for specific criteria.
- (l) **Pavement Surface Quality.** An on-street Class II or III bikeway should be established only where pavement can be brought to a reasonable standard. Dense graded asphalt concrete surfaces are preferable to open-graded or seal-coated surfaces. Refer to 1020.03(5) for additional guidance.
- (m) **Maintenance.** Ease of maintenance is an important consideration in locating and developing a bikeway. The main factor to consider is the ease of entry and exit of maintenance vehicles. An improperly maintained bikeway will often be shunned by bicyclists in favor of a parallel roadway.

- (n) **Environmental Compatibility.** Scenic value, erosion stability, and compatibility with the surrounding terrain are important for a bikeway whether serving as a recreational facility or for business commuting.
- (o) **Use Conflicts.** On-street Class II or III bikeways primarily involve potential conflicts with motor vehicles. Bike paths and Class I bikeways usually involve conflicts with other bicyclists, with pedestrians on the path, and with motor vehicles at street intersections.
- (p) **Security.** The potential for criminal acts against bicyclists, especially along remote bicycle paths, and the possibility of theft or vandalism at parking locations, need to be considered.
- (q) **Cost/Funding.** Location selection will normally involve a cost comparison analysis of alternatives. Funding availability will often limit the alternatives; however, it is important that a lack of funds not result in a poorly designed or constructed facility. It is usually more desirable not to construct a bicycle facility than to construct a poorly planned or designed facility.

#### **(5) Miscellaneous Bikeway Criteria**

The following miscellaneous bikeway criteria are to be followed, as pertinent, for Class I, II, and III bikeways. Some, by their very nature, will not apply to all classes of bikeway. Many of the criteria are important to consider on any highway where bicycle travel is expected, regardless of whether designated bikeways are established.

- (a) **Bridges.** Bikeways on highway bridges must be carefully coordinated with approach bikeways. Bicycle traffic is best accommodated by continuing the approach bikeway across the structure. For a one-way Class I bikeway, refer to 1020.03(6)(a)4.

Where a two-way bike path, Class I bikeway, is carried across one side of a bridge, the following criteria apply:

- Design the bikeway approach to the bridge on a separate two-way facility.
- Provide a physical separation if needed. For criteria regarding when a physical separation is needed, see 1020.03(6)(a)4.

The clear width on structures between railings must not be less than 10 feet for two-way Class I bikeways and 6 feet for one-way Class I bikeways. It is desirable that the clear width on structures be equal to that of the approaching path including the 2 to 3 feet graded areas. The minimum vertical clearance to obstructions across the clear width of the path is 8 feet.

- (b) **Maintenance.** Bikeway surfaces should be maintained in a good condition, generally free of potholes, corrugations, gravel, broken glass, and other debris.



(c) **Surface Quality.** The surface to be used by bicyclists should be smooth and the pavement edge uniform.

(d) **Drainage Grates and Manhole Covers.** Design the drainage inlet grates, manhole covers, etc. on bikeways in a manner that provides a smooth surface for bicyclists. Grates and manhole covers are to be maintained 0.5 inch below the surface.

Drainage inlet grates on bikeways must have openings narrow enough and short enough to ensure that bicycle tires will not drop into the grates. Where it is not immediately feasible to replace existing grates with standard grates designed for bicycles or where grate clogging could be a problem, steel cross straps may be installed onto the grates at a spacing of 6 inches to 8 inches on centers, to adequately reduce the size of the openings.

(e) **At-Grade Railroad Crossings and Cattle Guards.** Whenever a bikeway crosses railroad tracks, the crossing should be at least as wide as the approaches of the bikeway. Wherever possible, the crossing is at right angles to the rails.

For on-street bikeways, Class II or III bikeway, where a skew is unavoidable the shoulder (or bike lane) is widened to permit bicyclists to cross at right angles. If this is not possible, special construction and materials should be considered to keep the flangeway depth and width to a minimum.

Where hazards to bicyclists cannot be avoided, appropriate signs and markings should be installed in accordance with the MUTCD.

(f) **Lighting.** Proper illumination of bicycle facilities is necessary for provision of minimum levels of safety, security, and visibility. The level of illumination required on a bicycle facility is dependent upon the amount of nighttime use that is expected and the nature of the area the facility is expected to pass. Usually existing roadway illumination should be adequate to provide for safe bicycle travel. Refer to Chapter 840 for additional guidance concerning illumination of bikeways.

(g) **Support Facilities.** Where bicycles are used extensively for utility trips or commuting, adequate parking and/or storage at common destinations, such as park and ride lots, transit terminals, schools, shopping centers, etc., is desirable. This can be defined by doing a survey of the bicyclists using a particular route.

#### **(6) Design Criteria By Bikeway Class**

(a) **Class I Bikeway (Bike Path).** Class I bike paths are facilities with exclusive rights of way for the principal use of bicycles.

1. **Widths.** The geometric guidelines for bike paths are shown in Figures 1020-1a and 1020-1b. The paved width for a two-way bike path is 8 feet minimum and 10 feet desirable minimum. A minimum 2-foot wide graded area shall be provided adjacent to the pavement. Where the paved width is wider than the minimum required, the graded area may be reduced accordingly. If the bike path has an embankment height equal to or greater than 10 feet, a 3-foot wide graded area shall be provided adjacent to the pavement.

Where heavy bicycle volumes, adult tricycle traffic, or significant pedestrian traffic is expected, the paved width of a two-way path should be at least 10 feet. A count of 60 bicycles per hour during the peak hour taken on a nice day, constitutes a heavy bicycle volume. Twenty pedestrians per hour in the peak hour conditions described above constitute a significant pedestrian traffic. Contact the district Bicycle Coordinator for bicycle use information.

However, when maintenance vehicles are expected to use the bike path as an access road to utilities, etc., a 12-foot minimum paved width is recommended. Experience has shown that paved paths less than 12 feet wide sometimes break up along the edge as a result of loads from maintenance vehicles.

The minimum paved width for a one-way bike path is 5 feet. The development of a one-way bike path should be undertaken only after careful consideration due to the problems of enforcing one-way operation and the difficulties in maintaining a path of restricted width.

2. **Clearance to Obstructions.** The minimum horizontal clearance from the edge of pavement to an obstruction is 2 feet. Where minimum clearances to obstructions cannot be obtained, signs and pavement markings are installed to warn bicyclists of the condition.

3. **Intersections with Highways.** Intersections are a prime consideration in bike path design. At grade crossings occur at existing intersections or existing pedestrian crossings where motorists can be expected to stop. If alternate intersection locations for a bike path are available, the one with the most sight distance should be selected.

Whenever possible, a crossing is placed away from the influence of an intersection, to eliminate conflicts.

4. **Outer Separations Between Class I Bikeways and Highways.** Separation is recommended between Class I bikeways and adjacent highways. Class I bikeways closer than 5 feet to the edge of

a roadway must include a physical divider for posted highway speeds above 35 mph to prevent bicyclists from encroaching onto the highway. A suitable divider will include a concrete barrier Type 4, chain link fence, or a hedge. The physical separation should be at least 4.5 feet high, in order to minimize the likelihood of bicyclists falling over. Standard bridge railings which are lower than 4.5 feet can be retrofitted with additional railings or with chain link fence, suitable to restrain bicyclists. (Refer to Figure 1020-1c.)

Vertical concrete surfaces adjacent to bicyclists or pedestrian facilities should be smooth to avoid snagging of clothing or abrasive injuries from contact with the surface. Where bicyclists use facilities located behind guardrail, the protruding bolts on the guardrail should be cut off.

5. **Bike Paths in the Median of Highways.** Bike paths in the median of highways are not recommended.
6. **Design Speed.** The proper design speed for a bike path is dependent on the expected conditions of use and on the terrain.

#### DESIGN SPEEDS

<u>Conditions</u>	<u>Min. Design Speed MPH</u>
Open Country (level or undulating); Separate Bike Path in Urban Areas	20
Long Down Grades (steeper than 4% and longer than 500 feet)	30

Speed bumps or other similar surface obstructions intended to cause bicyclists to slow down in advance of intersections are not to be used.

7. **Horizontal Alignment and Superelevation.** Minimum recommended curve radii and superelevations for various design speeds are shown in Figure 1020-2. Superelevation transitions for bikeways are the same as those specified for ramp curves prorated for WL = 10 feet (refer to Chapter 640). When minimum curve radii are selected, increased pavement width of up to 4 feet on the inside of the curve is recommended to compensate for bicyclist lean (see Figure 1020-3). In sharp curve conditions, consider center line striping for Class I bikeways.  
  
A straight 2 percent cross slope is recommended on tangent. The maximum superelevation is 5 percent. Superelevation greater than 5 percent will slow bicyclists and adult tricyclists may have maneuvering difficulties (see Figure 1020-2).
8. **Stopping Sight Distance.** Figure 1020-4 indicates the minimum stopping sight distances for various design speeds and grades. The descending direction controls the design for two-way

bike paths. Design speeds for both directions combined need to be considered. Passing sight distance is not considered due to the relatively low speed of bicyclists.

9. **Length of Crest Vertical Curves.** Figure 1020-5, Sight Distance For Crest Vertical Curves, indicates the minimum lengths of crest vertical curves for varying design speeds.
10. **Lateral Clearance on Horizontal Curves.** Figure 1020-6 indicates the minimum clearances to line-of-sight obstructions for horizontal curves. The lateral clearance is obtained by entering on the chart the stopping sight distance from Figure 1020-4 and the proposed horizontal curve radius. Where minimum clearances cannot be obtained, appropriate signs and pavement markings are installed to warn bicyclists of the condition.
11. **Grades.** Bicyclists who are not physically in condition, are less skilled, or are riding poorly maintained bikes will be unable to negotiate long, steep uphill grades. Long downgrades can also cause problems. For these reasons, bike paths with long, steep grades will generally receive very little use. The maximum grade rate recommended for bike paths is 5 percent. It is desirable that sustained grades be limited to 2 percent if a wide range of riders is to be accommodated.

Steeper grades of 5 to 10 percent can be tolerated for short segments up to about 500 feet. Where the steeper grades are necessary, the design speed is increased and additional width of 3 feet is provided for maneuverability.

12. **Structural Section.** Design the structural section of a bike path in the same manner as a highway, giving consideration to the quality of the subgrade and the anticipated loads the bikeway will experience. Principal loads will normally be from maintenance and emergency vehicles.

Unless otherwise justified, Asphalt Concrete Pavement (ACP) is used in the construction of a bicycle facility. Asphalt concrete pavement 0.20-foot thick will not need surfacing material when the subgrade R value is more than 65. But if the R value is between 40 to 65, the depth of the surfacing material should be a minimum of 0.15 feet. If the subgrade R value is less than 40, the depth of the surfacing material should be a minimum 0.35 feet.

13. **Drainage.** For proper drainage, the surface of a bike path has a cross-slope of 2 percent. Sloping in one direction usually simplifies longitudinal drainage design and surface construction and is the preferred practice. Ordinarily, surface

drainage from the path will be adequately dissipated as it flows down the gently sloping shoulder. However, a bike path constructed on the side of a hill, may require a drainage ditch of suitable dimensions on the uphill side to intercept the hillside drainage. Where necessary, catch basins with drains are provided to carry intercepted water under the path. Refer to Chapter 1210 for other drainage criteria.

14. **Barrier Posts.** Barrier posts may be installed at entrances to bike paths to prevent motor vehicles from entering. A barrier post is used only if operational problems demand it; for instance, if there is a policing problem at the site under consideration. When locating such installations, ensure that barriers are well-marked and visible to bicyclists, day or night (e.g., by installing reflectors or reflectorized tape). The barriers must be at least 30 inches in height.

Where more than one post is necessary, a 5-foot spacing is used to permit passage of bicycle-towed trailers and adult tricycles and to ensure adequate room for safe bicycle passage without dismounting. Design barrier post installations so they are removable, to permit entrance by emergency and service vehicles, and breakaway when in the lateral clearance area.

15. **Signing and Striping.** Refer to MUTCD for guidance and directions for signing and striping of bikeways. A yellow center line stripe is beneficial to separate opposing directions of travel where there is heavy use, on curves where there is restricted sight distance, and where the path is unlighted and nighttime riding is expected.

- (b) **Class II Bikeway (Bike Lane).** Class II bikeways (bike lanes) for preferential use by bicycles are established within the paved area of highways. Bike lane stripes are intended to promote an orderly flow of traffic, by establishing specific lines of demarcation between areas reserved for bicycles and lanes to be occupied by other vehicles. This effect is supported by bike lane signs and pavement markings. Bike lanes are one-way facilities. Two-way bike lanes are not permitted, as such facilities have proved unsatisfactory.

1. **Widths.** Some typical Class II bikeway configurations are illustrated in Figure 1020-7 and are described below:

Figure 1020-7, Design A, depicts bike lanes on an urban-type curbed street where parking stalls (or continuous parking stripes) are marked. Bike lanes are located between the parking area and the traffic lanes. Minimum widths are shown.

Bike lanes are not placed between the parking area and the curb. Such facilities create hazards for bicyclists, with opening car doors and poor visibility at intersections. Also, they prevent bicyclists from leaving the bike lane to turn left, and cannot be effectively maintained.

Figure 1020-7, Design B, depicts bike lanes on an urban-type curbed street, where parking is permitted. Bike lanes are established in conjunction with the parking areas. As indicated, 12 feet is the minimum width of the bike lane where parking is permitted. This type of lane is satisfactory where parking is not extensive and where turnover of parked cars is infrequent. However, if parking is substantial or turnover of parked cars is high, additional width of 1 to 2 feet is recommended.

Figure 1020-7, Design C, depicts bike lanes along the outer portions of an urban-type curbed street, where parking is prohibited. This is generally the most desirable configuration for bike lanes, as it eliminates potential conflicts resulting from auto parking (e.g., opening car doors). Minimum widths are shown. Both minimum widths shown must be achieved. With a normal 2-foot gutter, the minimum bike lane width is 5 feet.

Figure 1020-7, Design D, depicts bike lanes on a highway without curbs and gutters. Minimum widths are shown. Additional width is desirable, particularly where motor vehicle speeds exceed 40 mph.

Bike lanes are not advisable on long, steep downgrades, where bicycle speeds greater than 30 mph are expected. As grades increase, downhill bicycle speeds will increase, which increases the danger of riding near the edge of the roadway. In such situations, bicycle speeds can approach those of motor vehicles, and experienced bicyclists will generally move into the motor vehicle lanes to increase sight distance and maneuverability.

If the bike lanes are to be located on one-way streets, they are placed on the right side of the street. Bike lanes on the left side would cause potentially hazardous weaving maneuvers between bicyclists and motorists making left turns onto a two-way street.

2. **Intersection and Signal Design.** Most auto/bicycle accidents occur at intersections. For this reason, bikeway design at intersections is to be accomplished in a manner that will minimize confusion by motorists and bicyclists and will permit both to operate in accordance with the normal rules of the road.

Figure 1020-8 illustrates a typical intersection of multilane streets, with bike lanes on all approaches. Some common movements of motor vehicles and bicycles are shown. At intersections where there are bike lanes and traffic signals, installation of bicycle-sensitive loop detectors within the bike lane (well in advance of intersections) is desirable. It is also important that loop detectors in left-turn lanes be sensitive enough to detect bicycles. The use of push button actuators at bikeway intersections are not preferred by bicyclists as they must stop to actuate the signal.

Figures 1020-9 and 1020-10 illustrate recommended striping patterns for bike lanes crossing a motorist right-turn-only lane, or freeway off-and-on-ramps. When confronted with such intersections, bicyclists will have to merge with right-turning motorists. Since bicyclists are typically traveling at speeds less than motorists, they could signal and merge where there is a sufficient gap in right-turning traffic, rather than at any predetermined location. For this reason, it is recommended that either all delineations are dropped at the approach of the right turn lane (or off-ramp), or that a single, dashed bike lane line be extended at a flat angle across the right turn lane. A pair of parallel lines (delineating a bike lane crossing) to channel the bike merge is not recommended, as bicyclists will be encouraged to cross at a predetermined location, rather than when there is a safe gap in right-turning traffic. Also, some bicyclists are apt to assume they have the right of way and neglect to check for right-turning traffic.

A dashed line across the right-turn-only lane (or off-ramp) is not recommended on extremely long lanes, or where there are double right-turn-only lanes. For these types of intersections, all striping is dropped to permit judgment by the bicyclists to prevail. Bike lanes crossing on-ramps do not present the same problems, as bicyclists normally have a good view of traffic entering the roadway, and will adjust their path to cross ramp traffic. A bike crossing sign is intended for use on highways to warn motorists of the potential for bicyclists crossing the roadway.

For additional guidance on signal design at intersections involving Class II bikeways, refer to Chapter 850.

3. **Signing and Striping.** Use the general guidelines for signing and striping in the MUTCD, Part IX, for acceptable signing and striping criteria. Additional guidelines are shown on Figure 1020-7.

- (c) **Class III Bikeways (Bike Routes).** Bike routes are intended to provide continuity to the bikeway system. Bike routes are established along through routes not served by bike paths or bike lanes (Class I or II bikeways), or to connect discontinuous segments of bikeways. Bike routes are shared facilities, normally with motor vehicles on the street, or occasionally with pedestrians on sidewalks; in either case, bicycle usage is secondary.

Bike routes are established by placing the MUTCD Bike Route sign along highways. Since bicyclists are permitted on all highways (except prohibited portions of limited access highways), the decision to sign the route is based on the following factors:

1. **On-Street Bike Route Criteria:**

- The route offers a higher degree of service than alternative streets.
- It provides for through and direct travel in bicycle-demand corridors.
- It connects discontinuous segments of bikeways.
- An effort has been made to adjust traffic control devices for bicyclists.
- Street parking is restricted for improved safety where lane width is critical.
- Surface hazards to bicyclists have been corrected.
- Maintenance of the route is to a higher standard than comparable streets, such as more frequent street sweeping and repair.

2. **Sidewalks.** Generally, the designated use of sidewalks for bicycle travel is unsatisfactory, for the following reasons:

- Sidewalks tend to be used in both directions, despite any signing to the contrary.
- At approaches to intersections, parked cars interfere with the visual relationships between motorists and bicyclists. At driveways, sight distances are often impaired by property, fences, shrubs, etc.
- At intersections, motorists are not looking for bicyclists entering the crosswalk area, particularly when motorists are making a turn.
- Sidewalks are typically designed for pedestrian speeds, and are not safe for higher-speed use. Conflicts between bicyclists and pedestrians (leaving stores, parked cars, etc.) are common, as are conflicts with fixed objects such as parking meters, utility poles, sign posts, bus shelters, benches, trees, hydrants, and mail boxes. Also, bicyclists

riding on the curb side of sidewalks may accidentally drop off the sidewalk into the path of motor vehicle traffic.

The development of extremely wide sidewalks does not necessarily add to the safety of sidewalk bicycle travel, as wide sidewalks will encourage higher speed bicycle use and can increase potential for conflicts with motor vehicles at intersections as well as with pedestrians and fixed objects.

Sidewalk bike routes are considered only under special circumstances, such as to provide bike-way continuity along high-speed or heavily traveled roadways having inadequate space for bicyclists, and uninterrupted by driveways and intersections for long distances or on long, narrow bridges. Even then, the preferred solution is to widen the roadway width itself and/or decrease the sidewalk width to provide room on the roadway for bicycles.

However, whenever sidewalk bike routes are necessary, a special effort should be made to remove obstacles that will be hazardous to bicycle travel. Ramps are installed at the sidewalk approaches. If approach bikeways are two-way, sidewalk facilities are also two-way. Whenever bicyclists are directed to sidewalks, curb cuts are required at each intersection. Curb cuts are flush with the street to ensure that bicyclists are not subjected to the hazards of a vertical lip crossed at a flat angle, and are as wide as the approach bike trail. For information regarding the design of sidewalks on highway structures, refer to 1020.04(6).

In residential areas, sidewalk riding by recreational adult bicyclists and children too inexperienced to ride in the street is common. However, it is inappropriate to sign these facilities as bikeways.

- (d) **Class IV Bikeway (Shared Roadway With No Designation).** Most bicycle travel now occurs on streets and highways without bikeway designations. In most instances, the street or highway systems are adequate for safe and efficient bicycle travel, and bikeway signing and striping is unnecessary. Also, in some cases, the street or highway systems are not located along bicycle-demand corridors and it is inappropriate to designate them as bikeways regardless of roadway conditions (e.g., minor residential streets).

The State Operations and Maintenance Engineer is responsible for determining the sections of state highways from which bicycle traffic would be prohibited.

Many rural highways are used by touring bicyclists for intercity and recreational travel. In most cases, it

would be inappropriate to designate the highways as bikeways because of the limited use and the lack of continuity with other bike routes. However, the development and maintenance of at least 4 feet of paved shoulders with a standard edge stripe can significantly improve safety and convenience for bicyclists and motorists along such routes. This should be the goal to work towards. Where rumble strips are used on shoulders, the outside 3 feet should be left clear for bicycles.

## **1020.04 PEDESTRIAN FACILITIES (WALKWAYS)**

### **(1) General**

Walkways may be sidewalks, pedestrian grade separations, hiking trails, or walking trails. Sidewalks are parallel and immediately adjacent to streets and highways, and are normally used for utility purposes. Walking and hiking trails are independently aligned and generally serve recreational activities (Figure 1020-11).

Walkways are considered during project development, along with the other highway design components. The type of walkway provided is based on the roadside environment, pedestrian volumes, user age group, safety-economic analysis, and continuity of local walkways along or across WSDOT right of way. The type of walkway also depends on the access control of the highway as follows:

- (a) **Full Access Control.** Walking and hiking trails may be located within the highway right of way to connect trails outside the right of way, with the approval of the Assistant Secretary for Highways. Crossing of the highway will be by grade separation for both the trails and sidewalks.
- (b) **Partial Access and Modified Access Control.** Walking and hiking trails may be located between access points (interchanges or intersections) using full access control or modified access control guidelines. (Refer to Chapter 1420.) Sidewalks or trails may cross the highway at-grade with an intersecting cross road or by a grade separation.
- (c) **No Access Control.** Sidewalks can be provided along both sides of urban area highways that are used for pedestrian access to schools, parks, shopping areas, commercial areas, and transit stops. In urban residential areas, a sidewalk is to be provided on at least one side of the highway. The sidewalk(s) is located close to the right of way line.

In rural areas, sidewalks would be needed only at points of community development such as schools, businesses, industrial plants, and transit stops. The cost of sidewalks are justified by a study of the local conditions. Walking trails may be used to connect some of these areas.

Crossings are permitted on uncontrolled access highways at intersections and where significant foot traffic is generated. In business districts, marked crosswalks are normally provided at intersections and, although not recommended, may be provided mid-block where pedestrian traffic volumes require. In residential and rural areas, marked crosswalks are normally unnecessary. In the vicinity of schools, convalescent centers, local parks, or community centers, marked crosswalks may be justified through a study of local conditions.

Design standards for marked crosswalks and warrants for pedestrian signals are provided in the MUTCD.

## (2) Sidewalks

In urban and residential areas sidewalks are usually raised. In suburban areas foot traffic uses the highway shoulder, although raised sidewalks are provided in the vicinity of pedestrian traffic generators (see guidelines for traffic islands in Chapter 910). In either case, sidewalks are parallel and adjacent to a highway, and follow the same alignment.

(a) Standards for raised sidewalks, including curb cuts, are shown in the standard plans. The minimum width of sidewalks is 1.2 meters (4 feet) when separated from the traveled way by a planting strip. Planting strips shall be a minimum of 1 meter (3 feet) in width when used to separate sidewalks from the traveled way.

When a sidewalk is less than 1525 mm (5 feet) in width and separated from the traveled way by a planting strip, an unobstructed passing and turning space not less than 1525 mm (5 feet) by 1525 mm (5 feet) shall be provided at intervals of not more than 60 meters (200 feet) (see Figure 1020-13).

Where a sidewalk is separated from the traveled way with a curb only, the minimum sidewalk width shall be 1.8 meters (6 feet).

Sidewalks in areas of high pedestrian traffic such as at schools, businesses, industrial areas, and transit stops are wider than the minimum and paved to the curb in most cases. The cross slope on the sidewalk is toward the roadway at the rate of 2 percent.

Provide raised sidewalks on highway bridges when raised sidewalks exist on both ends of the bridge. (See Figure 1020-12.) A ramp with a slope of 1:20 or flatter is required to treat all abrupt raised sidewalk ends that are exposed to traffic.

(b) In rural areas, most pedestrians use the highway shoulders for walkways. These are usually not marked or signed for pedestrian traffic. In an area of heavy pedestrian use, an additional pavement width of up to 1.2 meters (4 feet) is added to the roadway to obtain a maximum shoulder width of 3 meters (10 feet).

(Refer to Chapter 440 for the roadway shoulder width for each particular highway classification.) A 200 mm (8-inch) solid white stripe is used to mark the edge of traveled way in these areas.

(c) Consider separating pedestrians from vehicular traffic with a traffic barrier when the posted speed is 70 km/h (45 mph) or greater and there is no other separation (such as a planting strip). Consider the following:

- volume and type of pedestrian traffic
- horizontal and vertical alignment
- impact on other forms of transportation (such as bicyclists)
- treatment of the ends of the barrier

Document in the design file the decision to install or not install a barrier in these instances.

In some cases, barrier separation may be considered at speeds less than 70 km/h (45 mph) depending on the volume and type of traffic.

Where pedestrian use facilities are located behind guardrail, cut the protruding guardrail bolts or install a rub rail to prevent snagging on the bolts. Provide a smooth finish to vertical concrete surfaces adjacent to the pedestrian facility to prevent snagging or abrasive injuries from contact with the surface.

## (3) Curb Cut Ramps

Design for curb cut ramps for the handicapped are included in the standard plans.

A curb cut ramp will be located between the crosswalk lines at each sidewalk-crosswalk junction. Curb cuts and crosswalks have the same clear width as the sidewalks. The actual location is determined by considering user convenience, crosswalk location, and curb drainage characteristics. In some instances it may be proper to locate one curb cut in the center of the curb return to serve perpendicular crosswalks.

## (4) Walking and Hiking Trails

Walking and hiking trails are a supplemental feature and are considered on a project by project basis.

These often have a natural surface and usually are provided on highway right of way to connect existing trails. Trails may be paved in the vicinity of rest areas and roadside points of interest, or where bicycle traffic is expected, and in urban areas.

The clear area around walking and hiking trails is 2.4 meters (8 feet) laterally and 3.0 meters (10 feet) vertically (see Figure 1020-11). Any trees or brush removed from this area is cut close to the ground, and intruding branches are trimmed flush with the tree trunk.

(a) Walking trails are a minimum of 1.2 meters (4 feet) wide and have a maximum grade of 10 percent. The

alignment of the trail is independent and beyond the clear zone (recovery area) of a parallel highway.

- (b) Hiking trails have a minimum surface width of 0.6 meter (2 feet) and maximum sustained grade of 10 percent. The grade may be up to 20 percent maximum for a short distance.

All voids in hiking trails constructed on riprap, talus slide, or other rock slope are filled at least 0.6 meter (2 feet) below the rock surface. Place 75 mm (3 inches) of cover with soil or small rock over the filled surface.

#### (5) Pedestrian Grade Separations

In areas where highway crossing opportunities are infrequent and heavy pedestrian traffic is indicated, pedestrian grade separations may be appropriate, provided the following requirements are fulfilled:

- (a) The following must be satisfied on all highways: The conditions that require the crossing are permanent. There is no possibility that the replanning of bus routes or school districts in the near future will eliminate the need for such a structure in the vicinity of a school or other heavily used facility.
- (b) The following, plus the above, must be satisfied on fully controlled access highways: The estimated volume for the proposed structure is greater than 200 pedestrians per hour for two hours each day, and the additional average walking distance for 85 percent of the pedestrians having the shortest walking distance would exceed 800 meters ( $\frac{1}{2}$  mile) if there were no structure.
- (c) Either one of the following, plus the listing under (a) must be satisfied on partially controlled and non-controlled access highways:
  1. An economic analysis indicates that the yearly cost of the separation structure is less than the yearly cost of installing and maintaining the required signal and appurtenances (signs, cross-walk painting, fencing, etc.). Before making this comparison, additional average walking distance for 85 percent of the pedestrians having the shortest walking distance must exceed 800 meters ( $\frac{1}{2}$  mile) if there were no structure.
  2. The vehicular and pedestrian traffic is so great that a traffic signal could not handle both without being overloaded during peak hour traffic.

Pedestrian grade separation bridges or tunnels are designed on a project by project basis.

Railings 1370 mm (4 feet 6 inches) high are provided on pedestrian bridges. The bridge rail is designed so that a 150 mm (6-inch) sphere cannot pass through. In addition, 760 mm (2 feet 6 inch) to 860 mm (2 feet 10 inch) high handrail is provided for slopes greater than 5 percent. Overhead fencing is advisable in areas where lots of young children are anticipated. This is to discourage the tossing of objects or people jumping onto lower roadways.

The clear width and overhead clearance are 2.4 m (8 feet) and 3.0 m (10 feet) respectively. For bridges, the vertical clearance to the roadway below is 5.334 m (17 feet 6 inches) minimum.

Ramps with landings are used for the pedestrian grade separation approaches. A ramp has a maximum grade of 8.33 percent with a maximum rise of 750 mm (30 inches) between landings. When an approach ramp changes directions between two successive landings, the inside radius of the ramp should be 9 m (30 feet) or greater. Landings are a minimum of 1525 mm (5 feet) in length except at the bottom where they are 1830 mm (6 feet) in length. They are of sufficient width to allow wheelchairs to maneuver and at least as wide as the ramp run leading to them. If ramps change direction at intermediate landings, the minimum landing size is 1525 mm (5 feet) by 1525 mm (5 feet). Stairways, when provided, are designed in accordance with the specifications in the standard plans.

Pedestrian tunnels are aligned with the approaching walkways to provide continuous vision throughout, and are illuminated.

#### (6) Illumination

Design guidance for illumination is in Chapter 840.

#### (7) Signing

Design guidance for signing is in Chapter 820, and in the MUTCD.

### 1020.05 EQUESTRIAN AND WATERCRAFT FACILITIES

In some areas it may be appropriate to incorporate equestrian or watercraft trails within the right of way. It is anticipated that there will be only occasional need for these facilities; consequently, specific design criteria are not presented. These facilities will be designed on an individual basis, considering safety, access control, and conflict with other travel modes.

V:DM10

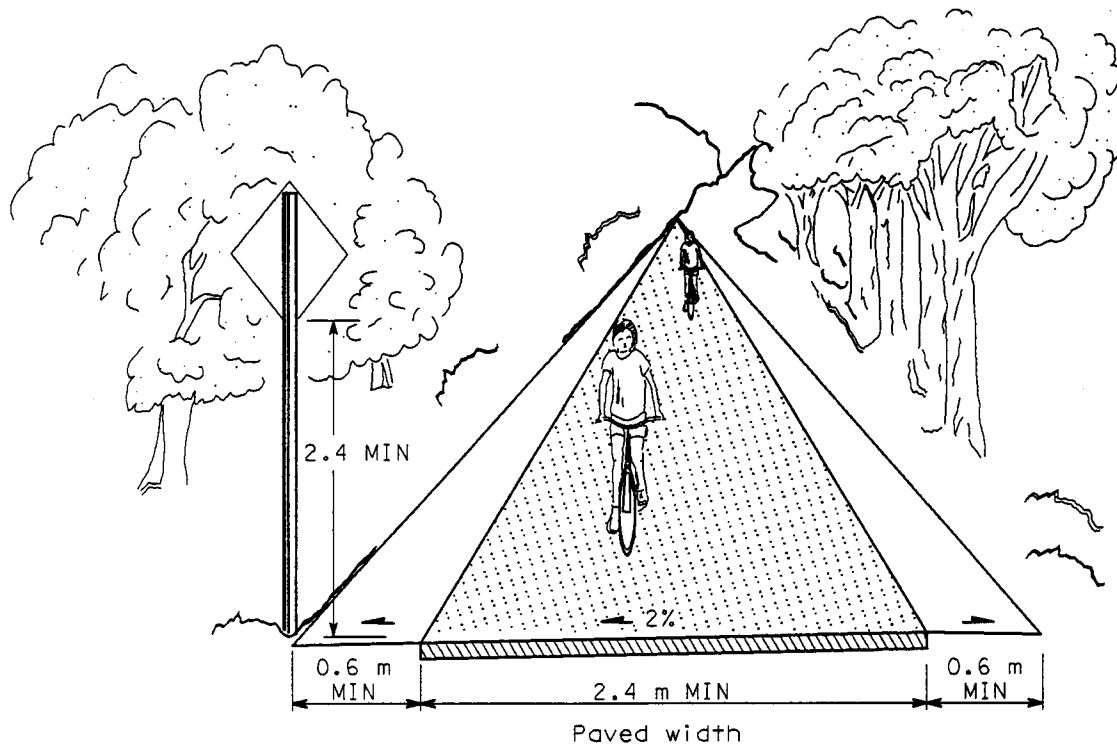

TYPICAL CROSS SECTION

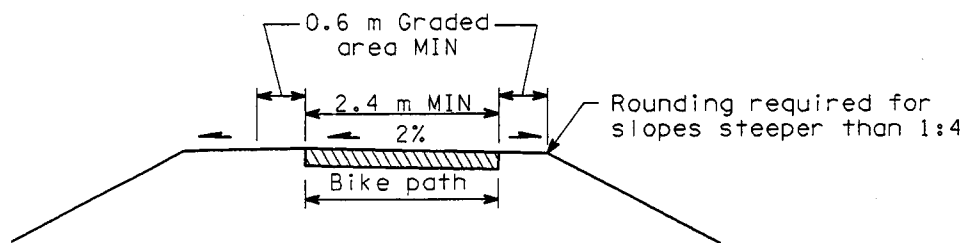

**TWO-WAY BIKE PATH ON SEPARATED RIGHT OF WAY**

Figure 1020-1a  
(Metric)



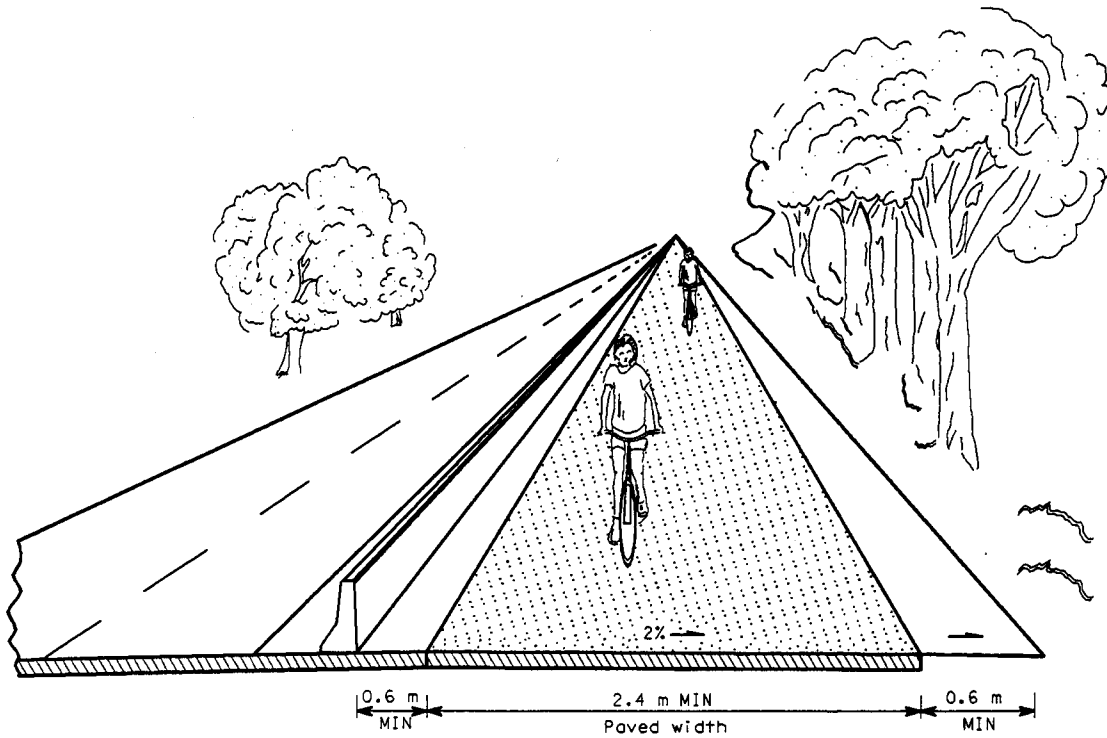

TYPICAL CROSS SECTION BIKE PATH ALONG HIGHWAY

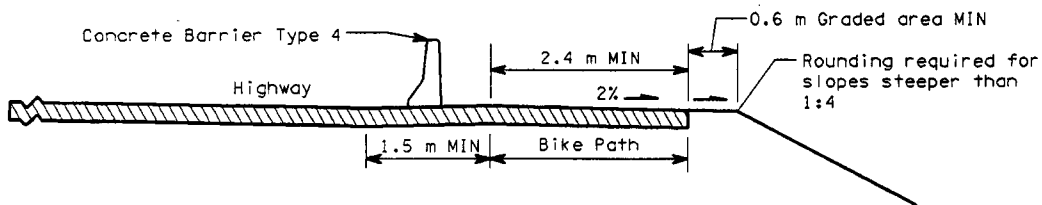

**TWO-WAY BIKE PATH ALONG HIGHWAY**

Figure 1020-1b  
(Metric)

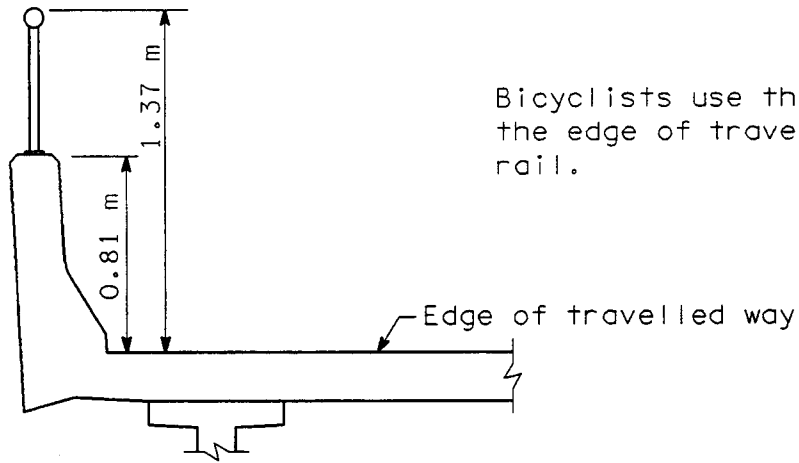

Bicyclists use the shoulder between the edge of travelled way and bridge rail.

UNSEPARATED (Class II, III, and IV Bikeways)

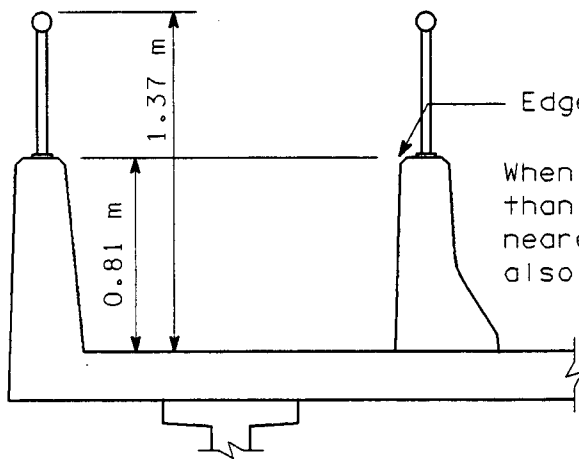

Edge of bikeway

When the edge of bikeway is closer than 1.5 meters to the edge of the nearest travelled lane, a railing is also provided on the inner barrier.

SEPARATED (Class I Bikeways Only)

### BIKEWAYS ON HIGHWAY BRIDGES

Figure 1020-1c  
(Metric)

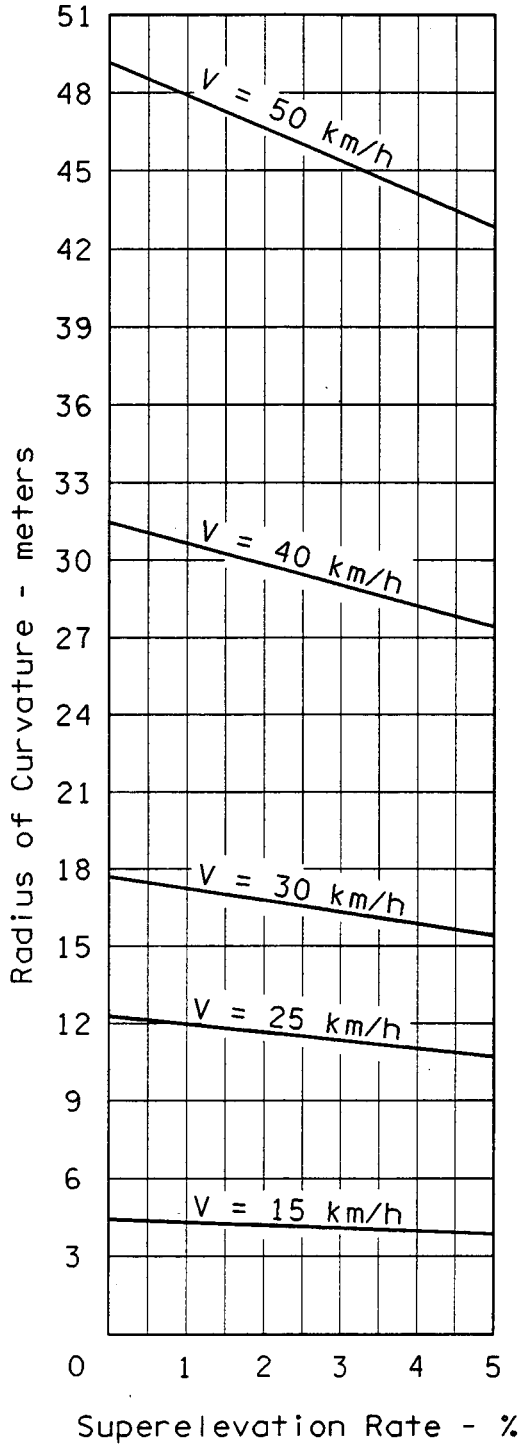

Figure at left is plot of:

$$\frac{V^2}{gR} = \frac{\tan \theta + f}{1 - f \tan \theta}$$

where:

- V = velocity, m/sec
- g = acceleration due to gravity, m/sec<sup>2</sup>
- R = radius of curvature, m
- f = coefficient of friction on dry pavement = 0.4 (based on max. 20° lean)
- tan θ = superelevation rate, m/m

**CURVE RADII & SUPERELEVATIONS**

Figure 1020-2  
(Metric)

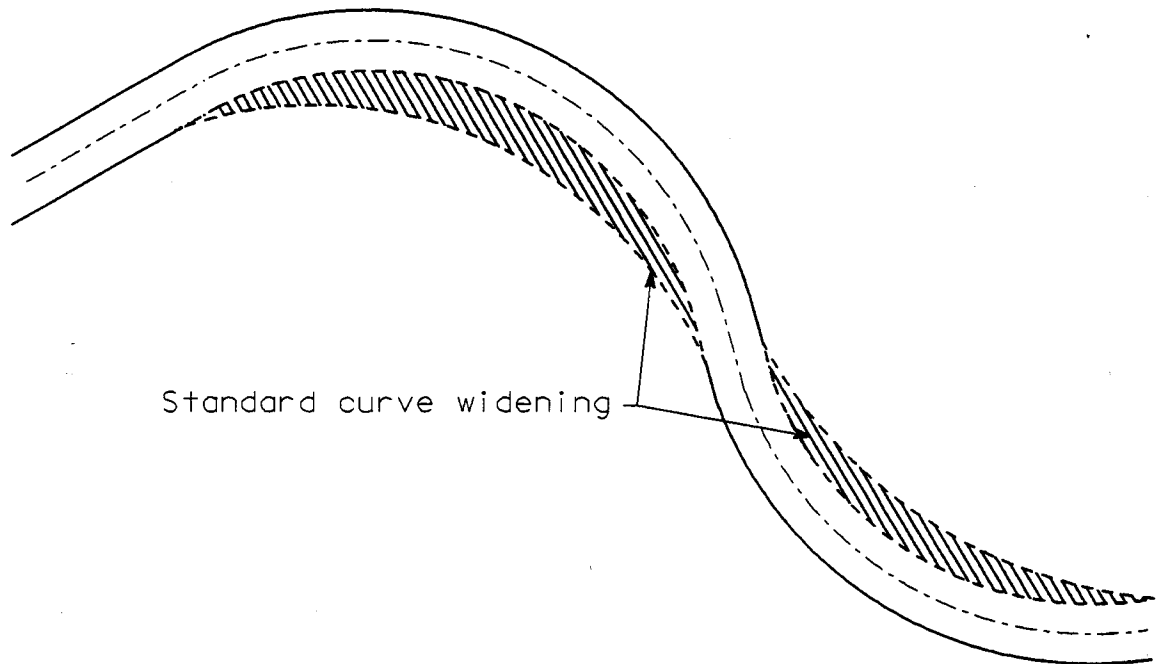

Radius (meters)	Additional Pavement Width (meters)
0 - 7.5	1.2
7.5 - 15.0	0.9
15.0 - 22.5	0.6
22.5 - 30.0	0.3
30.0+	0

**BIKEWAY CURVE WIDENING FOR VARIOUS RADII**

Figure 1020-3  
(Metric)

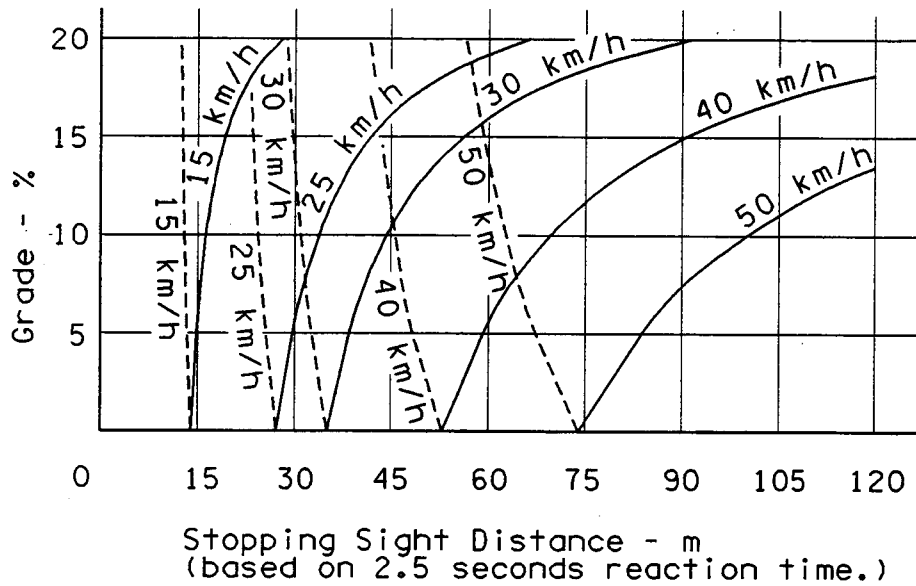

$$S = \frac{v^2}{255(f \pm G)} + 0.694 V$$

Descend (-G) \_\_\_\_\_

Ascend (+G) - - - - -

where: S = Stopping Sight Distance, m  
 V = Velocity, km/h  
 f = Coefficient of Friction (use 0.25)  
 G = Grade (rise/run)

### STOPPING SIGHT DISTANCE

Figure 1020-4  
(Metric)

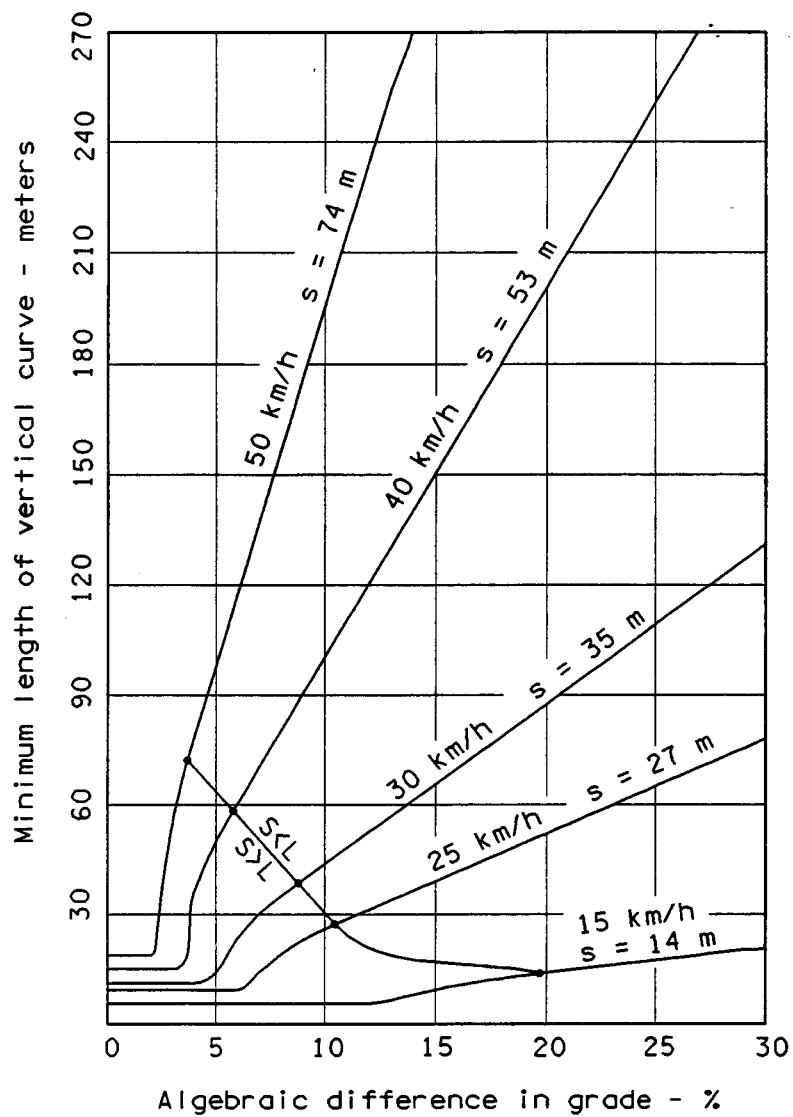

$$L = \frac{AS^2}{100(\sqrt{2h_1} + \sqrt{2h_2})^2} \text{ when } S < L$$

$$L = 2S - \frac{200(\sqrt{h_1} + \sqrt{h_2})^2}{A} \text{ when } S > L$$

where: S = Stopping sight distance  
 A = Algebraic difference in grade  
 $h_1$  = 1.4 m (eye height of cyclist)  
 $h_2$  = 0 m (height of object)  
 $L_{MIN}$  = 0.375 vertical curve length

### SIGHT DISTANCES FOR CREST VERTICAL CURVES

Figure 1020-5  
 (Metric)

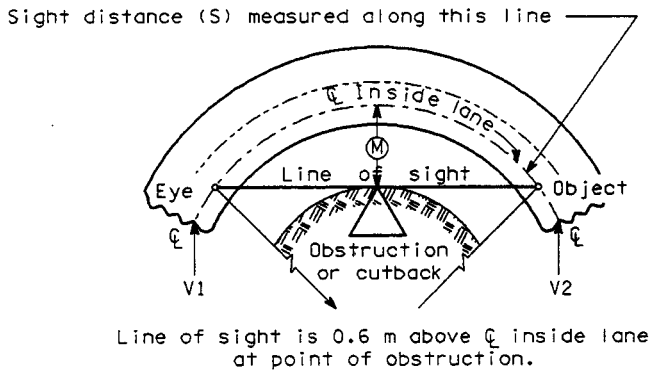

S = Sight distance in meters  
 R = Radius of C inside lane in meters  
 M = Distance from C inside lane in meters  
 V = Design speed for S in km/h

Angle is expressed in degrees

$$M = R \left[ \text{vers} \left( \frac{28.65S}{R} \right) \right] = R \left( 1 - \cos \frac{28.65S}{R} \right)$$

$$S = \frac{R}{28.65} \left[ \cos^{-1} \left( \frac{R-M}{R} \right) \right]$$

(For a one-way facility)

Formula applies only when S is equal to or less than length of curve.

$S = S_{V1} + S_{V2}$  (for a two-way facility)  
 where  $S_{V1}$  = sight distance for vehicle 1  
 $S_{V2}$  = sight distance for vehicle 2

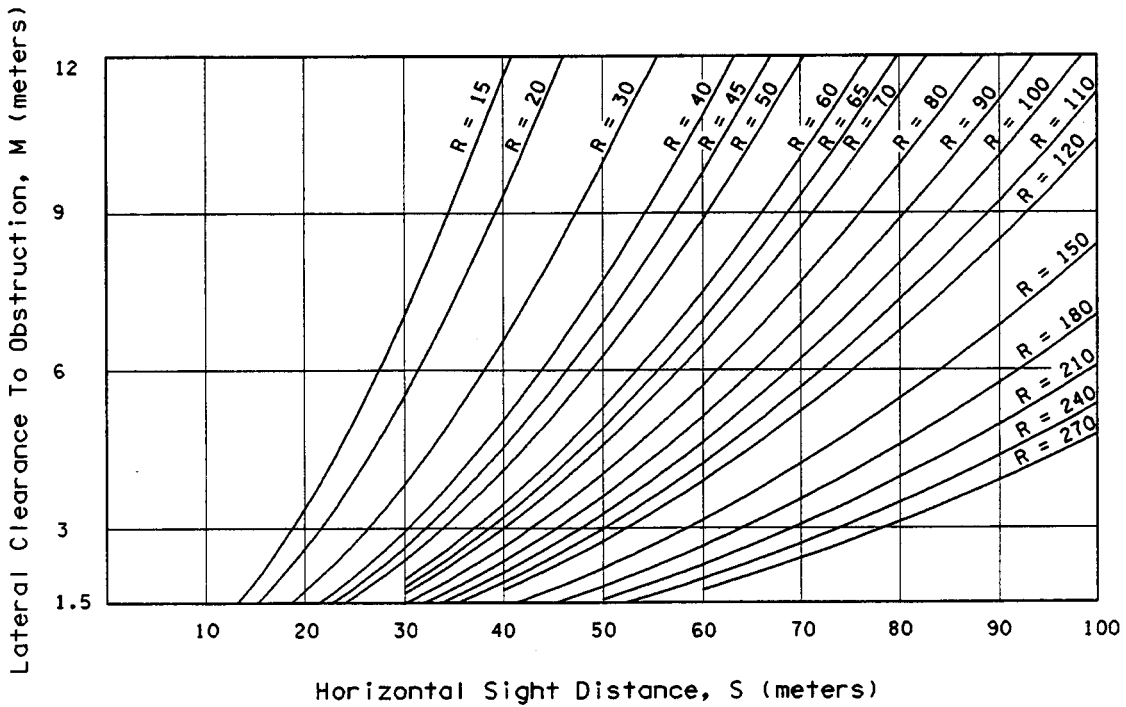

**LATERAL CLEARANCES ON HORIZONTAL CURVES**

Figure 1020-6  
 (Metric)

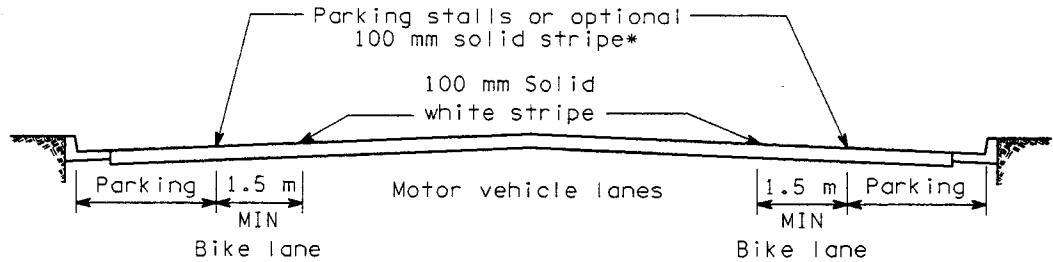

\* The optional solid white stripe may be advisable where stalls are unnecessary (because parking is light) but there is concern that motorists may misconstrue the bike lane to be a traffic lane.

### DESIGN A STRIPED PARKING

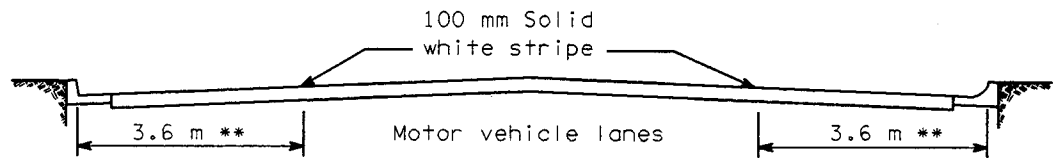

\*\* 3.9 m - 4.2 m is recommended where there is substantial parking or turnover of parked cars is high (eg, commercial areas).

### DESIGN B PARKING PERMITTED WITHOUT PARKING STRIPE OR STALL

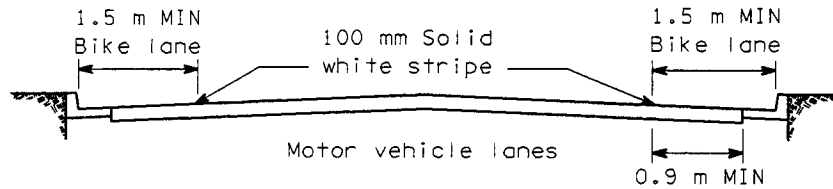

### DESIGN C PARKING PROHIBITED

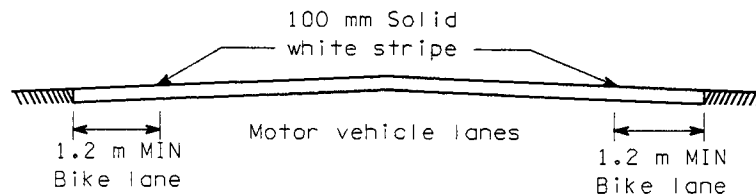

### DESIGN D TYPICAL ROADWAY IN RURAL AREAS

## TYPICAL BIKE LANE CROSS SECTIONS

Figure 1020-7  
(Metric)



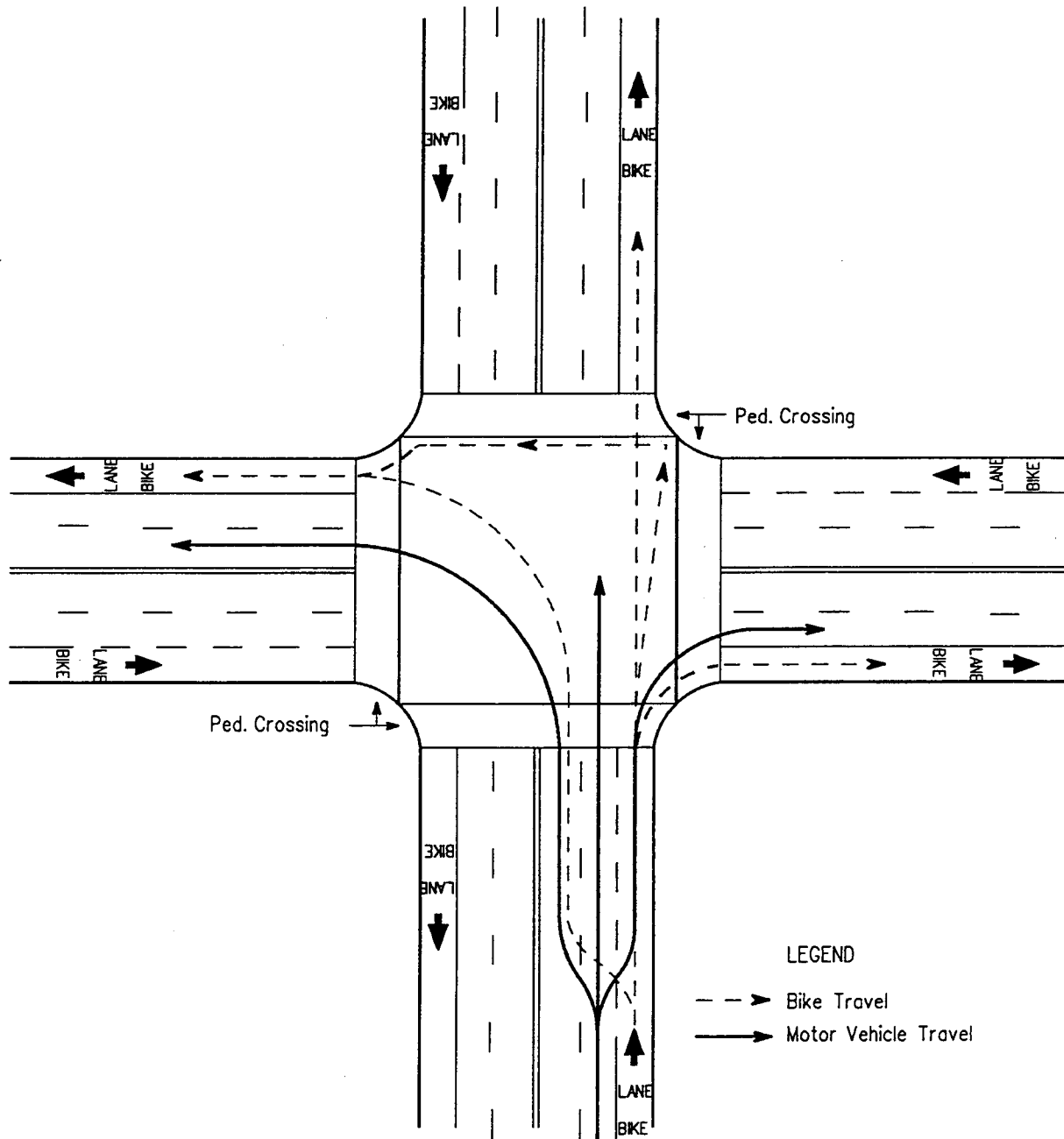

**TYPICAL BICYCLE/AUTO MOVEMENTS AT INTERSECTION OF MULTILANE STREETS**

Figure 1020-8

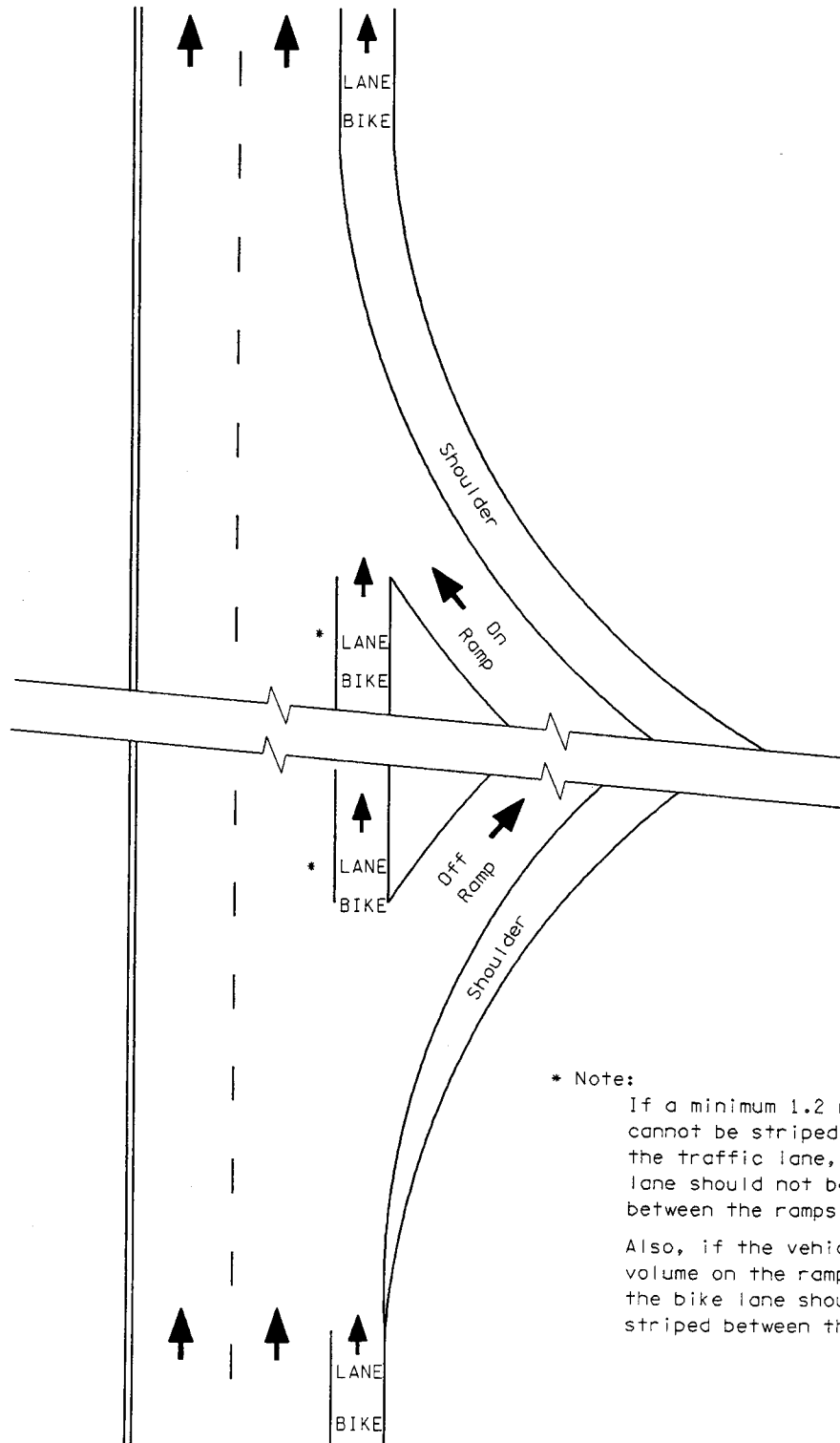

\* Note:  
 If a minimum 1.2 m bike lane cannot be striped outside the traffic lane, the bike lane should not be striped between the ramps.  
 Also, if the vehicular traffic volume on the ramp is high, the bike lane should not be striped between the ramps.

**BIKE LANE RAMP CROSSING**

Figure 1020-9  
 (Metric)

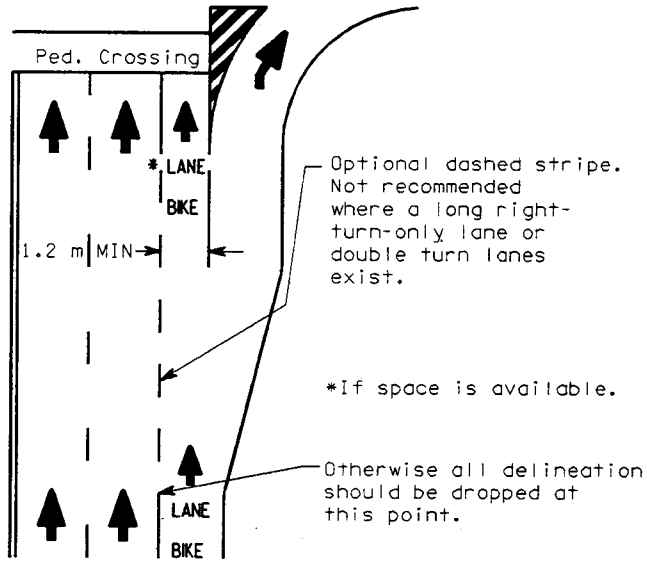

RIGHT-TURN-ONLY LANE

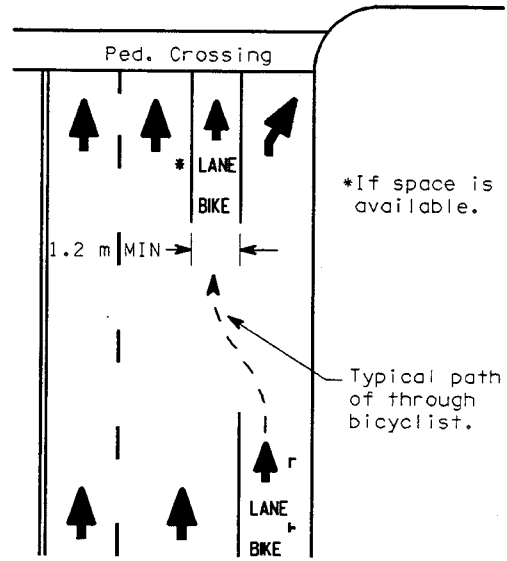

PARKING AREA BECOMES RIGHT-TURN-ONLY LANE

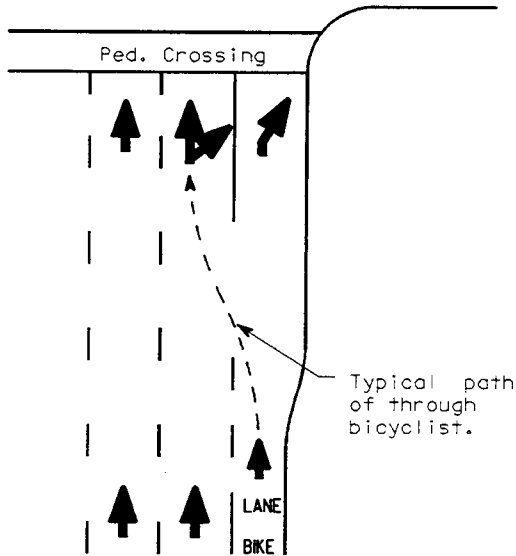

OPTIONAL DOUBLE RIGHT-TURN-ONLY LANE

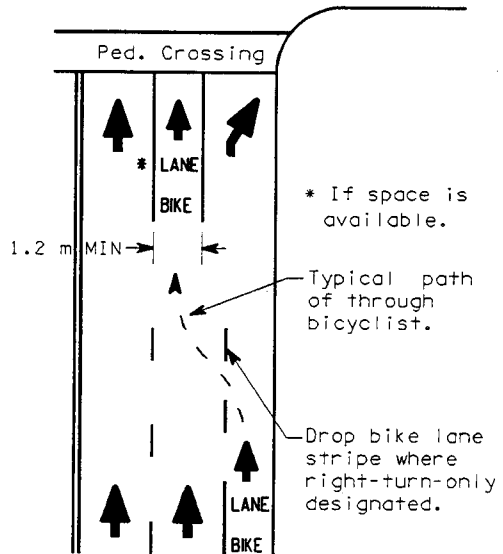

RIGHT LANE BECOMES RIGHT-TURN-ONLY LANE

**BIKE LANES APPROACHING MOTORISTS' RIGHT-TURN-ONLY LANES**

Figure 1020-10  
(Metric)

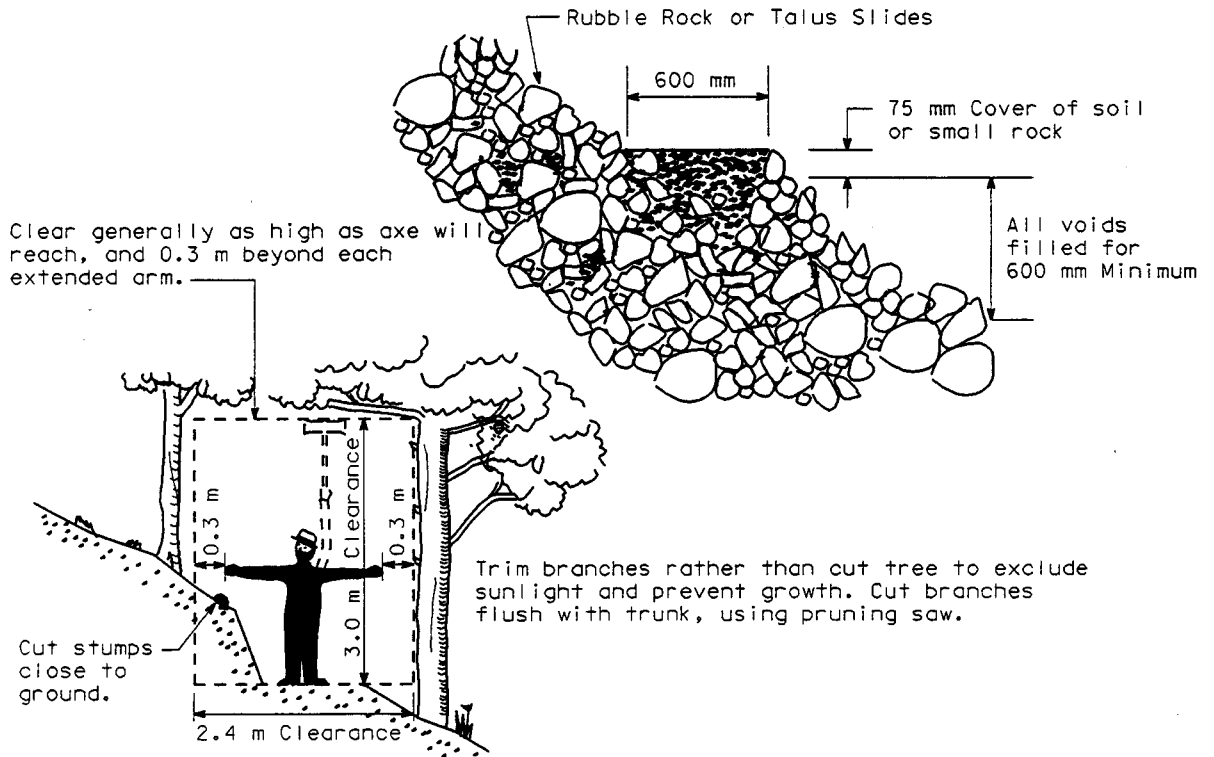

Width	0.6 m Minimum tread
Grade	20% Maximum short, 10% Maximum sustained
Alignment	Independent and located beyond 9.0 m safety zone
Clearances	3.0 m Vertical, 2.4 m Lateral
Surface	Gravel or natural material
Access Control	As required (see text)

## GUIDELINES FOR HIKING TRAILS

Figure 1020-11  
(Metric)

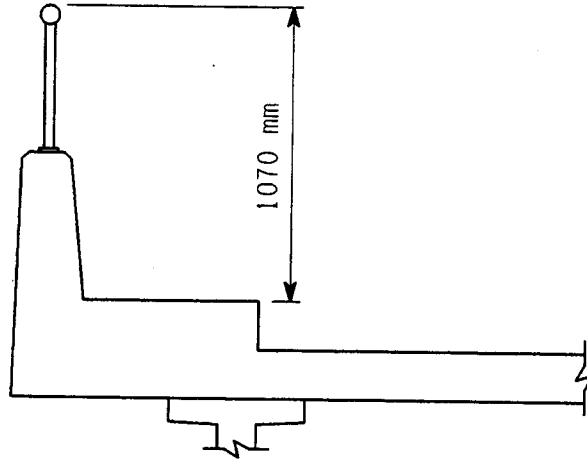

SIDEWALK IN URBAN AREAS

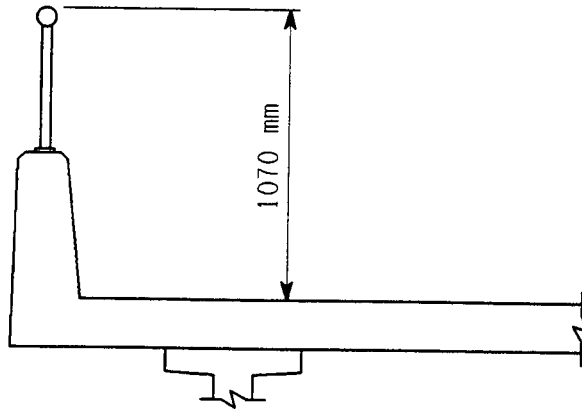

SIDEWALK IN RURAL AREAS

**WALKWAYS ON HIGHWAY BRIDGES**

Figure 1020-12  
(Metric)

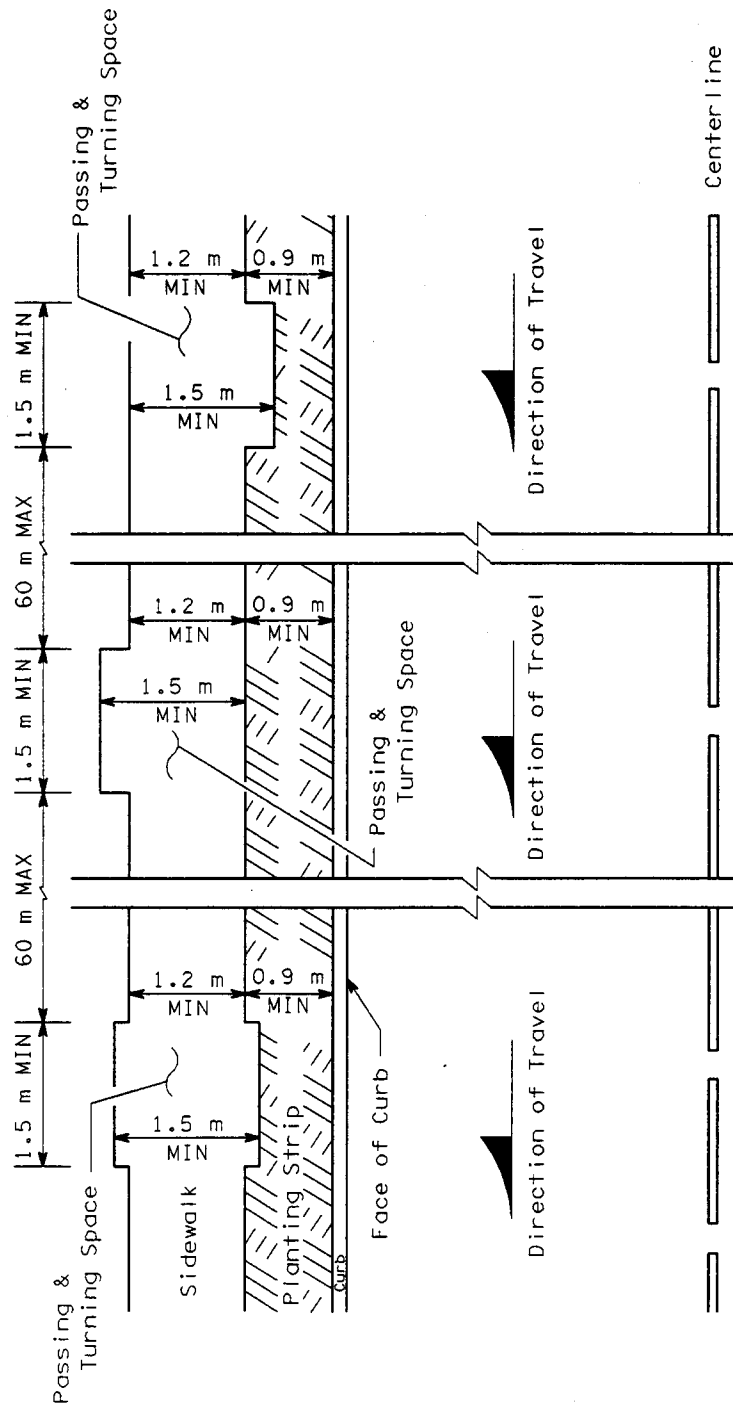

**HANDICAP PASSING AND TURNING SPACE FOR SIDEWALKS**

Figure 1020-13  
(Metric)



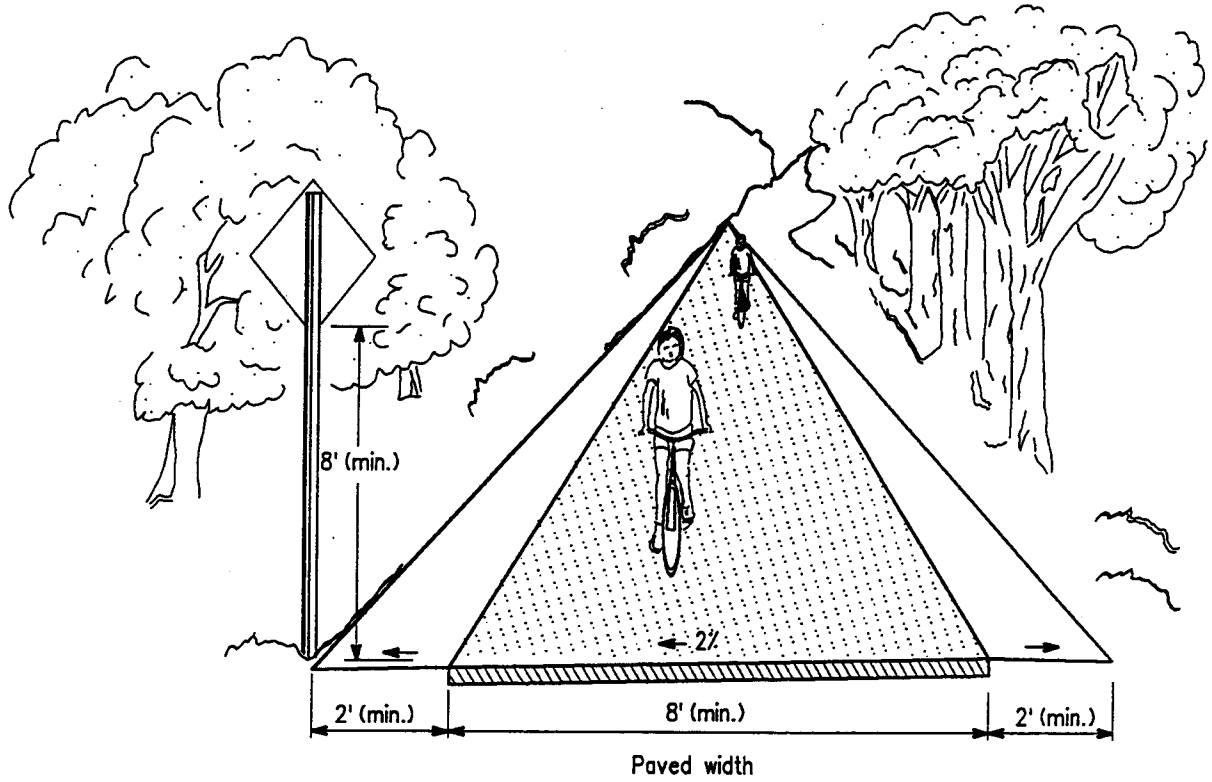

TYPICAL CROSS SECTION

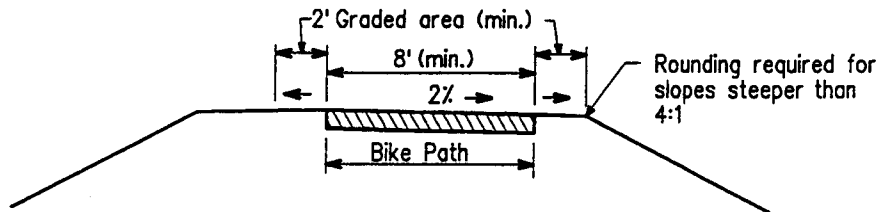

**TWO-WAY BIKE PATH ON SEPARATED RIGHT OF WAY**

Figure 1020-1a



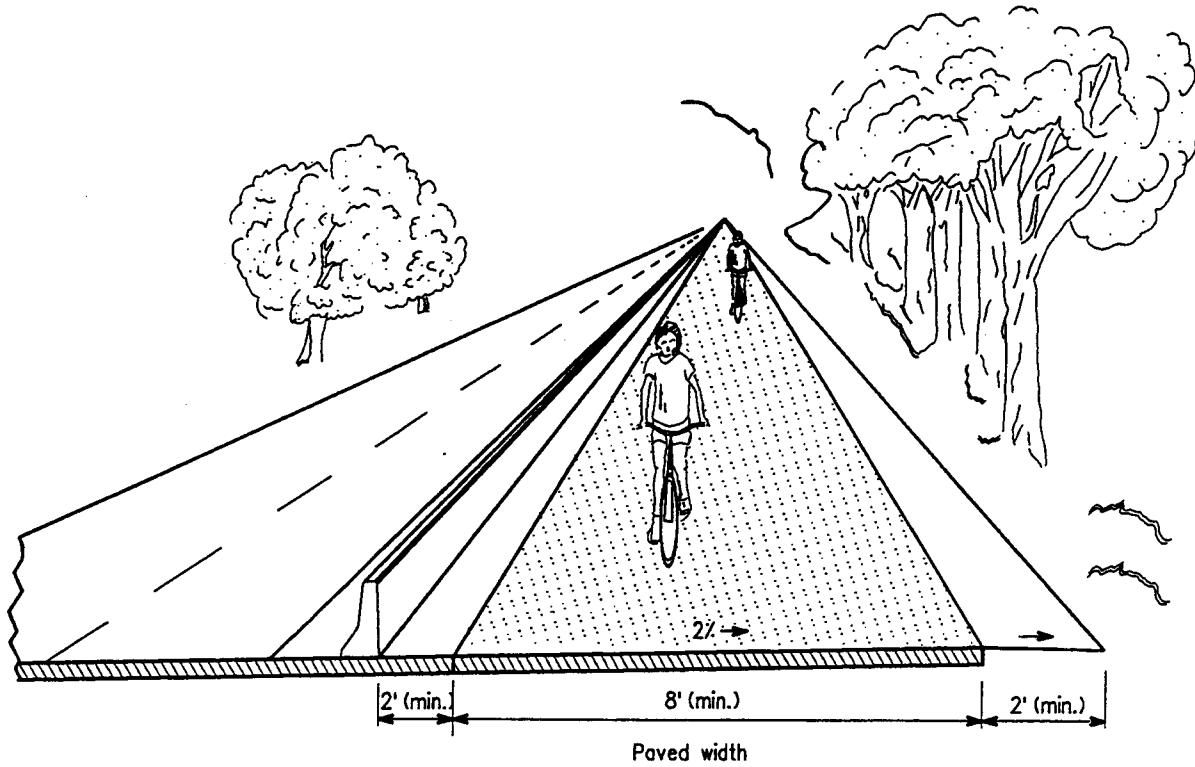

TYPICAL CROSS SECTION BIKE PATH ALONG HIGHWAY

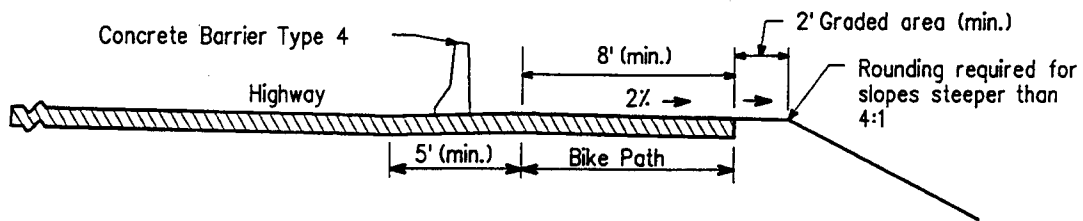

**TWO-WAY BIKE PATH ALONG HIGHWAY**

Figure 1020-1b

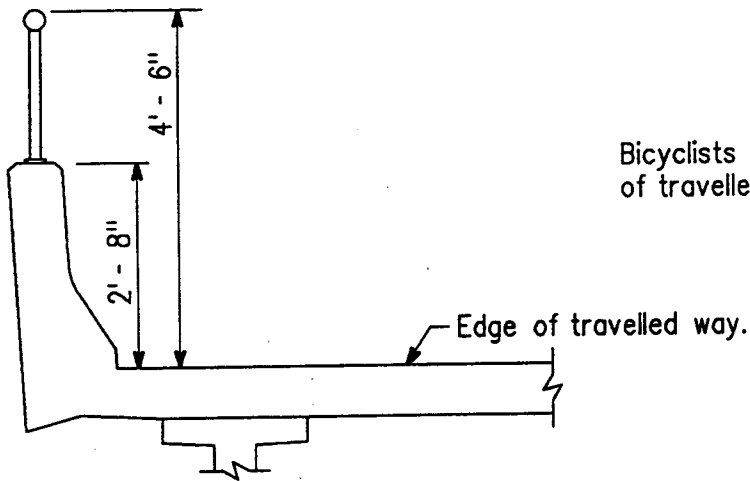

Bicyclists use the shoulder between the edge of travelled way and the bridge rail.

UNSEPARATED (Class II, III, & IV Bikeways)

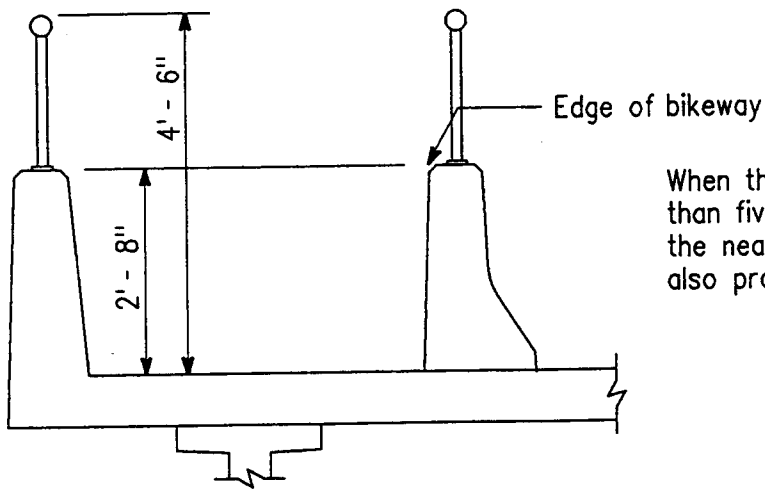

When the edge of bikeway is closer than five (5) feet to the edge of the nearest travelled lane, a railing is also provided on the inner barrier.

SEPARATED (Class I Bikeways Only)

### BIKEWAYS ON HIGHWAY BRIDGES

Figure 1020-1c

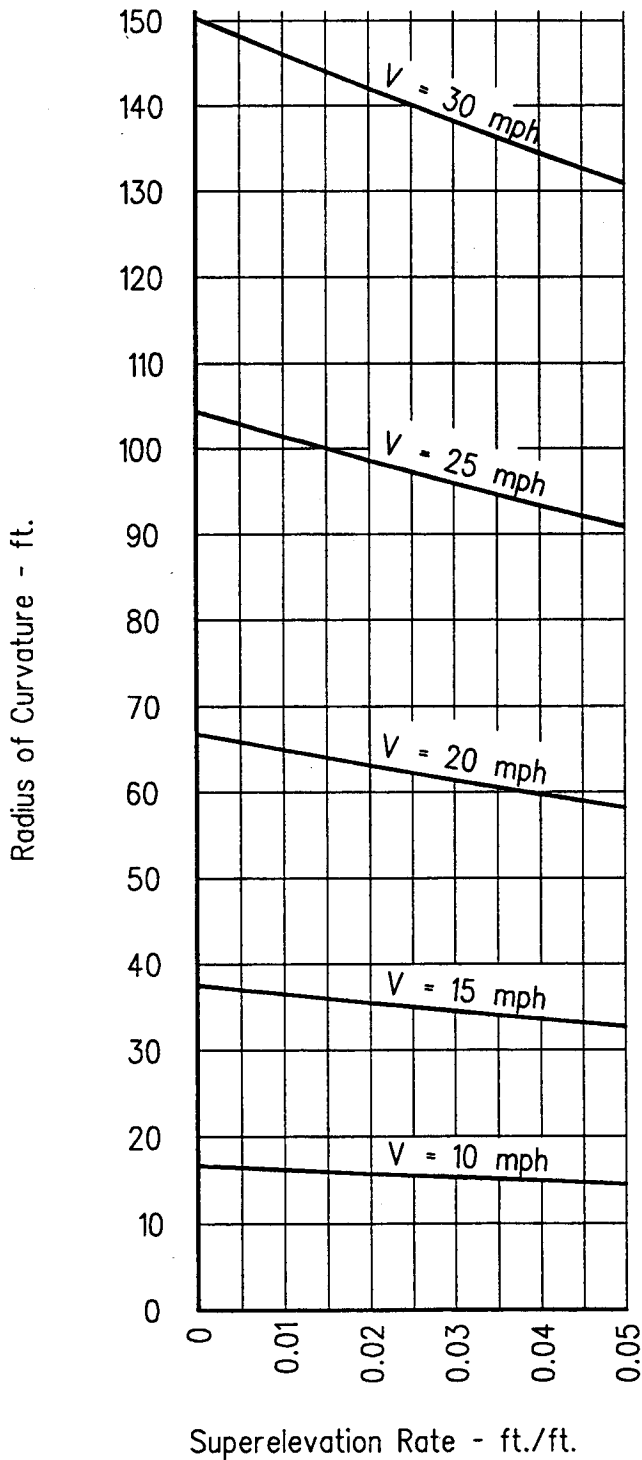

Figure at left is plot of:

$$\frac{V^2}{gR} = \frac{\tan \theta + f}{1 - f \tan \theta}$$

where:

- V = velocity, ft./sec.
- g = acceleration due to gravity ft./ sec.<sup>2</sup>
- R = radius of curvature, ft.
- f = coefficient of friction  
on dry pavement = 0.4  
(based on max. 20° lean)

$\tan \theta$  = superelevation rate, ft./ft.

### CURVE RADII & SUPERELEVATIONS

Figure 1020-2

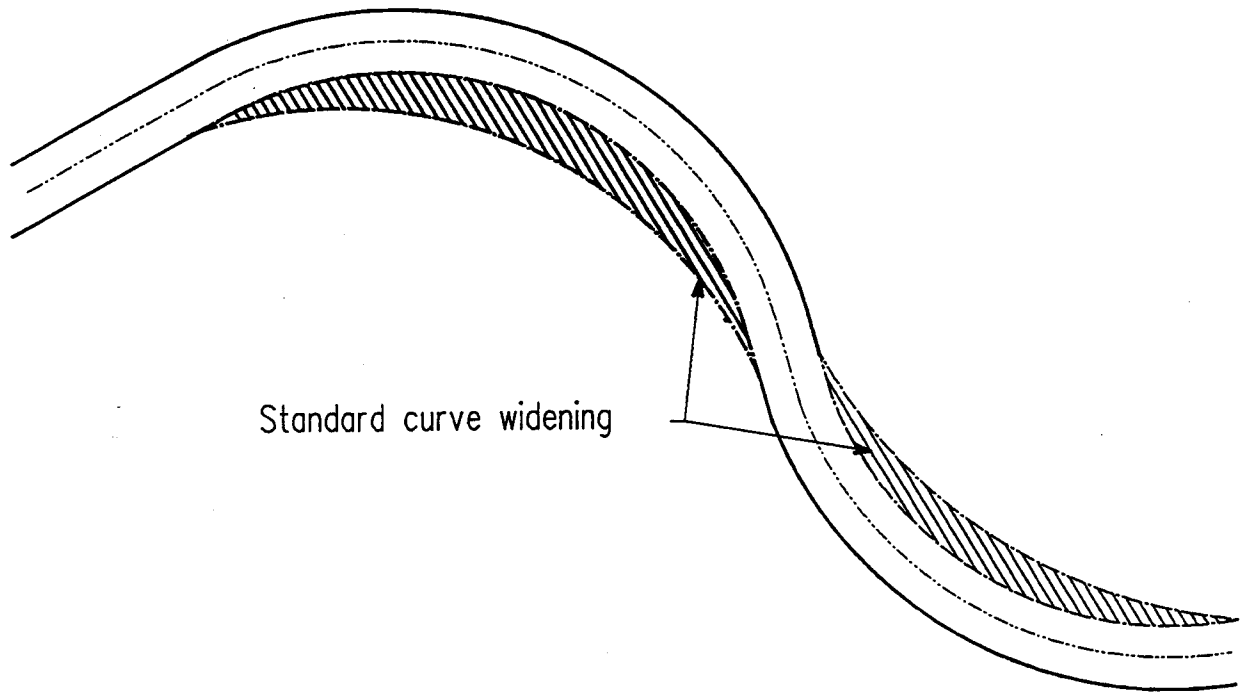

Radius (feet)	Additional Pavement Width (feet)
0 - 25	4
25 - 50	3
50 - 75	2
75 - 100	1
100 +	0

**BIKEWAY CURVE WIDENING FOR VARIOUS RADII**

Figure 1020-3

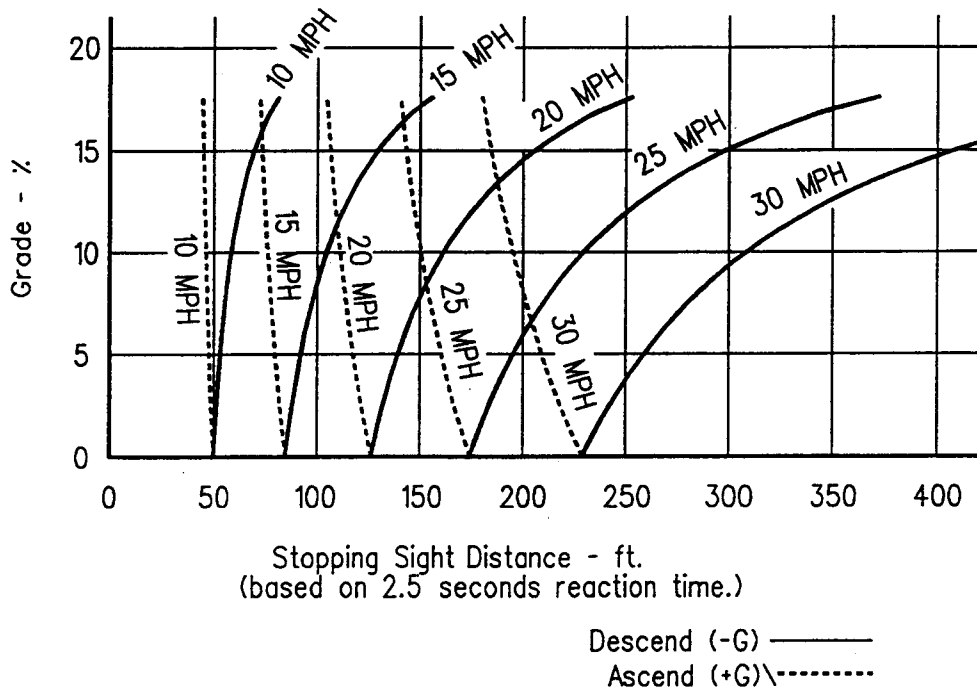

$$S = \frac{V^2}{30(f \pm G)} + 3.67 V$$

where: S - Stopping Sight Distance, ft.  
V - Velocity, mph  
f - Coefficient of Friction (use 0.25)  
G - Grade Ft./Ft.(rise/run)

### STOPPING SIGHT DISTANCE

Figure 1020-4

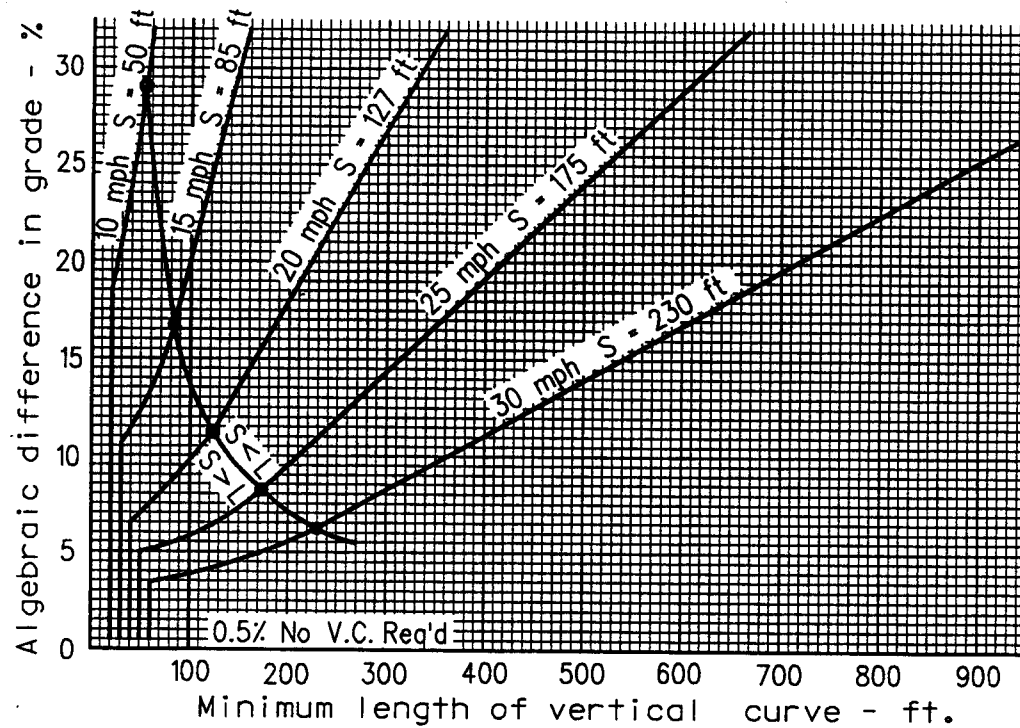

$$L = \frac{AS^2}{100(\sqrt{2h_1} + \sqrt{2h_2})^2} \quad \text{when } S < L$$

$$L = 2S - \frac{200(\sqrt{h_1} + \sqrt{h_2})^2}{A} \quad \text{when } S > L$$

where: S = Stopping sight distance.  
 A = Algebraic difference in grade.  
 $h_1 = 4\frac{1}{2}$  ft. (eye height of cyclist)  
 $h_2 = 1\frac{1}{3}$  ft. (Height of object)  
 L = Minimum vertical curve length.

### SIGHT DISTANCES FOR CREST VERTICAL CURVES

Figure 1020-5

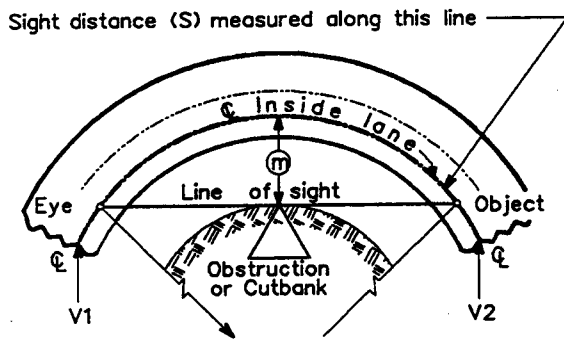

Line of sight is 2.0' above  $\mathcal{C}$  inside lane at point of obstruction.

S = Sight distance in feet  
 R = Radius of  $\mathcal{C}$  inside lane in feet  
 m = Distance from  $\mathcal{C}$  inside lane in feet  
 V = Design speed for S in M.P.H.

Angle is expressed in degrees

$$m = R \left[ \text{vers} \left( \frac{28.65S}{R} \right) \right] - R \left( 1 - \cos \frac{28.65S}{R} \right)$$

$$S = \frac{R}{28.65} \left[ \cos^{-1} \left( \frac{R-m}{R} \right) \right]$$

(For a one-way facility)

Formula applies only when S is equal to or less than length of curve.

S =  $S_{V1} + S_{V2}$  (For a two-way facility)  
 where  $S_{V1}$  = Sight distance for vehicle 1  
 $S_{V2}$  = Sight distance for vehicle 2

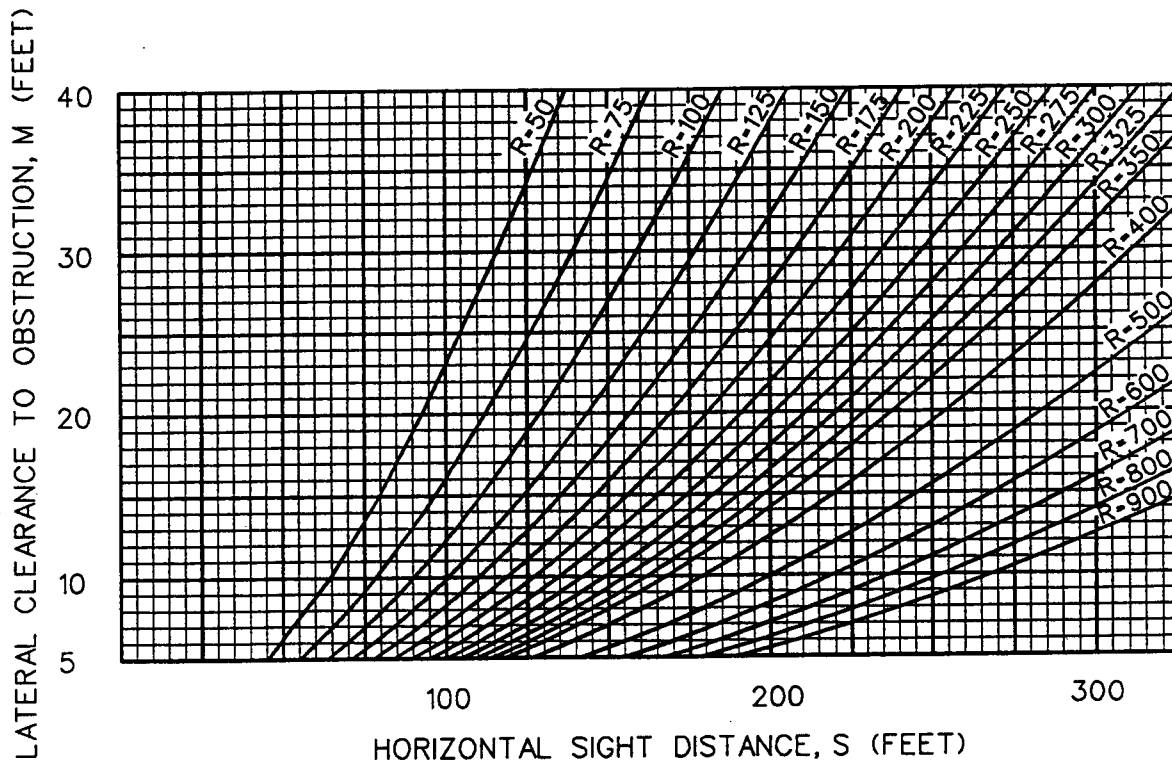

### LATERAL CLEARANCES ON HORIZONTAL CURVES

Figure 1020-6

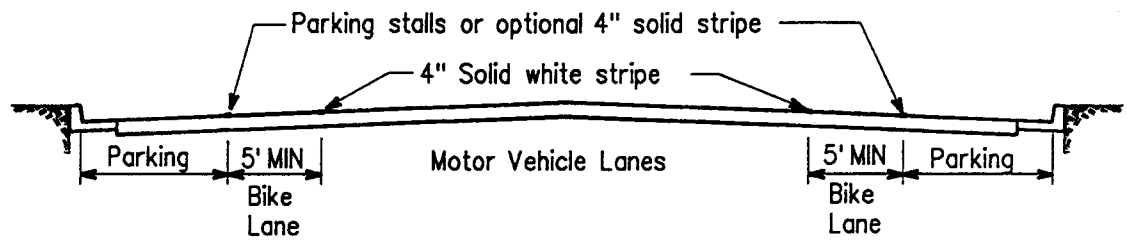

- \* The optional solid white stripe may be advisable where stalls are unnecessary (because parking is light) but there is concern that motorists may misconstrue the bike lane to be a traffic lane.

### DESIGN A STRIPED PARKING

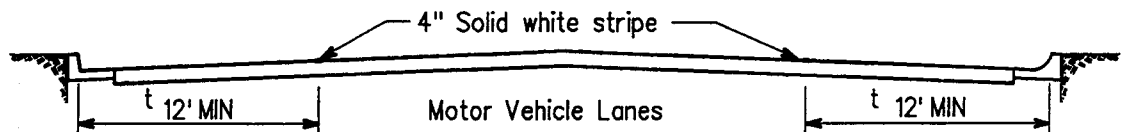

- <sup>t</sup> 13' - 14' is recommended where there is substantial parking or turnover of parked cars is high (e.g., commercial areas).

### DESIGN B PARKING PERMITTED WITHOUT PARKING STRIPE OR STALL

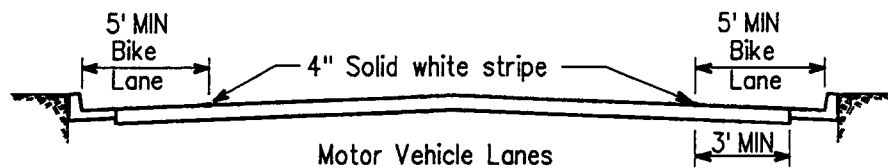

### DESIGN C PARKING PROHIBITED

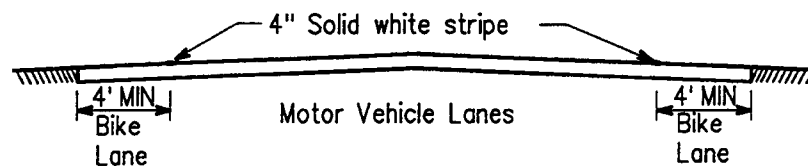

### DESIGN D TYPICAL ROADWAY IN RURAL AREAS

## TYPICAL BIKE LANE CROSS SECTIONS

Figure 1020-7



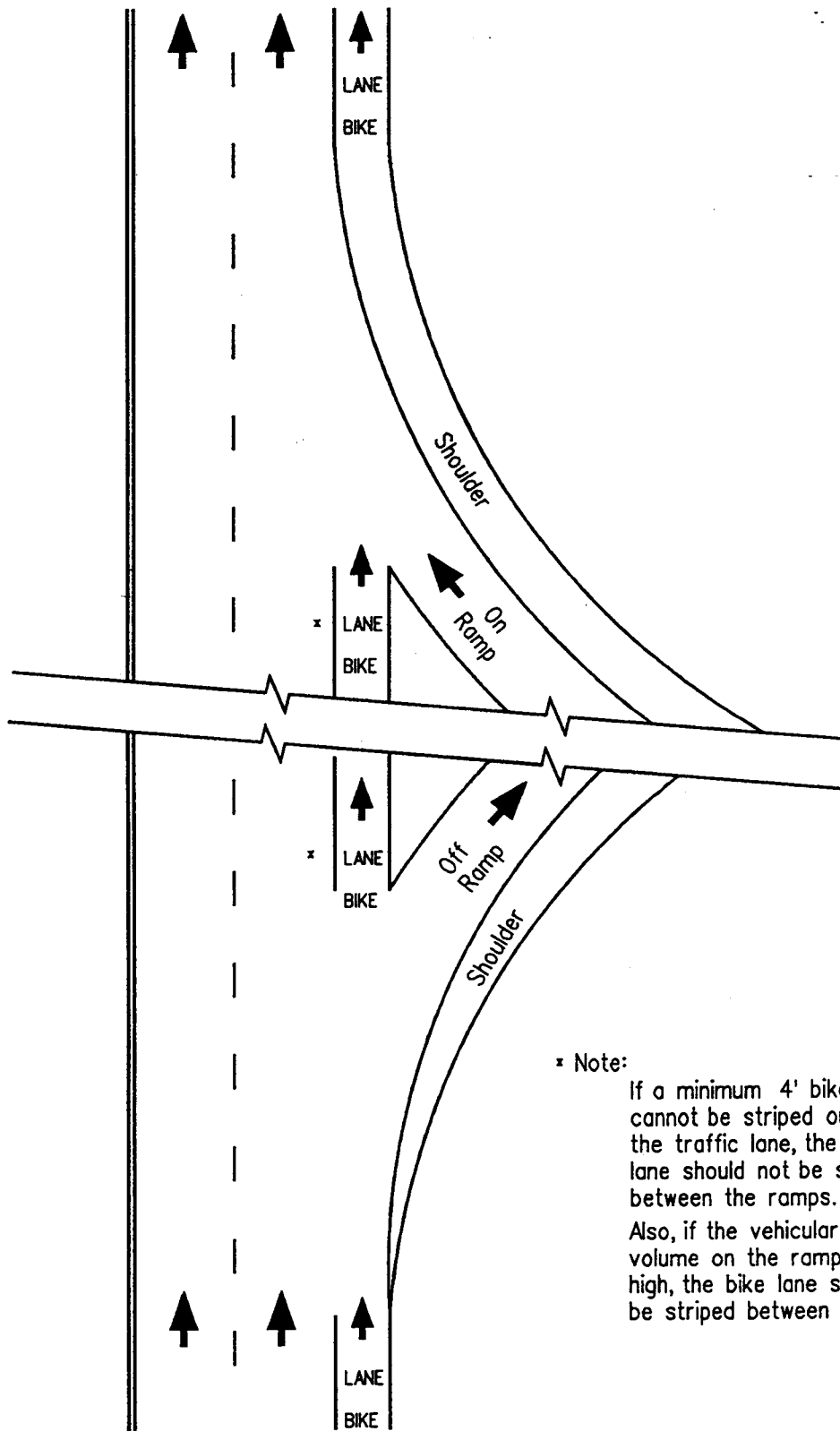

\* Note:  
 If a minimum 4' bike lane cannot be striped outside the traffic lane, the bike lane should not be striped between the ramps.  
 Also, if the vehicular traffic volume on the ramp is high, the bike lane should not be striped between the ramps.

**BIKE LANE RAMP CROSSING**

Figure 1020-9

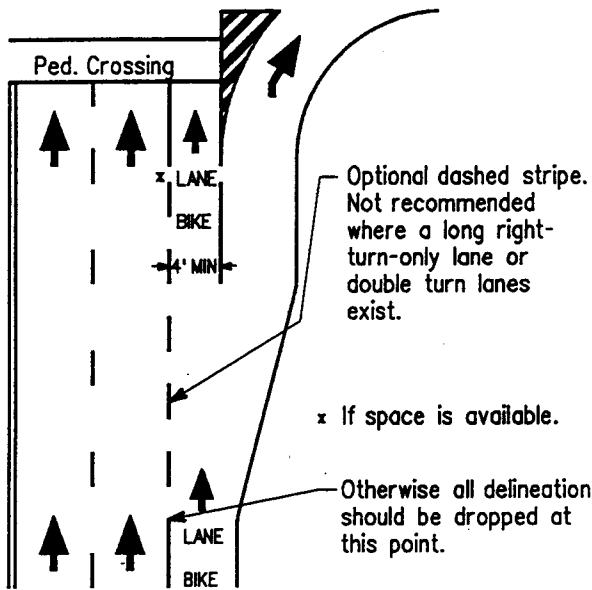

RIGHT-TURN-ONLY LANE

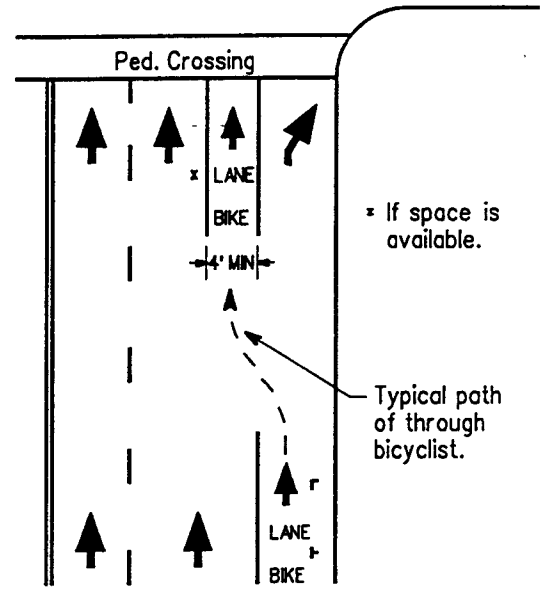

PARKING AREA BECOMES RIGHT-TURN-ONLY LANE

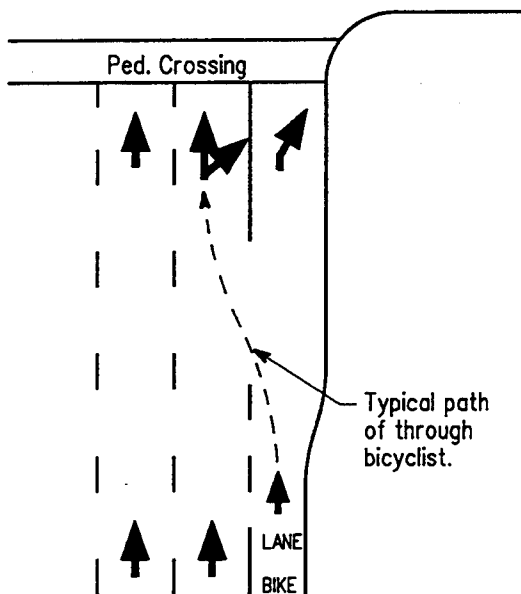

OPTIONAL DOUBLE RIGHT-TURN-ONLY LANE

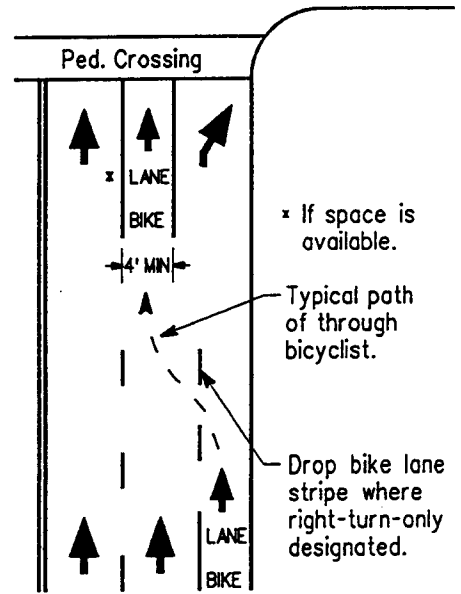

RIGHT LANE BECOMES RIGHT-TURN-ONLY LANE

**BIKE LANES APPROACHING MOTORISTS' RIGHT-TURN-ONLY LANES**

Figure 1020-10

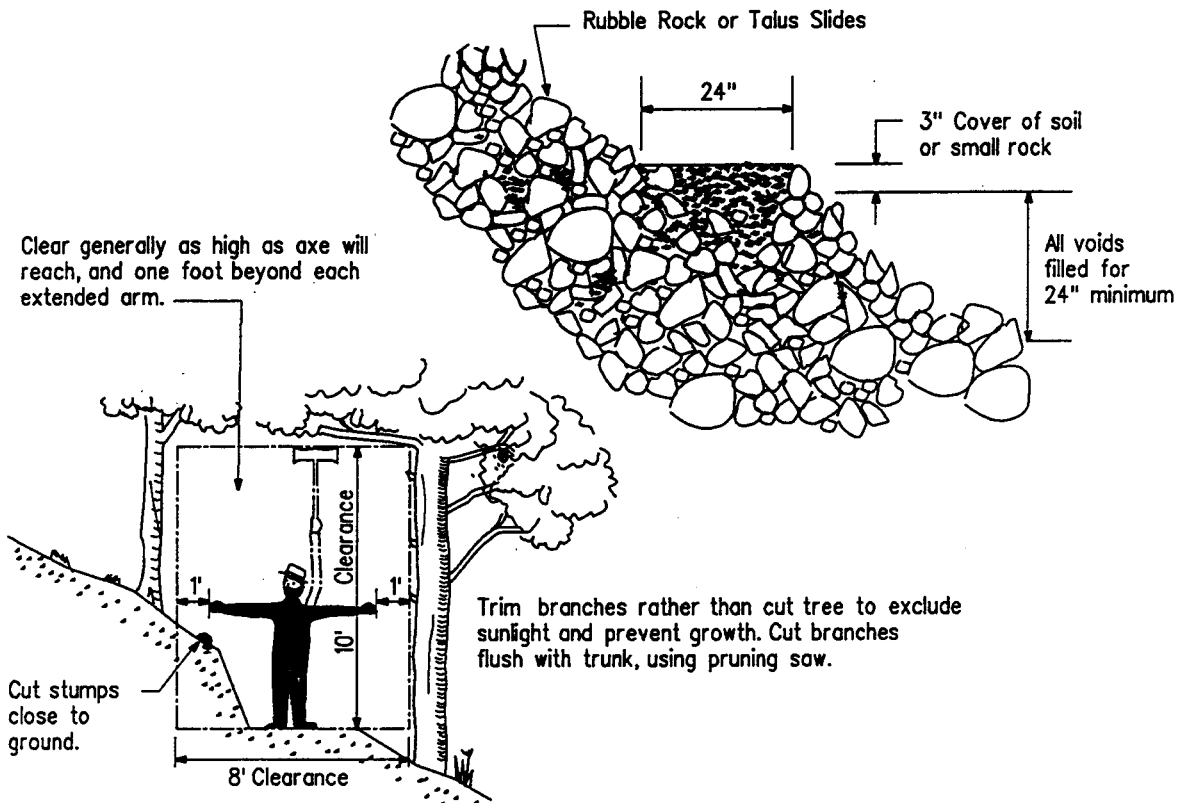

Width	2' Minimum tread
Grade	20% Maximum short, 10% Maximum sustained
Alignment	Independent and located beyond 30' safety zone
Clearances	10' Vertical, 8' Lateral
Surface	Gravel or natural material
Access Control	As required (see text)

### GUIDELINES FOR HIKING TRAILS

Figure 1020-11

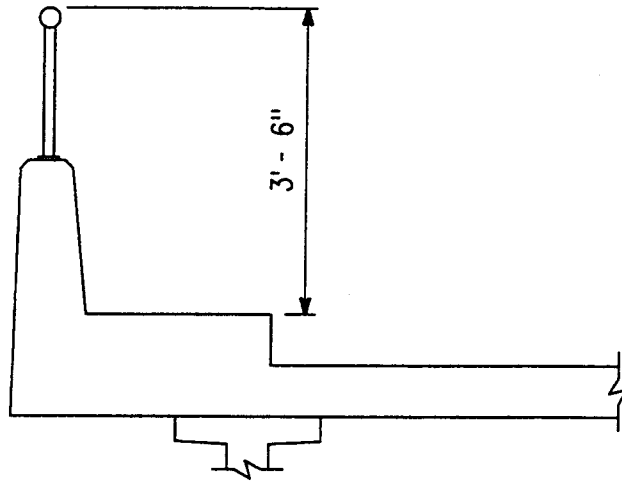

SIDEWALK IN URBAN AREAS

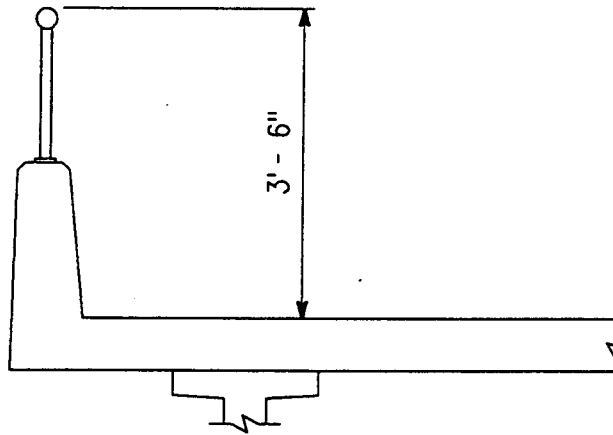

SIDEWALK IN RURAL AREAS

**WALKWAYS ON HIGHWAY BRIDGES**

Figure 1020-12

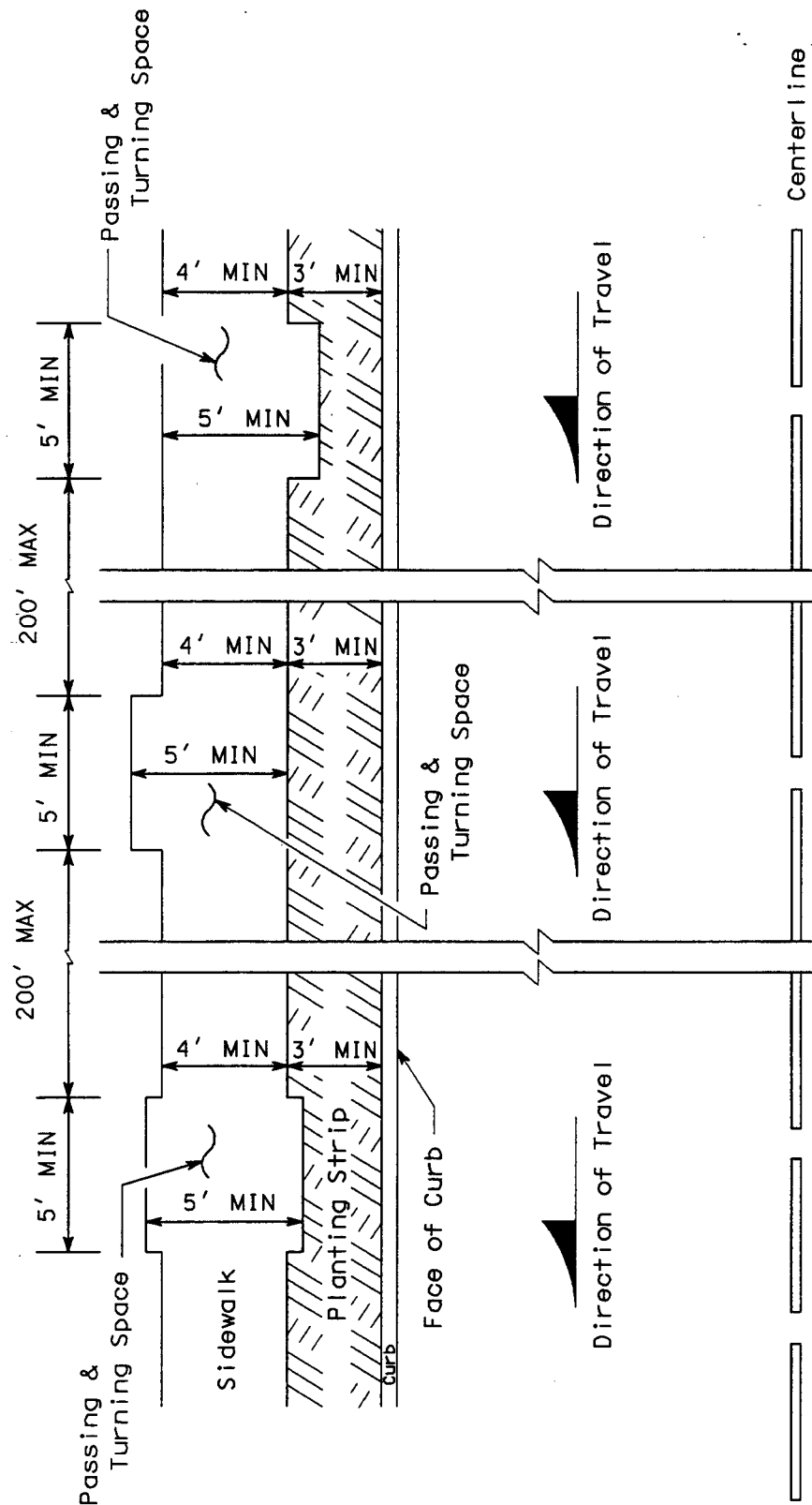

**HANDICAP PASSING AND TURNING SPACE FOR SIDEWALKS**

Figure 1020-13

- 1030.01 General
- 1030.02 References
- 1030.03 Documentation

### 1030.01 General

The Washington State Department of Transportation (WSDOT) has developed a statewide system of traveler services on Interstate highways and state routes. This system includes safety rest areas, roadside parks, points of interest, and traveler information centers. These traveler services provide the opportunity for rest and orientation. Benefits include improved safety, reduced driver fatigue, refuge from adverse driving conditions, and increased tourism. Traveler services are planned and designed by the Safety Rest Area Team a WSDOT working group representing various divisions, regions, service centers, and offices responsible for safety rest area planning, programming, design, construction, maintenance, and operation. The team assists the Heritage Corridors Program in the development of short and long term plans and budgets.

Safety rest areas and roadside parks are spaced approximately every 60 miles on the National Highway System and on Scenic and Recreational Highways. Use the Safety Rest Area and Roadside Park Master Plan as a guide to site location. Provide appropriate site amenities such as rest rooms, telephones, plaza areas, kiosks, visitor information areas, picnic areas, pet walk areas, recreational trails, and vegetation.

See the *Roadside Manual*, Division 6, for detailed information on planning, design, construction, and maintenance of safety rest areas and other traveler services.

### 1030.02 References

- 42 USC Section 12101et seq. Americans with Disabilities Act of 1990
- 23 CFR 752 Landscape and roadside development (Code Federal Regulations [CFR])

Revised Code of Washington (RCW) 46.16.063  
Additional fee for recreational vehicles.

RCW 46.68.170 RV account — Use for sanitary disposal systems.

RCW 47.06.040 State-wide multimodal transportation plan.

RCW 47.28.030 Contracts — State Forces

RCW 47.38 Roadside Areas — Safety Rest Areas

RCW 47.39 Scenic and Recreational Highway Act of 1967

WAC 51-40 Uniform Building Code  
Requirements for Barrier-Free Accessibility

*Roadside Manual*, M 25-30, WSDOT

*Highway Runoff Manual*, M 31-16, WSDOT

*Highway System Plan*, WSDOT

*Hydraulics Manual*, M 23-03, WSDOT

*Maintenance Manual*, M 51-01, WSDOT

*Right of Way Manual*, M 26-01, WSDOT

*Roadside Classification Plan*, M 25-31, WSDOT

*Traffic Manual*, M 51-02, WSDOT

*Manual on Uniform Traffic Control Devices*, (MUTCD), USDOT, FHWA; including the *Washington State Modifications to the MUTCD*, M 24-01, WSDOT

“Safety Rest Areas: Planning, Location and Design,” USDOT, FHWA, 1981

### 1030.03 Documentation

When locating a new traveler service, document:

- Conformance with the Safety Rest Area and Roadside Park Master Plan.
- Availability of utilities, including rights to well water where applicable.
- Site conditions and anticipated impacts.
- Mitigation measures where necessary. Refer to *Roadside Manual* Division 4.

- Adjacent land use.
- Traffic calculations and projections from the Transportation Data Office. This applies to such things as rest room capacity design, on-site sewage capacity, and parking area design.
- Public participation process and public input.
- Design decisions for ingress and egress.
- Compliance with local building codes and the Americans with Disabilities Act (ADA) requirements.

When projects involve construction in an existing traveler service, document:

- New construction on plans.
- Impacts (if applicable).
- Mitigation measures where necessary.
- Compliance with local building codes and ADA regulations.

See the *Roadside Manual* for further information. The Highways and Local Roadways Division and the Heritage Corridors Program are an integral part of safety rest area planning and design and can provide assistance and information.

P65:DP/DMM

Variables (feet)					
$\theta$	A	B	C	D	E
30°	85'	30'	50'	30'	100'
35°	90'	35'	55'	35'	105'
40°	95'	35'	60'	35'	110'
45°	100'	45'	65'	45'	115'

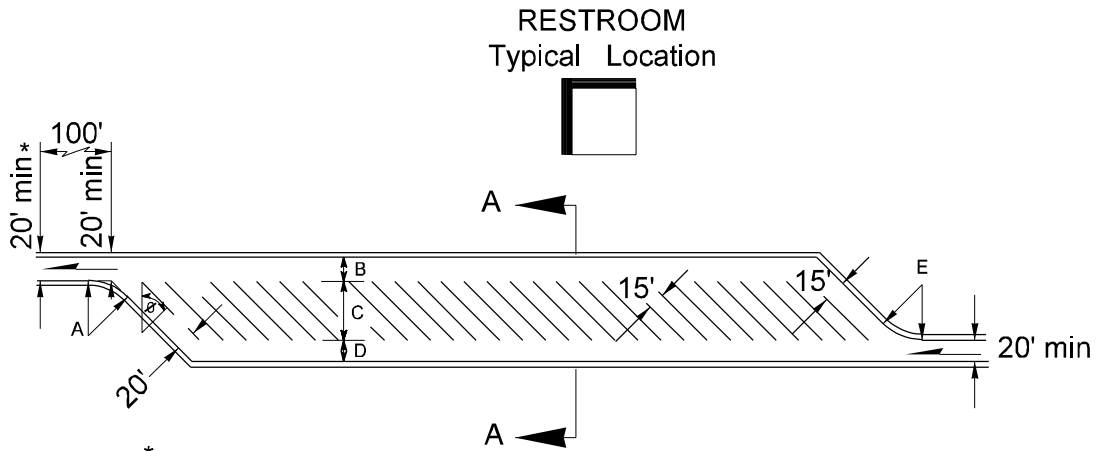

\* Note:  
 If exit ramp is tangent  
 or has curve radii greater  
 than 1000', this width may be  
 reduced to 14'.

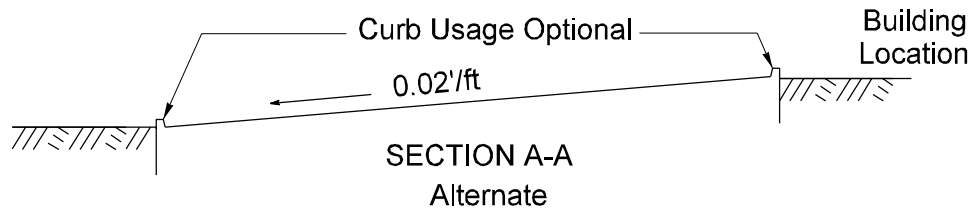
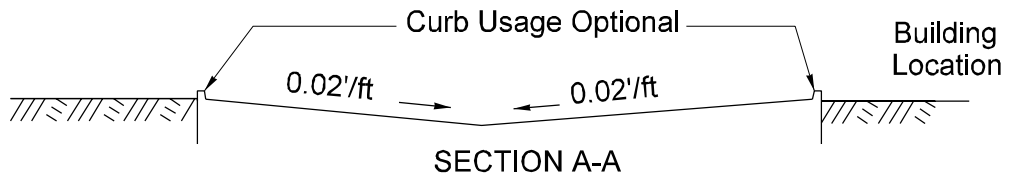

**Typical Truck Storage**  
*Figure 1030-1*



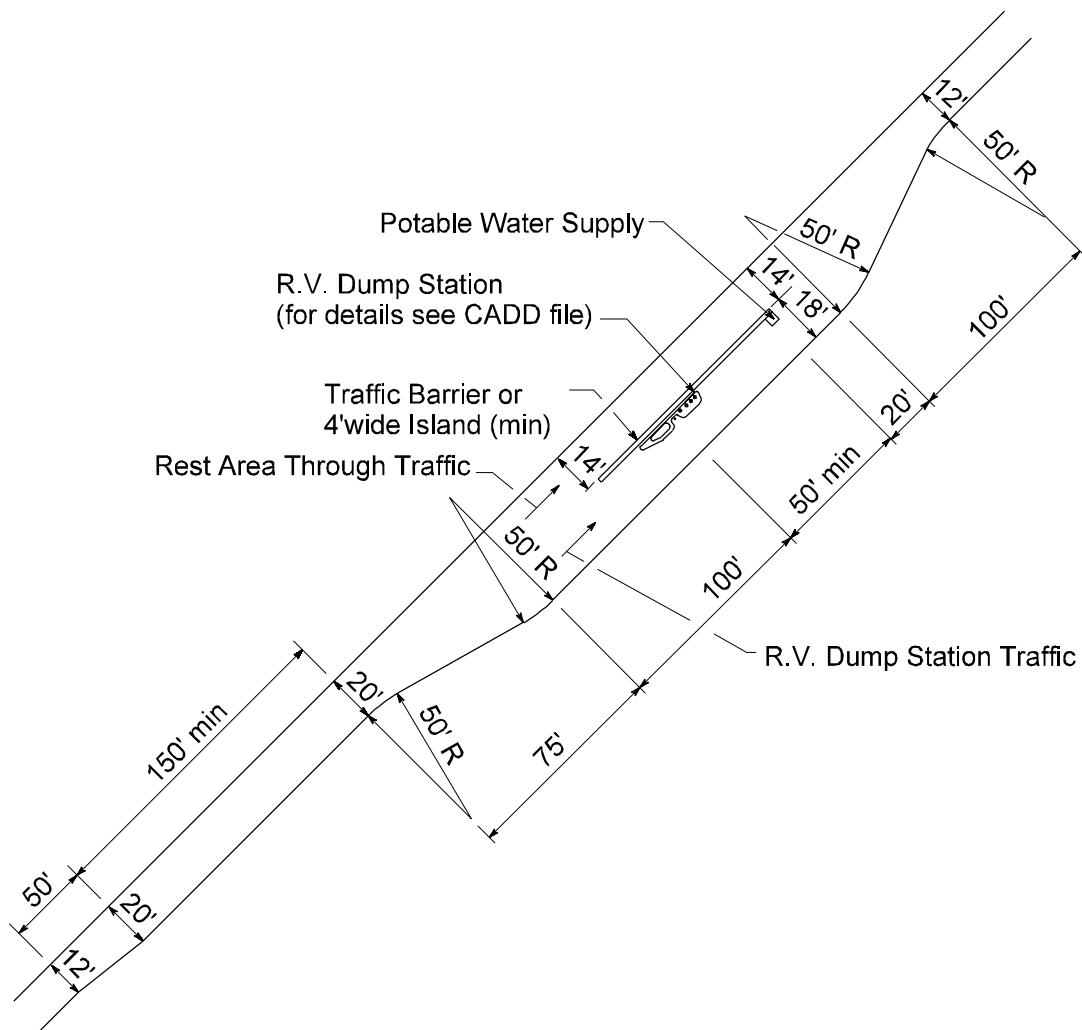

**Typical Single RV Dump Station Layout**  
*Figure 1030-2*

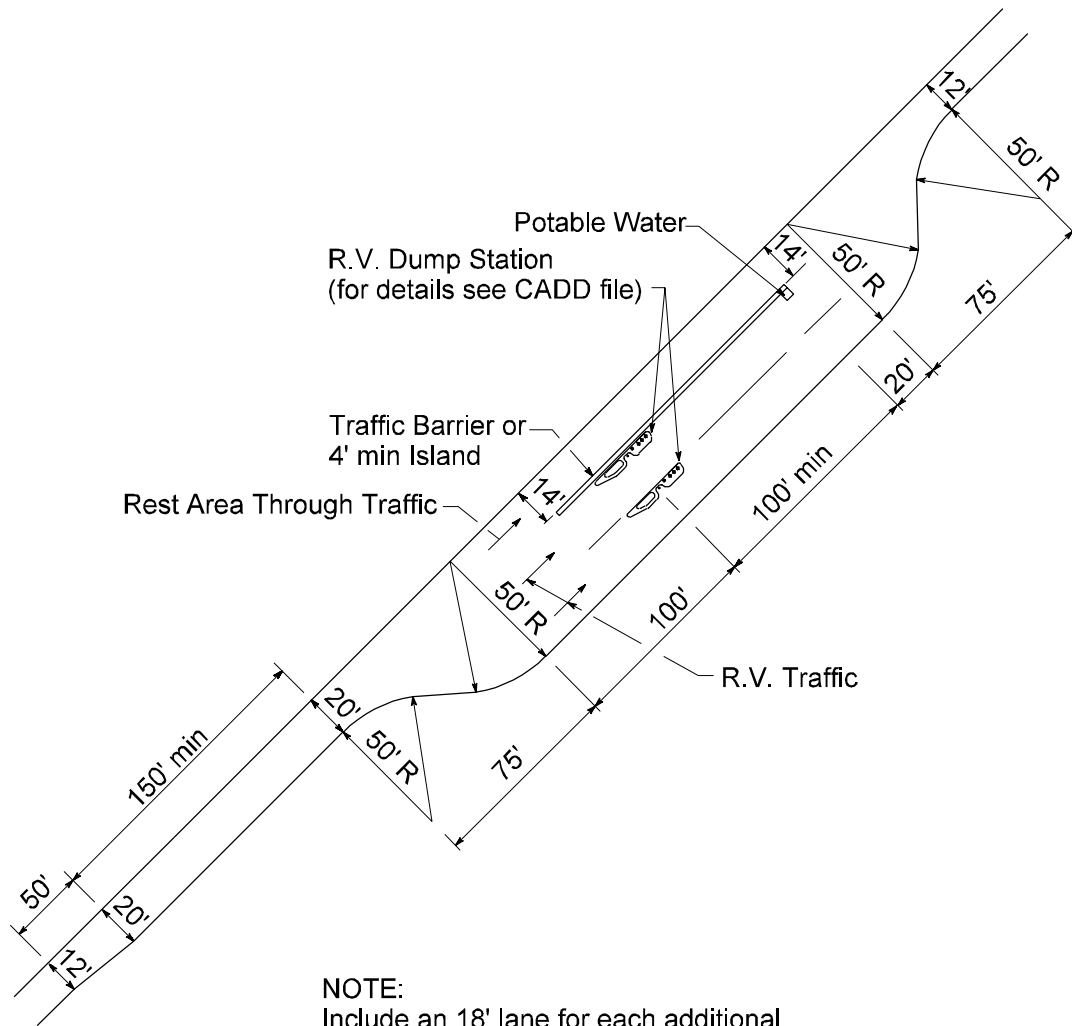

NOTE:  
 Include an 18' lane for each additional  
 RV Dump Station installed.

**Typical Two RV Dump Station Layout**  
*Figure 1030-3*

- 1040.01 General
- 1040.02 Definitions
- 1040.03 Planning, Development, and Responsibilities
- 1040.04 Permanent Facilities
- 1040.05 Portable Facilities
- 1040.06 Shoulder Sites
- 1040.07 Federal Participation
- 1040.08 Procedures
- 1040.09 Documentation

### 1040.01 General

Truck weighing facilities are needed to protect state highways from overweight vehicles, to provide for vehicle safety inspection, and to provide a source of data for planning and research. The development, construction, and maintenance of these facilities is a cooperative effort between the Washington State Department of Transportation (WSDOT) and the Washington State Patrol (WSP).

### 1040.02 Definitions

**Commercial Vehicle Information Systems and Networks (CVISN)** A network that links intelligent transportation systems (ITS) to share information on commercial vehicles. When in operation at a weigh site it can enable commercial vehicles to clear the facility without stopping.

**decision sight distance** The sight distance required for a driver to detect an unexpected or difficult-to-perceive information source or hazard, interpret the information, recognize the hazard, and select and complete an appropriate maneuver safely and efficiently.

**functional classification** The grouping of streets and highways according to the character of the service they are intended to provide. (See Chapter 440.)

**frontage road** An auxiliary road that is a local road or street located beside a highway for service to abutting property and adjacent areas and for control of access.

**lane** A strip of roadway used for a single line of vehicles.

**median** The portion of a divided highway separating the traveled ways for traffic in opposite directions.

**outer separation** The area between the outside edge of traveled way for through traffic and the nearest edge of traveled way of a frontage road.

**roadway** The portion of a highway, including shoulders, for vehicular use. A divided highway has two or more roadways.

**sight distance** The length of roadway visible to the driver.

**shoulder** The portion of the roadway contiguous with the traveled way, primarily for accommodation of stopped vehicles, emergency use, lateral support of the traveled way, and use by pedestrians and bicycles.

**static scale** A scale that requires a vehicle to stop for weighing.

**stopping sight distance** The sight distance required to safely stop a vehicle traveling at design speed.

**traveled way** The portion of the roadway intended for the movement of vehicles, exclusive of shoulders and lanes for parking, turning, and storage for turning.

**usable shoulder** The width of the shoulder that can be used by a vehicle for stopping.

**weigh in motion (WIM)** A scale facility capable of weighing a vehicle without the vehicle stopping.

### 1040.03 Planning, Development, and Responsibilities

The WSP works with the WSDOT's Planning and Programming Service Center to develop a prioritized list of weigh facility needs for each biennium. The list includes:

- New permanent facilities
- New portable facilities
- New shoulder sites

- WIM equipment
- Vehicle inspection facilities
- Scale approach slab reconstruction

The WSP provides Program Management a project definition, that includes:

- A statement of need, the purpose of the project, and the type of work
- The general location of the project

Program Management sends this information to the region for preparation of a Project Summary. The region works with the WSP to identify the specific location of the facility, prepares a design decision estimate, and submits it to Program Management.

The region negotiates and the Regional Administrator executes any formal agreements with the WSP required for the design, construction, or maintenance of vehicle weighing and inspection facilities.

The Memorandum of Understanding Related to Vehicle weighing and Equipment Inspection Facilities on State Highways, Figure 1040-8, contains details about the various responsibilities of the WSDOT and the WSP.

## 1040.04 Permanent Facilities

Permanent truck weighing facilities have permanent scales and may have buildings. When these facilities are in operation, trucks are required stop. However, when Weigh In Motion (WIM) and Commercial Vehicle Information Systems and Networks (CVISN) capabilities have been installed, the driver may be notified to continue without stopping. The notification to continue may be through the use of signs or transponders.

### (1) Site Locations

The exact location of a truck weighing facility is generally controlled by topography, highway alignment, and geometrics. It is also desirable to select a site where adequate right of way is already available. Select the most economical site to minimize site preparation, expense, or impact on the environment. Water, electricity availability, and sewage treatment and disposal are other considerations for site selection.

Locate the facility so that its operation will not hinder the operation of the highway or other related features such as intersections and interchanges.

To the extent possible, locate the facility to prevent truck traffic avoiding the facility on other roadways and the type and volume of truck traffic using the highway.

An Access Point Decision Report is required for weigh sites on multilane divided highways with access control. (See Chapter 1425.)

### (2) Design Features

On multilane highways, provide standard off- and on-connections, as shown in Chapter 940. Figure 1040-1 is the minimal design of a weigh site on multilane highways.

Design weigh facilities on two-lane highways to best fit the existing conditions, with particular consideration given to the matter of access to and from the site. Standard off- and on-connections, as shown in Chapter 940, are preferred; however, with justification on-connections may be designed as intersections. (See Chapter 910.) Figure 1040-2 is a guide for the design of weigh sites on two-lane highways.

The following special design features apply:

- Level cement concrete approach slabs are required at both ends of the scales.
  - Asphalt concrete pavement approach slabs will be allowed only when adequate soil conditions exist, projected truck volume is light, and benefit/cost analysis justifies the use of asphalt concrete pavement based on the small percentage of time the scales will be in operation.
  - The approach slabs must be level and in the same plane as the scale.
- Provide adequate parking and storage to ensure that trucks do not impede the main-line through traffic. The WSDOT Regional Administrator and the WSP agree on the area to be provided.

- On multilane divided highways, install illuminated electronically controlled “open” and “closed” message signs that can be operated from the scale house or the control cabinet. Provide permanent signing for the facility, as requested by the WSP.
- The need for a vehicle safety inspection facility at any site is identified by the WSP. Figure 1040-3 is a guide for a site plan for a single bay vehicle inspection facility. Additional bays and site adaptation will be on a site by site basis. The WSDOT Regional Administrator and the WSP agree on the area to be provided.
- The need for some form of approach protective treatment for the scale house or a protective fence between the scale and roadway is identified by the WSP and agreed upon by the WSDOT Regional Administrator and the WSP. The need for the device is to protect the scale house from errant vehicles. See Chapter 700 for additional clear zone considerations.
- The need for WIM or CVISN capabilities is identified by the WSP. Design the in-place facilities to provide the ability to notify drivers whether to continue on or to stop for further investigation before they reach the exit for the static scale. The design is agreed upon by the WSDOT Regional Administrator and the WSP.
- Where WIM and CVISN are not included in the project, provide conduit for their future installation.
- With justification, at locations where space is limited, the depressed outer separation between the weigh facility and the through lanes may be replaced with concrete traffic barrier. (See Collector Distributor Outer Separations, Chapter 940.)
- Provide a clear view of the entire weigh site for the facility’s operator and the driver of an approaching vehicle.
- Asphalt concrete pavement is acceptable for use on the ramp and storage areas. Design the depth in accordance with the surfacing report.
- To optimize scale efficiency, make the storage area flat; however, to facilitate drainage, the slope may be up to 2%.
- Provide illumination when requested by the WSP. Illumination is required if the facility is to be operated during the hours of darkness and may be desirable at other locations to deter unauthorized use of the facility. See Chapter 840 for additional information on illumination.

## 1040.05 Portable Facilities

Portable truck weighing facilities have no permanent scales or buildings. When these facilities are in operation, they operate in the same manner as permanent facilities.

### (1) Site Locations

Design portable truck weighing facilities located on two-lane and multilane roadways to best fit the existing conditions. Minor portable scale sites, as shown on Figure 1040-4, are used with two-way traffic and on multilane highways with low traffic volumes. Major portable scale sites, Figure 1040-5, are for use on expressways, freeways, and where traffic volumes are high.

Locate the weighing facility so that its operation will not hinder the operation of the highway or other related features such as an intersection.

An Access Point Decision Report is required for weigh sites on multilane divided highways with access control. (See Chapter 1425.)

### (2) Design Features

The following special design features apply:

- Off- and on-connections, as shown in Figures 1040-4 and 5, are preferred; however, with justification on highways with no access control, on-connections may be designed as intersections. (See Chapter 910.)
- With justification, at locations where space is limited, the depressed outer separation between the weigh facility and the through lanes may be replaced with concrete traffic barrier. See the collector distributor outer separation figure in Chapter 940.

- Provide adequate parking and storage to ensure that trucks do not impede the main-line through traffic. The WSDOT Regional Administrator and the WSP agree on the area to be provided.
- Asphalt concrete pavement is acceptable for use on the ramp and storage areas. Design the depth in accordance with the surfacing report.
- To optimize portable scale efficiency, make the storage area flat; however, to facilitate drainage, the slope may be up to 2%.
- Provide permanent signing for the facility, as requested by the WSP.
- Provide illumination when requested by the WSP. Illumination is required if the facility is to be operated during the hours of darkness and may be desirable at other locations to deter unauthorized use of the facility. See Chapter 840 for additional information on illumination.

## 1040.06 Shoulder Sites

Shoulder sites are used by the WSP to pull a truck over for inspection and weighing with portable scales.

### (1) Site Locations

Design shoulder sites to best fit the existing conditions. Small shoulder sites (Figure 1040-6) are for use on lower volume roadways (ADT 5,000 or less) with two-way traffic. Large shoulder sites (Figure 1040-7) are to be used with higher volume two-way roadways and multilane highways.

Locate the weighing facility so that its operation will not hinder the operation of the highway or other related features such as an intersection.

### (2) Design Features

Shoulder sites are designed in coordination with the WSP. Input from the local WSP Commercial Vehicle Enforcement personnel will ensure that the proposed site will meet their needs without over-building the facility. Obtain written concurrence from the WSP for the length, width, and taper rates before the design is finalized.

When the ADT is 1,500 or less and with the written approval of the WSP, the tapers at small shoulder sites may be eliminated. The shoulders on either side of the site may be used as acceleration and deceleration lanes, whether or not they were designed for this use. Therefore, provide adequate strength to support truck traffic.

Asphalt concrete pavement is acceptable for use on all shoulder sites. Design the depth in accordance with the surfacing report. Design the shoulder pavement at this depth for a length not less than the deceleration lane length before, and the acceleration lane length after, the site (Chapter 940).

When the shoulders are designed to be used for deceleration and acceleration lanes, the minimum width is 12 ft with full pavement depth for the deceleration/acceleration lane lengths (Chapter 940).

Use a maximum of 2% slope in order to optimize portable scale efficiency and to facilitate drainage.

## 1040.07 Federal Participation

Federal funds appropriate to the system being improved may be used for the acquisition of right of way and the construction of truck weighing facilities and vehicle inspection facilities. This includes, but is not limited to on and off ramps, deceleration and acceleration lanes, passing lanes, driveways, parking areas, scale approach slabs, vehicle inspection facilities, roadway illumination, and signing.

## 1040.08 Procedures

Prepare site plans for all truck weigh facilities that include:

- Class of highway and design speed for main line (Chapter 440).
- Curve data on main line and weigh site.
- Numbers of lanes and widths of lanes and shoulders on main line and weigh site.
- Superelevation diagrams for the main line and weigh site.
- Stationing of ramp connections and channelization.

- Illumination.
- Signing.
- Water supply and sewage treatment.
- Roadside development.

Get WSP approval of the site plans before the final plan approval.

### **1040.09 Documentation**

The following documents are to be preserved in the project file. See Chapter 330.

- Truck weigh facilities site plans.
- All correspondence with the WSP.
- Access Point Decision Report (Chapter 1425).
- Justification for any on-connection designed as an intersection.
- Justification for the use of concrete traffic barrier at the outer separation.

*P65:DP/DMM*

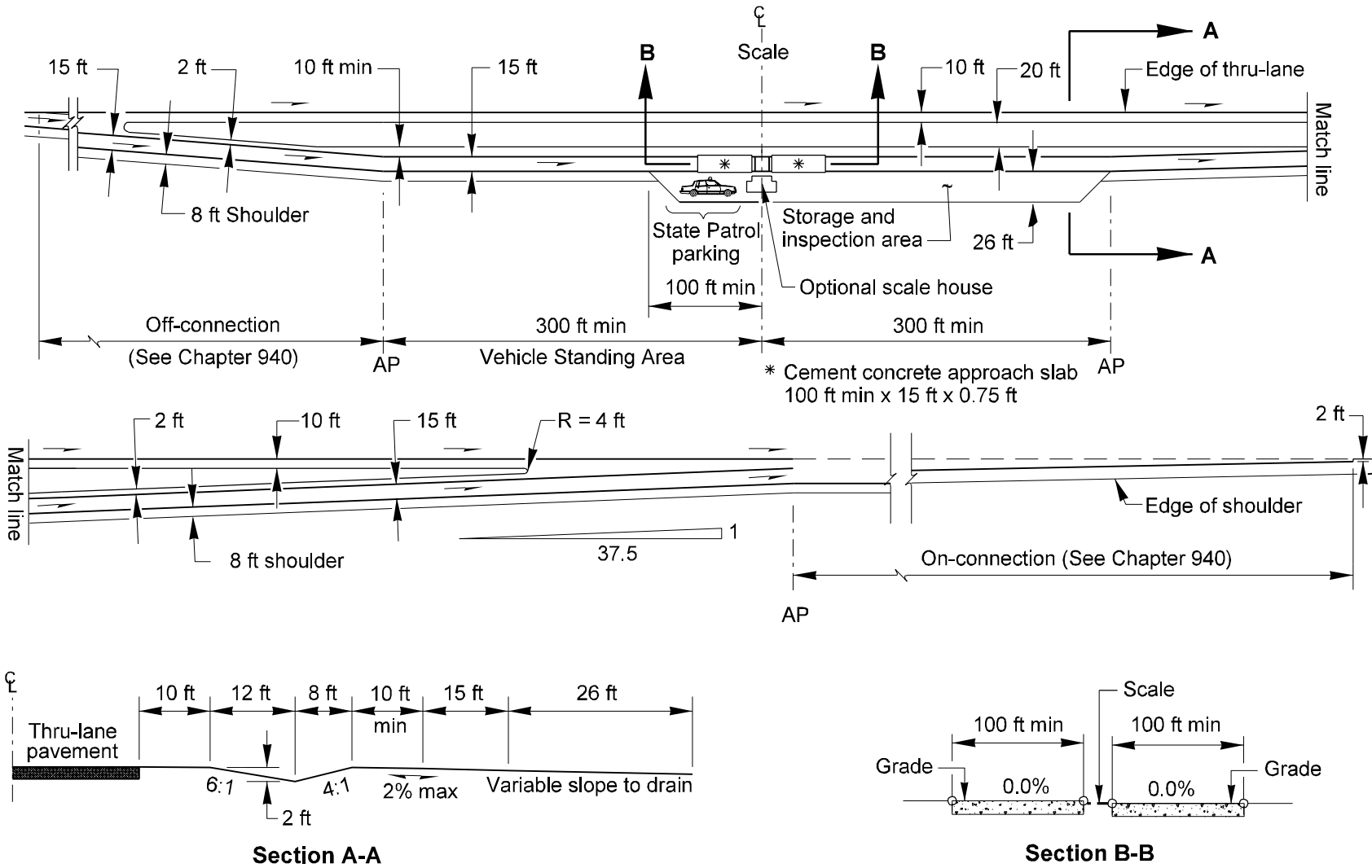

Truck Weigh Site (Multilane Highways)

Figure 1040-1



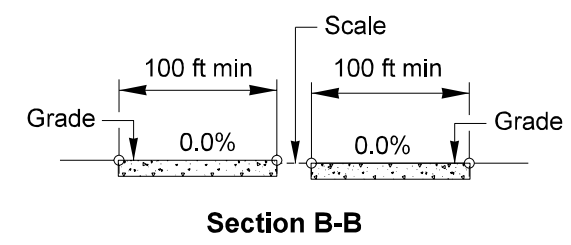
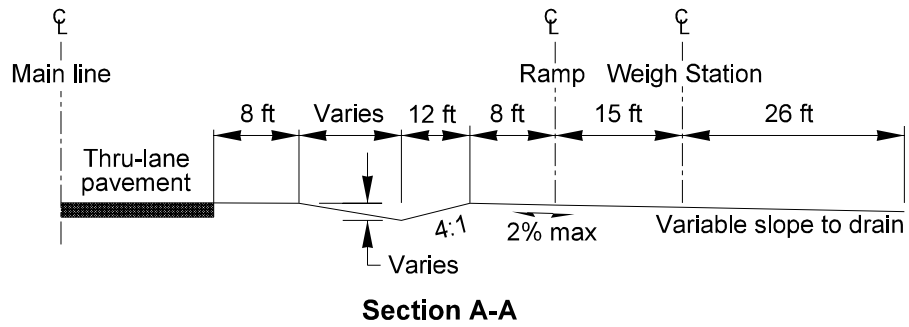
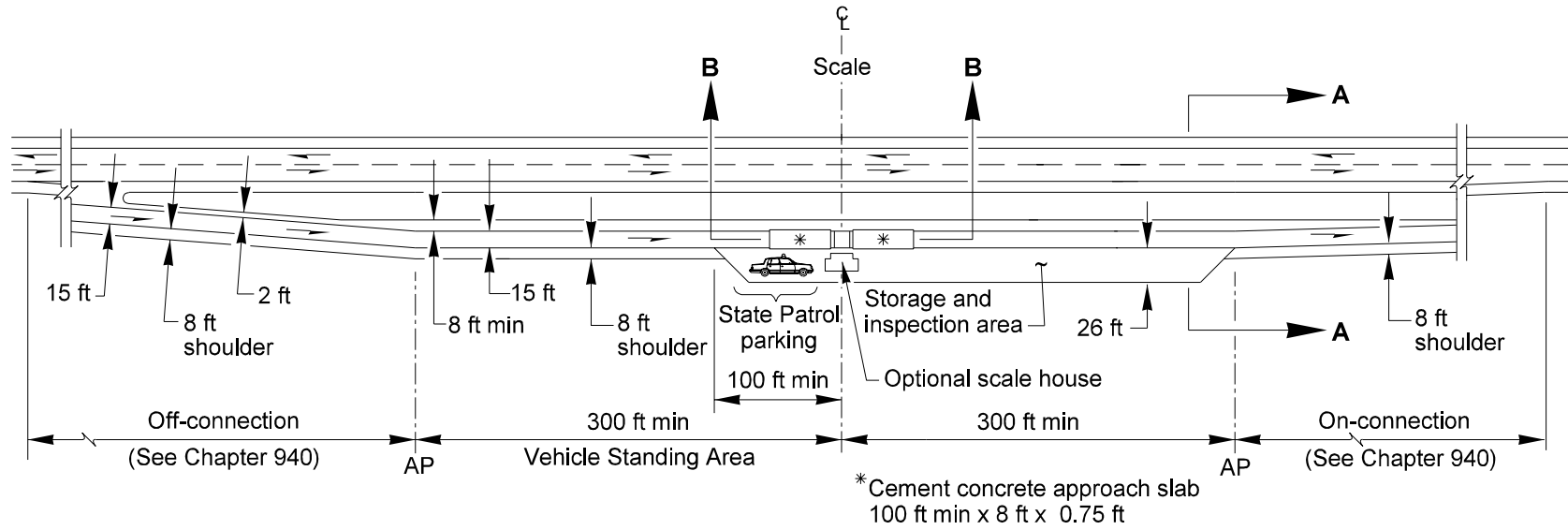

**Truck Weigh Site (Two Lane Highways)**  
Figure 1040-2

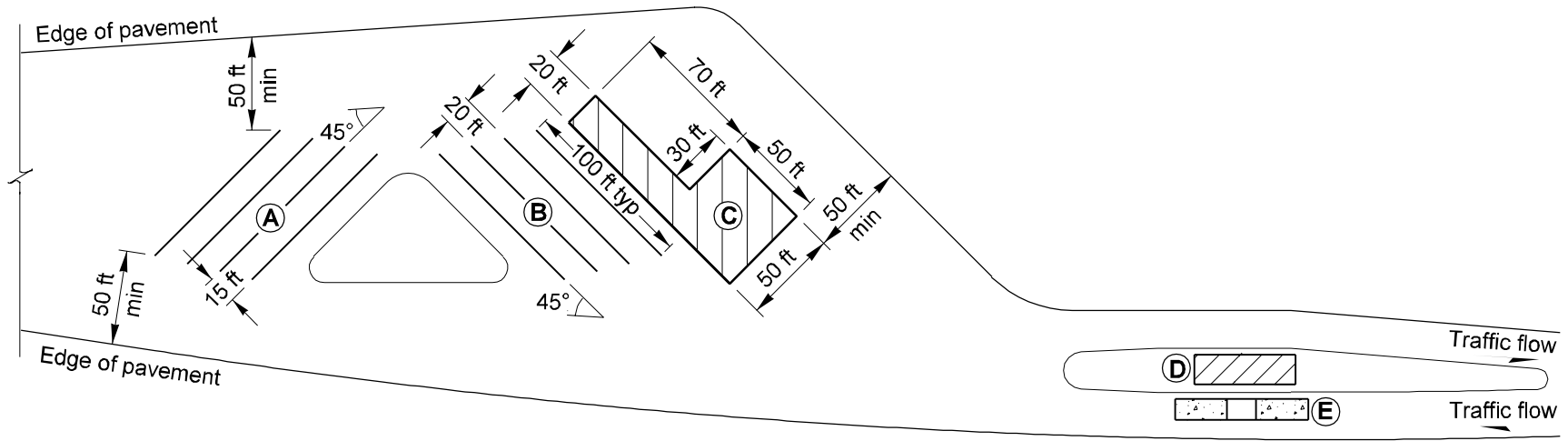

- (A) Truck storage and parking
- (B) Outside truck inspection and parking
- (C) Truck inspection building
- (D) Scalehouse
- (E) Scale

**Vehicle Inspection Installation**  
Figure 1040-3

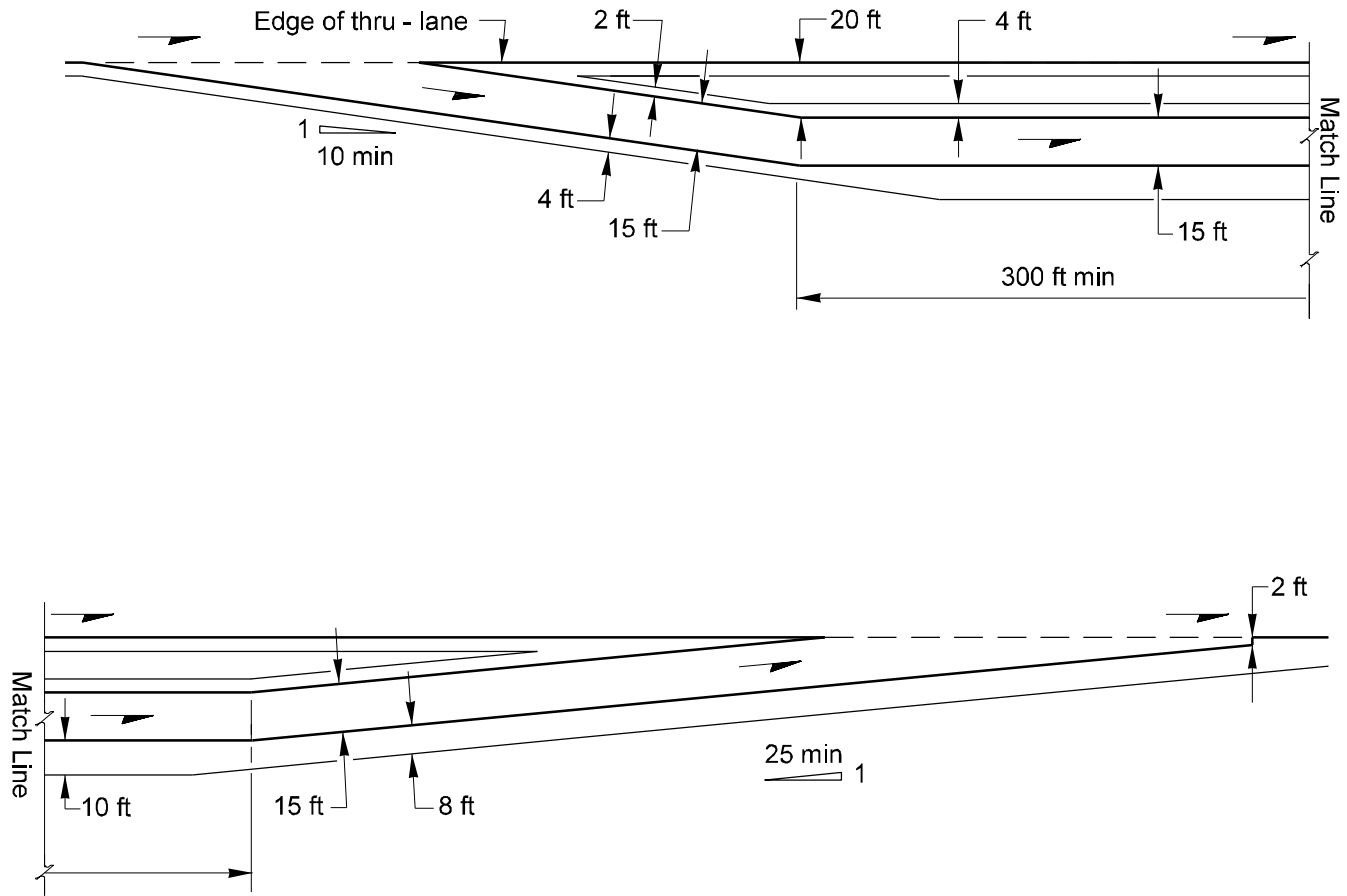

Minor Portable Scale Site  
Figure 1040-4

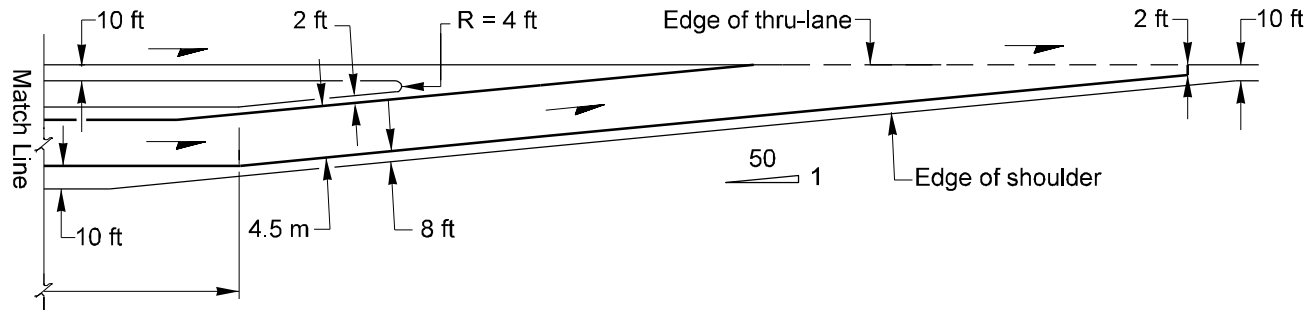
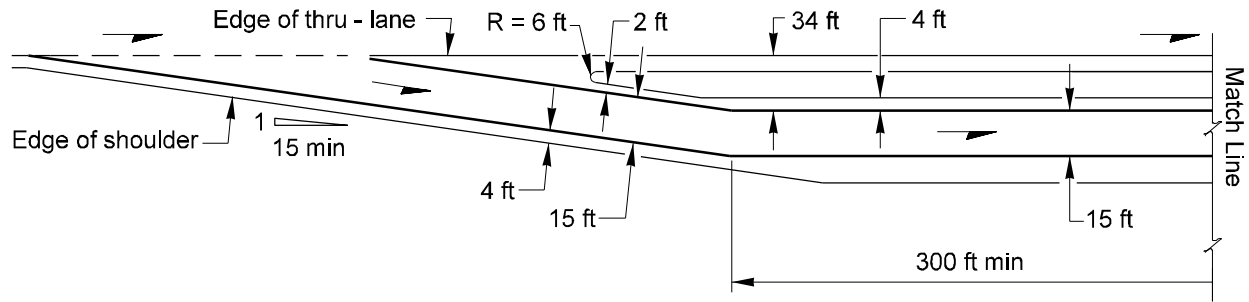

Major Portable Scale Site  
Figure 1040-5

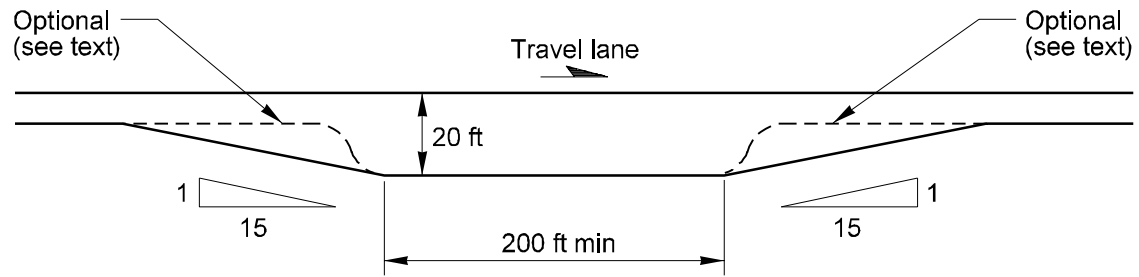

Length to be established by agreement  
with the WSP, but not less than 200 ft.

**Small Shoulder Site**  
*Figure 1040-6*

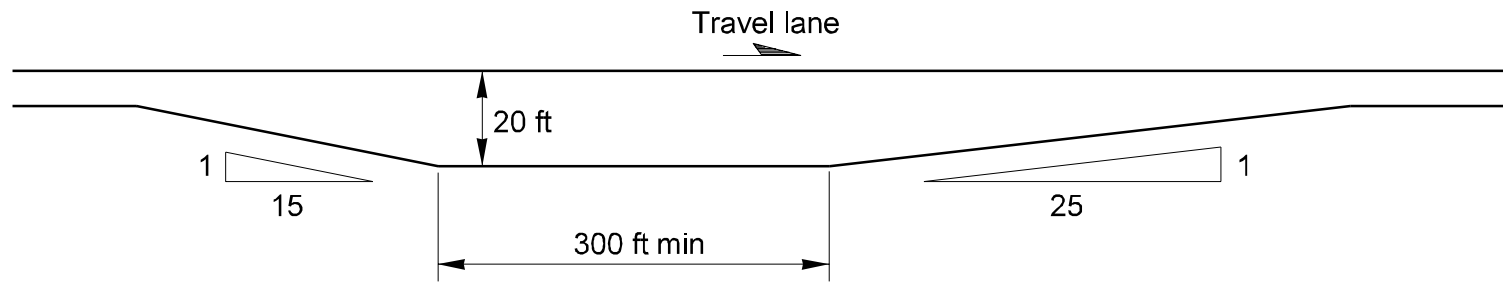

**Large Shoulder Site**  
*Figure 1040-7*

0990476SC

Memorandum of Understanding  
Related to Vehicle Weighing and  
Equipment Inspection Facilities on State Highways

This Memorandum of Understanding by and between the Washington State Department of Transportation hereinafter called the "Department of Transportation," and the Washington State Patrol, hereinafter called the "State Patrol," establishes procedures for coordinating and delineating the responsibilities for the location, design, construction, maintenance, signing, and other matters related to vehicle weighing and equipment inspection facilities and the state highway improvements needed as a result of these facilities.

It is mutually recognized that:

The Department of Transportation is responsible for planning, designing, constructing, and perpetuating public highways of the State Highway system for the safety and benefit of the traveling public;

The State Patrol is responsible for enforcement of the laws of the state of Washington regarding vehicle weight enforcement programs and vehicle safety inspection programs;

Nothing in this agreement is to be construed as conflicting with existing laws, regulations, and prescribed responsibilities, and

In recognition of the responsibilities, interest, and limitations set forth above and of the mutual benefits of established procedures to facilitate agreement on specific matters, the Department of Transportation and the State Patrol mutually agree as follows:

- I. Planning
  - A. The State Patrol will work with the Department of Transportation's Planning and Programming Service Center to develop a prioritized list of weigh station needs at each biennium. The list will include:
    - New permanent facilities
    - New portable facilities
    - Weigh-in-Motion (WIM) equipment
    - Vehicle inspection facilities
    - Scale approach slab construction
  - B. The State Patrol will provide the Planning and Programming Service Center with a project definition for each project, which will include statement of need, purpose of project, type of work, and general location of the project.
  - C. The Planning and Programming Center will send the information to the Regional Administrator for preparation of a project summary. The Regional Administrator will work with the State Patrol to identify the specific location of the facility, prepare a design decision estimate, and submit it to the Planning and Programming Service Center for inclusion in the biennial program.
  - D. The Regional Administrator will negotiate and execute any formal agreements required for design, construction, or maintenance of vehicle weighing and inspection sites.

**MOU Related to Vehicle Weighing and Equipment  
Inspection Facilities on State Highways**

*Figure 1040-8a*

## II. Responsibilities

Vehicle weighing and equipment inspection facilities shall meet highway standards for acceleration and deceleration lanes, on and off ramps, illumination, and other related equipment. These facilities will be provided through the cooperative efforts of the State Patrol and Department of Transportation as needed on state highways.

### A. The State Patrol will:

1. Initiate the action and submit recommendations for the addition of a new facility or expansion of an existing facility or the relocation of an existing facility, and negotiate agreements, e.g. siting of a new facility, etc. with the Department of Transportation through the appropriate region and the Olympia Service Center.
2. Perform the preliminary engineering and submit the design and PS&E documents for the scale, WIM, scalehouse, and inspection facility to the Department of Transportation for review and processing for approval with the Federal Highway Administration (FHWA), if applicable, at the State Patrol's expense.
3. Construct, operate, and maintain the weigh station scale, WIM, scalehouse, and equipment inspection facility with all related equipment thereto including lighting, water, heat, telephone, and toilet facilities at the State Patrol's expense.
4. For WIM facilities and for facilities deploying Commercial Vehicle Information Systems and Networks (CVISN), select sites in cooperation with DOT that minimize the need for pavement reconstruction, and, at the State Patrol's expense, install, operate, and maintain any weigh-in-motion signs and related equipment, purchase and install all WIM hardware and software, and provide electrical conduit and an equipment storage room within the scale facility.
5. In the event the State Patrol cannot fulfill the responsibilities specified above for preliminary engineering (design and PS&E documents), construction, or maintenance, they may request that the Department of Transportation perform the work on the basis of a written agreement that includes reimbursement to the Department of Transportation for the costs.
6. Construct the CVISN roadside apparatus at the same time as WIM equipment is installed, e.g.; cantilevered mounting poles, guard rail, conduit/raceway installation at DOT expense. All construction in the state or interstate right-of-way will be under the responsibility of a DOT region engineer.

### B. The Department of Transportation will:

1. Initiate action for the relocation of an existing installation when necessary because of the relocation of a highway or expansion of an existing highway, and obtain concurrence of the State Patrol.
2. Negotiate agreements with the State Patrol regarding addition, expansion, and relocation of facilities.

## MOU Related to Vehicle Weighing and Equipment Inspection Facilities on State Highways

*Figure 1040-8b*



C990477GSC

3. On all newly located or existing highways, at Department of Transportation expense, acquire the necessary right of way, construct and maintain the required acceleration and deceleration lanes, on and off ramps, driveways, passing lanes, scale approach slabs, and parking areas, including the surfacing thereof, excavate the scale pit, and construct and maintain the inspection, parking, and roadway illumination and standard signing at approved locations.
4. For WIM facilities and for facilities deploying Commercial Vehicle Information Systems and Networks (CVISN), at Department of Transportation's expense, construct the special approaches, provide maintenance of CVISN hardware and software located within the facility, and provide traffic control for installation of the scale and, when closure of any lane is required, for maintenance of the scale.
5. For facilities deploying Commercial Vehicle Information Systems and Networks (CVISN), at WSDOT's expense install mainline hardware (Automated Vehicle Identification equipment) and software for conformance with CVISN standards and provide maintenance of CVISN hardware and software located within the facility.
6. Upon request of the State Patrol, in accordance with a written agreement and on a reimbursement basis, perform other preliminary engineering, construction, and maintenance, which is the sole responsibility of the State Patrol.

Additionally, the State Patrol and the Department of Transportation agree to follow the Federal Highway Administration's *Guidance for Local Agency Roadway Projects within Interstate Rights-of-Way*, as outlined in Attachment A.

### III. Conclusions and Approvals

- A. The Regional Administrators for the Department of Transportation and the Commercial Vehicle Division Commander for the State Patrol are encouraged to consult with each other and to agree on such matters that fall within their scope of responsibility.
- B. This memorandum may be amended or supplemented by mutual agreement between the signers or their successors.
- C. Either party may terminate this MOU upon thirty- (30) days' written notification. If this MOU is so terminated, the terminating party shall be liable only for performance in accordance with the terms of the MOU for performance rendered prior to the effective date of the termination.
- D. In the event a dispute arises under this MOU, it shall be resolved as follows: The Secretary of WSDOT and the Chief of the WSP shall each appoint a member, not affiliated with either agency, to a conflict resolution board. Then these two members shall appoint a third member. The decision made by this board shall be final and binding on the parties to the MOU.
- E. In the event funding from state, federal, or other sources is withdrawn, reduced, or limited in any way after the effective date of this MOU and prior to normal completion, the WSDOT or WSP may terminate the MOU under the TERMINATION clause, subject to renegotiation under those new funding limitations and conditions.

## MOU Related to Vehicle Weighing and Equipment Inspection Facilities on State Highways

Figure 1040-8c

C990477GSC

F. We have read the foregoing and agree to accept and abide by the procedures herein.

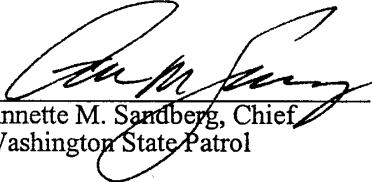
  
Annette M. Sandberg, Chief  
Washington State Patrol

12/16/99  
Date

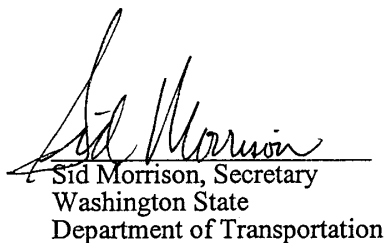
  
Sid Morrison, Secretary  
Washington State  
Department of Transportation

3/9/00  
Date

APPROVED AS TO FORM:

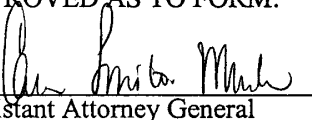
  
Assistant Attorney General

9/7/99  
Date

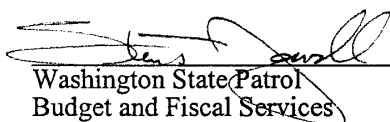
  
Washington State Patrol  
Budget and Fiscal Services

12/27/99  
Date

**MOU Related to Vehicle Weighing and Equipment  
Inspection Facilities on State Highways**

Figure 1040-8d

**ATTACHMENT A**  
**Guidance for Local Agency Roadway Projects within Interstate Rights-of-Way**

Since all projects within the Interstate rights-of-way (ROW) have the potential to impact safety and operations on the Interstate route, they must incorporate Interstate design criteria and construction quality. It is the Federal Highway Administration's (FHWA) policy that the Washington State Department of Transportation (WSDOT) should administer all projects within the Interstate ROW. However, given the scope and extent of non-Interstate projects within the Interstate ROW, it is recognized that local agency administration of some projects may be desirable.

Whenever a local agency proposes a project within the Interstate ROW, they must develop an agreement with WSDOT that clearly outlines their duties and responsibilities to maintain the integrity of the Interstate facility, from both the safety and quality perspectives. The agreement must be executed prior to beginning design and must incorporate the following requirements:

**Responsibilities:** WSDOT and the local agency must each assign a responsible Project Engineer.

**Design:** WSDOT must review and approve all highway plans, profiles, deviations structural plans false-work plans, shoring plans, and traffic control plans for any work within the Interstate ROW.

**Plans, specification and estimates:** WSDOT must review and approve the plans and specifications for any work within Interstate ROW.

**Advertising and aware:** The local agency must confer with the WSDOT Project Engineer on any pre-aware issues affecting the quality and timing of the contract.

**Construction:** All construction, materials, and quality control requirements contained in the current editions of the WSDOT Standard Specifications and Construction Manual must be incorporated into the agreement.

**Contract changes:** All contract changes affecting work within the Interstate ROW must have the prior concurrence of the WSDOT Project Engineer.

**Final inspection:** The final inspection of the project must be performed by WSDOT Olympia Service Center and must evidence their approval.

Only local agencies with full certification acceptance authority may enter into such an agreement with the WSDOT.

The agreement must be submitted to FHWA for approval. FHWA reserves the right to assume full oversight of the project.

**MOU Related to Vehicle Weighing and Equipment  
 Inspection Facilities on State Highways**

*Figure 1040-8e*

1050.01	General
1050.02	Definitions
1050.03	References
1050.04	Preliminary Design and Planning
1050.05	Operations
1050.06	Design Criteria
1050.07	Arterial HOV

### 1050.01 General

The high occupancy vehicle (HOV) is a transit vehicle, van, car, or any other vehicle that meets the occupancy requirements of a particular facility. Motorcycles and buses (with a capacity of 20 or more) can legally travel in an HOV lane regardless of occupancy level. Vehicles with a gross vehicle weight over 4 500 kg (10,000 lbs.) are not allowed in HOV lanes.

The specific objectives for the HOV system are:

- Improve the capability of congested freeway corridors to move more people by increasing the number of persons per vehicle.
- Provide travel time savings and a more reliable trip time to HOVs that use the facilities.
- Provide safe travel options for HOVs without unduly affecting the safety of the freeway general-purpose lanes.

HOV facilities should be designed and constructed to ensure intermodal linkages, with consideration given to future highway system capacity needs. Whenever possible, HOV facilities should be designed so that the level of service for the general-purpose lanes will not decrease.

In those urban corridors that do not currently have planned or existing HOV facilities, a thorough analysis of the need for HOV facilities should be completed before proceeding with any projects for additional new general-purpose lanes. In those corridors where both HOV and

general-purpose facilities are planned, the HOV facility should be constructed before or simultaneously with the construction of new general-purpose lanes.

### 1050.02 Definitions

**arterial HOV** a priority treatment(s) for buses, carpools, and vanpools on nonlimited access roadways

**buffer-separated HOV facility** an HOV lane(s) that is separated from adjacent general-purpose freeway lanes by a designated buffer width 0.6 to 1.2 m (2 to 4 ft) or greater than 2.4 m (8 ft)

**concurrent flow lane** a buffer or nonseparated lane on which HOVs operate in the same direction as the normal traffic flow

**contraflow lane** a lane on which HOVs operate in a direction opposite to that of the normal flow of traffic

**direct access ramp** a grade-separated on or off ramp that provides local access from a street or transit support facility to the freeway HOV facility

**enforcement area** a place where vehicles may be stopped for ticketing by law enforcement. It also may be used as an observation point and for emergency refuge

**enforcement observation point** a place where an officer may park and observe traffic

**flyover ramp** a grade-separated usually high-speed facility that provides ingress and egress over a freeway HOV main line facility to a local arterial street, another freeway, or another HOV support facility

**high occupancy vehicle (HOV)** a transit vehicle, van, car or any other vehicle that meets the occupancy requirements of a particular facility

## High Occupancy Vehicle Facilities

**level of service** a descriptive measure of the quantity and quality of transportation service provided the user that incorporates finite measures of quantifiable characteristics such as travel time, travel cost, number of transfers, etc.

**line enforcement** enforcement by means of travel in the HOV lane or in the adjacent general-purpose lane

**occupancy designation** the minimum number of occupants for a vehicle to use the facility

**separated HOV facility** an HOV lane that is physically separated from adjacent general-purpose freeway lanes

**shy distance** the width between the outside edge of the shoulder and the traffic barrier or other obstruction

**single occupant vehicle (SOV)** motor vehicles other than a motorcycle carrying one occupant

**stationary enforcement** enforcement by vehicles parked in enforcement areas, on and off ramps, and at locations with high violation rates. The officer can wave the violator over, and ideally, pursuit is not necessary.

**violation rate** the total number of violators divided by the total number of vehicles on an HOV facility

### 1050.03 References

*Guide for the Design of High Occupancy Vehicle Facilities*, American Association of State Highway and Transportation Officials

*Manual on Uniform Traffic Control Devices for Streets and Highways*, M 24-01, U.S. Department of Transportation, Federal Highway Administration

*Design Features of High Occupancy Vehicle Lanes*, Institute of Traffic Engineers

*Washington State Freeway HOV System Policy*, Washington State Department of Transportation

*Standard Plans for Road, Bridge and Municipal Construction*, M 21-01, Washington State Department of Transportation

*Traffic Manual*, M 51-02, Washington State Department of Transportation

*High-Occupancy Vehicle Facilities: Current Planning, Operation and Design Practices*, Parsons Brinkerhoff, Inc.

## 1050.04 Preliminary Design and Planning

### (1) Planning Elements for Design

In order to determine the appropriate design options for an HOV facility, the travel demand and capacity must first be established. Suitable corridors must be identified, the HOV facility location and length evaluated, and the HOV demand must be estimated. A viable HOV facility will satisfy the following criteria:

- Part of an overall transportation plan.
- Have the support of the community and public.
- In response to demonstrated congestion or near-term anticipated congestion (Level of Service E or F for at least one hour of peak period, traffic approaching a capacity of 1,700 to 2,000 vehicles per hour per lane, and/or average speeds less than 50 km/h (30 mph) during peak periods over an extended distance).
- Except for a bypass of a local bottleneck, HOV facilities will be of sufficient length to provide a travel time saving of at least 5 minutes during the peak periods.
- Sufficient number of HOV users for a cost-effective facility and to avoid the perception of under utilization. (HOV volumes of 400 to 500 vehicles per hour on concurrent flow lane and 600 to 800 on separated facilities.)
- A design that provides for safe, efficient, and enforceable operation.

A queue bypass treatment does not need to justify all of the above to be effective. Isolated bypasses may be warranted when there is localized, recurring traffic congestion, and such treatment will provide a travel time saving to an adequate number of HOV users.

Particular attention must be given to the ingress and the egress to the facility. The efficiency of the HOV facility can be greatly affected by the access provisions. Direct access to and from the HOV facility would be the most desirable, but it is also an expensive alternative. Direct access options are discussed in 1050.04(3)(d). The termination of an HOV lane should be safe and efficient. See the discussion in 1050.06(6).

The design report should address the need for the facility and how the facility will meet those needs in accordance with the above criteria.

## (2) HOV Facility Type

A determination must be made as to the type of HOV facility. For freeways, the three major choices are separated roadway, concurrent flow, and buffer separated.

(a) **Separated Roadway.** The separated roadway can be either a one-way reversible or a two-way operation. The directional split in the peak periods, space available, and operating logistics are factors to be considered. A separated HOV may be located in the median of the freeway, next to the freeway, along the side, or on an independent alignment. Separated HOV facilities are more effective for:

- Large HOV volumes.
- Large merging and weaving volumes that can compromise efficiency of the HOV lane.
- Long-haul HOV travel.

Reversible, separated roadways operate effectively where there are major directional splits during peak periods. Consideration should be given to potential changes in this traffic pattern in the future and designing the facility to accommodate possible conversion to two-way operation in the future. The separated roadway is normally the more efficient, provides for the higher level of safety, and is more easily enforced. However, it is generally the most expensive type of HOV facility to implement.

(b) **Concurrent Flow.** Concurrent flow lanes are an alternate for two-way operation. Concurrent flow HOV lanes operate in the direction of the freeway lanes immediately adjacent to the

general-purpose lanes. They are located either to the inside or outside of the general-purpose lanes. Refer to Figure 1050-1. This type of facility is normally less costly, is easier to implement, and provides more opportunity for frequent access. However, the ease of access also can create more problems for enforcement and higher potential for conflicts, particularly considering the speed differential between the HOV lane and the mixed traffic lanes. These operational shortcomings can be alleviated somewhat by the use of a buffer between the HOV lane and the general-purpose lanes.

(c) **Buffer Separated.** The buffer separated HOV facility is similar to the concurrent flow HOV, but with a 0.6- to 1.2-m (2- to 4-ft) buffer (or greater than 2.4 m [8 ft]) between the HOV lane and the general-purpose lanes. The addition of a buffer provides better delineation between the lanes and an improved operation, considering the speed differential between the lanes.

## (3) Operational Alternatives

In addition to the HOV facility, a full range of operational alternates must be considered before preparing a project prospectus. For limited access facilities, the operational alternates include:

- Inside or outside HOV lane.
- Lane conversion.
- Use of existing shoulder.
- Direct access.
- Queue bypasses.
- Transit flyer stops.

When evaluating alternates, it must be realized that a combination of alternates may provide the best solution for the corridor. Also, flexibility must be incorporated into the design in order not to preclude potential changes in operation, such as outside-to-inside lane and reversible to two-way operations. Access, freeway-to-freeway connections, and enforcement would have to be accommodated for such changes.

**(a) Inside Versus Outside HOV Lane.**

System continuity and consistency of HOV lane placement along a corridor are important and influence facility development decisions. Issues that should be considered include land use, trip patterns, transit vehicle service, HOV main line and ramp volumes, main line congestion levels, safety, enforcement, and direct access to facilities.

The inside HOV lane (left lane) is most appropriate for a corridor with long distance trip patterns, such as a freeway providing mobility to and from the central business district or a large activity center. These trips are characterized by long haul commuters and express transit vehicle service. Maximum capacity for an effective inside HOV lane is approximately 1,500 vehicles per hour. When HOV volumes exceed 1,500 vehicles per hour, the HOVs weaving across the general-purpose lanes may cause severe congestion. In these situations consideration should be given to implementing direct access HOV ramps, physically separated HOV roadways, or providing a higher occupancy designation.

The outside HOV lane (right lane) is most appropriate for a corridor with shorter, widely dispersed trip patterns such as a freeway that encircles the central business district and provides mobility for the suburb-to-suburb commuters. These trip patterns are characterized by transit vehicle routes that exit and enter at nearly every interchange. The maximum capacity for an effective outside HOV lane is approximately 1,100 vehicles per hour. Capacity is reduced and potential conflicts are increased by heavy main line congestion and large entering and exiting general-purpose volumes since they must cross through the HOV lane.

**(b) Conversion of a General-Purpose Lane.**

Conversion of a general-purpose lane to an HOV lane may be justified when the conversion provides greater people-moving capability on the roadway. Given sufficient existing capacity, converting a general-purpose lane to an HOV lane will provide for greater people moving capability in the future without significantly affecting the existing roadway operations. From an engineering standpoint, the fastest and least

expensive method for providing an HOV lane is through conversion of a general-purpose lane. Striping and signing are sometimes the only engineering features that need be implemented. Converting a general-purpose lane to HOV use would likely have long-term environmental benefits. This method, however, is controversial from a public acceptance standpoint. Public support may be gained through an effective public involvement program. See Chapter 210, Public Involvement and Hearings.

Lane conversion of a general-purpose lane to an HOV lane must enhance the corridor's people moving capacity. It is critical that an analysis be conducted. This analysis shall address:

- Public acceptance of the lane conversion.
- Present and long-term traffic impacts on the adjacent general-purpose lanes and the HOV lane.
- Impacts to the neighboring streets and arterials.
- Legal, environmental, and safety impacts.

The analysis must reflect an overall increase in people moving capacity, and this analysis must be included in the design report.

**(c) Use of Existing Shoulder.** When considering the alternatives in order to provide additional width for an HOV lane, the use of the existing shoulder is not a preferred option. To use the existing shoulder is a design deviation and approval is required.

Shoulder conversion to an HOV lane should only be used when traffic volumes are heavy and the conversion is a temporary measure. Another alternative would be to use the shoulder as a permanent measure to serve as a transit-only lane during peak hours and then reverted to a shoulder in off peak hours. The use of the shoulder creates special signing, operational, and enforcement problems. An agreement must be executed with the transit agency to ensure that transit vehicles will only use the shoulder during peak hours. The use of the shoulder must be clearly defined by signs which include the words TRANSIT ONLY and SHOULDER. Special operations should be instituted to ensure the shoulder is

clear and available for the designated hours. These operational alternatives must be documented in the design report.

The existing shoulder pavement is often not designed to carry heavy volumes of HOVs, especially transit vehicles. As a result, repaving and reconstruction of the shoulder may be required.

(d) **Direct Access.** To maximize the efficiency of the HOV system, exclusive HOV access ramps for an inside HOV lane are recommended. Direct access eliminates the HOV user crossing the general-purpose lanes since most of the main line ingress and egress movements are from the outside (right side). Also, transit vehicles will be able to use the HOV lane and provide service to frequently spaced interchanges.

Providing the HOV user access to the inside HOV lane without mixing with the general-purpose traffic saves the user additional travel time and aids in safety and enforcement, incident handling, and overall operation of the HOV facility.

Key locations for direct access ramps include park and ride lots and flyer stop interchanges. Coordination with the local transit agencies will result in the identification of these key locations. Priority should be given to locations that serve the greatest number of transit vehicles and other HOVs. Transit agencies may provide funding for the construction of a direct access ramp that serves transit vehicles.

Direct access of any type is usually very expensive due to the structural and right of way requirements. If direct access ramps are not included in the initial project, provisions should be made so that they can be added later or at least the design should not preclude their addition at a later date.

(e) **Queue Bypass Lanes.** The type of congestion, the HOV demand, or the physical roadway characteristics may warrant a short, preferential treatment that allows HOVs to save time by avoiding congestion at an isolated bottleneck. The bottleneck may be operational due to capacity restrictions or artificially introduced by metering. An acceptable range of time savings

for queue bypasses are one to three minutes, although much larger time savings may be experienced, particularly at metering sites. Typical locations for queue bypasses are at ramp meters, signalized intersections, toll plaza or ferry approaches, and parallel facilities in conjunction with isolated main line congestion. By far the most common use is with ramp metering. This type of treatment can be accomplished along with a corridor HOV facility or independently. In most cases, these treatments are relatively low cost and can be readily implemented. HOV bypasses should be included on all ramp metering sites or provisions made for the future accommodation, unless specific location conditions dictate otherwise.

(f) **Transit Flyer Stops.** A variation of direct access is to provide a flyer stop (also known as express transit stations) where transit vehicles traveling on the freeway stop alongside the freeway on a special ramp constructed for transit vehicle use only. Pedestrians access the flyer stop by way of stairs, wheelchair accessible ramps, and elevators. Ideally, the flyer stop is separated by barriers from the rest of the freeway.

## 1050.05 Operations

### (1) Vehicle Occupancy Designation

The vehicle occupancy designation should provide for the maximum movement of people in a corridor, provide free-flow HOV operations, reduce the empty lane perception, provide for the ability to accommodate future HOV growth within a corridor, and be consistent with the regional transportation plan and the policies adopted by the metropolitan planning organization (MPO).

An initial occupancy designation must be established, but it is not critical that this initial occupancy level be based on detailed traffic projections and usage for the design year since the requirements can be changed as operational conditions warrant in the future. It is WSDOT policy to use the 2+ designation as the initial occupancy designation. The 2+ carpools are easier to establish and will provide the higher vehicle utilization. A 3+ occupancy designation



should be considered if it is anticipated during initial operation that the volumes will be 1,500 vehicles per hour for a left side HOV lane, or 1,200 vehicles per hour for a right-side HOV lane, or that a 70 km/h (45 mph) operating speed cannot be maintained for more than 90 percent of the peak hour.

In air quality nonattainment areas where transportation sources are a significant cause of pollution, a change in the vehicle occupancy designation is subject to analysis by the MPO.

A possible option is a variable 2+/3+ occupancy designation providing access to the HOV lane for the 3+ HOV users during the peak hours and 2+ HOV users in the nonpeak hours. A variable definition alleviates the under utilization of an HOV lane and allows for a reliable level of service during peak hours. The use of a combination of both fixed and changeable message signing should be considered to indicate a variable carpool designation. Adequate signing and accommodation of enforcement needs must be included in this decision. Coordination with the enforcement agency(s) and an evaluation of the consistency with regional plans and policies is required before implementing this option.

### **(2) Hours of Operation**

WSDOT policy is to provide 24 hours a day HOV designation on freeway HOV lanes. There may be special situations where part time operation during the peak period is appropriate. This involves more complicated signing and enforcement considerations. Additionally, if it involves a shoulder or parking lane that reverts back to its normal usage, special operations should be instituted to ensure the shoulder or lane is clear and available for the designated hours. These operational alternatives must be documented in the design report.

### **(3) Enforcement**

Enforcement is essential to the success of an HOV facility. It shapes public attitudes and maintains the integrity of the facility. Coordination with the Washington State Patrol is critical

when the operational characteristics and design alternatives are being established. This involvement ensures that the project is enforceable and will receive their support.

Any high-speed HOV facility shall provide both enforcement areas and observation points. Ramp facilities also need enforcement areas although the design requirements will be different due to their location and reduced speeds.

Barrier-separated facilities, because of the limited access to SOV violators, are the easiest facilities to enforce. Shoulders provided to accommodate breakdowns may also be used for enforcement. Reversible barrier-separated facilities have dead ramps for the reverse direction that may be used for enforcement. Breaks in the barrier may be needed so emergency responders can access barrier separated HOV lanes and back up to the accident.

Buffer-separated and concurrent flow facilities allow violators to enter and exit the HOV lane at will. For this reason, providing strategically located enforcement areas and observation points is essential.

Consider the impact on safety and visibility for the overall facility during the planning and design of enforcement areas and observation points. Where HOV facilities do not have enforcement areas, or where officers perceive that the enforcement areas are inadequate, enforcement on the facility will be difficult and less effective.

### **(4) SC&DI**

The objective of the Surveillance, Control and Driver Information (SC&DI) system is to make more efficient use of our transportation network. This is done by collecting data, managing traffic, and relaying information to the motoring public.

It is important that an SC&DI system is incorporated into the HOV project and that the HOV facility fully utilize the SC&DI features available. This includes providing a strategy of incident management since vehicle breakdowns and accidents have a significant impact on the efficient operation of both the HOV facilities and the general-purpose lanes.

## 1050.06 Design Criteria

### (1) Design Procedures

HOV projects that add or reconstruct HOV facilities are to be considered as new construction. A design report is required for all HOV projects (including lane conversion alternatives). Refer to Chapter 330, *Design Reports*, for design report procedures.

### (2) Design Considerations

For freeway facilities, the design elements such as horizontal and vertical alignment, vertical clearance, cut and fill slopes for both sides of the freeway, sight distance, weave areas within interchanges, and superelevation shall conform to the criteria in Division 6, Geometrics, and Division 9, Interchanges and Intersections. The roadside safety principles in Division 7 are also applicable.

The design vehicle for HOV facilities should include passenger vehicles, vans, and single unit and articulated buses. Turning roadway widths for HOV on and off ramps shall conform to Figure 1050-2. The design speeds, as a minimum, should be comparable to the general-purpose facilities. The design criteria for paving sections, vehicle characteristics and intersection radii should conform to Chapter 1060, *Transit Benefit Facilities*.

### (3) Adding an HOV Lane

The options for adding an HOV lane are reconstruction, restriping, combined reconstruction and restriping, and possibly lane conversion.

Reconstruction involves creating additional traffic lanes by widening to the inside (left side), the outside (right side), or both. Additional right of way may be required. Restriping involves reallocating the existing paved roadway to create enough space to provide an additional HOV lane. Restriping of lane widths to less than 3.6 m (12 ft) is a design deviation and approval is required.

Reconstruction and restriping can be combined to maximize use of the available right of way. For example, a new lane can be created through a

combination of median reconstruction, shoulder reconstruction, and lane restriping. Each project will be handled on a case by case basis. Generally the following reductions should be considered in order of preference:

- (a) Reduction of the inside shoulder width, provided the enforcement and safety mitigation issues are addressed. (Consideration shall be given not to preclude future direct access by over reduction of the available median width.)
- (b) Reduction of the interior general-purpose lane width to not less than 3.3 m (11 ft).
- (c) Reduction of the outside general-purpose lane width to not less than 3.3 m (11 ft).
- (d) Reduction of the HOV lane to not less than 3.3 m (11 ft).
- (e) Reduction of the outside shoulder width from 3.0 to 2.4 m (10 ft to 8 ft).

If lane width adjustments are necessary, old lane markings must be thoroughly eradicated. It is desirable that longitudinal joints (new or existing) not conflict with tire track lines. If they do, then consideration should be given to overlaying the roadway before restriping.

### (4) Design Criteria for Types of HOV Facilities

(a) **Barrier-Separated HOV Facilities.** The separated HOV facility can be single lane or multilane and directional or reversible. A single lane roadway shall have a minimum cross section of 7.9 m (26 ft) (Figure 1050-3a). A two-lane roadway shall have a minimum width of 11.4 m (38 ft) (Figure 1050-3b).

(b) **Concurrent Flow HOV Lanes.** Concurrent flow HOV lanes are lanes that operate in the same direction as the adjacent freeway lanes and are located either on the outside or inside of the general-purpose lanes (Figure 1050-1).

For both inside and outside HOV lanes, the standard lane width is 3.6 m (12 ft) and the standard shoulder width is 3.0 m (10 ft). Approval of a design deviation is required for lane widths less than 3.6 m (12 ft) and shoulder widths less than 3.0 m (10 ft).

When it is proposed that the inside shoulder be less than 3.0 m (10 ft) for distances exceeding 2.5 km (1.5 mi), enforcement and observation areas must be provided at 1.5- to 3-km (1- to 2-mi) intervals. See Figures 1050-7a and 7b.

Where inside shoulders of less than 2.4 m (8 ft) are proposed for lengths of roadway exceeding 0.8 km (0.5 mi), safety refuge areas must be provided at 0.8- to 1.6-km (0.5- to 1-mi) intervals. These can be in addition to or in conjunction with the enforcement areas. Dedicated incident response teams, contracted towing, or private assistance patrols located along the corridor or in the immediate vicinity are operational mitigations which can be used along with greater spacing between refuge areas. These measures are to provide for the efficient operation and free flow capabilities of the corridor.

A buffer separated HOV facility is a variation of the concurrent flow lanes in which a buffer is provided between the faster moving HOV traffic and the general-purpose traffic to increase safety and driver confidence. The design standards are the same as for the concurrent flow HOV lanes, except for a buffer 0.6 to 1.2 m (2 to 4 ft) in width or greater than 2.4 m (8 ft) in width. Buffer widths between 1.2 and 2.4 m (4 and 8 ft) are not considered desirable since they may be mistakenly used as a refuge area for which they would be inadequate.

(c) **HOV Ramp Bypass.** The HOV bypass may be created by widening an existing ramp, construction of a new ramp where right of way is available, or reallocation of the existing pavement width provided the shoulders are full depth.

Ramp meter bypass lanes are located on the left or right of metered lane(s). Typically, bypass lanes are located on the left side of the ramp. Consult with local transit agencies and the region's Traffic Office for direction on which side (left or right) to place the HOV bypass.

The design of the ramp meter should be determined by the existing conditions at each location. See Figure 1050-4a for the typical

single lane ramp meter with HOV bypass and Figure 1050-4b for the typical two lane ramp meter with HOV bypass.

Both Figures, 1050-4a and 4b, show the required 4.2-m (14-ft) wide observation point/enforcement area. Any other design must be treated as a design exception and documented accordingly. One alternative (a design exception) is to provide a 3.0-m (10-ft) outside shoulder from the stop bar to the main line.

### (5) Direct Access Connections

Direct access ramps, such as Figure 1050-5a and 5b, provide access between the inside HOV facilities (barrier separated or concurrent flow) to another freeway, a local arterial street, or a park and ride facility, by way of an elevated structure.

The design for a single-lane on ramp located on the left side of the main line is shown on Figure 1050-5c.

A less expensive alternative to a flyover ramp is a slip ramp (Figure 1050-6). Slip ramps provide access to and from the barrier separated facility from the inside main line lane. As a result of the operational problems associated with a left-hand slip ramp, a thorough operational analysis should be conducted and adequate signing should be provided.

### (6) HOV Lane Termination

The beginning and end of an HOV facility should be at logical points and should typically avoid existing freeway ramps. There should be adequate sight distance at the terminals, and adequate signing and pavement markings must be provided.

For the termination of an HOV lane, the principles that apply to merge or diverge maneuvers should be used. When the HOV lane is on the inside of the freeway, the desirable or higher values should be used since the interface is with the "fast" lane.

The preferred method is to provide a straight-through move into a mixed-flow lane and drop a general-purpose lane. However, volumes for both the HOV lanes and general-purpose lanes, and

the geometric conditions should be analyzed so that the operational performance of the general-purpose lanes is not compromised.

### **(7) Enforcement Areas**

Enforcement of the inside concurrent flow HOV lane can be done with a minimum 3.0-m (10-ft) inside shoulder. For continuous lengths of barrier exceeding 3 km (2 mi), a 3.0-m (10-ft) shoulder with a 0.6-m (2-ft) shy distance is recommended.

For inside shoulders less than 3.0 m (10 ft), enforcement and observation areas shall be located at 1.5- to 3-km (1- to 2-mi) intervals or based on the recommendations of the Washington State Patrol. These areas can also serve as safety refuge areas for disabled vehicles. Refer to Figure 1050-7a and 7b.

Observation points should be constructed approximately 400 m (1300 ft) before enforcement areas. They can be designed to serve both patrol cars and motorcycles or motorcycles only. Coordination with Washington State Patrol is essential during the design stage to provide effective placement and to ensure utilization of the observation points. Median openings give motorcycle officers the added advantage of being able to quickly respond to emergencies in the opposing lanes. See Figure 1050-7c. The ideal observation point places the motorcycle officer a meter or more in elevation above the HOV lane and outside the shoulder so the officer can look down into a vehicle.

The enforcement pad should be located on the right side for queue bypasses and downstream from the stop bar so the officer can be an effective deterrent (Figures 1050-4a and 4b).

An optional one-section signal head with a 200 mm (8 in) red lens (signal status indicator for enforcement) may be placed at HOV lane installations that are metered. The signal head faces the enforcement pad so that Washington State Patrol can determine if vehicles are violating the ramp meter. The signal head allows Washington State Patrol to simultaneously enforce two areas, the meter and the HOV lane. Consult with Washington State Patrol for use at all locations.

Document in the design report the decision regarding the installation of the signal head. Refer to the *Traffic Manual* regarding HOV metered bypasses for additional information on enforcement signal heads.

### **(8) Signs and Pavement Markings**

The *MUTCD* has established pavement markings and signs for preferential lane-use control. Guidance for use of these items is provided in the *Traffic Manual*.

(a) **Signs.** Restricted use HOV signs should be post mounted next to the HOV lane. The sign wording must be clear and precise, stating which lane is restricted, the type of HOVs allowed and the HOV vehicle occupancy designation approved for that section of road. The sign size, location, and spacing is dependent upon the conditions under which the sign is used and should be consistently applied. Refer to the *Traffic Manual* for additional guidance on signing of HOV facilities. Roadside signs can also be used to convey other HOV information such as the HERO program, carpool information telephone numbers, and violation fines. Some situations may call for the use of variable message signs.

Overhead signs should be placed directly over the HOV lane to provide maximum visibility. A sequence of overhead signs shall be used at the beginning and end of all HOV freeway facilities. Overhead signs can also be used in conjunction with roadside signs along the roadway.

(b) **Pavement Markings.** Pavement markings should conform to the *Traffic Manual* and the *Standard Plans for Road Bridge and Municipal Construction*.

(c) **Interchanges.** In the vicinity of interchange on and off connections where merging or exiting traffic crosses an HOV lane, make provisions for general-purpose traffic using the HOV lane. These provisions include signing and striping that clearly show the changes in HOV versus general traffic restrictions. Refer to the *Standard Plans* for pavement markings and signing.

## **1050.07 Arterial HOV**

There are a variety of HOV treatments available for use on arterials. Some of these treatments are site specific or have limited applications. HOV lanes on arterials are increasingly being considered. Arterial HOV lanes differ from freeway HOV lanes in slower speeds, little access control (turning traffic can result in right angle conflicts), traffic signals, and reduced geometric standards. Arterial HOV lanes are occasionally designated for transit vehicles only, especially in major cities with a large concentration of transit vehicles.

Often, arterial HOV lanes are constructed in relatively short lengths to give an advantage to HOVs approaching a signalized intersection. Arterial HOV lanes are usually located on the outside (right) lane of the roadway because the loading and unloading of transit vehicles usually takes place there. If business and cross streets are present, then SOV traffic should be allowed access to the HOV lane to turn.

Turns across and through the arterial HOV lane can create conflicts. Minimizing access points that create these conflict locations, such as by providing well-delineated driveways, is recommended. Adequate signs and pavement markings are important.

The outside of the HOV lane should have either curb or an edge stripe.

Signal priority treatments which alter the sequence or duration of a traffic signal are techniques for providing preferential treatment for transit vehicles and emergency vehicles. The priority treatments can range from timing and phasing adjustments to signal preemption. The priority treatments may require changes in signal controller equipment and provisions for on-board transit vehicle equipment or special detectors to identify transit vehicles. However, the overall impact on traffic must be considered. Preemption would normally not be an appropriate treatment where traffic signal timing and coordination are being utilized or where there are high volumes on the cross streets.

These priority treatments can significantly improve effectiveness and safety of an arterial HOV facility. Modification of the signal system can provide a low cost priority treatment for transit vehicles. The use of these priority treatments must be coordinated with the local transit agencies and approved by the State Traffic Engineer. For further guidance for the use of signal priority treatments, refer to the *Traffic Manual*.

1050-MBJ:P:DM10

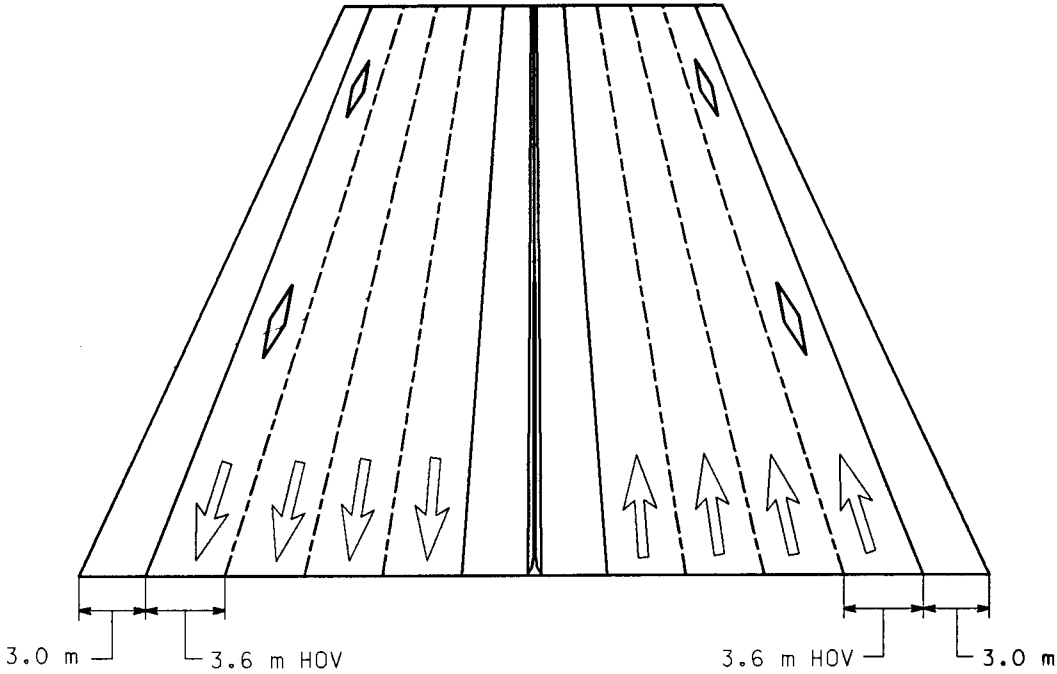

Concurrent flow HOV lanes with outside HOV lanes

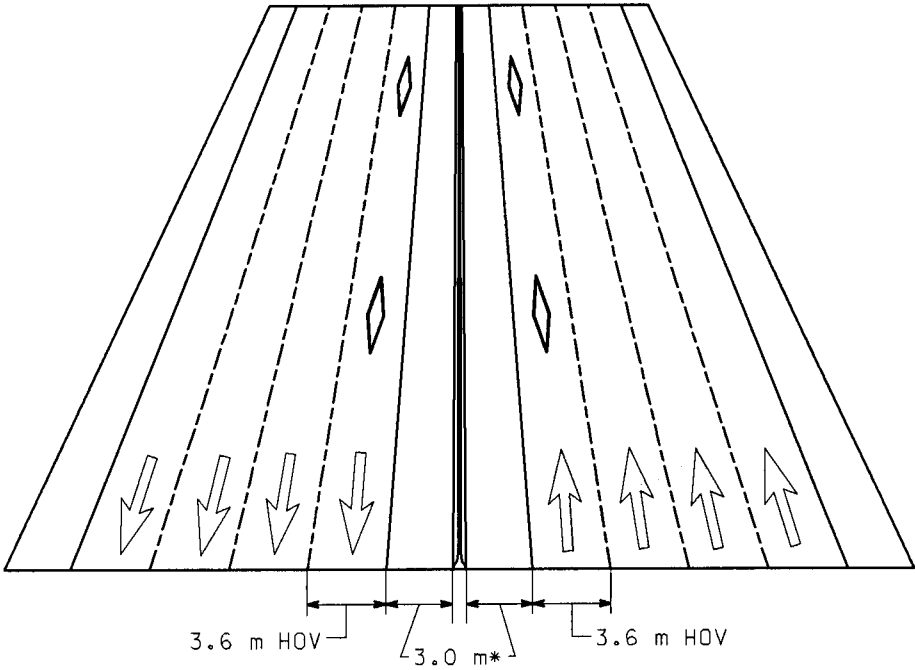

Concurrent flow HOV lanes with median HOV lanes

\*For continuous lengths of barrier, a 3.0 m shoulder with a 0.6 m shy distance is recommended to provide an enforceable corridor.

**Typical Concurrent Flow Lanes**  
*Figure 1050-1*  
*(Metric)*

RADIUS OF TWO-LANE RAMP R (m)	DESIGN WIDTH OF THIRD LANE* W (m)
301 to TANGENT	3.6
300	3.9
180	3.9
150	3.9
120	4.2
105	4.2
90	4.2
75	4.2
60	4.5
45	4.8
30	5.1

\* NOTE: Apply additional width to 2-lane ramp widths. See Chapter 640 for turning roadway widths.

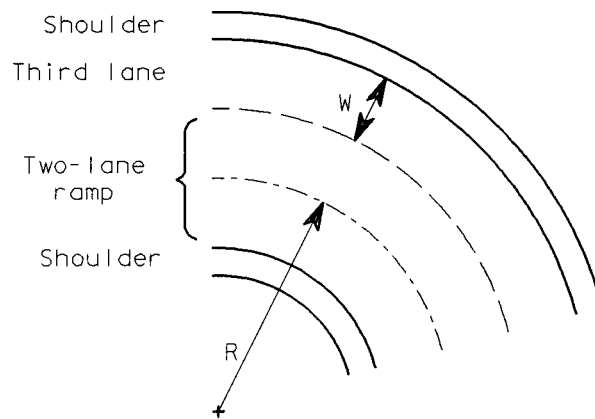

Roadway Widths for Three-Lane HOV On and Off Ramps

Figure 1050-2  
(Metric)

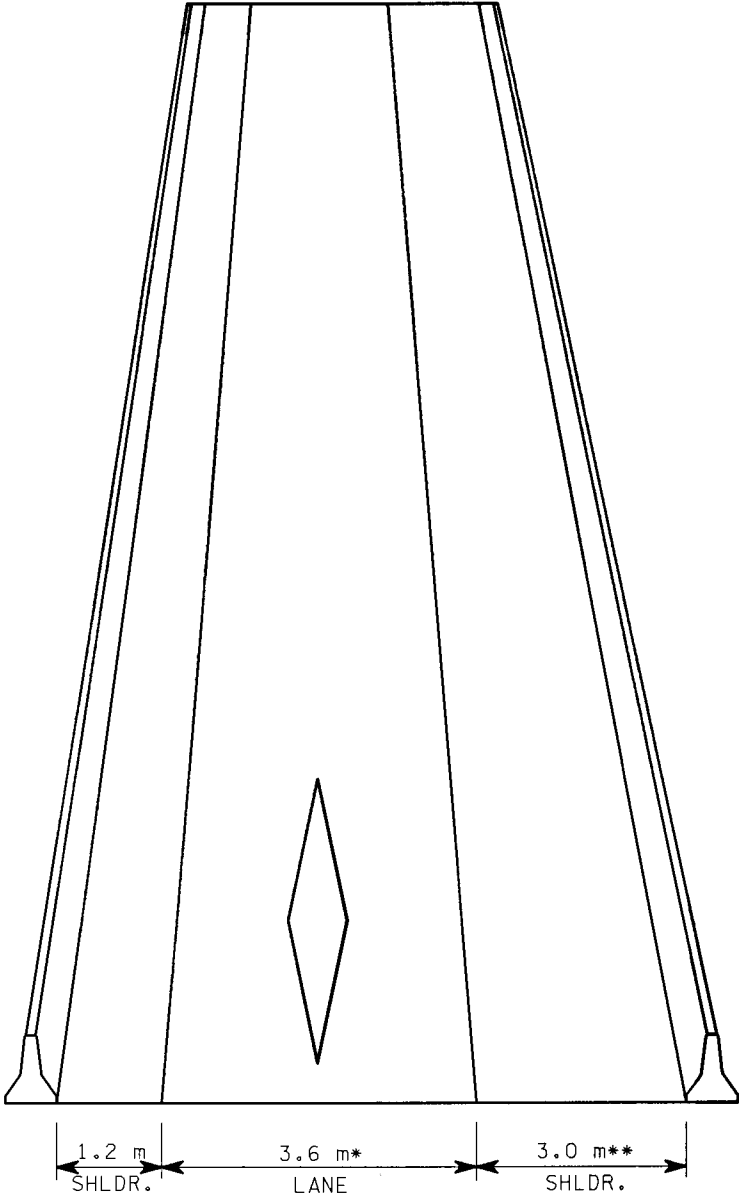

\*See Chapter 640 for turning roadway widths.

\*\*The use of a 2.4 m shoulder will require a design deviation.

**Separated Roadway Single-Lane, One-Way or Reversible**  
*Figure 1050-3a*  
*(Metric)*



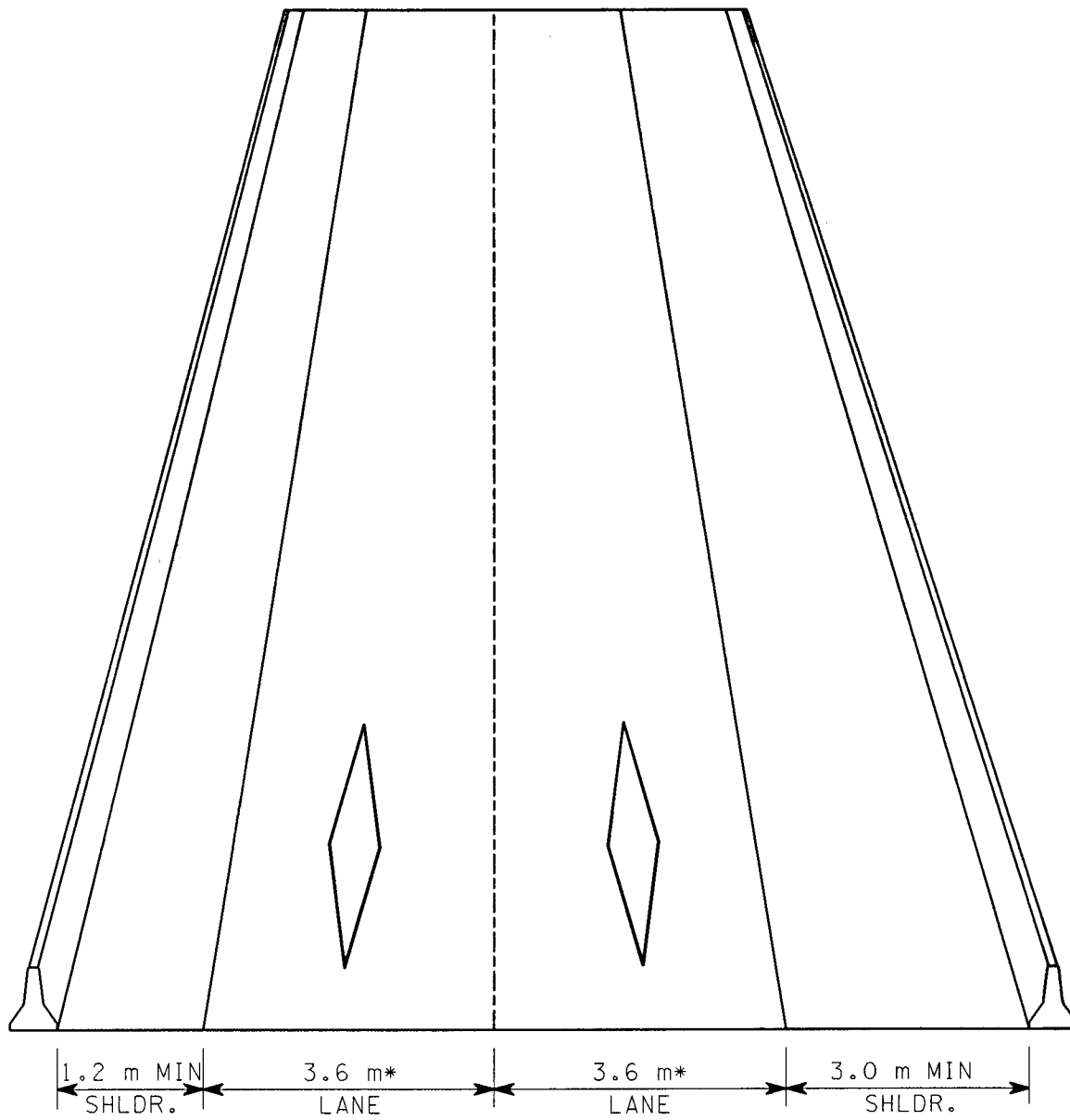

\* See Chapter 640 for turning roadway widths.

**Separated Roadway Multi-Lane, One-Way or Reversible**

*Figure 1050-3b  
(Metric)*

NOTES

1. See Standard Plans for striping details.
2. This distance must equal or exceed the "Acceleration lane length" tabulated in Chapter 940.
3. See Chapter 640 for roadway widths.
4. Use of radii less than 900 m must be justified in the design report.

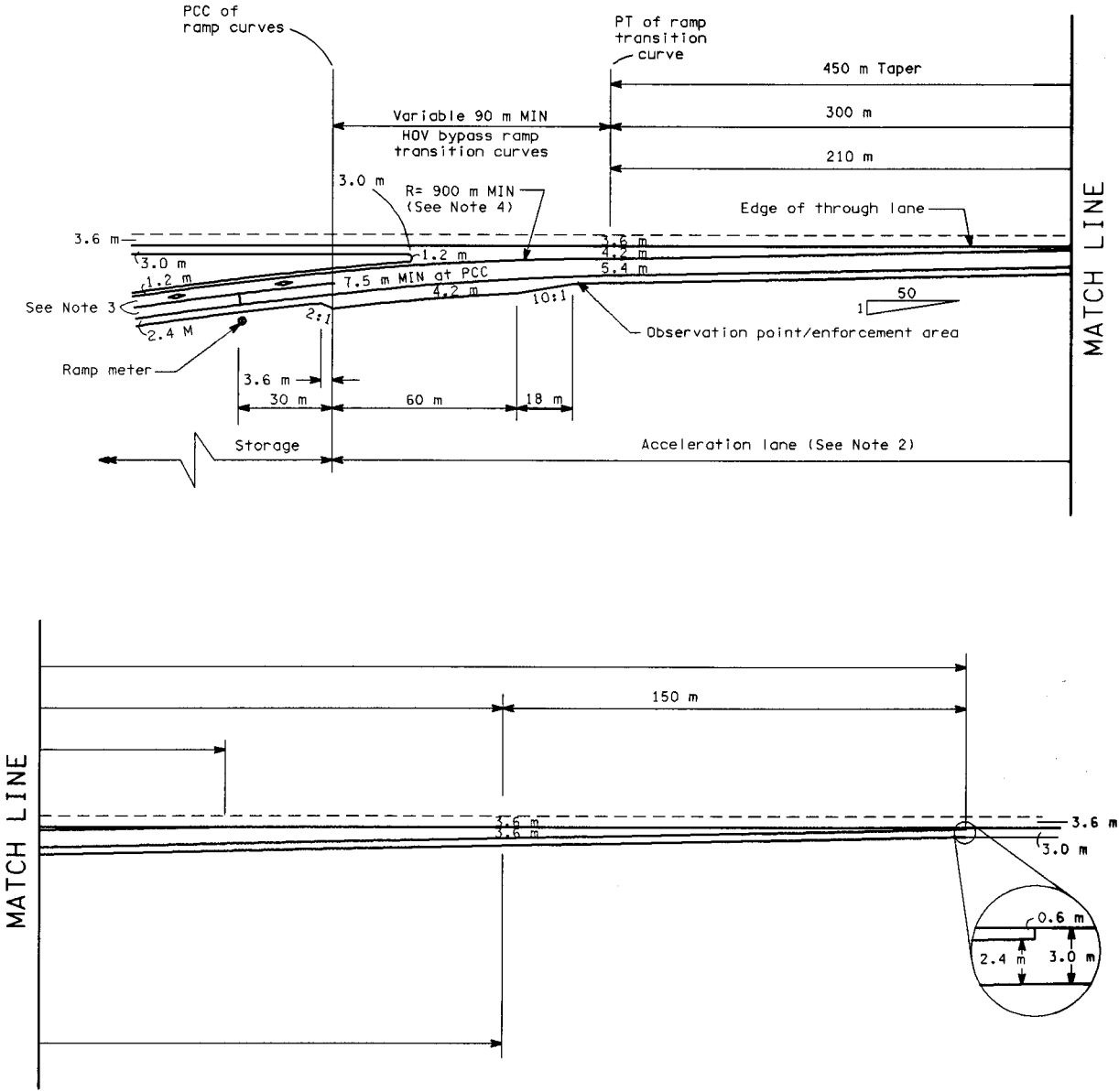

Single-Lane Ramp Meter With HOV Bypass  
 Figure 1050-4a  
 (Metric)

NOTES

1. See Standard Plans for Striping Details.
2. This distance must equal or exceed the "Acceleration Lane Length" tabulated in Chapter 940.
3. See Chapter 640 and Figure 1050-2 for roadway widths.
4. Use of radii less than 900 m must be justified in the design report.

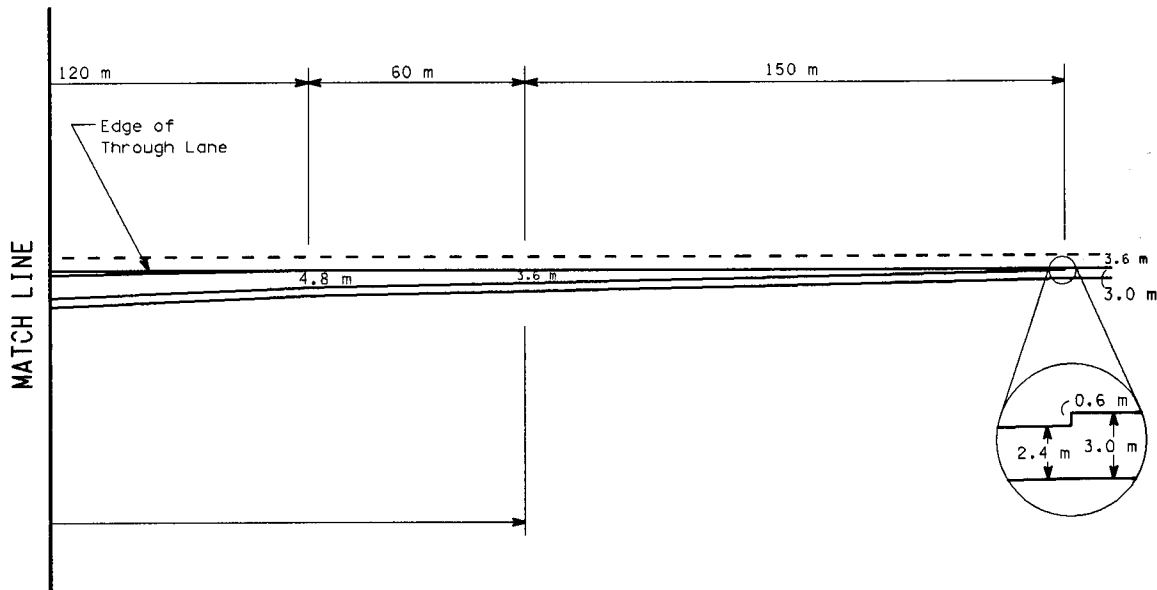
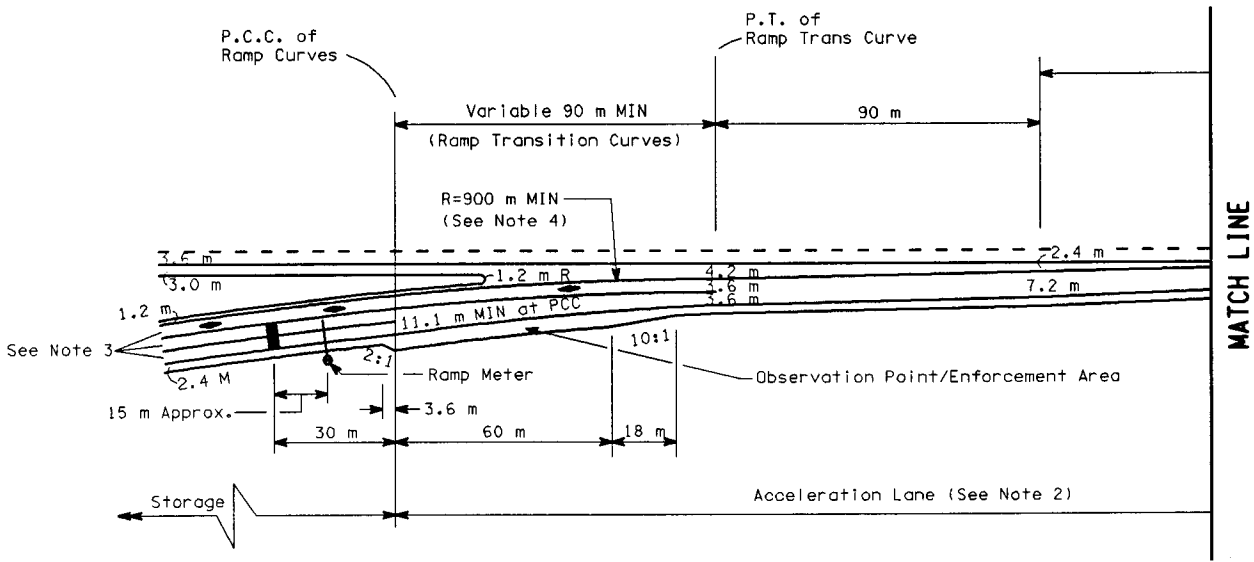

Two-Lane Ramp Meter With HOV Bypass

Figure 1050-4b  
(Metric)

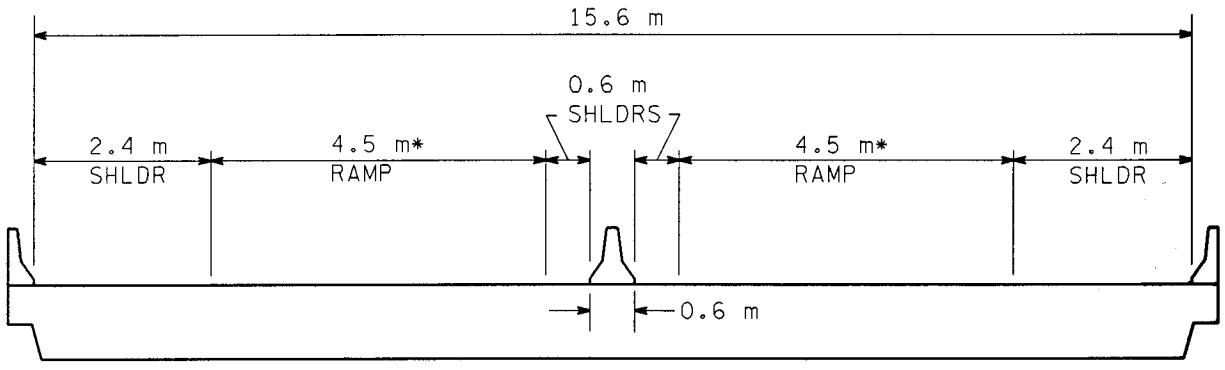
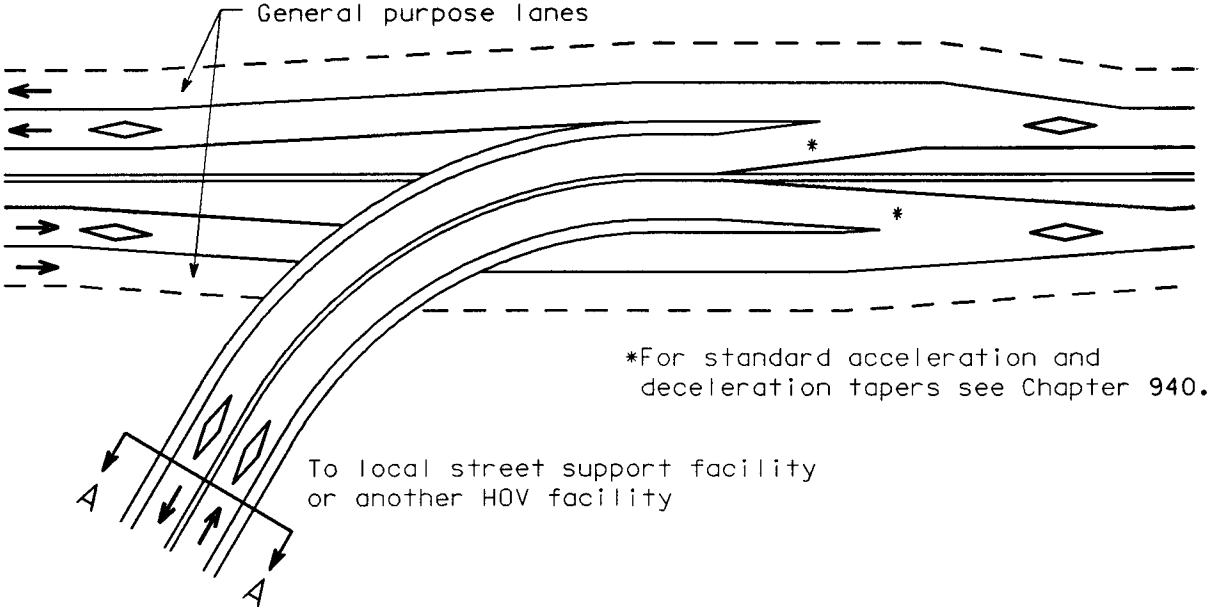

Section A-A

\*See Chapter 640 for turning roadway widths.

Typical HOV Flyover  
Figure 1050-5a  
(Metric)

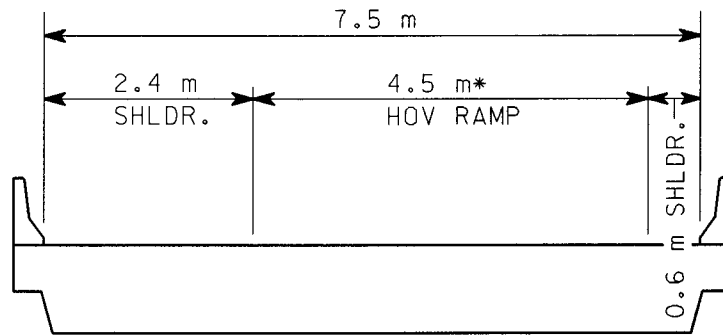
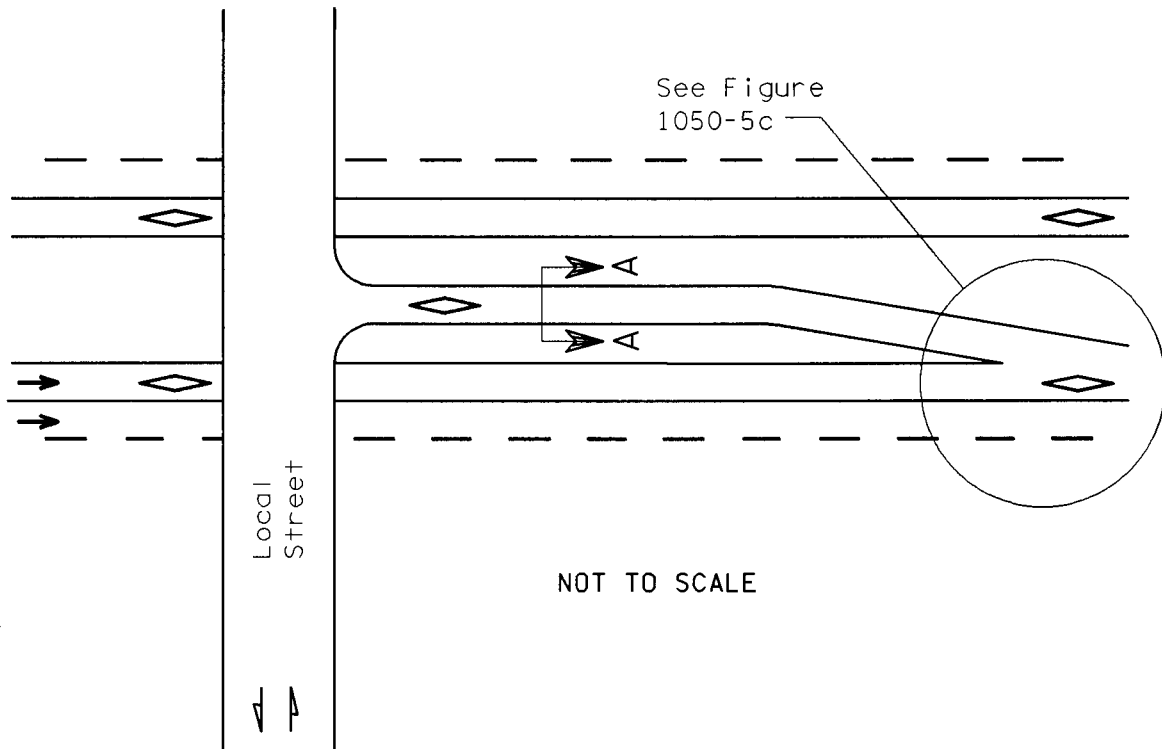

Section A-A

\*See Chapter 640 for turning roadway widths.

Typical Inside Lane On Ramp

Figure 1050-5b  
(Metric)

Inside Single-Lane On Ramp  
Figure 1050-5c  
(Metric)

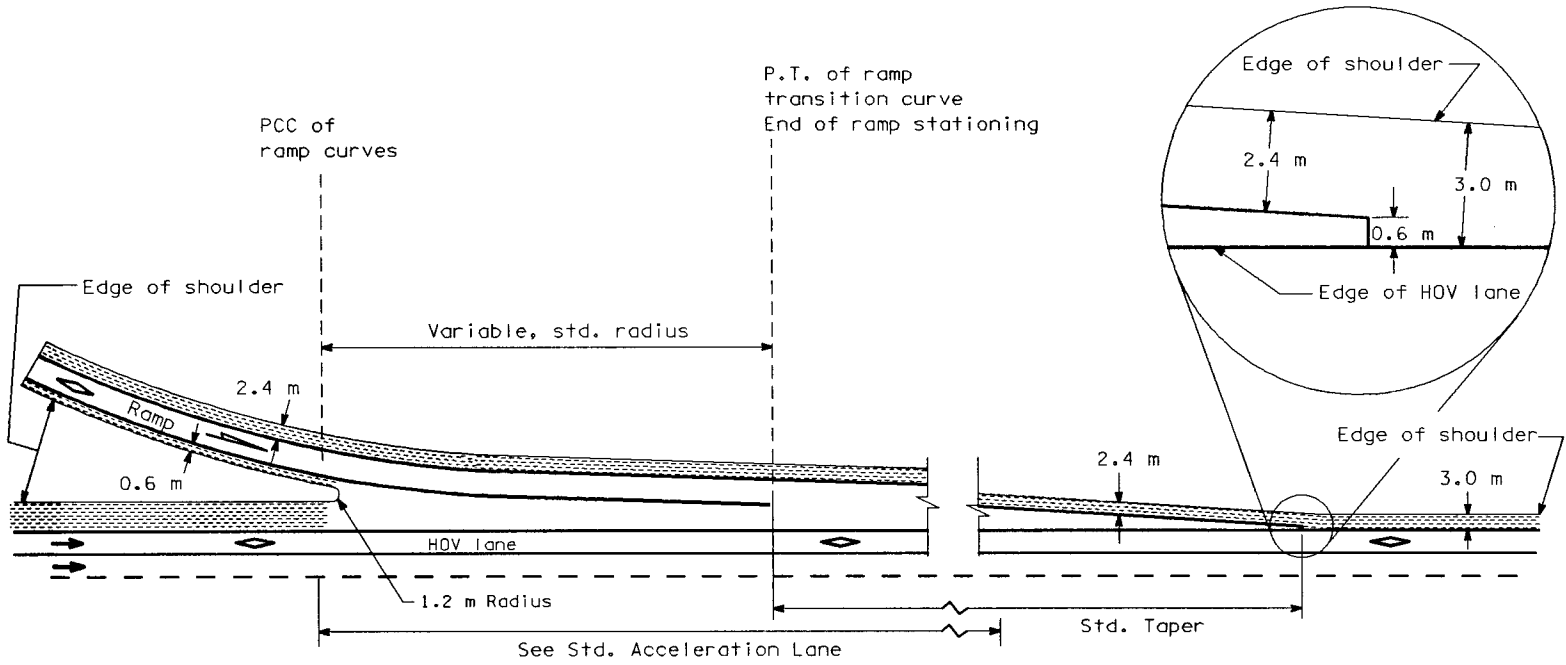

NOTE: See Chapter 940, "Single Lane On Connection".

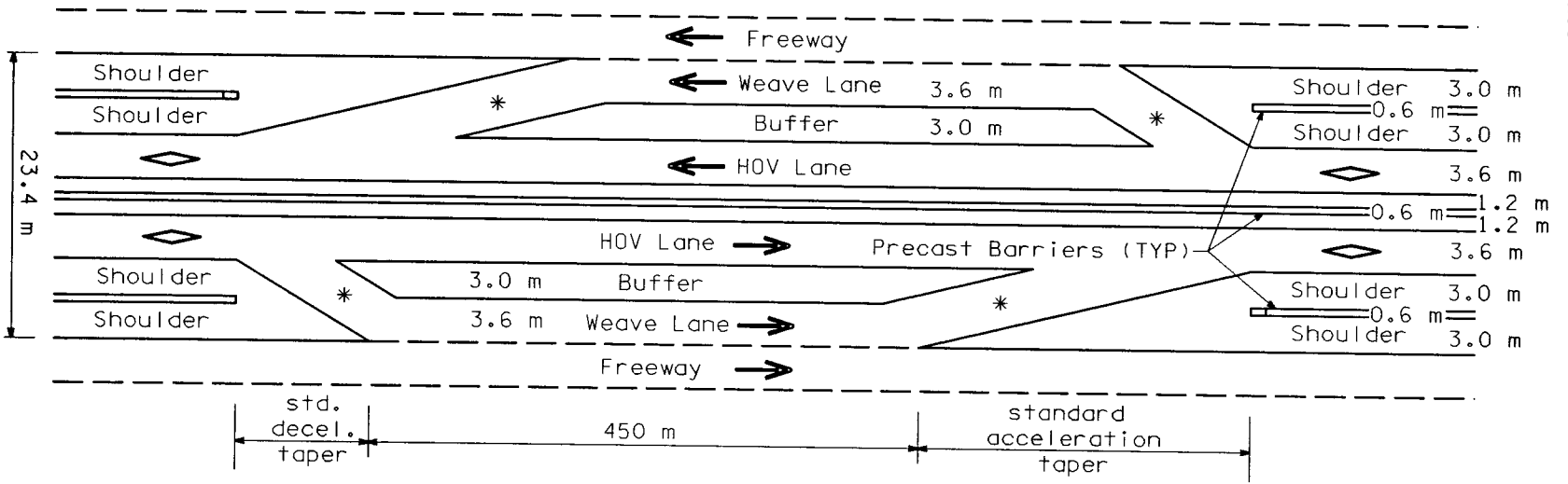

Typical Slip Ramp  
Figure 1050-6  
(Metric)

\* For standard acceleration and deceleration tapers see Chapter 940.

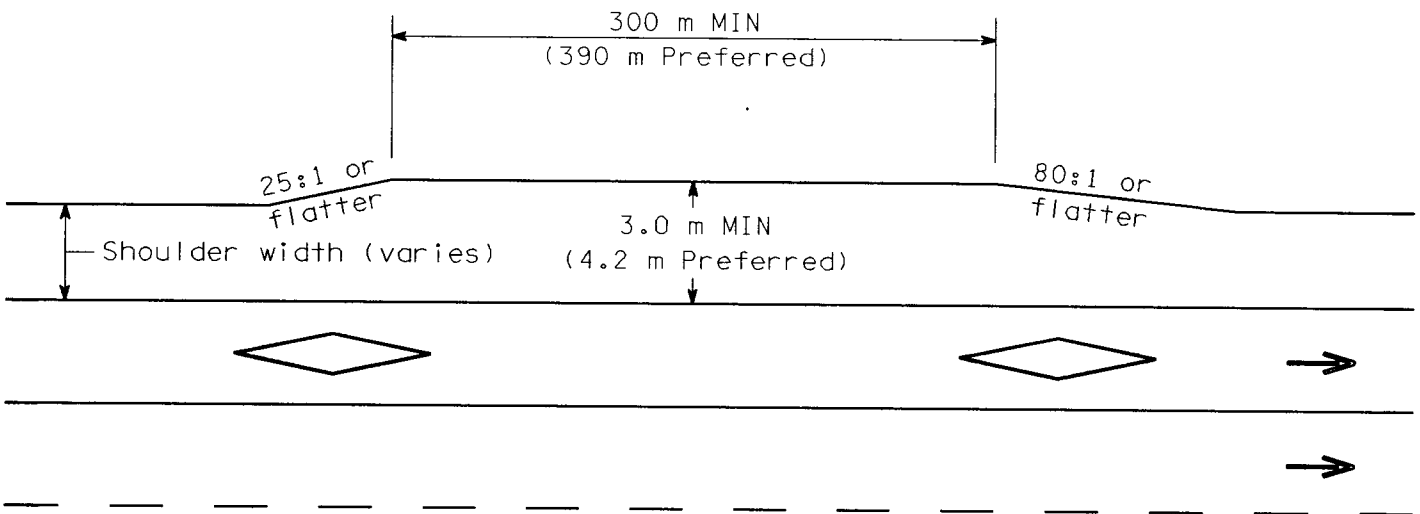

Enforcement Area (One Direction Only)

Figure 1050-7a  
(Metric)



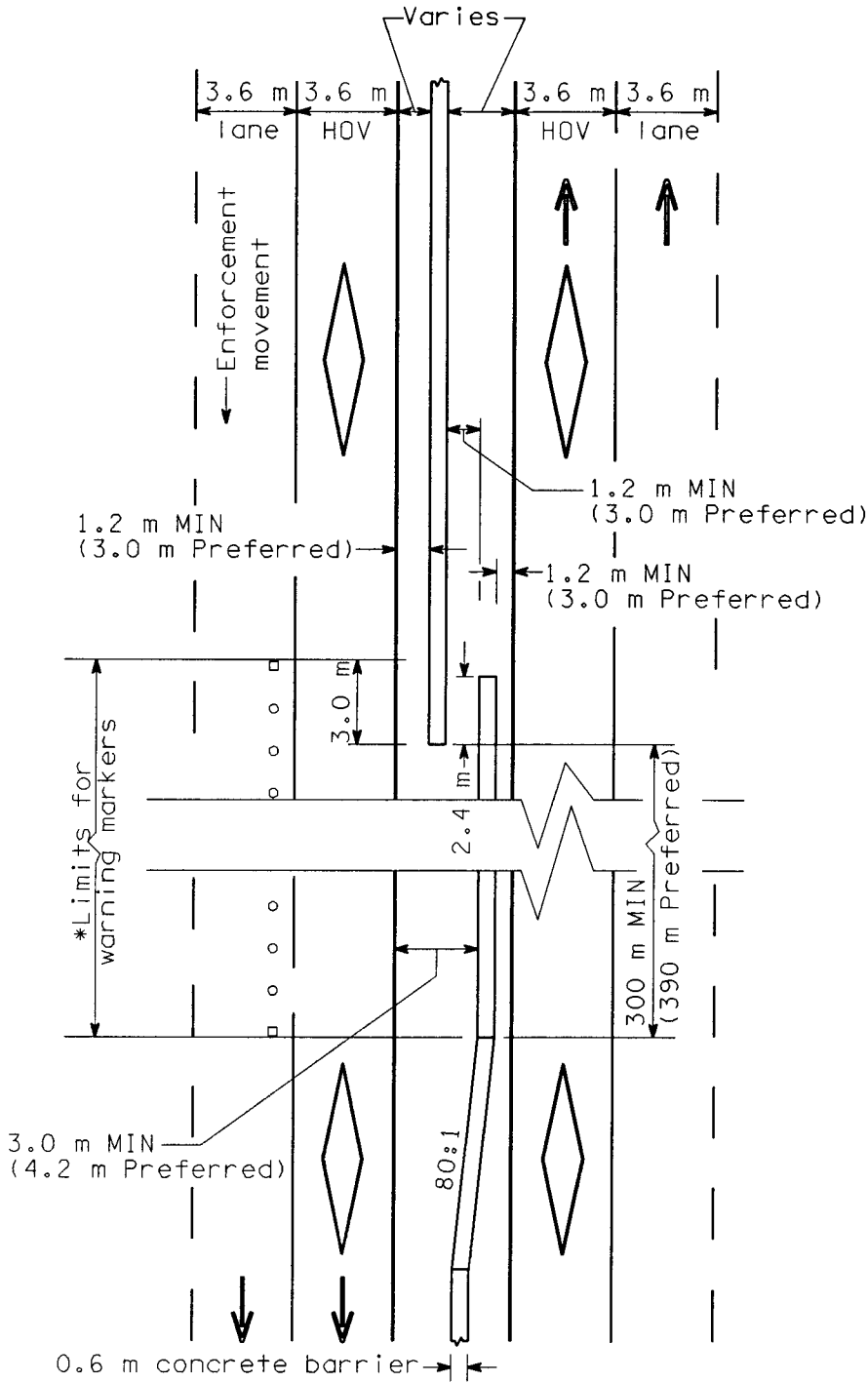

\*Refer to Standard Plans for warning marker details.

**Median Enforcement Area**  
 Figure 1050-7b  
 (Metric)

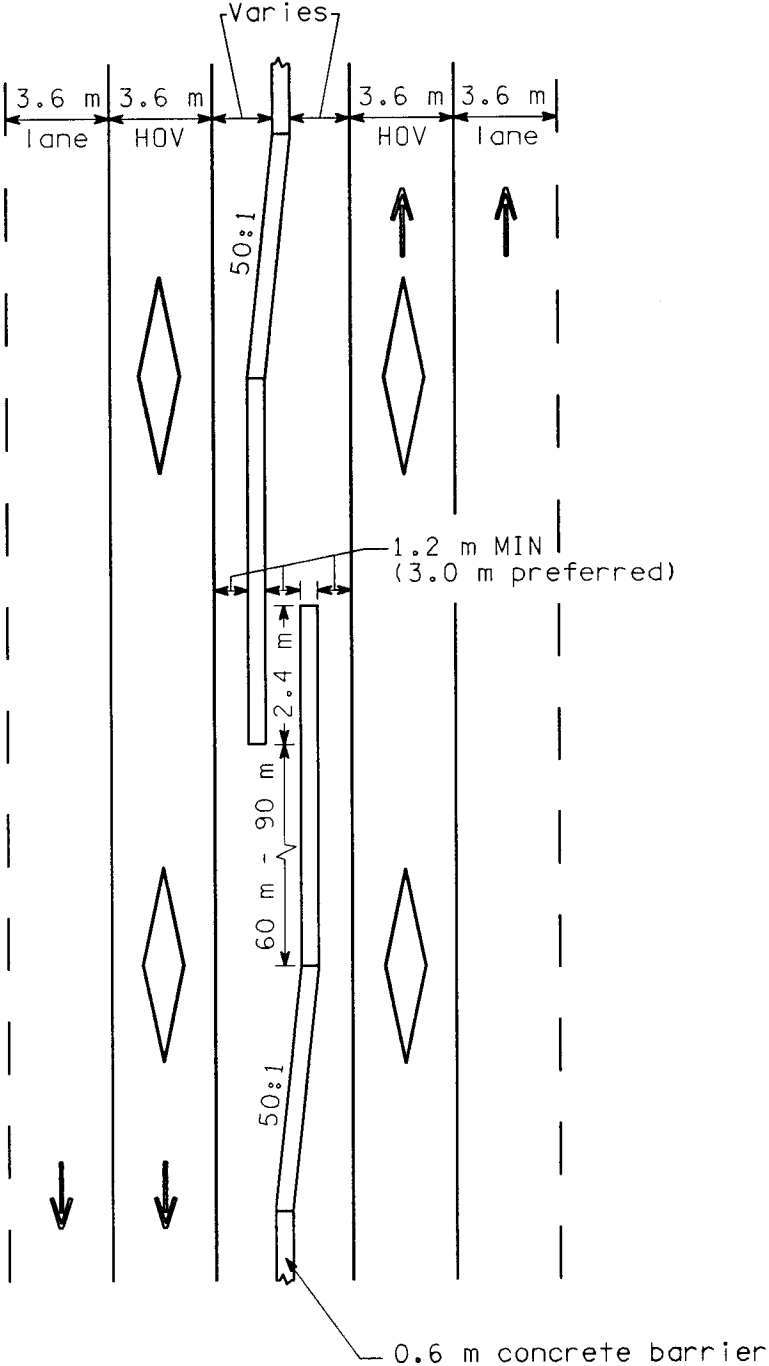

**Bidirectional Observation Point**  
*Figure 1050-7c*  
*(Metric)*

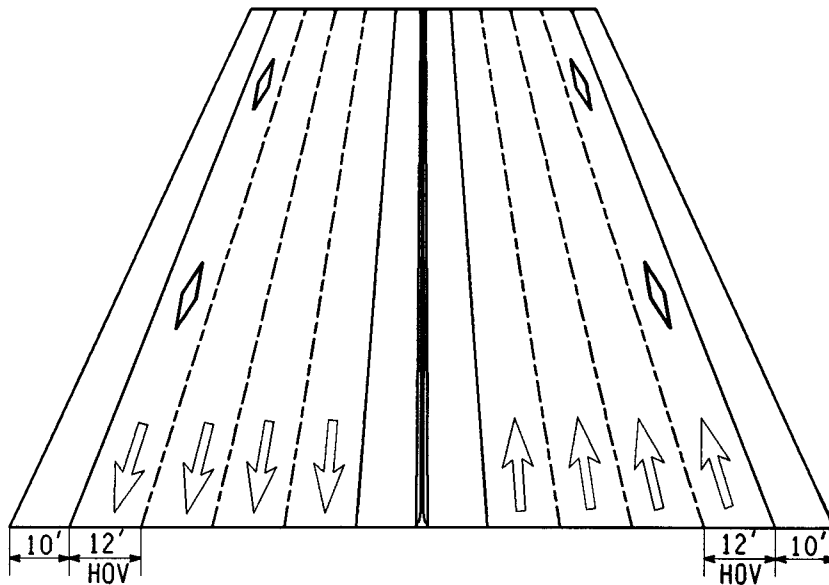

Concurrent flow HOV lanes with outside HOV lanes

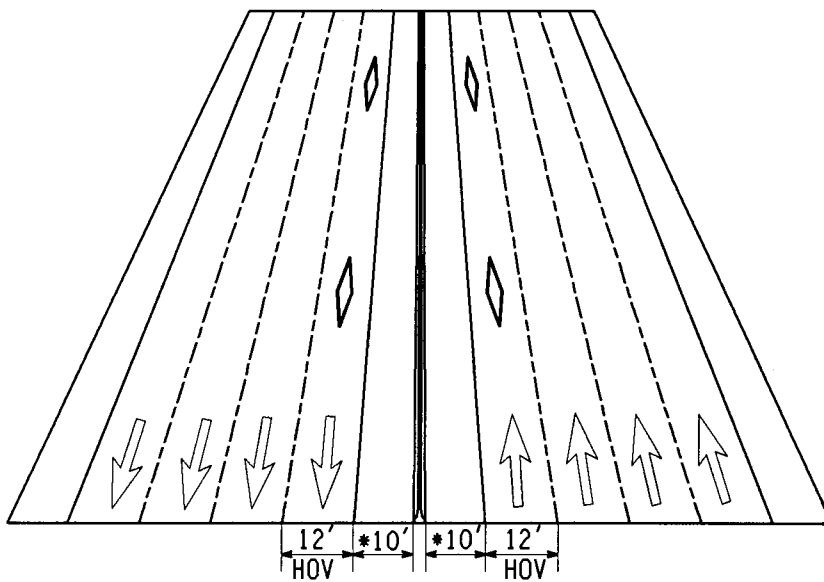

Concurrent flow HOV lanes with median HOV lanes

\*For continuous lengths of barrier, a 10' shoulder with a 2' shy distance is recommended to provide an enforceable corridor.

Typical Concurrent Flow Lanes  
Figure 1050-1

RADIUS OF TWO-LANE RAMP R (ft)	DESIGN WIDTH OF THIRD LANE* W (ft)
1001 to TANGENT	12
1000	13
600	13
500	13
400	14
350	14
300	14
250	14
200	15
150	16
100	17

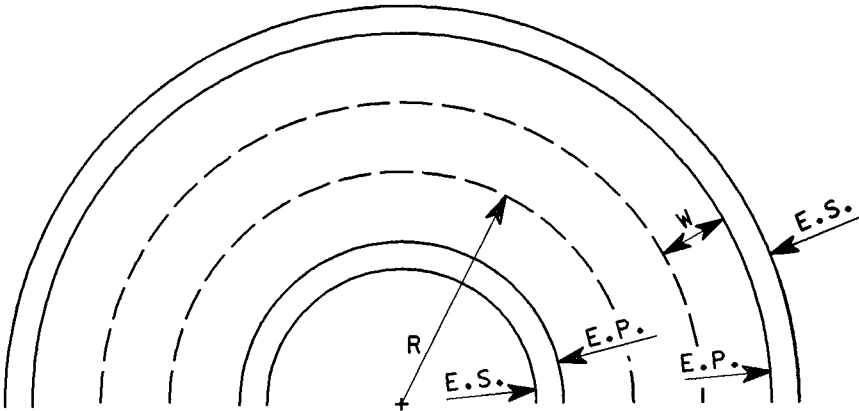

\* NOTE: Apply additional width to 2-lane ramp widths. See Chapter 640 for turning roadway widths.

Roadway Widths for Three-Lane HOV On and Off Ramps  
Figure 1050-2

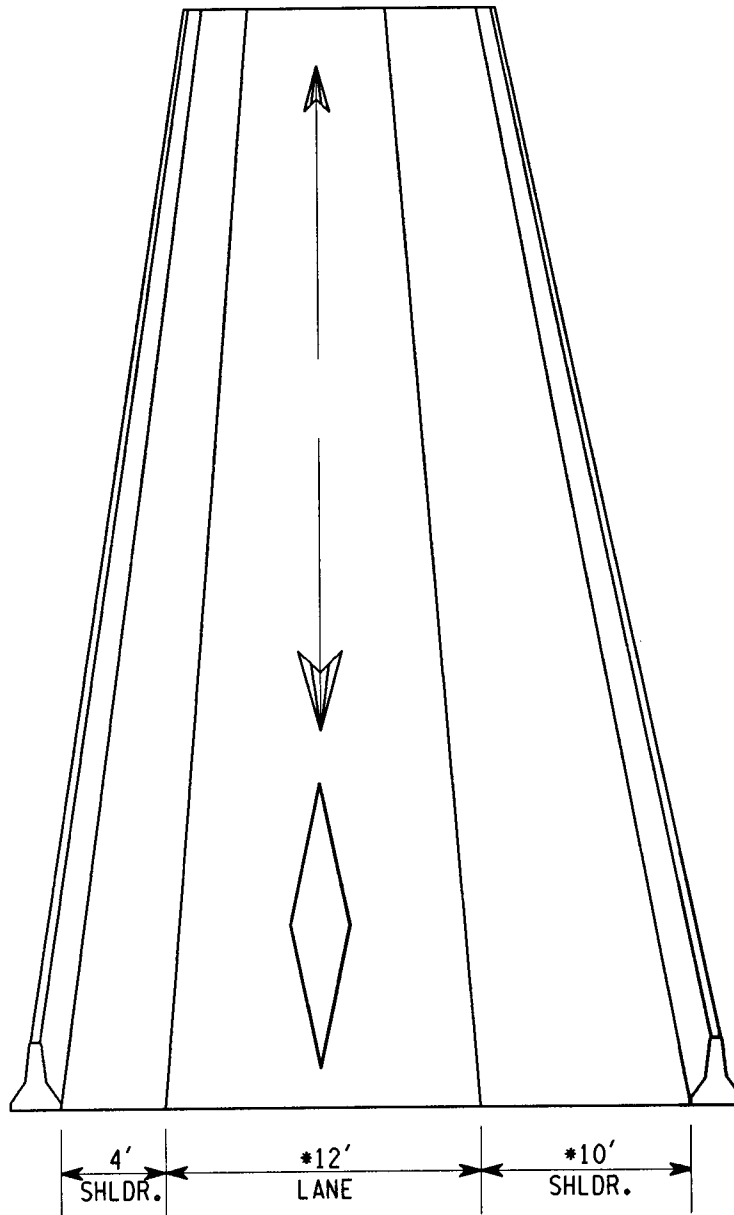

\*See Chapter 640 for turning roadway widths.

\*\*The use of an 8' shoulder will require a design deviation.

**Separated Roadway Single-Lane, One-Way or Reversible**  
Figure 1050-3a

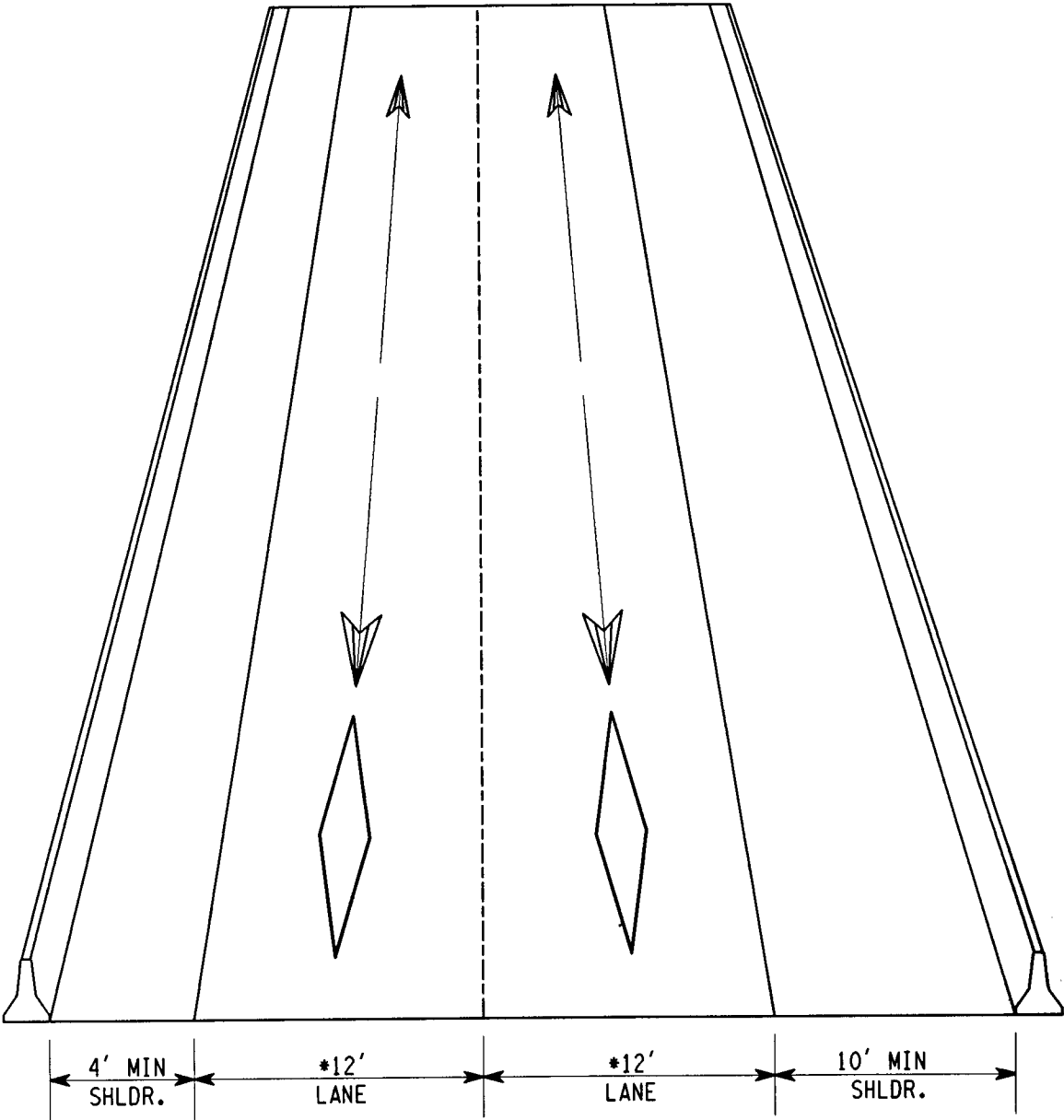

\* See Chapter 640 for turning roadway widths.

**Separated Roadway Multi-Lane, One-Way or Reversible**  
*Figure 1050-3b*

NOTES

1. See Standard Plans for Striping Details.
2. This distance must equal or exceed the "Acceleration Lane Length" tabulated in Chapter 940.
3. See Chapter 640 for roadway widths.
4. Use of radii less than 3000' must be justified in the design report.

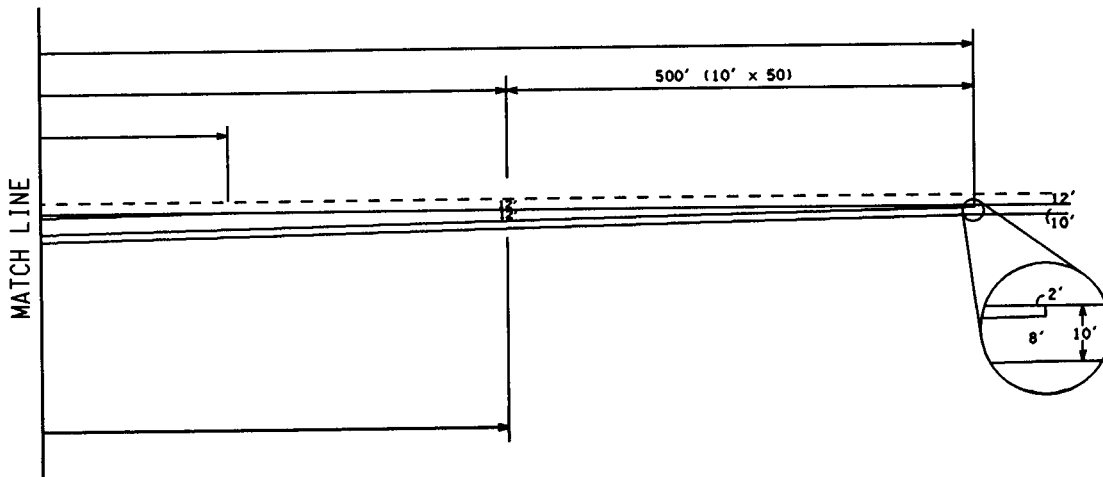
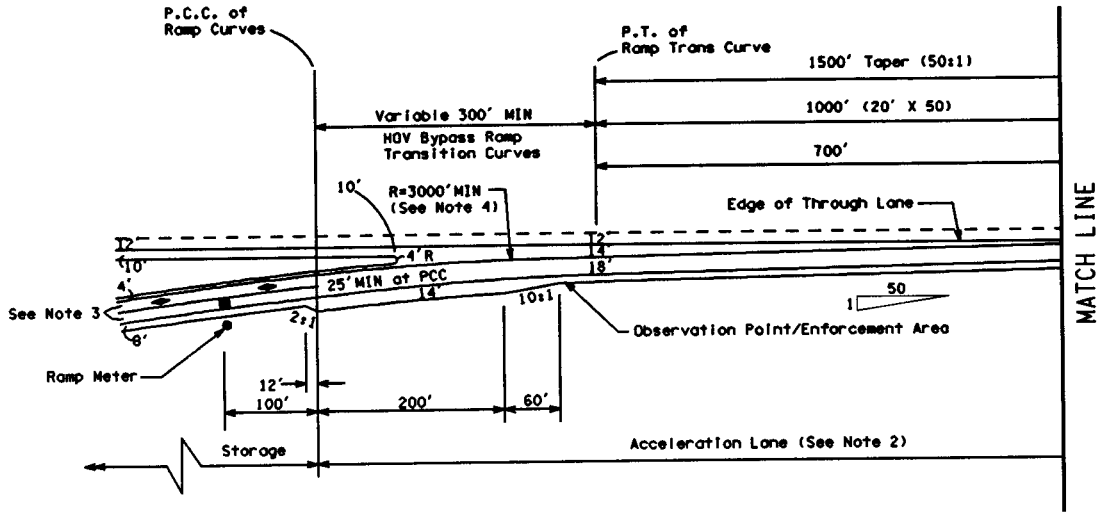

Single-Lane Ramp Meter With HOV Bypass  
Figure 1050-4a

- NOTES**
1. See Standard Plans for Striping Details.
  2. This distance must equal or exceed the "Acceleration Lane Length" tabulated in Chapter 940.
  3. See Chapter 640 and Figure 1050-2 for roadway widths.
  4. Use of radii less than 3000' must be justified in the design report.

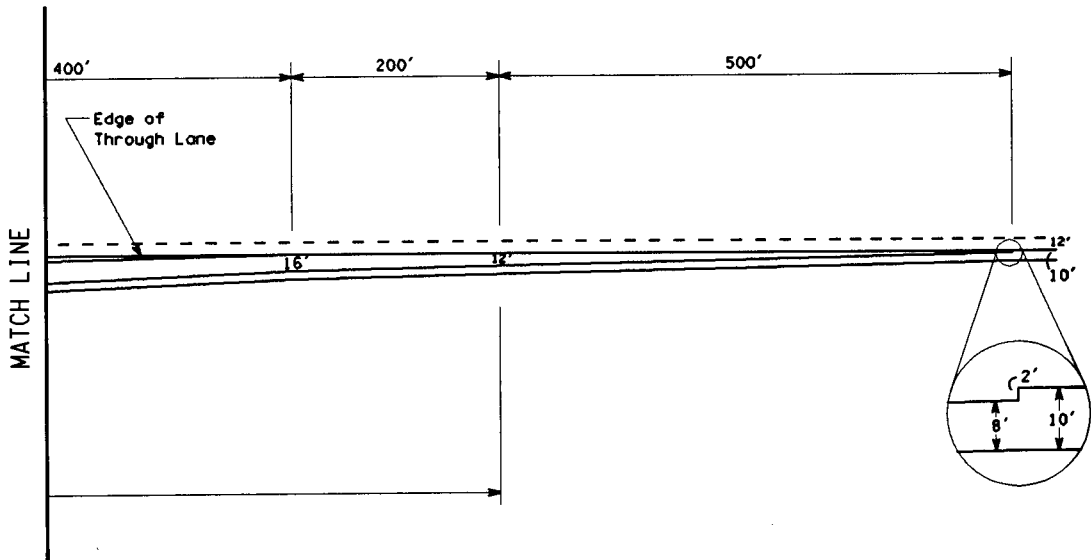
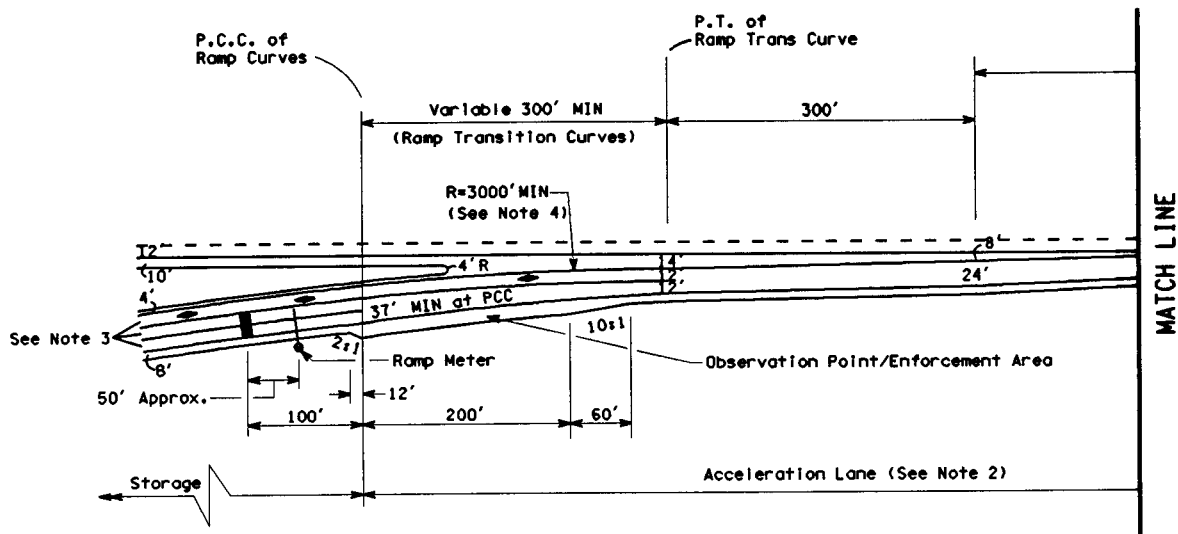

**Two-Lane Ramp Meter With HOV Bypass**  
 Figure 1050-4b



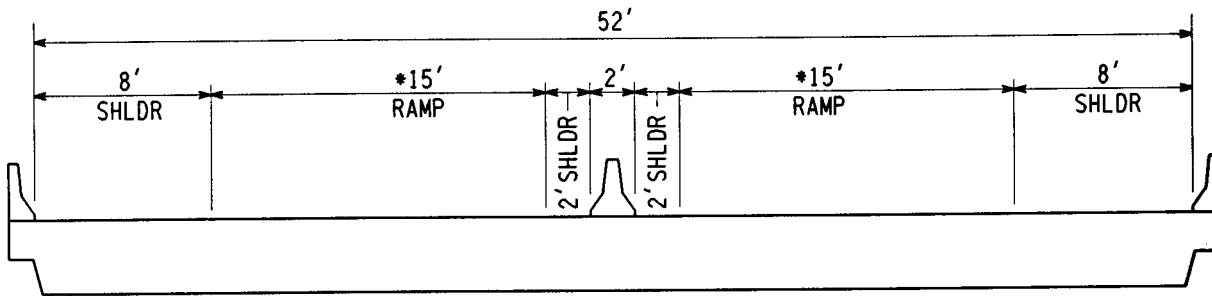
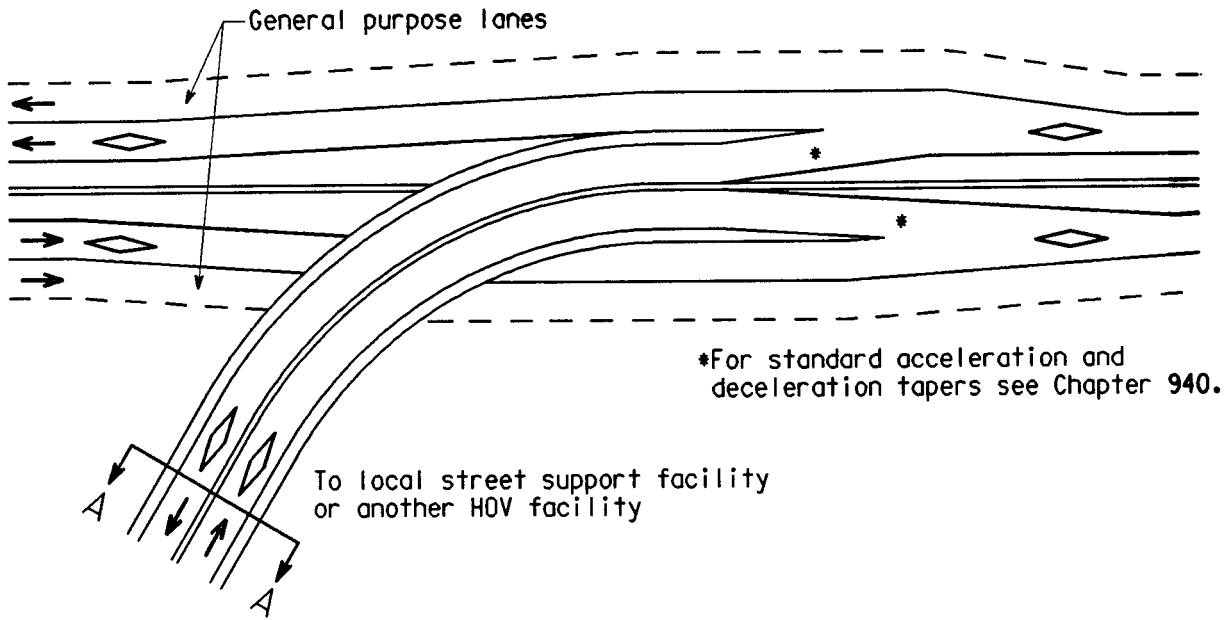

Section A-A

\*See Chapter 640 for turning roadway widths.

Typical HOV Flyover  
Figure 1050-5a

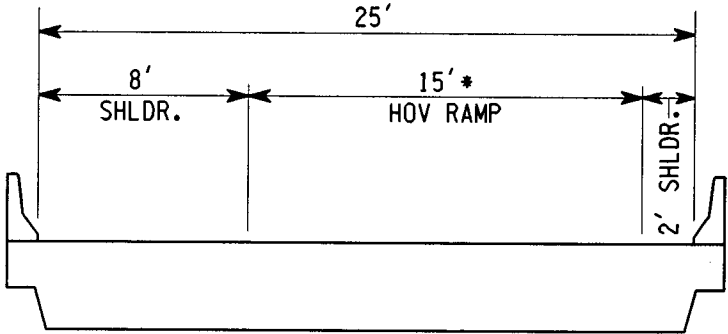
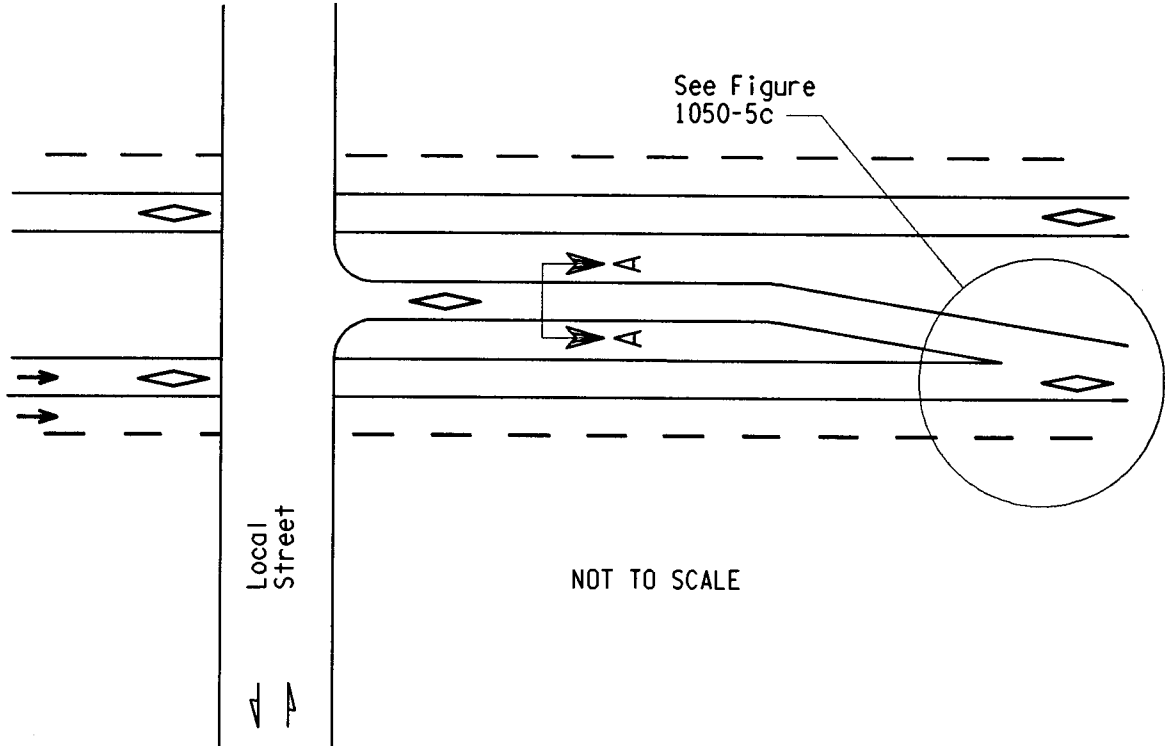

Section A-A

\*See Chapter 640 for turning roadway widths.

Typical Inside Lane On Ramp  
Figure 1050-5b

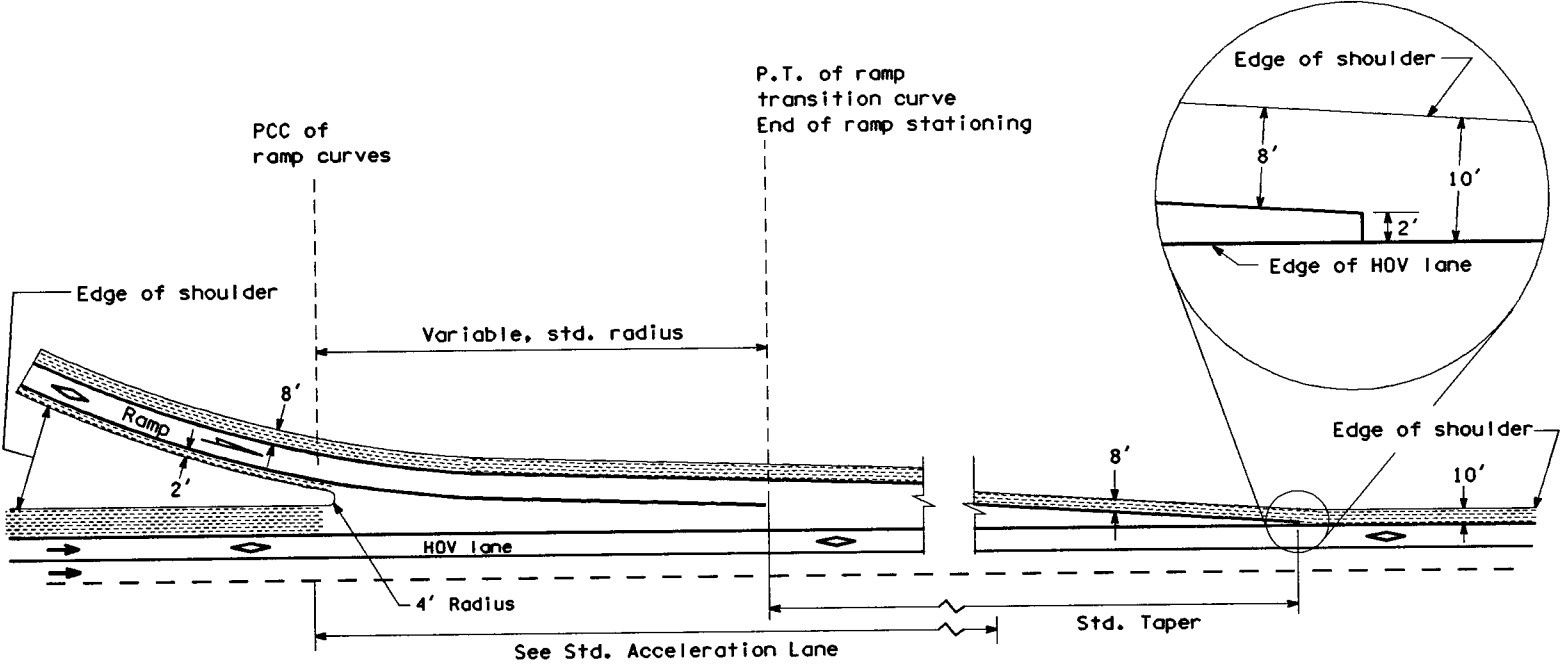

NOTE: See Chapter 940, "Single Lane On Connection".

Inside Single-Lane On Ramp  
Figure 1050-5c

Typical Slip Ramp  
Figure 1050-6

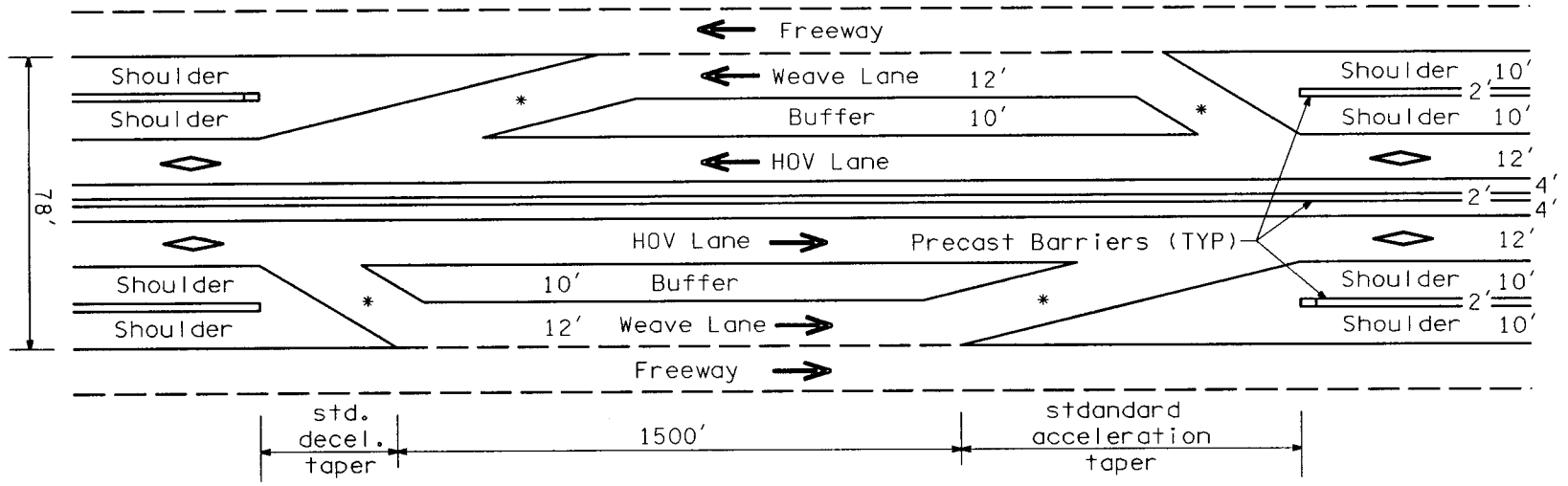

\* For standard acceleration and deceleration tapers see Chapter 940.

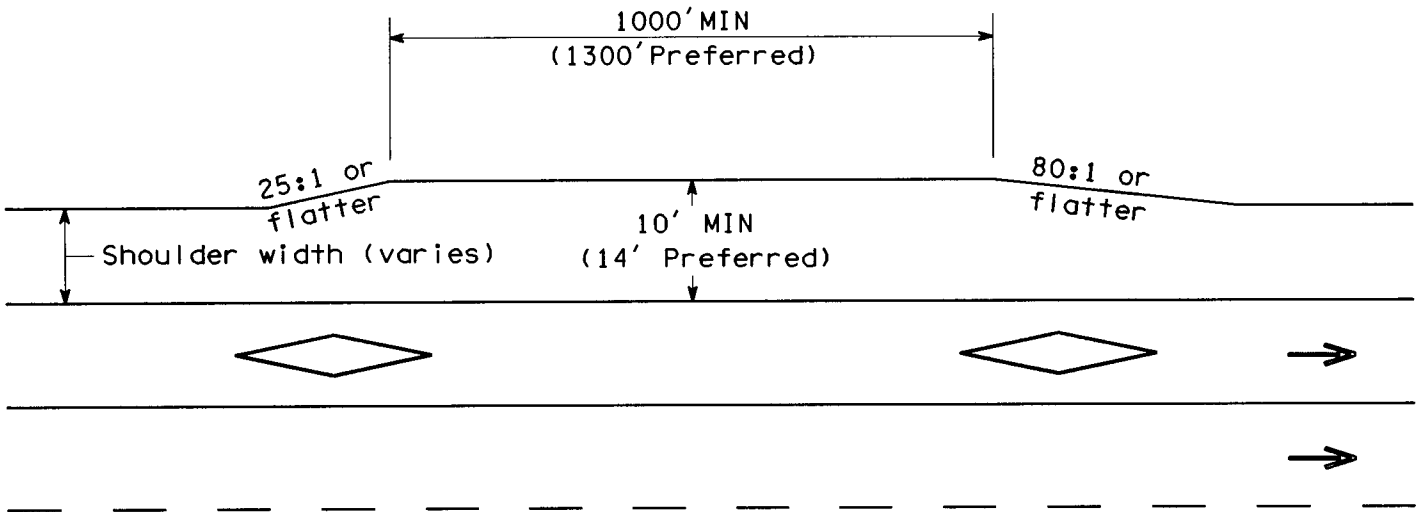

Enforcement Area (One Direction Only)  
Figure 1050-7a

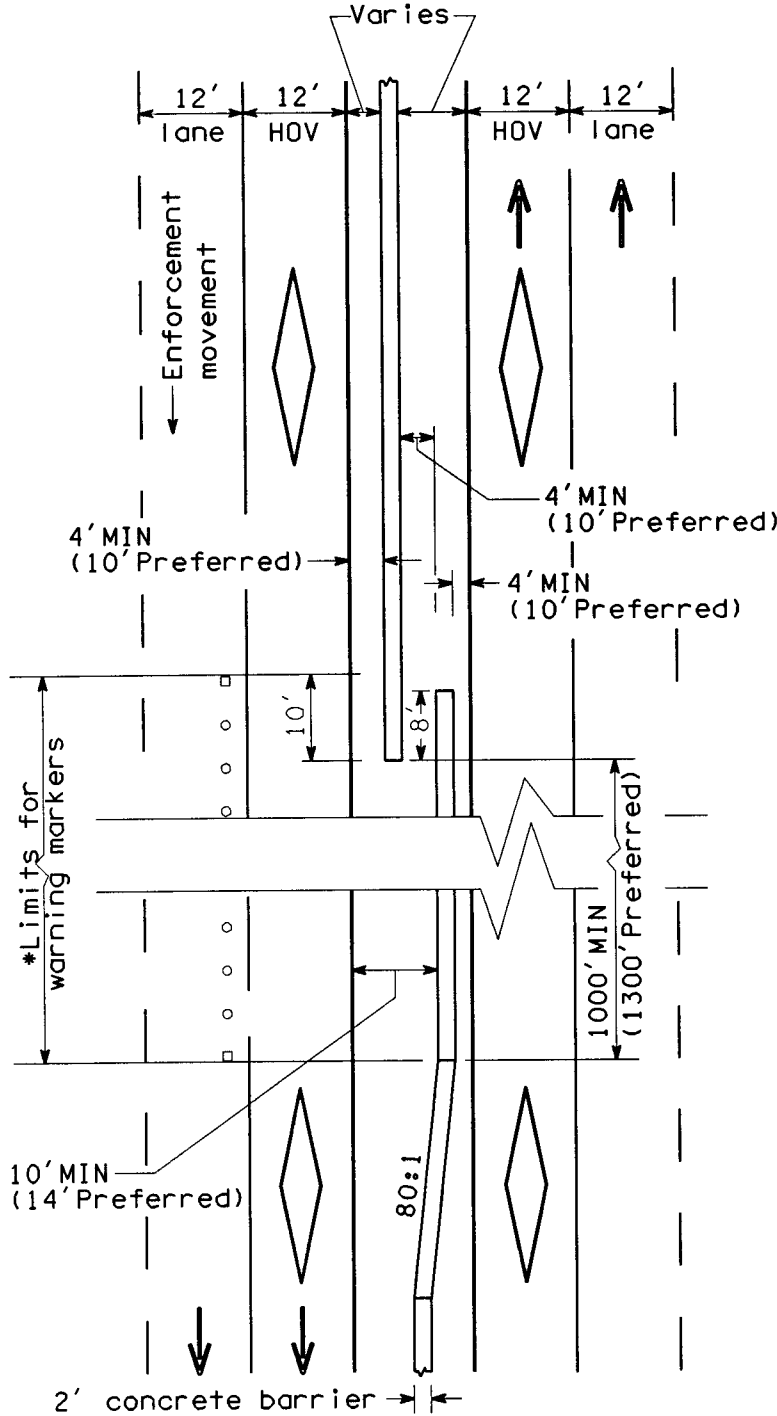

\*Refer to Standard Plans for warning marker details.

Median Enforcement Area  
Figure 1050-7b

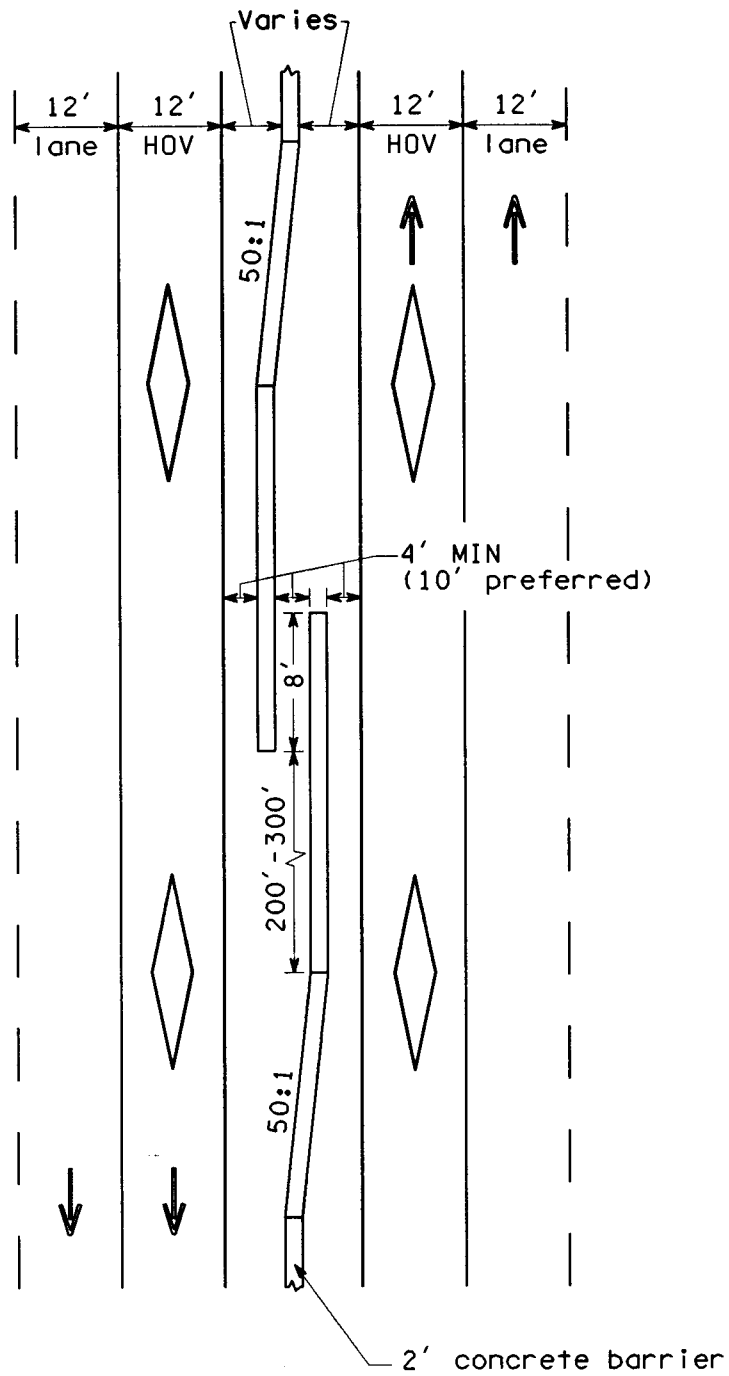

**Bidirectional Observation Point**  
*Figure 1050-7c*

# 1060

## TRANSIT BENEFIT FACILITIES

1060.01	Introduction
1060.02	Definitions
1060.03	Park and Ride Lots
1060.04	Transfer/Transit Centers
1060.05	Bus Stops and Pullouts
1060.06	Passenger Amenities
1060.07	Roadway and Vehicle Design Criteria Characteristics
1060.08	Intersection Radii
1060.09	Disabled Accessibility
1060.10	References

### 1060.01 INTRODUCTION

#### (1) Purpose of Chapter

The purpose of this chapter is to provide operational guidance and information for designing transit benefit facilities for WSDOT, local agencies, and developers on public or private property within Washington.

The design criteria presented represent recognized principles based mainly upon criteria developed by AASHTO. The information presented should not substitute for sound engineering judgement. It must be recognized that some situations encountered will be beyond the scope of this section, since it is not a comprehensive textbook on public transportation engineering.

Private development, which incorporates transit benefit facilities into its design, should use this section as a guide at the direction of staff from the appropriate public jurisdiction.

Coordination between agencies in the location and design of transit benefit facilities has often been catch-as-catch-can” at best. Where transit benefit facilities have been required as a condition of development, there has been some confusion as to what design criteria apply. This chapter, along with the referenced “A Guide to Land Use and Public Transportation,” provides guidance for the design and location of transit benefit facilities.

The design information which follows can help WSDOT, local jurisdictions, and developers assure that transit provides efficient and cost effective service to the public and the community.

#### 1060.02 DEFINITIONS

**articulated bus** a two-section bus that is permanently connected at a joint. An articulated bus is 50 percent longer than a standard bus, has three axles, and can bend around corners.

**bus pull-out** a dedicated parking area for in-service coaches on specified routes, where coaches do not have independent pull-in and pull-out areas.

**bus shelter** a facility which provides seating and protection from the weather for passengers waiting for a bus.

**bus stop** a place where passengers wait to board a bus.

**car/vanpool** a group of people who share the use and cost of a car or van for transportation, on a regular basis.

**feeder service** bus service providing connections with other bus or rail services.

**high occupancy vehicle (HOV)** a vehicle which carries a specified minimum number of persons (Chapter 1050).

**kiss and ride** when patrons of a park and ride lot are dropped off or picked up by private auto or taxi. These are sometimes called drop and ride.

**public transportation** passenger transportation services available to the public, including buses, ferries, rideshare, and rail transit.

**sawtooth berth** a series of bays that are off-set from one another by connecting curblines. They are constructed at an angle from the bus bays. This configuration minimizes the amount of space needed for vehicle pull-in and pull-out.

**standard bus** a bus that is approximately 40 feet in length.

**transit** a general term applied to passenger rail and bus service used by the public.

**transit benefit facility** capital facilities, along with the necessary design considerations, which improve the efficiency of public transportation or encourage the use of public transportation and other HOVs.

### 1060.03 PARK AND RIDE LOTS

#### (1) General

Park and ride lots provide parking for people who wish to transfer from private vehicles to public transit or carpools/vanpools. These lots are intended to increase highway efficiency, reduce energy demands, and increase highway safety by reducing traffic congestion. Most park and ride lots located within urban areas are served by transit; however, the smaller lots may only have local transit service. Smaller leased lots, usually at churches or shopping centers, may have no bus service, and only serve carpools and vanpools. Park and ride lots, located in rural areas not served by buses, also serve carpools and vanpools.

Early and continuous coordination with the local transit authority and local government agencies is critical. When a memorandum of understanding (MOU) exists, which



outlines design, funding, maintenance and operations of the lot program, it must be checked for requirements for new lots. If the requirements cannot be met, the MOU must be renegotiated.

## **(2) Site Selection**

Present and future needs are the main considerations in determining the location of a park and ride lot. Public input is a valuable tool. The demand for and the size of a park and ride lot is dependent on a number of factors. Many of these factors vary with the state of the economy, energy availability and cost, perceived congestion, and public attitude, and are somewhat difficult to predict. Therefore, consider sizing the facility to allow for a conservative first-stage construction with expansion possibilities. As a rule of thumb, one acre can accommodate approximately 90 vehicles in a park and ride lot. This allows about 40 percent of the area for borders, landscaping, passenger amenities, bus facilities for larger lots, and future expansion.

Primary concerns during the design stage include:

- Safe and efficient traffic flows, both on and adjacent to the site, for all modes: transit, carpools, vanpools, pedestrians, and bicycles.
- Adequate lighting and good visibility to enhance security and surveillance of the facility to reduce criminal activity.
- Adequate number of parking spaces.
- Comfortable and attractive facilities.
- Facilities that accommodate use by elderly and disabled users and meet state barrier free design codes.

Local transit authority input is critical because, in some cases, the need for a park and ride lot and its location may already have been determined in the development of their comprehensive transit plan. Failure to obtain transit input could result in a site which does not work well for transit vehicle access.

A list of potential sites should be developed. This can be simplified by the use of existing aerial photos, detailed land use maps, or property maps. The goal is to identify properties which can most readily be developed for parking and which have suitable access.

Factors influencing site selection and design of a park and ride facility include:

- Local transit authority master plan.
- Regional transportation plan.
- Local public input.
- Need.
- Traffic.
- Commuter distance.
- Local government zoning.

- Economic, social, and environmental impacts.
- Cost and cost effectiveness.
- Access by all modes of travel.
- Security and appearance.
- Maintenance.
- Available utilities.
- Existing right of way or sundry site.
- Capability for future expansion.

Purchasing or leasing property increases costs substantially. Therefore, state-owned right of way should be the first choice, assuming the other selection criteria are favorable. The use of city or county-owned right of way should also receive prime consideration. The site selected should not jeopardize the present and future integrity of the highway facility.

Each potential site should be further investigated in the field. The field survey serves to confirm or revise impressions gained from the office review. Consider the following when making the review:

- Physical characteristics of the site.
- Current use of surrounding area (zoning).
- Whether the site is visible from adjacent street(s) to enhance security and surveillance of the facility.
- Potential for additional expansion.
- Accessibility for motorists and other modes of travel including transit.
- Proximity of any existing parking facilities, such as church or shopping center parking lots, that are underutilized during the day.
- Potential for joint use of facilities with businesses or land uses compatible with park and ride patrons, such as day care centers or dry cleaners.
- Congestion problems and other design considerations.

After establishing the best potential sites, public meetings and environmental procedures should be completed prior to preparing the design report. Follow environmental procedures as outlined in Chapter 220.

The design report should address the public meetings and environmental processes completed, as well as the preferred and alternate sites considered.

## **(3) Design**

A design report (Chapter 330) is required for all federally funded projects and for WSDOT facilities that are to be paved.

Design features must be in compliance with applicable design standards, specifications, and operating procedures and with any local requirements that may apply. In some cases, variances to local design standards may be necessary to ensure the safety and security of facility users.

Design components may include:

- Geometric design of access points.
- Internal and external circulation.
- Parking space layout.
- Pavements.
- Shelters.
- Exclusive High Occupancy Vehicle (HOV) facilities.
- Bicycle facilities.
- Motorcycle facilities.
- Traffic control devices, including signs, signals, and permanent markings.
- Illumination.
- Drainage and erosion control.
- Security of facility users and vehicles.
- Environmental mitigation.
- Landscape preservation and development.
- Restroom facilities.
- Telephone booths.
- Trash receptacles.
- Traffic data.
- Barrier free design for the disabled.

The degree to which the desirable attributes of any component are sacrificed to obtain the benefits of another component can only be dealt with on a site specific basis. However, these guidelines present the optimum requirements of each factor.

Large park and ride lots use private automobiles as the primary collector distributor mode and transit buses as the line haul mode. The basic principles are also used in designing smaller park and ride lots used primarily for carpools and vanpools with limited or no bus service.

**(a) Access.** Six basic transportation modes are used to arrive at and depart from park and ride lots: walking, bicycle, motorcycle, private automobile including carpools, vanpools, and bus. All these modes should be provided for.

Access to a park and ride lot should not increase congestion on the facility it serves. For this reason, direct access by private automobiles to a freeway or ramp should be avoided. However, direct access for transit is often desirable as long as this access does not add a major conflict point. Often the most efficient access point to a park and ride lot will be on an intersecting collector or local street. If the intersection is already signalized, excellent access can often be provided. Entrances and exits should be located with regard to adjacent intersections, so that signal control at these intersections can be reasonably installed at a later time, if necessary. Storage for vehicles entering the lot and adequate storage for exiting vehicles should be planned. Ease of access will encourage use of the facility.

When it is necessary to provide direct access to an arterial, the location must be carefully considered. It should be located to avoid queues from nearby intersections. Field observation of traffic patterns and queuing at the site is recommended prior to establishing an access point.

The facility should be located to allow the most users possible to make a right turn into the lot, thus reducing the hazard of crossing opposing traffic.

Entrances and exits should be at least 150 feet apart and not closer than 150 feet to a public intersection, all measured curb to curb (minimum standard); 350 feet is desirable. Where the capacity of the parking area does not exceed 150 stalls, the above spacings may be reduced to 100 feet.

Park and ride lots located along one-way couplets should be located between the two one-way streets with access from both streets. When access cannot be provided directly to both streets, it may be necessary to provide additional signing to guide users to and from the facility.

When a park and ride lot has more than 300 parking stalls, at least two entrances and two exits should be provided. The volume per entrance or exit should not exceed 300 vehicles per hour. With lot sizes larger than 500 stalls, two lane exits with traffic signals should be considered for exits onto heavy volume two-way streets. It is desirable for park and ride lots with capacities greater than 1,000 parking stalls to have entrance and exit points to two or more adjacent streets in order to avoid congestion. Entrances should be located so that a vehicle approaching the site from any direction could miss one entrance and find a second one without circuitous routing.

Entrances and exits that will be used by buses should have a minimum width of 15 feet per lane. See Section 1060.08 for corner radii requirements for buses. See Chapter 920 and the standard plans for design of other access points.

All entrances and exits should conform to WSDOT design standards or other published design standards used by the local agency.

The transit route from the freeway or arterial to a park and ride lot, circulation patterns within the lot, and return route should be designed to minimize transit travel time. Exclusive ramp connections for buses and vanpools, both to and from the freeway or street, may be justified by time savings to riders and reduced transit costs. All transit routing should be coordinated with the transit authority.

**(b) Internal Circulation.** Major circulation routes within a park and ride lot should be located at the periphery of the parking area to minimize vehicle-pedestrian conflicts. Circulation within the lot should

accommodate all modes using that part of the facility. Care should be taken to see that an internal intersection is not placed too close to a street intersection. A separate loading area, with priority parking areas, should be considered for vanpools. Whenever possible, buses should not be mixed with cars. Bus circulation routes should be designed to provide for easy movement, with efficient terminal operations and convenient passenger transfers. A one-way roadway with two lanes to permit passing of stopped buses is desirable, with enough curb length and/or saw-tooth type loading areas to handle the number of buses that will be using the facility under peak conditions (see Section 1060.04). Close coordination with the local transit authority is critical in the design of internal circulation for buses and vanpools.

The passenger waiting area should be located either:

1. In a central location with parking for the various user modes surrounding the waiting area, or
2. Located near the end of the facility with parking for the various user modes extending radially from the waiting area.

Large lots may require more than one waiting area.

In shared-type lots, such as shopping centers and churches, the waiting area should be located away from main building(s) so pedestrian and vehicle traffic from the lot will not interfere with the other facility activities.

In an undersized or odd-shaped lot, circulation may have to be compromised in order to maximize utilization of the lot. The general design for the individual user modes should be based on the priority sequence of pedestrians, bicycles, feeder buses, and park and ride area. Traffic circulation should be designed to minimize vehicular travel distances, conflicting movements, and number of turns. Vehicular movements within the parking area should be dispersed by strategic location of entrances, exits, and aisles. Aisles should be aligned to facilitate convenient pedestrian movement toward the bus loading zone.

Any of the internal layout that will be used by buses, including entrance and exit driveways, must be designed to the turning radius of the bus. Additional considerations for internal circulation are:

- All users (auto, pedestrian, bicycle, and bus) should be able to understand how the lot works.
- Drivers should not be confronted with more than one decision at a time.
- Adequate capacity should be provided at entrances and exits.
- Signing should be clear.
- Flexibility to adjust to changes in transit volume and operations should be provided.

- (c) **Stall Size.** Internal circulation should be two-way with 90-degree parking. However, due to geometrics of smaller lots, one-way aisles with angled parking may be advantageous. Automobile stall dimensions should be 8.5 feet x 18 feet. When space for vehicle overhang is provided, some of the stalls may be 8.5 feet x 16 feet when parking at 90 degrees. When justified, some of the stalls may be designed for compact cars, 8 feet x 16 feet minimum. Include justification of the percentage of compact stalls.

For additionally information on parking stall size requirements for the disabled, see Section 1060.09.

If possible, aisle lengths should not exceed 400 feet. The greatest efficiency can generally be obtained by placing aisles and rows of parking parallel to the long dimension of the site. All parking should be head-in only. Vehicles and other objects should be excluded from corners where it is necessary to provide adequate intersection sight distances. It is also desirable to have parking on both sides of the aisle. This provides the most efficient design in terms of land use.

- (d) **Pedestrian Movement.** Pedestrian movement in parking areas is normally by way of the aisles. Additional provision for pedestrian movement by means of walkways is desirable and could be required in certain situations, as described below. A pedestrian path from any parking stall to the loading zone should be as direct as possible.

Pedestrian walkways should be provided to minimize pedestrian use of a circulation road or an aisle, and to minimize the number of points at which pedestrians cross a circulation road. Where pedestrians originate from an outlying part of a large parking lot and use aisles or circulation roads to approach the loading zone, they will have to travel along an irregular path for a considerable distance. In such cases, consideration should be given to the provision of a walkway which extends toward the loading zone in a straight line.

The maximum distance a pedestrian will have to walk from his car to a loading zone should be in the range of 600 to 800 feet. Longer walking distances require consideration of centrally located or additional loading zones.

Pedestrian crossings should have good visibility both for pedestrians and drivers. Pedestrian walkways and crossings shall be clearly marked.

Facilities for disabled patrons must also be included. All pedestrian walkways shall have curb cuts, built in accordance with the Standard Plans, at all curbs or other sudden elevation changes. The sidewalk grade should be 12:1 or less. For additional disabled accessibility information, see Section 1060.09.

Sidewalks intended for use by pedestrians should have a minimum width of 5 feet. When it is anticipated that both pedestrians and bicycles will use the sidewalks, the minimum width is 8 feet. They should be compatible with existing sidewalks in the area and follow local codes.

The minimum width of a sidewalk adjacent to a loading zone should be 12 feet or the adjacent sidewalk width plus 7 feet, whichever is greater. Pedestrian barriers should be provided where unusual hazards or unreasonable interference with vehicular traffic would result. The barriers may be railings, berms, fencing, walls, or landscaping. These barriers should be installed with sight distance in mind. Minimum horizontal clearance between a barrier and vehicle should be 2 feet. A good parking lot design will minimize the need for pedestrian barriers.

- (e) **Bicycle Facilities.** Encouraging the bicycle commuter is important. Each bicycle used to commute to the park and ride lot potentially frees up one parking space. An evaluation should be made to determine if the lot is going to be used by bicyclists and, if bicycles are expected, bicycle lockers or locking racks should be provided. All paved lots that are accessible by bicycle and are served by public transit should have lockers or a rack for a minimum of three bicycles. The bike parking area should be located relatively close to the transit loading area, separated from motor vehicles by curbing or other physical barriers, and have a direct route from the feeding streets. The bicycle parking area should be designed to prevent pedestrians from inadvertently walking into it and tripping. For bicycles, the layout normally consists of stalls 2 feet x 6 feet, at 90 degrees to aisles, with a minimum aisle width of 5 feet. For additional information on bicycle facilities, see Chapter 1020.
- (f) **Motorcycle Facilities.** Motorcycle stalls should be 4 feet x 7 feet. Motorcycle storage should be on a Portland cement concrete slab to prevent stands from sinking into the asphalt pavement. Motorcycle stalls should be located relatively close to the transit loading areas.
- (g) **Drainage.** Ponding of water in a lot is undesirable both for vehicles and pedestrians. Therefore, adequate slope should be provided for surface drainage. This is particularly true in cold climates where freezing may create icy spots. Recommended grade is 2 percent (0.02 ft/ft). Curb, gutter, and surface drains and grates should be installed where needed. Drainage grates with short, narrow openings, placed perpendicular to traffic direction, should be used in traffic areas to allow safe passage over the grate. Drainage design should be coordinated with the local agency to ensure that appropriate codes are followed (Chapter 1210).

Raised islands shall be held to a minimum so as not to hinder cleaning and snow removal.

- (h) **Pavement Design.** Pavement design shall conform to state design specification for each of the different uses and loadings that a particular portion of a lot or roadway is expected to handle. The surfacing type shall have the concurrence of the Materials Laboratory (Chapter 520).
- (i) **Traffic Control.** Control of traffic movement can be greatly improved by proper pavement markings. Typically, reflectorized markings for center lines, lane lines, channelizing lines, and lane arrows will be necessary to guide or separate patron traffic and transit traffic. Signing and pavement markings shall conform to Chapters 820 and 830 and to the MUTCD. Park and Ride identification signs should be installed.
- (j) **Shelters.** Pedestrian shelters should be considered in areas where the magnitude of transit service and environmental conditions warrant. Consider shelters when 50 or more riders per day are anticipated. Shelters may be individually designed or selected from a variety of commercially available designs to satisfy local needs. The following features should be considered in selecting shelter designs:
  - Select open locations with good visibility to minimize potential for criminal activity.
  - If enclosed, the open side should be away from nearby vehicle splashing.
  - Doors are not recommended, unless need dictates otherwise, because of maintenance and vandalism potential.
  - Allow for a small air space below side panels to permit air circulation and prevent the collection of debris.
  - Optional features that may be provided are lighting, heat, telephone, travel information (schedules), and trash receptacles.
  - Ease of field assembly and repair of components. Contact WSDOT's Architecture Office or local transit agency for shelter designs. Shelters are usually provided by the serving transit authority with the state providing only the shelter pad. Coordination with the local transit authority is essential in shelter design and placement.
  - Design shelters to accommodate the disabled.
  - See Section 1060.06, Passenger Amenities, for additional information on this subject.
- (k) **Illumination.** Adequate lighting is important from a safety standpoint and as a deterrent to criminal activity in both the parking area and the shelters. Illumination should be considered for all park and ride lots (Chapter 840). Only security lighting is provided during hours of low usage. Locate poles so that vehicle movements and parking are not obstructed. If

raised islands are used to separate adjacent parking rows, place the poles on the islands. In determining the locations of luminaire poles, plan for future expansion of the facility.

**(l) Landscape Preservation and Development.**

Selective preservation of existing vegetation is often a cost-effective means to provide a balanced environment for the park and ride lot user. Preservation may reduce environmental impacts and give “instant” results. Landscaping of park and ride lots is desirable for aesthetic as well as ecological reasons and should consist of plantings that will be compatible with the operation of the facility. Landscaping shall be cost-effective, comply with the local requirements, and satisfy the functional needs of the park and ride lot. The type of plantings and their placements should not interfere with:

- Adequate lighting for the area, thus resulting in a potential safety hazard to the patron.
- Adequate sight distance for cars and transit vehicles, especially at intersections and pedestrian crossings.
- The proper placement of the traffic control devices.
- The ability of pedestrians, bicyclists, and the disabled to use the facility.
- Security of patrons and their property.

Trees provide shade and visual interest, reduce glare, and are less costly to maintain than shrubs and ground cover. Therefore, trees should be the dominant plant material. Trees should be placed only where they will not block sight distance for cars or buses and proper clearances can be maintained as they mature. Landscaping should be designed in such a manner that hiding places for vandals are minimized. Landscaping can provide an effective means for establishing pedestrian paths and walking patterns within the site. In parking zones, sufficient setback must be provided for all plants so the front or rear overhang of cars does not damage them. Earth forms, such as berms, mounds, and swales are a good design tool to provide for low-cost screening, delineation, visual interest, and drainage. Landscaping should be designed so that security patrols can see into the lot from adjacent streets without entering. Landscape design shall keep maintenance requirements to a minimum.

It is desirable that one tree be planted per 12 parking stalls so that no parking stall is farther than 75 feet from a tree. These trees provide luminaire light diffusion for adjacent property owners.

Irrigation also needs to be addressed in the landscape design.

**(m) Fencing.** See Chapter 1460 for guidelines for fencing.

**(n) Maintenance.** A comprehensive maintenance plan should be developed as per established state policy either as part of a memorandum of understanding with the local authority or for use by state maintenance forces. Maintenance of park and ride lots outside state right of way shall be the responsibility of the local transit authority. It is encouraged that park and ride lots inside state right of way should also be maintained by the local transit authority. Agreements for maintenance by others shall be negotiated during the design phase and documented in the design report (Chapter 330).

Maintenance cost estimates, funding source, and legal responsibilities for accidents and security are to be addressed in the maintenance plan and documented in the design report. The location and type of site (new or existing), and method of performing maintenance, will generally determine the extent of the maintenance program.

The following maintenance activities should be considered:

- Periodic inspection.
- Pavement repair.
- Traffic control devices (signs and pavement markings).
- Lighting.
- Mowing.
- Cleaning of drainage structures.
- Sweeping/trash pickup.
- Landscaping.
- Shelters.
- Snow and ice control.

A sound maintenance program should be established well ahead of the date a park and ride lot is placed into operation.

## **1060.04 TRANSFER/TRANSIT CENTERS**

### **(1) Introduction**

Transfer centers are essentially large bus stops where buses on a number of routes converge to allow riders the opportunity to change buses. Transfer centers are of particular importance in many transit systems, since riders in many areas are served by a “feeder” route; to travel to area destinations not served by the feeder, residents must transfer.

Transit centers are frequently associated with a major activity center. In this case, the activity is beyond simply a transfer between buses but also involves the center as a destination point.

This section provides general design considerations of transfer and transit centers. The development of a particular center requires consideration of such features as

passenger volume, number of buses on site at one time, and local auto and pedestrian traffic levels. These factors will dictate the particular requirements of each center.

## **(2) Bus Berths**

Where several transit routes converge and where buses congregate, multiple bus berths or spaces are sometimes required. Parallel and shallow sawtooth designs are the options available when considering multiple berths.

An important aspect in multiple bus berthing is proper signing and marking for the bus bays. Each bay should clearly delineate the route served. In addition, the pavement should be marked with striping to indicate correct stopping positions.

Consideration should be given to using Portland Cement Concrete Pavement where pedestrians will walk for ease of cleaning.

Where buses are equipped with a bicycle rack, the design should provide for loading and unloading of bicycles.

Figure 1060-1 shows typical parallel and sawtooth designs for parking standard 40-foot buses for loading and unloading passengers at a transfer center. The sawtooth design does not require buses to arrive or depart in any order. The parallel design shown requires that the buses either arrive or depart in order.

Where space is a consideration, the sawtooth design can be used for independent arrival but dependent departure. Figure 1060-2 is an example of a sawtooth transit center. In an in-line berthing design, space requirements are excessive if this same access is to be provided. More commonly, in an in-line design, buses pull into the forward-most available berth. Buses must then leave in the order of arrival. The local transit authority should be involved throughout the design process and must concur with the final design.

In the design of parallel bus berths, additional roadway width is required for swing-out maneuvers if shorter bus loading platforms are utilized. The roadway width and amount of lineal space at the bus loading platform are directly related where designs allow departing buses to pull out from the platform around a standing bus. For example, a 40-foot bus with a 16-foot forward clearance requires 22 feet of roadway width for its pull-out maneuver. This condition requires a roadway width of at least 24 feet and a total minimum berth length of 56 feet for each bus. Thus, five buses would require 264 feet of linear distance. The shorter the berth length allowed, the wider the roadway must be.

Considerable linear space is necessary in a parallel design to permit a bus to overtake and pull into a platform ahead of a parked bus. For example, a 40-foot bus requires approximately 92 feet to pull in, assuming the rear end of

the bus is 1 foot out from the platform curb and 56 feet when a 5-foot “tailout” is permitted.

Parallel designs, even if signed properly, require strict parking enforcement, since they give the appearance of general curbside parking areas. Pavement marking is most critical for parallel design. Sawtooth designs offer the advantage of appearing more like a formal transit facility, which tends to discourage unauthorized parking.

## **(3) Flow/Movement Alternatives**

Two primary alternatives for vehicle and passenger movement are possible for transfer centers, regardless of the type of bus berths used. As shown in Figure 1060-3, all buses may line up along one side of the transfer center. This type of arrangement is generally only suitable for a limited number of buses, due to walking distances required for transferring passengers. For a larger number of buses, an arrangement similar to Figure 1060-4 can minimize transfer time requirements by consolidating the buses in a smaller area.

## **1060.05 BUS STOPS AND PULLOUTS**

### **(1) Introduction**

The bus stop is the point of contact between the passenger and the transit services. The simplest bus stop is a location by the side of the road. The highest quality bus stop is an area that provides passenger amenities such as a bench and protection from the weather.

Bus pullouts allow the transit vehicle to pick up and discharge passengers in an area outside the traveled way. The interference between buses and other traffic can be reduced by providing bus pullouts.

### **(2) Bus Stops Designation and Location**

The location of bus stops should be standardized within the system to avoid undue confusion. However, standardization should not be a substitute for sound judgement whenever conditions render standard practice inappropriate. It is imperative that bus stops be of adequate length and located so that the adverse effect on traffic (including pedestrians) is kept to a minimum.

The following should be considered when locating bus stops:

- Bus stop placement requires the consent of the jurisdiction having authority over the affected right of way and the local transit authority.
- The physical location of any bus zone should be primarily determined by the following considerations: maximizing safety, operational efficiency, minimizing adjacent property impacts, and user destination points.
- Public transportation agencies are typically responsible for maintenance of transit facilities within the public right of way.

These elements are discussed in the following subsections.

The proper spacing for bus stops represents a trade-off between passenger convenience and bus operating speed. Closer spacing reduces passenger walking distance, while longer spacing permits faster and less expensive bus operations. The proper spacing in any specific area depends on the nature and layout of adjoining land uses and the number of passengers expected. Bus stops should be as close as possible to passenger origins and destinations.

If activity along the bus route is uniform, the typical bus stop spacing should be about 1,000 feet. A general minimum spacing should be 500 to 600 feet within the central business district (every 2 to 3 blocks). In this range, stops should be provided where streets intersect or where walkways from the surrounding areas reach the main street. Evaluation of pedestrian walking distances as a design issue in subdivision layout may yield short walking distances to bus stops and encourage transit use.

In suburban areas (mostly single-family housing with pockets of open space and undeveloped land), bus stops should be located approximately every 1,250 feet (four per mile). Stops are generally not provided where residential density drops below four units per acre.

If commercial, residential, or industrial activity along the bus route is not clustered, bus stops need not be located uniformly along routes, but can be sited at the activity nodes. Greater spacings, 1,500 to 2,500 feet (approximately two to four per mile), may be possible in these circumstances.

In order to evaluate a new route and build ridership, placement of bus zones may initially depart from the above guidelines.

### **(3) Bus Stop Placement**

Where traffic volume is low, on-street parking is prohibited, and a stopped bus will not impede traffic, the bus stop may simply be a designated location where the bus can pull up to the curb or to the edge of the roadway. The location will be dictated by patronage, the intersecting bus routes or transfer points, security of the rider, and the need for convenient service.

The specific bus stop location is influenced not only by convenience to patrons, but also by the design characteristics and operational considerations of the highway or street. Bus stops are usually located in the immediate vicinity of intersections. Where blocks are exceptionally long, or where bus patrons are concentrated well removed from intersections, midblock bus stops, along with midblock crosswalks, may be used.

Bus stop capacity of one bus will typically be adequate for up to 30 buses per hour.

Where on-street auto parking is permitted, a designated area where the bus can pull in, stop, and pull out must be provided. Figure 1060-5 illustrates several types of bus stops.

- Far-side, with a stop located just past an intersection;
- Near-side, with a stop located just prior to an intersection; and
- Mid-block, with a stop located away from any intersections.

In general, a far-side stop is preferred, however, examine each case separately and determine the most suitable location giving consideration to such things as service to patrons, efficiency of transit operations, and traffic operation in general. Near-side and mid-block bus stops may be suitable in certain situations. Bus stops should utilize sites which discourage unsafe pedestrian crossings, offer proximity to activity centers, and satisfy the general spacing requirements discussed previously. Following are descriptions of the advantages and disadvantages of each type of site.

#### **(a) Far-Side Bus Stops. Advantages:**

- Right turns can be accommodated with less conflict.
- A minimum of interference is caused at locations where traffic is heavier on the approach side of the intersection.
- Will cause less interference where the cross street is one-way street from left to right.
- Stopped buses do not obstruct sight distance for vehicles entering or crossing from a side street.
- At a signalized intersection, buses can find a gap to enter the traffic stream without interference, except where there are heavy turning movements into the street with the bus route.
- Waiting passengers assemble at less-crowded sections of the sidewalk.
- Buses in the bus stop will not obscure traffic control devices or pedestrian movements at the intersection.

#### **Disadvantages:**

- Intersections may be blocked if other vehicles park illegally in the bus stop, or if the stop is too short for occasional heavy demand.
- Stops on a narrow street or within a traffic lane may block the intersection.

#### **(b) Near-Side Bus Stops. Advantages:**

- A minimum of interference is caused at locations where traffic is heavier on the leaving side than on the approach side of the intersection.
- Will cause less interference where the cross street is one-way from right to left.
- Passengers generally exit the bus close to crosswalk.

- There is less interference with traffic turning into the bus route street from a side street.

Disadvantages:

- Heavy vehicular right turns can cause conflicts, especially where a vehicle makes a right turn from the left of a stopped bus.
- Buses often obscure sight distance stop signs, traffic signals, or other control devices, as well as pedestrians crossing in front of the bus.
- Where the bus stop is too short for occasional heavy demand, the overflow will obstruct the traffic lane.

**(c) Mid-Block Bus Stops.** Advantages:

- Buses cause a minimum of interference with sight distance of both vehicles and pedestrians.
- Stops can be located adjacent to major bus passenger generators.
- Waiting passengers assemble at less-crowded sections of the sidewalk.

Disadvantages:

- Pedestrian jaywalking is more prevalent.
- Patrons from cross streets must walk farther.
- Buses may have difficulty re-entering the flow of traffic.

Some general guidelines for the location of bus stops are:

- At intersections controlled by signals, stop, or yield signs, when transit is critical but traffic and parking are not critical, a near-side stop is preferable.
- At intersections where heavy left or right turns occur, a far-side bus stop should be used. If a far-side bus stop is impractical, the stop should be moved to an adjacent intersection or to a mid-block location in advance of the intersection.
- It is important that the bus stop be clearly marked as a no parking zone with signs and/or curb painting.
- For safety and accessibility, all loading and unloading should be made from the curb, not in the street/traffic lane.
- At intersections where bus routes and heavy traffic movements diverge, a far-side stop can be used to advantage.
- Mid-block stop areas are recommended under the following conditions: (1) where traffic or physical street characteristics prohibit a near or far-side adjacent to an intersection; or (2) where large factories, commercial establishments, or other large bus passenger generators exist. A mid-block stop should be located at the far-side of a pedestrian crosswalk (if one exists) so that standing buses will not block an approaching motorist's view of pedestrians in the crosswalk.

- Sight distance conditions generally favor far-side bus stops, especially at unsignalized intersections. A driver approaching a cross street on the through lanes can see any vehicles approaching from the right. With near-side stops the view to the right may be blocked by a stopped bus. Where the intersection is signalized, the bus may block the view of one of the signal heads.
- For security purposes the availability of adequate off-street lighting is an important consideration.

**(4) Bus Pullouts**

Bus pullouts are generally most appropriate when one or more of the following situations exists:

- Traffic in the curb lane exceeds 250 vehicles during the peak hour.
- Passenger volume at the stop exceeds 20 boardings an hour.
- Traffic speed is greater than 45 miles per hour.
- Accident patterns are recurrent.

The separation of transit and passenger vehicles is critical in cases of high bus or traffic volumes or high speeds. Bus stops in the travel lane may be unsafe or impede the free flow of traffic. Bus pullouts should also be considered at locations with high bus passenger loading volumes that cause traffic to back up behind the stopped bus.

To be fully effective, the pullout should incorporate a deceleration lane or taper, adequate staging area for all anticipated buses, and a merging lane or taper. As roadway operating speeds increase, the taper length should increase accordingly. Many times, high traffic volumes will not allow sufficient gaps for the bus operator to return the vehicle safely to the traffic stream. When this happens, the operator may opt not to use the turnout.

Figure 1060-6 illustrates the dimensions and design features of bus pullouts associated with near-side, far-side, and mid-block bus pullouts.

There are no absolute criteria for locating bus pullouts. Where a pullout is being considered, the transit agency must be involved. Factors controlling the appropriate location and eventual success of a pullout include:

- Operating speed.
- Traffic volume.
- Number of passenger boardings.
- Available right of way.
- Roadway geometrics (horizontal and vertical).
- Construction costs.
- Location of curb ramps.

Figure 1060-7 illustrates the dimension and design requirements of far-side bus zones and pullouts where buses will stop after making a right turn. Adherence to these designs should allow safe stopping of buses with minimal interference with legally parked vehicles.



It is important in the design of bus pullouts to consider the need to provide structurally adequate pavement for the bus pullout (Chapter 520), otherwise the surfacing may be damaged by the weight of the buses.

## **1060.06 PASSENGER AMENITIES**

### **(1) Introduction**

Providing an attractive, pleasant setting for the walk and wait are important elements in attracting bus users.

A passenger arriving at a bus stop desires a comfortable place to wait. Important elements of a bus stop are:

- Safety from passing traffic.
- Adequate lighting.
- Security.
- Paved surface.
- Protection from the environment.
- A seat (if the wait may be long).
- Information about the routes serving the stop.

Providing safety from passing traffic involves locating stops where there is adequate space, so passengers can wait away from the edge of the traveled roadway. The buffering distance required from the roadway increases with traffic speed and traffic volume. Three to 5 feet is adequate where vehicle speeds are 30 miles per hour. A heavy volume arterial with speeds of 45 miles per hour can require a distance of 8 to 10 feet for passenger comfort.

Passengers arriving at bus stops, especially infrequent riders, want information and reassurance. Information provided should include the numbers or names of routes serving the stop. Other important information may include a system route map, the hours and days of service, schedules, and a phone number for information. The information provided and format used is typically the responsibility of the local transit system.

At busier stops, including park and ride lots, a public telephone should be provided. For all paved park and ride lots, a desirable site for a public telephone should be selected and conduit provided whether or not a telephone is currently planned. Where shelters are not provided, a bus stop sign and, depending on weather conditions, passenger bench are desirable. The sign indicates to passengers where to wait and can provide some basic route information.

### **(2) Passenger Shelters**

Passenger shelters should provide protection for waiting transit users. In accomplishing this task, the shelter itself must be located conveniently for users without creating hazards — such as blocking the line of sight of automobile drivers or blocking the sidewalk. Figure 1060-8 illustrates a clear sight triangle that will permit shelter siting

with minimal impact on sight distances at urban arterial intersections without traffic controls. The dimensions may vary by local jurisdiction — check local zoning ordinances or with appropriate officials.

State Motor Vehicle Funds cannot be used for design or construction of shelters, except for the concrete pad. Funding of shelters must be handled by the transit agency or some other local agency.

Adequate lighting is necessary to enhance passenger security. Lighting makes the shelter visible to passing traffic and allows waiting passengers to read information provided. General street lighting is usually adequate. Where street lights are not in place, additional street lights or transit shelter lights should be considered.

A properly drained, paved surface is necessary so that passengers will not traverse puddles and mud in wet weather. Protection from the environment is typically provided by a shelter that provides shade from the sun, protection from rain and snow, and a wind break. Shelters can range from simple to elaborate. The latter type may serve as an entrance landmark for a residential development or employment complex and be designed to carry through the architectural theme of the complex. If a nonpublic transportation entity shelter is provided, its design and siting must be approved by the local transit operator. The reasons for this approval requirement include safety, barrier-free design and long-term maintenance concerns.

Simple shelters, such as that illustrated in Figure 1060-9, may be designed and built by the transit agency or purchased from commercial vendors. The WSDOT Architecture Office may be contacted for more complex designs.

If resources permit, shelter placement should be considered at most bus stops in new commercial and office developments and in places where large numbers of elderly and disabled persons may wait, i.e., hospitals, senior centers, etc. In residential areas, shelters are placed only at the highest volume stops.

## **1060.07 ROADWAY AND VEHICLE DESIGN CRITERIA CHARACTERISTICS**

### **(1) Paving Sections**

The pavement design (type and thickness) of a transit benefit project, whether initiated by a public transportation agency or a private entity, must be coordinated with WSDOT or the local agency public works department depending on highway, street, or road jurisdiction. These agencies play a major role in determining the paving section for the particular project. Early and frequent coordination is required.

Paving section design is determined by the volume and type of traffic, design speed, soil characteristics, availability of materials, construction costs, and maintenance cost. Important characteristics of good pavement design are the ability to retain shape and dimensions, the ability to drain, and the ability to maintain adequate skid resistance.

See Chapter 510 “Investigation of Soils and Surfacing Materials” and Chapter 520 “Design of Pavement Structure” for guidance in the design of pavements.

(a) **Grades.** Roadway grades refer to the maximum desirable slope or grade, or the maximum slope based upon the minimum design speed that a standard 40-foot transit bus can negotiate safely. Guidance on roadway grades is in Chapter 440 or in the *Local Agency Guidelines*. Public transportation agencies or private developers should coordinate their needs with WSDOT or the appropriate local agency.

Speed of buses on grades is directly related to the weight/horsepower ratio. Grades should be selected to permit uniform operation at an affordable cost. In cases where the roadway is steep, a climbing lane for buses and trucks may be needed. Abrupt changes in grade should be avoided due to bus overhangs and ground clearance requirements.

(b) **Lane Widths.** Roadway and lane widths are generally regulated by WSDOT or the *Local Agency Guidelines*, based upon the functional class of highway or road under their respective jurisdiction.

Private developers should contact these agencies early in the design process to ensure that roadway and lane widths are consistent with applicable standards.

Roadway capacity is directly affected by lane width. As lanes narrow, anticipated capacity is lowered. Controls determining adequate lane width include design speed, anticipated traffic volume, types of user vehicles, available right of way, and roadside obstructions, i.e., retaining walls, light poles, and street furniture.

For lanes to be used by High Occupancy Vehicles (HOV), buses, vanpools, and carpools, the recommended width is 12 feet. Lane widths should not be less than 12 feet when transit volumes are high. Chapter 1050 provides additional information on HOV facilities.

## (2) Vehicle Characteristics/Specifications

Most transit agencies operate several types of buses within their system. Vehicle sizes range from the articulated bus to passenger vans operated for specialized transportation purposes and vanpooling.

Each manufacturer within each of the general classifications may vary dimensions such as wheelbase, height, and vehicle overhang. The total gross vehicle weight rating

(GVWR) varies considerably among manufacturers for the type of general vehicle classification. Because of these differences, more specific design information should be obtained from the local transit authority.

The principal dimensions affecting design are the minimum turning radius, the tread width, the wheelbase, and the path of the inner rear tire. Effects of driver characteristics and the slip angle of the wheels are minimized by assuming that the speed of the vehicle for the minimum radius (sharpest) turn is less than 10 miles per hour.

(a) **Large Transit Buses.** These traditional urban transit service vehicles are typically 40 feet long and have a wheelbase of approximately 25 feet. Many agencies operate 35-foot buses which have a 19-foot wheelbase.

Many of these vehicles are equipped with either front or rear door wheelchair lifts, or a front “kneeling” feature that reduces the step height for mobility impaired patrons.

(b) **Articulated Transit Bus.** Because articulated buses are hinged between two sections, these vehicles can turn on a relatively short radius. Articulated buses are typically 60 feet in length with a wheelbase of 19 feet from the front axle to mid-axle and 24 feet from the mid-axle to the rear axle.

(c) **Small Transit Buses.** Some of the smaller transit agencies operate 26 to 30-foot transit coaches which are designed for use in low volume situations. Modified vans are used for transportation of the elderly and disabled persons and shuttle services. Passenger vans are a third type of small bus, used for specialized transportation and vanpooling. Some of these vans have been modified to provide special seating arrangements. Since the vehicle specifications vary so widely within this category, consult the local transit authority or bus manufacturer for specifications of the particular vehicle in question.

## 1060.08 INTERSECTION RADII

A fundamental characteristic of transit accessible development is safe, convenient access and circulation for transit vehicles. It is important that radii at intersections be designed to accommodate turning buses. Adequate radii will reduce conflicts between automobiles and buses, reduce bus travel time, and provide maximum comfort for the passengers.

The following major factors should be taken into consideration in designing intersection radii:

- Right of way availability.
- Angle of intersection.
- Width and number of lanes on the intersecting streets.
- Design vehicle turning radius.

- Parking at the intersection.
- Allowable bus encroachment.
- Operating speed and speed reductions.
- Pedestrians.
- Bicycles.

Because of space limitations and generally lower operating speeds in urban areas, curve radii for turning movements may be smaller than those normally used in rural areas. It is assumed that buses making turns are traveling at speeds of less than 10 miles per hour. Figures 1060-10 and 11 illustrate the Turning Templates and design vehicle specifications for a standard 40-foot bus and an articulated bus.

Figure 1060-12 illustrates appropriate radii at intersections for four types of parking configurations which may be associated with an intersection. Radii less than minimum result in encroachment into adjoining lanes or curbs. As intersection radii increase, pedestrian crossing distances increase.

To ensure efficient transit operation on urban streets, it is desirable to provide corner radii of from 35 to 50 feet (based on the presence of curb parking on the streets) for right turns to and from the through lanes. Where there are curb parking lanes on both of the intersecting streets and parking is restricted for some distance from the corner, the extra width provided thereby serves to increase the usable radius.

Angle of intersection also influences the turning path of the design vehicle. Figure 1060-13 shows the effect of the angle of intersection on the turning path of the design vehicle on streets without parking. Figure 1060-13 also illustrates different cases; when a vehicle turns from proper lane and swings wide on the cross street, and when the turning vehicle swings equally wide on both streets.

## 1060.09 DISABLED ACCESSIBILITY

### (1) Introduction

Public transportation providers have an obligation under both state and federal laws to create and operate capital facilities and vehicles that are usable by the wide variety of residents in the service area. A major need arising from this obligation is to provide transportation service to the transit dependent, among whom are disabled individuals.

According to the report titled "Persons of Disability in Washington State — A Statistical Profile 1970-1980" by the Washington State Employment Security Department, the percentage of persons with disabilities within the state in the working age years of 16 to 64 was 8.7 percent in 1980. The number of elderly people with disabilities that affect mobility is far higher.

Federal law requires all new or significantly rehabilitated buses to be accessible to the disabled. Transit agencies

are also required to provide demand response service comparable with the fixed route service.

Barrier-free design means more than just accommodating wheelchairs. Care needs to be given not to create hazards or barriers for people who have vision or hearing impairments. The key is to design clear pathways without obstacles and signs that are simple with large print.

Transit Benefit facilities are designed for accessibility aspects under the Uniform Federal Accessibility Standards (UFAS) and/or, Chapter 51-10 WAC "Washington State Regulations for Barrier-Free Facilities" or local agency standards where applicable.

### (2) Park and Ride Lots

Parking stalls for the disabled should be located in close proximity to the transit loading and unloading area. Stalls shall be at least 8 feet wide with a 5-foot adjacent loading aisle on each side with sidewalk curb cuts (see Standard Plans). Two accessible parking stalls may share a common access aisle. Provide disabled stalls according to the following table:

Total Parking Stalls in Lot	Required Disabled Parking Stalls
1 to 25	1
26 to 50	2
51 to 75	3
76 to 100	4
101 to 150	5
151 to 200	6
201 to 300	7
301 to 400	8
401 to 500	9
501 to 1,000	2% of total
1,001 and over	20 plus 1 for each 100 over 1,000

No more than two of these stalls need be striped and signed for disabled use at the time of initial operation. The remaining stalls may be striped for standard usage, but the curb cuts for wheelchair ramps should be provided for each future stall. Additional stalls shall be made available for use by disabled patrons when demand indicates the need.

A parking stall for disabled persons shall be signed according to the requirements of RCW 46.61.581.

- Disabled facilities should be in accordance with the following:
- Disabled patrons should not have to cross access roads enroute to the bus loading zone.
- Disabled patrons should not be forced to travel behind parked cars (in their circulation path).
- Wheelchair ramps shall be provided to facilitate the movement of physically disabled patrons.

- Parking stalls and access aisles shall be level with surface slopes not exceeding 2 percent.

### **(3) Bus Stops and Shelters**

In order to use buses which are accessible, bus stops must also be accessible to disabled persons. The nature and condition of streets, sidewalks, passenger loading pad, curb ramps, and other bus stop facilities can constitute major obstacles to mobility and accessibility. State, local, public and private agencies need to work closely with public transportation officials to enhance accessibility for people with disabilities. A significant component of bus stop accessibility is in the provision of “pads” for the deployment of wheelchair lifts. The terrain where a wheelchair pad is located should be level. The pad should be constructed of cement concrete, asphalt concrete pavement, or a similar impervious surface. The approach to the pad should not consist of grass, gravel, or any surface where a wheelchair might lose traction. The pad should have a minimum slope toward the curb sufficient for drainage purpose. The stop pad should measure at least 10 feet in length and 8 feet in width. When right of way or other limitations restrict the pad size, a smaller pad may be provided, but it must be able to accommodate a wheelchair.

The local public transit agency should be involved in the pad design to help ensure that lifts can actually be deployed at this site.

In order to access a bus stop, it is important that the path to these facilities also be accessible by the use of sidewalks with curb ramps. The Standard Plans contain design and construction information for cement concrete sidewalks and curb ramps. A continuous curb ramp is used for accessibility of disabled park and ride users as part of the accessible path to the bus stop and shelter.

In the design of bus stops and/or shelters the following should be considered:

- Inclusion of bus stop disabled access as a critical factor in the selection of locations for pedestrian improvements within the safety component of the state’s or local agency capital improvement program.
- Ensure that curb ramps are properly sloped and sized for safe wheelchair usage and that they have textured surfaces to warn blind persons (see the Standard Plans).
- Identification of places that require sidewalks.
- Encouragement that property owners keep existing sidewalks in a good state of repair.
- Encouragement and continued emphasis of standards requiring all new street construction or reconstruction to include sidewalk or pedestrian walkway and curb ramps.

- Bus stop should be identified with curb painting and/or bus stop signs. Both disabled and nondisabled persons will benefit from this.
- All bus stops that can be made accessible should be made accessible, whether or not the paths to them are accessible, as future improvements may make the paths accessible.
- All bus stop signs along a route served by accessible vehicles should be marked with the blue international accessibility symbol conforming to the requirements of RCW 70.92.120 for easier identification by users.
- Existing as well as future park and ride locations must, by state law, include reserved parking for disabled persons, marked with signs as outlined in RCW 46.61.581.

### **1060.10 REFERENCES**

AASHTO, *Guide for the Design of High Occupancy Vehicle and Public Transfer Facilities*, 1983.

*Performance Criteria and Design Standards for Park and Ride Lots*, Metro Guidelines, April 1974.

*An Illustrated Handbook of Barrier Free Design*, Washington State Rules and Regulations, November 1989.

*Uniform Federal Accessibility Standard, Accommodations for the Physically Handicapped*, FHWA, April 1984.

Manual on Uniform Traffic Control Devices for Streets and Highways, (MUTCD), FHWA.

*WSDOT Standard Plans for Road, Bridge, and Municipal Construction (M 21-01)*.

Design Guidelines for Bus Facilities, Orange County Transit District, Garden Grove, California, November 1987.

*A Guide to Land Use and Public Transportation*, Snohomish County Transportation Authority, December 1989.

*Access By Design: Transit’s Role in Land Development*, Mass Transit Administration, Maryland Department of Transportation, September 1988.

*Public Transportation Facilities Design Manual*, Thurston Regional Planning Council, January 1986.

*Bus Use of Highways: Planning and Design Guidelines*, National Cooperative Highway Research Program Report 155, Transportation Research Board, 1975.

*A Policy on Geometric Design of Highways and Streets*, American Association of State Highway and Transportation Officials, 1984.

*A Guide for Transportation Landscape and Environmental Design*, American Association of State Highway and Transportation Officials, 1991.

V:DM10

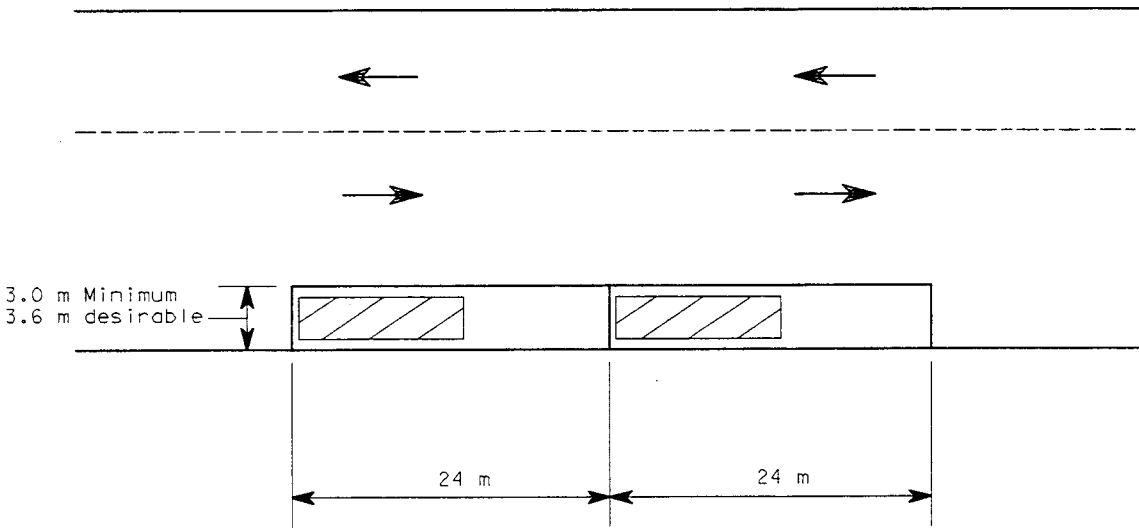

Parallel Design

NOT TO SCALE

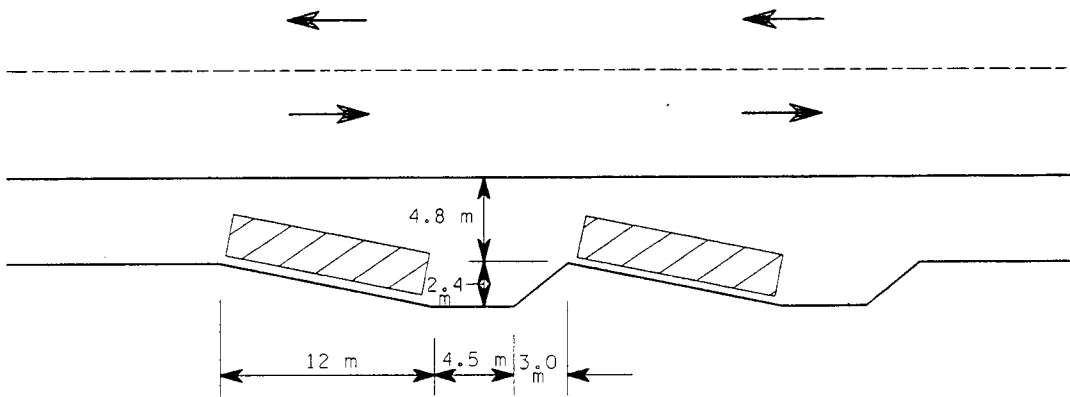
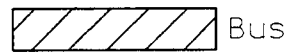

Sawtooth Design

**BUS BERTH DESIGNS**

Figure 1060-1  
(Metric)

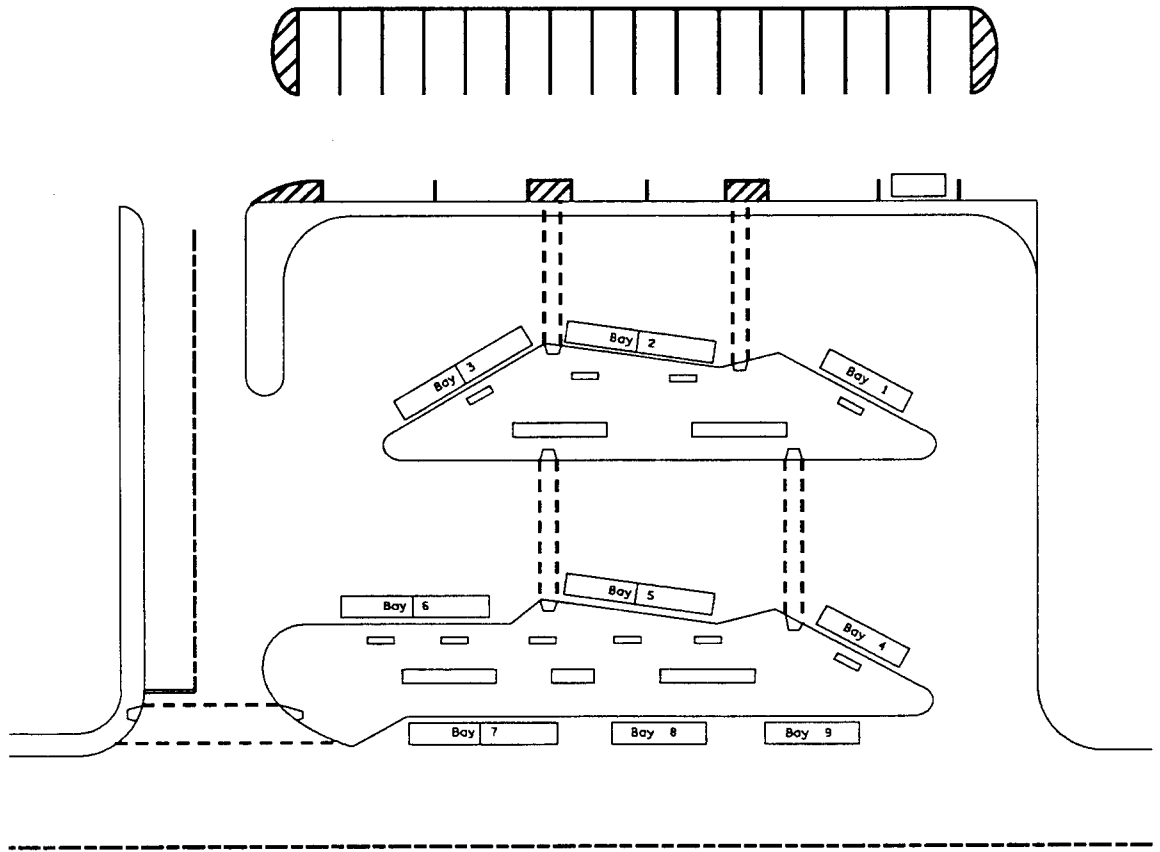

**TRANSIT CENTER  
SAWTOOTH BUS BERTH  
DESIGN EXAMPLE**

Figure 1060-2

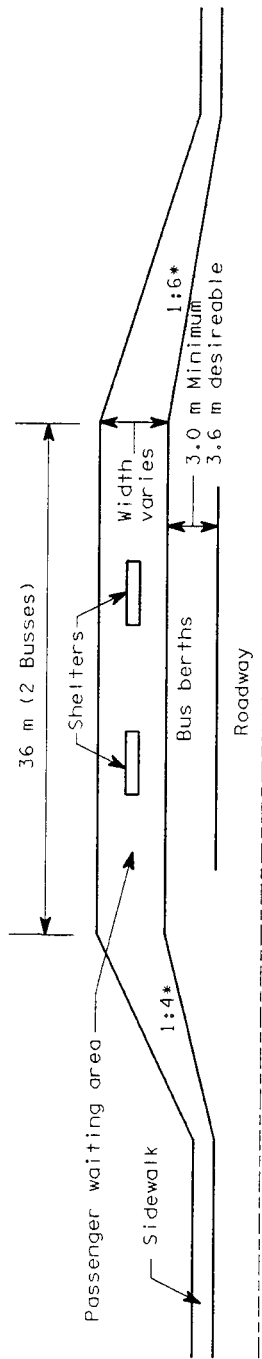

\* On higher speed facilities it may be necessary to provide a greater acceleration/deceleration transition.

**BUS TURNOUT TRANSFER CENTER**

Figure 1060-3  
(Metric)

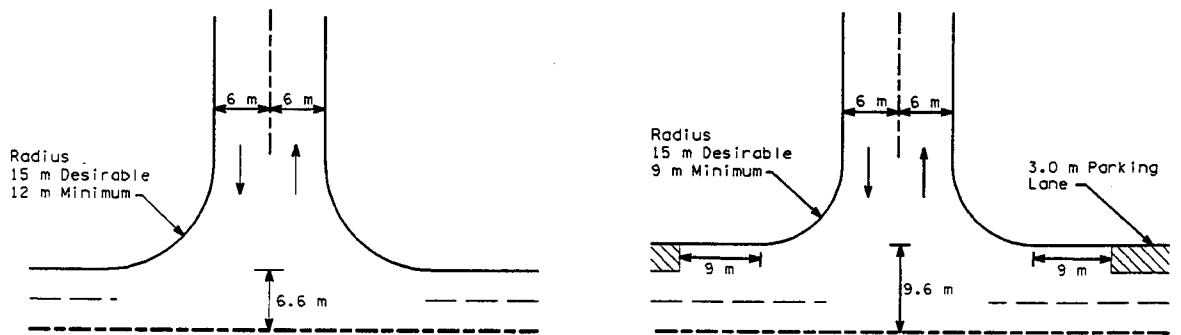
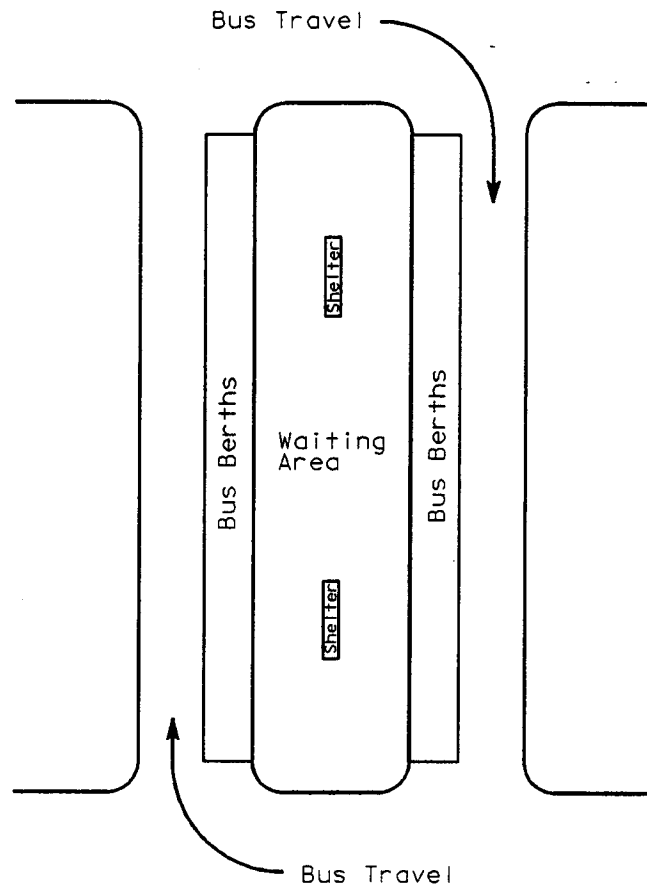



### OFF-STREET TRANSFER CENTER

Figure 1060-4  
(Metric)

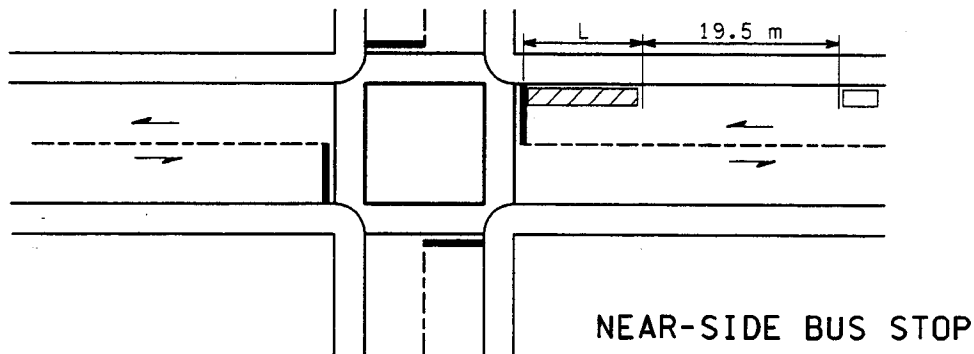
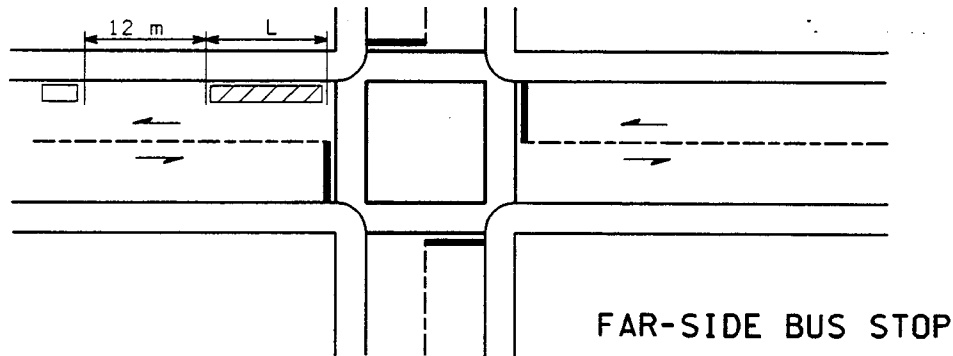

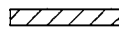

 Bus  
 Parked car

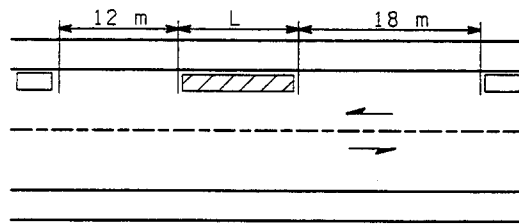

Minimum Lengths for Bus Curb Loading Zones (L)<sup>1</sup>

Approx. Bus Length(L)	Loading Zone Length (meters)					
	One Bus Stop			Two Bus Stops		
	Near Side <sup>2,3</sup>	Far Side <sup>2</sup>	Mid Block	Near Side <sup>2,3</sup>	Far Side <sup>2</sup>	Mid Block
7.5	27	19.5	37.5	36	27	45
9	28.5	21	39	39	30	48
10.5	30	22.5	40.5	42	33	51
12	31.5	24	42	45	36	54
18	37.5	30	48	57	48	66

<sup>1</sup>Based on bus 0.3 m from curb. When bus is 0.15 m from curb, add 6.0 m near side, 4.5 m far side, and 6.0 m midblock. Based on streets 12.0 m wide, add 4.5 m when 10.5 m wide and 9.0 m when 9.6 m wide.

<sup>2</sup>Measured from extension of building line or established stop line. Add 4.5 m where buses make a right turn.

<sup>3</sup>Add 9.0 m where right turn volume is high for other vehicles.

### MINIMUM BUS ZONE DIMENSIONS

Figure 1060-5  
(Metric)

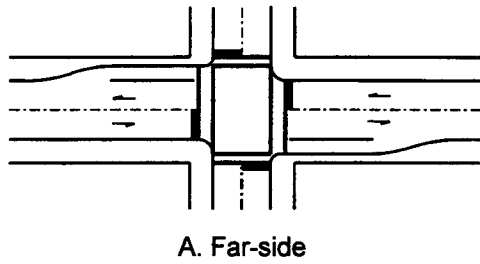

A. Far-side

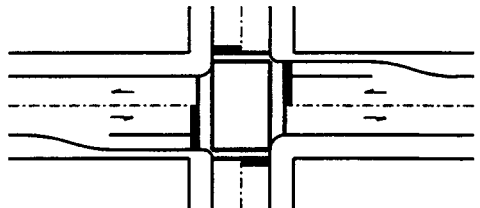

B. Near-side

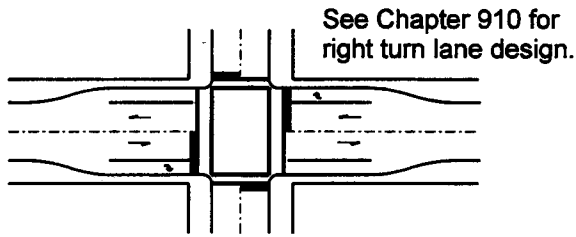

C. Near-side right turn lane and far-side bus bays

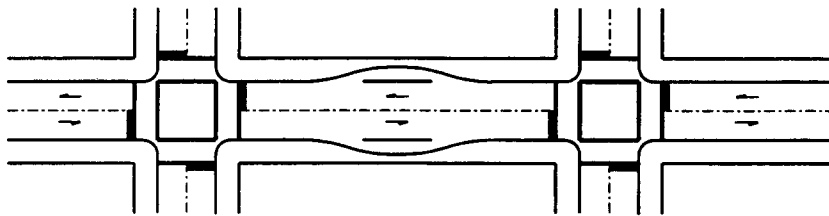

D. Mid-block bus bays

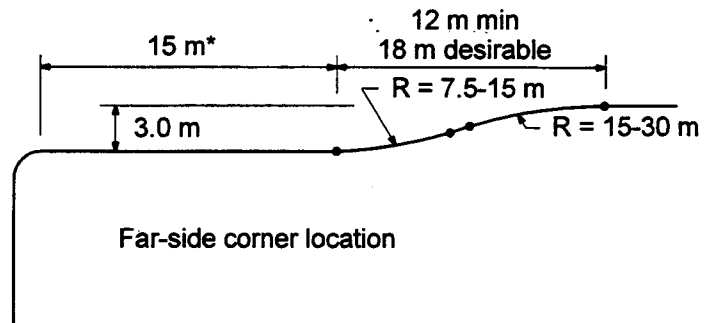

Far-side corner location

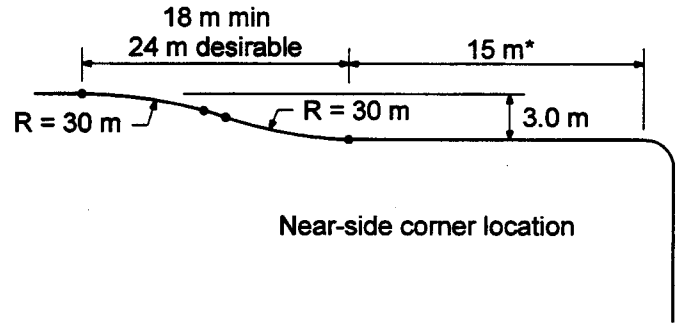

Near-side corner location

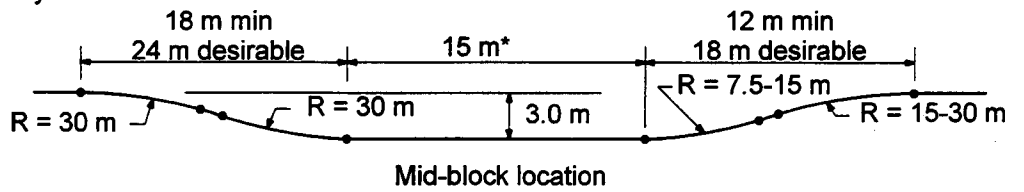

Mid-block location

\* 15 m Bay is for one standard 12 m bus.  
 Add 13.5 m for each additional standard bus.  
 Articulated buses require 21 m bays, with  
 19.5 m for each additional.

### Bus Stop Pullouts, Arterial Streets

Figure 1060-6

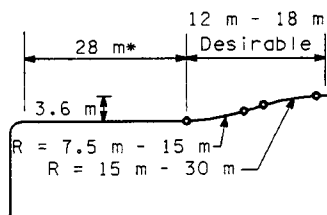
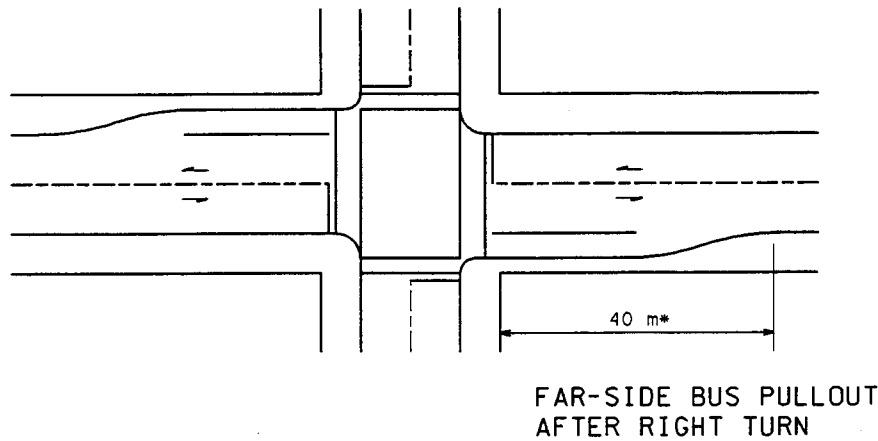
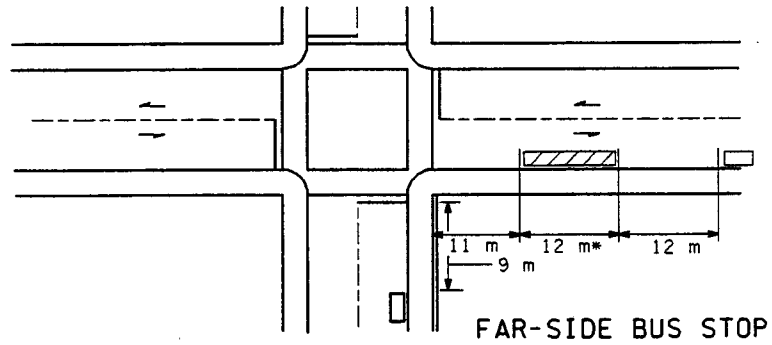

 Bus
  Parked car

\* Based on a standard 12 m bus. Add 6 m for articulated buses.

## MINIMUM BUS ZONE AND PULLOUT AFTER RIGHT TURN DIMENSIONS

Figure 1060-7  
(Metric)

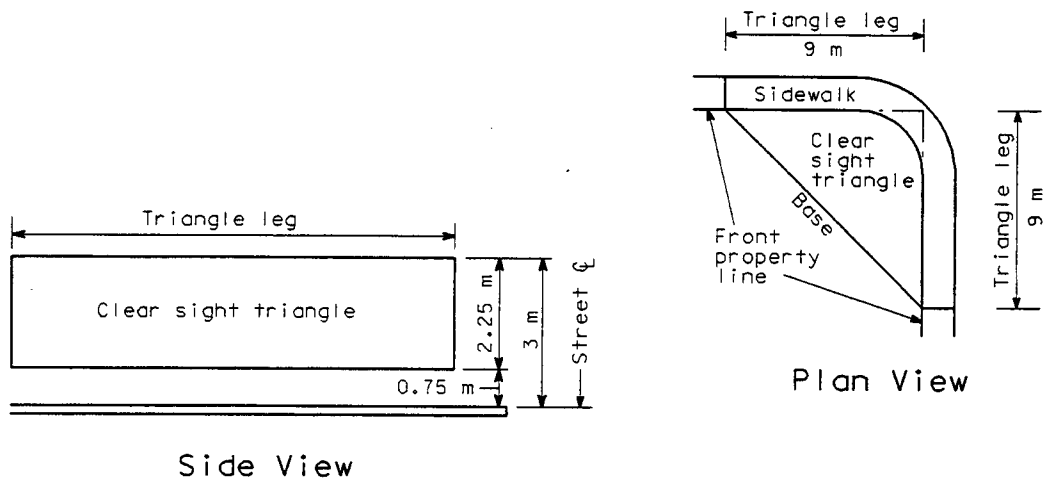
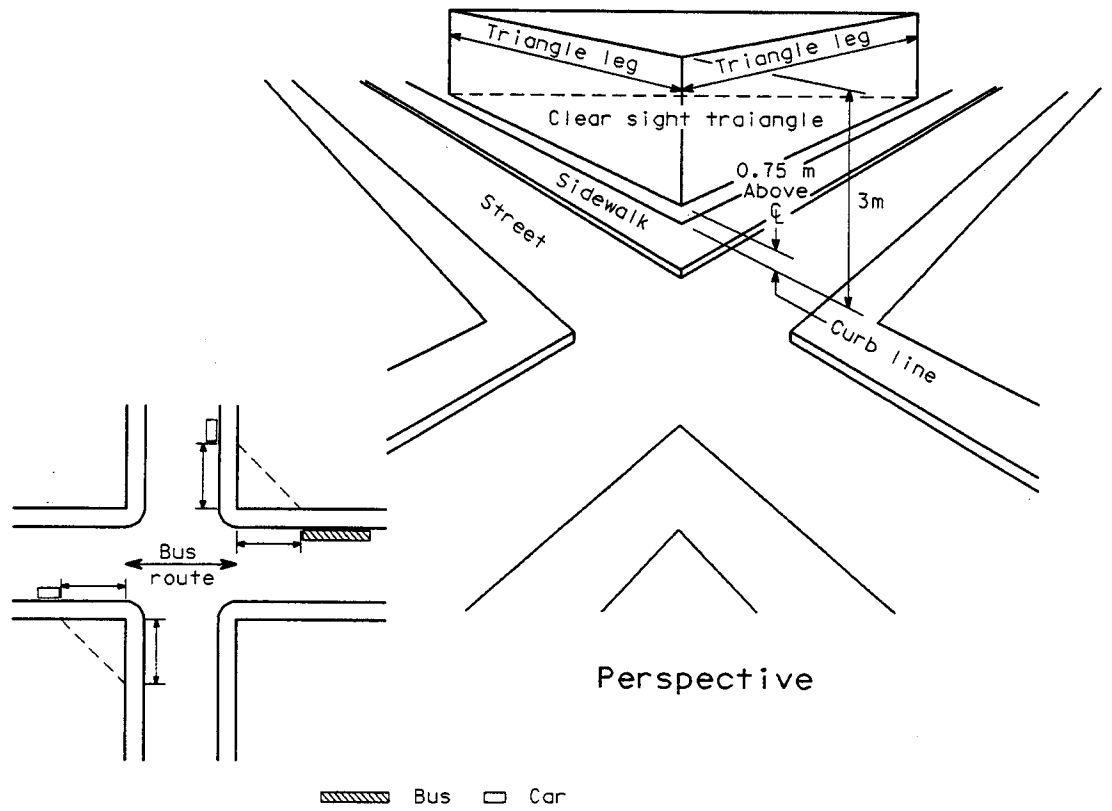

**SHELTER SITING**

Figure 1060-8  
(Metric)

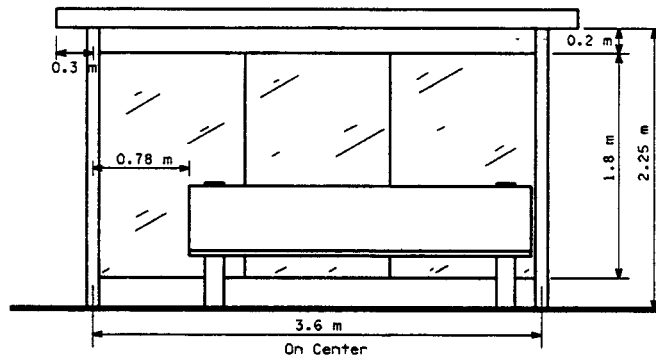

Front View

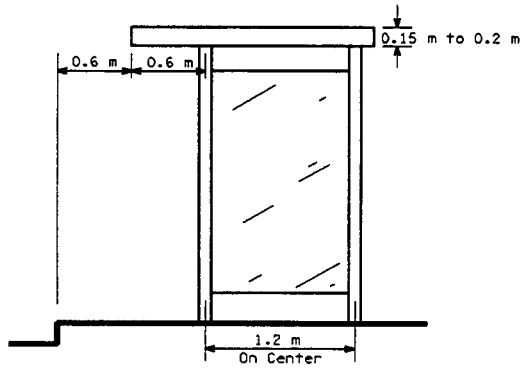

Side View

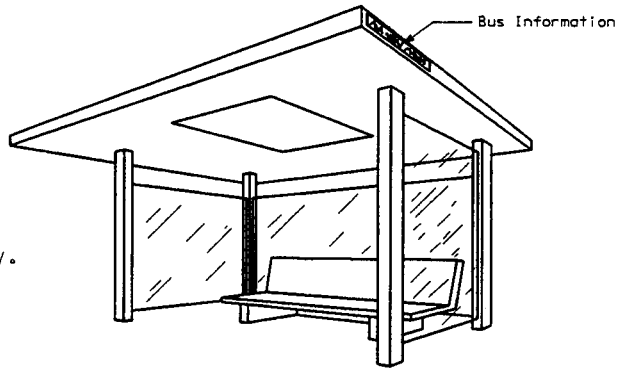

Note: Bench style can vary.

**TYPICAL BUS SHELTER DESIGN**

Figure 1060-9  
(Metric)

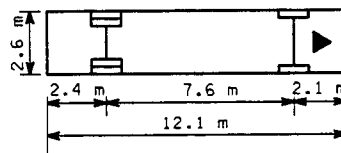
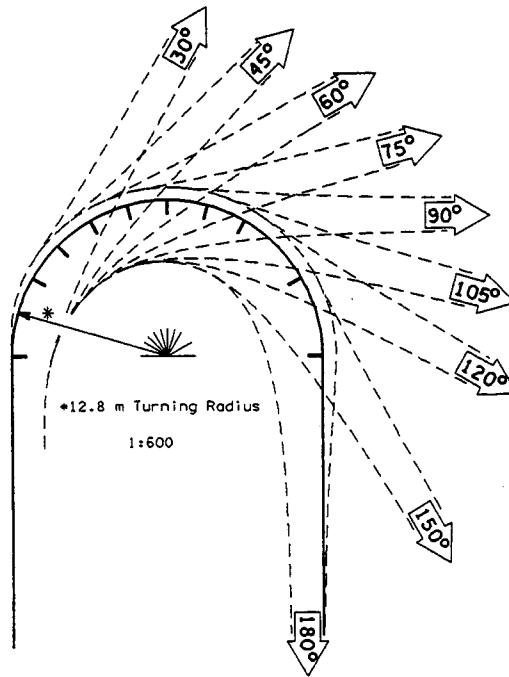

**Design Vehicle Turning Movements**  
**Figure 1060-10**  
**(Metric)**

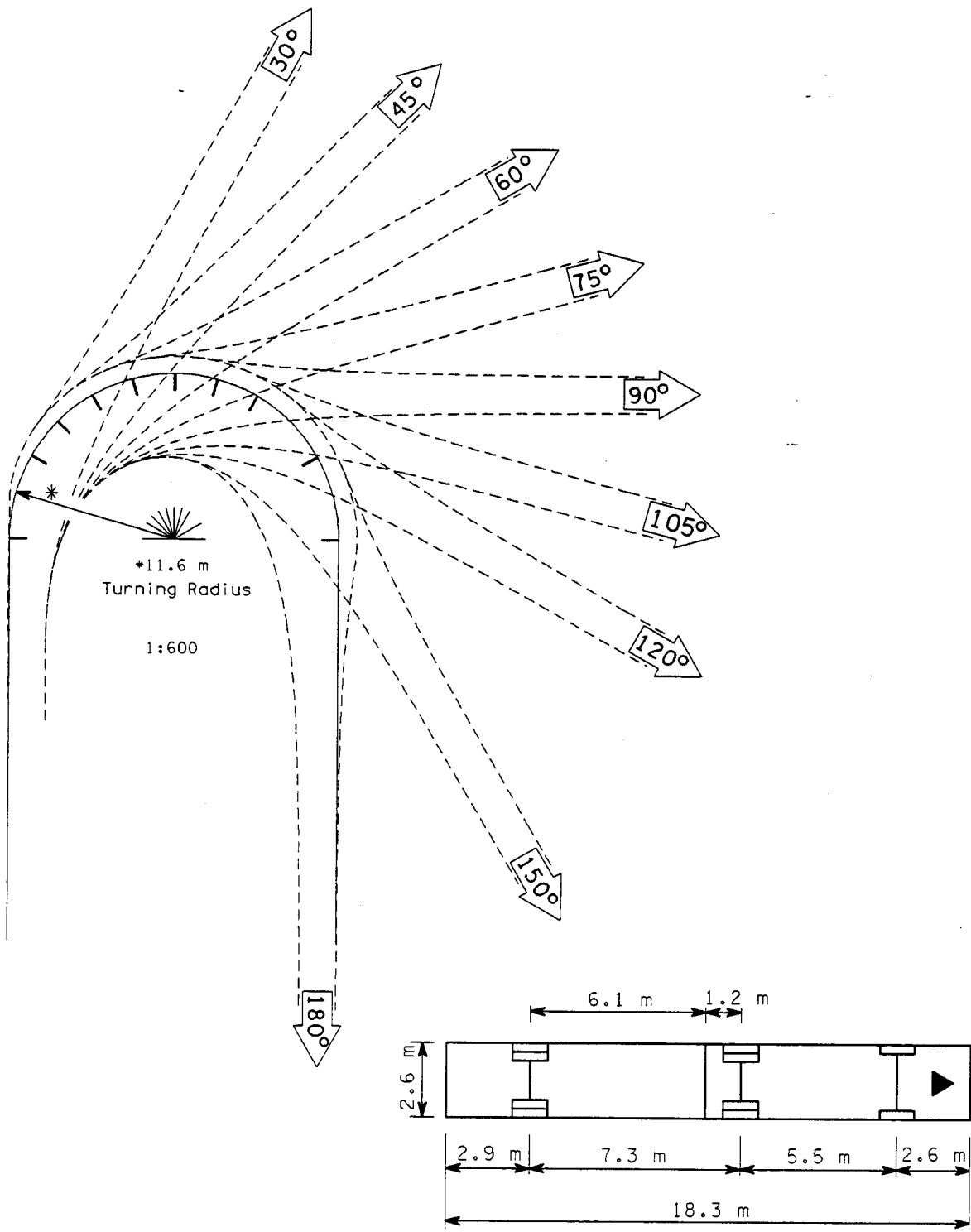

**Turning Template for Articulated Bus**  
 Figure 1060-11  
 (Metric)

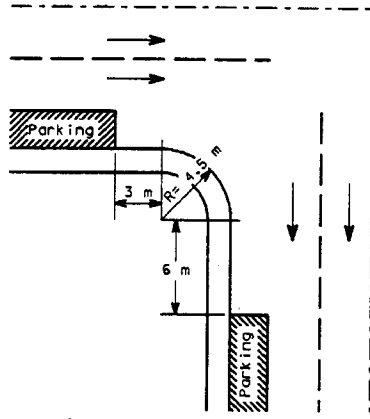

On Street Parking Before and After Turn

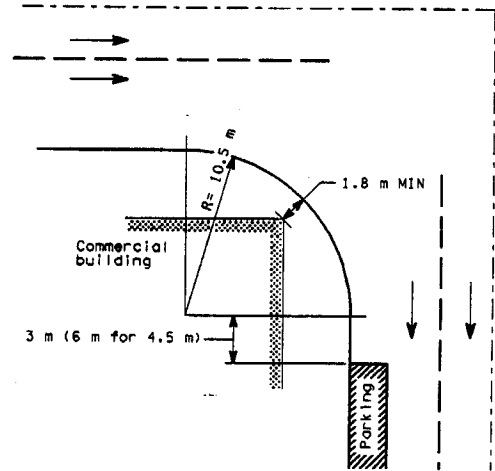

On Street Parking After Turn

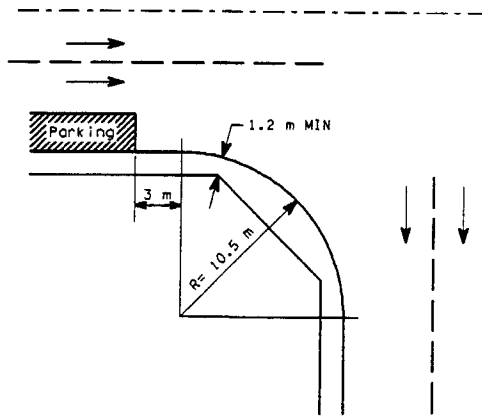

On Street Parking Before Turn

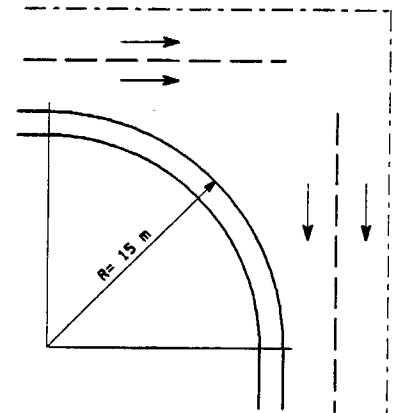

No On Street Parking

## INTERSECTION DESIGN

Figure 1060-12  
(Metric)



Design Vehicle	d (m) for Classes A and B Where:									
	R = 4.5 m		R = 6 m		R = 7.5 m		R = 9 m		R = 12 m	
	A	B	A	B	A	B	A	B	A	B
30°	6.6	5.1	5.7	5.1	5.7	5.1	5.7	5.1	5.4	5.1
60°	8.4	6.3	7.8	6.0	7.2	6.0	6.9	5.7	6.6	5.4
90°	11.4	6.9	9.9	6.6	9.0	6.6	7.5	6.3	6.3	5.4
120°	13.8	8.4	12.0	7.5	9.6	6.9	7.8	5.7	5.7	5.4
150°	14.4	8.4	12.0	7.5	9.6	6.9	6.6	5.4	5.1	4.8

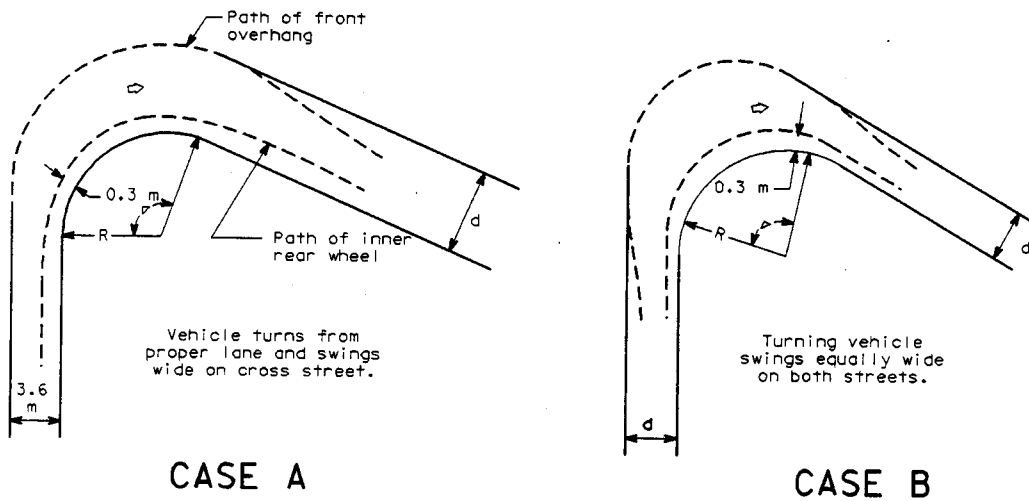

**CROSS-STREET WIDTH OCCUPIED BY TURNING VEHICLE FOR VARIOUS ANGLES OF INTERSECTION AND CURB RADII**

Figure 1060-13  
(Metric)

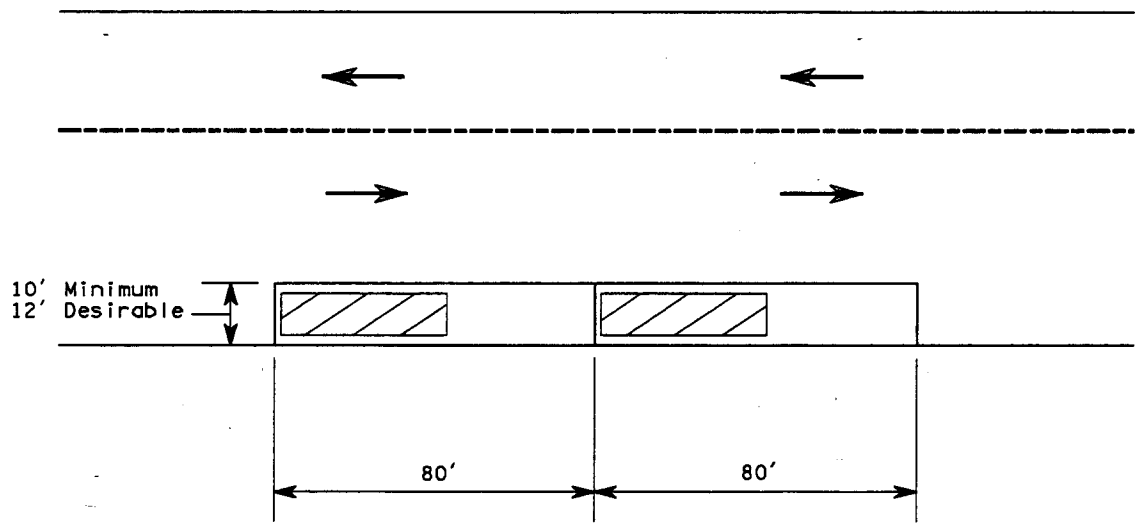

Parallel Design

NOT TO SCALE

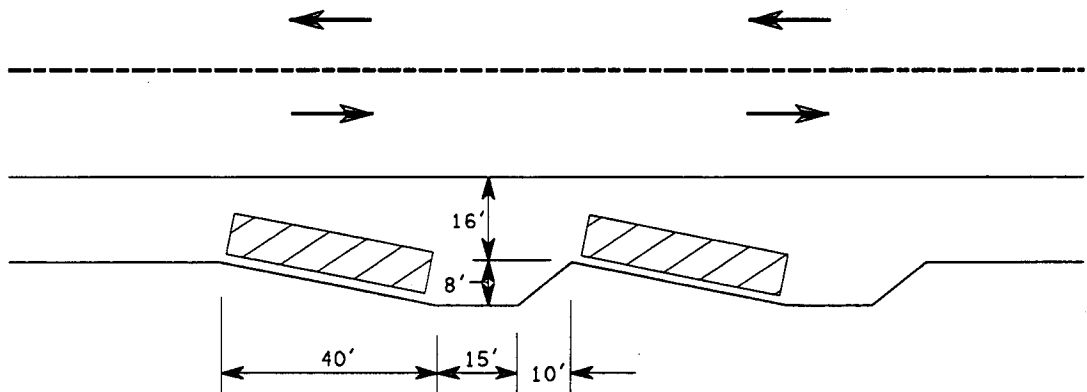

Sawtooth Design

**BUS BERTH DESIGNS**

Figure 1060-1

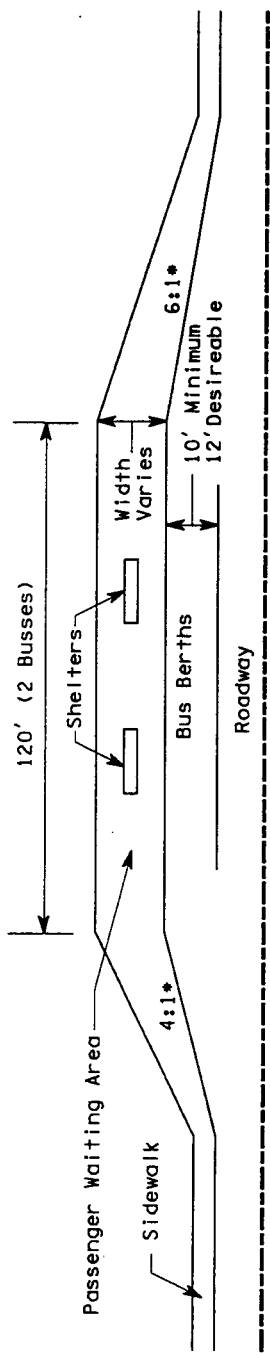

\* On higher speed facilities it may be necessary to provide a greater acceleration/deceleration transition.

**BUS TURNOUT TRANSFER CENTER**

Figure 1060-3

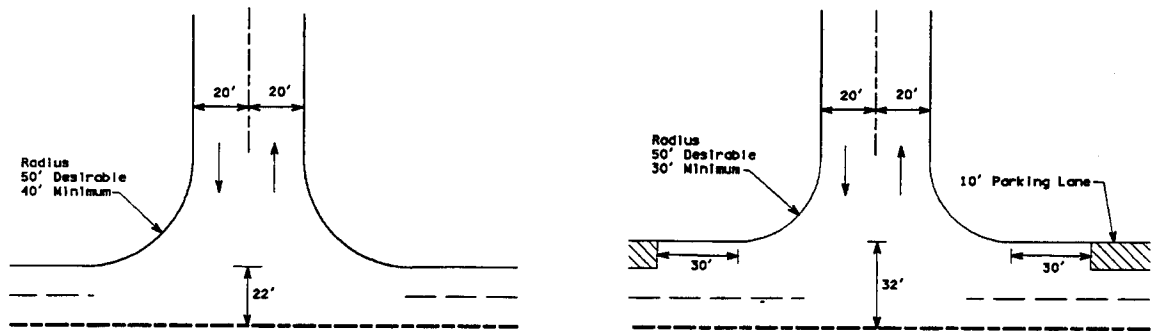
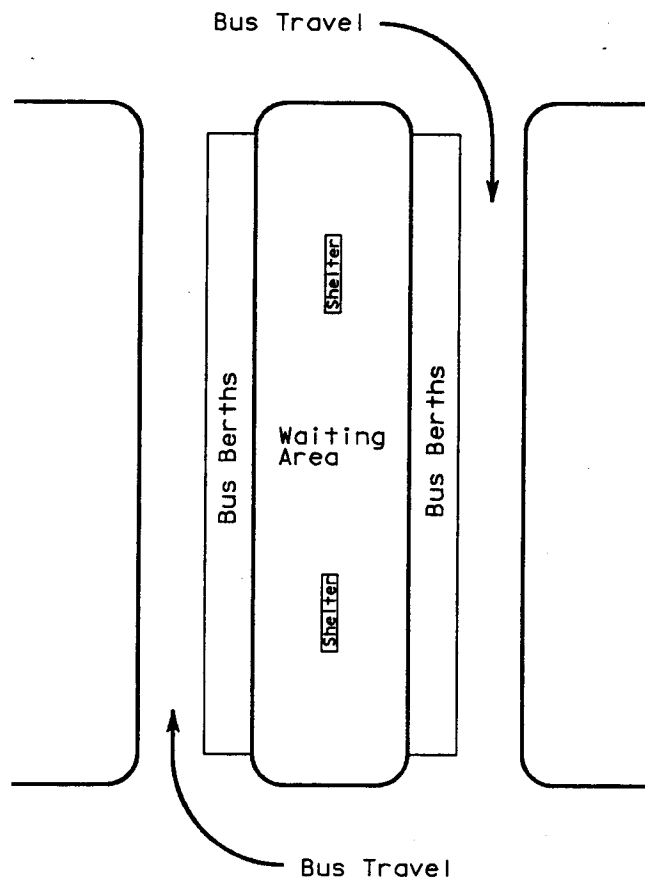

**OFF-STREET TRANSFER CENTER**

Figure 1060-4

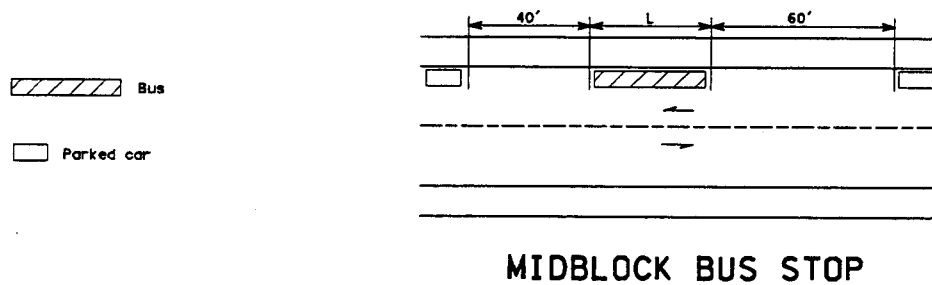
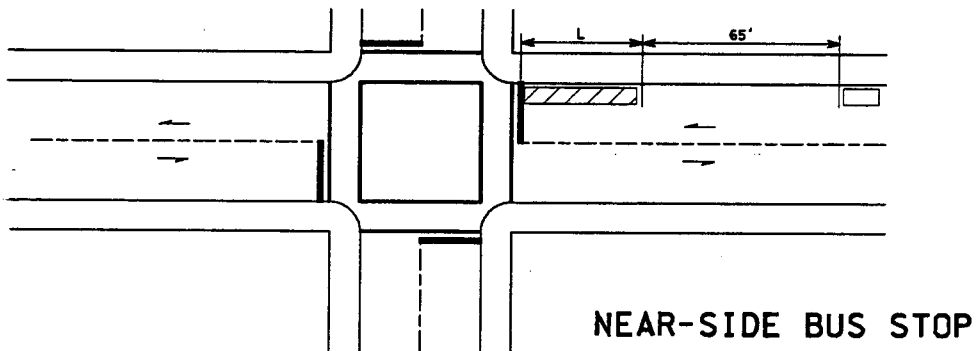
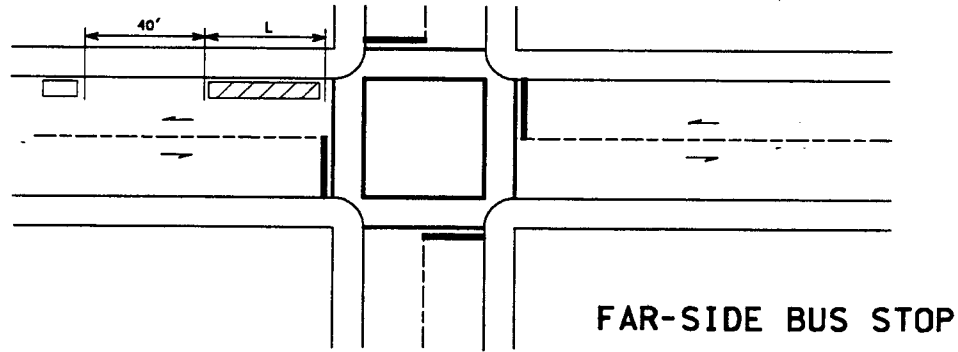

Minimum Lengths for Bus Curb Loading Zones (L)<sup>1</sup>

Approx. Bus Length(L)	Loading Zone Length (feet)					
	One Bus Stop			Two Bus Stops		
	Near Side <sup>2,3</sup>	Far Side <sup>2</sup>	Mid Block	Near Side <sup>2,3</sup>	Far Side <sup>2</sup>	Mid Block
25	90	65	125	120	90	150
30	95	70	130	130	100	160
35	100	75	135	140	110	170
40	105	80	140	150	120	180
60	125	100	160	190	160	220

<sup>1</sup>Based on bus 1 foot from curb. When bus is 0.5 feet from curb, add 20 feet near side, 15 feet far side, and 20 feet midblock. Based on streets 40 feet wide, add 15 feet when 35 feet wide and 30 feet when 32 feet wide.

<sup>2</sup>Measured from extension of building line or established stop line. Add 15 feet where buses make a right turn.

<sup>3</sup>Add 30 feet where right turn volume is high for other vehicles.

**MINIMUM BUS ZONE DIMENSIONS**

Figure 1060-5

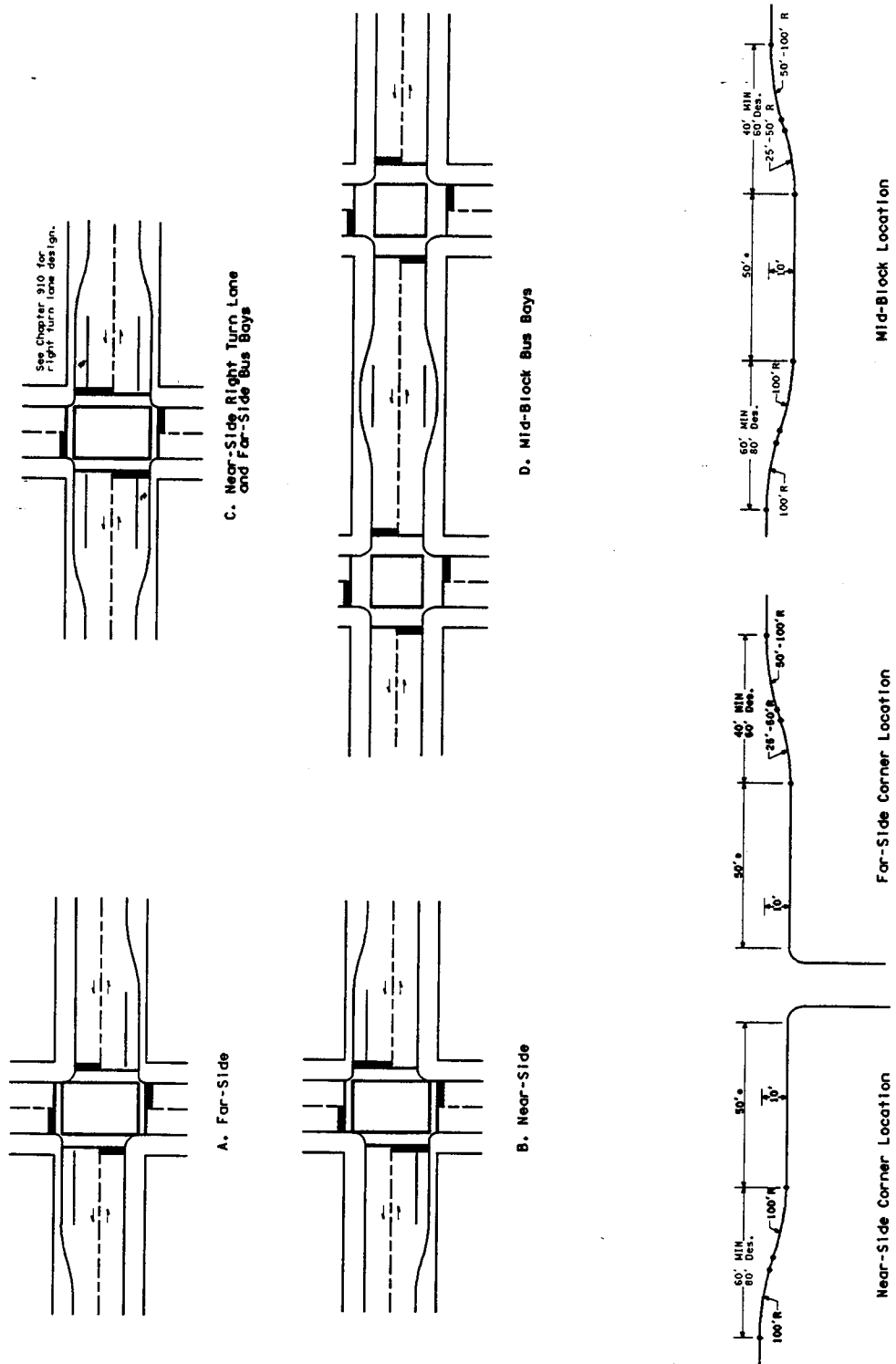

NOTE: Add 45' for each additional bus.  
 \* Based on a standard 40' bus.  
 Add 20' for articulated buses.

**BUS STOP PULLOUTS, ARTERIAL STREETS**

Figure 1060-6

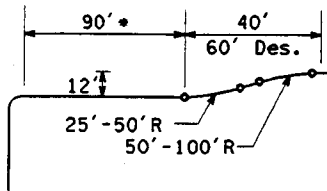
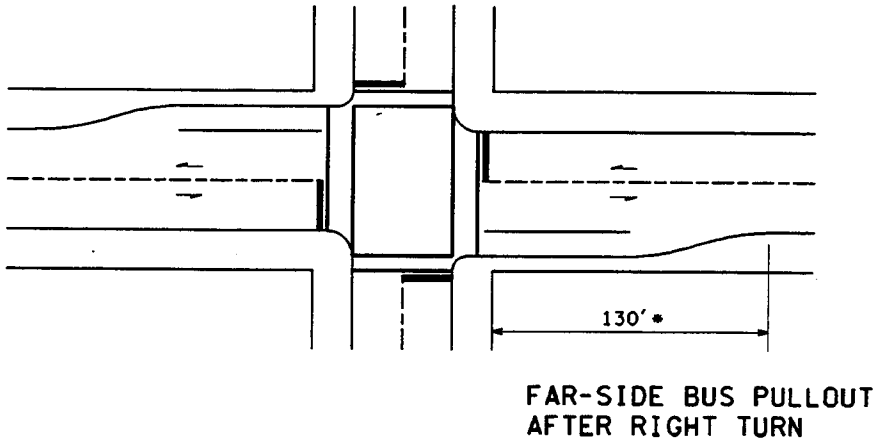
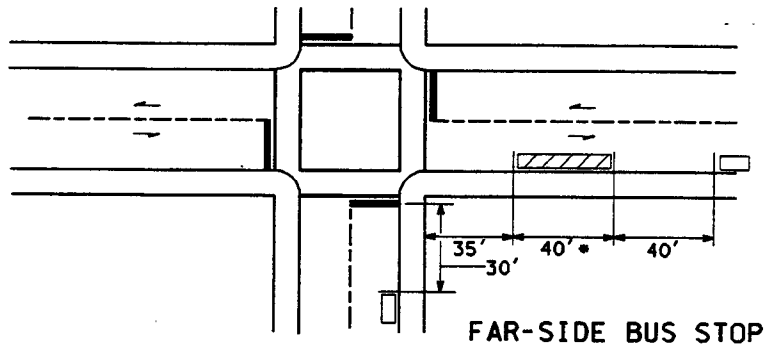

▨ Bus    □ Parked Car

\* Based on a standard 40' bus. Add 20' for articulated buses.

**MINIMUM BUS ZONE AND PULLOUT AFTER RIGHT TURN DIMENSIONS**

Figure 1060-7

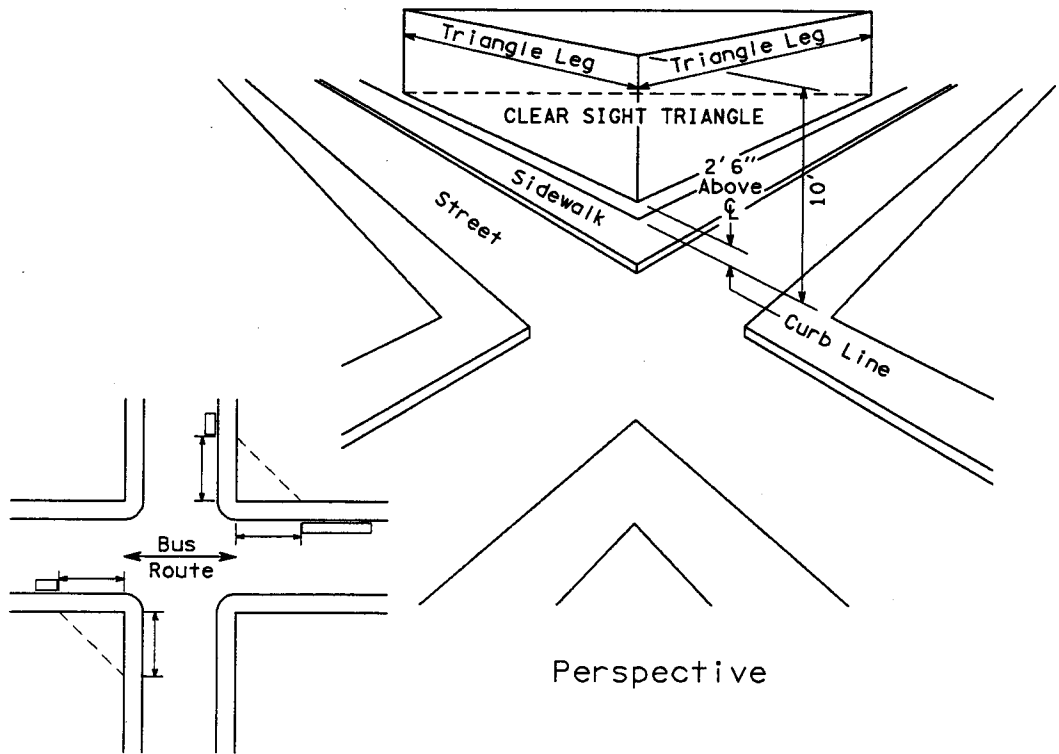
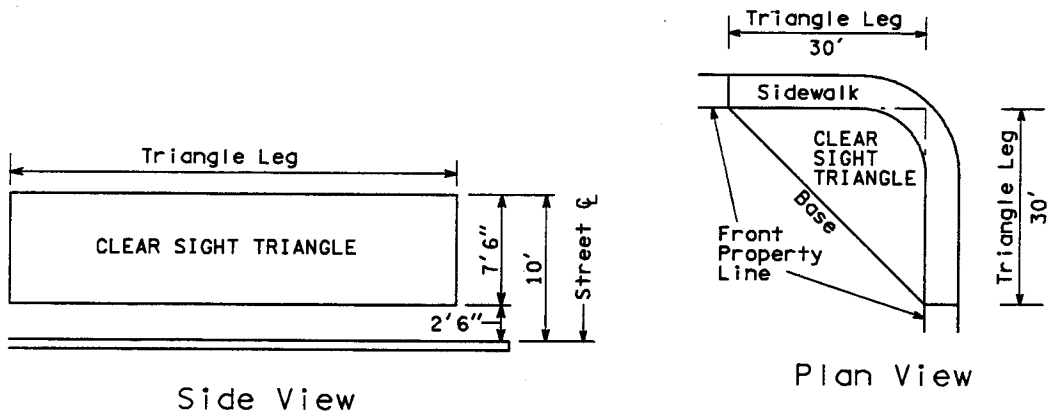

**SHELTER SITING**

Figure 1060-8



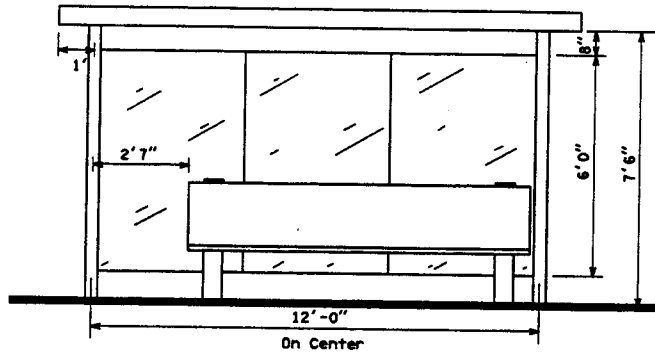

Front View

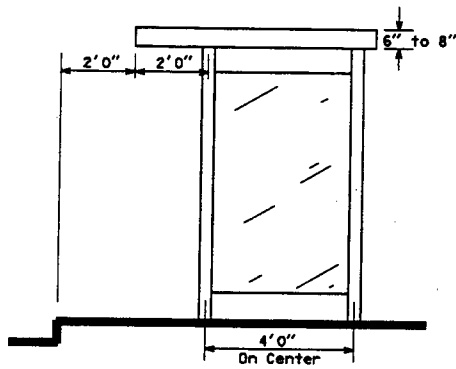

Side View

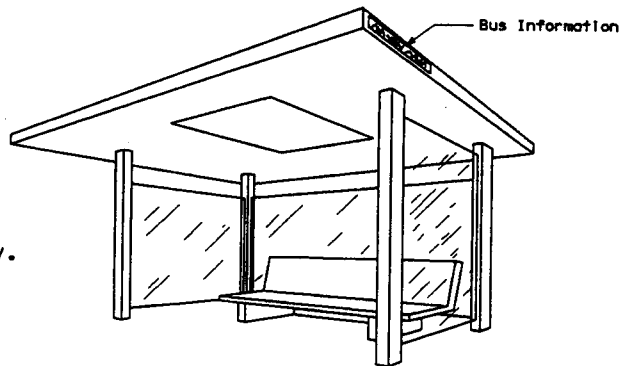

Note: Bench style can vary.

**TYPICAL BUS SHELTER DESIGN**

Figure 1060-9

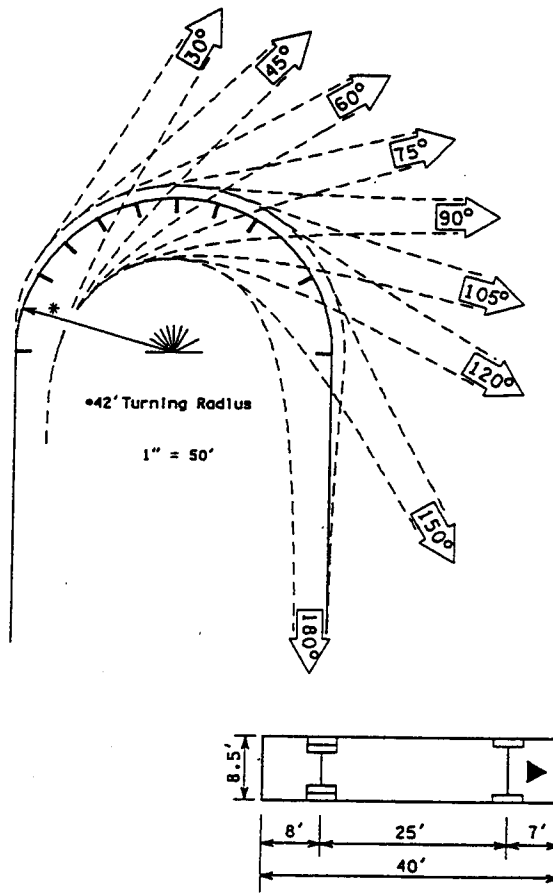

**Design Vehicle Turning Movements**  
*Figure 1060-10*

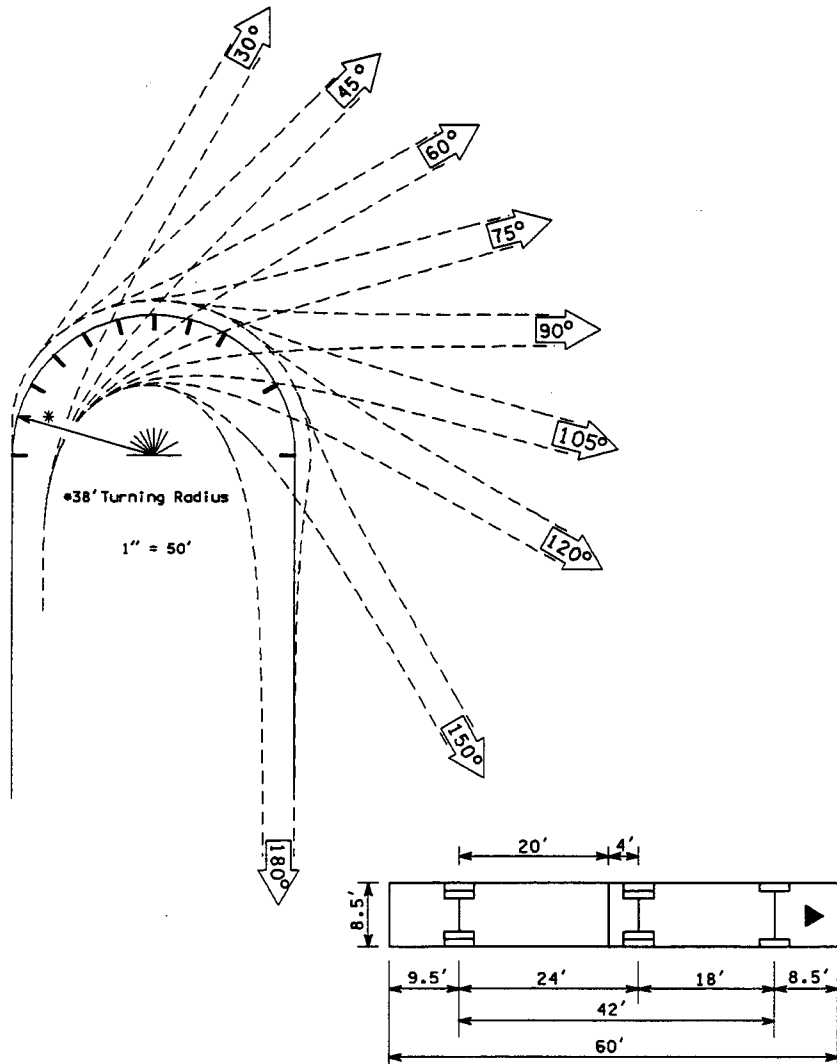

**Turning Template for Articulated Bus**  
*Figure 1060-11*

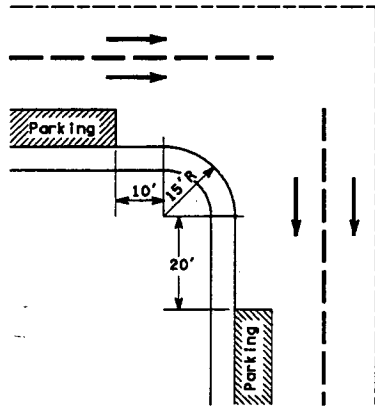

On Street Parking Before and After Turn

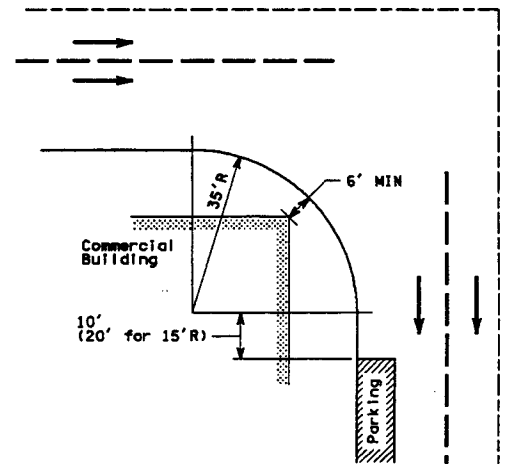

On Street Parking After Turn

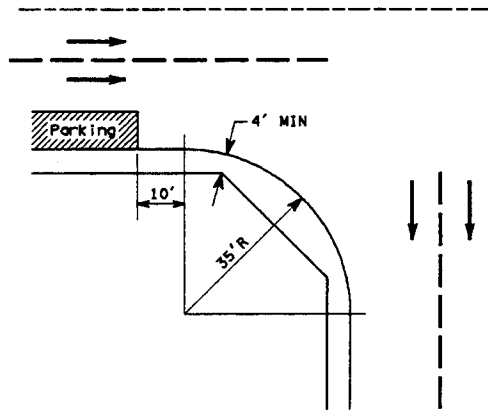

On Street Parking Before Turn

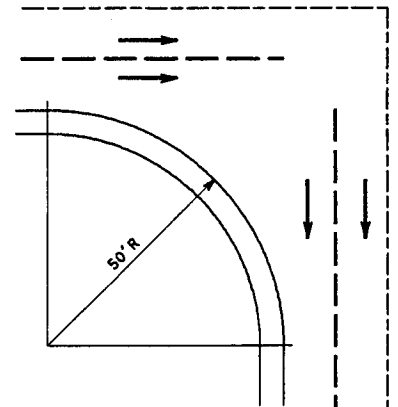

No On Street Parking

## INTERSECTION DESIGN

Figure 1060-12

$d_2$  (ft) for Cases A and B Where:

Design Vehicle	R=15'		R=20'		R=25'		R=30'		R=40'	
	A	B	A	B	A	B	A	B	A	B
30°	22	17	19	17	19	17	19	17	18	17
60°	28	21	26	20	24	20	23	19	22	18
90°	38	23	33	22	30	22	25	21	21	18
120°	46	28	40	25	32	23	26	19	19	18
150°	48	28	40	25	32	23	22	18	17	16

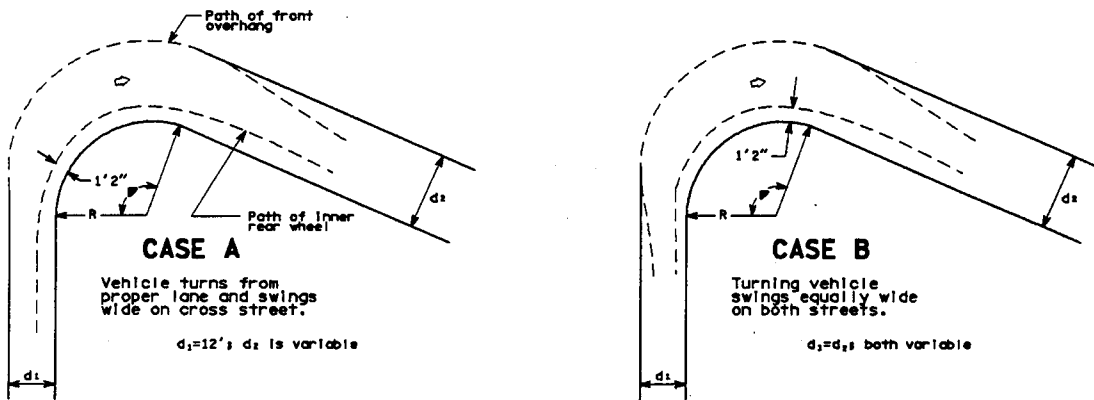

**CROSS-STREET WIDTH OCCUPIED BY TURNING VEHICLE FOR VARIOUS ANGLES OF INTERSECTION AND CURB RADII**

Figure 1060-13

- 1110.01 General
- 1110.02 References
- 1110.03 Required Data for All Structures
- 1110.04 Additional Data for Waterway Crossings
- 1110.05 Additional Data for Grade Separations
- 1110.06 Additional Data for Widening
- 1110.07 Documentation

### 1110.01 General

The Olympia Service Center Bridge and Structures Office provides structural design services to the regions. This chapter describes the information required by the Bridge and Structures Office to perform this function.

### 1110.02 References

*Bridge Design Manual*, M 23-50, WSDOT

*Plans Preparation Manual*, M 22-31, WSDOT

### 1110.03 Required Data for All Structures

Submit the bridge site data to the Bridge and Structures Office. Provide a cover memo that gives general information on the project, describes the attachments, and transmits the forms and data included in the submittal. Submit site data as a CAD file, supplemental drawings, and a report. See Figure 1110-1 for items to include in a bridge site data submittal. Direct any questions relating to the preparation of bridge site data to the Bridge and Structures Office. The *Bridge Design Manual* shows examples of required WSDOT forms.

#### (1) CAD Files and Supplemental Drawings

The Bridge and Structures Office uses the GDS Computer-Aided Drafting (CAD) system. CAD files prepared for use as bridge site data will be accepted in standard DGN, DXF, or DWG format.

Prepare plan, profile, and section drawings for all structures. Include copies of the CAD site data and supplemental drawings in the reduced plan sheet format with the submittal.

Use a complete and separate CAD file for each structure. See the *Plans Preparation Manual* for information regarding drawing levels and use the Bridge and Structures format. The *Bridge Design Manual* contains examples of completed Bridge Preliminary Plans. These plans show examples of the line styles and drawing format for site data in CAD.

Include the following information in the CAD files or in the supplemental drawings:

#### (a) Plan

- Drawing scales for the bridge site plan:

Length of Structure	Scale
20 ft to 100 ft	1"=10'
100 ft to 500 ft	1"=20'
500 ft to 800 ft	1"=30'
800 ft to 1,100 ft	1"=40'
more than 1,100 ft	1"=50'

The bridge site data is used to prepare the bridge layout plan which is be used in the contract plans. The drawing scales shown are for the full-sized contract plan format and are a guide only. Consider the width and general alignment of the structure when selecting the scale. For structures on curved alignments or where the bridge width is nearly equal to or greater than the bridge length, consult the Bridge and Structures Office for an appropriate plan scale.

- Vertical and horizontal datum control. See Chapters 1440 and 1450.
- Contours of the existing ground surface. Use intervals of 1, 2, 5, or 10 ft depending on terrain and plan scale. The typical contour interval is 2 ft. Use 1 ft intervals for flat terrain. Use 5 ft or 10 ft

intervals for steep terrain or small scales. Show contours beneath an existing or proposed structure and beneath the water surface of any waterway.

- Alignment of the proposed highway and traffic channelization in the vicinity.
- Location by section, township, and range.
- Type, size, and location of all existing or proposed sewers, telephone and power lines, water lines, gas lines, traffic barriers, culverts, bridges, buildings, and walls.
- Location of right of way lines and easement lines.
- Distance and direction to nearest towns or interchanges along the main alignment in each direction.
- Location of all roads, streets, and detours.
- Stage construction plan and alignment.
- Type, size, and location of all existing and proposed sign structures, light standards, and associated conduits and junction boxes. Provide proposed signing and lighting items when the information becomes available.
- Location of existing and proposed drainage.
- Horizontal curve data. Include coordinates for all control points.

(b) **Profile**

- Profile view showing the grade line of the proposed or existing alignment and the existing ground line along the alignment line.
- Vertical curve data.
- Superelevation transition diagram.

(c) **Section**

- Roadway sections on the bridge and at the bridge approaches. Indicate the lane and shoulder widths, cross slopes and side slopes, ditch dimensions, and traffic barrier requirements.
- Stage construction roadway geometrics with the minimum lane and roadway widths specified.

## (2) **Report**

Submit DOT Form 235-002, “Bridge Site Data-General.” Supplement the CAD drawings with the following items:

- Vicinity maps
- Class of highway
- Design speed
- Special requirements for replacing or relocating utility facilities
- ADT and DHV counts
- Truck traffic percentage
- Requirements for road or street maintenance during construction

## (3) **Video and Photographs**

Submit a VHS video of the site. Show all the general features of the site and details of existing structures. Scan the area slowly, spending extra time showing existing bridge pier details and end slopes. A “voice over” narrative on the video is necessary for orientation.

Color photographs of the structure site are desirable. Include detailed photographs of existing abutments, piers, end slopes, and other pertinent details for widenings, bridge replacements, or sites with existing structures.

### **1110.04 Additional Data for Waterway Crossings**

Coordinate with the Olympia Service Center (OSC) Hydraulics Branch and supplement the bridge site data for all waterway crossings with the DOT Form 235-001, “Bridge Site Data for Stream Crossings” and the following:

(a) **Plan**

- Show riprap or other slope protection requirements at the bridge site (type, plan limits, and cross section) as determined by the OSC Hydraulics Branch.

(b) **Profile**

- Show a profile of the waterway. The extent will be determined by the OSC Hydraulics Branch.

(c) **Section**

- Show cross sections of the waterway. The extent will be determined by the OSC Hydraulics Branch.

The requirements for waterway profile and cross sections may be less stringent if the Hydraulics Branch has sufficient documentation (FEMA reports, for example) to make a determination. Contact the Hydraulics Branch to verify the extent of the information needed. Coordinate any rechannelization of the waterway with the Hydraulics Branch.

Many waterway crossings require a permit from the U.S. Coast Guard. (See Chapter 240.) Generally, ocean tide influenced waterways and waterways used for commercial navigation require a Coast Guard permit. These structures require the following additional information:

- Names and addresses of the landowners adjacent to the bridge site.
- Quantity of new embankment material within the floodway. This quantity denotes, in cubic meters, the material below normal high water and the material above normal high water.

Some waterways may qualify for an exemption from Coast Guard permit requirements if certain conditions are met. See the *Bridge Design Manual*. If the waterway crossing appears to satisfy these conditions, then submit a statement explaining why this project is exempt from a Coast Guard permit. Attach this exemption statement to the Environmental Classification Summary prepared for the project and submit it to the OSC Project Development Branch for processing to FHWA.

The region is responsible for coordination with the Bridge and Structures Office, U. S. Army Corps of Engineers, and U. S. Coast Guard for waterways that may qualify for a permit exemption. The Bridge and Structures Office is responsible for coordination with the U.S. Coast Guard for waterways that require a permit.

## 1110.05 Additional Data for Grade Separations

### (1) *Highway-Railroad Separation*

Supplement bridge site data for structures involving railroads with the following:

(a) **Plan**

- Alignment of all existing and proposed railroad tracks.
- Center-to-center spacing of all tracks.
- Angle, station, and coordinates of all intersections between the highway alignment and each track.
- Location of railroad right of way lines.
- Horizontal curve data. Include coordinates for all circular and spiral curve control points.

(b) **Profile**

- For proposed railroad tracks; profile, vertical curve, and superelevation data for each track.
- For existing railroad tracks, elevations accurate to 0.1 ft taken at 10-ft intervals along the top of the highest rail of each track. Provide elevations to 50 ft beyond the extreme outside limits of the existing or proposed structure. Tabulate elevations in a format acceptable to the Bridge and Structures Office.

### (2) *Highway-Highway Separation*

Supplement bridge site data for structures involving other highways by the following:

(a) **Plan**

- Alignment of all existing and proposed highways, streets, and roads.
- Angle, station, and coordinates of all intersections between all crossing alignments.
- Horizontal curve data. Include coordinates for all curve control points.

(b) **Profile**

- For proposed highways; profile, vertical curve, and superelevation data for each.



- For existing highways; elevations accurate to 0.1 ft taken at intervals of 10 ft along the center line or crown line and each edge of shoulder, for each alignment, to define the existing roadway cross slopes. Provide elevations to 50 ft beyond the extreme outside limits of the existing or proposed structure. Tabulate elevations in a format acceptable to the Bridge and Structures Office format.

(c) **Section**

- Roadway sections of each undercrossing roadway indicating the lane and shoulder widths, cross slopes and side slopes, ditch dimensions, and traffic barrier requirements.
- Falsework or construction opening requirements. Specify minimum vertical clearances, lane widths, and shy distances.

### 1110.06 Additional Data for Widening

Bridge rehabilitations and modifications that require new substructure are defined as bridge widenings.

Supplement bridge site data for structures involving bridge widenings by the following:

- Submit DOT Form 235-002A, “Supplemental Bridge Site Data-Rehabilitation/Modification.”

(a) **Plan**

- Stations for existing back of pavement seats, expansion joints, and pier center lines based on field measurement along the survey line and each curb line.
- Locations of existing bridge drains. Indicate whether these drains are to remain in use or be plugged.

(b) **Profile**

- Elevations accurate to 0.1 ft taken at intervals of 10 ft along the curb line of the side of the structure being widened. Pair these elevations with corresponding elevations (same station) taken along the crown line or an offset distance (minimum of 10 ft from the curb line). This information will be used to establish the cross slope of the existing bridge. Tabulate elevations in a format acceptable to the Bridge and Structures Office.

Take these elevations at the level of the concrete roadway deck. For bridges with latex modified or microsilica modified concrete overlay, elevations at the top of the overlay will be sufficient. For bridges with a nonstructural overlay, such as an asphalt concrete overlay, take elevations at the level of the concrete roadway deck. For skewed bridges, take elevations along the crown line or at an offset distance (10 ft minimum from the curb line) on the approach roadway for a sufficient distance to enable a cross slope to be established for the skewed corners of the bridge.

### 1110.07 Documentation

The following documents are to be preserved in the project file. See Chapter 330.

- DOT Form 235-002, “Bridge Site Data - General”
- DOT Form 235-001, Bridge Site Data for Stream Crossings”
- DOT Form 235-002A, “Supplemental Bridge Site Data - Rehabilitation/Modification”
- United States Coast Guard permit
- Environmental Classification Summary

P65:DP/DME

I

**Review Chapter 1110 of the *Design Manual*  
for further information and description of the items listed below.**

PLAN (In CAD file.)	_____ Profile Grade Vertical Curves
_____ Survey Lines and Station Ticks	_____ Coast Guard Permit Status
_____ Survey Line Intersection Angles	_____ Railroad Agreement Status
_____ Survey Line Intersection Stations	_____ Highway Classification
_____ Survey Line Bearings	_____ Design Speed
_____ Roadway and Median Widths	_____ ADT, DHV, and % T
_____ Lane and Shoulder Widths	
_____ Sidewalk Width	FORMS (Information noted on the form or attached on supplemental sheets or drawings.)
_____ Connection/Widening for Traffic Barrier	
_____ Profile Grade and Pivot Point	Bridge Site Data General
_____ Roadway Superelevation Rate (if constant)	_____ Slope Protection
_____ Lane Taper and Channelization Data	_____ Pedestrian Barrier/Pedestrian Rail Height Requirements
_____ Traffic Arrows	_____ Construction/Falsework Openings
_____ Mileage to Towns Along Main Line	_____ Stage Construction Channelization Plans
_____ Existing Drainage Structures	_____ Bridge (before/with/after) Approach Fills
_____ Existing Utilities — Type/Size/Location	_____ Datum
_____ New Utilities — Type/Size/Location	_____ Video of Site
_____ Light standards, Junction boxes, Conduits	_____ Photographs of Site
_____ Bridge Mounted Signs and Supports	_____ Control Section
_____ Contours	_____ Project Number
_____ Bottom of Ditches	_____ Region Number
_____ Test Holes (if available)	_____ Highway Section
_____ Riprap Limits	
_____ Stream Flow Arrow	Bridge Site Data for Stream Crossings
_____ R/W Lines and/or Easement Lines	_____ Water Surface Elevations and Flow Data
_____ Exist. Bridge No. (to be removed, widened)	_____ Riprap Cross Section Detail
_____ Section, Township, Range	
_____ City or Town	Supplemental Bridge Site Data-Rehabilitation/Modification
_____ North Arrow	
_____ SR Number	BRIDGE, CROSSROAD, AND APPROACH ROADWAY CROSS SECTIONS
_____ Scale	(May be in CAD or separate drawings.)
TABLES (In tabular format in CAD file.)	_____ Bridge Roadway Width
_____ Curb Line Elevations. at Top of Exist. Br. Deck	_____ Lane and Shoulder Widths
_____ Undercrossing Roadway Existing Elevations	_____ Profile Grade and Pivot Point
_____ Undercrossing Railroad Existing Elevations	_____ Superelevation Rate
_____ Curve Data	_____ Survey Line
	_____ PB/Pedestrian Rail Dimensions
	_____ Stage Construction Lane Orientations
	_____ Locations of Temporary Barrier
	_____ Conduits/Utilities in Bridge
	_____ Location and Depth of Ditches
OTHER SITE DATA (May be in CAD or may be on supplemental sheets or drawings.)	_____ Shoulder Widening for Barrier
_____ Superelevation Diagrams	_____ Side Slope Rate
_____ End Slope Rate	

I

**Bridge Site Data Check List**  
*Figure 1110-1*

- 1120.01 General
- 1120.02 References
- 1120.03 Bridge Location
- 1120.04 Bridge Site Design Elements
- 1120.05 Documentation

### 1120.01 General

A bridge is a structure having a clear span of 20 ft or more. Bridge design is the responsibility of the Bridge and Structures Office in Olympia. A project file is required for all bridge construction projects. The Bridge Office develops a preliminary bridge plan for a new or modified structure in collaboration with the region. This chapter provides basic design considerations for the development of this plan. Unique staging requirements, constructibility issues, and other considerations are addressed during the development of this plan. Contact the Bridge Office early in the planning stage on issues that might affect the planned project.

### 1120.02 References

*Bridge Design Manual*, M 23-50, WSDOT

*Local Agency Guidelines*, M 36-63, WSDOT

*Manual on Uniform Traffic Control Devices for Streets and Highways* (MUTCD), USDOT, Washington DC, 1988, including the Washington State Modifications to the MUTCD, M 24-01, WSDOT, 1996

*Traffic Manual*, M 51-02, WSDOT

### 1120.03 Bridge Location

Bridges are located to conform to the alignment of the highway. Providing the following conditions can simplify design efforts, minimize construction activities, and reduce structure costs:

- A perpendicular crossing
- The minimum required horizontal and vertical clearances
- A constant bridge width (without tapered sections)

- A tangential approach alignment of sufficient length to not require superelevation on the bridge
- A crest vertical curve profile that will facilitate drainage
- An adequate construction staging area

### 1120.04 Bridge Site Design Elements

#### (1) Structural Capacity

The structural capacity of a bridge is a measure of the structure's ability to carry vehicle loads. For new bridges, the bridge designer chooses the design load that determines the structural capacity. For existing bridges, the structural capacity is calculated to determine the "load rating" of the bridge. The load rating is used to determine whether or not a bridge is "posted" for legal weight vehicles or if the bridge is "restricted" for overweight permit vehicles.

(a) **New Structures.** All new structures that carry vehicular loads are designed to HL-93 notional live load in accordance with AASHTO LRFD Bridge Design Specifications or HS-25 live loading in accordance with the AASHTO Standard Specifications for Highway Bridges.

(b) **Existing Structures.** When the Structural Capacity column of a Design Matrix applies to the project, request a Structural Capacity Report from the Risk Reduction Engineer in the Bridge and Structures Office at mail stop 47341. The report will state:

- The structural capacity status of the structures within the project limits.
- What action, if any, is appropriate.
- Whether a deficient bridge is included in the six-year or 20 year plans for replacement or rehabilitation under the P<sub>2</sub> program and, if so, in which biennium the P<sub>2</sub> project is likely to be funded.

Include the Structural Capacity Report in the design file.

The considerations used to evaluate the structural capacity of a bridge are as follows:

1. On National Highway System (NHS) routes (including Interstate routes):

- I • Operating load rating is at least 36 tons (which is equal to HS-20).
  - The bridge is not permanently posted for legal weight vehicles.
  - The bridge is not permanently restricted for vehicles requiring overweight permits.
2. On non-NHS routes:
- The bridge is not permanently posted for legal weight vehicles.
  - The bridge is not permanently restricted for vehicles requiring overweight permits.

## **(2) Bridge Widths for Structures**

(a) **New Structures.** Full design level widths are provided on all new structures. See Chapter 440. All structures on city or county routes crossing over a state highway must conform to the Local Agency Guidelines. Use local city or county adopted and applied standards when their minimums exceed state criteria.

(b) **Existing Structures.** See the design matrices in Chapter 325 for guidance.

## **(3) Horizontal Clearance**

Horizontal clearance for structures is the distance from the edge of the traveled way to bridge piers and abutments, bridge rail ends, or bridge end embankment slopes. Minimum distances for this clearance vary depending on the type of structure. The Bridge Design Manual provides guidance on horizontal clearance.

## **(4) Medians**

For multilane highways, the minimum median widths for new bridges are as shown in Chapters 430 and 440. An open area between two bridges is undesirable when the two roadways are separated by a median width of 26 ft or less. The preferred treatment is to provide a new, single structure that spans the area between the

roadways. When this is impractical, consider widening the two bridges on the median sides to reduce the open area to 6 in. When neither option is practical, consider installing netting or other elements to enclose the area between the bridges. Consideration and analysis of all site factors are necessary if installation of netting or other elements is proposed. Document this evaluation in the project file and obtain the approval of the State Design Engineer.

## **(5) Vertical Clearance**

Vertical clearance is the critical height under a structure that will safely accommodate vehicular and rail traffic based on its design characteristics. This height is the least height available from the lower roadway surface (including useable shoulders), or the plane of the railroad tracks, to the bottom of the bridge. Usable shoulders are the design shoulders for the roadway and do not include paved widened areas that may exist under the structure.

(a) **Minimum Vertical Clearance.** For new structures, the minimum vertical clearances are as follows:

1. A bridge over a roadway. The minimum vertical clearance is 16.5 ft.
2. A bridge over a railroad track. The minimum vertical clearance is 23.5 ft. Vertical clearance is provided for the width of the railroad freight car. (See Figure 1120-1a.)
3. A pedestrian bridge over a roadway. The minimum vertical clearance is 17.5 ft.

(b) **Vertical Clearance for Existing Structures.** The criteria used to evaluate the vertical clearance of existing structures depends on the work that is being done on or under that structure.

1. For a project that will widen a structure over a highway or where the highway will be widened under a structure, evaluate the vertical clearance using the criteria for a new structure. With an approved deviation, the vertical clearance of these structures can be as little as 16.0 ft on the Interstate System (see 1120.04 (5) (d), Coordination) or 15.5 ft on non-Interstate highways.

2. For a project at an existing bridge where no widening is proposed on or under the structure, the bridge may remain in place if at least 14.5 ft of vertical clearance is provided.

3. For a planned resurfacing of the highway under an existing bridge, if the clearance will be less than the minimum vertical clearance for a new bridge, consider:

- Pavement removal and replacement
- Roadway excavation and reconstruction to lower the profile of the roadway
- Providing a new bridge with the required vertical clearance

Reducing roadway paving and surfacing thickness under the bridge to achieve the minimum vertical clearance can cause accelerated deterioration of the highway and is not allowed. Elimination of the planned resurfacing in the immediate area of the bridge might be a short term solution if recommended by the region's Materials Engineer.

4. For an existing structure over a railroad track, the vertical clearance can be as little as 22.5 ft with an approved deviation. (See Figure 1120-1b.) A lesser clearance can be used with the agreement of the railroad company and the Washington State Utilities and Transportation Commission.

(c) **Signing.** Low clearance warning signs are necessary when the vertical clearance of an existing bridge is less than 15 ft 3 in. Other requirements for low clearance signing are contained in the Manual on Uniform Traffic Control Devices and the Traffic Manual.

(d) **Coordination.** The Interstate system is used by the Department of Defense (DOD) for the conveyance of military traffic. The Military Traffic Management Command Transportation Engineering Agency (MTMCTEA) represents the DOD in public highway matters. The MTMCTEA has an inventory of vertical clearance deficiencies over the Interstate system in Washington State. Contact the MTMCTEA, through FHWA, if any of the following changes are proposed to these bridges:

- A project would create a new deficiency of less than 16.0 ft vertical clearance over an Interstate highway.
- The vertical clearance over the Interstate is already deficient (less than 16.0 ft) and a change (increase or decrease) to vertical clearance is proposed.

Coordination with MTMCTEA is required for these changes on all rural Interstate highways and for one Interstate route through each urban area.

### **(6) Bridge Approach Slab**

Bridge approach slabs are reinforced concrete pavement installed across the full width of the bridge ends. They provide a stable transition from normal roadway cross section to the bridge ends and compensate for differential expansion and contraction of the bridge and the roadway. Bridge approach slabs are provided on all new bridges. If an existing bridge is being widened and it has an approach slab, slabs are required on the widenings. The region, with the concurrence of the State Geotechnical Engineer and the State Bridge Engineer, may decide to omit bridge approach slabs.

### **(7) Pedestrian and Bicycle Facilities**

Accommodations for pedestrians and bicycles on bridges are addressed in Chapter 1020.

### **(8) Bridge Rail End Treatment**

Plans for new bridge construction and bridge rail modifications include provisions for the connection of traffic barriers to the bridge rail. Indicate the preferred traffic barrier type and connection during the review of the bridge preliminary plan.

### **(9) Bridge Slope Protection**

Slope protection provides a protective and aesthetic surface for exposed slopes under bridges. Slope protection is normally provided under:

- Structures over state highways
- Structures within an interchange
- Structures over other public roads unless requested otherwise by the public agency

- Railroad overcrossings, if requested by the railroad

Slope protection is usually not provided under pedestrian structures. The type of slope protection is selected at the bridge preliminary plan stage. Typical slope protection types are concrete slope protection, semi-open concrete masonry, and rubble stone.

### **(10) Slope Protection at Watercrossings**

The Olympia Service Center (OSC) Hydraulics Branch determines the slope protection requirements for structures that cross waterways. The type, limits, and quantity of the slope protection are shown on the bridge preliminary plan.

### **(11) Protective Screening for Highway Structures**

The Washington State Patrol classifies the throwing of an object from a highway structure as an assault, not an accident. Therefore, records of these assaults are not contained in the Patrol's accident databases. Contact the region's Maintenance Engineer's office and the Washington State Patrol for the history of reported incidents.

Protective screening might reduce the number of incidents but will not stop a determined individual. Enforcement provides the most effective deterrent.

Installation of protective screening is analyzed on a case-by-case basis at the following locations:

- On existing structures where there is a history of multiple incidents of objects being dropped or thrown and enforcement has not changed the situation.
- On a new structure near a school, a playground, or where frequently used by children not accompanied by adults.

- In urban areas, on a new structure used by pedestrians where surveillance by local law enforcement personnel is not likely.
- On new structures with walkways where experience on similar structures within a 1 mile radius indicates a need.
- On structures over private property that is subject to damage, such as buildings or power stations.

In most cases, the installation of a protective screen on a new structure can be postponed until there are indications of need.

Submit all proposals to install protective screening on structures to the State Design Engineer for approval. Contact the Bridge and Structures Office for approval to attach screening to structures and for specific design and mounting details.

### **1120.05 Documentation**

Include the following items in the project file. See Chapter 330.

- Structural Capacity Report
- Evaluation of need and approval for enclosing the area between bridges
- Correspondence involving the MTMCTEA
- Justification for eliminating an overlay in the vicinity of a bridge
- Final Foundation Report
- Justification and OSC concurrence for omitting approach slabs
- Analysis of need and approval for protective screening on highway structures

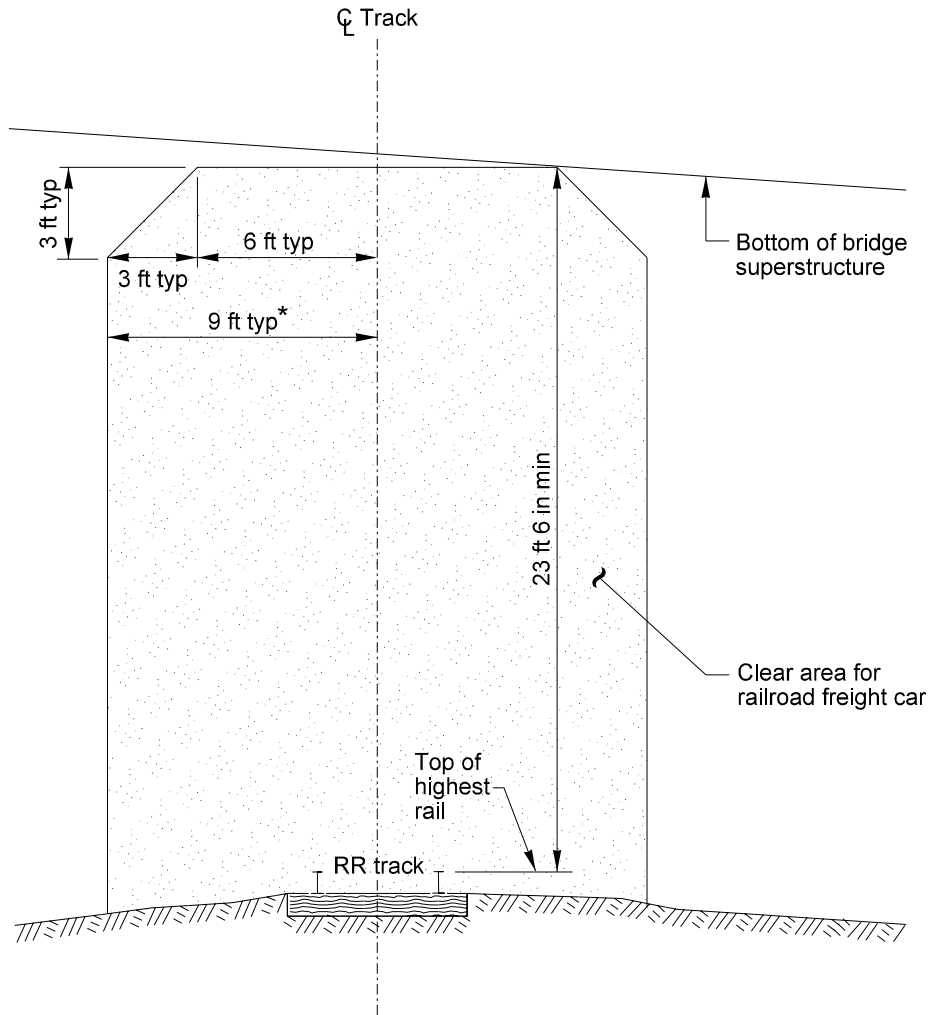

\* Increase 1.5 in for each degree of railway alignment curve.

**Railroad Vertical Clearance for New Bridge Construction**  
*Figure 1120-1a*

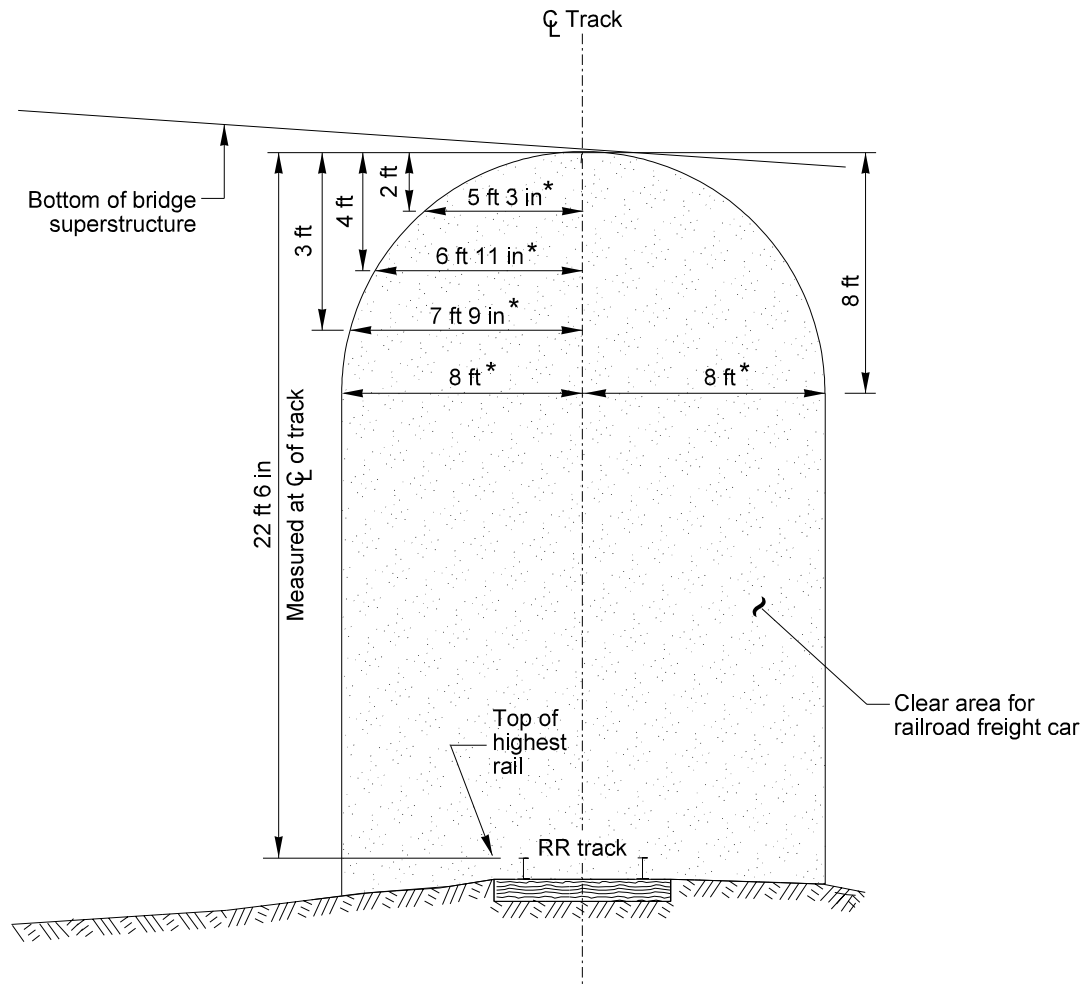

\* Increase 1.5 in for each degree of railway alignment curve.

**Railroad Vertical Clearance for Existing Bridge Modifications**  
*Figure 1120-1b*



## 1130

# Retaining Walls and Steep Reinforced Slopes

- 1130.01 References
- 1130.02 General
- 1130.03 Design Principles
- 1130.04 Design Requirements
- 1130.05 Guidelines for Wall/Slope Selection
- 1130.06 Design Responsibility and Process
- 1130.07 Documentation

### 1130.01 References

*Bridge Design Manual*, M 23-50, WSDOT

*Standard Plans for Road, Bridge, and Municipal Construction* (Standard Plans), M 21-01, WSDOT

*Plans Preparation Manual*, M 22-31, WSDOT

*Roadside Manual*, M 25-39, WSDOT

### 1130.02 General

The function of a retaining wall is to form a nearly vertical face through confinement and/or strengthening of a mass of earth or other bulk material. Likewise, the function of a reinforced slope is to strengthen the mass of earth or other bulk material such that a steep (up to 1H:2V) slope can be formed. In both cases, the purpose of constructing such structures is to make maximum use of limited right of way. The difference between the two is that a wall uses a structural facing whereas a steep reinforced slope does not require a structural facing. Reinforced slopes typically use a permanent erosion control matting with low vegetation as a slope cover to prevent erosion. See the *Roadside Manual* for more information.

To lay out and design a retaining wall or reinforced slope, consider the following items:

- Functional classification
- Highway geometry
- Design Clear Zone requirements (Chapter 700)
- The amount of excavation required

- Traffic characteristics
- Constructibility
- Impact to any adjacent environmentally sensitive areas
- Impact to adjacent structures
- Potential added lanes
- Length and height of wall
- Material to be retained
- Foundation support and potential for differential settlement
- Ground water
- Earthquake loads
- Right of way costs
- Need for construction easements
- Risk
- Overall cost
- Visual appearance

If the wall or toe of a reinforced slope is to be located adjacent to the right of way line, consider the space needed in front of the wall/slope to construct it.

### (1) Retaining Wall Classifications

Retaining walls are generally classified as gravity, semigravity, nongravity cantilever, or anchored. Examples of the various types of walls are provided in Figures 1130-1a through 1c.

Gravity walls derive their capacity to resist lateral soil loads through a combination of dead weight and sliding resistance. Gravity walls can be further subdivided into rigid gravity walls, prefabricated modular gravity walls, and Mechanically Stabilized Earth (MSE) gravity walls.

Rigid gravity walls consist of a solid mass of concrete or mortared rubble and use the weight of the wall itself to resist lateral loads.

Prefabricated modular gravity walls consist of interlocking soil or rock filled concrete, steel, or wire modules or bins (gabions, for example). The combined weight of these modules or bins resist the lateral loads from the soil.

MSE gravity walls use strips, bars, or mats of steel or polymeric reinforcement to reinforce the soil and create a reinforced soil block behind the face. The reinforced soil block then acts as a unit and resists the lateral soil loads through the dead weight of the reinforced mass. MSE walls may be constructed as fill walls, with fill and reinforcement placed in alternate layers to create a reinforced mass, or reinforcement may be drilled into an existing soil/rock mass using grouted anchor technology to create a reinforced soil mass (soil nail walls).

Semigravity walls rely more on structural resistance through cantilevering action of the wall stem. Generally, the backfill for a semigravity wall rests on part of the wall footing. The backfill, in combination with the weight of the wall and footing, provides the dead weight for resistance. An example of a semigravity wall is the reinforced concrete wall provided in the Standard Plans.

Nongravity cantilever walls rely strictly on the structural resistance of the wall in which vertical elements of the wall are partially embedded in the soil or rock to provide fixity. These vertical elements may consist of piles (soldier piles or sheet piles, for example), caissons, or drilled shafts. The vertical elements may form the entire wall face or they may be spanned structurally using timber lagging or other materials to form the wall face.

Anchored walls derive their lateral capacity through anchors embedded in stable soil or rock below or behind all potential soil/rock failure surfaces. Anchored walls are similar to nongravity cantilevered walls except that anchors embedded in the soil/rock are attached to the wall facing structure to provide lateral resistance. Anchors typically consist of deadmen or grouted soil/rock anchors.

Reinforced slopes are similar to MSE walls in that they also use fill and reinforcement placed in alternate layers to create a reinforced soil mass. However, the face is typically built at a 1.2H:1V to 1H:2V slope.

Rockeries (rock walls) behave to some extent like gravity walls. However, the primary function of a rockery is to prevent erosion of an oversteepened but technically stable slope. Rockeries consist of large well-fitted rocks stacked on top of one another to form a wall.

An example of a rockery and reinforced slope is provided in Figure 1130-1d. The various wall types and their classifications are summarized in Table 1(a-f).

### **1130.03 Design Principles**

The design of a retaining wall or reinforced slope consists of seven principal activities:

- Developing wall/slope geometry
- Adequate subsurface investigation
- Evaluation of loads and pressures that will act on the structure
- Design of the structure to safely withstand the loads and pressures
- Design of the structure to meet aesthetic requirements
- Wall/slope constructibility
- Coordination with other design elements

The structure and adjacent soil mass must also be stable as a system, and the anticipated wall settlement must be within acceptable limits.

### **1130.04 Design Requirements**

#### **(1) Wall/Slope Geometry**

Wall/slope geometry is developed considering the following:

- Geometry of the transportation facility itself
- Design Clear Zone requirements (Chapter 700)
- Flare rate and approach slope when inside the Design Clear Zone (Chapter 710)

- Right of way constraints
- Existing ground contours
- Existing and future utility locations
- Impact to adjacent structures
- Impact to environmentally sensitive areas
- For wall/slope geometry, also consider the foundation embedment and type anticipated, which requires coordination among the various design groups involved.

Retaining walls must not have anything (such as bridge columns, light fixtures, or sign supports) protruding in such a way as to present a potential for snagging vehicles.

Provide a traffic barrier shape at the base of a new retaining wall constructed 12 ft or less from the edge of the nearest traffic lane. The traffic barrier shape is optional at the base of the new portion when an existing vertical-faced wall is being extended (or the existing wall may be retrofitted for continuity). Standard Concrete Barrier Type 4 is recommended for both new and existing walls except when the barrier face can be cast as an integral part of a new wall. Deviations may be considered but require approval as prescribed in Chapter 330. For deviations from the above, deviation approval is not required where sidewalk exists in front of the wall or in other situations where the wall face is otherwise inaccessible to traffic.

## **(2) Investigation of Soils**

All retaining wall and reinforced slope structures require an investigation of the underlying soil/rock that supports the structure. Chapter 510 provides guidance on how to complete this investigation. A soil investigation is critical for the design of any retaining wall or reinforced slope. The stability of the underlying soils, their potential to settle under the imposed loads, the usability of any existing excavated soils for wall/reinforced slope backfill, and the location of the ground water table are determined through the geotechnical investigation.

## **(3) Geotechnical and Structural Design**

The structural elements of the wall or slope and the soil below, behind, and/or within the structure must be designed together as a system. The wall/slope system is designed for overall external stability as well as internal stability. Overall external stability includes stability of the slope of which the wall/reinforced slope is a part and the local external stability (overturning, sliding, and bearing capacity). Internal stability includes resistance of the structural members to load and, in the case of MSE walls and reinforced slopes, pullout capacity of the structural members or soil reinforcement from the soil.

## **(4) Drainage Design**

One of the principal causes of retaining wall/slope failure is the additional hydrostatic load imposed by an increase in the water content in the material behind the wall or slope. This condition results in a substantial increase in the lateral loads behind the wall/slope since the material undergoes a possible increase in unit weight, water pressure is exerted on the back of the wall, and the soil shear strength undergoes a possible reduction. To alleviate this, adequate drainage for the retaining wall/slope must be considered in the design stage and reviewed by the Region Materials Engineer during construction. The drainage features shown in the Standard Plans are the minimum basic requirements. Underdrains behind the wall/slope must daylight at some point in order to adequately perform their drainage function. Provide positive drainage at periodic intervals to prevent entrapment of water.

Native soil may be used for retaining wall and reinforced slopes backfill if it meets the requirements for the particular wall/slope system. In general, use backfill that is free-draining and granular in nature. Exceptions to this can be made depending on the site conditions as determined by the Geotechnical Services Branch of the Olympia Service Center (OSC) Materials Laboratory.

A typical drainage detail for a gravity wall (in particular, an MSE wall) is shown in Figure 1130-2. Typical drainage details for a standard reinforced concrete cantilever wall are provided in the DETAILS.CEL library. Always include drainage details such as these with a wall unless otherwise recommended to be deleted by the region's Materials Engineer or OSC Geotechnical Services Branch.

### **(5) Aesthetics**

Retaining walls and slopes should have a pleasing appearance that is compatible with the surrounding terrain and other structures in the vicinity. To the extent possible within functional requirements and cost effectiveness criteria, this aesthetic goal should be met for all visible retaining walls and reinforced slopes.

Aesthetic requirements include consideration of the wall face material, the top profile, the terminals, and the surface finish (texture, color, and pattern). Where appropriate, provide planting areas and irrigation conduits. These will visually soften them and blend them with adjacent areas. Avoid short sections of retaining wall or steep slope where possible.

In higher walls, variations in slope treatment are recommended for a pleasing appearance. High, continuous walls are generally not desirable from an aesthetic standpoint, as high, continuous walls can be quite imposing. Consider stepping high or long retaining walls in areas of high visibility. Plantings could be considered between wall steps.

Approval from the Principle Architect of the Bridge and Structures Office is required on all retaining wall aesthetics including finishes.

### **(6) Constructibility**

Consider the potential effect site constraints may have on the constructibility of the specific wall/slope. Constraints to be considered include, but are not limited to, site geometry, access, time required to construct the wall, environmental issues, and impact on traffic flow and other construction activities.

### **(7) Coordination with Other Design Elements**

Retaining wall and slope designs must be coordinated with other elements of the project that could interfere with or impact the design and/or construction of the wall/slope. Also consider drainage features, utilities, luminaire or sign structures, adjacent retaining walls or bridges, concrete traffic barriers, and beam guardrails. Locate these design elements in a manner that will minimize the impacts to the wall elements. In general, locate obstructions within the wall backfill (such as guardrail posts, drainage features, and minor structure foundations) a minimum of 3 ft from the back of the wall facing units. Greater offset distances may be required depending on the size and nature of the interfering design element. If possible, locate these elements to miss reinforcement layers or other portions of the wall system. Conceptual details for accommodating concrete traffic barriers and beam guardrails are provided in Figure 1130-3.

Where impact to the wall elements is unavoidable, the wall system must be designed to accommodate these impacts. For example, it may be necessary to place drainage structures or guardrail posts in the reinforced backfill zone of MSE walls. This may require that holes be cut in the upper soil reinforcement layers, or that discrete reinforcement strips be splayed around the obstruction. This causes additional load to be carried in the adjacent reinforcement layers due to the missing soil reinforcement or the distortion in the reinforcement layers.

The need for these other design elements and their impact on the proposed wall systems must be clearly indicated in the wall site data that is submitted so that the walls can be properly designed. Contact the Bridge and Structures Office (or the Geotechnical Services Branch, for geosynthetic walls/slopes and soil nail walls) for assistance regarding this issue.

## 1130.05 Guidelines for Wall/Slope Selection

Wall/slope selection is dependent on the following considerations:

- Whether the wall/slope will be located primarily in a cut or fill (how much excavation/shoring will be required to construct the wall or slope?)
- If located in a cut, the type of soil/rock present
- The need for space between the right of way line and the wall/slope or easement
- The amount of settlement expected
- The potential for deep failure surfaces to be present
- The structural capacity of the wall/slope in terms of maximum allowable height
- The nature of the wall/slope application
- Whether or not structures or utilities will be located on or above the wall
- Architectural requirements
- Overall economy

### (1) *Cut and Fill Considerations*

Due to the construction technique and base width required, some wall types are best suited for cut situations whereas others are best suited for fill situations. For example, anchored walls and soil nail walls have soil reinforcements drilled into the in-situ soil/rock and, therefore, are generally used in cut situations. Nongravity cantilevered walls are drilled or cut into the in-situ soil/rock, have narrow base widths, and are also well suited to cut situations. Both types of walls are constructed from the top down. Such walls are also used as temporary shoring to allow other types of walls or other structures to be constructed where considerable excavation would otherwise be required.

MSE walls and reinforced slopes, however, are constructed by placing soil reinforcement between layers of fill from the bottom up and are therefore best suited to fill situations. Furthermore, the base width of MSE walls is typically

on the order of 70 percent of the wall height, which would require considerable excavation in a cut situation. Therefore, in a cut situation, base width requirements usually make MSE structures uneconomical and possibly unconstructible.

Semigravity (cantilever) walls, rigid gravity walls, and prefabricated modular gravity walls are free-standing structural systems built from the bottom up but they do not rely on soil reinforcement techniques (placement of fill layers with soil reinforcement) to provide stability. These types of walls generally have a narrower base width than MSE structures, (on the order of 50 percent of the wall height). Both of these factors make these types of walls feasible in fill situations as well as many cut situations.

Reinforced slopes generally require more room overall to construct than a wall because of the sloping face, but are typically a feasible alternative to a combination wall and fill slope to add a new lane. Reinforced slopes can also be adapted to the existing ground contours to minimize excavation requirements where fill is placed on an existing slope. Reinforced slopes may also be feasible to repair slopes damaged by landslide activity or deep erosion.

Rockerries are best suited to cut situations, as they require only a narrow base width, on the order of 30 percent of the rockery height. Rockeries can be used in fill situations, but the fill heights that they support must be kept relatively low as it is difficult to get the cohesive strength needed in granular fill soils to provide minimal stability of the soil behind the rockery at the steep slope typically used for rockeries in a cut (such as 1H:6V or 1H:4V).

The key considerations in deciding which walls or slopes are feasible are the amount of excavation or shoring required and the overall height. The site geometric constraints must be well defined to determine these elements. Another consideration is whether or not an easement will be required. For example, a temporary easement may be required for a wall-in a fill situation to allow the contractor to work in front of the wall. For walls in cut situations, especially anchored walls and soil nail walls, a permanent easement may be required for the anchors or nails.

## **(2) Settlement and Deep Foundation Support Considerations**

Settlement issues, especially differential settlement, are of primary concern for selection of walls. Some wall types are inherently flexible and can tolerate a great deal of settlement without suffering structurally. Other wall types are inherently rigid and cannot tolerate much settlement. In general, MSE walls have the greatest flexibility and tolerance to settlement, followed by prefabricated modular gravity walls. Reinforced slopes are also inherently very flexible. For MSE walls, the facing type used can affect the ability of the wall to tolerate settlement. Welded wire and geosynthetic wall facings are the most flexible and the most tolerant to settlement, whereas concrete facings are less tolerant to settlement. In some cases, concrete facing can be placed, after the wall settlement is complete, such that the concrete facing does not limit the wall's tolerance to settlement. Facing may also be added for aesthetic reasons.

Semigravity (cantilever) walls and rigid gravity walls have the least tolerance to settlement. In general, total settlement for these types of walls must be limited to approximately 1 in or less. Rockeries also cannot tolerate much settlement, as rocks could shift and fall out. Therefore, semigravity cantilever walls, rigid gravity walls, and rockeries are not used in settlement prone areas.

If very weak soils are present that will not support the wall and that are too deep to be overexcavated, or if a deep failure surface is present that results in inadequate slope stability, the wall type selected must be capable of using deep foundation support and/or anchors. In general, MSE walls, prefabricated modular gravity walls, and some rigid gravity walls are not appropriate for these situations. Walls that can be pile supported such as concrete semigravity cantilever walls, nongravity cantilever walls, and anchored walls are more appropriate for these situations.

## **(3) Feasible Wall and Slope Heights and Applications**

Feasible wall heights are affected by issues such as the capacity of the wall structural elements, past experience with a particular wall, current practice, seismic risk, long-term durability, and aesthetics.

See Table 1 for height limitations.

## **(4) Supporting Structures or Utilities**

Not all walls are acceptable to support other structures or utilities. Issues that must be considered include the potential for the wall to deform due to the structure foundation load, interference between the structure foundation and the wall components, and the potential long-term durability of the wall system. Using retaining walls to support other structures is considered to be a critical application, requiring a special design. In general, soil nail walls, semigravity cantilever walls, nongravity cantilever walls, and anchored walls are appropriate for use in supporting bridge and building structure foundations. In addition to these walls, MSE and prefabricated modular gravity walls may be used to support other retaining walls, noise walls, and minor structure foundations such as those for sign bridges and signals. On a project specific basis, MSE walls can be used to support bridge and building foundations, as approved by the Bridge and Structures Office.

Also consider the location of any utilities behind the wall or reinforced slope when making wall/slope selections. This is mainly an issue for walls that use some type of soil reinforcement and for reinforced slopes. It is best not to place utilities within a reinforced soil backfill zone because it would be impossible to access the utility from the ground surface without cutting through the soil reinforcement layers, thereby compromising the integrity of the wall.

Sometimes utilities, culverts, pipe arches, etc. must penetrate the face of a wall. Not all walls and facings are compatible with such penetrations. Consider how the facing can be formed

around the penetration so that backfill soil cannot pipe or erode through the face. Contact the Bridge and Structures Office for assistance regarding this issue.

### **(5) Facing Options**

Facing selection depends on the aesthetic and the structural needs of the wall system. Wall settlement may also affect the feasibility of the facing options. More than one wall facing may be available for a given system. The facing options available must be considered when selecting a particular wall.

For MSE walls, facing options typically include the following:

- Precast modular panels
- In some cases, full height precast concrete panels. (Full height panels are generally limited to walls with a maximum height of 20 ft placed in areas where minimal settlement is expected.)
- Welded wire facing
- Timber facing
- Shotcrete facing with various treatment options that vary from a simple broom finish to a textured and colored finish
- Segmental masonry concrete blocks
- Cast-in-place concrete facing with various texturing options.

Plantings on welded wire facings can be attempted in certain cases. The difficulty is in providing a soil at the wall face that is suitable for growing plants and meets engineering requirements in terms of soil compressibility, strength, and drainage. If plantings in the wall face are attempted, use only small plants, vines, and grasses. Small bushes could be considered for plantings between wall steps. Larger bushes or trees are not considered in these cases due to the loads on the wall face that they can create.

Geosynthetic facings are not acceptable for permanent facings due to potential facing degradation when exposed to sunlight. For permanent applications, geosynthetic walls must have some

type of timber, welded wire, or concrete face. (Shotcrete, masonry concrete blocks, cast-in-place concrete, welded wire, or timber are typically used for geosynthetic wall facings.)

Soil nail walls can use either architecturally treated shotcrete or a cast-in-place facia wall textured as needed to produce the desired appearance.

For prefabricated modular gravity walls, the facing generally consists of the structural bin or crib elements used to construct the walls. For some walls, the elements can be rearranged to form areas for plantings. In some cases, textured structural elements may also be feasible. This is also true of rigid gravity walls, though planting areas on the face of rigid gravity walls are generally not feasible. The concrete facing for semigravity cantilever walls can be textured as needed to produce the desired appearance.

For nongravity cantilevered walls and anchored walls, a textured cast-in-place or precast facia wall is usually installed to produce the desired appearance.

### **(6) Cost Considerations**

Usually, more than one wall type is feasible for a given situation. Consider cost throughout the selection process. Decisions in the selection process that may affect the overall cost might include the problem of whether to shut down a lane of traffic to install a low cost gravity wall system that requires more excavation room or to use a more expensive anchored wall system that would minimize excavation requirements and impacts to traffic. In this case, determine if the cost of traffic impacts and more excavation justifies the cost of the more expensive anchored wall system.

Decisions regarding aesthetics can also affect the overall cost of the wall system. In general, the least expensive aesthetic options use the structural members of the wall as facing (welded wire, concrete or steel cribbing or bins, for example), whereas the most expensive aesthetic options use textured cast-in-place concrete facias. In general, concrete facings increase in cost in the following order: shotcrete, segmental masonry concrete

blocks, precast concrete facing panels, full height precast concrete facing panels, and cast-in-place concrete facing panels. Special architectural treatment usually increases the cost of any of these facing systems. Special wall terracing to provide locations for plants will also tend to increase costs. Therefore, the value of the desired aesthetics must be weighed against costs.

Other factors that affect costs of wall/slope systems include wall/slope size and length, access at the site and distance to the material supplier location, overall size of the project, and competition between wall suppliers. In general, costs tend to be higher for walls or slopes that are high, but short in length, due to lack of room for equipment to work. Sites that are remote or have difficult local access increase wall/slope costs. Small wall/slope quantities result in high unit costs. Lack of competition between materials or wall system suppliers can result in higher costs as well.

Some of the factors that increase costs are required parts of a project and are, therefore, unavoidable. Always consider such factors when estimating costs because a requirement may not affect all wall types in the same way. Current cost information can be obtained by consulting the *Bridge Design Manual* or by contacting the Bridge and Structures Office.

### **(7) Summary**

For wall/slope selection, consider factors such as the intended application, the soil/rock conditions in terms of settlement, need for deep foundations, constructibility, impact to traffic, the overall geometry in terms of wall/slope height and length, location of adjacent structures and utilities, aesthetics, and cost. Table 1 provides a summary of many of the various wall/slope options available, including their advantages, disadvantages, and limitations. Note that specific wall types in the table may represent multiple wall systems, some or all of which may be proprietary.

## **1130.06 Design Responsibility and Process**

### **(1) General**

The retaining walls available for a given project include standard walls, nonstandard walls, and reinforced slopes.

Standard walls are those walls for which standard designs are provided in the WSDOT Standard Plans. Standard plans are provided for reinforced concrete cantilever walls up to 35 ft in height. The internal stability design, and the external stability design for overturning and sliding stability, have already been completed for these standard walls. However, overall slope stability and allowable soil bearing capacity (including settlement considerations) must be determined for each standard-design wall location.

Nonstandard walls may be either proprietary (patented or trademarked) or nonproprietary. Proprietary walls are designed by a wall manufacturer for internal and external stability, except bearing capacity, settlement, and overall slope stability which are determined by WSDOT. Nonstandard nonproprietary walls are fully designed by WSDOT.

The geosynthetic soil reinforcement used in nonstandard nonproprietary geosynthetic walls is considered to be proprietary. It is likely that more than one manufacturer can supply proprietary materials for a nonstandard nonproprietary geosynthetic wall.

Reinforced slopes are similar to nonstandard nonproprietary walls in terms of their design process.

Some proprietary wall systems are preapproved. Preapproved proprietary wall systems have been extensively reviewed by the Bridge and Structures Office and the Geotechnical Services Branch. Design procedures and wall details for preapproved walls have already been agreed upon between WSDOT and the proprietary wall manufacturers, allowing the manufacturers to competitively bid a particular project without having a detailed wall design provided in the contract plans.



Note that proprietary wall manufacturers may produce several retaining wall options, and not all options from a given manufacturer have necessarily been preapproved. For example, proprietary wall manufacturers often offer more than one facing alternative. It is possible that some facing alternatives are preapproved, whereas other facing alternatives are not preapproved. WSDOT does not preapprove the manufacturer, but specific wall systems by a given manufacturer can be preapproved.

It is imperative with preapproved systems that the design requirements for all preapproved wall alternatives for a given project be clearly stated so that the wall proprietor can adapt the preapproved system to specific project conditions. For a given project, coordination of the design of all wall alternatives with all project elements that impact the wall (such as drainage features, utilities, luminaires and sign structures, noise walls, traffic barriers, guardrails, or other walls or bridges) is critical to avoid costly change orders or delays during construction.

In general, standard walls are the easiest walls to incorporate into project plans, specifications, & estimate (PS&E), but they may not be the most cost effective option. Preapproved proprietary walls provide more options in terms of cost effectiveness and aesthetics and are also relatively easy to incorporate into a PS&E. Nonstandard state-designed walls and nonpreapproved proprietary walls generally take more time and effort to incorporate into a PS&E because a complete wall design must be developed. Some nonstandard walls (state-designed geosynthetic walls, for example) can be designed relatively quickly, require minimal plan preparation effort, and only involve the region and the Geotechnical Services Branch. Other nonstandard walls such as soil nail and anchored wall systems require complex designs, involve both the Bridge and Structures Office and the Geotechnical Services Branch, and require a significant number of plan sheets and considerable design effort.

The Bridge and Structures Office maintains a list of the proprietary retaining walls that are preapproved. The region should consult the

Bridge and Structures Office for the latest list. The region should consult the Geotechnical Services Branch for the latest geosynthetic reinforcement list to determine which geosynthetic products are acceptable if a critical geosynthetic wall or reinforced slope application is anticipated.

Some proprietary retaining wall systems are classified as experimental by the FHWA. The Bridge and Structures Office maintains a list of walls that are classified as experimental. If the wall intended for use is classified as experimental, a work plan must be prepared by WSDOT and approved by the FHWA.

Gabion walls are nonstandard walls that must be designed for overturning, sliding, overall slope stability, settlement, and bearing capacity. A full design for gabion walls is not provided in the Standard Plans. Gabion baskets are typically 3 ft high by 3 ft wide, and it is typically safe to build gabions two baskets high (6 ft) but only one basket deep, resulting in a wall base width of 50 percent of the wall height, provided soil conditions are reasonably good (medium dense to dense granular soils are present below and behind the wall).

## **(2) Responsibility and Process for Design**

A flow chart illustrating the process and responsibility for retaining wall/reinforced slope design is provided in Figure 1130-4. As shown in the figure, the region initiates the process, except for walls developed as part of a preliminary bridge plan. These are initiated by the Bridge and Structures Office. In general, it is the responsibility of the design office initiating the design process to coordinate with other groups in the department to identify all wall/slope systems that are appropriate for the project in question. Coordination between the region, Bridge and Structures Office, Geotechnical Services Branch, and the Principle Architect should occur as early in the process as possible.

OSC or region consultants, if used, are considered an extension of the OSC staff and must follow the process summarized in Figure 1130-4.

All consultant designs, from development of the scope of work to the final product, must be reviewed and approved by the appropriate OSC offices.

**(a) Standard Walls.** The regions are responsible for detailing retaining walls for which standard designs are available.

For standard walls greater than 10 ft in height, and for all standard walls where soft or unstable soil is present beneath or behind the wall, a geotechnical investigation must be conducted, or reviewed and approved, by the Geotechnical Services Branch. Through this investigation, provide the foundation design including bearing capacity requirements and settlement determination, overall stability, and the selection of the wall types most feasible for the site.

For standard walls 10 ft in height or less where soft or unstable soils are not present, it is the responsibility of the region materials laboratory to perform the geotechnical investigation. If it has been verified that soil conditions are adequate for the proposed standard wall that is less than or equal to 10 ft in height, the region establishes the wall footing location based on the embedment criteria in the *Bridge Design Manual*, or places the bottom of the wall footing below any surficial loose soils. During this process, the region also evaluates other wall types that may be feasible for the site in question.

Figure 1130-5 provides design charts for standard reinforced concrete cantilever walls. These design charts, in combination with the Standard Plans, are used to size the walls and determine the applied bearing stresses to compare with the allowable soil bearing capacity determined from the geotechnical investigation. The charts provide two sets of bearing pressures: one for static loads, and one for earthquake loads. Allowable soil bearing capacity for both the static load case and the earthquake load case can be obtained from the Geotechnical Services Branch for standard walls over 10 ft in height and from the region materials laboratories for standard walls less than or equal to 10 ft in height. If the allowable soil bearing capacity exceeds the values provided in

Figure 1130-5, the Standard Plans can be used for the wall design. If one or both of the allowable soil bearing capacities does not exceed the values provided in Figure 1130-5, the Standard Plans cannot be used for wall design and the Bridge and Structures Office must be contacted for a nonstandard wall design.

If the standard wall must support surcharge loads from bridge or building foundations, other retaining walls, noise walls, or other types of surcharge loads, a special wall design is required. The wall is considered to be supporting the surcharge load and is treated as a nonstandard wall if the surcharge load is located within a 1H:1V slope projected up from the bottom of the back of the wall. Contact the Bridge and Structures Office for assistance.

The Standard Plans provide six types of reinforced concrete cantilever walls (which represent six loading cases). Reinforced concrete retaining wall Types 5 and 6 are not designed to withstand earthquake forces and are not used in Western Washington (west of the Cascade crest).

Once the geotechnical and architectural assessment have been completed, the region completes the PS&E for the standard wall option(s) selected including a generalized wall profile and plan, a typical cross-section as appropriate, details for desired wall appurtenances, drainage details, and other details as needed.

Metal bin walls, Types 1 and 2, have been deleted from the Standard Plans and are therefore no longer standard walls. Metal bin walls are seldom used due to cost and undesirable aesthetics. If this type of wall is proposed, contact the Bridge and Structures Office for plan details and toe bearing pressures. The applied toe bearing pressure would then have to be evaluated by the Geotechnical Services Branch to determine if the site soil conditions are appropriate for the applied load and anticipated settlement.

**(b) Preapproved Proprietary Walls.** Final design approval of preapproved proprietary walls, with the exception of geosynthetic walls, is the responsibility of the Bridge and Structures Office. Final approval of the design of preapproved

proprietary geosynthetic walls is the responsibility of the Geotechnical Services Branch. It is the region's responsibility to coordinate the design effort for all preapproved wall systems.

The region materials laboratory performs the geotechnical investigation for preapproved proprietary walls 10 ft in height or less that are not bearing on soft or unstable soils. In all other cases, it is the responsibility of the Geotechnical Services Branch to conduct, or review and approve, the geotechnical investigation for the wall. The region also coordinates with the Principal Architect to ensure that the wall options selected meet the aesthetic requirements for the site.

Once the geotechnical and architectural assessments have been completed and the desired wall alternatives selected, it is the responsibility of the region to contact the suppliers of the selected preapproved systems to confirm in writing the adequacy and availability of the systems for the proposed use.

A minimum of three different wall systems must be included in the PS&E for any project with federal participation that includes a proprietary wall system unless specific justification is provided. Standard walls can be alternatives.

Once confirmation of adequacy and availability has been received, the region contacts the Bridge and Structures Office for special provisions for the selected wall systems and proceeds to finalize the contract PS&E in accordance with the *Plans Preparation Manual*. Provide the allowable bearing capacity and foundation embedment criteria for the wall, as well as backfill and foundation soil properties, in the special provisions. In general, assume that Gravel Borrow or better quality backfill material will be used for the walls when assessing soil parameters.

Complete wall plans and designs for the proprietary wall options will not be developed until after the contract is awarded, but will be developed by the proprietary wall supplier as shop drawings after the contract is awarded. Therefore, include a general wall plan, a profile showing

neat line top and bottom of the wall, a final ground line in front of and in back of the wall, a typical cross-section, and the generic details for the desired appurtenances and drainage requirements in the contract PS&E for the proprietary walls. Estimate the ground line in back of the wall based on a nominal 1.5 ft facing thickness (and state this on the wall plan sheets). Include load or other design acceptance requirements for these appurtenances in the PS&E. Contact the Bridge and Structures Office for assistance regarding this.

It is best to locate catch basins, grate inlets, signal foundations, and the like outside the reinforced backfill zone of MSE walls to avoid interference with the soil reinforcement. In those cases where conflict with these reinforcement obstructions cannot be avoided, the location(s) and dimensions of the reinforcement obstruction(s) relative to the wall must be clearly indicated on the plans. Contact the Bridge and Structures Office for preapproved wall details and designs for size and location of obstructions, and to obtain the generic details that must be provided in the plans. If the obstruction is too large or too close to the wall face, a special design may be required to accommodate the obstruction, and the wall is treated as a nonpreapproved proprietary wall.

A special design is required if the wall must support structure foundations, other retaining walls, noise walls, signs or sign bridges, luminaires, or other types of surcharge loads. The wall is considered to be supporting the surcharge load if the surcharge is located within a 1H:1V slope projected from the bottom of the back of the wall. For MSE walls, the back of the wall is considered to be the back of the soil reinforcement layers. If this situation occurs, the wall is treated as a nonpreapproved proprietary wall.

For those alternative wall systems that have the same face embedment criteria, the wall face quantities depicted in the plans for each alternative must be identical. To provide an equal basis for competition, the region determines wall face quantities based on neat lines.

Once the detailed wall plans and designs are available as shop drawings after contract award, the Bridge and Structures Office will review and approve the wall shop drawings and calculations, with the exception of geosynthetic walls which are reviewed and approved by the Geotechnical Services Branch.

**(c) Nonpreapproved Proprietary Walls.** Final design approval authority for nonpreapproved proprietary walls is the same as for preapproved proprietary walls. The region initiates the design effort for all nonpreapproved wall systems by submitting wall plan, profile, cross-section, and other information for the proposed wall to the Bridge and Structures Office, with copies to the Geotechnical Services Branch and the Principal Architect. The Bridge and Structures Office coordinates the wall design effort.

Once the geotechnical and architectural assessments have been completed and the desired wall types selected, the Bridge and Structures Office contacts suppliers of the nonpreapproved wall systems selected to obtain and review detailed wall designs and plans to be included in the contract PS&E.

To ensure fair competition between all wall alternatives included in the PS&E, the wall face quantities for those wall systems subject to the same face embedment requirements should be identical.

The Bridge and Structures Office develops the special provisions and cost estimates for the nonpreapproved proprietary walls and sends the wall PS&E to the region for inclusion in the final PS&E in accordance with the *Plans Preparation Manual*.

**(d) Nonstandard Nonproprietary Walls.** With the exception of rockeries over 5 ft high, nonproprietary geosynthetic walls and reinforced slopes, and soil nail walls, the Bridge and Structures Office coordinates with the Geotechnical Services Branch and the Principal Architect to carry out the design of all nonstandard, nonproprietary walls. In this case, the Bridge and Structures Office develops the wall preliminary plan from site data provided by the region,

completes the wall design, and develops the nonstandard nonproprietary wall PS&E package for inclusion in the contract.

For rockeries over 5 ft high, nonproprietary geosynthetic walls and reinforced slopes, and soil nail walls, the region develops wall/slope profiles, plans, and cross-sections and submits them to the Geotechnical Services Branch to complete a detailed wall/slope design.

For geosynthetic walls and slopes, and for rockeries, the region provides overall coordination of the wall/slope design effort, including coordination with the Principal Architect regarding aesthetics and finishes, and the Region or OSC Landscape Architect if the wall uses vegetation on the face. The Geotechnical Services Branch has overall design approval authority. Once the wall design has been completed, the Geotechnical Services Branch, and in some cases the Bridge and Structures Office, provides geotechnical and structural plan details to be included in the region plan sheets and special provisions for the PS&E. The region then completes the PS&E package.

For soil nail walls, once the Geotechnical Services Branch has performed the geotechnical design, the Bridge and Structures Office, in cooperation with the Geotechnical Services Branch, coordinates the design effort and completes the PS&E package.

### **(3) Guidelines for Wall/Slope Data Submission for Design**

**(a) Standard Walls, Proprietary Walls, Geosynthetic Walls/Slopes, and Soil Nail Walls.** Where OSC involvement in retaining wall/slope design is required (as for standard walls and preapproved proprietary walls over 10 ft in height, gabions over 6 ft in height, rockeries over 5 ft in height, all nonpreapproved proprietary walls, geosynthetic walls/slopes, and all soil nail walls), the region submits the following information to the Geotechnical Services Branch or Bridge and Structures Office as appropriate:

- Wall/slope plans.
- Profiles showing the existing and final grades in front of and behind the wall.

- Wall/slope cross-sections (typically every 50 ft) or CAiCE files that define the existing and new ground-line above and below the wall/slope and show stations and offsets.
- Location of right of way lines as well as other constraints to wall/slope construction.
- Location of adjacent existing and/or proposed structures, utilities, and obstructions.
- Desired aesthetics.
- Date design must be completed.
- Key region contacts for the project.

Note that it is best to base existing ground measurements, for the purpose of defining the final wall geometry, on physical survey data rather than solely on photogrammetry. In addition, the region must complete a Retaining Wall/Reinforced Slope Site Data Check List, DOT Form 351-009 EF, for each wall or group of walls submitted.

**(b) Nonstandard Walls, Except Geosynthetic Walls/Slopes and Soil Nail Walls.** In this case, the region must submit site data in accordance with Chapter 1110. Additionally, a Retaining Wall Site Data Check List, DOT361-009EF, for each wall or group of walls must be completed by the region.

### **1130.07 Documentation**

The following documents are to be preserved in the project file. See Chapter 330.

- Wall Site Data Check List, DOT361-009EF, and attachments
- Final selection approval

P65:DP/DME

<b>Specific Wall Type</b>	<b>Advantages</b>	<b>Disadvantages</b>	<b>Limitations</b>
Steel soil reinforcement with full height precast concrete panels	Relatively low cost	Can tolerate little settlement; generally requires high quality backfill; wide base width required (70% of wall height)	Applicable primarily to fill situations; maximum feasible height is approximately 20 ft
Steel soil reinforcement with modular precast concrete panels	Relatively low cost; flexible enough to handle significant settlement	Generally requires high quality backfill; wide base width required (70% of wall height)	Applicable primarily to fill situations; maximum height of 33 ft; heights over 33 ft require a special design
Steel soil reinforcement with welded wire and cast in place concrete face	Can tolerate large short-term settlements	Relatively high cost; cannot tolerate long-term settlement; generally requires high quality wall backfill soil; wide base width required (70% of wall height); typically requires a settlement delay period during construction	Applicable primarily to fill situations; maximum height of 33 ft for routine designs; heights over 33 ft require a special design
Steel soil reinforcement with welded wire face only	Can tolerate large long-term settlements; low cost	Aesthetics, unless face plantings can be established; generally requires high quality backfill; wide base width required (70% of wall ht.)	Applicable primarily to fill situations; maximum height of 33 ft for routine designs; heights over 33 ft require a special design

**Table 1(a).**  
**Summary of mechanically stabilized earth (MSE) gravity wall/slope options available.**

<b>Specific Wall Type</b>	<b>Advantages</b>	<b>Disadvantages</b>	<b>Limitations</b>
Segmental masonry concrete block faced walls, generally with geosynthetic soil reinforcement	Low cost; flexible enough to handle significant settlements	Internal wall deformations may be greater than for steel reinforced systems but are still acceptable for most applications; generally requires high quality backfill; wide base width required (70% of wall height)	Applicable primarily to fill situations; in general, limited to wall height of 20 ft or less; greater wall heights may be feasible by special design in areas of low seismic activity and when geosynthetic products are used in which long-term product durability is well defined (see Qualified Products List).
Geosynthetic walls with a shotcrete or cast in place concrete face	Very low cost, esp. with shotcrete face; can tolerate large short-term settlements	Internal wall deformations may be greater than for steel reinforced systems but are still acceptable for most applications; generally requires high quality backfill; wide base width required (70% of wall height)	Applicable primarily to fill situations; in general, limited to wall height of 20 ft or less unless using geosynthetic products in which long-term product durability is well defined (see Qualified Products List). For qualified products, heights of 33 ft or more are possible.
Geosynthetic walls with a welded wire face	Very low cost; can tolerate large long-term settlements	Internal wall deformations may be greater than for steel reinforced systems but are still acceptable for most applications; generally requires high quality wall backfill soil; wide base width required (70% of wall height)	Applicable primarily to fill situations; in general, limited to wall height of 20 ft or less unless using geosynthetic products in which long-term product durability is well defined (see Qualified Products List). For qualified products, heights of 33 ft or more are possible.

**Table 1(a), continued.**

<b>Specific Wall Type</b>	<b>Advantages</b>	<b>Disadvantages</b>	<b>Limitations</b>
Geosynthetic walls with a geosynthetic face	Lowest cost of all wall options; can tolerate large long-term settlements	Internal wall deformations may be greater than for steel reinforced systems but are still acceptable for most applications; generally requires high quality backfill; wide base width required (70% of wall height); durability of wall facing	Applicable primarily to fill situations; use only for temporary applications due to durability of facing; can be designed for wall heights of 40 ft or more
Soil nail walls	Relatively low cost; can be used in areas of restricted overhead or lateral clearance	Soil/rock must have adequate standup time to stand in a vertical cut approximately 6 ft high for at least 1 to 2 days; not feasible for bouldery soils; may require an easement for the nails	Applicable to cut situations only; not recommended in clean or water bearing sands and gravels, in bouldery soils which could interfere with nail installation, or in landslide deposits, esp. where deep potential failure surfaces are present; maximum wall heights of 35 ft are feasible, though greater wall heights are possible in excellent soil/rock conditions. A special design is always required.

**Table 1(a), continued.**



<b>Specific Wall Type</b>	<b>Advantages</b>	<b>Disadvantages</b>	<b>Limitations</b>
Concrete crib walls	Relatively low cost; quantity of high quality backfill required relatively small; relatively narrow base width, on the order of 50% to 60% of the wall height; can tolerate moderate settlements	Aesthetics	Applicable to cut and fill situations; reinforced concrete can typically be designed for heights of up to 33 ft and unreinforced concrete up to 16 ft; not used to support bridge or building foundations
Metal crib walls	Quantity of high quality backfill required relatively small; relatively narrow base width, on the order of 50% to 60% of the wall height; can tolerate mod. settlements	Relatively high cost; aesthetics	Applicable to cut and fill situations; can be designed routinely for heights up to 35 ft; not used to support bridge or building foundations
Timber crib walls	Low cost; minimal high quality backfill required; relatively narrow base width, on the order of 50% to 60% of the wall height; can tolerate moderate settlements	Design life relatively short, aesthetics	Applicable to cut and fill situations; can be designed for heights up to 16 ft; not used to support structure foundations
Concrete bin walls	Relatively low cost; narrow base width, on the order of 50 to 60% of the wall height; can tolerate moderate settlements	Aesthetics	Applicable to cut and fill situations; can be designed routinely for heights up to 25 ft; not used to support bridge or building foundations
Gabion walls	Relatively narrow base width, on the order of 50 to 60% of the wall height; can tolerate moderate settlements	Relatively high cost, depending on proximity to source of high quality angular rock to fill baskets	Applicable to cut and fill situations; can be designed routinely for heights up to 15 ft, and by special design up to 21 ft; not used to support structure foundations

**Table 1(b). Summary of prefabricated modular gravity wall options available.**

<b>Specific Wall Type</b>	<b>Advantages</b>	<b>Disadvantages</b>	<b>Limitations</b>
Mortar rubble masonry walls	Quantity of high quality backfill required is relatively small	High cost; relatively wide base width, on the order of 60% to 70% of the wall height; cannot tolerate settlement	Applicable mainly to fill situations where foundation conditions consist of very dense soil or rock; due to expense, only used in areas where other mortar rubble masonry walls are present and it is desired to match aesthetics; typically, can be designed for maximum heights of 25 ft
Unreinforced concrete gravity walls	Quantity of high quality backfill required is relatively small	High cost; relatively wide base width, on the order of 60% to 70% of the wall height; cannot tolerate settlement	Applicable mainly to fill situations where foundation conditions consist of very dense soil or rock; due to expense, only used in areas where other concrete gravity walls are present and it is desired to match aesthetics; typically, can be designed for maximum heights of 25 ft
Reinforced concrete cantilever walls	Relatively narrow base width on the order of 50 % to 60 % of the wall height; can be used to support structure foundations by special design	High cost; cannot tolerate much settlement; relatively deep embedment could be required on sloping ground due to toe in front of wall face	Applicable to cut and fill situations; can be routinely designed for heights up to 35 ft
Reinforced concrete counterfort walls	Relatively narrow base width on the order of 50 % to 60 % of the wall height; can be used to support structure foundations by special design	High cost; cannot tolerate much settlement; relatively deep embedment could be required on sloping ground due to toe in front of wall face	Applicable to cut and fill situations; can be routinely designed for heights up to 50 ft; proprietary versions typically 33 ft max

**Table 1(c). Summary of rigid gravity and semigravity wall options available.**

<b>Specific Wall Type</b>	<b>Advantages</b>	<b>Disadvantages</b>	<b>Limitations</b>
Soldier pile wall	Very narrow base width; deep embedment to get below potential failure surfaces relatively easy to obtain	Relatively high cost	Applicable mainly to cut situations; maximum feasible exposed height is on the order of 10 ft; difficult to install in bouldery soil or soil with water bearing sands
Sheet pile wall	Low to moderate cost; very narrow base width	Difficult to get embedment in dense or bouldery soils; difficult to protect against corrosion	Applicable mainly to cut situations in soil; maximum feasible exposed height is on the order of 10 ft
Cylinder pile wall	Relatively narrow base width; can produce stable wall even if deep potential failure surfaces present	Very high cost	Applicable mainly to cut situations; max. feasible exposed height is on the order of 20 to 25 ft, depending on passive resistance available; can be installed in bouldery conditions, though cost will increase
Slurry wall	Relatively narrow base width; can produce stable wall even if deep potential failure surfaces present	Very high cost; difficult construction	Applicable mainly to cut situations; maximum feasible exposed ht. is on the order of 20 to 25 ft, depending on passive resistance available

**Table 1(d). Summary of nongravity wall options available.**

<b>Specific Wall Type</b>	<b>Advantages</b>	<b>Disadvantages</b>	<b>Limitations</b>
All nongravity cantilever walls with tiebacks	Relatively narrow base width; can produce stable wall even if deep potential failure surfaces present	Very high cost; difficult to install in areas where vertical or lateral clearance is limited; easements may be necessary; installation activities may impact adjacent traffic	Applicable only to cut situations; can be designed for heights of 50 ft or more depending on the specifics of the structure of the wall
All nongravity cantilever walls with deadman anchors	Relatively narrow base width; can produce stable wall even if deep potential failure surfaces present	Moderate to high cost; must have access behind wall to dig trench for deadman anchor; may impact traffic during deadman installation; easements may be necessary	Applicable to partial cut/fill situations; can be designed for wall heights of approximately 16 ft

**Table 1(e). Summary of anchored wall options available.**

<b>Wall/Slope Classification</b>	<b>Specific Wall Type</b>	<b>Advantages</b>	<b>Disadvantages</b>	<b>Limitations</b>
Rockerries	Only variations are in rock sizes used and overall wall dimensions	Low cost; narrow base width on the order of 30% of the wall ht. required	Slope must be at least marginally stable without rockery present; cannot tolerate much settlement	Applicable to both cut and fill situations; max. feasible ht. in a cut even for excellent soil conditions is approx. 16 ft and 8 ft in fill situations
Reinforced slopes	Only variations are in geosynthetic products used and in erosion control techniques used on slope face	Low cost; can tolerate large settlements; can adapt well to sloping ground conditions to minimize excavation required; high quality fill is not a requirement	Must have enough room between the right of way line and the edge of the shoulder to install a 1H:1V slope	Best suited to sloping fill situations; max. height limited to 30 ft unless geosynthetic products are used in which long-term product durability is well defined. Certain products can be used in critical applications and for greater slope heights on the order of 60 ft or more but consider need, landscaping maintenance, and the reach of available maintenance equipment.

**Table 1(f). Other wall/slope options available.**

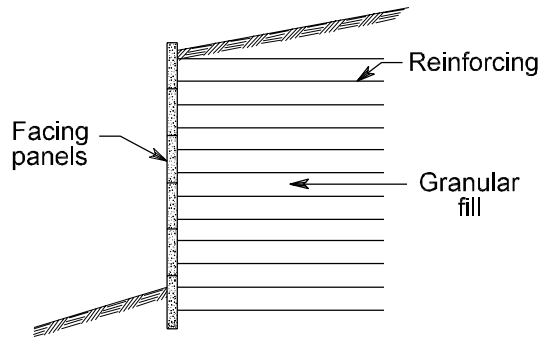

MSE Wall with Modular Precast Concrete Facing Panels

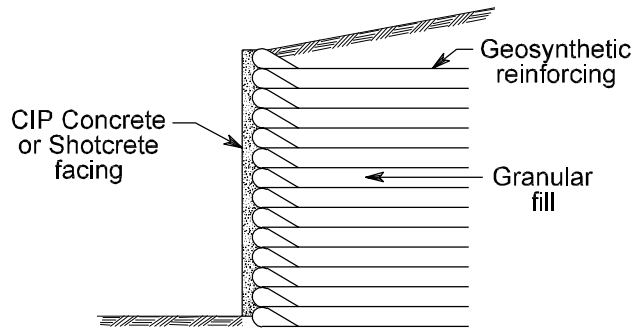

MSE Wall with Geosynthetic Reinforcement and CIP Concrete or Shotcrete Facing

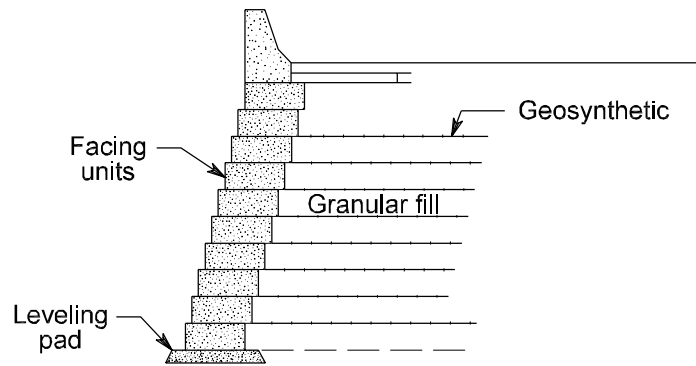

MSE Wall with Segmental Concrete Block Facing

**Typical Mechanically Stabilized Earth Gravity Walls**

*Figure 1130-1a*

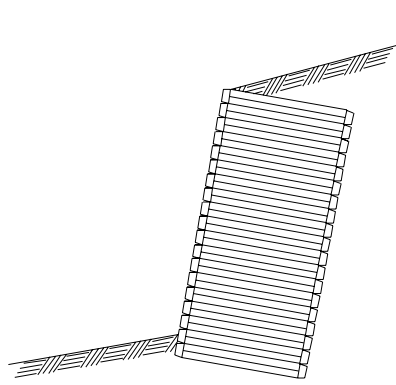

Metal Bin Wall

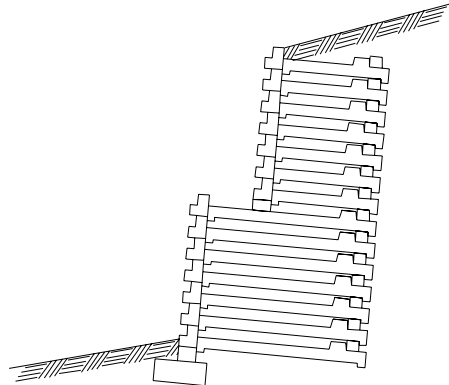

Precast Concrete Crib Wall

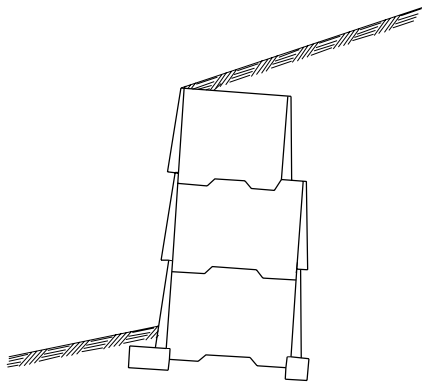

Precast Concrete Bin Wall

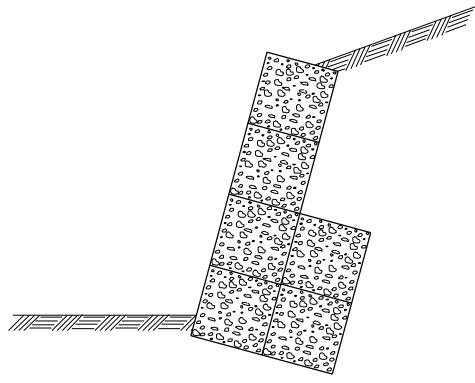

Gabion Wall

**Typical Prefabricated Modular Gravity Walls**  
*Figure 1130-1b*

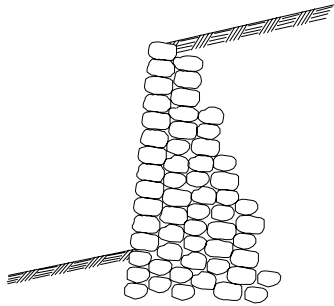

Mortar Rubble Masonry  
Rigid Gravity Wall

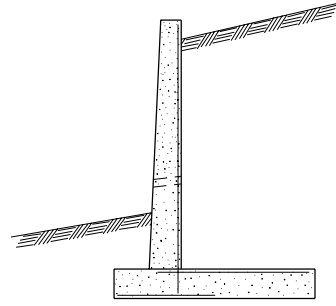

Reinforced Concrete Cantilever  
Semigravity Wall

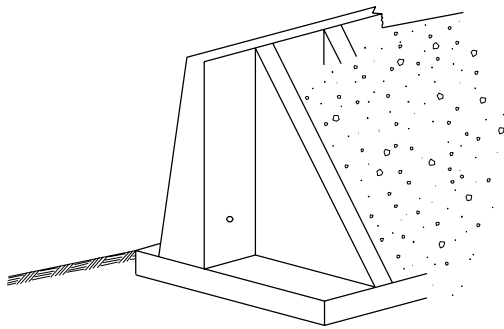

Reinforced Concrete Counterfort  
Semigravity Wall

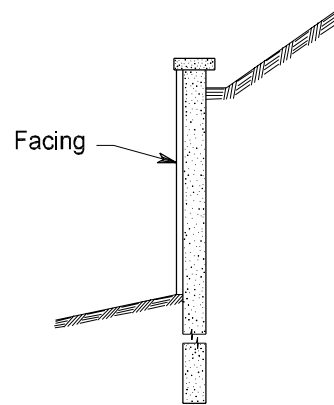

Slurry or Cylinder Pile  
Nongravity Cantilever Wall

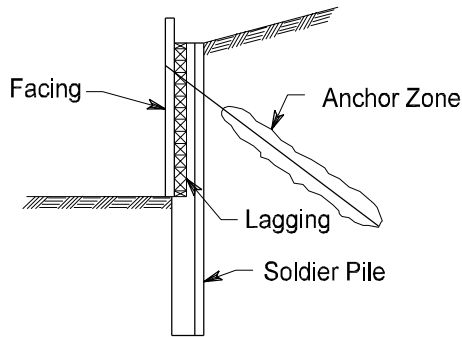

Soldier Pile Tieback Wall

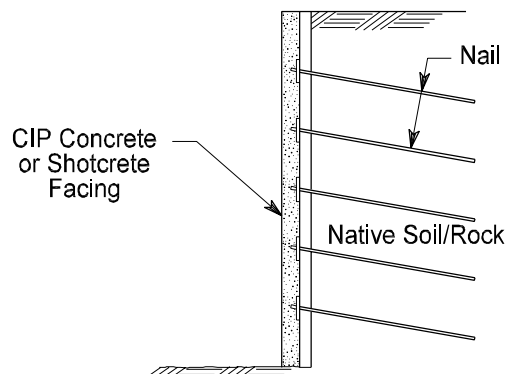

Soil Nail Wall  
in Cut

**Typical Rigid Gravity, Semigravity Cantilever,  
Nongravity Cantilever, and Anchored Walls**

*Figure 1130-1c*



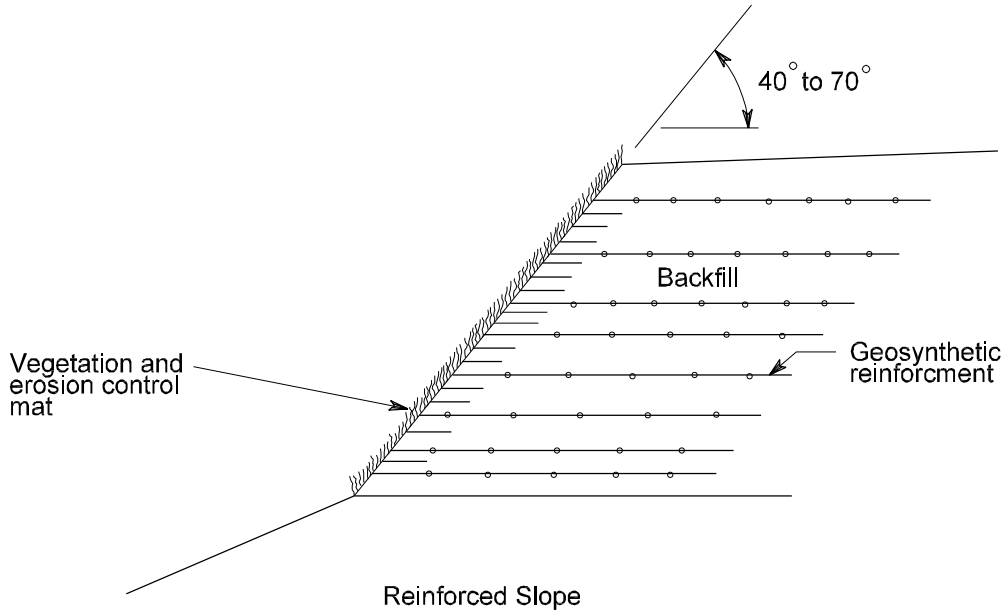
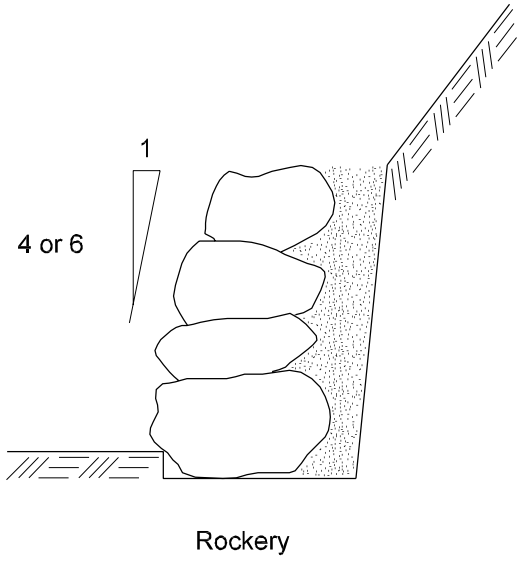

**Typical Rockery and Reinforced Slope**  
*Figure 1130-1d*

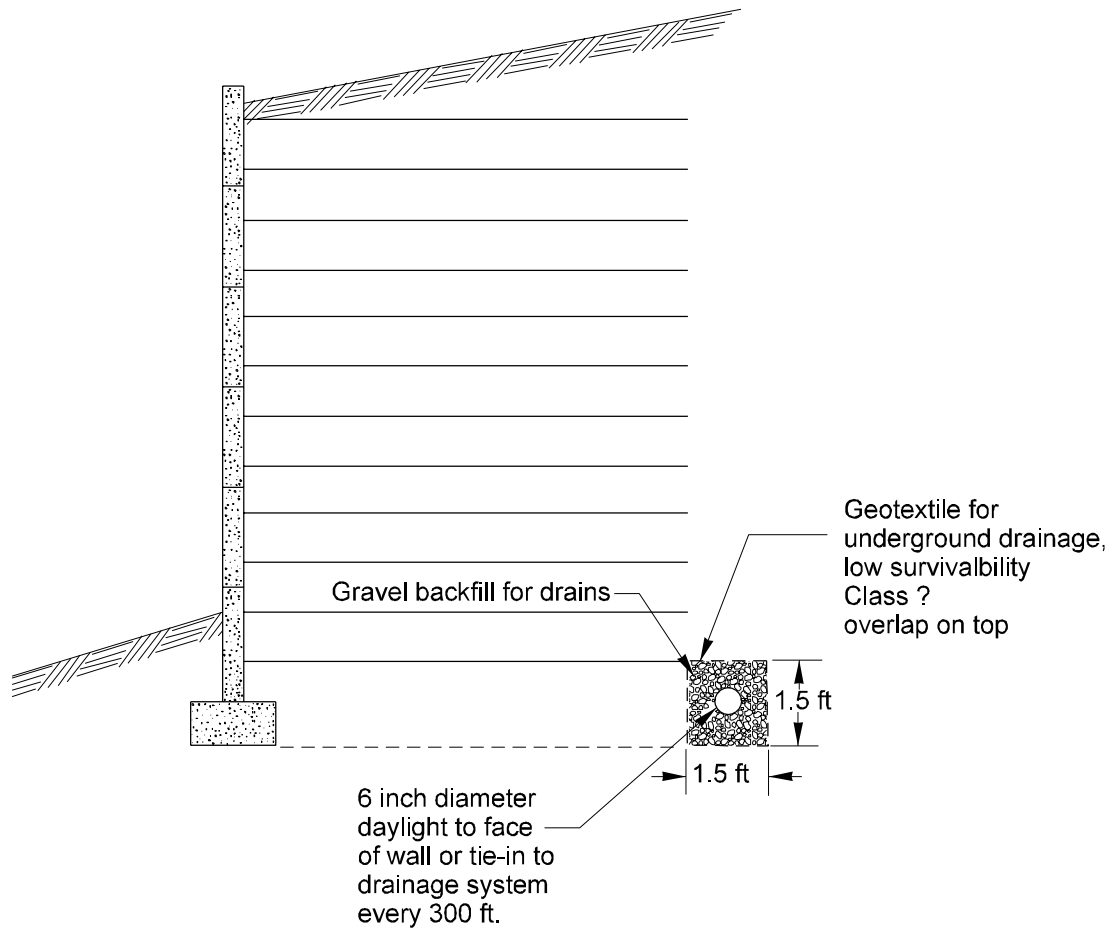

**MSE Wall Drainage Detail**  
*Figure 1130-2*

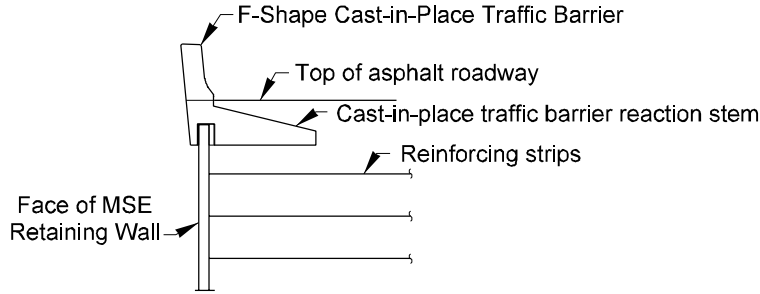

**Concrete Traffic Barrier with Concrete Roadway**

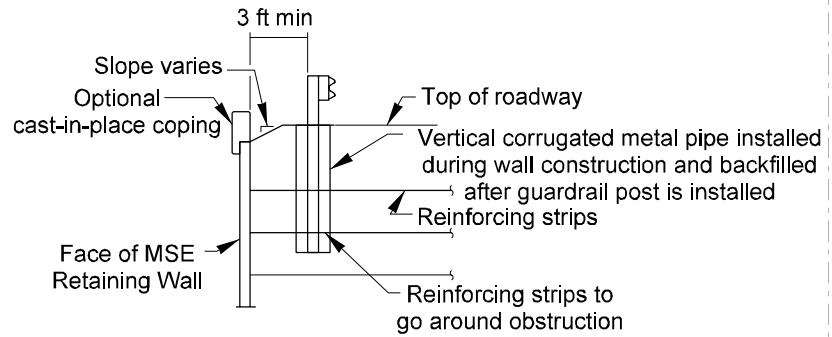

**Beam Guardrail on Top of MSE Retaining Wall**

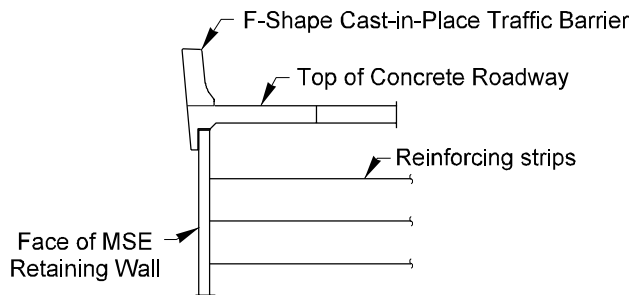

**Concrete Traffic Barrier with Concrete Roadway**

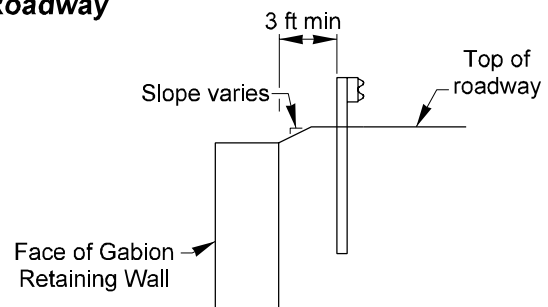

**Beam Guardrail on Top of Gabion Wall**

**Retaining Walls with Traffic Barriers**

*Figure 1130-3*

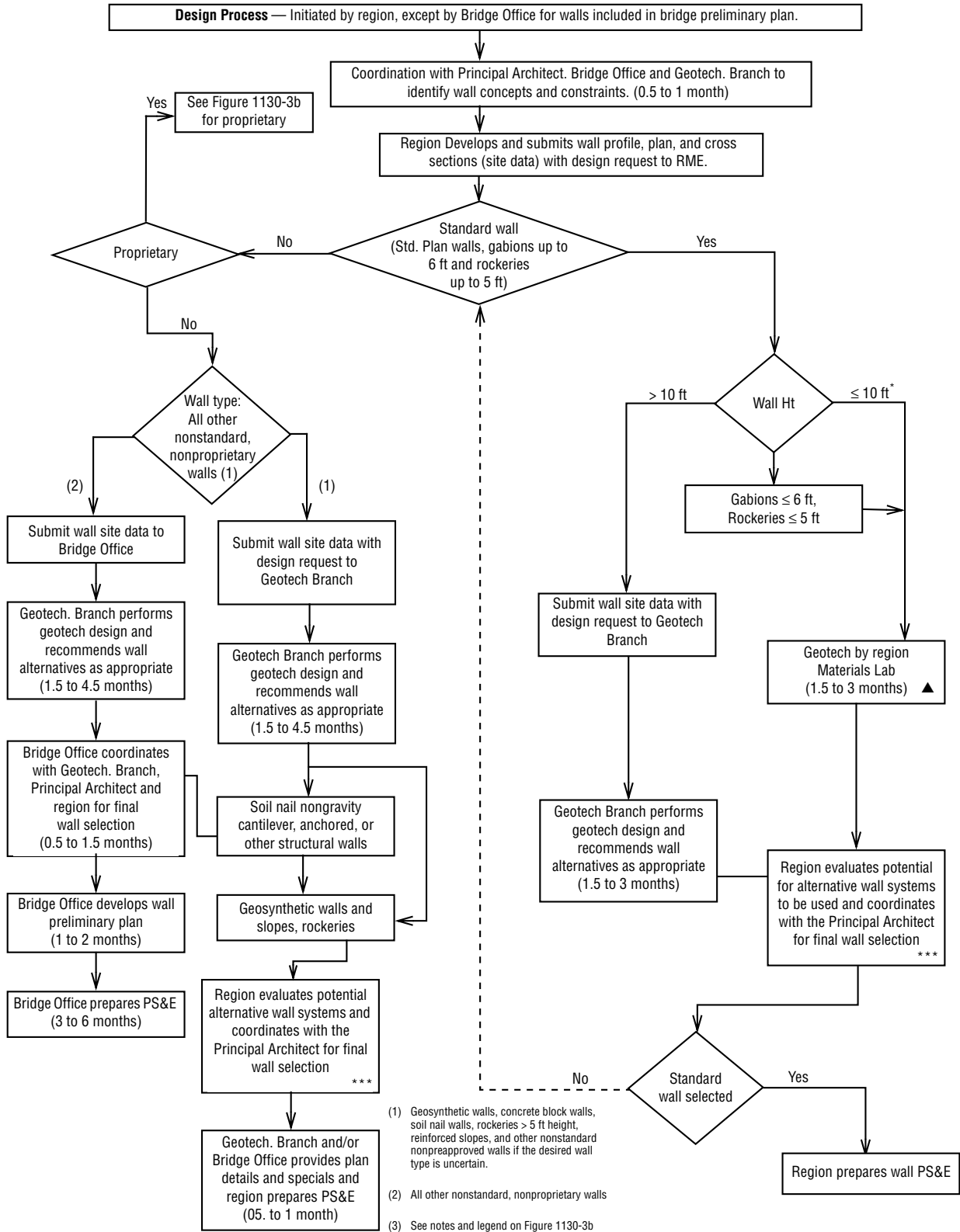

**Retaining Wall Design Process**  
Figure 1130-4a

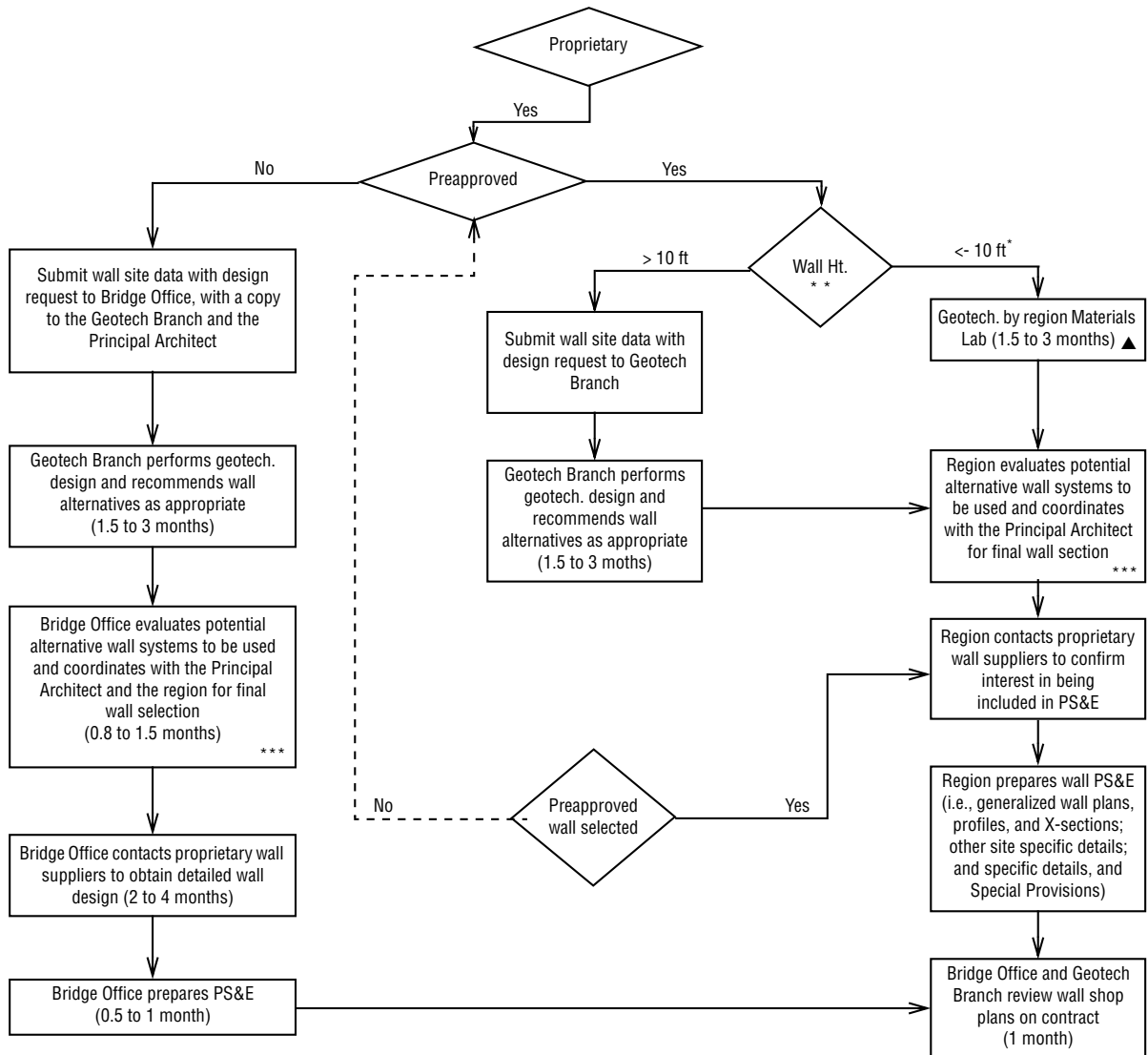

**Notes:**

The "Bridge Office" refers to the WSDOT Bridge and Structures Office in the Olympia Service Center.  
 The "Geotech Branch" refers to the WSDOT Geotechnical Services Branch in the Olympia Service Center.  
 The "Principal Architect" refers to the WSDOT Architecture Section of the Bridge and Structures Office in the Olympia Service Center.

**Regarding time estimates:**

- Assumes no major changes in the wall scope during design.
- Actual times may vary depending on complexity of project.
- Contact appropriate design offices for more accurate estimates of time.

**Legend:**

- ▲ Region provides courtesy copy of region geotech report to geotech services.
- \* Assumes soft or unstable soil not present and wall does not support other structures.
- \*\* The preapproved maximum wall height is generally 33 ft. Some proprietary walls may be less. (Check with the Bridge and Structures Office.)
- \*\*\* If the final wall selected is a different type than assumed, go back through the design process to ensure all steps have been taken.

**Retaining Wall Design Process - Proprietary**

*Figure 1130-4b*

Ht (ft)	Maximum Soil Pressure (psf) for Reinforced Concrete Retaining Walls											
	Type 1 ①		Type 2 ②		Type 3 ③		Type 4 ④		Type 5 ③		Type 6 ④	
	Static	Earth-quake	Static	Earth-quake	Static	Earth-quake	Static	Earth-quake	Static	Earth-quake	Static	Earth-quake
5	1611	781	1607	770	630	1033	641	1115	702	971	611	798
6	1838	976	1842	974	705	1254	865	1661	908	1322	746	1141
7	1876	1137	1891	1150	797	1558	882	1904	1179	1782	882	1420
8	2178	1431	2213	1465	995	2047	1025	2323	1510	2419	1246	2091
9	2255	1646	2305	1703	1104	2402	1040	2473	1632	2666	1587	2692
10	2492	2078	2492	2063	1216	2786	1065	2651	1924	3224	1635	2918
11	2693	2474	2713	2482	1197	2787	1174	2907	2046	3475	1795	3233
12	2643	2666	2682	2702	1308	3172	1277	3351	2345	4063	1873	3282
13	2732	2999	2693	2923	1458	3560	1304	3158	2384	4041	1955	3377
14	2972	3508	3065	3624	1539	3790	1444	3643	2683	4611	2269	3941
15	3100	3886	3358	4281	1620	4019	1645	4205	2766	4664	2349	4036
16	3166	4128	3420	4552	1752	4305	1748	4466	2818	4715	2668	4603
17	3247	4372	3472	4795	1833	4534	1849	4723	3149	5293	2846	4927
18	3301	4577	3559	5067	2104	5223	2072	5246	3373	5625	2924	5021
19	3399	4825	3405	4877	2217	5457	2208	5534	3691	6417	3175	5551
20	3570	5205	3724	5585	2461	5983	2312	5822	3685	6422	3405	6103
21	3677	5453	3617	5423	2507	6197	2478	6111	3650	6403	3556	6406
22	3752	5659	3696	5664	2635	6473	2610	6547	3778	6672	3737	6741
23	3866	5910	3810	5939	2715	6693	2650	6729	4110	7280	3889	7046
24	4049	6294	3912	6180	2844	6972	2785	7071	4159	7293	4071	7383
25	4166	6544	4058	6457	2973	7252	2949	7462	4492	7894	4228	7689
26	4250	6752	4172	6698	3103	7532	3047	7711	4664	8241	4410	8031
27	4372	7004	4318	6976	3265	7986	3093	7928	4786	8507	4391	8040
28	4496	7258	4463	7254	3394	8264	3106	8115	4956	8832	4575	8385
29	4621	7512	4609	7533	3524	8544	3241	8402	4920	8819	4724	8693
30	4666	7480	4535	7371	3653	8824	3376	8690	4892	8824	4752	8760
31	4795	7734	4682	7648	3816	9280	3536	9130	5068	9158	4901	9068
32	4924	7988	4828	7926			3707	9422	5194	9433	5088	9415
33	5055	8244	4975	8204			3872	9901	5293	9513	5263	9723
34	5186	8500	5122	8483					5328	9603	5191	9536
35	5318	8757	5269	8763					5456	9877	5378	9880

**Notes**

- ① 2 ft surcharge or traffic barrier with vertical front face.
- ② 2 ft surcharge or traffic barrier with sloping front face.
- ③ 2H:V1 backslope with vertical front face.
- ④ 2H:1V backslope with sloping front face.

**Retaining Wall Bearing Pressure**  
*Figure 1130-5*

- 1140.01 General
- 1140.02 References
- 1140.03 Design
- 1140.04 Procedures
- 1140.05 Documentation

### 1140.01 General

The function of a noise barrier is to reduce traffic noise levels at adjoining areas. The noise abatement decisions are made during the environmental stage of the project development process. This is a highly interactive process. Before a noise barrier is designed, the department must be confident that there is significant need, a cost effective and environmentally acceptable noise barrier, a source of funds, and acceptance by adjacent property owners, local governmental agencies, and the general public.

The designer will find the following preliminary design information in the noise report:

- Sources of noise
- Noise receiver locations
- Predicted level of noise reduction
- Locations of existing and future noise impacts along the project corridor
- Barrier location and height recommendations based on what is feasible and reasonable

Design of a noise barrier project is the result of a team effort coordinated by the project engineer.

This chapter addresses the factors that are considered when designing a noise barrier and the associated procedures and documentation requirements.

### 1140.02 References

*Environmental Procedures Manual*, M 31-11, WSDOT

*Guide Specifications for Structural Design of Sound Barriers*, AASHTO

*Roadside Manual*, M 25-30, WSDOT

*Standard Plans for Road, Bridge, and Municipal Construction* (Standard Plans), M 21-01, WSDOT

### 1140.03 Design

The two basic types of noise barriers are the earth berm and the noise wall. An earth berm can be constructed to the full height required for noise abatement or to partial height in conjunction with a noise wall to reach the required height. A noise wall can be made of concrete, masonry, metal, wood, or other approved innovative products, and can be supported by spread, pile, shaft, or trench footings.

Consideration of the noise report and the visual characteristics of adjacent land forms, vegetation, and structural elements (such as buildings, bridges, and retaining walls) will determine whether a proposed noise barrier might be berm, wall, or both.

An earth berm should be the primary alternative if the visual and environmental quality of the corridor would be preserved or enhanced and materials and right of way widths are available. See the *Roadside Manual* for criteria for determining if a vegetated earth berm is appropriate.

The region uses the noise report and other environmental documents (see the *Environmental Procedures Manual*) to help determine the location, exposure conditions, length, and heights of the proposed noise barrier.

To design and locate a noise barrier of any kind, consider the following:

- Desired noise abatement
- Future right of way needs
- Cost and constructibility
- Visual character and quality of the corridor
- Future maintenance of the noise barrier and the whole right of way
- Wind

- Supporting soil
- Earthquakes
- Ground water
- Existing drainage systems and water courses
- Exposure to vehicular impacts
- Potential vandalism
- Existing vegetation and roadside restoration required
- Access for maintenance equipment and enforcement, traffic service, and emergency vehicles
- Pedestrian and bicycle access
- Available and attainable width of right of way for berms
- Aesthetic and structural characteristics of available wall designs
- Visual compatibility of each wall design with other transportation structures within the corridor
- Construction limits for footings
- Access to, and maintenance of, right of way behind a wall, including drainage structures
- Use of right of way and wall by adjacent property owners
- Drainage and highway runoff
- Drainage from adjacent land
- Existing utilities and objects to relocate or remove
- Water and electricity; needs, sources, and access points

A noise barrier must not have anything (such as bridge columns, light fixtures, or sign supports) protruding in such a way as to present a potential for snagging vehicles.

### **(1) Earth Berm**

- (a) Berm slopes are a function of the material used, the attainable right of way width, and the desired visual quality. Slopes steeper than 2H:1V (3H:1V for mowing) are not recommended.

Design the end of the berm with a lead-in slope of 10H:1V and curve it toward the right of way line.

- (b) See Chapter 710 and the Standard Plans for guidance on redirection of land forms if the berm is to function as a traffic barrier.

### **(2) Noise Wall**

- (a) When feasible, to encourage competitive bidding, include several alternate noise wall designs in the contract and permit the contractor to submit alternate designs under the value engineering specification.

(b) There are standard noise wall designs in the Standard Plans manual. Additional designs are in various stages of development to become standard plans. The draft-standard design sheets and other preapproved plans are available from the Bridge and Structures Office. The Bridge Office also works with the regions to facilitate the use of other designs as bidding options.

- (c) When a noise wall has ground elevations that are independent of the roadway elevations, a survey of ground breaks (or cross sections at 25-ft intervals) along the entire length of the wall is needed for evaluation of constructibility and to assure accurate determination of panel heights.

(d) Size of openings (whether lapped, door, or gated) depends on the intended users. Agencies such as the local fire department can provide the necessary requirements. Unless an appropriate standard plan is available, such openings must be designed and detailed for the project.

- (e) When a noise wall is inside the Design Clear Zone, design its horizontal and vertical (ground elevation) alignment as if it were a rigid concrete traffic barrier. See Chapter 710 for maximum flare rates.

(f) Provide a concrete traffic barrier shape at the base of a new noise wall constructed 12 ft or less from the edge of the nearest traffic lane. The traffic barrier shape is optional at the base of the new portion when an existing vertical-faced wall is being extended (or the existing wall may be retrofitted for continuity). Standard Concrete Barrier Type 4 is recommended for both new and



existing walls except when the barrier face can be cast as an integral part of a new wall. Deviations may be considered but require approval as prescribed in Chapter 330. For deviations from the above, deviation approval is not required where sidewalk exists in front of the wall or in other situations where the wall face is otherwise inaccessible to traffic.

See Chapter 710, "Traffic Barriers," for flare rates and approach slopes for concrete barriers.

(g) To designate a standard noise wall, select the appropriate general special provisions and state the standard plan number, type, and foundation type. For example: Noise Barrier Standard Plan D-2a, Type 1A, Foundation D1.

Wall type is a function of exposure and wind speed. See Figure 1140-1.

A geotechnical/soils report identifying the angle of internal friction  $f$  and the allowable bearing pressure is needed for selection of a standard foundation. The standard spread footing designs require an allowable bearing pressure of 1 Tsf. The standard trench and shaft footing designs require a  $f$  of at least  $32^\circ$  for D1 and  $38^\circ$  for D2.

A special design of the substructure is required for noise walls on substandard soil, where winds exceed 90 mph, and for exposures other than B1 and B2 as defined in Figure 1140-1.

### 1140.04 Procedures

The noise unit notifies the Project Engineer's Office when a noise barrier is recommended in the noise report.

	Exposure				
	B1		B2		C
Wind Speed	80 mph	90 mph	80 mph	90 mph	
Wall Type	A	B	C	D	Special Design*

Wind speed is according to Figure 1-2.1.2.A of the (AASHTO) *Guide Specifications for Structural Design of Sound Barriers*. Assume the wind to be perpendicular to the wall on both sides and design for the most exposed side.

Exposure is determined by the nature of the immediately adjacent ground surface and the extension of a plane at the adjacent ground surface elevation for 1,500 ft to either side of the noise wall:

Exposure B1 = Urban and suburban areas with numerous closely spaced obstructions having the size of single-family dwellings or larger that prevail in the upwind direction from the noise barrier for a distance of at least 1,500 ft.

Exposure B2 = Urban and suburban areas with more open terrain not meeting the requirements of Exposure B1.

Exposure C = Open terrain with scattered obstructions that include flat, open country, grasslands, and elevated terrain.

\*For a noise wall with Exposure C, on a bridge or overpass, or at the top of a slope, consult the Bridge and Structures Office, as a special design will probably be necessary.

### Standard Noise Wall Types

Figure 1140-1

The Project Engineer's Office is responsible for interdisciplinary teams, consultation, and coordination with the public, noise specialists, maintenance, construction, region's Landscape Architecture Office (or the Roadside and Site Development Services Unit), right of way personnel, Materials Laboratory, Principal Architect (in the Bridge and Structures Office), Bridge and Structures Office, CAE Support Team, Access and Hearings Engineer, consultants, and many others.

The region evaluates the soils (see Chapters 510 and 1110) and, if a noise wall is contemplated, obtains a list of acceptable wall design options by sending information pertaining to soils and drainage conditions, the alignment, and heights of the proposed wall to the Principal Architect.

If a vegetated earth berm is considered, see the *Roadside Manual* for procedures.

The Principal Architect coordinates with the Bridge and Structures Office, Hydraulics Design Branch, Geotechnical Branch, and the region to provide a list of acceptable standard, draft-standard, and preapproved-proprietary noise wall designs, materials, and finishes that are compatible with existing visual elements of the corridor. Only wall designs from this list may be considered as alternatives. Design visualizations of the highway side of proposed walls (available from the CAE Support Team in Olympia) must be limited to options from this list. The visual elements of the private-property side of a wall are the responsibility of the region unless addressed in the environmental documents.

After the noise report, any changes to the dimensions or location of a noise barrier must be reviewed by the appropriate noise unit to determine the impacts of the changes on noise abatement.

On limited access highways, any opening in a wall or fence (for pedestrians or vehicles) must be coordinated with the Access and Hearings Engineer and approved by the State Design Engineer.

On nonlimited access highways, an access connection permit is required for any opening (approach) in a wall or fence.

The Bridge and Structures Office provides special substructure designs to the regions upon request; reviews contract design data related to standard, draft-standard, and preapproved designs; and reviews plans and calculations that have been prepared by others. (See Chapter 1110.)

Approval of the Bridge and Structures Office and the Architecture Office is required for any attachment or modification to a noise wall and for the design, appearance, and finish of door and gate type openings.

Approval of the Principal Architect is required for the final selection of noise wall appearance and finish.

## **1140.05 Documentation**

The following documents are to be preserved for future reference in the project file. See Chapter 330.

- Noise report
- Geotechnical/soils report
- List of design options considered and summary of evaluations
- Report on impacts due to changes
- Openings approvals
- Wall attachments approval
- Final selection approval

- 1210.01 General
- 1210.02 References
- 1210.03 Hydraulic Considerations
- 1210.04 Safety Considerations
- 1210.05 Design Responsibility

### 1210.01 General

Hydraulic design factors can significantly influence the corridor, horizontal alignment, grade, location of interchanges, and the necessary appurtenances required to convey water across, along, away from, or to a highway or highway facility. An effective hydraulic design conveys water in the most economical, efficient, and practical manner to ensure the public safety without incurring excessive maintenance costs or appreciably damaging the highway or highway facility, adjacent property, or the total environment.

This chapter is intended to serve as a guide to highway designers so they can identify and consider hydraulic related factors that impact the design. Detailed criteria and methods that govern highway hydraulic design are in WSDOT's *Hydraulics Manual* and *Highway Runoff Manual*.

Some drainage, flood, and water quality problems can be easily recognized and resolved; others might require extensive investigation before a solution can be developed. Specialists experienced in hydrology and hydraulics can contribute substantially to the planning and project definition phases of a highway project by recognizing potentially troublesome locations, making investigations and recommending practical solutions. Regions may request that the Olympia Service Center (OSC) Hydraulics Branch provide assistance regarding hydraulic problems.

Since hydraulic factors can affect the design of a proposed highway or highway facility from its inception, consider these factors at the earliest possible time during the planning phase.

In the project definition phase, begin coordination with all state and local governments and Indian tribes that issue or approve permits for the project.

### 1210.02 References

#### (1) Existing Criteria and References

Existing criteria and additional information for hydraulic design requirements, analyses, and procedures are contained in the following references:

*Hydraulics Manual*, M 23-03, WSDOT

*Highway Runoff Manual*, M 31-16, WSDOT

*Standard Plans for Road, Bridge and Municipal Construction*, M 21-01, WSDOT

*Standard Specifications for Road, Bridge and Municipal Construction*, M 41-10, Amendments, and General Special Provisions, WSDOT

*Utilities Manual*, M 22-87, Section 1-19, "Storm Drainage," WSDOT

#### (2) Special Criteria

Special criteria for unique projects are available on request from the OSC Hydraulics Branch.

### 1210.03 Hydraulic Considerations

#### (1) The Flood Plain

Encroachment of a highway or highway facility into a flood plain might present significant problems. A thorough investigation considers the following:

- (a) The effect of the design flood on the highway or highway facility and the required protective measures.
- (b) The effect of the highway or highway facility on the upstream and downstream reaches of the stream and the adjacent property.
- (c) Compliance with hydraulic related environmental concerns and hydraulic aspects of permits from other governmental agencies per Chapters 220 and 240.

Studies and reports published by the Federal Emergency Management Agency (FEMA) and the Corps of Engineers are very useful for flood plain analysis. The OSC Hydraulics Branch has access to all available reports and can provide any necessary information to the region.

## **(2) Stream Crossings**

When rivers, streams, or surface waters (wetland) are crossed with bridges or culverts (including open bottom arches), consider the following:

- Locating the crossing where the stream is most stable.
- Effectively conveying the design flow(s) at the crossing.
- Providing for passage of material transported by the stream.
- The effects of backwater on adjacent property.
- Avoiding large skews at the crossing.
- The effects on the channel and embankment stability upstream and downstream from the crossing.
- Location of confluences with other streams or rivers.
- Fish and wildlife migration.
- Minimizing disturbance to the original streambed.
- Minimizing wetland impact.

## **(3) Channel Changes**

It is generally desirable to minimize the use of channel changes because ongoing liability and negative environmental impacts might result.

Channel changes are permissible when the designer determines that a reasonable, practical alternative does not exist. When used, consider:

- (a) Restoration of the original stream characteristics as nearly as practical. This includes:
  - Meandering the channel change to retain its sinuosity.

- Maintaining existing stream slope and geometry (including meanders) so stream velocity and aesthetics do not change in undisturbed areas.
- Excavation, selection, and placement of bed material to promote formation of a natural pattern and prevent bed erosion.
- Retention of stream bank slopes.
- Retention or replacement of streamside vegetation.

- (b) The ability to pass the design flood.
- (c) The effects on adjacent property.
- (d) The effects on the channel and embankment upstream and downstream from the channel change.
- (e) Erosion protection for the channel change.
- (f) Environmental requirements such as wetlands, fish migration, and vegetation re-establishment.

Do not redirect flow from one drainage basin to another. (Follow the historical drainage pattern.)

Consult the OSC Hydraulic section for the best guidance when channel changes are considered.

## **(4) Roadway Drainage**

Effective collection and conveyance of storm water is critical. Incorporate the most efficient collection and conveyance system considering initial highway costs, maintenance costs, and legal and environmental considerations. Of particular concern are:

- (a) Combinations of vertical grade and transverse roadway slopes that might inhibit drainage.
- (b) Plugging of drains on bridges as the result of construction projects. This creates maintenance problems and might cause ponding on the structure. The use of drains on structures can be minimized by placing sag vertical curves and crossovers in superelevation outside the limits of the structure.

(c) See Chapter 630 for discussion of the relationship of roadway profiles to drainage profiles.

### **(5) Subsurface Drainage**

Subsurface drainage installations control ground water encountered at highway locations. Ground water, as distinguished from capillary water, is free water occurring in a zone of saturation below the ground surface. The subsurface discharge depends on the effective hydraulic head and on the permeability, depth, slope, thickness, and extent of the aquifer.

The solution of subsurface drainage problems often calls for specialized knowledge of geology and the application of soil mechanics. The region Materials Engineer evaluates the subsurface conditions and includes findings and recommendations for design in the Soils Report.

Typical subdrain installations control seepage in cuts or hillsides, control base and shallow subgrade drainage, or lower the ground water table (in swampy areas, for example).

Design a system that will keep the stormwater out of the subsurface system when stormwater and subsurface drainage systems are combined.

### **(6) Subsurface Discharge of Highway Drainage**

Consider subsurface discharge of highway drainage when it is a requirement of the local government or when existing ground conditions are favorable for this type of discharge system. Criteria for the design of drywells or subsurface drainage pipe for this type of application are described in Chapter 6 of the *Hydraulics Manual*. The criteria for the design of infiltration ponds are described in the *Highway Runoff Manual*.

### **(7) Treatment of Runoff**

On certain projects, effective quantity control of runoff rates and removal of pollutants from pavement are intended to address flooding and water quality impacts downstream. See the *Highway Runoff Manual* for specific criteria on quantity and quality control of runoff.

## **1210.04 Safety Considerations**

Locate culvert ends outside the Design Clear Zone when practical. See Chapter 700 for culvert end treatments when this is impractical.

## **1210.05 Design Responsibility**

Chapter 1 of the *Hydraulics Manual* describes the responsibilities of the regions and the OSC Hydraulics Branch relative to hydraulic design issues.

P65:DM12

1300.01	General
1300.02	References
1300.03	<i>Roadside Classification Plan</i>
1300.04	<i>Roadside Manual</i>
1300.05	Design Requirements
1300.06	Documentation
1300.07	Design Recommendations

### 1300.01 General

The *roadside* is the area outside the traveled way. This applies to all lands managed by WSDOT and may extend to elements outside the right of way boundaries.<sup>1</sup> This includes unpaved median strips and auxiliary facilities such as rest areas, roadside parks, viewpoints, heritage markers, pedestrian and bicycle facilities, wetlands and their associated buffer areas, stormwater treatment facilities, park and ride lots, and quarries and pit sites.

The roadside is managed to fulfill operational, environmental, visual and auxiliary functions. In reality, these functions are interrelated and inseparable. However, the four categories help communicate the range of roadside management issues.

- **Operational functions** are functions that provide safe, multiuse roadsides. Operational functions include access control, and providing recovery areas and sight distances with accommodations for signs and utilities.
- **Environmental functions** are those roadside functions that protect and enhance our natural and built surroundings. Environmental functions include water quality preservation and improvement, stormwater detention and retention, wetland and sensitive area

<sup>1</sup> WSDOT owns and manages the land within the right of way boundaries. WSDOT also owns, or has partial investment in, properties outside of the right of way boundaries; for example, wetland mitigation sites. In addition, WSDOT has an interest in elements outside the right of way boundaries which may affect roadway safety.

protection, noxious weed control, noise control, habitat preservation, air quality improvement, and erosion control.

- **Visual functions** are those roadside functions that are designed and experienced primarily from a visual perspective. Visual functions promote a positive quality of life and are integral to operational, environmental, and auxiliary functions. They include positive guidance and navigation, distraction screening, corridor continuity, roadway and adjacent property buffering, and scenic view preservation.
- **Auxiliary functions** are those roadside functions that provide additional operational, environmental, and visual functions for a complete transportation system. Examples of auxiliary functions include community enhancement areas, safety rest areas, roadside parks, viewpoints, agricultural uses, historic markers, bicycle and pedestrian facilities, park and ride lots, and maintenance facilities.

One element can provide multiple functions simultaneously. Roadside functions are described in greater detail in the *Roadside Manual*, (M 25-30).

The design level planning effort of a roadside project incorporates site conditions, commitments, the extent of need, and available funding. Roadside development concepts covered elsewhere in the *Design Manual* are:

- Signs (Chapter 820)
- Safety rest areas, roadside parks, view-points, and historical markers (Chapter 1030)
- Retaining walls (Chapter 1130)
- Noise barriers (Chapter 1140)
- Roadside safety (Chapter 700)
- Traffic barriers (Chapter 710)
- Contour grading (Chapter 1310)
- Vegetation (Chapter 1320)

- Irrigation (Chapter 1330)
- Fencing (Chapter 1460)
- Utilities (*Utilities Manual and Utilities Accommodation Policy*)

It is WSDOT policy to employ roadside treatments for the protection and restoration of roadside character as designated in the *Roadside Classification Plan*.

## 1300.02 References

*Roadside Classification Plan*, M 25-31, WSDOT

*Roadside Manual*, M 25-30, WSDOT

*Utilities Accommodation Policy*, M 22-86, WSDOT

*Utilities Manual*, M 22-87, WSDOT

Roadside Design Guide, AASHTO

## 1300.03 Roadside Classification Plan

The *Roadside Classification Plan* coordinates and guides the management of Washington State highway roadsides within a framework of roadside character classifications. It provides guidelines for roadside restoration and advocates the use of native plants, integrated vegetation management (IVM), and a long-term management approach to achieve sustainable roadsides.

## 1300.04 Roadside Manual

The *Roadside Manual* provides a link and coordination between all WSDOT partners responsible for roadside activities, and establishes a common basis for consistent roadside management decisions statewide.

It also establishes a convenient and accessible reference for new and previously unpublished material related to roadside management including planning, design, construction, and maintenance. In addition, the manual supplements statewide roadside guidelines established in the *Roadside Classification Plan*.

The *Roadside Manual* includes information on, or references to:

- Federal, state, and departmental roadside law and policy.

- Considerations such as the Americans with Disabilities Act.
- Heritage Corridors Program and Scenic Byways.
- Roadside treatments such as erosion control, contour grading, rock cuts, soil bioengineering, wetland mitigation, and revegetation.
- Right of way issues such as commercial impacts, view exposure, agricultural uses, acquisitions, and scenic easements.
- Partnerships such as Adopt a Highway.

See the *Roadside Manual* table of contents for more information on the contents of the manual.

## 1300.05 Design Requirements

For all projects outside the roadway edge, consult the region's Landscape Architect, or the OSC Region Liaison Landscape Architect in regions without a Landscape Architect. The Landscape Architects can help coordinate all the various aspects of roadside projects including siting and design for maintenance facilities, safety rest areas, noise berms, noise walls, and revegetation, restoration, and wetland mitigation projects.

For any work in, or near wetlands, Section 404 of the Clean Water Act may apply.

The act requires a permit to discharge dredge or fill into most waters of the United States, including wetlands. The Section 404 permitting process requires advanced planning and coordination with the permitting agency: the U.S. Army Corps of Engineers.

## 1300.06 Documentation

Document all roadside projects with a project file (see Chapter 330 for information on design documentation and design approval levels). A roadside project file may include the following documents:

- Site analysis
  - Soils
  - Soil boring logs
  - Climate
  - Slopes

- Aspect (north facing slope, for example)
- Vegetation present (species, percentage of each species, location, health)
- Adjacent land uses
- Location of any surface water bodies
- Movement of water
- Views into and out of site
- General impressions
- Conceptual diagrams
- Preliminary plans
- Final PS&E
- Decision documentation; for example:
  - Jurisdictional requirements
  - Commitments
  - Soil analysis
  - Slope stability analysis
  - Hydrologic analysis
  - Horticultural reports
  - Plant availability
  - Proprietary product information

Participants in reviews for roadside projects may include:

- OSC Region Liaison Landscape Architect
- Maintenance Office
- Construction Office
- OSC Horticulturist
- Region's Traffic Office
- Region's Project Development Office
- Environmental Office
- Affected Community Groups

The OSC Region Liaison Landscape Architect is also available for roadside design in regions without a regional Landscape Architect.

*P65:DP/DMM*

### **1300.07 Design Recommendations**

The region's Landscape Architect designs and approves revegetation plans. They are available for assistance on any roadside projects. A review of preliminary plans to provide additional perspective on the design is recommended at the following roadside project benchmarks:

- Shortly after field data has been collected - consists of site analysis and conceptual diagrams
- Preliminary plans
- Final PS&E plans

These reviews help to ease the final PS&E process.



- 1310.01 General
- 1310.02 References
- 1310.03 Procedures
- 1310.04 Recommendations

**1310.01 General**

Contour grading is an important element in achieving operational, environmental and visual functions.

Contour grading plans are required when profiles and cross sections do not provide a complete picture. Examples include stream channel changes, interchanges, redirection berms, noise abatement berms, wetland mitigation sites, and detention/retention ponds. Contour grading plans show the subtle changes in grading that occur between cross sections and can allow for finer grading so that the constructed earthform blends smoothly into the surrounding landscape. While engineered slopes define grades to meet engineering requirements, contours can be used to define a finished grade that will blend the facility into the surrounding landscape and meet the requirements of the *Roadside Classification Plan*.

A detention/retention pond can be designed and constructed to appear as if it were naturally formed. Contour grading plans facilitate this kind of earth sculpting. In addition, contour grading plans can be critical to wetland mitigation sites where inaccurate grading can leave a proposed mitigation site without access to a water source.

See the *Roadside Manual* for more detailed information on grading for roadsides.

**1310.02 References**

*Roadside Manual*, M 25-30, WSDOT

*Roadside Classification Plan*, M 25-31, WSDOT

*Standard Plans for Road, Bridge and Municipal Construction*, M 21-01, WSDOT

**1310.03 Procedures**

See Chapter 330 for design approval levels.

When contour grading plans are needed, consult the region's or Olympia Service Center (OSC) Design Landscape Architect.

Submit plans for contour grading on structures (such as lids) to the OSC Bridge and Structures Office for approval.

**1310.04 Recommendations**

Consider the following factors when developing a contour grading plan:

- Balancing of cut and fill within project limits.
- Preservation of existing desirable vegetation.
- Preservation of existing topsoil.
- Vehicle recovery areas.
- Sight distance.
- Pedestrian safety and security.
- Impacts to groundwater and surface water both on and off the right of way, including wetlands.
- Slope angle and potential soil erosion.
- Slope rounding.
- Drainage (including detention/retention functions).
- Surrounding landscape.
- Visual factors (a form that blends with the adjacent landforms).
- Grading construction cost
- Slopes steeper than 2 horizontal:1 vertical may be difficult to stabilize and establish vegetation on.
- Soil properties and angle of repose.

- Maintenance access to drainage and traffic operational features.
- Maintenance requirements for slopes (slopes steeper than 3 horizontal:1 vertical cannot be mowed).
- Access along fence line or noise walls, if necessary.
- Maximum allowable cut/fill next to a structure (minimum cover over a footing, maximum fill behind a wall or next to a pier).

Use a known stationing point or baseline as a starting point in drawing contours.

Recommended contour interval:

- 3 to 5 ft for highway plan drawings.
- 2 ft contour intervals for redirection berms, and pedestrian related facilities.
- 0.5 to 1.5 ft contour intervals for wetland mitigation sites, stream mitigation sites, and wetland bank sites. Include two or more cross-sections done at a vertical exaggeration sufficient to communicate the design intent.

*P65:DP/DME*

1320.01	General
1320.02	References
1320.03	Discussion
1320.04	Recommendations
1320.05	Design Guidelines
1320.06	Documentation

### 1320.01 General

Roadside vegetation provides operational, environmental and visual benefits to WSDOT roadway users. Vegetation preservation and restoration is an integral part of roadside planning and design. When a project disturbs a roadside segment, that project is responsible for meeting the requirements of the roadside classification for that road segment. This may include working outside the actual disturbed area for buffering and blending into the surrounding landscape.

Consult early in the project process with the region's Landscape Architect, or the OSC Region Liaison Landscape Architect for regions without a Landscape Architect, for all projects involving revegetation.

### 1320.02 References

*Roadside Classification Plan*, M 25-31, WSDOT

*Roadside Manual*, M 25-30, WSDOT

*Integrated Vegetation Management for Roadsides*, WSDOT

*Standard Specifications for Road, Bridge and Municipal Construction*, APWA and WSDOT

### 1320.03 Discussion

#### Operational, Environmental and Visual Functions of Roadside Vegetation

Roadside vegetation serves various functions. Functions include, but are not limited to, the following:

- Prevent soil erosion.
- Enhance water quality.
- Provide for water storage and slow runoff.

- Aid in de-watering soils.
- Slope stabilization.
- Protect or restore wetlands and sensitive areas.
- Preserve and provide habitat.
- Prevent noxious weed infestation.
- Provide positive driver cues for guidance and navigation.
- Provide for corridor continuity.
- Screen glare and distractions, and buffer view of neighboring properties from the roadway.
- Buffer view of roadway by neighboring property owners.
- Preserve scenic views.
- Reduce driver monotony.
- Provide for a pleasing roadside experience.

For more detail see the *Roadside Manual*.

### 1320.04 Recommendations

#### (1) Reviews

Refer to Chapter 1300, Design Recommendations, for review recommendations.

#### (2) Preliminary Plans

The region's Landscape Architect designs and approves revegetation plans. A review of preliminary plans to provide additional perspective on the design is recommended at least six weeks before submittal of the Plans, Specification and Estimate package (PS&E). Participants in design reviews for revegetation projects include:

- OSC Region Liaison Landscape Architect
- Maintenance Office
- Construction Office
- OSC Horticulturist
- Region's Traffic Office

- Region's Project Development Office
- Affected Community Groups

Preliminary plans may consist of print or pencil drawings of plans (excluding standardized details) being developed for the PS&E. The preliminary plans provide for an informal review which allows adaptation of the plan and can ease the formal PS&E review.

The Olympia Service Center (OSC) Region Liaison Landscape Architect is also available to prepare plans for regions without a Landscape Architect.

## 1320.05 Design Guidelines

### (1) General

The type and extent of vegetation will vary depending on the roadside character classification of the road segment, the approved treatment level of the project, the affected roadside management zone, and the planting environment. Select and maintain vegetation so that it does not present a hazard or restrict sight distances to other vehicles and to signs.

- Apply the following guidelines when designing roadside projects:
- Apply the requirements of the *Roadside Classification Plan*.
- Design revegetation plans, including wetland mitigation sites and detention/retention ponds to be as maintenance-free as possible.
- Select and maintain plants to achieve required clear zone, sight distance, clear sight to signing, and headlight screening.
- Preserve existing desirable vegetation and topsoil to the maximum extent reasonable.
- Select native plants as the first choice.
- Select plants adaptable to the site conditions. (See the *Roadside Manual* for more information.)
- Consider stripping, stockpiling and reapplying topsoil if construction will disturb topsoil.

- Consider design speeds in the selection and location of plants. For example, as traffic speed increases, include larger groupings of fewer species in the landscape since the motorist's perception of detail along the roadside diminishes.
- When selecting vegetation, consider screening undesirable views, or consider allowing openings to reveal or maintain desirable views.
- Accommodate existing and proposed utilities.
- Consider maintenance requirements and design for sustainable roadsides.

Roadway geometrics will also affect the type and extent of vegetation in specific locations. The maximum allowable diameter of trees within the Design Clear Zone is 4 in measured at 6 in above the ground when the tree has matured. Consider limiting vegetation diameters on the outside of curves beyond the Design Clear Zone to improve safety. See the *Roadside Manual* for more information.

### (2) Existing Vegetation.

Avoid destruction of desirable existing vegetation, reduce impacts on desirable existing vegetation, and restore desirable damaged vegetation.

- Protect desirable existing vegetation wherever possible.
- Delineate trees that are to remain within the construction zone and provide adequate protection of the root zone (extending from the tree trunk to a minimum of 3 ft beyond the drip line).
- Encourage desirable vegetation by using revegetation techniques to prevent or preclude the establishment of undesirable vegetation. See *Integrated Vegetation Management for Roadsides*.
- Limit clearing and grubbing (especially grubbing) to the least extent possible.

Selectively remove vegetation to:

- Remove dead and diseased trees when they are a hazard (including those outside the clear zone).
- Maintain clear zone and sight distance.
- Increase solar exposure and reduce accident rates, if analysis shows that removing vegetation will improve safety.
- Open up desirable views.
- Encourage understory development.
- Encourage individual tree growth.
- Prevent plant encroachment on adjacent properties.
- Ensure long-term plant viability.

Refer to Division 8 of the *Roadside Manual* for more information.

### **(3) Plant Material Selection.**

Select noninvasive vegetation (not having the potential to spread onto roadways, ditches and adjacent lands).

Base plant material selection on:

- Site analysis and conditions expected after the facility is constructed.
- Horticultural requirements.
- Plant availability.
- Plant cost.
- Plant success rates in the field.
- Traffic speed.

The *Roadside Manual* provides more detailed guidelines on plant selection, sizing, and location.

### **(4) Establishment of Vegetation**

Most WSDOT projects have 1 to 3 year plant establishment periods. Wetland mitigation projects often include additional years of monitoring to ensure that mitigation standards of success are met. The goal of plant establishment is to promote a healthy, stable plant community.

Soil treatments, such as the use of slow release fertilizer; incorporation of soil amendments such as compost into the soil layer; and surface mulching, may improve the success rate of introduced vegetation. Consult the WSDOT Horticulturist for recommendations. (Check with the local maintenance office or the local jurisdiction's comprehensive plan for any restrictions such as those in well-head protection areas.)

- Use soil amendments based on the soil analysis done for the project. Soil testing is coordinated through the OSC Horticulturist or the Landscape Architect. Soil amendments will enhance the soil's moisture holding capacity.
- Use surface mulches to conserve soil moisture and moderate soil temperatures. Mulches also help keep weeds from competing with desirable plants for water and nutrients, and provide organic matter and nutrients to the soil.
- Use irrigation only when necessary. If irrigation is required, see Chapter 1330 for design guidelines and the *Roadside Manual* for more detail.

## **1320.06 Documentation**

Refer to Chapter 320 for guidance on reviews and approvals, and Chapter 330 for design approval levels. Include the following as a part of the project file for a revegetation project:

**(a) Roadside Classification** of the road segment. Park-and-ride lots and other off-road facilities may not have a roadside classification. However, if there are local requirements driving the design for these facilities, then those need to be documented.

**(b) Scope and Conceptual Approach** of the planting design

Include commitments to adjacent property owners.

**(c) Treatment Level** (Described in the *Roadside Classification Plan*.)

- Treatment Level 1 is for maintenance activities.

- Treatment Level 2 is used in most cases.
- Treatment Level 3 requires OSC approval.

**(d) Horticultural Requirements** of the vegetation:

- Collect and analyze soil sample data.
- Develop a proposed plant list.
- Document the need for irrigation (if proposed).

Consult the WSDOT Horticulturist for assistance.

**(e) Wildflower Requirements.**

The Surface Transportation and Uniform Relocation Assistance Act of 1987, Section 130 requires at least 0.25% of funds expended for landscape projects be used to plant native wildflowers.

Wildflowers are defined by the Federal Highway Administration (FHWA) as any native flowering plant growing in fields, woods, etc., without cultivation. Native flowering shrubs and trees also qualify as wildflowers and are generally more sustainable than herbaceous wildflowers.

For federal-aid landscape projects, include the amount of wildflower plantings, expressed as a percentage of all landscaping costs (excluding erosion control costs), in the project summary. If the project contains wildflower plantings amounting to less than 0.25% of all landscaping costs (excluding erosion control costs), a deviation must be requested from FHWA.

The wildflower requirement may be waived by FHWA if any of the following conditions exist:

- Wildflowers cannot be grown satisfactorily within the project limits.
- The available right of way is to be used for agricultural purposes.
- There are no suitable planting areas available within the project limits.

- Wildflower planting would pose a threat to endangered or rare species.

**(f) Construction.** The project file will include the following roadside construction considerations and requirements.

- Commitments to adjacent property owners.
- Instructions for special testing procedures (examples are compost maturity test, clay liner requirements, permeability test, etc.).

Communication with the assigned construction office is recommended throughout the design process to improve constructibility of the project.

**(g) Maintenance.** The project file will include the following roadside maintenance considerations and requirements:

- Maintenance requirements and estimated costs necessary to achieve the design intent.

Coordinate with the regional maintenance or operations engineer (as appropriate for your region) to allow for funding.

- Guidelines, schedules, and prioritized list of activities required to meet the design intent.

The project file will state whether the project is within the scope of the existing maintenance program.

Communication with the area maintenance office is recommended throughout the design process.

*P65:DP/DME*

- 1330.01 General
- 1330.02 References
- 1330.03 Design Considerations

### 1330.01 General

Irrigation provides additional moisture to plants during their establishment (the first 3-5 years), or in special cases, on a continuing basis. Irrigation is a high maintenance and high cost item; use only when absolutely necessary. Irrigation is only used in semiurban and urban character classifications in Treatment Levels two and three. Refer to the *Roadside Classification Plan* for more information. Contact the region's Landscape Architect or the OSC Irrigation Specialist for assistance with irrigation plans.

### 1330.02 References

*Roadside Classification Plan*, M 25-31, WSDOT  
*Roadside Manual*, M 25-30, WSDOT

### 1330.03 Design Considerations

#### During the project planning phase:

- (a) Determine whether irrigation is necessary
  - Analyze soils
  - Determine local climate conditions and microclimates
  - Consult with the OSC Horticulturist, regional Landscape Architect, or OSC Landscape Architect for regions without landscape architectural expertise for site, soil, and plant recommendations to reduce or eliminate need for irrigation
  - Describe where irrigation is needed based on a functional design concept, such as "irrigation is needed to provide green lawn at a safety rest area"

- (b) Determine the source of water and its availability and connection fees

Sources of water for irrigation use include municipal water systems and water pumped from a well, pond, or stream. When selecting a source of water, consider what permits and agreements may be needed as well as the cost and feasibility of bringing water from the source to the site.

- (c) Determine applicable laws and regulations regarding water, and backflow prevention

#### During the design and implementation phases:

- (a) Coordinate with the local water purveyor.
- (b) Select durable, readily available, easy to operate, and vandal resistant irrigation components.
- (c) Justify any proprietary device selections.
- (d) Determine power source and connection fees.
- (e) Consider the need for winterization of the irrigation system to avoid freeze damage to system components.

Use this information to document design decisions for the project file.

Show the location and type of water source on the irrigation plan.

For more detailed information on irrigation systems and irrigation documentation, see the *Roadside Manual*.

P65:DP/DMM

- 1350.01 General
- 1350.02 References
- 1350.03 Uses
- 1350.04 Design Responsibilities and Considerations
- 1350.05 Documentation

### 1350.01 General

Soil bioengineering is a land stabilization technology applied to disturbed sites and on slope and streambank projects. A multidisciplinary partnership is used to implement soil bioengineering techniques. Project managers initiate and design bioengineering features by employing the expertise of WSDOT hydraulic engineers, geotechnical engineers, engineering geologists, landscape architects, horticulturists, biologists, water quality specialists, environmental planners, and others. Soil bioengineering for slope stabilization provides additional environmental benefits such as habitat enhancement and water quality improvement.

All soil bioengineering proposals should include consideration of slope geometry, climate, water regime, soil properties, and surrounding vegetation. Applications of soil bioengineering are divided into three general categories: erosion control, streambank or shoreline stabilization, and upland slope stabilization. Refer to manuals according to the related discipline.

### 1350.02 References

For more detailed information, see:

*Design Manual* chapters, M 21-01, WSDOT:

- 1300 Roadside Development
- 510 Investigation of Soils, Rock, and Surfacing Materials
- 640 Geometric Cross Section
- 1210 Hydraulics
- 1130 Retaining Walls

*Geotechnical Guidance* — see geotechnical report for slope/soil stability. If further assistance is needed, contact Regional Materials Engineer.

*Hydraulics Manual*, M 23-03, WSDOT — for hydrology criteria.

*Highway Runoff Manual*, M 31-16, WSDOT — for Stormwater Site Plans, Temporary Erosion and Sediment Control Plans, and best management practices.

*Roadside Manual*, M 25-30, WSDOT — for vegetation and site preparation criteria, plant selection, design configurations, and other related topics.

*Roadside Classification Plan*, M 25-31, WSDOT — policy and guidelines for roadside treatment. Contact the region's Landscape Architect Office or the OSC Roadside and Site Development Services Unit at the Olympia Service Center.

*Environmental Procedures Manual*, M 31-11, WSDOT — permits.

Internet Bioengineering Drawings, WSDOT Homepage (<http://www.wsdot.wa.gov/eesc/cae/design/roadside/bioeng.htm>)

### 1350.03 Uses

#### (1) General

Soil bioengineering combines the use of live plants or cuttings, dead plant material, and inert structural members to produce living, functioning land stabilization systems. This technique uses living plants to control and prevent soil erosion, sedimentation, and shallow slope instability. The bioengineered solution benefits from engineering techniques that use live plant material.

Soil bioengineering methods can be cost effective and a useful mitigation solution for site specific problems. Soil bioengineering is effective in erosion control, streambank stabilization, and some upland instabilities. Soil bioengineering, like other engineering techniques, is not



applicable in all situations. Soil bioengineering techniques may not effectively mitigate severe bridge scour, severe roadway erosion conditions, or deep seated slope instabilities. In such cases, soil bioengineering can be used in combination with other engineering techniques.

The use of native vegetation that is adapted to the conditions of the project site will increase the success of the application of soil bioengineering techniques. Over time, native vegetation will encourage the establishment of a diverse plant community and discourage undesirable and invasive plant species.

Other applications of soil bioengineering include:

- Wildlife and fisheries habitat enhancement
- Reinforcement and steepening of cut and fill slopes to limit impacts to adjacent properties and sensitive areas
- Vegetated buffer enhancement on steep slopes
- Enhancement of stormwater treatment areas and stabilization of drainage ways by providing erosion prevention and sediment control
- Site specific mitigations using standard geotechnical solutions in combination with vegetative control

## **(2) Erosion Prevention**

Soil Bioengineering techniques can provide erosion prevention in the top soil layers. Erosion is the detachment and transport of surficial soil particles through the action of water, wind, and ice. Plant shoots and foliage diminish rainfall erosion and remove excess moisture through transpiration. Roots reinforce the soil mantle, allowing the system to grow more stable with age. Vegetative material slows down runoff and traps soil thereby reversing the effects of erosion. Refer to the *Roadside Manual* for more information.

## **(3) Streambank Stabilization**

Soil bioengineering techniques can be used to stabilize streambanks, enhance wildlife habitat, improve water quality by controlling sediments,

and protect structures. Bioengineering in the riparian zone (banks of streams, wetlands, lakes, or tidewater) requires an hydraulic study of stream characteristics and changes in stream alignment. Refer to the *Hydraulics Manual* for more information.

## **(4) Upland Slope Stabilization (generally less than 3 feet in depth)**

Upland slope stabilization refers to the use of vegetation and plant materials to reduce or prevent soil erosion caused by wind or water on slopes not directly adjacent to riparian zones.

There are three classifications of unstable slopes:

- **Surface movement** refers to surface erosion caused by wind or water on slopes
- **Shallow-seated instability** is defined as a failure surface less than 3 ft in depth
- **Deep-seated instability** is defined as a failure surface greater than 3 ft in depth

Soil bioengineering is used for slopes that are at risk of shallow landslides, slumps, sloughing, and surface erosion. Soil bioengineering techniques are most applicable to shallow slope stabilization projects characterized by unstable slopes that have surface movement. Surface movement of soils can be induced by soil creep, repeated freeze-thaw cycles, and soil erosion. The processes that influence overall slope stability, such as heavy and prolonged erosion and continuous slow soil movement, can significantly alter slope geometry.

Soil bioengineering alone is not appropriate for deep-seated landslides, but can be used in conjunction with other engineering methods to treat associated shallow instabilities.

Soil bioengineering techniques can be used to stabilize the slopes of construction sites or to repair disturbed or damaged slopes. Soil bioengineering is applied to both cut and fill slopes.

<b>Factors</b>	<b>Parameters</b>	<b>Design Considerations/Specifications</b>
Climate/ Microclimate	Growing season Exposure/Aspect	Select suitable plants, methods and construction timing
Soil, Physical	Density and rootability Permeability	Modify during construction Select suitable plants
Soil, Water	Profile available water	Modify soil during construction Install structures (drains, ditches etc.) to remove excess water
Soil, Chemical	pH Fertility Cation Exchange	Select suitable plants Add lime, fertilizers Ameliorate soil
Erosion Risk	Soil erodibility Rainfall erosivity Channel discharge Slope Wind, Water, Ice	Temporary or Permanent covers Select suitable plants Management Reinforcement with geotextile
Geotechnical	Shear strength Slope Factor of Safety	Select suitable soil materials Structures Soil density and moisture Reinforcement with geosynthetics (Chapter 530)

### **(5) Strategies**

When planning for site specific soil bioengineering design, consider the factors, parameters, and design considerations/ specifications in the following table.

#### **1350.04 Design Responsibilities and Considerations**

Consider the possible applications for soil bioengineering during the project definition process. Address soil bioengineering applications during the design process as part of the recommendations in the Hydraulic Report (for streambank/shoreline), Stormwater Site Plan (SSP), Geotechnical Report (for slope stabilization), and in the Environmental Documents. These reports provide design criteria and guidelines.

### **1350.05 Documentation**

For all applications, include in the documentation a summary of site analysis, a list of design options considered along with a summary of evaluations, and management plans. The following is a list of soil bioengineering applications and the documents that support the designs.

#### **(1) Erosion Control**

- Temporary Erosion and Sediment Control Plan (TESC), *Highway Runoff Manual*
- Stormwater Site Plan (SSP), *Highway Runoff Manual*
- Roadside Restoration Plan including the Horticultural Report, OSC Horticulturalist and the region's Landscape Architect Office or the OSC Roadside and Site Development Unit

**(2) Streambank/Shoreline  
Stabilization**

- Hydraulics Report, *Hydraulics Manual*
- Roadside Restoration Plan, region's Landscape Architecture Office or the OSC Roadside and Site Development Unit

**(3) Upland Slope Stabilization**

- Geotechnical Report, *Design Manual*
- Geotechnical Report, Geotechnical Branch
- Roadside Restoration Plan, region's Landscape Architecture Office or the OSC Roadside and Site Development Unit

P65:DP/DMM13

## 1410

## Right of Way Considerations

- 1410.01 General
- 1410.02 References
- 1410.03 Special Features
- 1410.04 Easement and Permit
- 1410.05 Programming for Funds
- 1410.06 Appraisal and Acquisition
- 1410.07 Transactions
- 1410.08 Documentation

### 1410.01 General

Real Estate Services personnel participate in the project definition phase of a project to assist in minimizing right of way costs, defining route locations and acquisition areas, and determining potential problems and possible solutions.

Due to the variables in land acquisition, the following categories of right of way costs are considered in the project definition phase.

- Purchase costs (acquisition compensation).
- Relocation assistance benefits payments.

Other Real Estate Services staff expenses (acquisition services, relocation services, interim property management services). Right of way cost estimates are made by Real Estate Services specialists. When the parcels from which additional right of way will be acquired are known, title reports (including assessors' land areas) can be requested.

Real Estate Services personnel also “make project field inspections at appropriate times throughout the development of a project to ensure adequate consideration is given to significant right of way elements involved (including possible social, economic, and environmental effects)” in accordance with 23CFR Chapter 1 part 712 subpart B and the *Right of Way Manual*.

During plan development:

- Title reports are examined for easements or other encumbrances that would reveal the existence and location of water lines, conduits, drainage or irrigation lines, etc., that must be provided for in construction.

- Easements that indicate other affected ownerships are added to the right of way/access plan.
- Arrangements are made to obtain utility, railroad, haul road, detour routes, or other essential agreements, as instructed in the *Utilities Manual* and the *Agreements Manual*.
- Right of way acquisition, disposal, and maintenance is planned.
- Easements and permits are planned (to accommodate activities outside of the right of way).

See Chapter 440 concerning design right of way widths. The widths may be modified based on Real Estate Services input but cannot be moved to coincide with property boundaries in anticipation of a total take. Jogs in the final widths of the right of way are held to a minimum. See *Right of Way Manual* Chapter 6 for discussion of remainders.

All acquisition documents are processed through the Olympia Service Center Real Estate Services Office except temporary permits that are not shown on the Right of Way Plans and are not needed for the project (such as driveway connections).

### 1410.02 References

*Code of Federal Regulations* 23 CFR Chapter 1 part 712 subpart B, General Provisions and Project Procedures

49 CFR Part 24 Uniform Relocation Assistance and Real Property Acquisition Act of 1970

RCW 8.26, Relocation Assistance - Real Property Acquisition Policy

WAC 468-100. Uniform Relocation Assistance and Real Property Acquisition

*Agreements Manual*, M 22-99, Washington State Department of Transportation (WSDOT)

*Plans Preparation Manual*, M 22-31, WSDOT

*Right of Way Manual*, M 26-01, WSDOT

*Utilities Manual*, M 22-87, WSDOT

## **1410.03 Special Features**

### **(1) Road Approaches**

On access managed highways, the department will reconstruct legally existing road approaches that are removed or destroyed as part of the highway construction. New approaches required by new highway construction are negotiated by the region with the approval of the Regional Administrator. The negotiator coordinates with the region's design section to ensure that new approaches conform to the requirements of Chapter 920 for road approaches. All new approaches will be by permit through the appropriate regional office.

On limited access highways, road approaches of any type must be approved by the State Design Engineer before there is legal basis for negotiation by the Olympia Service Center (OSC) Real Estate Services Office. When approved, approaches will be specifically reserved in the right of way transaction and will contain the identical limitations set by the State Design Engineer and as shown on the approved Limited Access Plan.

### **(2) Cattle Passes**

The desirability of, or need for a cattle pass will be considered during the appraisal or negotiation process. A cattle pass will be approved only after complete studies of location, utilization, cost, and safety elements have proved its necessity. Upon approval, such an improvement and appurtenant rights will be established. Future right of access for maintenance is negotiated during acquisition.

On limited access highways, approval of the State Design Engineer and the addition of a traffic movement note on the right of way and limited access plan (*Plans Preparation Manual*) are required.

### **(3) Pit, Stockpile, and Waste Sites**

These sites are investigated and planned as outlined in the *Plans Preparation Manual*. Detour and haul road agreements, approved by

the Regional Administrator, are necessary when the state proposes to use city streets or county roads for the purpose of detouring traffic or hauling certain materials. See the *Utilities Manual* for detour and haul road agreement guidelines.

### **(4) International Boundaries**

Construction proposed "within a 20-foot strip, 10 feet on each side of the international boundary," must be coordinated between the department and the British Columbia Ministry of Highways and Public Works.

Permission of the International Boundary Commission is required to work "within 10 feet of an international boundary." Their primary concern is monumentation of the boundary line and the line of sight between monuments. They require a written request stating what will be done, when, and why; sent to 1250 23rd Street NW, Washington DC 20037.

## **1410.04 Easements and Permits**

### **(1) General**

If others request rights within existing WSDOT ownership, they are to contact the region's Real Estate Services Office.

Easements and permits to accommodate WSDOT activities outside the right of way usually fall into one of the categories defined below.

Easements and permits are processed in accordance with the requirements of the *Right of Way Manual*. The region's Real Estate Services Office drafts the legal descriptions for all easements and permits for acquisition or disposition of rights. These requests are to be directed through the region's Real Estate Services Manager.

The region's Real Estate Services Office either obtains or assists in obtaining easements and permits. The region is responsible for compliance with and appropriate retention of the final documents. Easements and permits are to be shown on the contract plans in accordance with the *Plans Preparation Manual*.

## **(2) Perpetual Easements**

Perpetual easements are shown on the right of way plans in accordance with the *Plans Preparation Manual*.

(a) **State Maintenance Easement.** Used when the state is to construct a facility and provide all maintenance. Examples are slope and drainage easements.

(b) **Dual Maintenance Easement.** Used when the state is to construct and maintain a facility and the owner is to maintain the remainder. Examples are; the surface area above a tunnel and the area behind a retaining wall or noise wall.

(c) **Transfer Easement.** Used when an easement must be acquired to replace an existing easement for a facility that is to be relocated. The region's Real Estate Services Office obtains or prepares instruments that contain all necessary rights and provide for maintenance by the party to whom the easement will ultimately be conveyed. Easements are conveyed when they remain within state rights of way and are replacing existing property rights. Easements are transferred only when the easement is outside the state right of way and not needed for highway purposes. The right of way/limited access plan is modified to identify the party to whom the easement will be transferred. The department cannot obtain easements for transfer across lands under the jurisdiction of the Department of Natural Resources (DNR). WSDOT cannot condemn for a transfer easement to a private party.

## **(3) Temporary Easements**

Temporary easements are used when the state requires a property right of a temporary nature that involves either more than minor work or construction activities on privately owned property. In the cases where the rights required or the work to be performed is not beneficial to the property owner, just compensation may be paid.

Temporary easements are usually shown on the right of way plans in accordance with the *Plans Preparation Manual* when the encroachment is significant; more than about 5 ft. Consult the region's Plans and Real Estate Services

personnel for exceptions. If the easement is not mapped, mark and submit plans as described for construction permits.

## **(4) Construction Permits**

Construction permits are used for temporary rights during construction and not used when WSDOT needs a perpetual right. A construction permit is recommended for rights of entry to publicly owned property. Local agencies might require the use of specific Forms when applying for these rights of entry. Regardless of the Form or its name, the region is responsible for appropriate central storage.

A construction permit is only valid with the current owner and must be renegotiated if property ownership changes before construction begins. For private ownerships, a temporary construction easement is recommended.

The construction permit is usually obtained without the payment of compensation (donation or mutual benefits, for example). Consult the region's Plans and Real Estate Services personnel for exceptions.

Permits are allowed where minor right of way acquisitions are obtained for intersections.

Mapping requirements for a construction permit are as follows:

1. Construction permits are not shown on the right of way plan.
2. The region's Project Coordinator's Office is provided two sets of right of way plans with all required construction permits delineated in red. The region sends one copy of the marked plans and copies of the permits to the OSC Real Estate Services Office. These plan sheets provide the following information:
  - Ownership boundaries. (Confirmation of ownership and parcel boundaries may be completed by a search of county records and mapping. A formal title report is not required for construction permits.)
  - Parcel number assigned to each ownership.
  - Sufficient engineering detail to write legal descriptions.

- Statement of the intended use of each construction permit area.

### **1410.05 Programming for Funds**

The phases in Figure 1410-1, in relation to plan development, apply to the authorization of stage programming.

When federal funds are involved, special attention must be given to Federal Highway Administration (FHWA) requirements. When federal participation in right of way costs is anticipated, specific authorization must be obtained from the FHWA. The rules and procedures provided in RCW 8.26, WAC 468-100, and the Right of Way Manual must be followed to ensure federal and state participation. In many cases, for example, federal funds are contingent upon the department setting up a relocation advisory procedure for any owner or tenant who is displaced by an improvement and desires such assistance. Relocation advisory assistance is a function of the OSC Real Estate Services Office.

### **1410.06 Appraisal and Acquisition**

#### **(1) All Highways**

The phases in Figure 1410-1, in relation to plan development, apply to the authorization of right of way acquisition for all access highways.

#### **(3) Exceptions**

Exceptions can be made to the requirements in Figure 1410-1 if unusual hardships result for the individual or the state. The approval of right of way hardship action will be based on the individual parcel merit and is processed in accordance with hardship acquisition policy (*Right of Way Manual*).

### **1410.07 Transactions**

#### **(1) Private Ownerships**

Right of way is ordinarily acquired from private property owners by region-level negotiation between the owner and the right of way agent.

#### **(2) Utilities**

The region ascertains ownership of all utilities and makes arrangements for necessary adjustment, including relocation of portions of the

utility, if necessary. Provisions for relocation or adjustment are included in the PS&E plans when:

- The items are normal construction items and the department is obligated for the moving expense.
- The utility requests that relocation be performed by the department and the department has approved the request.

Readjustment may require the department to purchase substitute rights of way or easements for eventual transfer to the utility. Such rights of way or easements must be shown on the right of way plans with the same engineering detail as highway right of way.

Because of the considerable time required to obtain approvals, processing of utility relocation agreements must begin as soon as possible.

#### **(3) Railways**

Right of way is generally not acquired in fee from a railroad company. Instead, the state acquires a perpetual easement for encroachment or crossing. A construction and maintenance agreement may also be required. The easement must be shown on the right of way plan and identified by both highway and railroad stationing.

The OSC Design Office coordinates with the railroad design staff to determine a mutually agreeable location before the proposed easement is sent to Real Estate Services. The negotiations with the railroads are done by OSC Real Estate Services. Because of the considerable time required to obtain approvals, processing of railroad agreements must begin as soon as possible.

The perpetual easement document is executed by the Director, Real Estate Services.

#### **(4) Federal Agencies**

Acquisition of right of way from most federal agencies must be negotiated and processed through several federal offices. Allow at least one year's time for efficient and economical right of way acquisition. Depending upon the particular federal agency involved, special exhibit maps and other documentation may be required, and the

right of way may be acquired as an easement rather than in fee.

### **(5) Other State Agencies**

Acquisition from other state agencies must be negotiated and processed through the individual agencies or designees. Negotiations with other state agencies are generally handled by OSC Real Estate Services. As in the case of federal agencies, substantial time must be allowed for compliance with applicable statutes and regulations peculiar to the agency before right of way will be granted.

### **(6) Condemnations**

Condemnation may result from a disagreement between the department and the owner as to a fair settlement or from a faulty title. Since several months might elapse between the filing of a condemnation case and a court decision, the OSC Real Estate Services Office can be requested to investigate the possibility of obtaining a negotiated possession and use agreement as in the case of an emergency project, or when a sundry site is required at once.

## **1410.08 Documentation**

The following documents are to be preserved in the design file or other permanent files. See Chapter 330.

- Agreements
- Permits
- Cattle pass studies and approvals
- International Boundary Commission approval

Deeds and plans are preserved as directed in the *Right of Way Manual* by the OSC Real Estate Services Office.

P65:DP/DME

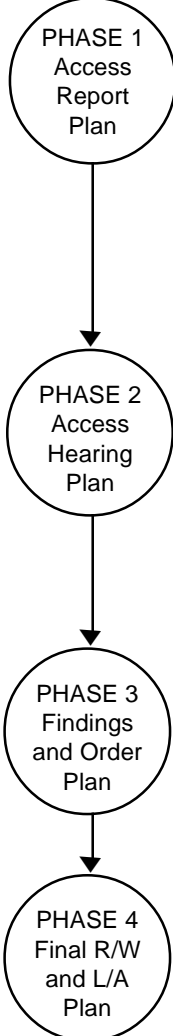

Plan Approval	Plan Approval	Programming of Funds for Appraisal and Acquisition
<b>Limited Access Highways</b>		
 <p>PHASE 1 Access Report Plan</p>	<p>State Design Engineer* approves Access Report Plan for prehearing discussion with county and/or city officials.</p> <p>The access report plan may be used for preparation of federal-aid program data for appraisals if federal funds are to be used for right of way acquisition. It may be used for requesting advance appraisal funds through the Program Development Office for all projects with either state or federal funds.</p>	<p>Program appraisals of total takes. (No acquisition.)</p>
<p>PHASE 2 Access Hearing Plan</p>	<p>State Design Engineer* approves Access Hearing Plan for use at a public access hearing. R/W information is complete.</p> <p>The access hearing plan may be used for the preparation of federal-aid program data for negotiations on federally funded projects, and for the preparation of true cost estimates and fund requests.</p>	<p>Program all appraisals and acquisitions.</p> <p>Note: Do not appraise or purchase partial takes in areas subject to controversy. Appraise or purchase total takes only if federal design hearing requirements are met.</p>
<p>PHASE 3 Findings and Order Plan</p>	<p>No signature required.</p> <p>Results of Findings and Order Access Hearing are marked in red and green on Access Hearing plan and sent to OSC R/W Plans Branch.</p>	<p>Program appraisals of partial takes where data is available to appraisers.</p> <p>Acquisition of total takes.</p>
<p>PHASE 4 Final R/W and L/A Plan</p>	<p>State Design Engineer* Approves final R/W and LA plans or approves revisions to established R/W and L/A plans</p>	<p>Program all remaining appraisals and all remaining acquisitions.</p> <p>Note: If appeal period is not complete, delay action in areas subject to controversy and possible appeal.</p>
<b>Access Managed Highways</b>		
<p>PHASE 5 Final R/W Plan</p>	<p>R/W plan submitted to OSC R/W Plans Branch for approval.</p> <p>State Design Engineer* approves new R/W plans or approves revisions to established R/W plans.</p>	<p>Program appraisals</p> <p>Program all appraisals and acquisitions.</p>

\*Or a designee.

**Appraisal and Acquisition**  
*Figure 1410-1*

# 1420

## Access Control Design Policy

- 1420.01 General
- 1420.02 Full Access Control Criteria
- 1420.03 Partial Access Control Criteria
- 1420.04 Modified Access Control Criteria
- 1420.05 Access Approaches
- 1420.06 Approaches Between Limited Access Highways and Adjacent Railroads
- 1420.07 Frontage Roads
- 1420.08 Multiple Use of Right of Way for Nonhighway Purposes
- 1420.09 Modifications to Established Limited Access Plans

### 1420.01 GENERAL

Access control is established to preserve the safety and efficiency of specific highways and to preserve the public investment. Control is effected by acquiring rights of access from abutting property owners, and by selectively limiting approaches to the facility.

Facilities thus controlled are termed limited access or access controlled highways, and are further distinguished as having full, partial, or modified access control. The number of access points per mile, spacing of interchanges or intersections, and the location of frontage roads or local road connections are determined by the functional classification and importance of the highway, the character of the traffic, the present and future land use, the environment and aesthetics, the highway design and operation, and the economic considerations involved.

The establishment of full, partial, or modified control of access shall be considered whenever major improvements, reconstruction, relocation, or new facilities are required on all highways or whenever the route is shown on the Master Plan for limited access highways as planned for access control." The reasonable cost of access control must be evaluated considering future accident costs, future development, improved level of service of controlled facilities, and cost to replace the facility in the future if access control is not implemented. Because specific warrants cannot be logically or economically applied in every circumstance, the Assistant Secretary for Highways may consider exceptions upon presentation of justification for reasonable deviation from the policy.

Expansion of an existing facility may be undertaken without control of access where there is no practical alternative within reasonable cost, subject to approval of a deviation by the State Project Development Engineer. The decision to defer implementation of access control shall be documented in the design report.

Nothing in this policy should be construed to prevent short sections of full, partial, or modified control of access

where unusual topographic, land use, or traffic conditions exist. Special design problems should be dealt with on the basis of sound engineering-economic principles.

Preliminary approval of the degree of access control recommended by the district as presented in the final access plan is granted by headquarters. The final plan is approved by the Transportation Commission, after a public hearing (Chapter 1430), by the signing of a findings and order document.

On all applicable classes of highways, except Interstate, stage development may be used, with initial construction as partial or modified control and ultimate planning for full control.

Turnbacks should be located at points of logical termination such that the department retains an adequate amount of right of way for maintenance of the facility and for other operational functions.

### 1420.02 FULL ACCESS CONTROL CRITERIA

#### (1) Introduction

Fully controlled access highways provide almost complete freedom from disruption by permitting access connections only through interchanges at selected public roads, rest areas, viewpoints, or weighing stations, and by prohibiting all crossings and private connections at grade.

#### (2) Application

Termini of access control sections should be at apparent logical points of design change. The following guides shall be used for the application of full access control on state highways: (Refer to Figure 1420-1a.)

- (a) **Interstate.** Interstate highways require full access control.
- (b) **Principal Arterial.** Unless approved for partial or modified access control on existing highways by the Assistant Secretary for Highways, principal arterial highways requiring four or more through traffic lanes within a 20-year design period require full access control.
- (c) **Minor Arterial and Collector.** Minor arterial and collector highways will not normally be considered for development to full access control standards.

#### (3) Crossroads at Interchange Ramps

The limit of access control is measured from the center line of ramps, crossroads, or parallel roads or from the terminus of transition tapers. (See Figures 1420-1b and 1c.)

(a) **Ramp Connections.** Connections from the highway to abutting property or local service or frontage roads are prohibited within the full length of any off or on interchange ramp. The ramp is considered to terminate at its intersection with the local road which undercrosses or overcrosses the highway or, in urban areas, with its connection to a local street.

(b) **Frontage Road Connections.** Direct connections from the highway to local service or frontage roads are permitted only via the interchange crossroad.

(c) **Interchange Crossroads.** In both urban and rural areas, access control must be established along the crossroad at an interchange for a minimum distance of 300 feet beyond the center line of the ramp or terminus of transition taper. If a frontage road or local road is located in a generally parallel position within 350 feet of a ramp, access control should be established along the crossroad and for an additional minimum distance of 130 feet in all directions from the center of the intersection of the parallel road and crossroad.

For interchanges incorporating partial cloverleaf and/or button-hook ramps, access control is required for all portions of the crossroad and frontage roads between the ramp terminals, and for a distance of 300 feet beyond the ramp terminals. If a grade intersection for a local road or street is to be served directly opposite the ramp terminals, access control should be extended additionally for a minimum of 130 feet, and preferably 300 feet, along that leg of the intersection.

(d) **Levels of Control, Location of Approaches.** Full access control should be provided for the first 130 feet from the center line of the ramp or terminus of a transition taper. If the economic considerations to implement full access control are excessive, partial or modified control may be provided for the remaining distance for a total minimum distance of 300 feet for the two types of control. Type A - residential, Type B - farm, and Type C - special use approaches may be permitted on that portion of the crossroad for which partial or modified control of access is established. Type D - commercial single and Type E - commercial double road approaches are permitted only within the limits of modified access control. Approaches should be sufficiently removed from a frontage road intersection to provide proper intersection operation. Access approach types are further defined in 1420.05.

#### **(4) Location of Utilities, Bus Stops, Mailboxes, and Pedestrian Crossings**

(a) **Utilities.** Utilities location and access shall be consistent with the Utilities Accommodation Policy (WAC 468-34).

(b) **Bus Stops.** No common carrier or school bus stops shall be permitted except at:

- Railroad crossings (Chapter 930);
- Locations provided by the state on the interchanges;
- In exceptional cases, along the main roadway where pedestrian separation is available.

(c) **Mailboxes.** Mailboxes are permitted only on frontage roads. Mail delivery will be from frontage roads or other adjacent local roads.

(d) **Pedestrian Crossings.** Pedestrian crossings shall not be permitted at grade.

#### **(5) Nonmotorized Traffic**

All nonmotorized traffic is prohibited on highways established and operating as fully controlled limited access facilities. This prohibition does not apply to:

- Pedestrian separations or other facilities provided specifically for pedestrian use.
- Bicyclists utilizing facilities provided specifically for bicycle use (i.e., separated paths).
- Bicyclists utilizing the right-hand shoulders, except where such use has been specifically prohibited. Information pertaining to such prohibitions may be obtained from the Traffic Engineering Branch of the Operations and Maintenance Office.

### **1420.03 PARTIAL ACCESS CONTROL CRITERIA**

#### **(1) Introduction**

Partial access control may be established when warranted on highways other than Interstate. Partial control provides a considerable degree of protection from traffic interference and protects the highway from future strip-type development.

Access control on partially controlled highways is exercised to the degree that, in addition to connections with selected public roads, some crossings and private driveway connections may be permitted at grade. Commercial approach types, D, or E are not allowed within the limits of partial access control.

#### **(2) Application**

Termini of access control sections should be at apparent logical points of design change. Refer to Figure 1420-2a.

(a) **Principal Arterial.** When the estimated traffic volumes exceed 3,000 average daily traffic within a 20-year design period, principal arterial highways requiring two through traffic lanes must have partial access control. Modified access control may be approved on existing principal arterial highways by the Assistant Secretary for Highways. For multilane principal arterial highways, see 1420.02(2)(b).

(Exception) Partial access control will not normally be used in urban areas, or inside corporate limits on existing principal arterial highways where traffic volumes are less than 700 DHV, if required levels of urban service, including operating speeds, can be maintained for traffic under existing and estimated future conditions, including traffic engineering operational improvements. If not, the route should be relocated or reconstructed in accordance with the modified or partial access control standards.

- (b) **Minor Arterial.** Rural minor arterial highways on both new and existing location, and urban minor arterial highways on new location, requiring four or more through traffic lanes within a 20-year design period, or requiring only two through traffic lanes where the estimated traffic volumes exceed 3,000 average daily traffic within a 20-year design period, shall require partial access control; however, modified access control may be applied on existing highways when approved by the Assistant Secretary for Highways.

(Exception) Partial access control normally will not be used in urban areas. Nor will it normally be used inside corporate limits on existing minor arterial highways where traffic volumes are less than 700 DHV, if required levels of service (including operating speeds) can be maintained for existing and estimated future conditions. If these conditions cannot be met, the route should be relocated or reconstructed in accordance with the modified or partial access control standards.

Other rural minor arterial highways with only two lanes may be considered for partial or modified control of access if any of the following conditions apply:

- The control can be acquired at a reasonable cost.
  - The route connects two highways of a higher classification.
  - The potential land development would result in numerous individual approaches, such as may be encountered in recreational or rapidly developing areas.
  - The highway traverses publicly-owned lands where access control seems desirable.
- (c) **Collector (New Alignment).** Collector highways on new location requiring four or more through traffic lanes in a 20-year design period shall require partial access control.
- (d) **Collector (Existing).** Existing collector highways will normally be considered for access control only when all of the following conditions apply:
- The highway serves an area which is not directly served by a higher class of highway.
  - Existing or planned development will result in traffic volumes significantly higher than what

would be required for access control on minor arterials.

- Partial or modified access control may be established without a major impact on development of abutting properties within the constraints of zoning established at the time access control is proposed.

### (3) Interchanges and Intersections

- (a) **Interchanges.** See 1420.02(3). Full access control on crossroads at interchange ramps applies equally under conditions of partial control.

- (b) **Intersections.** Access control limits on a partially controlled highway should be established along the crossroad at a grade intersection for a minimum distance of 300 feet from the center line of the nearest directional roadway. If a parallel road is located within 350 feet of the grade intersection, access control should be established along the crossroad for the required minimum 300 feet and for an additional minimum distance of 130 feet in all directions from the center of the intersection of the parallel road and crossroad. On multilane facilities, measurements should be made from the center line of the nearest directional roadway. (Figure 1420-2b.) Modified access control with Type D and E approaches may be permitted beyond 130 feet from the center line of the highway only when the approaches already exist and cannot reasonably be relocated. Approaches closer than 130 feet will be permitted only where application of the normal standards would have a severe adverse effect on existing development and where the location is such that retention of the approaches will not seriously affect traffic operations.

Grade intersections with public roads should be limited to the number permitted for the class of highway involved (Figure 1420-2a); however, shorter intervals may be used, with approval from headquarters, where topography or other conditions restrict the design. When intersecting roads are spaced farther apart than one per mile, median crossings may be considered for U-turns in accordance with Chapter 910. U-turns should be kept to a minimum, consistent with requirements for operation and maintenance of the highway.

### (4) Access Approach Criteria

Access approaches on highways with partial control must be held to a minimum. Except for very large ownerships, or where terrain features will not allow the property to be served by a single approach, allow only one approach for each parcel. Where possible, locate a single approach to serve two or more parcels. Approaches should not be permitted for parcels which have reasonable access to other public roads unless the parcel has extensive highway frontage. Approaches in excess of the standards set

forth in Figure 1420-2a may be permitted as stage construction. The approved design should provide for future development of frontage roads which would eliminate the excessive number of approaches.

On routes with partial access control, only the following approach types may be permitted for direct access to the highways.

- Type A, residential use.
- Type B, farm use.
- Type C, special use (to accommodate utility access).

Commercial access is permitted only by way of public roads. Type D and Type E commercial approaches may be permitted within the access controlled area along intersecting roadways as outlined in 1420.03(3).

To discourage movement in the wrong direction on multilane highways, locate private access openings 300 feet or more from an at-grade intersection. At a tee intersection, a private access opening should be located directly opposite the intersection or a minimum of 300 feet away from the intersection. Extreme caution should be exercised to ensure that a private access opening directly opposite a tee intersection cannot be mistaken for a continuation or part of the public traveled way.

Access approach types are further defined in 1420.05.

### **(5) Location of Utilities, Bus Stops, Mailboxes, and Pedestrian Crossings**

**(a) Utilities.** Utilities location and access shall be consistent with the Utilities Accommodation Policy (WAC 468-34). Connecting utility lines between intermittent frontage roads are permitted along the outer right of way line.

**(b) Bus Stops.** Bus stops for both common carriers and school buses shall not be permitted on either two or four-lane highways, except as follows:

- At railroad crossings (Chapter 930).
- At locations of intersections with necessary pullouts to be constructed by the state.
- Where shoulder widening has been provided for mail delivery service.
- For a designated school bus loading zone on the traveled lane or adjacent thereto which has been approved by the Department of Transportation. Buses are not permitted to stop on the traveled lanes at at-grade intersections or private approaches, to load or unload passengers.

School bus loading zones on partially controlled access highways shall be posted with school bus loading zone signs, in accordance with the latest edition of the *Manual on Uniform Traffic Control Devices*.

**(c) Mailboxes.** Mailboxes shall be located on frontage roads or at intersections with the following exceptions for properties which are served by Type A or B approaches:

- Mailboxes for Type A or B approaches on a four-lane highway shall be located only on the side of the highway on which the approach is provided.
- Mailboxes for Type A or B approaches on a two-lane highway shall be located on that side of the highway which is on the right in the direction of the mail delivery.

Whenever mailboxes are allowed, a mailbox turnout should be provided to allow mail delivery vehicles to stop clear of the through traffic lanes. See Chapter 730 for additional information concerning mailbox locations and turnouts.

**(d) Pedestrian Crossings.** Pedestrian grade crossings will be permitted only where an at-grade crossing is provided. Pedestrian crossings may be permitted:

- On two-lane highways at mailbox locations.
- On two-lane highways not less than 100 feet from a school bus loading zone adjacent to the traveled lane, if school district and Department of Transportation personnel determine that stopping in the traveled lane is hazardous.
- On two-lane highways when the school bus is stopped on the traveled lane to load or unload passengers and the proper sign and signal lights are displayed.

### **(6) Nonmotorized Traffic**

Pedestrian and bicycle traffic will be permitted, consistent with Rules of the Road, on partially controlled highways, except when unusual safety conditions warrant prohibition. Information pertaining to such prohibitions may be obtained from the Traffic Engineering Office of the Program Development Division.

## **1420.04 MODIFIED ACCESS CONTROL CRITERIA**

### **(1) Introduction**

Modified access control is intended to prevent further deterioration in the safety and operational characteristics of existing highways due to traffic interference associated with strip development by limiting the number and location of access points to the highway.

### **(2) Application**

In general, modified access control is applied where some degree of control is desired, but existing and potential commercial development preclude the implementation of partial or full control.

(a) **Existing Highways.** Modified access control may be established on existing highways other than Interstate. Priority should be given to route segments where one or both of the following conditions apply:

- Commercial development potential is high, but most of the adjoining property remains undeveloped.
- There is a reasonable expectation that the adjoining property will be redeveloped to a more intensive land use resulting in greater traffic congestion.

(b) **Design Analysis.** Selection of facilities on which modified access control may be applied is based on a design analysis including the following factors:

- Traffic volumes.
- Level of service.
- Safety.
- Level of Development Plan.
- Route continuity.
- Population density.
- Local land use planning.
- Present and potential land use.
- Predicted growth rate.
- Economic analysis.

(c) **Exceptions.** Where modified access control is to be established, developed commercial areas may be excepted from control when all or most of the abutting property has been developed to the extent that few, if any, additional commercial approaches would be required with full development of the area.

### (3) Interchanges and Intersections

(a) **Interchanges.** Access control is applied in the same manner at interchanges as on full control, see 1420.02(3).

(b) **Intersections.** Access control limits at intersections on highways with modified control should be established along the crossroad for a minimum distance of 130 feet from the center line of a two-lane highway or for a minimum of 130 feet from the center line of the nearest directional roadway of a four-lane highway (Figure 1420-3). Approaches, especially Type D and Type E commercial approaches, should be permitted within this area only when there is no reasonable alternative.

### (4) Access Approach Criteria

The number and location of approaches on a highway, with modified access control, must be carefully planned to provide a safe and efficient highway compatible with present and potential land use.

(a) **Approach Types.** On highways with modified access control, the following approach types may be permitted:

- Type A, residential.
- Type B, farm.
- Type C, approaches to serve more than one owner and/or utility
- Type D, commercial single (existing).
- Type E, commercial double (existing).

The type of access provided for each parcel shall take into consideration present and potential land use and should be based on an economic evaluation which considers the following:

- Local comprehensive plans, zoning, and land use ordinances.
- Property covenants and/or agreements.
- City or county ordinances.
- The highest and best use of the property.
- Highest and best use of adjoining lands.
- Change in use by merger of adjoining ownerships.
- All other factors bearing upon proper land use of the parcel.

Access approach types are further defined in 1420.05.

(b) **Design Considerations.** The following conditions are used to determine the number and location of access approaches:

1. Parcels which have access to another public road or street are not normally permitted direct access to the highway.
2. Approaches located in areas where sight limitations create undue hazard should be relocated or closed.
3. The number of access approaches should be held to a minimum. Access approaches are limited to one approach for each parcel of land, with the exception of extensive frontages where one approach is unreasonable or for Type E approaches which feature separate off and on approaches.
4. Joint use of access approaches shall be considered, where feasible.
5. Additional approaches may be permitted for future development consistent with local zoning.
6. Existing access approaches not meeting the above criteria should be closed.

### (5) Location of Utilities, Bus Stops, Pedestrian Crossings, and Mailboxes

(a) **Utilities.** Utilities location and access shall be consistent with the Utilities Accommodation Policy (WAC 468-34). Connecting utility lines between

intermittent frontage roads are permitted along the outer right of way line.

**(b) Bus Stops and Pedestrian Crossings.** Bus stops and pedestrian crossings may be permitted as follows:

- In rural areas, bus stops and pedestrian crossings shall be subject to the same restrictions as in 1420.03(5)(b).
- In urban areas, bus stops for both commercial carriers and school buses may be permitted without restriction.

**(c) Mailboxes.** Mailboxes may be located adjacent to or opposite all authorized approaches as follows:

- Mailboxes on a four-lane highway shall be located only on the side of the highway on which the approach is provided.
- Mailboxes on a two-lane highway shall all be located on that side of the highway which is on the right in the direction of the mail delivery.

Where mailboxes are allowed, a mailbox turnout should be provided to allow mail delivery vehicles to stop clear of the through traffic lanes. See Chapter 730 for additional information concerning mailbox locations and turnouts.

## **(6) Nonmotorized Traffic**

Pedestrian and bicycle traffic is permitted, consistent with Rules of the Road, on highways with modified access control, except where unusual safety considerations warrant prohibition. Information pertaining to such prohibitions may be obtained from the Traffic Engineering Branch of the Operations and Maintenance Office.

### **1420.05 ACCESS APPROACHES**

#### **(1) General**

Access approaches may be permitted on limited access highways consistent with the criteria outlined in 1420.02, 1420.03, 1420.04, and 1420.06.

For additional information pertaining to approaches, refer to Chapters 920 and 1410, and the *Plans Preparation Manual*, M 22-31.

#### **(2) Definitions**

The widths for the following approach types should be negotiated, and only the negotiated width shall be shown on the plan.

**(a) Type A Approach.** Type A Approach is an Off and On approach in legal manner, not to exceed 30 feet in width, for the sole purpose of serving a single family residence. It may be reserved by the abutting owner for specified use at a point satisfactory to the state at or between designated highway stations.

**(b) Type B Approach.** Type B Approach is an Off and On approach in legal manner, not to exceed 50 feet in width, for use necessary to the normal operation of a farm, but not for retail marketing. It may be reserved by the abutting owner for specified use at a point satisfactory to the state at or between designated highway stations.

**(c) Type C Approach.** Type C Approach is an Off and On approach in legal manner, for special purpose and width to be agreed upon. It may be specified at a point satisfactory to the state at or between designated highway stations.

**(d) Type D Approach.** Type D Approach is an Off and On approach in a legal manner not to exceed 50 feet in width for use necessary to the normal operation of a commercial establishment. It may be specified at a point satisfactory to the state at or between designated highway stations.

**(e) Type E Approach.** Type E Approach is a separated Off and On approach in a legal manner, with each opening not exceeding 30 feet in width, for use necessary to the normal operation of a commercial establishment. It may be specified at a point satisfactory to the state at or between designated highway stations.

### **1420.06 APPROACHES BETWEEN LIMITED ACCESS HIGHWAYS AND ADJACENT RAILROADS**

#### **(1) General**

A highway and railroad are considered adjacent when they have a common right of way border with no other property separating them. This applies only to railroads on operating right of way and not to adjacent railroad property which is not directly used for railroad operation.

#### **(2) Warrants**

It is in the public interest to provide access to the railroad right of way from limited access highways for maintenance of the railroad and utilities located on the railroad right of way when other access is not feasible. This applies both to new highways and to existing highways where access control is obtained.

Direct access is permitted when local roads are infrequent or there are few highway-railroad crossings from which trail-type access for maintenance purposes is feasible, and when unique topography or other unusual conditions justify its use.

Direct access from the highway is considered unnecessary and is not permitted when:

- There are local roads adjacent to or crossing the railroad.

- A trail-type road can be provided by the railroad between crossroads.
- A roadway is paralleled by a frontage road adjacent to the railroad. Access between frontage roads is permitted as for any other nonlimited access road. Frontage roads may be connected to the freeway only by intersections and interchanges provided for the general public.
- No highway previously existed adjacent to the railroad.

### **(3) Restrictions**

When direct approaches to provide access to railroad right of way are warranted, the following conditions must be met:

- A maximum of one approach is permitted for every 2 miles of highway.
- The approach must not adversely affect the design, construction, stability, traffic safety, or operation of the highway.
- Except when the railroad is located in the median area, the approach is to be accomplished in legal manner by right turns only to and from the roadway nearest the railroad. Median crossing is not permitted.
- The approach is secured by a locked gate under arrangements satisfactory to the department. (See 1420.05(2)(c).)
- Parking of any vehicles or railroad equipment is prohibited within highway access control lines.
- A special emergency maintenance permit must be obtained for periods of intensive railroad maintenance.
- The approach must be closed if the railroad operation ceases.
- Approaches are limited to use by the railroad company unless specific provisions for other use are shown on the plan and included in the right of way negotiations.

## **1420.07 FRONTAGE ROADS**

### **(1) General**

Frontage roads are provided in conjunction with limited access highways to:

- Control access to through lanes.
- Provide access to abutting land ownership.
- Restore continuity of the local street or road system.
- Provide continuity when the construction causes unreasonable circuitry of travel. On partially controlled highways, when the number of property access openings exceed the requirements in Figure 1420-2a, a frontage road should be considered.

Refer to Chapter 620 for frontage road standards and general policy and to Chapter 330 for frontage road justification required in the design report.

Frontage roads that are not the responsibility of the state under the terms of this policy may be built by the state upon request of a local political subdivision, a private agency, or an individual, by agreement under which the state is reimbursed for all costs involved.

### **(2) County Road and City Street Connections**

Short sections of county roads or city streets not adjacent to the highway may be constructed to connect roads or streets that have been closed off by the highway if the connection will serve the same purpose and be less costly than a frontage road.

### **(3) Cul-de-Sacs**

Frontage roads or local streets bearing substantial traffic that are terminated or closed at one end should be provided with a cul-de-sac, or other facility consistent with the local policy or practice, sufficient to permit vehicles to turn around without encroachment on private property.

### **(4) Turnbacks**

Local agency approval is required for any planned frontage roads, county road or city street connections, or cul-de-sacs. The local agency must also agree in writing to accept and maintain the connecting section as a county road or city street. See *Utilities Manual*, M 22-87, for turnback procedure.

## **1420.08 MULTIPLE USE OF RIGHT OF WAY FOR NONHIGHWAY PURPOSES**

Use of right of way by either a private party or public agency is permitted by one of the following as applicable:

- **Airspace Agreement (Nonhighway Use).** Refer to the *Right of Way Manual*, M 26-01, Section 11-6.
- **Permit or Franchise (Highway, Nonhighway, or Utility Use).** Refer to the *Utilities Manual*, M 22-87, Chapter 1.
- **Utility Easement (Highway or Utility Use).** Refer to the *Utilities Manual*, M 22-87, Chapter 2.
- **Agreement (Highway or Utility Use).** Refer to the *Utilities Manual*, M 22-87, Chapters 4 and 5, e.g., Private Party Agreement, Chapter 4. United States Bureau of Reclamation Blanket Crossing Agreement, Chapter 5.

Agreements for the nontransportation use of right of way must be coordinated with the appropriate district supervisor. Such use typically includes, but is not



limited to, landscaping, parking, storage, utilities, and construction of facilities, such as buildings. Unless specifically provided in the airspace agreement, permit, or franchise, direct access to the traveled way of any access controlled roadway is not permitted. Access may be permitted from outside the access controlled area for the specified use.

## **1420.09 MODIFICATIONS TO ESTABLISHED LIMITED ACCESS PLANS**

### **(1) General**

Revisions to established limited access facilities can only be made by application of current design criteria and with the approval of the Assistant Secretary for Highways. The following factors shall be considered when evaluating a request for modification of an established limited access facility:

- Existing level of access control on the highway,
- Functional classification and importance of the highway,
- Percentage of truck traffic,
- Highway operations,
- Present or future land use,
- Environment or aesthetics,
- Economic considerations,
- Safety considerations.

All revisions to established limited access highways should be evaluated to determine if a public hearing is required.

### **(2) Modifications for Private Access Approaches**

**(a) Requirements.** Examples of access modification requested by individual owners include additional road approaches, changes in the permitted use, or number of users of existing road approaches.

Plan revisions which provide for additional access to individual ownerships after the department has purchased the access rights are normally not considered. However, these revisions may be considered if it can be established that:

- The efficiency and safety of the highway will not be significantly affected,
- There are no other reasonable alternatives,
- The existing situation causes extreme hardship on the owner(s), and
- The revision is consistent with the access control standards for the class of highway and level of existing or planned future access control.

### **(b) Procedures.**

- District initiates an engineering review of the requested modification.
- District prepares and submits to headquarters Plans Branch a preliminary limited access plan revision together with a recommendation for preliminary approval by the Assistant Secretary for Highways. When federal aid funds were involved in any phase of the project, the proposed modification will be sent to FHWA for their review and approval.
- The recommendation should include an item by item analysis of the factors listed in 1420.09(1) and (2a) above.

**(c) Valuation Determination.** Upon the Assistant Secretary for Highways' preliminary approval, district Land Management prepares an appraisal for the value of the access change.

- The appraisal follows the requirements set forth in the *Right of Way Manual*.
- The appraisal is reviewed by the headquarters Land Management Office. If the appraisal data does not support a value of \$1,500 or more, a minimum value of \$1,500 shall be used.
- For well documented special cases where it does not appear appropriate to base the charges on the reviewed appraisal, district Land Management documents the circumstances that support granting the requested change at less than the review appraisers determined value in an administrative settlement letter.
- The appraisal package is sent to the headquarters Land Management Office for review. If federal aid funds were involved in purchasing access, a copy of the administrative settlement letter will be sent to FHWA for their review and approval.
- The final value is submitted to the Assistant Secretary for Highways for his approval.

### **(d) Final Processing.**

- District Land Management informs the requestor of the approved appraised value for the change.
- If requestor is still interested, district prepares a "Surplus Disposal Package" for headquarters Land Management Office review and Assistant Secretary for Highways approval.
- At the same time, the preliminary limited access plan revision previously transmitted is processed for Assistant Secretary for Highways approval.
- After the department collects the payment from the requestor, the district issues a permit for the construction, if required.

- Headquarters Land Management Office prepares and processes a deed granting the modified access rights.

### **(3) Modifications for public grade intersections**

#### **(a) Requirements.**

- Public grade intersections on state highways with partial access control should serve local arterials that form part of the local transportation network.
- Requests for new intersections on established limited access highways must be made by or through the local governmental agency.
- New intersections require full application of current access control design and spacing criteria.

#### **(b) Procedures.**

- District evaluates request.
- District submits intersection plan for approval (Chapter 910) and right of way and limited access plan revision request (*Plans Preparation Manual*, M 22-31, ).

- State Project Development Engineer approves intersection plan.
- Assistant Secretary for Highways approves access revision.
- District submits construction agreement to State Project Development Engineer (*Utilities Manual*).
- Assistant Secretary for Highways approves construction agreement.

#### **(c) Valuation Determination.**

- When a requested public grade intersection will serve a local arterial that forms part of the local transportation network, compensation will not be required.
- When a requested public grade intersection will serve only a limited area or is primarily for the benefit of a limited number of developers, compensation for access change will be addressed in the plan revision request. In situations where compensation is appropriate, value will be determined as outlined in 1420.09(2)(c) above.

ITEM	FUNCTIONAL HIGHWAY CLASS			
	INTERSTATE	PRINCIPAL ARTERIAL RURAL & URBAN	MINOR ARTERIAL	COLLECTOR
Traffic est. year beyond R/W plan approval	REQUIRED FOR ALL ROUTES	20	FULL CONTROL NOT NORMALLY REQUIRED	FULL CONTROL NOT NORMALLY REQUIRED
Lanes required		4 or more		
Termini		Principal cities, or Junctions with Interstates or other Principal Arterial Routes		
2 Lanes within 4 lane R/W		Where 25% or less between termini required only 2 lanes		
New locations		All new locations meeting other criteria for Full Control		

**FULL ACCESS CONTROL CRITERIA**

Figure 1420-1a

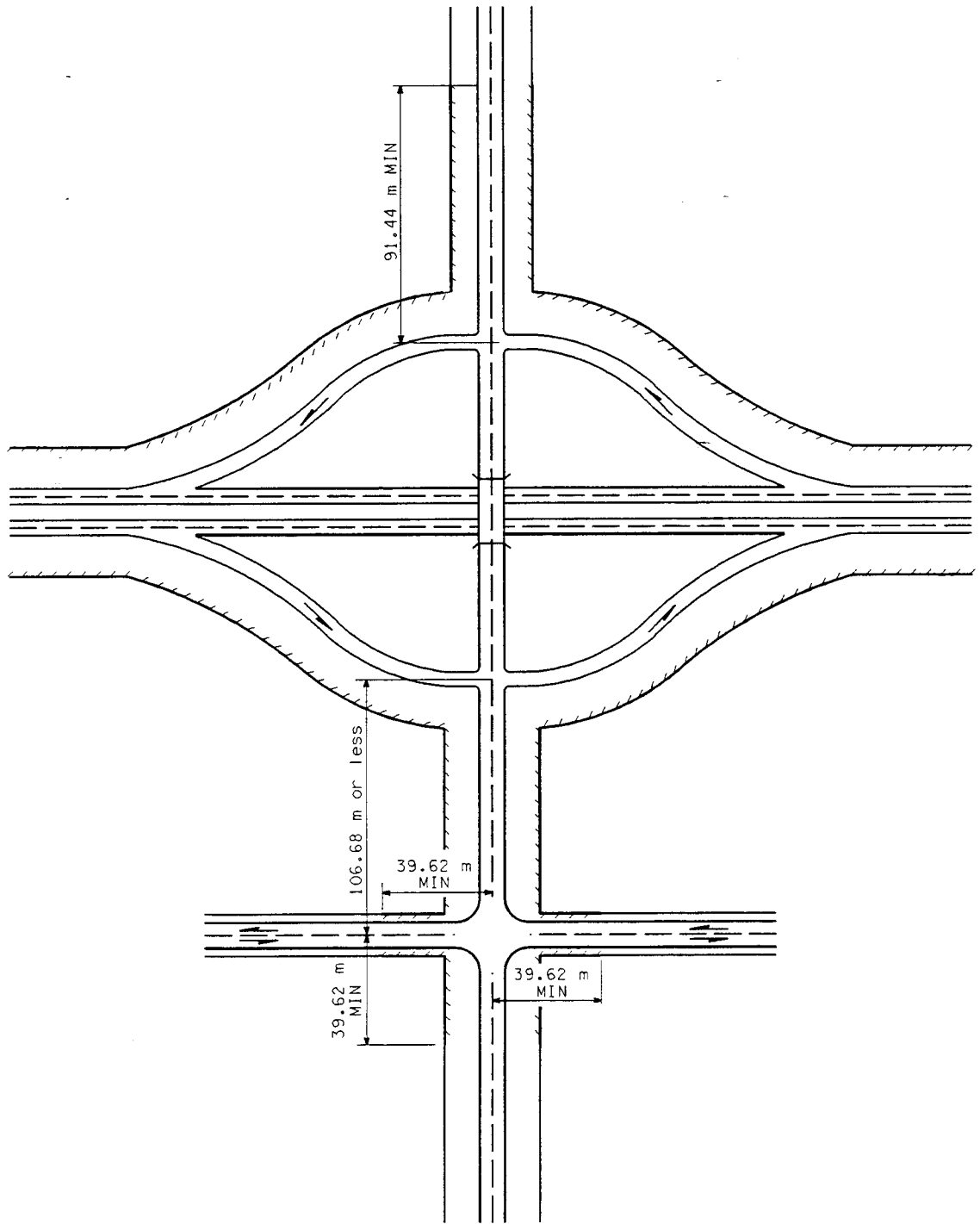

**ACCESS CONTROL FOR TYPICAL INTERCHANGE**

Figure 1420-1b  
(Metric)

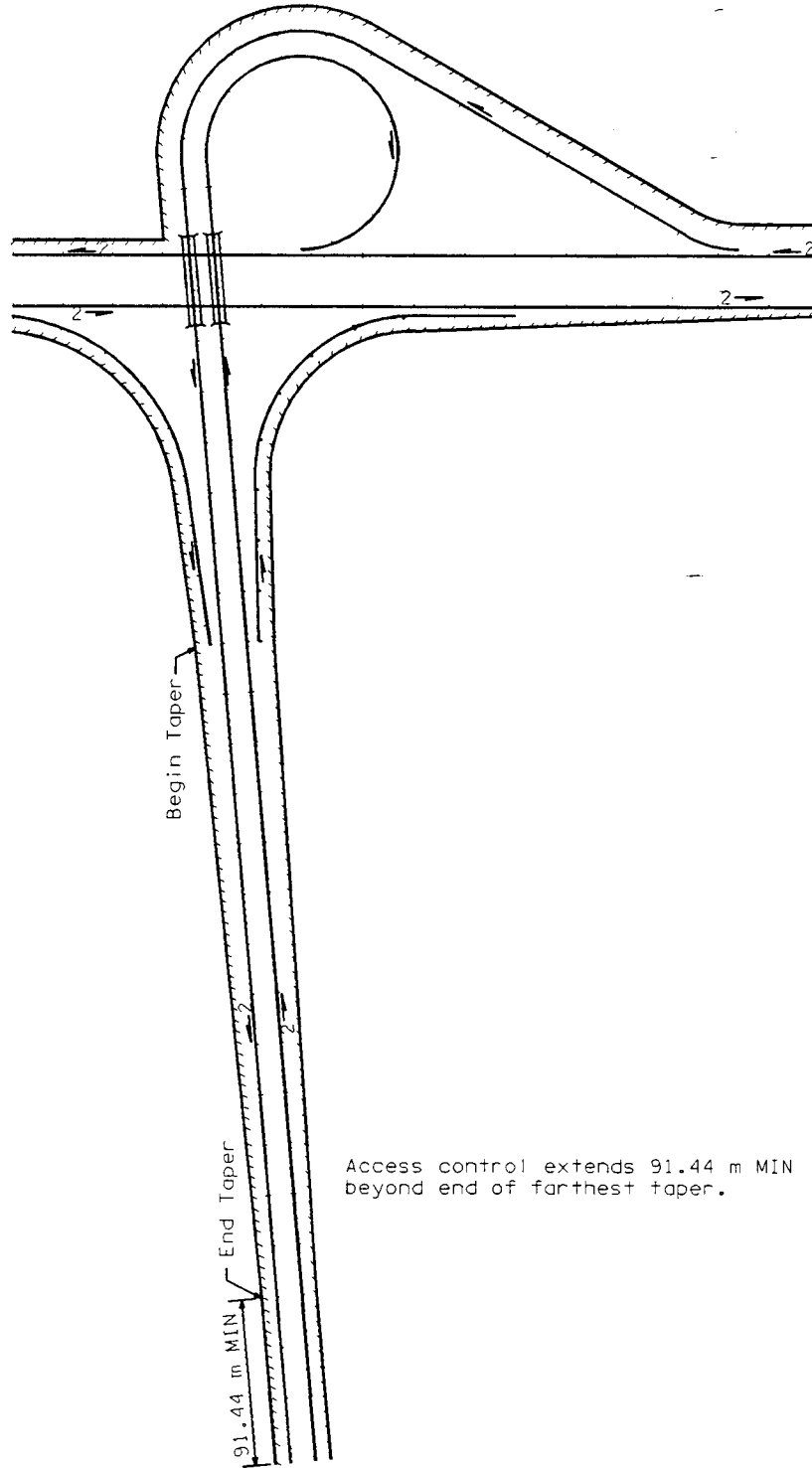

**ACCESS CONTROL AT RAMP TERMINATION**

Figure 1420-1c  
(Metric)

Item		Functional Highway Class				
		Interstate	Principal Arterial	Minor Arterial		Collector
Traffic Estimate Year Beyond Right of Way Plan Approval			20	20 Urban and Rural	20 Rural Only	20
ADT			Over 3,000	Not Applicable	Over 3,000	Not Applicable
Lanes Required			2	4	2	4
Minimum Route Length			All Sections Not Requiring Full Control as Per Figure 1420-1a	Urban . . . 3.2 km Rural . . . 8.0 km Combined . . . 4.8 km		Logical Points of Design Change
New Locations Including Bypass			Limit All Property Access – Allow Public Roads as Below	Limit All Property Access – Allow Public Roads as Below		Limit Property Public Roads as Below
All Other Locations Requiring or Permitting Partial Control	Property Access	Not Applicable	2 per Side per 1.6 km Plus Public Roads	4 per Side per 1.6 km Plus Public Roads		Public Road or Property Access 6 per Side per 1.6 km
	Public Road at Grade Junctions		Crossroads < 2,000 ADT Minimum 1.6 km Spacing	All 2-lane and 4-lane Where Crossroad < 2,000 ADT Minimum 0.8 km Spacing		
Plan for Highway Separation				Crossroad ADT Over 2,000 in 20 Years	Same as Principal Arterial	None

**PARTIAL ACCESS CONTROL CRITERIA**

Figure 1420-2a  
(Metric)

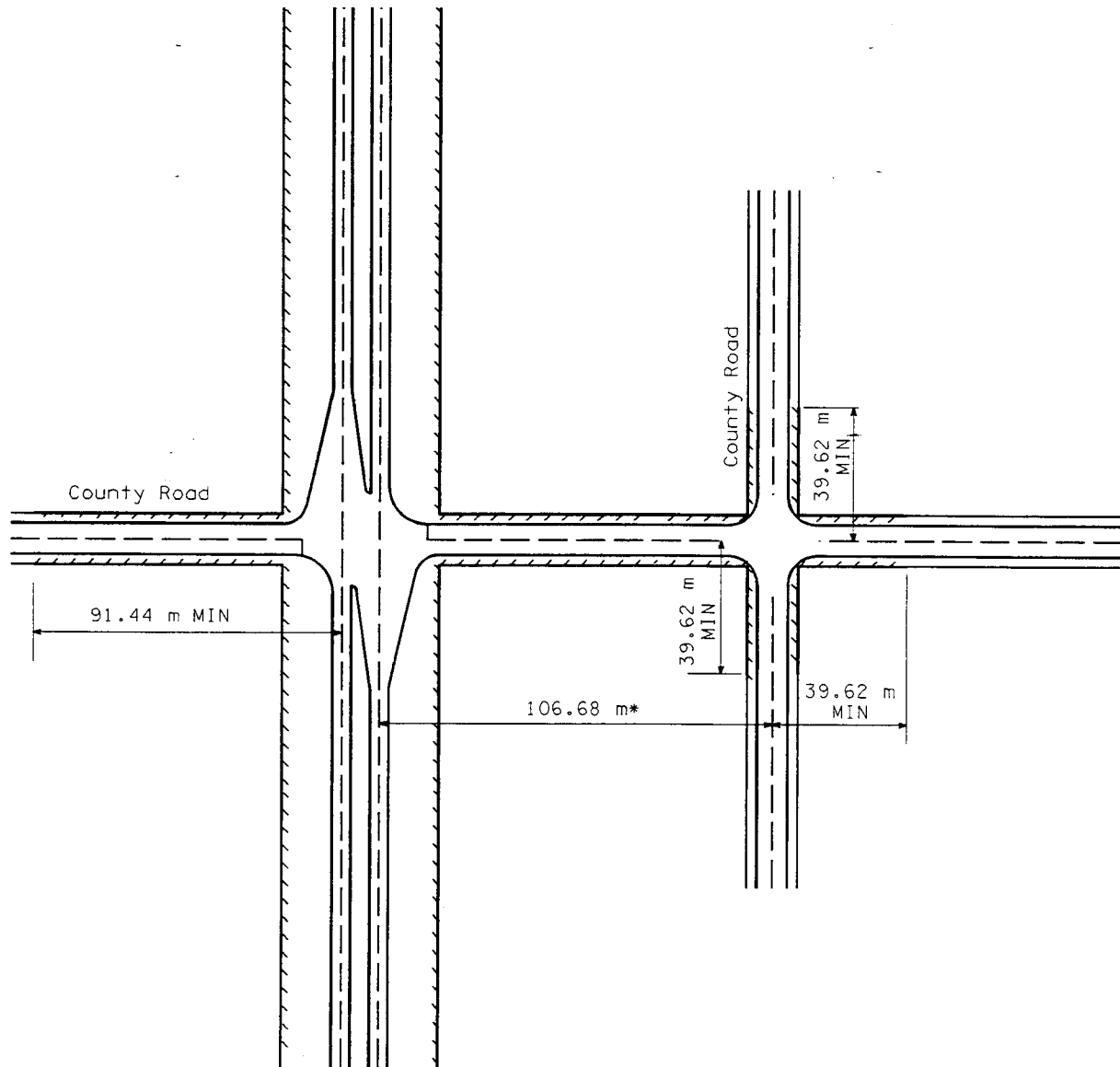

\* For Frontage road located 106.68 m or less from the center line of the nearest directional roadway, access control should be extended 39.62 m in all directions.

**ACCESS CONTROL FOR INTERSECTION AT GRADE**

Figure 1420-2b  
(Metric)

Access Control Limits at Intersections  
Modified Control Highways  
Two-Lane

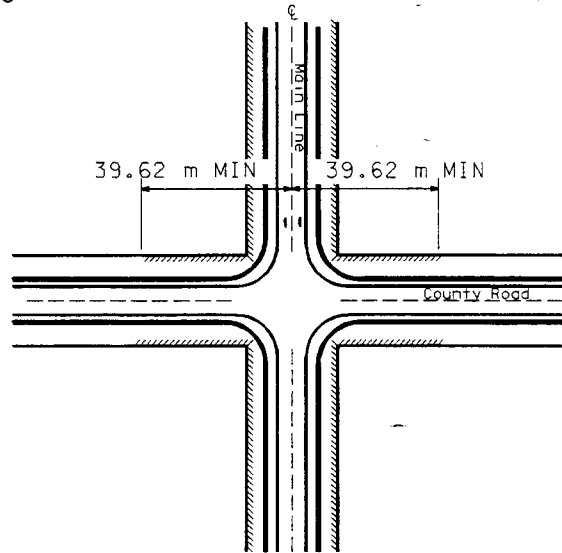

Access Control Limits at Intersections  
Modified Control Highways  
Multi-Lane

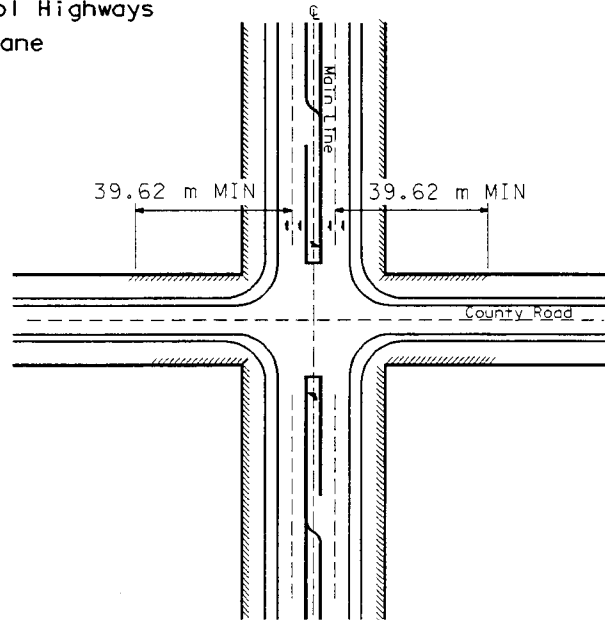

**ACCESS CONTROL LIMITS AT INTERSECTIONS**

Figure 1420-3  
(Metric)





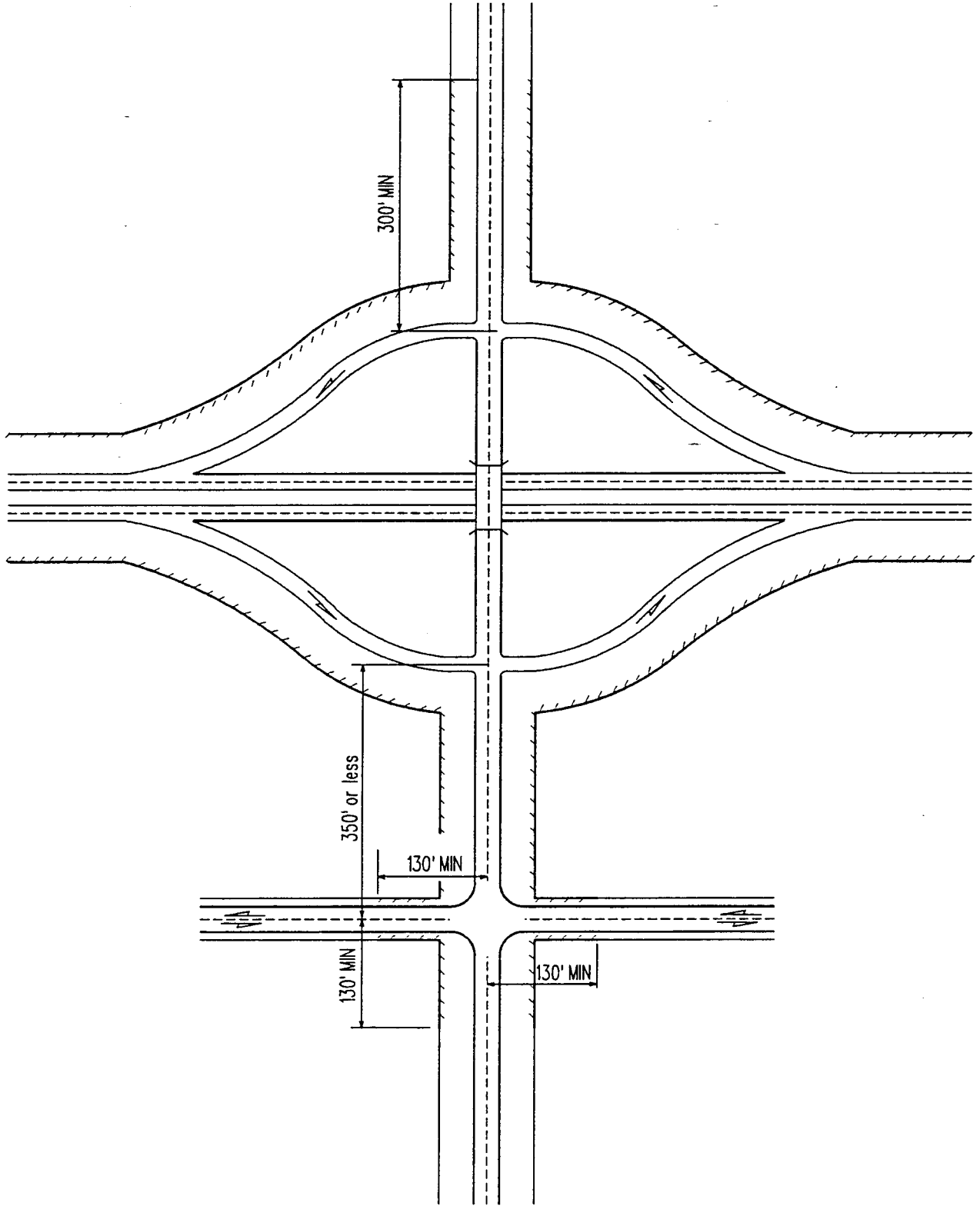

**ACCESS CONTROL FOR TYPICAL INTERCHANGE**

Figure 1420-1b

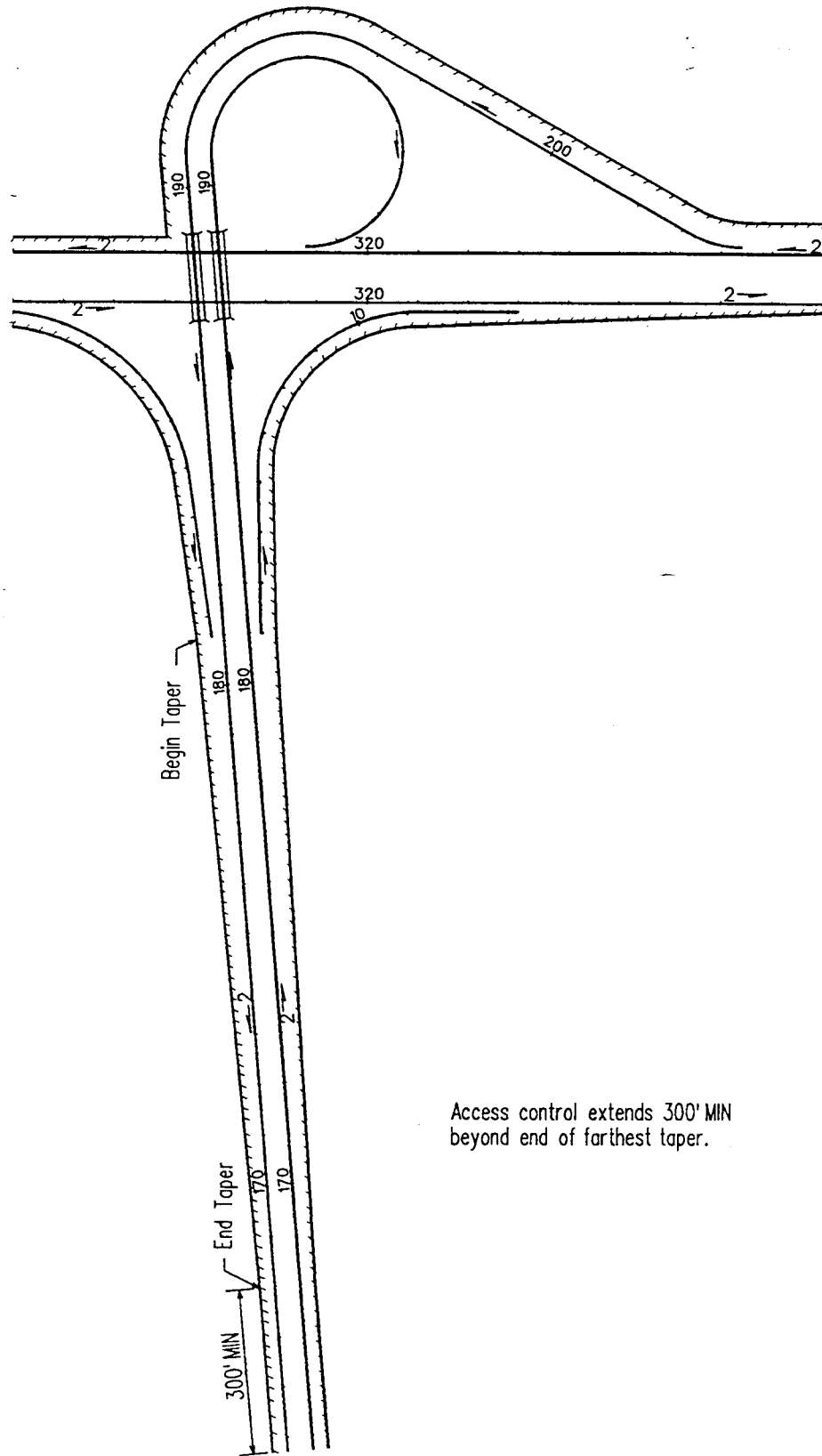

**ACCESS CONTROL AT RAMP TERMINATION**

Figure 1420-1c

PARTIAL ACCESS CONTROL CRITERIA

ITEM		FUNCTIONAL HIGHWAY CLASS				
		INTERSTATE	PRINCIPAL ART.	MINOR	ARTERIAL	COLLECTOR
TRAFFIC EST. YR. BEYOND R/W PLAN APPROVAL			20	20 URBAN & RURAL	20 RURAL ONLY	20
ADT			OVER 3,000	NOT APPLICABLE	OVER 3,000	NOT APPLICABLE
LANES REQUIRED			2	4	2	4
MINIMUM ROUTE LENGTH			ALL SECTIONS NOT REQUIRING FULL CONTROL AS PER FIGURE 1420-1a	URBAN..2 MILES RURAL..5 MILES COMB.. 3 MILES		LOGICAL POINTS OF DESIGN CHANGE
NEW LOCATIONS INCLUDING BYPASS			LIMIT ALL PROPERTY ACCESS - ALLOW PUB. ROADS AS BELOW	LIMIT ALL PROPERTY ACCESS - ALLOW PUB. ROADS AS BELOW		LIMIT PROP. PUBLIC ROADS AS BELOW
ALL OTHER LOCATIONS REQUIRING OR PERMITTING PARTIAL CONTROL	PROPERTY ACCESS	NOT APPLICABLE	2 PER SIDE PER MILE PLUS PUBLIC ROADS	4 PER SIDE PER MILE PLUS PUBLIC ROADS		PUBLIC ROAD OR PROPERTY ACCESS 6 PER SIDE PER MILE
	PUBLIC ROAD AT - GRADE JUNCTIONS		CROSSROADS < 2,000 ADT. MINIMUM ONE MILE SPACING	ALL 2 - LANE & 4 - LANE WHERE CROSSROAD < 2,000 ADT, MINIMUM 1/2 MILE SPACING		
PLAN FOR HIGHWAY SEPARATION			CROSSROAD ADT. OVER 2,000 IN 20 YEARS	SAME AS PRINCIPAL ARTERIAL	NONE	RURAL ONLY CROSSROAD ADT OVER 4,000 IN 20 YEARS

**PARTIAL ACCESS CONTROL CRITERIA**

Figure 1420-2a

x For Frontage road located 350' or less from the centerline of the nearest directional roadway, access control should be extended 130' in all directions.

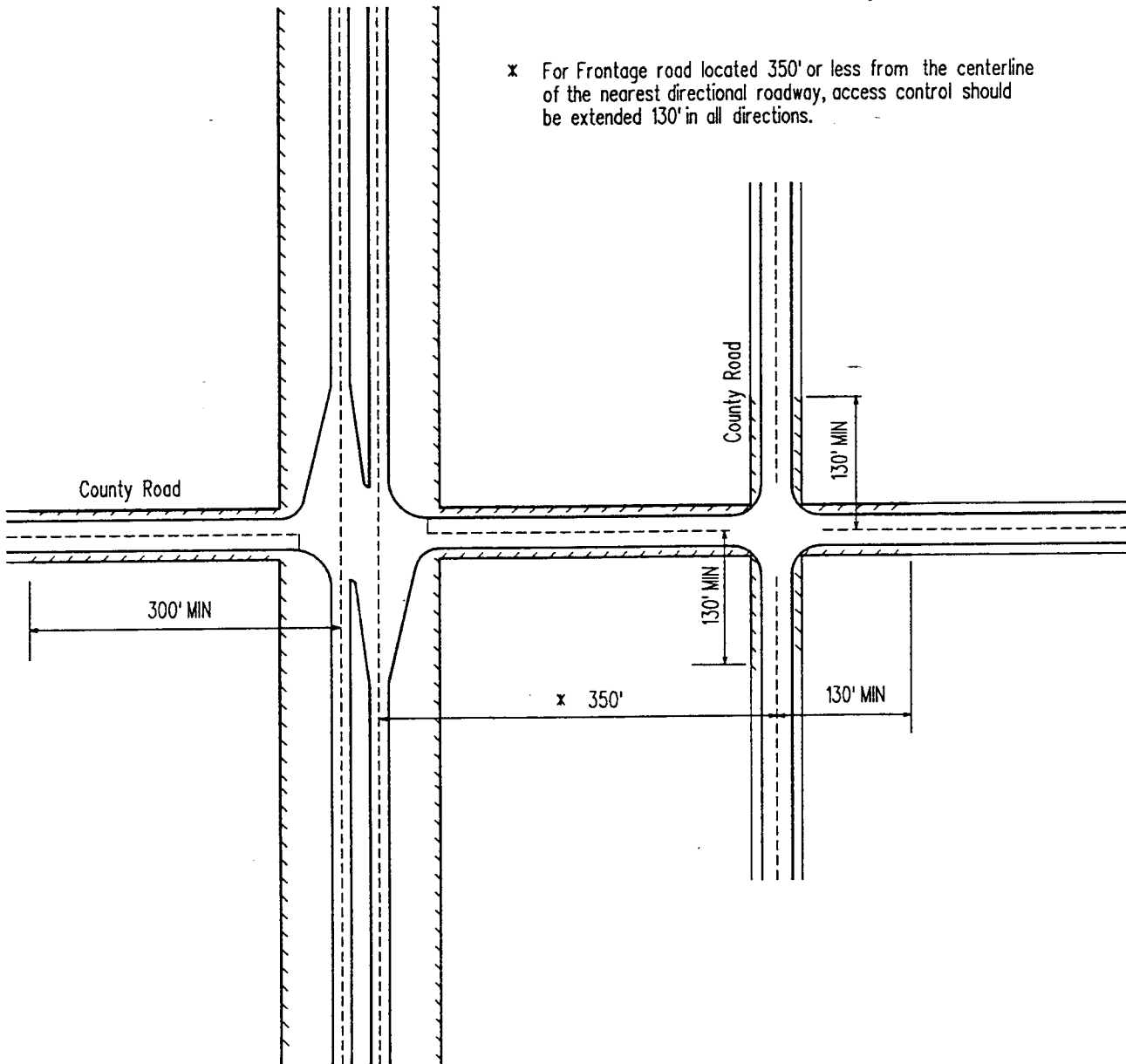

## ACCESS CONTROL FOR INTERSECTION AT GRADE

Figure 1420-2b

Access Control Limits at Intersections  
Modified Control Highways  
Two-Lane

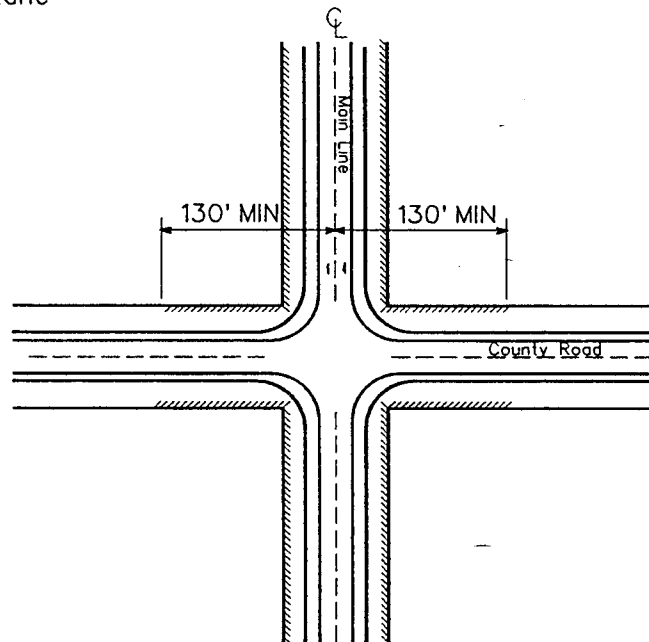

Access Control Limits at Intersections  
Modified Control Highways  
Multi-Lane

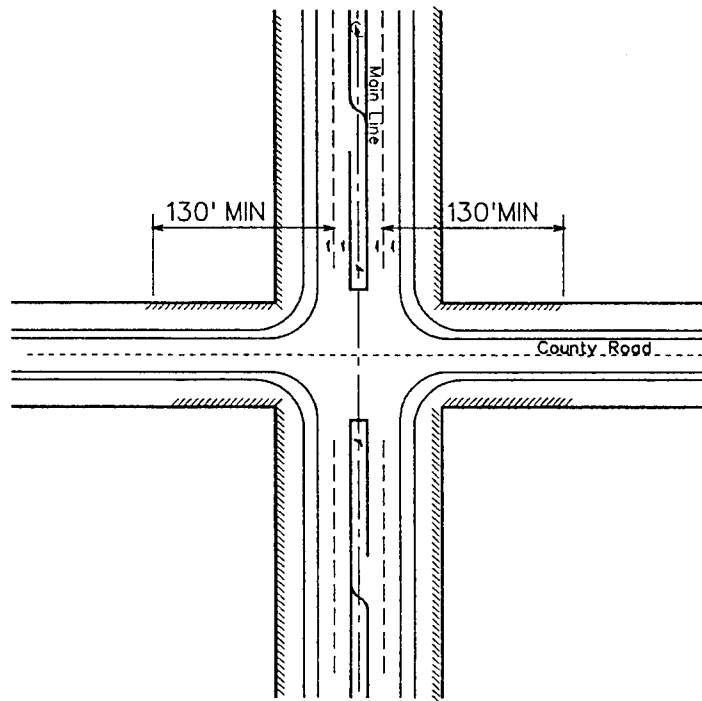

**ACCESS CONTROL LIMITS AT INTERSECTIONS**

Figure 1420-3

- 1425.01 General
- 1425.02 References
- 1425.03 Definitions
- 1425.04 Procedures
- 1425.05 Access Point Decision Report and Supporting Analyses
- 1425.06 Documentation

### 1425.01 General

It is in the public's interest that the state's freeways be maintained and protected to provide the highest practical level of service in terms of safety and mobility. Federal laws and both FHWA and WSDOT policies require a formal request, with an Access Point Decision Report, for any access point revision that might adversely affect through traffic on a freeway in Washington State. The report is used for a decision-making process and documents the planning, evaluation, design, and coordination that support and justify the request.

In theory, a transportation project such as a new interchange would begin with a study of a large section of the freeway system to determine existing and future access needs. The needs would become part of a statewide plan. Alternatives would be suggested and evaluated. Preliminary proposals would be selected and evaluated. A final proposal would be selected, analyzed, approved, designed, constructed, maintained, and monitored.

But that is not always the source of a proposal.

If a revised access point proposal is not the result of system planning, then the process of evaluating the alternative has to go back to the beginning to study the system throughout the affected area and determine whether or not an access point revision will be the best reasonable alternative. Sometimes it is not — for example, because it would interfere with Interstate travel, or because modifications to the local surface system would be a better and more reasonable solution for accommodating local traffic.

For all but the simplest projects, WSDOT recommends that a support team be used to help integrate the planning, programming, and design efforts that lead to development of a proposal. The Project Definition process, Value Engineering studies, public involvement efforts, environmental analyses, and analyses for the Access Point Decision Report all use similar data and try to find the best way to meet the needs. The team is charged with achieving creative and reasonable identification of possible alternatives — guiding selection of the best from the alternatives to develop a proposal — and providing guidance from potential reviewers to the decision report developers in order to streamline the report-development process and meet the reviewers' requirements.

An Access Point Decision Report is a stand-alone decision document that includes all supporting information for ready reference by those reviewing the request. (For example, information drawn from the planning documents and the Project Summary is included.) It includes information about the proposed project that includes the access point revision and information about all other improvements that are needed for the access revision to function as intended.

After the Access Point Decision Report is reviewed, if the revised access proposal is acceptable it is given a *finding of engineering and operational acceptability* and approved concurrently with the appropriate environmental documents.

For consistency, this chapter provides the sequence of presentation and guidance for developing the required documentation.

### 1425.02 References

Notice of policy statement: "Additional Interchanges to the Interstate System," Federal Highway Administration notice published in the Federal Register, October 22, 1990. (Vol. 55, No. 204)

Notice of policy statement: “Additional Interchanges to the Interstate System,” Federal Highway Administration notice published in the Federal Register on Wednesday, February 11, 1998. (Vol. 63, No. 28) (Accessible in [http://www.access.gpo.gov/su\\_docs/fedreg/a980211c.html](http://www.access.gpo.gov/su_docs/fedreg/a980211c.html), under FHWA notices, “Interstate system, additional interchanges, policy statement, 7045-7047.”)

*United States Code* 23 USC section 111

*Code of Federal Regulations* 23 CFR part 450 (implementing 23 USC section 111)

*Code of Federal Regulations* 40 CFR parts 51 and 93 (regarding federal conformity with state and federal air quality implementation plans)

*Highway Capacity Manual*, Special Report No 209 (HCM), Transportation Research Council

*Forecasting and Methods Matrix*, WSDOT (when available)

### 1425.03 Definitions

**alternatives** Possible components of a proposal — including design options, locations, and travel demand management and transportation system management type improvements such as ramp metering, mass transit, and high occupancy vehicle (HOV) facilities.

**access point** Any point that allows entrance to or exit from the traveled way of a freeway. (This includes “locked gate” access.)

**access point revision** A new access point, a change in existing interchange/intersection configuration, or the relocation of an existing access point.

**freeway** For this chapter only, a *freeway* is any multilane divided highway with limited access control that is on the Interstate System or the Washington State Highway System.

**need** For this chapter only, an existing or anticipated travel demand requiring a change in access to the state’s freeway system.

**proposal** The combination of alternatives that is being submitted for approval by way of a request and an Access Point Decision Report. A proposal

would have one or more projects involving access point revision alternatives and other projects and actions necessary for the needs to be addressed and the access revisions to function as intended.

**traveled way** The portion of the roadway intended for the movement of vehicles, exclusive of shoulders and lanes for parking, turning, and storage for turning.

### 1425.04 Procedures

Figures 1425-1a and 1b list the project types most likely to affect freeway efficiency, thus requiring a formal request and an Access Point Decision Report. Figure 1425-2 lists the project types least likely to require a request and decision report. If there is any question whether an Access Point Decision Report is required, consult the OSC Access and Hearings Engineer and, if on the Interstate System, the FHWA Transportation and Environmental Engineer.

Gaining acceptance and approval for an access point revision is a multistep process. (See the Access Point Decision Report Flow Chart, Figures 1425-3a and 3b.)

**(1) The first step:** to identify needs and develop a proposal. When going through the process of developing a proposal, it is important to use the data and analysis methods required for an Access Point Decision Report in order to easily document the process.

(a) Are there existing or anticipated needs? Might a new or revised access point be an appropriate solution (Figure 1425-3a, box 1)?

(b) If the proposed solution includes an access point revision, determine whether the proposed access point revision is reflected in a Regional Transportation Improvement Plan, a Metropolitan Transportation Improvement Plan, or the State Highway System Plan, or whether it is the result of a developer, local agency, or regional request. If needed, conduct a comprehensive freeway study, revisit the land use and transportation plans, and revise the State Highway System Plan to include the need for an access point revision (Figure 1425-3a, boxes 2 and 3).



(c) Establish a support team for all new access points and for major revisions to existing access points (Figure 1425-3a, box 4). The core decision-making team consists of:

- FHWA Transportation and Environmental Engineer (if Interstate)
- Region's Design or Project Development Engineer
- OSC Assistant State Design Engineer
- OSC Access and Hearings Engineer
- OSC Traffic Office representative
- Representative of the proponent
- Recorder

The core team is encouraged to call upon specialists as needed, for example:

- Metropolitan Planning Organization
- WSDOT region
  - Planning
  - Environmental
  - Traffic
  - Maintenance
  - Safety
  - Access Point Decision Report writer
- OSC
  - Design
  - Bridge
  - Geotechnical
- Local agencies
- Transit agencies

The team's role is to:

- Develop a charter that includes the processes for reaching consensus, resolving disputes, and assigning responsibility for final decisions when consensus is not reached.
- Expedite the decision report development and review process through early communication and agreement.

- Provide guidance and support.
- Contribute to identification of possible alternatives.
- Define the study and decision report parameters.
- Ensure compatibility of data used in various studies.
- Agree on impact areas and travel forecasts for each of the alternatives being considered.
- Help integrate the Project Definition process studies, Value Engineering studies, public involvement efforts, environmental analyses, operational analyses, and analyses for the Access Point Decision Report. This can encourage use of consistent data.
- Address deviation issues. (Representatives from approving agencies participate in problem-solving.)
- Provide conclusions promptly, in writing, to the persons preparing the Access Point Decision Report.
- Contribute material for the decision report that documents the opposing point of view when consensus was not reached.
- Review results.

**(2) The second step:** to prepare a detailed decision report using the guidance in 1425.05 "Access Point Decision Report and Supporting Analyses" (Figure 1425-3a, boxes 5 through 9).

The Access Point Decision Report usually addresses eight specific policy topics in detail. (See Figures 1425-1a and 1b for exceptions.) They are, in order of presentation:

1. Future Interchanges
2. Land Use and Transportation Plans
3. Reasonable Alternatives
4. Need for the Access Point Revision
5. Access Connections and Design
6. Operational and Accident Analyses
7. Coordination
8. Planning and Environmental Processes

The extent of the decision report varies considerably with the scope of the access point revision. For example, for locked gates and emergency temporary access to sites normally accessed by another route, the application for approval may be condensed to a letter format that includes adequate justification.

The Access Point Decision Report is begun early in the environmental process because its analyses help define the area of impact and the range of alternatives. Since the traffic data required for NEPA or SEPA and the operational analyses of the decision report are similar, these documents are usually developed together using the same data sources and procedures.

**(3) The third step:** acceptance based on an Access Point Decision Report that defines the proposed access point revision and other needed modifications to the main line and the local surface system to protect freeway operations and safety.

The region, with the help of the support team, prepares the Access Point Decision Report and submits four copies (two for non-Interstate) to the Access and Hearings Engineer (in the Design Office, Olympia Service Center) for review and submittal for acceptance and approval. When the access point revision is on an Interstate freeway, regardless of funding sources, the State Design Engineer submits the decision report to FHWA with a request for acceptance and approval (Figure 1425-3b, box 10).

Acceptance of the proposed access point revision by FHWA or the State Design Engineer is a *finding of engineering and operational acceptability*. For state routes, the State Design Engineer's acceptance is given concurrently with environmental approval (Figure 1425-3b, boxes 11 through 14).

Some Interstate access point revisions are reviewed by FHWA at the local divisional level in Washington State and consequently require less time for a determination of acceptability and final approval. Others are reviewed by the Federal Highway Administrator in Washington, DC, and can require a more protracted review and acceptance process. See Figure 1425-1b for details.

FHWA final approval requires that the National Environmental Policy Act (NEPA) procedures are followed. The NEPA procedures are accomplished as part of the normal project development process and as a condition of the access approval. Final access point approval cannot precede the completion of the NEPA process. To offer maximum flexibility, however, any proposed access point(s) may be submitted for a determination of engineering and operational acceptability prior to completion of the NEPA process. A determination can be made as to whether or not a proposal is acceptable for inclusion as an option in the environmental process.

**(4) The fourth step:** for Interstate projects, is the FHWA final approval of the access point revision that is given concurrently with the local division level environmental approval (as in the case of a Record of Decision) or as part of the NEPA approval (Figure 1425-3b, box 15).

## 1425.05 Access Point Decision Report and Supporting Analyses

Begin the Access Point Decision Report with an executive summary. Briefly state what access point revision is being submitted for a decision and why the revision is needed. Include a brief summary of the proposal and the impacts and mitigative measures of the proposal.

For any new access point on an existing freeway to be considered for acceptance and approval, all eight policy points must be addressed in the Access Point Decision Report. If the project modifies an existing access point, see Figures 1425-1a and 1b for the required policy points. (See Figure 1425-2 for project types that might not require a decision report.)

Follow the summary statement with a numbered outline representing the eight policy points being covered in the decision report. In the outline, provide a sentence or two that very briefly answers each policy point's question. If one of the eight policy points is not included, briefly justify its omission. Figure 1425.1a or 1b might be referenced as justification or, for instance, if there are no documents for number seven, its

outline entry might read: “**7. Coordination.** No developers are involved and no work on the local system is proposed.”

All eight policy points are provided numbered tabs in the decision report. The Access Point Decision Report must be assembled in the numbered order. An empty tab is justified in the outline.

The following guidance for each policy point is written for the most extreme condition — a new interchange in an urbanized area. The scope of the analyses and documentation need not be as extensive for more modest access point revisions. Factors that affect the scope include location (rural or urban), access points (new or revised), ramps (new or existing), ramp terminals (freeway or surface system), and intersections (revise or replace with interchange or over/undercrossing).

The following guidance on the preparation of the decision report applies to routes in both rural and urban areas.

Each of the policy points is part of the decision report to answer the question given at the beginning of the discussion.

### **(1) Future Interchanges**

*Is the proposed access point revision compatible with a comprehensive network plan?*

In areas where the potential exists for future multiple interchange additions, support all requests for revised access points by a comprehensive freeway network study with recommendations that address all proposed, reasonable, and desired access points within the context of a long-term plan for that area.

In larger urban areas, regional plans might be too generalized to specify individual interchanges. To plan the relative priority of new access points, a plan refinement study or traffic circulation study must be completed.

The study must demonstrate that the proposed revised access point is compatible with other feasible new access points that have already been proposed.

Reference and summarize any comprehensive freeway network study, plan refinement study, or traffic circulation study.

Explain the consistency of the proposed access point revision with those studies.

### **(2) Land Use and Transportation Plans**

*Is the proposed access point revision compatible with all land use and transportation plans for the area?*

Show that the proposal is based on consideration of and is consistent with local and regional land use and transportation plans. Before final approval, all requests for access point revisions must be consistent with the metropolitan and/or statewide transportation plan, as appropriate. (See Chapter 120.)

Reference the existing and proposed land use plan and the regional and local transportation plans and studies that apply to the area.

Explain the consistency of the proposed access point revision with those plans and studies, the applicable provisions of 23 CFR Part 450, and the applicable transportation conformity requirements of 40 CFR Parts 51 and 93.

If the proposed access is not specifically referenced in the transportation plans, define its consistency with the plans and indicate the process for the responsible planning agency to incorporate the project. In urban areas, the plan refinement must be adopted by the metropolitan planning organization (MPO) before the project is designed.

The proposed access point revision will affect adjacent land use and, conversely, land use will affect travel demand generated. Therefore, reference and show compatibility with the land use plans, zoning controls, and transportation ordinances in the affected area.

### **(3) Reasonable Alternatives**

*Have all reasonable alternatives been assessed and provided for?*

Explain how the preferred proposal provides for all reasonable alternatives that are currently justified and includes provisions to accommodate alternatives that meet the identified future (design year) needs. (For example, if ramp metering and an HOV bypass meet future needs, they are provided for by constructing adequate storage or by acquiring adequate right of way for future construction.) Future projects must be coordinated as described in policy point 7 below.

Describe all reasonable alternatives that have been considered — the design options, locations, and transportation system management type improvements (such as ramp metering, mass transit, and HOV facilities) that have been assessed.

Describe alternatives that were proposed and then rejected as being unreasonable.

Explain why omitted reasonable alternatives were dismissed.

### **(4) Need for the Access Point Revision**

*What are the current and projected needs and why won't the existing access points and existing or improved local system meet the needs? Is the anticipated demand short or long trip?*

Provide a narrative section that describes the need for an access point revision and explains why existing access points do not address the need and how the proposal does meet the anticipated travel demand. Provide the analysis and data to support the access request.

(a) **Narrative.** Describe the needs being addressed and describe the proposal in detail. Include all reasonable alternatives for design options, location, and travel demand management and transportation system management type improvements that are proposed to address the needs. Show that any alternative that might affect the need for the proposal has been considered in the needs analyses.

Show that the existing interchanges/intersections and the local surface system can neither provide the necessary access nor be improved to satisfactorily accommodate the design-year travel demands. Describe traffic mitigation measures considered at locations where the level of service is or will be below service standards.

Show that the access point revision portion of the proposal is primarily to meet regional (not local) travel demands. Distinguish between local and regional traffic (trip link and/or route choice).

(b) **Analysis and Data.** The data analysis procedures and study areas used must be acceptable to the support team.

Show that a preliminary (planning level) analysis, comparing build to no-build data, was conducted and included the following steps:

- Define the study areas. The proposed access point revision will affect adjacent land use and, conversely, land use will affect travel demand generated. For a possible new interchange, there might be more than one study area depending on build/no-build options and the associated land use development levels.
- Develop current and design year (20 years from start of construction) peak hour traffic estimates for the regional and local systems in the subarea of the proposal. Use regional transportation planning organization based forecasts refined, as necessary, by accepted travel demand estimating procedures. Forecasts for specific ramp traffic can require other methods of estimation procedures and must be consistent with the projections of the travel demand models. (See the *Forecasting and Methods Matrix*, when available.)
- Identify the origins and destinations of trips on the local systems, the existing interchange/intersections, and the proposed access.
- Assign the appropriate travel demand to improvements that might be made to:

- The surface system such as: widen, add new surface routes, coordinate the signal system, control access, improve local circulation, or improve parallel roads or streets.
- The existing interchanges such as lengthen or widen ramps, add park and ride lots, or add frontage roads.
- The freeway lanes such as add collector-distributor roads or auxiliary lanes.
- Transportation system management and travel demand management measures.
- Describe the current and design year level of service at all affected locations within the study area; including local systems, existing ramps, and freeway lanes.

### **(5) Access Connections and Design**

*Will the proposal provide fully directional interchanges connected to public roads, spaced appropriately, and designed to full design level geometric control criteria?*

Wherever possible, provide for all directions of traffic movements. The intent is to try to provide full movement at all interchanges. Less than fully directional interchanges for special-purpose access for transit vehicles, for HOVs, or to or from park and ride lots will be considered on a case-by-case basis.

A proposed interchange access must connect to a public highway, road, or street.

Discuss interchange spacing and how the proposed access point relates to present and future proposed configurations and the spacing recommendations.

Show that the proposed access point revision will be designed to meet or exceed current full design level (Chapters 325, 440, 640, 940, and 1050, for example). Present the information in sufficient detail to be used for an operational analysis. For example, include the number of lanes, horizontal and vertical curvature, lateral clearance, lane width, shoulder width, weave distance, ramp taper, and all traffic movements, if appropriate. This information is presented as a simple sketch

or a more complex layout depending on the complexity of the proposal. Construction plans, specifications, and estimates of quantities are not necessary.

When existing nonstandard features are to be retained, explain why they are nonstandard and justify the decision not to improve them to standard. The support team helps determine the extent of reconstruction to be proposed and rules on any suggestions regarding deviations for new work that are being considered to become part of the proposal.

Show that all new ramp terminals will be designed to meet or exceed current state and local full design level geometric control criteria.

### **(6) Operational and Accident Analyses**

*How will the proposal affect safety and traffic operations now and for the next 20 years?*

The support team plays a critical role in operational and accident analysis decisions such as selecting appropriate procedures, defining affected areas, selecting appropriate data, and defining “significant adverse impact.” These are project-specific decisions.

The reporting for policy point six is documentation of the procedures used to do the operational and accident analyses and the results that support and justify the proposal.

Once the (preferred) proposed access revision has been selected, show that it will not have a significant adverse impact on the (a) operation and (b) safety of the freeway and the affected surface system, or that the impacts will be mitigated. If this cannot be shown, the needs and alternatives are revisited, using more detailed information, to develop a different proposal.

Show that the analysis procedures and study areas used are acceptable to the support team.

Document the results of the following analyses in the decision report as appropriate:

- An operational analysis for both the opening and design years of the existing freeway and the affected surface system.

- An operational analysis for both the opening and design years of the proposed future freeway and the affected surface system for the preferred proposal.
- An accident analysis for both opening and design years of the existing freeway and the affected surface system, and for the proposed future freeway and affected surface system.

The data used must be consistent with the data used in the environmental documentation. If not, provide justification for the discrepancies.

(a) **Operational Analyses.** Demonstrate that the proposal does not have a significant adverse impact on the operation of the freeway or the adjacent affected surface system or that the impacts will be mitigated.

Use appropriate operational analysis procedures. For complex urban projects, a refined model might be necessary. As a minimum, the latest accepted *Highway Capacity Manual* (HCM) might be appropriate. Any procedure used must provide a measure of effectiveness compatible with the HCM. Include data sufficient to allow independent verification of the results by using the HCM.

All (design level) operational analyses shall be of sufficient detail and include sufficient data and procedure documentation to allow independent analysis and concurrence during FHWA or OSC evaluation of the proposal.

Prepare a sketch or layout displaying adjacent affected facilities and the following data. Include this sketch or layout in the body of the decision report where it is readily available to the reviewers. Show:

- Distances between intersections or ramps of a proposed interchange and that of adjacent interchanges.
- Design speeds.
- Grades.
- Truck volume percentages on the freeway, ramps, and affected roadways.
- Adjustment factors (peak hour factors, etc.).

- Freeway, ramp, and affected surface system traffic volumes (including turning volumes) forecasts for each option, including a “no-build” scenario, in the AM and PM peaks (also, noon peaks, if applicable) and average daily traffic (ADT), for the opening and design year.
- Current year (report year) traffic volumes based on traffic counts.
- Main line, ramp, and affected surface system lane configurations.

The required minimum limits of the analysis on the freeway are through the adjacent and proposed interchanges/intersections on both sides of the access point revision unless it is documented that the proposal has no impacts on the adjacent interchanges/intersections. If the interchanges/intersections are closely spaced, it might be necessary to go beyond adjacent interchanges/intersections. In urban areas, extend the analyses far enough to include the extent of the traffic impacts.

The required limits of the capacity analysis on the surface system are the extent necessary to show that the system can safely and adequately collect and distribute any new traffic loads resulting from the access point revision. Expand the limits of the study area, if necessary, to analyze the coordination required with an in-place or proposed traffic signal system. Document the limits of the analysis as well as how the limits were established.

Document the results of analyzing the existing access and the proposed access point revision at all affected locations within the limits of the study area (such as, weave, merge, diverge, ramp terminals, accident sites, and HOV lanes) along the affected section of freeway (main line and ramps) and on the affected surface system. In the decision report, highlight the following:

- Any location for which there is a significant adverse impact on the operation or safety of the freeway facility (such as causing a reduction of the operational efficiency of a merge condition at an existing ramp,

introducing a weave, or significantly reducing the level of service on the main line due to additional travel demand) as well as what will be done to mitigate this adverse impact.

- Any location where a congestion point will be improved or eliminated by the proposal (such as proposed auxiliary lanes or collector-distributor roads for weave sections).
- Any surface system conditions that will affect traffic entering or exiting the freeway. If entering traffic is to be metered, explain the effect on the connecting surface system (for example, vehicle storage).
- When the existing facility does not meet the desired level of service, show how the proposal will improve the level of service or keep it from becoming worse than the future level with no change in access.

(b) **Accident analyses.** Demonstrate that the proposal does not have a significant adverse impact on the safety of the freeway or the adjacent affected surface system or that the impacts will be mitigated.

The required minimum limits of study are the same as for the operational analyses.

Identify all safety program (I2) locations. Where appropriate, identify accident histories, rates, and types for the freeway section and the adjacent affected surface system. Project the rates that will result from traffic flow and geometric conditions imposed by the proposed access point revision. Document the basis for all assumptions.

### **(7) Coordination**

*Are all coordinating projects and actions programmed and funded?*

When the request for an access point revision is generated by new or expanded development (such as private developer or new park and ride lot), demonstrate appropriate coordination between the development and the changes to the transportation system.

Show that the proposal includes a commitment to complete the other noninterchange/nonintersection improvements that are necessary for the interchange/intersection to function as

proposed. For example, the local circulation system must be in place before new ramps are opened to traffic and there must be commitment to the travel demand management and transportation system management concepts included in the proposal. If future reconstruction is part of the mitigation for design year level of service, the reconstruction projects must be in the State Highway System Plan.

All elements for improvements must be shown to include a fiscal commitment and a definite time for completion.

If the access point is to be designed as a left-side connection for HOV use only, include a commitment to close the access, rather than to open it to general use, if the HOV demand is moved to another access point or it declines to a level that no longer justifies the access.

### **(8) Planning and Environmental Processes**

*What is the status of the proposal's planning and environmental processes?*

All requests for access point revisions on Interstate freeways must contain information on the status of the planning process. Show that the following federal objectives have been considered and report the proposed project's relationship to meeting them.

Federal law (23 USC 111) requires that "*each state carry out a transportation planning process that provides for consideration of projects and strategies that will:*

(a) *Support the economic vitality of the United States, the states, and metropolitan areas, especially by enabling global competitiveness, productivity, and efficiency.*

(b) *Increase the safety and security of the transportation system for motorized and nonmotorized users.*

(c) *Increase the accessibility and mobility options available to people and for freight.*

(d) *Protect and enhance the environment, promote energy conservation, and improve quality of life.*

*(e) Enhance the integration and connectivity of the transportation system, across and between modes throughout the state, for people and freight.*

*(f) Promote efficient system management and operation.*

*(g) Emphasize the preservation of the existing transportation system.”*

All requests for access point revisions on free-ways must contain information on the status of the environmental process. The following are just a few examples of status information that might apply.

- Are the environmental documents presently or soon-to-be submitted for approval?
- What applicable permits and approvals have been obtained and are pending?
- Are there hearings still to be held?
- Is the environmental process waiting for an engineering and operational acceptability decision?

## **1425.06 Documentation**

The following documents are to be preserved in the project file.

- Request for acceptance and approval and the associated Access Point Decision Report and records.
- Acceptance and approval documents.
- Justification for omitting a request and decision report.

P65:DP/DMM



Project Type	Support Team	Policy Point								Acceptance *	Approval *	
		1	2	3	4	5	6	7	8			
<b>Full and Partial Access Control</b> (See Chapter 1420.)												
<b>For Interstate Freeways</b>											FHWA	FHWA
<b>For Non-Interstate Freeways</b>											OSC	OSC
New freeway-to-crossroad interchange in a transportation management area (1)	R	S F	S F	S F	S F	S F	S F	S F	S F	S F	N or ✓	L or ✓
New freeway-to-crossroad interchange not in a transportation management area (1)	R	S F	S F	S F	S F	S F	S F	S F	S F	S F	L or ✓	L or ✓
New partial interchange	R	S F	S F	S F	S F	S F	S F	S F	S F	S F	N or ✓	L or ✓
New HOV direct access to and/or from the median	R	S F	S F	S F	S F	S F	S F	S F	S F	S F	N or ✓	L or ✓
New freeway-to-freeway interchange	R	S F	S F	S F	S F	S F	S F	S F	S F	S F	N or ✓	L or ✓
Modification to freeway-to-freeway interchange in a transportation management area (1)(2)	R	S F	S F	S F	S F	S F	S F	S F	S F	S F	N or ✓	L or ✓
Modification to freeway-to-freeway interchange not in a transportation management area (1)(2)	R	S F	S F	S F	S F	S F	S F	S F	S F	S F	L or ✓	L or ✓
Modification to interchange (3)	R	S F	S F	S F	S F	S F	S F	S F	S F	S F	L or ✓	L or ✓
Addition of entrance or exit ramps that complete basic movements at existing interchange	R	S F	S F	S F	S F	S F	S F	S F	S F	S F	L or ✓	L or ✓
Abandonment of a ramp (4)	R	S F	S F	S F	S F	S F	S F	S F	S F	S F	L or ✓	L or ✓
Locked gate (Letter Format)	No			B	B	(5)	B				L or ✓	L or ✓
Emergency temporary access to site normally accessed by another route. (Letter Format)	No			B	B	(5)	B				L or ✓	L or ✓

See legend and notes next page.

\* See legend item next page.

**Access Point Decision Report Content and Review Levels**  
Figure 1425-1a

Project Type	Support Team	Policy Point								Acceptance *	Approval *
		1	2	3	4	5	6	7	8		
<b>For Partial and Modified Access Control Freeways</b> (See Chapter 1420.)									OSC	OSC	
New intersection or access point, partial access control	R	S	S	S	S	S	S	S	S	✓	✓
New intersection or access point, modified access control	R			S	S	(5)	S			✓	✓
Change intersection to interchange or over/undercrossing (6)	R	S		S	S	S	S			✓••	✓••
Modify interchange with effects	R			S	S		S		(7)	✓	✓
Modify intersection with effects	R			S	S					✓	✓

\* See 1425(3) regarding acceptance and 1425(4) regarding approval.

•• See Figure 1425-2 for exceptions

FHWA Federal Highway Administration.

OSC Olympia Service Center, Design Office. The Access and Hearings Engineer coordinates acceptance and approval.

B Brief (policy point) report item required.

✓ OSC acceptance and approval.

F On the Interstate system, a (policy point) report item required by FHWA.

L For Interstate, FHWA acceptance or approval at the local division level, which can be expected to take from 1 to 4 months, or longer, depending on the complexity of the project and its environmental processes.

N For Interstate, FHWA acceptance at the national level, which can be expected to take from 3 to 12 months, or longer, depending on the complexity of the project and its environmental processes.

R Recommended.

S On a non-Interstate route, a (policy point) report item required by the state.

Notes:

- (1) A transportation management area is a county with a population greater than 200,000. In Washington they are Clark, King, Pierce, Snohomish, Spokane, and Yakima Counties.
- (2) "Modification" includes changes in interchange configuration even though the number of access points does not change. Changing from a cloverleaf to a directional interchange is an example of a "modification." However, for non-Interstate, if the modification does not add new lanes and can be shown to have no adverse impacts, and the spacing and geometric control criteria requirements will be met, omit the request and document justification to the design file.
- (3) Modifications that might adversely affect the level of service of the through lanes. Examples: doubling lanes for an on-ramp with double entry to the freeway; adding a loop ramp to an existing diamond interchange, replacing a diamond ramp with a loop ramp.
- (4) Unless it is a condition of the original approval.
- (5) Sketch only.
- (6) Changing an intersection to an over/undercrossing if all conditions on Figure 1425-2 are met.
- (7) Only if data is not consistent between the decision report and the environmental analyses.

**Access Point Decision Report Content and Review Levels**

*Figure 1425-1b*

<b>Project Type</b>	<b>Comments</b>
Modify existing freeway to freeway interchange	To bring to standard
Revise existing component (lengthening or widening)	To meet current geometric control criteria
Ramp modification at the crossroad with no effect on the through lanes of the freeway	New right turn pocket, for example
Add a lane to a ramp that merges before entering the through lane	Adding a lane at the on/off access point requires a decision report
Reconstruct intersection at grade having HAL, HAC, or FAL concerns	Changing an intersection to an interchange or over/undercrossing requires a report unless all geometric control and policy criteria are met.
Modification of the intersection of a ramp and a crossroad	Signalize, redo radii, for example

**Note:**

The table above shows some, but not all, of the types of access revisions that do not require a request and Access Point Decision Report if the following conditions are met.

- It is documented that there will be no adverse impact on the freeway.
- The data used is consistent with the data used in the environmental analyses.
- The access is designed to the design level required by the appropriate Design Matrix.
- Access spacing meets requirements in Chapter 940.
- The project is approved per Chapter 330 as part of the Project Summary approval process.
- Omission of the request and decision report is justified to file with a copy sent to the state Access and Hearings Engineer.

**Access Point Decision Report Possibly Not Required**

*Figure 1425-2*

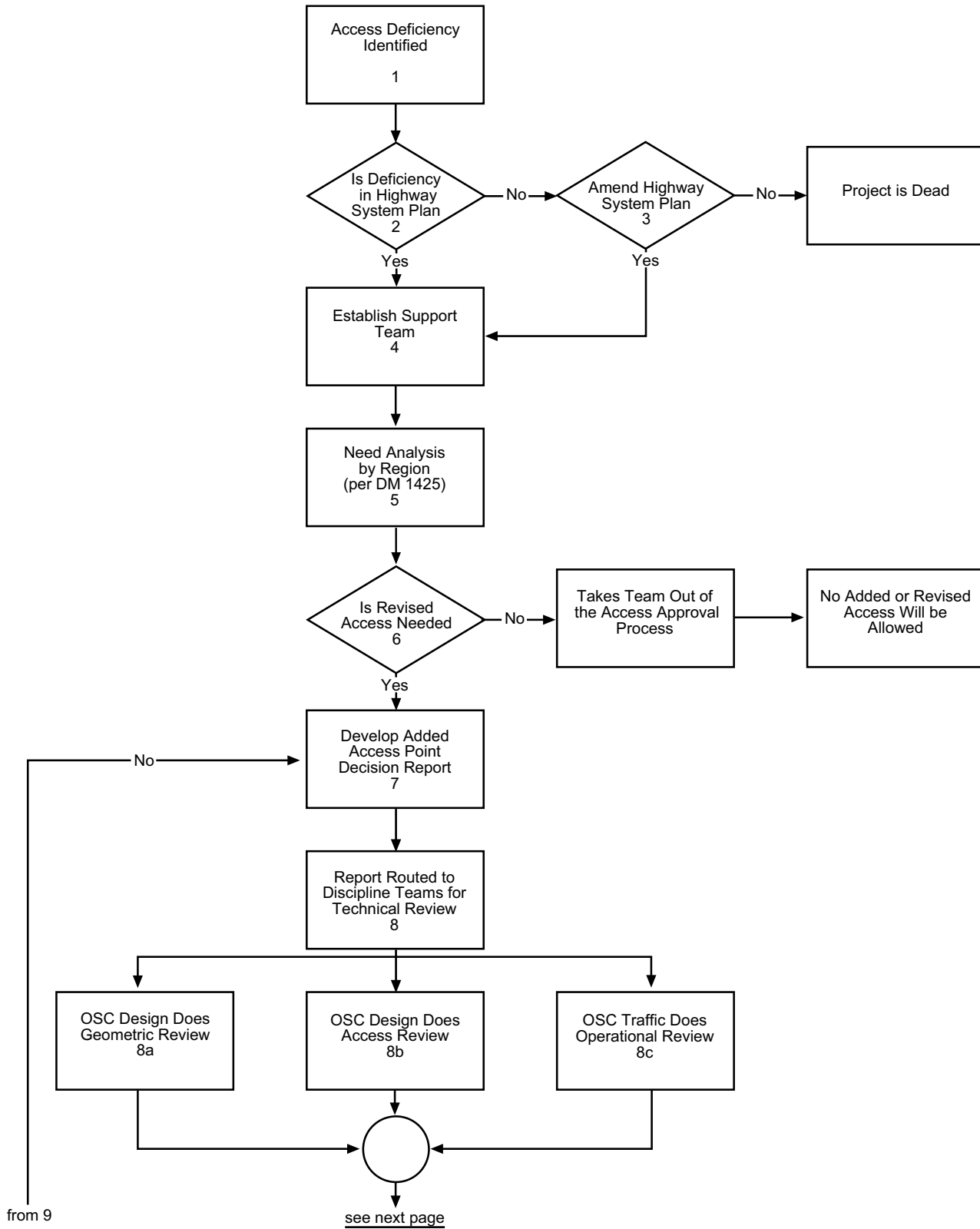

**Access Point Decision Report Flow Chart**  
*Figure 1425-3a*

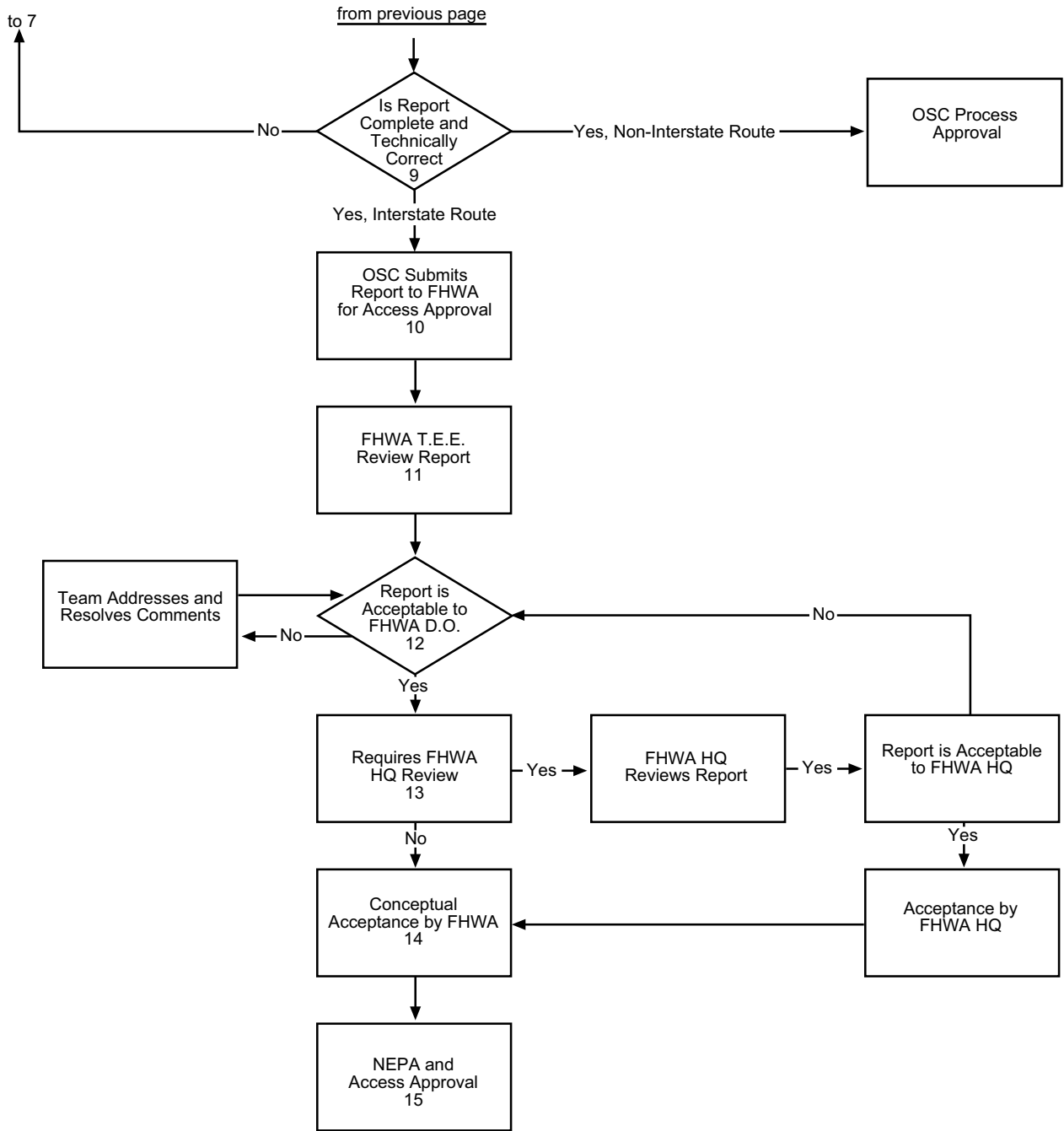

**Access Point Decision Report Flow Chart**  
*Figure 1425-3b*

# 1430

## Development of Access Control

- 1430.01 General
- 1430.02 Access Report
- 1430.03 Access Hearing

### 1430.01 GENERAL

Requirements for the establishment of controlled access facilities are set forth in RCW 47.52. The degree of access control is determined during the early stages of design in conformance with Chapter 1420.

Access control is established in three stages of development: The access report plan, access hearing plan, and the findings and order plan. The findings and order plan becomes a permanent document and is approved by the Deputy Secretary of Transportation.

If all information required for the right of way plan is included, the findings and order plan may also become the right of way plan. If not, it is used as the basis for preparation of the right of way plan (Refer to the *Plans Preparation Manual*, M 22-31). Control section, project control, federal aid, state route, and sheet numbers, along with project name and county, will appear on each plan.

### 1430.02 ACCESS REPORT

#### (1) General

The access report is developed by the district to inform local governmental officials of the proposed route and principal access features involved, and to secure their approval. This report is not furnished to abutting owners. Three copies of the report are to be submitted to the headquarters Project Development Office for review and approval prior to submission to local authorities. The access report is to consist of:

- (a) A description of the existing and proposed routes. Data on the history of the existing route and development of the proposed routes should be included.
- (b) Traffic analyses pertaining to the proposed facility, including available information concerning present and potential future traffic volumes of county roads and city streets crossing or severed by the proposed facility, and source of information (origin-destination surveys, etc.).

Traffic data developed for the design report, together with counts of existing traffic directly available from state or local records, is normally adequate. Special counts of existing traffic should be obtained only if circumstances indicate that the available data is inadequate or outdated.
- (c) Factors affecting the design of the subject highway, including discussions of:

- Standards.
  - Type of access control, with definition.
  - Roadway section.
  - Interchange, grade separation, and/or intersection spacing.
  - Pedestrian and bicycle trails or paths.
  - Operational controls with emphasis on proposed fencing for the protection of motorists and pedestrians, and definition of right of way limits; the general concept of illumination; and the need for use of signing and other traffic control devices.
  - Locations of utilities and how affected.
  - Proposed plan for landscaping and beautification, including an artist's graphic rendition.
- (d) Governmental responsibility, comprehensive planning, land use, and community service relative to the new facility.
  - (e) The disposition of frontage roads, city street and county road connections, and excess right of way.
  - (f) An appendix containing the following:
    - A glossary of engineering terms.
    - A traffic volume diagram.
    - Plates showing diagrammatically or graphically the roadway section or sections, operational controls, and rest areas (if rest areas are included in the project covered by the report).
    - Vicinity map.
    - Access report plan and profiles for the project.
  - (g) **Access Report Plan.** The access report plan shows the effects of the proposed highway on the street and road system by delineating the points of public access. Figure 1430-1 is a sample access report plan. The following items are minimum details to be shown on the plan:
    - Highway facilities with standard access control delineated.
    - Public road network.
    - Proposed frontage roads and county road or city street connections. Individual private approaches need not be included but the report should describe general provisions for access to private properties.
    - Location and identity of subdivisions.
    - Corporate limits and boundaries.
    - Rivers, streams, and major landmarks.
    - Pedestrian and bicycle trails or paths.
    - Beginning and end of plan.

- Legend and scale bar.
- Publicly owned utilities.
- Title block.
- Areas “for relinquishment to county, city or transfer to others” with “turnback lines” indicated, and “excess R/W” labeled as such.
- Structures, labeled as “overcrossings” or “undercrossings.”
- Local names for interchanges shown on plan.
- Points of public access.
- Appropriate traffic movement notes on plan sheets.
- Project length on first page of vicinity map: Total length of project = miles.
- Directional arrows on all roadways and ramps.
- Number of lanes indicated on all roadways.
- Topographic features, buildings, fences, private driveways, etc.
- Ownerships, including parcel numbers and names. See the *Plans Preparation Manual*, M 22-31 for details on assignment of property parcel identification numbers.
- Access approach schedule showing all private approaches within the limits of access control.
- Access notes in conformance with the *Plans Preparation Manual* M 22-31. Right of way dimensions need not be shown.

Matching of stationing and all details, especially in all plan sheets, will be carefully checked to assure relationship to adjacent plans.

To prevent confusion concerning the degree of access control intended for each area of a plan, the station where transition is made from one type of control to the other is clearly labeled. This applies to any such transition upon the highway proper or where such highway connects or intersects with another limited access facility, be it a state, county, or city roadway. This does not apply at intersections where the transition occurs between access controlled facilities and facilities with no access control. Modified access control adjacent to interchanges or intersections must be identified on the plan.

The title block on the plan sheet shall designate either full, partial, or modified access control. Whenever a transition occurs on a sheet, the title block shall indicate all degrees of access control appearing on the sheet.

## **(2) Conferences and Reviews**

Upon receipt of Assistant Secretary for Highways’ approval of Phase 1 (Figure 1410-1), the district will publish the necessary copies, submit the access report to the county and/or city officials for review, and meet with all local governmental agencies involved to discuss the report. The district will review any request for modification and submit recommendations, with copies of any correspondence or minutes relating thereto, to the headquarters Project Development Office.

### **1430.03 ACCESS HEARING**

#### **(1) Access Hearing Plan**

The district will prepare an access hearing plan to be used as an exhibit at the public hearing (Figure 1430-2) and forward it to the headquarters Project Development Office for review. The plan should contain the following data in addition to that required for the access report plan.

When the plan review is completed by headquarters, the access hearing plan will be placed on the Assistant Secretary for Highways’ calendar by the headquarters Project Development Office, for approval of Phase 2 or 2-A authority (Figure 1410-1).

#### **(2) Preparation for Hearing**

The district will assemble the prehearing documents for the access hearing, make arrangements for the hearing hall, and retain a court reporter.

The prehearing documents will consist of, but are not limited to, the proposed advertisement, a mailing list, legislator’s project description and list, sample “notice of appearance,” vicinity map, and all other material necessary to accomplish a proper hearing.

The district shall transmit the prehearing documents to the headquarters Project Development Office for concurrence. Subsequent to concurrence, the district shall notify the legislators in advance of publication, make the appropriate mailings, and advertise the hearing.

#### **(3) Access Hearing**

At the hearing, the Secretary of Transportation or his designee will preside as examiner. Hearing examiners are assigned by the headquarters Project Development Office. Any representative of the county, city, or town, or any other person, may appear and be heard as long as the material presented is pertinent to the issues at hand.

An Assistant Attorney General assists with the presentation of testimony and evidence for the department, and may question witnesses who present objections or counter proposals. Hearing testimony for the department will normally be provided by the district.

After the hearing, the court reporter will submit the original transcript to the examiner for certification, with copies to the district. Following the examiner’s certification, the original transcript is to be transmitted to the headquarters Project Development Office.

The district will review the transcript, prepare a findings and order analysis, draft a findings and order plan as it is modified from the access hearing plan, and transmit these documents to the headquarters Project Development

Office. Care should be taken to ensure that no portion of the findings and order analysis or findings and order plan considers, or is based on, material not properly made part of the hearing record.

Along with the draft findings and order and hearing exhibits, the district shall submit to the headquarters Project Development Office one set of prints marked to show all plan revisions, in composite form, to be included in the findings and order. Any revisions which are not based on the hearing record cannot be included as part of the findings and order. They shall be held by the district until termination of the findings and order appeal period. Following the appeal period, additional plan revisions may be submitted in composite form and in accordance with the *Plans Preparation Manual*, M 22-31.

After the Secretary of Transportation or his designee adopts the findings and order document, the headquarters Project Development Office will make appropriate final revisions to the access hearing plan, in accordance with

the adopted findings and order document. Prints of the findings and order plan (revised access hearing plan) will be reproduced in headquarters and reduced prints, together with a copy of the findings and order text, will be mailed by the district to all parties filing a notice of appearance, including local government officials. Subsequent to mailing, the district will prepare an "affidavit of service by mailing" and transmit it to headquarters in Olympia. On the mailing date of the findings and order documents, the district will notify the appropriate legislators of the Secretary's action, with copies to the Public Affairs Office and the headquarters Project Development Office.

Right of way and limited access plans that follow are prepared in accordance with the provisions of the *Plans Preparation Manual*, M 22-31 and must conform to the findings and order document.

For further information refer to the latest issue of Directive D 22-52(HR) Public Hearings.

V:DM14



REGION NO.	STATE	FED. AID PROJECT NO.	SHEET NO.
10	WASH.	F-500 ( )	

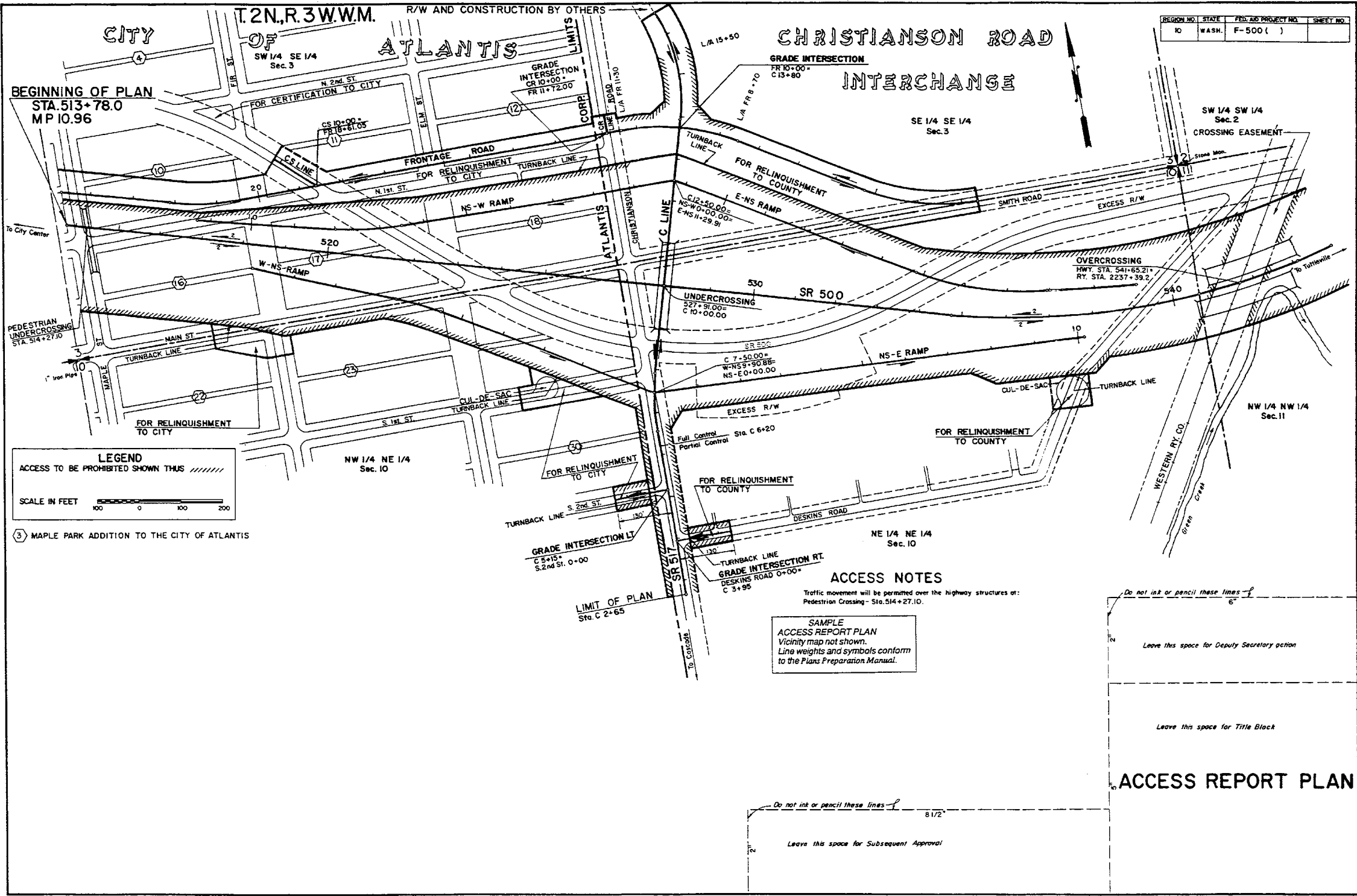

**LEGEND**  
 ACCESS TO BE PROHIBITED SHOWN THUS

SCALE IN FEET  
 100 0 100 200

③ MAPLE PARK ADDITION TO THE CITY OF ATLANTIS

**ACCESS NOTES**  
 Traffic movement will be permitted over the highway structures at:  
 Pedestrian Crossing - Sta. 514+27.10.

**SAMPLE ACCESS REPORT PLAN**  
 Vicinity map not shown.  
 Line weights and symbols conform to the Plans Preparation Manual.

Do not ink or pencil these lines

6

Leave this space for Deputy Secretary action

Leave this space for Title Block

**ACCESS REPORT PLAN**

Do not ink or pencil these lines

81/2

Leave this space for Subsequent Approval

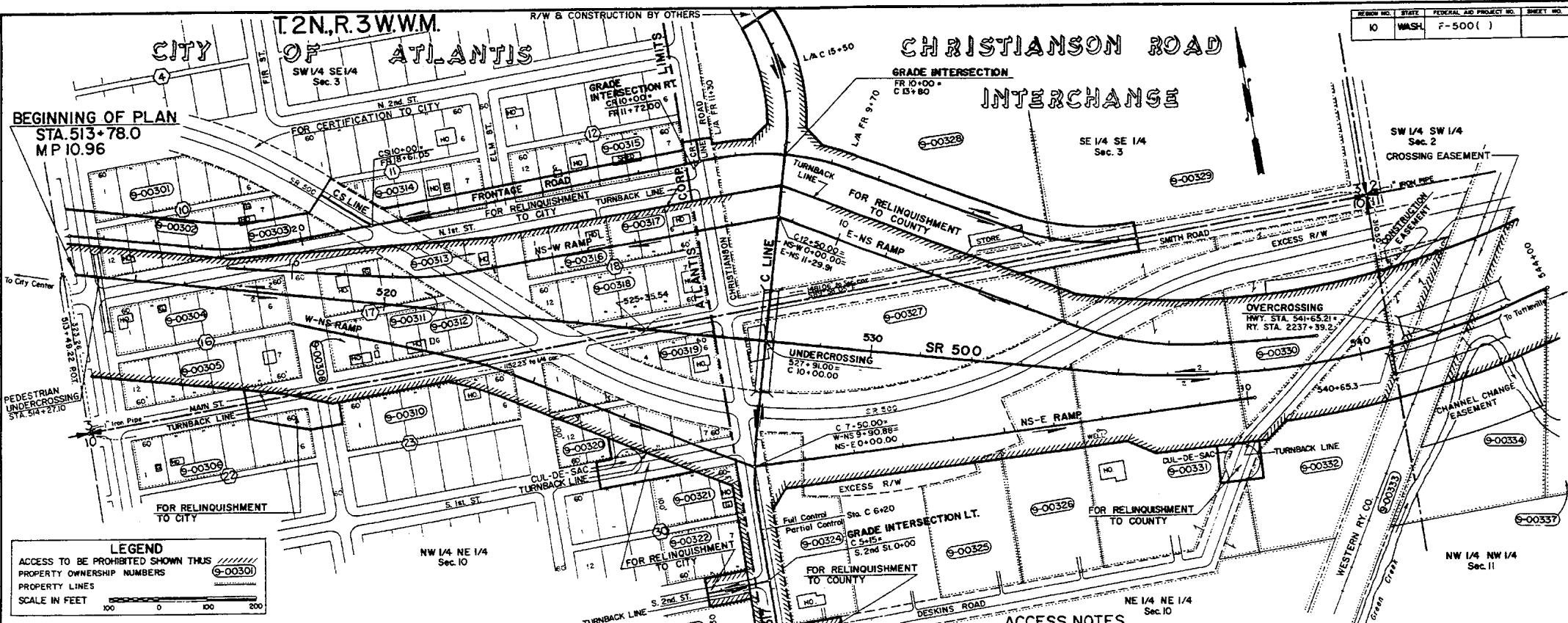

**LEGEND**  
 ACCESS TO BE PROHIBITED SHOWN THUS   
 PROPERTY OWNERSHIP NUMBERS (9-00301)   
 PROPERTY LINES   
 SCALE IN FEET

3) MAPLE PARK ADDITION TO THE CITY OF ATLANTIS FOR TOTAL PARCEL DETAILS SEE SHEET I.

9-00337	Provide space for 4 or more additional ownerships				
9-00336	(RECORD OWNER AS SHOWN IN TITLE REPORTS)			STA. DR 1+15 RT.	A
9-00335					
9-00334				STA. 540+57 TO STA. 542+86	B
9-00333					
9-00332					
9-00331					
9-00330					
9-00329					
9-00328					
9-00327					
9-00326					
9-00325					
9-00324				STA. DR 1+00 LT.	B-2
9-00323					
9-00322					
9-00321					
9-00320					
9-00319					
9-00318					
9-00317					
9-00316					
9-00315					
9-00314					
9-00313					
9-00312					
9-00311					
9-00310					
9-00308					
9-00306					
9-00305					
9-00304					
9-00303					
9-00302					
9-00301					
GRANT COUNTY PUD				STA. 1+00 LT. (Power Lines)	C-5-2
PARCEL NO.	NAME	TOTAL AREA	R/W	LT. REMAINDER	RT. EASMT
					STATION ON ROADWAY
					TYPE
					ACCESS APPROACH SCHEDULE

**SAMPLE ACCESS HEARING PLAN (FULL CONTROL)**  
 Vicinity map not shown.  
 Line weights and symbols conform to the Plans Preparation Manual.

**ACCESS NOTES**

Traffic movement will be permitted over the highway structures at Pedestrian Crossing - Sta. 514+27.10.

Type A approach is an Off and On approach in legal manner, not to exceed 30 feet in width, for residential purposes. It may be reserved for specified use at a point satisfactory to the state.

Type B approach is an Off and On approach in legal manner, not to exceed 50 feet in width, for use necessary to the normal operation of a farm, but not for retail marketing. It may be reserved for specified use at a point satisfactory to the state.

Type C approach is an Off and On approach in legal manner, for special purpose and width to be agreed upon. It may be reserved with the width and for the use specified at a point satisfactory to the state.

No. 2 This approach is to be used to serve more than one owner and/or utility.

No. 5 This approach is to be used for the operation, maintenance and repair of the existing utility specified. The approach shall not exceed 20 feet in width.

No. 8 No access is permitted between the Railway right of way and the the travelled highway lanes.

Do not ink or pencil these lines

Leave this space for Deputy Secretary action

7"

Leave this space for Title Block

**ACCESS HEARING PLAN**

Do not ink or pencil these lines

8-1/2"

Leave this space for Subsequent Approval

- 1440.01 General
- 1440.02 References
- 1440.03 Procedures
- 1440.04 Datums
- 1440.05 Global Positioning System
- 1440.06 WSDOT Monument Database
- 1440.07 Geographic Information System
- 1440.08 Photogrammetric Surveys
- 1440.09 Documentation

### 1440.01 General

The Washington State Department of Transportation (WSDOT) is permitted, by an agreement with the Board of Registration for Professional Engineers and Land Surveyors, to “practice land surveying” under the “direct supervision of either a licensed professional land surveyor or a licensed professional engineer.” See Figure 1440-1, Interagency Agreement.

### 1440.02 References

RCW 58.09, “Surveys -- Recording”

RCW 58.20.120, “System designation -- Permitted uses”

RCW 58.24.040(8), “. . . temporary removal of boundary marks or monuments”

WAC 332-120, “Survey Monuments -- Removal or Destruction”

WAC 332-130, “Minimum Standards for Land Boundary Surveys and Geodetic Control Surveys and Guidelines for the Preparation of Land Descriptions”

Interagency Agreement Between the Washington State Department of Transportation and the Board of Registration for Professional Engineers and Land Surveyors

*Construction Manual*, M 41-01, WSDOT

*Highway Surveying Manual*, M 22-97, WSDOT

*Plans Preparation Manual*, M 22-31, WSDOT

WSDOT Monument Database at <http://www.wsdot.wa.gov/monument/>

### 1440.03 Procedures

For WSDOT projects, it is recommended that surveying activities include (if appropriate) but not be limited to the following items.

#### (1) During the Project Definition Phase

- (a) Include any pertinent surveying information in the Project Summary.
- (b) Research for recorded survey monuments existing within the project area.
- (c) Determine and prioritize project survey needs and tasks to be completed.
  - Cadastral issues
  - Right of way issues
  - Geodetic control issues
  - Photogrammetry issues
  - Other issues as needed

#### (2) During Design and Development of the Plans, Specifications, and Estimate

- (a) Hold a presurvey conference.
- (b) Schedule tasks with surveyors.
- (c) Perform field reconnaissance, mark existing recorded survey monuments, and determine location of possible new survey monuments. Also mark found unrecorded monuments for preservation if practical.
- (d) Determine impact to geodetic monuments and notify OSC Geographic Services.
- (e) See the *Highway Surveying Manual* to:
  - Convert Washington state plane coordinates to project datum.
  - Document the procedure and combined factor used for converting between datums.

- Determine survey collection methods.
- Collect primary, secondary, and tertiary survey data.
- Process and import secondary, tertiary, or other survey data into design software for use by designers.

(f) Apply to the Department of Natural Resources (DNR) for permits for monuments that will be disturbed or removed (Chapter 1450).

(g) Archive new primary and secondary survey control data in the WSDOT Monument Database and GIS, as appropriate, for future retrieval.

(h) Ensure that all survey monuments within the right of way of the project are shown on the contract plans in order to avoid accidental damage.

(i) Develop a Record of Survey (RCW 58.09) or a Record of Monuments and Accessories as required (Chapter 1450).

### **(3) After Construction is Completed**

(a) Complete “Post Construction” survey as described in the *Highway Surveying Manual* and the *Construction Manual*.

(b) Have DNR Completion Report signed and stamped by the appropriate professional in direct responsible charge of the surveying work, then file with DNR as described in Chapter 1450.

## **1440.04 Datums**

A datum is a geometrical quantity or set of quantities that serves as a reference, forming the basis for computation of horizontal and vertical control surveys in which the curvature of the earth is considered. Adjusted positions of the datum, described in terms of latitude and longitude, may be transformed into plane coordinates on a state system.

### **(1) Horizontal**

WAC 332-130-060 states that “The datum for the horizontal control network in Washington shall be NAD83 (1991) as officially adjusted

and published by the National Geodetic Survey of the United States Department of Commerce and as established in accordance with chapter 58.20 RCW. The datum adjustment shall be identified on all documents prepared; i.e., NAD83 (1991).” For further information, see the *Highway Surveying Manual*.

### **(2) Vertical**

The Federal Geodetic Control Subcommittee (FGCS) has affirmed the North American Vertical Datum of 1988 (NAVD88) as the official civilian datum for surveying and mapping activities in the United States. WSDOT has adopted this datum. For further information, see the *Highway Surveying Manual*.

## **1440.05 Global Positioning System**

A Global Positioning System (GPS) uses a constellation of satellites and earth stationed receivers to determine geodetic positions (latitude and longitude) on the surface of the earth. This survey technology is used by WSDOT personnel. See the *Highway Surveying Manual* for more detailed discussions.

GPS technology is changing rapidly. The key point is for the designer and surveyor to select the best tool (GPS application) for doing the survey. Often times a combination of GPS and traditional (Total Station) surveying is appropriate.

## **1440.06 WSDOT Monument Database**

The WSDOT Monument Database provides storage and retrieval capabilities for data associated with survey control monuments set by WSDOT. This database supports and tracks the Report of Survey Mark and aids in fulfilling WSDOT’s obligation to contribute to the body of public record, thereby minimizing the duplication of survey work.

The Internet address <http://www.wsdot.wa.gov/monument/> is used to access the WSDOT Monument Database.

## 1440.07 Geographic Information System

The Geographic Information System (GIS) is a collection of information from many sources. Its purpose is to assemble data into a central database for the common good. The data is stored on many levels so that the desired information can be selected and combined to achieve the desired product. Surveying and photogrammetric data are vital elements of this system.

## 1440.08 Photogrammetric Surveys

Photogrammetric surveys are performed to furnish topographic or planimetric maps and cross sections for use in the reconnaissance, location, and preliminary design phases of highway work. To use photogrammetric surveys for final design and construction requires that the ground be nearly bare to obtain the necessary accuracy. By using well-planned aerial photography in stereoscopic plotters, contours and other physical features are delineated on map sheets to a scale consistent with the accuracies or detail required.

The usefulness of aerial photography is not limited to mapping. Taking the form of enlargements, mosaics, and digital images, it can be used as a visual communication tool (displays and exhibits) for planning, design, property acquisition, engineering, construction, litigation, and public relations.

To obtain information on preparation, procedure, and programming of aerial photography and photogrammetric mapping and applications, contact the Geographic Services Branch. When requesting a photogrammetric survey, specify the desired units and check the units of the product. Allow for the time required to communicate the complex and detailed work request, develop the service, and accomplish the product.

## 1440.09 Documentation

See Chapter 1450 for documentation related to monuments.

Primary and secondary survey control data are archived in the WSDOT Monument Database and GIS when available.

As a minimum, permanent hard copies of the following are to be preserved in a manner that can easily be retrieved in the future:

- Report of Survey Marks
- Project datum conversion documentation
- Legal research (descriptions, lists of references, etc.)

*P65:DP/DMM*

**INTERAGENCY AGREEMENT BETWEEN  
THE WASHINGTON STATE DEPARTMENT OF TRANSPORTATION  
AND THE BOARD OF REGISTRATION FOR PROFESSIONAL  
ENGINEERS AND LAND SURVEYORS**

THE FOLLOWING Interagency Agreement is hereby entered into between the Washington State Department of Transportation (hereafter referred to as "WSDOT") and the Washington State Board of Registration for Professional Engineers and Land Surveyors (hereafter referred to as "BOARD").

I

**DECLARATIONS OF THE PARTIES**

- A. WHEREAS the BOARD has the exclusive authority to regulate the practice of engineering and land surveying in Washington; and
- B. WHEREAS WSDOT employees are required to practice land surveying as defined by RCW 18.43.020 in carrying out the program of said agency; and
- C. WHEREAS WSDOT is exempted from necessarily using a licensed land surveyor to perform said surveys in accordance with the provisions of the Survey Recording Act, RCW 58.09.090; and
- D. WHEREAS both the BOARD'S and WSDOT'S goals include the performance of land surveys in conformance with recognized standards of practice and relevant laws and administrative codes in order to safeguard life, health, and property; and
- E. WHEREAS the parties to the Agreement agree to the following Principles of Agreement.

II

**PRINCIPLES OF AGREEMENT**

- A. The practice of land surveying performed by WSDOT employees shall be under the direct supervision of a licensed professional land surveyor OR licensed professional engineer. Said licensee shall hold a valid Washington license issued in conformance with RCW 18.43.
- B. All surveys performed by WSDOT employees shall be performed in accordance with the Survey Standards promulgated under Chapter 332-130 WAC.
- C. When a survey has been performed by WSDOT employees a survey map shall be prepared and filed with the county engineer in compliance with RCW 58.09.090(1)(a). Said map's contents shall be in conformance with the requirements of RCW 58.09.060 and WAC 332-130. Furthermore, said map shall contain the stamp and signature of the licensee who was in direct responsible charge of the work.

**Interagency Agreement**  
*Figure 1440-1a*

- D. A record of corner information shall be filed in accordance with RCW 58.09.040(2) and 58.09.090(2) where WSDOT employees replace or restore an existing or obliterated general land office corner. Said record of corner information shall be signed and stamped by the professional land surveyor or professional engineer responsible for said work.
- E. The temporary removal or destruction of any section corner or any other land boundary mark or monument shall be permitted if performed in compliance with RCW 58.24.040(8).
- F. Whether performed by a licensed professional engineer or a licensed professional land surveyor, any surveys performed by WSDOT shall be in accordance with the standards generally expected of those practicing professional land surveying.

IN WITNESS WHEREOF: The Washington State Department of Transportation and the Board of Registration have signed this Agreement.

/s/ Ed W. Ferguson

\_\_\_\_\_  
Ed W. Ferguson, PE  
DEPUTY SECRETARY  
Department of Transportation

\_\_\_\_\_  
January 5, 1990  
Date

This Agreement approved by motion of the Board dated January 19, 1990.

/s/ Wesley E. Taft

\_\_\_\_\_  
Wesley E. Taft, PE  
CHAIRMAN, Board of Registration

\_\_\_\_\_  
January 19, 1990  
Date

**Interagency Agreement**  
*Figure 1440-1b*

- 1450.01 General
- 1450.02 References
- 1450.03 Definitions
- 1450.04 Control Monuments
- 1450.05 Alignment Monuments
- 1450.06 Property Corners
- 1450.07 Other Monuments
- 1450.08 Documentation
- 1450.09 Filing Requirements

### 1450.01 General

Proper monumentation is important in referencing a highway's alignment that is used to define its right of way and the department can contribute to the body of public records and minimize duplication of survey work by establishing and recording monuments that are tied to a state plane and to a standard vertical datum. In addition, the department is required by law to perpetuate existing recorded monuments. (See RCW 58.09.) Consequently, the department shall provide monuments for realignments and new highway alignments and shall perpetuate existing monuments impacted by a project.

Both the Department of Natural Resources (DNR) and the Geographic Services Branch maintain records of surveys performed and survey monuments established. New monuments are to be reported to both operations.

Existing monuments are not to be disturbed without first obtaining the DNR permits required by state law. DNR allows the temporary covering of a string of monuments under a single permit. State law requires replacement of land boundary monuments after temporary removal according to permit procedures. WSDOT control and alignment monuments may be removed without replacement if approved by the Geographic Services Branch. (Notify DNR.)

Other requirements pertaining to specific monuments are discussed below.

Figure 1450-1 summarizes the documentation requirements for new and existing monuments.

The region is responsible for obtaining all required permits before any existing monument is disturbed and for the research to locate existing monuments as required by WAC 332-120-030 as follows:

(2) *Any person, corporation, association, department, or subdivision of the state, county or municipality responsible for an activity that may cause a survey monument to be removed or destroyed shall be responsible for ensuring that the original survey point is perpetuated. It shall be the responsibility of the governmental agency or others performing construction work or other activity (including road or street resurfacing projects) to adequately search the records and the physical area of the proposed construction work or other activity for the purpose of locating and referencing any known or existing survey monuments.*

### 1450.02 References

“Engineers and Land Surveyors,” RCW 18.43

“Surveys — Recording,” RCW 58.09

“State Agency for Surveys and Maps — Fees,” RCW 58.24

“Survey Monuments--Removal or Destruction,” WAC 332-120

“Minimum Standards for Land Boundary Surveys and Geodetic Control Surveys and Guidelines for the Preparation of Land Descriptions,” WAC 332-130

“*Manual of Instructions for the Survey of the Public Lands of the United States* 1973 BLM, U.S. Department of Interior”

### 1450.03 Definitions

**monument**, as defined for this chapter, is any physical object or structure which marks or references a survey point. This includes a point of curvature (P.C.), a point of tangency (P.T.), a property corner, a section corner, a General Land Office (GLO) survey point, a Bureau of Land



## Monumentation

Management (BLM) survey point, and any other permanent reference set by a governmental agency or private surveyor.

**removal or destruction** the physical disturbance or covering of a monument such that the survey point is no longer visible or readily accessible.

### 1450.04 Control Monuments

Horizontal and vertical control monuments are permanent references required for the establishment of project coordinates tied to a state plane and elevations tied to a standard vertical datum. By establishing and recording permanent control monuments, the department eliminates duplication of survey work and contributes to the body of public records.

Horizontal and vertical control monuments are required for highway projects requiring the location of existing or proposed alignment or right of way limits. Monuments set by other agencies may be used if within two kilometers (1.24 miles) of the project and the required datum and accuracy were used. To omit monumentation when it is impractical, a variance must be sought from the State Survey Support Engineer.

When control monuments are required for a given project, either show the existing and proposed control monuments on the contract plans or include an approved variance in the design report.

For horizontal control:

- Use North American Datum 1983, revised 1991 (NAD83/91).
- Use a minimum of second order, Class II procedures as defined in the *Highway Surveying Manual* (M 22-97).
- Provide two monuments near the beginning of the project.
- Provide two monuments near the end of the project.
- Provide a pair of monuments at about five kilometer (or 3-mile) intervals throughout the length of the project.

For vertical control:

- Use North American Vertical Datum 1988 (NAVD88). See the *Highway Surveying Manual* for orders of accuracy required.
- Use at least third order procedures within project limits as defined in the *Highway Surveying Manual*.
- Provide vertical control throughout the length of the project. Desirable spacing is at or near each milepost or every other kilometer. Maximum spacing is five kilometers (3.11 miles) apart.

All control monuments that are established, reestablished, or reset must be filed with the county engineer, Geographic Services, and DNR. Submit a Record of Monuments and Accessories that has been signed by the supervising, licensed, professional engineer, or land surveyor (or, if the monument is not used to reference right of way or land corners, submit a Record of Survey Mark).

### 1450.05 Alignment Monuments

Alignment monuments are permanent references required for the establishment or reestablishment of the highway and its right of way. Generally, highway and ramp center line P.C.s and P.T.s are monumented. Establishment, reestablishment, or resetting of alignment monuments is required on the following highway projects:

- New highway alignment projects.
- Highway realignment projects involving new right of way. (Monuments are only required for the realigned highway section.)
- Highway projects where alignment monuments already exist.

Before an existing alignment monument is reestablished or reset, a DNR permit is required.

All alignment monuments that are established, reestablished or reset must be filed with the appropriate county engineer and DNR. A Record of Monuments and Accessories is filed with the county engineer of the county in which the monument is located and copies are sent to the Geographic Services Branch and DNR for their records.

## 1450.06 Property Corners

A new property corner monument will be provided where an existing recorded monument has been invalidated as a direct result of a right of way purchase by the department. The new property corner monument shall be set by or under the direct supervision of a licensed professional land surveyor. The licensed professional land surveyor must record the survey with the county auditor and send copies to the Geographic Services Branch and DNR.

## 1450.07 Other Monuments

A DNR permit is required before any monument may be removed or destroyed.

Existing section corners and BLM or GLO monuments impacted by a project shall be reset to perpetuate their existence. After completing the work, a Land Corner Record is required.

Other permanent monuments established by any other governmental agency must not be disturbed until the agency has been contacted to determine specific requirements for the monument. If assistance is needed to identify a monument, contact the Olympia Service Center Geographic Services Branch.

Resetting monuments must be done by or under the direct supervision of a licensed professional engineer or a licensed professional land surveyor. Submit a Record of Monuments and Accessories to the county engineer, Geographic Services Branch, and DNR.

## 1450.08 Documentation

The following documents are to be preserved for future reference in the project's design documents file. See Chapter 330.

- A general statement about the project's impacts on existing monuments.
- A general statement concerning new monuments.

## 1450.09 Filing Requirements

### (1) DNR Permit

When a DNR permit is required, use the application form shown in Figure 1450-2a. The

completed application must be signed by a licensed professional engineer or a licensed professional land surveyor and submitted to DNR.

Monumentation work cannot be done until DNR has approved the permit. Verbal permission may be granted by DNR pending the issuance of a written permit.

After resetting the monument, the survey method used must be filed with DNR using the completion report form shown in Figure 1450-2b. The form must be signed by a licensed professional engineer or a licensed professional land surveyor.

### (2) Record of Monuments and Accessories

When a Record of Monuments and Accessories is required, a plan sheet similar to Figure 1450-3 is prepared. Generally, the plan sheet is based on a right of way plan obtained from the Olympia Service Center Plans Branch. A Record of Monuments and Accessories should contain a description of all new and existing monuments indicating their kind, size and location. In addition, it must contain the seal and signature of a licensed professional engineer or a licensed professional land surveyor.

The completed Record of Monuments and Accessories must be submitted to the county engineer of the county in which the monument is located and copies sent to the Geographic Services Branch and DNR.

### (3) Land Corner Record

When a Land Corner Record is required, use the forms shown in Figure 1450-4. The completed forms must be signed and stamped by a licensed professional engineer or a licensed professional land surveyor and submitted to the county auditor for the county in which the monument is located and to the Geographic Services Branch and DNR.

1450:P:DM14

## **SET NEW**

---

### **WSDOT Control Monument**

**Before:** No permit required.

**After:** File a Record of Monuments and Accessories with the county engineer, Geographic Services Branch, and DNR.

### **Alignment Monument**

**Before:** No permits required.

**After:** Submit Record of Monuments and Accessories to the county engineer, Geographic Services Branch, and DNR.

### **Property Corner Monument**

**Before:** Engage a licensed professional land surveyor.

**After:** Licensed professional land surveyor files Record of Survey with county auditor and DNR.

## **DISTURB EXISTING**

---

### **Control Monument**

**Before:** Obtain DNR permit.

**After:** File Record of Monuments and Accessories with the county engineer, Geographic Services Branch, and DNR.

### **Alignment Monument**

**Before:** Obtain DNR permit.

**After:** File Record of Monuments and Accessories with the county engineer, Geographic Services Branch, and DNR.

### **Section Corner, BLM, or GLO Monument**

**Before:** Obtain DNR permit.

**After:** File Land Corner Record with the county auditor and DNR.

### **All Other Monuments**

**Before:**

- Obtain DNR permit.
- Contact governmental agency.

**After:** File Record of Monuments and Accessories with the county engineer, Geographic Services Branch, and DNR.

## **Monument Documentation Summary**

*Figure 1450-1*

**APPLICATION FOR PERMIT  
TO REMOVE OR DESTROY  
A SURVEY MONUMENT**

**PERMIT NO.**

You are hereby authorized to remove or destroy  
the described survey monument(s):

**AUTHORIZING SIGNATURE/DATE  
(DNR or Other Authorizing Agency)**

**APPLICANT INFORMATION:**

NAME:

TELEPHONE NO:

DATE:

COMPANY OR AGENCY NAME AND ADDRESS:

I estimate that this work will be finished by (date) \_\_\_\_\_.

\_\_\_\_\_ I request a variance from the requirement to reference to the Washington Coordinate System. (Please provide your justification in the space below.)

The variance request is \_\_\_ approved; \_\_\_ not approved. (FOR DNR USE ONLY) Reason for not approving:

**MULTIPLE MONUMENTS:**

\_\_\_\_\_ Check here if this form is being used for more than one monument. You must attach separate sheets showing the information required below for each monument affected. You must seal, sign and date each sheet.

**INDEXING INFORMATION FOR AN INDIVIDUAL MONUMENT:**

- 1) THE MONUMENT IS LOCATED IN: SEC \_\_\_\_\_ TWP \_\_\_\_\_ RGE \_\_\_\_\_ 1/4-1/4 \_\_\_\_\_
- 2) ADDITIONAL IDENTIFIER: (e.g., BLM designation for the corner, street intersection, plat name, block, lot, etc.)

**MONUMENT INFORMATION:** Describe: 3) the monument/accessories found marking the position, 4) the temporary references set to re-monument the position (include coordinates when applicable), and 5) the permanent monument(s) to be placed on completion (if a permanent witness monument(s) is set include the references to the original position).

SEAL/SIGNATURE/DATE SIGNED

(Form prescribed 2/94 by the Public Land Survey Office, Dept. of Natural Resources, pursuant to RCW 58.24.040 (8).)

Figure 1450-2a

**COMPLETION REPORT FOR MONUMENT  
REMOVAL OR DESTRUCTION**

(TO BE COMPLETED AND SENT TO THE DNR AFTER THE WORK IS DONE.)

\_\_\_\_\_ I have perpetuated the position(s) as per the detail shown on the application form.

\_\_\_\_\_  
SEAL/SIGNATURE/DATE SIGNED

**OR**

\_\_\_\_\_ I was unable to fulfill the plan as shown on the application form. Below is the detail of what I did do to perpetuate the original position(s). (If the application covered multiple monuments attach sheets providing the required information. Seal, sign and date each sheet.)

\_\_\_\_\_  
SEAL/SIGNATURE/DATE SIGNED

Figure 1450-2b

Record of Monuments and Accessories  
Figure 1450-3

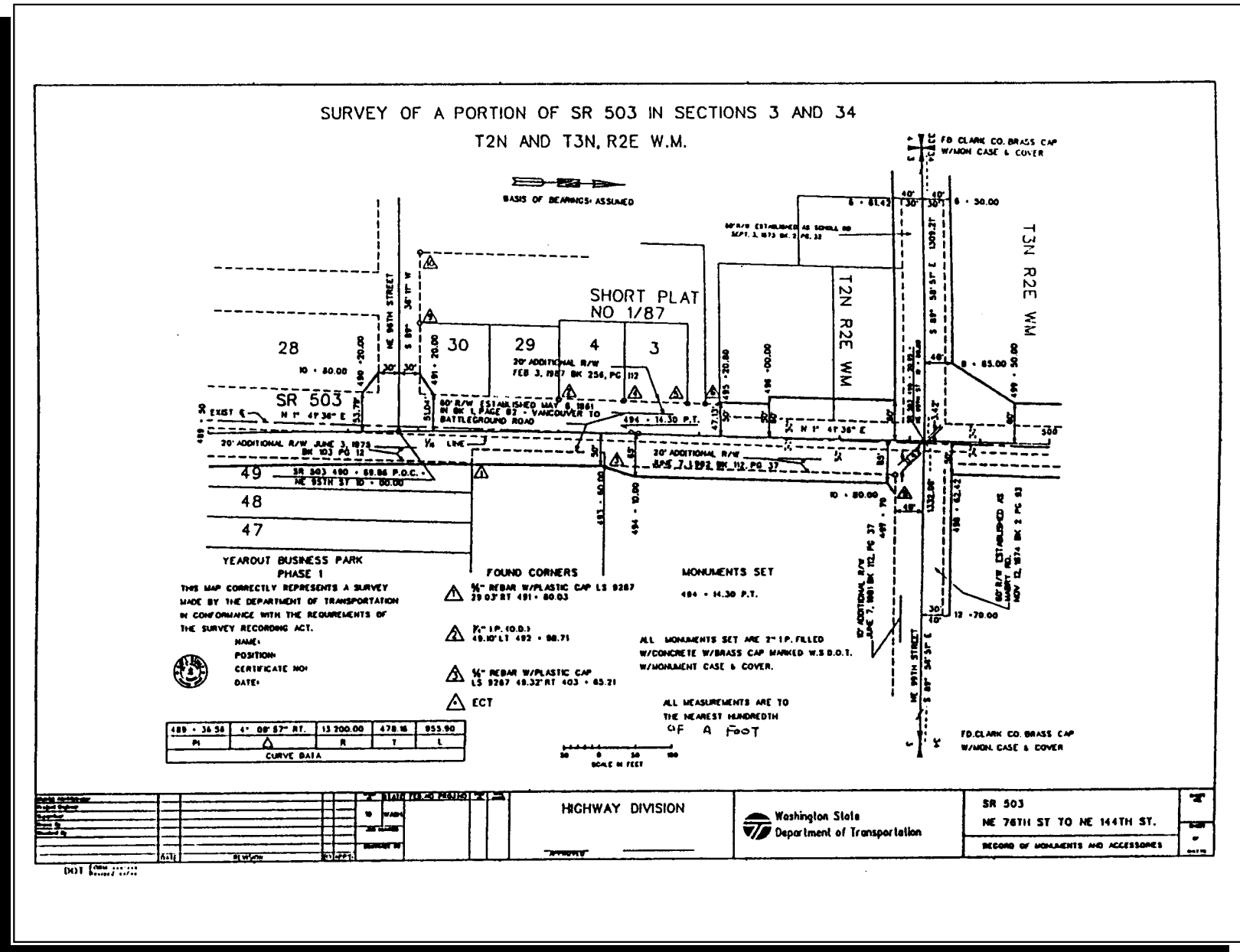

HIGHWAY DIVISION					SR 503 NE 78TH ST TO NE 144TH ST.
				RECORD OF MONUMENTS AND ACCESSORIES	

# LAND CORNER RECORD

(THIS FORM PRESCRIBED BY THE PUBLIC LAND SURVEY OFFICE, DEPARTMENT OF NATURAL RESOURCES, PURSUANT TO RCW 58.09.. ALPHA-NUMERIC INDEX DIAGRAM ON THE BACK.)

## CORNER INDEXING INFORMATION:

TWP \_\_\_\_\_ RGE \_\_\_\_\_ CORNER CODE \_\_\_\_\_  
(Willamette Meridian) (See instructions on back of LCR)

ADDITIONAL IDENTIFIER: (e.g., BLM designation for the corner, street intersection, plat name, block, lot, etc.)

COUNTY: \_\_\_\_\_

AUDITOR'S USE

## LAND SURVEYOR INFORMATION: (or Public Officer as per RCW 58.09.090)

This corner record correctly represents work performed by me or under my direction in conformance with the Survey Recording Act.

COMPANY OR AGENCY:

ADDRESS:

SEAL/SIGNATURE/DATE

WASHINGTON PLANE COORDINATES: N: \_\_\_\_\_ E: \_\_\_\_\_

ORDER: \_\_\_\_\_ ZONE: \_\_\_\_\_ DATUM (Date of adjustment): \_\_\_\_\_

**CORNER INFORMATION:** Use the space below to provide the following information regarding the corner: **(1) Pertinent Corner History, (2) Evidence Found at the Corner, and (3) Corner Perpetuation Information.** Please title and number the parts of your discussion accordingly. If additional space is needed use the back. (For (3), diagram the references. Also, provide the cross-reference to a map of record, if applicable, the surveyor's field book no./page no., and the date of work.) (See the back of this form for the requirements of the Survey Recording Act.)

DATE OF FORM: 2/32

Figure 1450-4a

**MARK THE CORNER LOCATION ON THE DIAGRAM BELOW AND FILL IN THE CORNER CODE BLANK ON THE OTHER SIDE:**

- (1) For corners located at the intersection of two lines (Section corners, quarter corners and sixteenth corners):
  - (a) The corner code is the alpha-numeric coordinate from the diagram below that corresponds to the appropriate intersection of lines.
- (2) For corners that are not located at the intersection of two lines (Meander corners, DLC's, HES's, reservation boundaries, mining claims, etc.):
  - (a) For corners that are on one line only the corner code is the line designation and the related line segment; i.e., a corner on line 5 between "B" and "C" is designated BC-5.
  - (b) For corners that are between lines the corner code is both line segments; i.e., a corner in the SE1/4 of the SE1/4 of section 18 is designated MN-4-5.

	1	2	3	4	5	6	7	8	9	10	11	12	13	14	15	16	17	18	19	20	21	22	23	24	25
A																									
B																									
C		6				5				4					3					2					1
D																									
E																									
F																									
G			7				8				9				10					11					12
H																									
J																									
K																									
L			18				17				16				15					14					13
M																									
N																									
O																									
P			19				20				21				22					23					24
Q																									
R																									
S																									
T			30				29				28				27					26					25
U																									
V																									
W																									
X			31				32				33				34					35					36
Y																									
Z																									

RCW 58.09.060 (2) requires the following information on this form: an accurate description and location, in reference to the corner position, of all monuments and accessories (a) found at the corner and (b) placed or replaced at the corner; (c) basis of bearings used to describe or locate such monuments or accessories; and (d) corollary information that may be helpful to relocate or identify the corner position.

SPACE FOR ADDITIONAL COMMENT:

Figure 1450-4b



1460.01	General
1460.02	References
1460.03	Design Criteria
1460.04	Fencing Types
1460.05	Gates
1460.08	Procedure
1460.09	Documentation

### 1460.01 General

Fencing is provided primarily to discourage encroachment onto the Washington State Department of Transportation's (WSDOT's) highway right of way from adjacent property and to delineate the right of way. It is also used to replace fencing that has been disrupted by construction and to discourage encroachment onto adjacent property from the highway right of way.

The reason for discouraging encroachment onto the right of way is to limit the presence of people and animals that might disrupt the efficient flow of traffic on the facility. Fencing along the highway is not intended to be protection for people or animals approaching the highway or residing near it.

### 1460.02 References

*Plans Preparation Manual*, M 22-31, WSDOT

*Roadside Manual*, M 25-30, WSDOT

*Standard Plans for Road, Bridge, and Municipal Construction* (Standard Plans), M 21-01, WSDOT

*Standard Specifications for Road, Bridge, and Municipal Construction* (Standard Specifications), M 41-10, WSDOT

### 1460.03 Design Criteria

#### (1) General

Fencing on a continuous alignment has a pleasing appearance and is most economical to construct and maintain. The recommended practice is to locate fencing to coincide with the final right of way line.

Where the anticipated or existing right of way line has abrupt irregularities over short distances, coordinate with Maintenance and Real Estate Services personnel to dispose of the irregularities as excess property, where possible, and fence the final property line in a manner that is acceptable to Maintenance.

Where possible, preserve the natural assets of the surrounding area and minimize the number of fence types on any particular project.

#### (2) Limited Access Highways

On highways with limited access control, fencing is mandatory unless it has been established that such fencing may be deferred. Fencing is required between frontage roads and adjacent parking or pedestrian areas (such as at rest areas and flyer stops) and highway lanes or ramps unless other barriers are used to discourage access violations.

On new alignment in rural areas, fencing is not provided for the outside line of a frontage road unless the abutting property was enclosed prior to highway construction. Such fencing is normally part of the right of way negotiation.

Unless there is a possibility of access control violation, fencing installation may be deferred until needed at the following locations. (When in doubt, consult the Olympia Service Center Access and Hearings Engineer.)

- Areas where rough topography or dense vegetation provides a natural barrier.
- Along rivers or other natural bodies of water.
- In sagebrush country that is sparsely settled.
- In areas with high snowfall levels and sparse population.
- On long sections of undeveloped public or private lands not previously fenced.

### **(3) Managed Access Highways**

Fencing is not required for managed access highways. When highway construction will destroy the fence of an abutting property owner, the cost of such replacement fencing may be included in the right of way payment. When the fences of several property owners will be impacted, it may be cost-effective to replace the fences as part of the project.

If fencing is essential to safe operation of the highway, it will be constructed and maintained by the state. Examples of this are the separation of traveled highway lanes and adjacent facilities with parking or pedestrian areas such as rest areas and flyer stops.

### **(4) Special Sites**

Fencing is often needed at special sites such as pitsites, stockpiles, and borrow areas. The type and configuration of the fence is determined by the requirements of each situation.

## **1460.04 Fencing Types**

### **(1) Chain Link**

Installation of chain link fence is appropriate for maximum protection against right of way encroachment on sections of high volume highways under the following conditions:

- Along an existing business district adjacent to a freeway.
- Between a freeway and an adjacent parallel city street.
- At locations where existing streets have been cut off by freeway construction.
- At industrial areas.
- At large residential developments.
- At military reservations.
- At schools and colleges.
- At recreational and athletic areas.
- At developed areas at the intersection of two limited access highways.
- At any other location where a barrier is needed to protect against pedestrian or

livestock encroachment in limited access areas.

- See Chapter 640 for roadway sections in rock cuts.

The Standard Plans contains details for the four approved types of chain link fence. The recommended uses for each type of fence are as follows:

(a) **Type 1.** A high fence for areas of intensified use, such as industrial areas or school playgrounds. It is not to be used within the Design Clear Zone because the top rail of the fence is considered a hazard. (See Chapter 700.)

(b) **Type 3.** A high fence for use in suburban areas with limited existing development. It may be used within the Design Clear Zone.

(c) **Type 4.** A lower fence for special use, such as between the traveled highway lanes and a rest area or flyer stop, or as a rest area boundary fence if required by the development of the surrounding area. This fence may be used along a bike path or hiking trail to separate it from an adjacent roadway.

(d) **Type 6.** A lower fence used instead of Type 1 where it is deemed important not to obstruct the view toward or from areas adjacent to the highway. This fence is not to be used within the Design Clear Zone. (See Chapter 700.)

Coated galvanized chain link fence is available in various colors and may be considered in areas where aesthetic considerations are important. Coated ungalvanized chain link fence is not recommended.

### **(2) Wire Fencing**

The Standard Plans and Specifications contain details for the two approved types of wire fence. The recommended uses for each type of fence are as follows:

(a) **Type 1.** This fence is used in urban and suburban areas where improvements along the right of way are infrequent and future development is not anticipated. It may also be used adjacent to livestock grazing areas. The lower portion of this fence is wire mesh and provides a barrier to children and small animals.

(b) **Type 2.** This fence is used in farming areas to limit highway crossings by farm vehicles to designated approaches: in irrigation districts to prevent ditch riders, maintenance personnel, and farmers from making unauthorized highway crossings; and where new alignment crosses parcels previously enclosed by barbed wire.

### **(3) Other Considerations**

Extremely tall fences (7 to 10 ft high) may be used in areas where there are exceptional hazards such as large concentrations of elk. See the region's Environmental Office and the *Roadside Manual* concerning wildlife management.

Metal fencing can interfere with airport traffic control radar. When locating fencing in the vicinity of an airport, contact the Federal Aviation Administration to determine if metal fence will create radar interference at the airport. If so, use nonmetallic fencing.

### **1460.05 Gates**

Keep the number of fence gates along limited access highways to a minimum. On limited access highways, all new gates must be approved as described Chapter 1425, "Access Point Decision Report."

Usually such gates are necessary only to allow highway maintenance personnel and operating equipment to reach the freeway border areas without using the through-traffic roadway. Gates may be needed to provide access to utility supports, manholes, and the like, located within the right of way.

Use gates of the same type as the particular fence, and provide locks to deter unauthorized use.

In highly developed and landscaped areas where maintenance equipment is parked outside the fence, provide the double gate indicated in the Standard Plans.

Where continuous fencing is not provided on limited access highways, Type C approaches are normally gated and locked, with a short section of fence on both sides of the gate.

### **1460.08 Procedure**

Fencing is included in the access report, in accordance with Chapter 1430, and the PS&E, in accordance with the *Plans Preparation Manual*.

### **1460.09 Documentation**

The following documents are to be preserved in the project file. See Chapter 330.

- Reasons for providing fencing and for the type and configuration selected.
- Justification for using a nonstandard fence design.
- Justification for deferring or not providing fencing on a highway with limited access control or as otherwise recommended in this chapter.
- Access Point Decision Report for gates on limited access highways.

P65:DP/DME

**A**

- Abbreviations, 110-1
- Acceleration lane, 910-6, 910-29, 940-6, 940-16
- Access:
- approach criteria, 1420-3, 1420-5
  - commercial approaches, 1420-5, 1420-6
  - control development, 1430-1
  - crossroads at interchange ramps, 1420-1
  - design policy, 1420-1
  - frontage roads, 1420-7
  - full control, 1420-1
  - general requirements, 1430-1
  - hearing, 210-12, 1430-2
  - hearing plan, 1430-2
  - illumination, 840-1
  - location of utilities, 1410-4, 1420-2, 1420-4, 1420-5, 1420-7
  - modified control, 1420-4
  - partial control, 1420-2
  - pedestrian facilities, 1020-8
  - programming for funds, 1410-4
  - public transportation facilities, 1060-1
  - railroad approaches, 1420-6
  - report, 1430-1
  - report plan, 1430-1
  - road approaches, 1410-1
- Access control, 120-7
- Access Point Decision Report, 1425-1
- access connections and design, 1425-7
  - alternatives, 1425-6
  - content and review levels, 1425-11, 1425-12
  - coordination, 1425-9
  - definitions, 1425-2
  - documentation, 1425-10
  - finding of engineering and operational acceptability, 1425-1, 1425-4
  - flow chart, 1425-14, 1425-15
  - future interchanges, 1425-5
  - land use and transportation plans, 1425-5
  - need for the access point revision, 1425-6
  - operational and accident analyses, 1425-7
  - planning and environmental processes, 1425-9
  - policy topics, 1425-3
  - possibly not required, 1425-13
  - procedures, 1425-2
  - references, 1425-1
  - review levels, 1425-11, 1425-12
  - supporting analyses, 1425-4
  - support team, 1425-1, 1425-3
- Administrative appeal hearing, 210-15
- Aesthetics for retaining walls, 1130-4
- Agency Request Budget (ARB), 120-15
- Agreements, 240-10, 1420-7
- Air space, 1420-7
- Airport System Plan, 120-13
- Airport-highway clearance, 240-13, 630-3
- Alignment:
- horizontal, 620-1
  - vertical, 630-1
- Alignment monuments, 1450-2
- Application for permit to remove or destroy a survey monument, 1450-5
- Approaches:
- commercial, 920-3
  - full access control, 1420-1
  - noncommercial, 920-3
  - partial access control, 1420-2
  - railroad, 1420-6, 1420-7
  - right of way considerations, 1410-1
  - road, 920-1, 1410-1, 1420-8
- Approach rails to bridges, 710-15
- Approval:
- access report, 1430-1
  - environmental, 220-8, 220-10
  - governmental agencies, 240-1
  - hearing plans, 1430-2
  - interchange plans, 940-10
  - materials source, 510-1, 510-16
- Archaeological sites, 220-5
- Army Corps of Engineers (COE), 240-1
- Arterial HOV, 1050-10
- Arterial HOV, definition, 1050-1
- Asphalt concrete pavement, 520-3, 520-4
- Attenuators, impact, 720-1
- Authorized road approach, 920-1
- Auxiliary lane, 1010-1
- added to basic, 620-4
  - chain-up area, 1010-5
  - climbing lanes, 1010-2
  - emergency escape ramps, 1010-4

- interchanges, 940-6
  - left turn, 910-4
  - passing lanes, 1010-2
  - railroad grade crossings, 930-2
  - right turn, 910-6
  - shoulder driving for slow vehicles, 1010-3
  - slow moving vehicle turnouts, 1010-3
  - speed change lanes, 910-6
  - two-way left turn, 910-5
  - Average weekday vehicle trip ends, 920-1
- B**
- Barrier delineation, 830-4
  - Barriers, traffic, 710-1
    - barrier deflections, 710-4
    - barrier design, 710-3
    - beam guardrail, 710-5
    - bridge rails, 710-15
    - cable barrier, 710-11
    - concrete barrier, 710-12
    - definitions, 710-1
    - dragnet, 710-16
    - flare rate, 710-4
    - length of need, 710-5
    - project requirements, 710-1
    - redirectional land forms, 710-15
    - shy distance, 710-4
    - special use barriers, 710-14
    - standard run, 710-2
    - terminals and transitions, 710-2
    - water filled barriers, 710-16
  - Base and surfacing typical section, 520-6
  - Basic design level, 410-1
    - minor safety and minor preservation work, 410-1
    - required safety items of work, 410-1
  - Beam guardrail (see Guardrail), 710-5
  - Bicycle facilities, 1020-1, 1060-4, 1120-3
  - Bicycle policy plan, 120-10
  - Borrow sites: see sundry sites
  - Boundaries, international, 1410-2
  - Bridges, 1120-1
    - approach slab, 1120-3
    - end slopes, 640-9
    - geotechnical investigation, 510-11
    - horizontal clearance, 1120-2
    - location, 1120-1
    - medians, 1120-2
    - pedestrian and bicycle facilities, 1120-3
    - permits, 240-1
    - protective screening for highway structures, 1120-4
    - rail end treatment, 1120-3
    - rails, 710-15
    - site design, 1120-1
    - slope protection, 1120-4
    - structural capacity, 1120-1
    - vertical clearance, 1120-2
    - width for structures, 1120-2
  - Bridge rails, 710-15
    - concrete safety shapes, 710-15
    - end treatment, 1120-3
    - thrie beam retrofit, 710-16, 710-24
    - type 7 upgrade criteria, 710-3
  - Bridge site data, 1110-1
    - checklist, 1110-5
  - Bridge width for structures, 1120-2
  - Budgets, 120-15
  - Buffer-separated HOV facility, definition, 1050-1
  - Bus berth design, 1060-14
  - Bus shelter design, 1060-22
  - Bus stop pullouts, arterial streets, 1060-19
  - Bus stops and pullouts, 1060-7
    - bus pullouts, 1060-9
    - designation and location, 1060-7
    - farside bus stops, 1060-8
    - introduction, 1060-7
    - mid-block bus stops, 1060-9
    - near side bus stops, 1060-8
    - placement, 1060-8
    - turnout transfer center, 1060-16
  - Bus zone dimensions, 1060-18
- C**
- Cable barrier, 710-11
  - Cantilever sign supports, 820-3
  - Capacity, highway, 610-1
  - Categorical Exclusion (CE), Programmatical - Class II - NEPA, 220-9
  - Categorical Exclusion (CE), Documental - Class II - NEPA, 220-9
  - Categorical Exemption (CE), Class II - SEPA, 220-10
  - Cattle passes, 1410-1
  - Chain-off areas, 1010-5
  - Chain-up areas, 1010-5
  - Channel changes, 1210-2

- Channelization, 910-4
    - curbing, 910-6
    - island, 910-7
    - left-turn lanes, 910-4
    - median, 910-22, 910-23
    - right-turn lanes, 910-6
    - speed change lanes, 910-6
    - widening, 910-21
  - City street connections, 1420-7
  - Classification:
    - cross section design data, 640-1
    - functional, 120-7, 440-1, 440-2
    - project, 220-2
    - terrain, 440-3
  - Clearance:
    - airport-highway, 240-4, 630-3
    - bridge, 1120-2
  - Clear zone, 330-3, 700-1
    - distance tables, 700-12
    - ditch sections, 700-12
    - inventory form, 330-3
    - values, 700-2
  - Climbing lanes, 1010-2
    - level of service, 1010-2
    - speed reduction, 1010-2
  - Closed circuit television cameras, 860-1
  - Cloverleaf interchange, 940-3
  - Coast Guard permits, 240-3
  - Collector distributor roads, 940-8
  - Collector system, 440-1
  - Combined hearings, 210-15
  - Commercial approaches, 920-3
  - Commitment file, 220-1, 220-12
  - Comprehensive Plans, 120-13, 120-17
  - Concrete barrier, 710-12
    - shapes, 710-12
    - terminals, 710-14
  - Concurrent flow lane, definition, 1050-1
  - Concurrent flow lanes, typical, 1050-11, 1050-24
  - Conflict, 910-1
  - Conforming road approach, 920-1
  - Connections:
    - county road and city street, 1420-7
    - interchange, 940-6
  - Contraflow lane, definition, 1050-1
  - Control monuments, 1450-2
  - Construction identification signs, 820-1
  - Construction Work Zone Traffic Control Strategy, 810-1
  - Construction Zone Guard Rail Energy Absorption Terminal (GREATcz), 720-2, 720-9
  - Consultants, geotechnical, 510-14
  - Contour grading, 1310-1
    - general, 1310-1
    - procedures, 1310-1
    - recommendations, 1310-1
    - references, 1310-1
  - Coordination:
    - public agencies, 240-1
  - Corridor analysis: see project analysis
  - Corridor hearing, 210-11
  - Corridor Management Plan (CMP), 120-11
  - County road connections, 1420-7
  - Critical slope, 700-1
  - Crossings:
    - bicycle facilities, 1020-3
    - pedestrian, 1020-3
    - railroad grade, 930-1
    - ramp intersections, 940-6
    - waterway, 1110-2
  - Crossroad, 910-1, 910-2
  - Cross sections:
    - encroachment (RR), 930-3
    - geometric, 640-1
    - interchanges, 940-3
    - roadway, 640-2
  - Cross slope, 430-2, 640-2, 640-4
  - Crosswalks, 910-8, 1020-9
  - Cul-de-sac, 1420-7
  - Curb cut ramps, 1020-9
  - Curbing, 910-6
  - Current Law Budget (CLB), 120-15
  - Curves:
    - horizontal, 620-2
    - superelevation, 640-4
    - vertical, 630-2
- D**
- Data for all structures, 1110-1
  - Data for grade separations structures, 1110-3
  - Data for waterway crossings structures, 1110-2
  - Data for widening of structures, 1110-4
  - Datums for surveying, 1440-2
  - Deceleration lane, 910-6, 910-28, 940-7, 940-21
  - Deep-seated instability, 1350-2
  - Delineation, 830-1
    - barrier delineation, 830-5
    - guidepost placement, 830-7
    - guideposts, 830-4

- pavement marking, 830-1
- pavement marking material guide, 830-6
- placement, 830-5
- raised pavement markers, 830-4
- wildlife warning reflectors, 830-5
- Department of Ecology, 240-6
- Depts. of Fisheries and Game, 240-6
- Department of Natural Resources, 240-8
- Design:
  - guides for highway capacity, 610-1
  - hearing, 210-12
  - items, 160-1
  - manual description, 100-1
  - manual revisions, 100-1
  - pavement structure, 520-1
  - principles, 160-1
  - speed, 430-1, 440-3, 940-4
  - speed ramp, 940-4
  - standards, 160-1, 430-3
  - traffic barriers, 710-3
  - vehicle, 430-3, 910-3
  - vehicle turning movements, 1060-23
- Design approach for geosynthetics, 530-3
  - ditch lining, 530-6
  - permanent erosion control, moderate and high survivability, 530-5
  - separation, 530-4
  - site-specific designs (all applications), 530-10
  - soil stabilization, 530-5
  - standard specification geotextile application identification in the plans, 530-9
  - temporary silt fence, 530-6
  - underground drainage, low and moderate survivability, 530-3
- Design approval level, 330-6
- Design clear zone for ditch sections, 700-1
- Design components of signs, 820-2
  - cantilever sign structures, 820-3
  - foundations, 820-3
  - lateral clearance, 820-2
  - location, 820-2
  - longitudinal placement, 820-2
  - sign heights, 820-2
  - sign posts, 820-3
  - truss-type sign bridges, 820-3
- Design considerations of intersections at grade, 910-2
  - crossroads, 910-2
  - intersection configurations, 910-2
  - traffic analysis, 910-2
- Design criteria of HOV facilities, 1050-7
  - adding an HOV lane, 1050-7
  - barrier-separated HOV facilities, 1050-7
  - concurrent flow HOV lanes, 1050-7
  - design considerations, 1050-7
  - design procedures, 1050-7
  - direct access connections, HOV Direct Access Design Guide, Draft, M 22-98
  - enforcement areas, 1050-9
  - lane termination, 1050-8
  - ramp bypass, 1050-8
  - signs and pavement markings, 1050-9
- Design documentation, 330-3
  - design documents, 330-3
  - design variance inventory, 330-4
  - FHWA requirements, 330-3
- Design documentation, approval, and process review, 330-1
  - design approval, 330-4
  - design documentation, 330-3
  - process review for region approved projects, 330-4
  - project definition phase, 330-2
  - project development, 330-2
  - purpose, 330-1
- Design exception, 325-4
- Design hearing, 210-12
- Design Matrix 1, Interstate Routes (Main Line), 325-11
- Design Matrix 2, Interstate Interchange Areas, 325-12
- Design Matrix 3, NHS Routes (Main Line), 325-13
- Design Matrix 4, Non-Interstate Interchange Areas, 325-14
- Design Matrix 5, Non-NHS Routes, 325-15
- Design matrix procedures, 325-1
  - design elements, 720-2
  - design matrix procedures, 325-3
  - design matrix selection guide, 325-4
  - project type, 325-4, 325-2
  - selecting a design matrix, 325-3
  - terminology, 325-1
  - using a design matrix, 325-4
- Design of noise barriers, 1140-1

- Design of pavement structure, 520-1
    - asphalt concrete pavement and asphalt distribution tables, 520-3, 520-4
    - base and surfacing typical section, 520-6 to 520-14
    - estimating bituminous surface treatment, 520-5
    - estimating tables, 520-1
    - introduction, 520-1
  - Design recommendations for roadside development, 1300-3
  - Design responsibility and process for retaining walls, 1130-8
    - guidelines for wall/slope data submission for design, 1130-12
    - nonpreapproved proprietary walls, 1130-12
    - nonstandard nonproprietary walls, 1130-12
    - preapproved proprietary walls, 1130-10
    - responsibility and process for design, 1130-8
    - standard walls, 1130-10
  - Design requirements of retaining walls and steep reinforced slopes, 1130-2
    - aesthetics, 1130-4
    - constructibility, 1130-4
    - coordination with other design elements, 1130-4
    - drainage design, 1130-3
    - geotechnical and structural design, 1130-3
    - investigation of soils, 1130-3
    - wall/slope geometry, 1130-2
  - Design requirements for roadside development, 1300-2
  - Design reviews and approvals, 330-8
  - Design vehicle for intersection at grade, 910-3
  - Designated State Highways map, 120-11
  - Deviation, 325-5
  - Diamond interchange, 940-3
  - Direct access, HOV Direct Access Design Guide, Draft, M 22-98
  - Direct access ramp, definition, 1050-1
  - Directional interchange, 940-3
  - Disabled accessibility, transit, 1060-12
    - accessibility of bus stops and shelters, 1060-13
    - introduction, 1060-12
    - park and ride lots, 1060-12
  - Discipline report, 220-1
  - Distribution facilities, 620-2
  - Ditch inslopes, 430-3
  - Ditch sections, 700-2
  - Documentation:
    - environmental, 220-1
    - noise barriers, 1140-3
  - Drainage:
    - park and ride lot, 1060-5
    - retaining walls, 1130-3
    - roadway, 1210-2
  - Drainage ditches in embankment areas, 640-9
  - Driveways: see road approaches
  - Dynamic message signs, 860-4
- E**
- Earth berms:
    - noise barriers, 1140-2
    - redirectional, 710-15
  - Easements, 1410-2
  - Ecology, Department of, 240-6
  - Eight-phase job plan for VE studies, 315-5
  - Embankment barrier, 700-3
  - Emergency escape ramps, 1010-3
  - Encroachment, railroad, 930-3
  - Enforcement area (one direction only), 1050-21, 1050-34
  - Enforcement area, definition, 1050-1
  - Enforcement area, median, 1050-22, 1050-35
  - Enforcement observation point, definition, 1050-1
  - Environmental Assessment (EA), NEPA - Class III, 220-10
  - Environmental documents
    - Class I - NEPA (EIS) Environmental Impact Statement, 220-3
    - Class I - SEPA (EIS) Environmental Impact Statement, 220-3
    - Class II - NEPA (EIS) Environmental Impact Statement, 220-9
    - Class II - NEPA (EIS) Environmental Impact Statement, 220-9
    - Class II - SEPA (EIS) Categorical Exemption, 220-10
    - Class III - NEPA (EIS) Environmental Assessment, 220-10
    - geotechnical report, 510-5
    - SEPA; Checklist, 220-10
  - Environmental hearings, 210-11, 1425-10
  - Environmental Protection Agency (EPA), 240-5



Equestrian facilities, 1020-10  
Erosion control, 1350-2  
Escape ramps, 1010-4  
Estimating bituminous surface treatment,  
520-5 to 520-14  
Evaluate upgrade, 325-5  
Evaluate Upgrade (EU), Sample, 330-13

**F**

Farmlands, 220-5  
Federal aid:  
    financing, 140-1, 1410-3  
Federal agencies, 240-1, 1410-4  
Federal Aviation Administration (FAA), 240-4  
Federal Energy Regulatory Commission (FERC),  
240-5  
Fencing, 1460-1  
    chain link fencing, 1460-2  
    design criteria, 1460-1  
    documentation, 1460-3  
    fence types, 1460-2  
    gates, 1460-3  
    limited access highway, 1460-1  
    managed access highways, 1460-2  
    procedures, 1460-3  
    references, 1460-1  
    wire fencing, 1460-2  
Ferry System Plan, 120-13  
Filing requirements of monuments, 1450-3  
Fill slopes, 430-3  
Finding of engineering and operational  
    acceptability, 1425-1, 1425-3  
Finding of no significant impact, 220-2, 220-11  
Findings and order plan, 220-13, 1410-4, 1430-2  
Fisheries, Department of, 240-6  
Flexible pavement design, 520-2, 520-3  
Flood plains, 220-5  
Flow chart,  
    access point decision report, 1425-14  
    planning and programming, 120-18  
    planning transportation improvement  
    program, 120-18  
Flyover ramp, definition, 1050-1  
Fog seal, 520-5  
Forest Service (USFS), 240-3  
Formal hearings, 210-4  
Freeway lighting applications, 840-11  
Freight and Goods Transportation System  
    (FGTS), 120-7  
Freight Rail Plan, 120-9

Frontage roads, 620-3, 1420-7  
Full access control, design policy, 1420-1  
Full design level, 440-1  
    city streets and county roads, 440-3  
    design speed, 440-3  
    functional classification, 440-2  
    geometric design data, 440-3  
    grades, 440-6  
    medians, 440-5  
    parking, 440-6  
    pavement type, 440-6  
    shoulders, 440-4  
    structure width, 440-6  
    state highway system, 440-3  
    state highways as city streets, 440-3  
    terrain classification, 440-3  
    traffic lanes, 440-4  
Functional classification, 120-6, 440-2  
Funds, programming for:  
    access control, 1410-4  
    federal aid programs, 140-1  
    right of way, 1410-4

**G**

Gates, 1460-2  
Geocomposites, 530-2  
Geographic information system, 1440-3  
Geogrids, 530-2  
Geomembranes, 530-2  
Geometric cross section, 640-1  
    documentation, 640-9  
    medians and outer separations, 640-6  
    minimum radius for normal crown  
    section, 640-5  
    roadsides, 640-7  
    roadways, 640-2  
    side friction factor, 640-5  
    superelevation, 640-4  
Geometric plan elements, 620-1  
    alignment examples, 620-6 to 620-8  
    arrangement of lanes, 620-3  
    auxiliary lanes, 620-4  
    distribution facilities, 620-2  
    frontage roads, 620-3  
    horizontal alignment, 620-1  
    horizontal curve radii, 620-2  
    lane transitions, 620-4  
    median width transitions, 620-4  
    number of lanes and arrangement, 620-3  
    procedures, 620-4

- Geometric profile elements, 630-1
  - alignment of structures, 630-2
  - airport clearance, 630-3
  - coordinating of vertical and horizontal alignments, 630-2, 630-6 to 630-8
  - design control, 630-1
  - grade lengths, 630-2
  - grading at railroad crossings, 630-3
  - length of grade, 630-2
  - maximum grades, 630-2
  - minimum grades, 630-2
  - minimum length of vertical curves, 630-2
  - procedures, 630-3
  - railroad crossings, 630-3
  - references, 630-1
  - vertical alignment, 630-1
- Geometrics:
  - design data, 440-3
  - horizontal alignment, 620-1
  - plan elements, 620-1
  - profile elements, 630-1
  - vertical alignment, 630-1
- Geonets, 530-2
- Geosynthetics, 530-1
  - application examples, 530-16 to 530-19
  - applications, 530-2
  - class, selection criteria, 530-3
  - design approach, 530-3
  - design process for drainage and erosion control, 530-4
  - design process for separation, soil stabilization, and silt fence, 530-13
  - design responsibility, 530-11
  - ditch lining, 530-6
  - ditch and swale length and width, 530-21
  - ditch and swale maximum contributing areas, 530-8
  - examples, 530-14, 530-15
  - function definitions, 530-2
  - permanent erosion control, 530-5
  - separation, 530-4
  - silt fence, contributing area, 530-22
  - silt fence, end treatment, 530-23
  - silt fence, gravel check dams, 530-24
  - silt fence, length, 530-8
  - silt specification design, 530-10
  - slope length, 530-20
  - soil stabilization, 530-5
  - standard specifications, 530-9
  - temporary silt fence, 530-6
  - types and characteristics, 530-1
  - underground drainage, 530-3
- Geotechnical investigation, design, and reporting, 510-2
  - bridge foundations, 510-11
  - buildings, 510-7
  - communication towers, 510-7
  - design objectives, 510-3
  - earthwork, 510-4
  - environmental mitigation, 510-5
  - ferries projects, 510-13
  - hydraulic structures, 510-5
  - key contacts, 510-2
  - luminaire foundations, 510-7
  - noise walls, 510-8
  - overview, 510-3
  - park and ride lots, 510-7
  - reinforced slopes, 510-8
  - rest areas, 510-7
  - retaining walls, 510-8
  - rockslope, 510-10
  - scheduling considerations, 510-2
  - signals, 510-7
  - signs, 510-7
  - site data and permits, 510-3
  - slopes, 510-9
- Geotextiles, 530-1, 530-9
- Glare screen, 700-7
- Global positioning system, 1440-2
- Grade approvals, cities and towns, 240-9
- Grade crossings, railroad, 930-1
- Grade intersections, 910-1
- Grade separation:
  - highway, 1110-3
  - pedestrian, 1020-10
  - railroad, 1110-3
- Grades:
  - bicycle facilities, 1020-3, 1020-5
  - highway, 440-2
  - pedestrian facilities, 1020-10
  - ramp, 940-4
  - vertical alignment, 630-2
- Grading, contour, 1310-1
- Gravity walls, 1130-2
- Guardrail:
  - beam, 710-5
  - connections, 710-8
  - locations on slopes, 710-6
  - old type 3 anchors, 710-8
  - placement cases, 710-10

- post installation, 710-21
- terminals and anchors, 710-6, 710-22
- transitions and connections, 710-8, 710-9

Guide posts, 830-4

- placement and spacing, 830-4, 830-7

Guide sign plan, 820-4

## H

Handicapped, facilities for, 1020-9, 1060-4

Hazard, 700-1

Headlight glare, 700-6

Hearing summary, 210-11

Hearings, 210-6

- access, 210-12, 1430-2
- administrative appeal, 210-15
- combined, 210-15
- corridor, 210-11
- design, 210-12
- environmental, 210-11, 220-7, 220-12
- formal, 210-4
- notice, 210-7
- preparation, 210-8
- requirements, 210-6
- informal, 210-4

Heritage Corridors Program Office, 120-11

Heritage tour route:

- barriers, 710-4
- designations, 120-11

Heritage tour route designations, 120-11

High occupancy vehicle (HOV) facility, 1050-1

- arterial HOV, 1050-10
- design criteria, 1050-7
- direct access, HOV Direct Access Design Guide, Draft, M 22-98
- HOV operations, 1050-5
- preliminary design and planning, 1050-2

Highway:

- airport clearance, 240-4
- capacity, 610-1
- classification, 440-1
- functional classification, 120-6, 440-1
- monumentation, 1450-1
- System Plan, 120-2, 120-10, 120-11

Highway Access Management Classification Reports, 120-7

Highway advisory radio, 860-4

Highway Capital Improvement Program, 325-9, 325-10

Highway Capital Preservation Program, 325-8

Highway construction program, 120-15

Highway-highway separation, 1110-3

Highway Performance Monitoring System (HPMS), 130-1

Highway-railroad separation, 1110-3

Highways and Local Programs Service Center, 120-10

Highway System Plan: see State Highway System Plan

Historical marker, 1030-1

Horizontal alignment, 620-1

Horizontal clearance in bridge design, 1120-2

HOV flyover, typical, HOV Direct Access Design Guide, Draft, M 22-98

HOV:

- design criteria, 1050-7
- direct access, HOV Direct Access Design Guide, Draft, M 22-98
- enforcement, 1050-6
- hours of operations, 1050-6
- operations, 1050-5
- SC&DI, 1050-6
- vehicle occupancy designation, 1050-5

Hydraulic considerations, 1210-1

- channel changes, 1210-2
- roadway drainage, 1210-2
- stream crossings, 1210-2
- subsurface discharge of highway drainage, 1210-3
- subsurface drainage, 1210-3
- the flood plain, 1210-1
- treatment of runoff, 1210-3

Hydraulic design, 1210-1

- design responsibility, 1210-3
- geotechnical investigation, 510-5
- hydraulic considerations, 1210-1
- safety considerations, 1210-3

## I

Illumination, 840-1, 1060-5

- bridges, 840-5
- construction zones and detours, 840-4
- definitions, 840-1
- design criteria, 840-5
- electrical design, 840-8
- freeway off and on ramps, 840-2
- freeway ramp terminals, 840-2
- highways with full limited access control, 840-4
- intersections with left turn channelization, 840-2

- intersections with traffic signals, 840-3
- intersections without channelization, 840-4
- light levels and uniformity ratio, 840-16
- light standard locations, 840-17
- light standards, 840-7
- line loss calculation, 840-19
- parking lots, 840-3
- pedestrian crossings, 840-3
- railroad crossings, 840-3
- references, 840-1
- required, 840-2
- rest areas, 840-5
- roadway lighting applications, 840-13
- transit flyer stops, 840-3
- truck weigh sites, 840-3
- tunnels, 840-3
- tunnels, underpasses, or lids, 840-4
- walkways and bicycle trails, 840-5
- illumination calculation examples, 840-21 to 840-24
- Impact attenuator systems, 720-1 to 720-12
  - comparison, 720-12
  - design criteria, 720-3
  - documentation, 720-5
  - older systems, 720-10, 720-11
  - permanent installations, 720-1, 720-6, 720-7, 720-8
  - selection, 720-4
  - sizes, 720-4
  - truck mounted, 720-3
  - work zone installations, 720-2, 720-9
- Impact Statement, Environmental (EIS) - Class I - NEPA, 220-3
- Impact Statement, Environmental (EIS) - Class I - SEPA, 220-3
- Intelligent transportation systems (ITS), 860-1
  - closed circuit television cameras, 860-1
  - motorist information, 860-4
  - National ITS Architecture, 860-1
  - surveillance, control, and driver information (SC&DI), 860-1
  - traffic data collection, 860-2
  - traffic flow control, 860-3
  - traffic operations center (TOC), 860-2
  - Traffic Systems Management Center (TSMC), 860-2
  - Venture Washington, 860-1
- Interchange, 940-1
  - definitions, 940-1
  - documentation, 940-10
  - collector distributor roads, 940-8
  - connections, 940-6
  - design, 940-2
  - future, 1425-5
  - on two-lane highways, 940-9
  - patterns, 940-2
  - plans, 940-10
  - ramps, 940-4
  - ramp design speed, 940-4
  - ramp grade, maximum, 940-5
  - ramp widths, 940-5
  - ramp terminal intersections at crossroads, 940-9
  - references, 940-1
  - spacing, 940-3
- Intercity Rail Passenger Plan, 120-8
- Interdisciplinary team (IDT), 220-3
- International boundaries, 1410-1
- Intersection at grade, 430-3, 910-1, 920-1
  - channelization, 910-4
  - design considerations, 910-2
  - design vehicle, 430-3
  - four leg intersection, 910-1
  - interchange ramp terminals, 910-11
  - intersection leg, 910-1
  - island, 910-2
  - procedures, 910-11
  - right-turn corners, 910-4
  - roundabouts, 910-2, 910-8
  - sight distance, 910-9
  - tee (T) intersection, 910-1
  - traffic control, 910-10
  - u-turns, 910-9
  - wye (W) intersection, 910-1
- Intersection design, transit, 1060-11, 1060-25, 1060-26
- Intersection radii, transit, 1060-11
- Interstate highway system, 120-2, 440-1, 1425-1 to 1425-15
- Investigation of soils, rock, and surfacing materials, 510-1
  - geotechnical investigation, design, and reporting, 510-2
  - geotechnical work by others, 510-14
  - materials sources, 510-1, 510-16
  - surfacing report, 510-14
  - use of geotechnical consultants, 510-14

- Irrigation, 1330-1
  - design considerations, 1330-1
  - general, 1330-1
  - references, 1330-1
- Islands, traffic, 910-2, 910-7
  - compound right-turn lane, 910-8
  - location, 910-8
  - size and shape, 910-7
- J**
- Joint use approach, 920-2
- L**
- Labor and Industries, Department of, 240-9
- Landscaping, 1060-5, 1300-2
- Land corner record, 1450-8
- Land use and transportation plans, 1425-5
- Lane:
  - balance, 620-3, 940-3
  - capacity volume relationship, 620-3
  - interchange connections, 940-6
  - lane reduction alternatives, 940-15
  - markers, 830-1
  - number and arrangement, 620-3
  - reduction, 940-4
  - transitions, 620-4
- Left-turn lanes, 910-4
  - one-way, 910-4
  - two-way, 910-5
- Left-turn storage guidelines, 910-5
- Legislative studies, 310-1
- Level of service, 610-1
- Lighting, 840-1
- Light levels, 840-5
- Light levels and uniformity ratio, 840-16
- Light standards, 840-7
  - locations, 840-17
- Limited access: see access
- Line enforcement, definition, 1050-2
- Line loss calculations, 840-19
- Longitudinal barriers, 710-1
- Longitudinal easements, railroad, 930-3
- Low Maintenance Attenuator System (LMA), 720-3, 720-11
- M**
- Mailboxes, 700-4, 1420-5
- Mailbox location and turnout design, 700-14
- Maintenance site: see sundry sites
- Maps: (also see plans)
  - bridges, 1110-1
  - designated state highway, 120-18
  - survey requirements, 1440-1
- Markings, pavement, 830-1
- Master Plan for Limited Access Highways, 120-7, 120-12
- Materials sources, 510-1, 510-16
- Mechanically stabilized earth walls, 1130-3
- Median, 440-5
  - barrier warrant, 700-5
  - bridge, 1120-2
  - cross sections, 640-6
  - crossovers, 960-1
  - transitions, width, 620-4
  - width, 430-1, 430-4, 440-5
- Median crossovers, 910-2, 960-1
  - analysis, 960-1
  - approval, 960-2
  - design, 960-1
- Memorandum of agreement, 220-7, 220-9
- Memorandum of understanding:
  - Highways Over National Forest Lands, 240-3
  - WSDOT-USCG & FHWA, 240-3
  - WSDOT-WDF & WDW, 240-6
  - WSP, 1040-2, 1040-13 to 1040-17
- Metropolitan Planning Organizations (MPO), 120-3
- Metropolitan Transportation Improvement Program (MTIP), 120-4, 120-14 to 120-18
- Mileposts, 820-4
- Minimum bus zone and pullout after right turn
  - dimensions, 1060-20
- Minimum bus zone dimensions, 1060-18
- Minor arterial system, 440-2
- Minor safety and minor preservation work, 410-1
- Modified design, 430-1
  - bridges, 430-3
  - cross slope, 430-2
  - design speed, 430-1
  - evaluation for stopping sight distance for crest vertical curves, 430-8
  - evaluation for stopping sight distance for horizontal curves, 430-9
  - fill slopes and ditch inslopes, 430-3
  - intersections, 430-3
  - main line roadway sections, 430-10
  - minimum total roadway widths for two-lane highway curves, 430-6

- minimum total roadway widths for two-lane highway curves,  $D < 90^\circ$ , 430-7
  - multilane highways and bridges, 430-4
  - profile grades, 430-2
  - ramp lane widths, 430-1
  - ramp roadway sections, 430-11
  - roadway widths, 430-1
  - stopping sight distance, 430-2
  - two-lane highways and bridges, 430-5
- Monitoring, 130-1
- Monumentation, 1450-1
  - alignment monuments, 1450-2
  - application for permits to remove or destroy a survey monument, 1450-5
  - control monuments, 1450-2
  - filing requirements, 1450-3
  - land corner record, 1450-3, 1450-8
  - monument documentation summary, 1450-4
  - other monuments, 1450-3
  - property corners, 1450-3
  - record of monuments and accessories, 1450-7
- Motorist information, 860-4
  - additional public information components, 860-4
  - dynamic message signs, 860-4
  - highway advisory radio, 860-4
- Multiple use of right of way, 1420-7
- N**
- National Highway System (NHS), 325-6, 325-7, 440-2
- National ITS Architecture, 860-1
- Natural Resources, Department of, 240-8
- Navigable waters, 240-3
- NEPA, 220-1
- New Jersey shape barrier, 710-12
- Noise barriers, 1140-1
  - design, 1140-1
  - earth berm, 1140-2
  - noise wall, 1140-2
  - procedures, 1140-3
  - standard noise wall types, 1140-3
- Noise wall, 1140-2, 1140-4
- Nomenclature and references, 110-1
- Noncommercial approaches, 920-3
- Nonconforming road approach, 920-2
- Nonmotorized transportation facilities, 1020-1
- Nonrecoverable slope, 700-1
- Nonwoven geotextiles, 530-1
- O**
- Observation point, bidirectional, 1050-23, 1050-36
- Occupancy designation, definition, 1050-2
- Office of Urban Mobility, 120-12
- One-way left-turn geometrics, 910-4
- Open house meetings, 210-4
- Overhead sign installation, 820-3
  - horizontal placement, 820-4
  - illumination, 820-3
  - monotube cantilever sign supports, 820-3
  - monotube sign bridges, 820-3
  - service walkways, 820-4
  - sign lighting fixtures, 820-3
  - structure mounted sign mountings, 820-3
  - vertical clearance, 820-4
- P**
- Park and ride lot, 510-7, 1060-1
  - access, 1060-3
  - bicycle, 1060-5
  - design, 1060-2
  - drainage, 1060-5
  - fencing, 1060-6
  - geotechnical investigation, 510-7
  - illumination, 1060-5
  - internal circulation, 1060-3
  - landscape preservation and development, 1060-6
  - maintenance, 1060-6
  - motorcycle facilities, 1060-5
  - pavement design, 1060-5
  - pedestrian movement, 1060-4
  - shelters, 1060-5
  - site selection, 1060-2
  - stall size, 1060-4
  - traffic control, 1060-5
- Parking stall size, 1060-3
- Partial access control, 1420-2
- Partial cloverleaf interchange, 940-3
- Passenger amenities, transit, 1060-10
  - introduction, 1060-10
  - passenger shelters, 1060-10
- Passing lanes, 1010-2

Passing sight distance, 650-1  
     design criteria, 650-1  
     horizontal curves, 650-2  
     no-passing zone markings, 650-2  
     vertical curves, 650-2  
 Patented items, 160-1  
 Paths, 1020-8  
 Pavement:  
     markings, 830-1  
     transit benefit facilities, 1060-10  
     transitions, 620-4  
     widening, 620-4  
 Pavement marking, 830-1  
     materials, 830-3  
     materials guide, 830-6  
     types, 830-1  
 Pavement structure, design, 520-1  
 Pedestrian facilities, 1020-8, 1060-4, 1120-3  
 Pedestrian grade separations, 1020-10  
 Pedestrian Policy Plan, 120-10  
 Permanent references, 1450-1  
 Permits:  
     governmental, 240-1  
     right of way, 1410-2  
     traffic signal, 850-3  
 Permit and easement details, 1410-2  
 Photogrammetry, 130-2, 1440-2  
 Pit sites, 1410-1  
 Planning, 120-1  
     definitions, 120-2  
     legislation and policy development, 120-2  
     linking transportation plans, 120-13  
     linking WSDOT planning to programming, 120-15, 120-19  
     planning and programming, 120-16  
     planning at WSDOT, 120-7  
     planning organizations, 120-3  
     planning to programming, 120-15  
     transportation improvement program development flow chart, 120-18  
     transportation plan relationship, 120-17  
     references, 120-1  
 Planning and environmental processes, 1425-9  
 Plans: see maps  
     access hearing, 1410-3, 1430-2  
     access report, 1410-3, 1430-1  
     Airport System Plan, 120-13  
     Bicycle Policy Plan, 120-10  
     bridge preliminary, 1110-1 to 1110-5  
     Comprehensive Plan, 120-13, 120-17  
     Corridor Management Plan, (CMP), 120-11  
     Findings and Order Plan, 1410-3, 1430-2  
     Freight and Goods Transportation System, 120-7  
     Freight Rail Plan, 120-9  
     Highway System Plan (DSP):  
         see State Highway System Plan  
     interchange, for approval, 940-3  
     international boundaries, 1410-1  
     intersection, for approval, 910-11  
     Master Plan for Limited Access Highways, 120-7, 120-12  
     Pedestrian Policy Plan, 120-10  
     public involvement, 210-2, 220-4  
     Public Transportation and Intercity Rail Passenger Plan, 120-8  
     right of way, 1410-1  
     Route Development Plan (RDP), 120-11, 120-12  
     signing, 820-4  
     State Highway System Plan (SHSP), 120-10 to 120-13, 120-15, 120-16, 120-18  
     study, 220-4  
     transportation, 1425-5  
     Travel Demand Management (TDM) Strategic Plan, 120-9  
     Washington's Transportation Plan (WTP), 120-4, 120-8, 120-9, 120-12, 120-15 to 120-18  
 Plant material selection, 1320-3  
 Policies:  
     pavement structure design, 520-1  
     signing, 820-1  
 Pollution control (DOE), 240-7  
 Preliminary bridge plans, 1110-1 to 1110-5  
 Preliminary design and planning of HOV facilities, 1050-2  
     conversion of a general-purpose lane, 1050-4  
     direct access, 1050-5  
     facility type, 1050-3  
     inside versus outside HOV lane, 1050-4  
     operational alternatives, 1050-3  
     planning elements for design, 1050-2  
     queue bypass lanes, 1050-5

- transit flyer stops, 1050-5
  - use of existing shoulder, 1050-4
  - Preliminary plans of vegetation, 1320-1
  - Preliminary studies, 310-2
  - Primary control surveys, 1440-1
  - Principal arterial system, 440-2
  - Procedures for intersection at grade, 910-11
    - approval, 910-11
    - intersection plans, 910-11
    - local agency or developer initiated intersections, 910-12
  - Profile grades, 430-2
  - Program development, 140-1
  - Program Management Office, 120-15
  - Programs
    - Heritage Corridors Program, 120-11
    - highway construction program, 120-15
    - Metropolitan Transportation Improvement Program (MTIP), 120-4, 120-14 to 120-18
    - Regional Transportation Improvement Program (RTIP), 120-14, 120-17, 120-18
    - State Commute Reduction Program, 120-8
    - Statewide Transportation Improvement Program (STIP), 120-5, 120-10, 120-14, 120-15, 120-18
    - Surface Transportation Program, 120-7
    - Transportation Improvement Program (TIP), 120-5, 120-14
    - Transportation Demand Management (TDM), 120-9
    - Travel Demand Management program, 120-10, 120-12
    - Watchable Wildlife Program, 120-12
  - Project:
    - classification, 220-2
    - direct federal, 240-4
    - reviews, 220-12
  - Project analysis, 325-1
    - sample, 330-11, 330-12
  - Project definition phase, 330-2
    - design decision summary (DDS), 330-2
    - environmental review summary (ERS), 330-2
    - project definition (PD), 330-2
    - project summary, 330-2
  - Project requirements for traffic barriers, 710-1
    - barrier terminals and transitions, 710-2
    - bridge rail, 710-2
    - standard run of barrier, 710-2
  - Property corners, 1450-3
  - Proprietary items, 160-1
  - Propriety walls, 1130-8
  - Protective screening for highway structures, 1120-4
  - PS&E process approvals, 330-10
  - Public hearing access, 1430-2
  - Public information components, 860-4
  - Public involvement and hearings, 210-1
    - access hearing, 210-12
    - administrative appeal hearing, 210-15
    - advertise a hearing or opportunity for a hearing, 210-7
    - combined hearings, 210-15
    - corridor hearing, 210-11
    - design hearing, 210-12
    - environmental hearing, 210-11
    - formal hearings, 210-4
    - hearings, 210-6
    - hearing notice, 210-7
    - hearing preparation, 210-8
    - hearing requirements, 210-6
    - hearing summary contents, 210-11
    - informal hearings, 210-4
    - no hearing interest, 210-8
    - notification techniques, 210-5
    - open house meetings, 210-4
    - public involvement, 210-2
    - public meetings and open house meetings, 210-4
    - sequence for a hearing, 210-16
  - Public involvement plan, 210-3
  - Public transfer facilities, 1060-1
  - Public Transportation and Intercity Rail Passenger Plan, 120-8
  - Public Transportation and Rail Division, 120-8
- Q**
- Quarry site: see sundry sites
- R**
- Rail plan, 120-8
  - Railroad:
    - approaches, access control, 1420-6
    - crossing, 630-3, 930-1
    - easements, 930-3
    - encroachments, 330-4, 930-3
    - grade crossings, 930-1



- grade crossing orders, 930-3
- longitudinal easements, 930-3
- right of way acquisition from, 1410-4
- stopping lanes, 930-2
- traffic control systems, 930-1
- vertical clearance, 1120-5, 1120-6
- Railroad vertical clearance, 1120-5, 1120-6
- Ramp, 940-4
  - design speed, 940-4
  - grade, 940-4
  - lane increases, 940-5, 1050-12, 1050-25
  - lane widths, 430-1, 940-5
  - meter, HOV bypass, 1050-8, 1050-15, 1050-16, 1050-28
  - meters, 940-5
- Ramp, curb, 910-8, 1020-9
- Ramps, interchange, 940-1
- Reconstruction, 440-1
- Record of decision, 220-2
- Record of monuments and accessories, 1450-3, 1450-7
- Recoverable slope, 700-1
- Redirectional land forms, 710-15
- Regional Transportation Improvement Program (RTIP), 120-14, 120-17, 120-18
- Regional Transportation Planning Organizations (RTPOs), 120-4, 120-6
- Reports:
  - access, 1430-1
  - access point decision, 1425-1
  - discipline, 220-5
- Request for value engineering study, 315-6
- Required data for all structures, 1110-1
  - CAD files and supplemental drawings, 1110-1
  - report, 1110-2
  - video and photographs, 1110-2
- Required safety items of work, 410-1
- Rest areas, 1030-1
- Retaining wall classifications, 1130-1
- Retaining wall geotechnical investigation, 510-8
- Retaining walls and steep reinforced slopes, 1130-1
  - design principles, 1130-2
  - design requirements, 1130-2
  - design responsibility and process, 1130-8
  - guidelines for wall/slope selection, 1130-5
  - summary of wall options, 1130-14
- Reviews and approvals, 330-7
- Revisions, *Design Manual*, 100-1
- Right of way:
  - acquisition, 1410-4
  - appraisal, 1410-4
  - considerations, 1410-1
  - multiple use, 1420-7
  - plans, 1410-1
  - programming for funds, 1410-4
  - transactions, 1410-4
- Right of way considerations, 1410-1
  - acquisition, 1410-4
  - appraisal, 1410-4
  - documentation, 1410-5
  - easements, 1410-2
  - general, 1410-1
  - permits, 1410-2
  - programming for funds, 1410-4
  - references, 1410-1
  - special features, 1410-2
  - transactions, 1410-4
- Right of way special features, 1410-2
  - cattle passes, 1410-2
  - international boundaries, 1410-2
  - pits sites, 1410-2
  - road approaches, 1410-2
  - stockpile sites, 1410-2
  - waste sites, 1410-2
- Right of way transactions, 1410-4
  - condemnations, 1410-5
  - federal agencies, 1410-4
  - other state agencies, 1410-5
  - private ownerships, 1410-4
  - railways, 1410-4
  - utilities, 1410-4
- Right-turn at intersections at grade,
  - corners, 910-4, 910-15
  - lane guidelines, 910-26
  - pocket and taper, 910-6, 910-27
- Right-turn lane, 910-5
- Road approaches, 920-1, 1410-2, 1420-8
  - design considerations, 920-2
  - drainage requirements, 920-4
  - procedures, 920-4
  - road approach connection category, 920-2
  - road approach design template, 920-2
  - road approach spacing and corner clearance, 920-3
  - sight distance, 920-3

- Roadside classification plan, 1300-2
  - Roadside development, 1300-1
    - design recommendations, 1300-3
    - design requirements, 1300-2
    - documentation, 1300-2
    - general, 1300-1
    - references, 1300-2
    - roadside classification plan, 1300-2
    - roadside manual, 1300-2
  - Roadside safety, 700-1
    - clear zone, 700-1, 700-2
    - hazards to be considered for mitigation, 700-2
    - headlight glare, 700-6
    - median considerations, 700-5
    - other roadside safety features, 700-5
    - rumble strip, 700-5
  - Roadsides, 640-7
    - bridge end slopes, 640-9
    - drainage ditches in embankment areas, 640-9
    - roadway sections in rock cuts, 640-7
    - side slopes, 640-7
    - stepped slopes, 640-9
  - Roadway, 640-2
    - drainage, 1210-2
    - sections, 640-3
    - shoulders, 640-4
    - traveled way cross slope, 640-2
    - turning roadway widths, 640-2
    - widths, 430-1, 440-4
  - Roadway lighting applications, 840-13, 840-14, 840-15
  - Roadway and vehicle design characteristics, transit, 1060-10
    - articulated transit buses, 1060-11
    - large transit buses, 1060-11
    - paving sections, 1060-10
    - small transit buses, 1060-11
    - vehicle characteristics/specifications, 1060-11
  - Roadway widths for three-lane HOV on and off ramps, 1050-12, 1050-25
  - Rock cuts, 640-7
    - geotechnical investigation, 510-10
    - hazard, side slope, 700-3
  - Roundabouts, 910-2, 910-8, IL 4019.00
  - Route Development Plans, 120-11, 120-12
  - Route/design studies, 310-3
  - Rumble strips, 700-5
  - Rural Deviation, Sample, 330-14, 330-15
- S**
- Safety rest areas, 1030-1, 1210-3
  - Sawtooth bus berth design example, 1060-15
  - Scenic byway:
    - barriers, 710-4
    - designations, 120-11
  - Screening of unsightly areas, 1300-2
  - Seal projects, 330-1
  - Section 4(f) evaluation, 220-2, 220-6
  - Sections, roadway, 640-1
  - Selection of impact attenuator system, 720-4
  - Semidirectional interchange, 940-2
  - SEPA, 220-1
  - SEPA; Check List, 220-10
  - Separated HOV facility, definition, 1050-2
  - Separated roadway multi-lane, one-way or reversible, 1050-14, 1050-27
  - Separated roadway single-lane, one-way or reversible, 1050-13, 1050-26
  - Service, level of, 610-1
  - Shallow-seated instability, 1350-2
  - Shelter siting, 1060-21
  - Shelters:
    - passenger, 1060-10
    - pedestrian, 1060-5
  - Shoreline development permits, 240-10
  - Shoreline stabilization, 1350-1
  - Shoulder:
    - cross section, 640-4
    - driving, 1010-3
    - enforcement areas, 1050-9
    - shy distance, 440-7, 910-7
    - slope, 640-4
    - turnouts, 1010-2
    - weigh sites, 1040-4
    - width, 430-1, 440-4
  - Shy distance:
    - curb, 430-4, 430-5, 640-22, 710-1, 910-7, 910-8
    - definition, 1050-2
    - intersections, 910-9
    - islands, 910-7
    - shoulder, 440-5, 910-7
    - structures, 440-6
    - traffic barriers, 710-3
    - turning vehicles, 910-10

Sidewalks, 1020-7, 1020-9  
 Sight distance, 650-1  
     at intersections, 910-9  
     decision sight distance, 650-4  
     design stopping sight distance, 650-2  
     existing stopping sight distance, 650-2  
     passing sight distance, 650-1  
     ramp, 940-4  
     road approach, 920-3  
     stopping sight distance, 650-2  
     stopping sight distance for crest vertical curves, 650-3  
     stopping sight distance for horizontal curves, 650-4  
     stopping sight distance for sag vertical curves, 650-4  
 Sight triangle, 910-10  
 Signals, traffic control, 850-1  
     geotechnical investigation, 510-7  
 Signing, 820-1  
     design components, 820-2  
     geotechnical investigation, 510-7  
     guide sign plan, 820-4  
     mileposts, 820-4  
     overhead installation, 820-3  
 Single-lane ramp meter with HOV bypass, 1050-15, 1050-28  
 Single point (urban) interchange, 940-3  
 Single slope barrier, 710-12  
 Site data for structures, 1110-1  
     additional data for grade separations, 1110-3  
     additional data for waterway crossings, 1110-2  
     additional data for widenings, 1110-4  
     geotechnical investigation, 510-3  
     required data for all structures, 1110-1  
 Slip ramp, typical, 1050-20, 1050-33  
 Slopes:  
     bridge end, 640-9  
     geotechnical investigation, 510-8  
     roadway, 640-2  
     selection: see wall/slope selection  
     shoulder, 640-4  
     side, 640-7  
     stepped, 640-9  
 Slow moving vehicle turnouts, 1010-2  
 Soil bioengineering, 1350-1  
     design responsibilities and considerations, 1350-3  
     erosion control, 1350-3  
     streambank/shoreline stabilization, 1350-4  
     upland slope stabilization, 1350-4  
     uses, 1350-1  
 Soil bioengineering applications and the documents that support, 1350-3  
 Space, air, 1420-7  
 Special features, right of way, 1410-2  
 Special permits and approvals, 240-1  
 Speed, design, 430-1, 440-3, 940-4  
 Speed change lanes, 910-6, 940-6, 940-7  
 Standards:  
     design, 160-1  
     noise wall types, 1140-4  
     traffic interchanges, 940-1  
 State agencies, 240-1  
 State Commute Trip Reduction Program, 120-8  
 State Highway System Plan (SHSP), 120-5, 120-10 to 120-18, 1425-9  
 Statewide Transportation Improvement Program (STIP), 120-5, 120-10, 120-14, 120-15, 120-18  
 Stepped slopes, 640-9, 650-1  
 Stockpile site reclamation, 1410-2  
 Stopping sight distance, 430-2  
     crest vertical curve, 650-3  
     design criteria, 650-2  
     design stopping sight distance, 650-3  
     design stopping sight distance on grades, 650-3  
     effects of grade, 650-3  
     existing stopping sight distance, 650-3  
     horizontal curves, 650-4  
     sag vertical curves, 650-4  
 Streambank stabilization, 1350-2  
 Stream crossings, 1210-2  
 Structure clearances, 1120-2  
 Structure data, 1110-1  
     CAD files, 1110-1  
     photographs, 1110-2  
     reports, 1110-2  
     supplemental drawings, 1110-1  
     video, 1110-2  
 Study plan, 220-2, 220-4  
 Subsurface drainage, 1210-3  
 Sundry sites:  
     public lands, 240-8  
     right of way, 1410-2  
     source of materials, 510-1

- Superelevation, 640-4
    - existing curves, 640-5
    - superelevation rates for open highways and ramps, 640-4
    - turning movements at intersections, 640-5
  - Superelevation runoff for highway curves, 640-5
  - Superelevation runoff for ramp curves, 640-6
  - Surface Transportation Program, 120-7
  - Surface movement, 1350-2
  - Surfacing, 510-1 (see pavement structure, 520-1)
  - Surveillance, control, and driver information (SC&DI), 860-1
  - Surveying and mapping, 1440-1
    - after construction is completed, 1440-2
    - datums, 1440-2
    - documentation, 1440-3
    - during the project definition stage, 1440-1
    - during design and PS&E development, 1440-1
    - general, 1440-1
    - geographic information system, 1440-3
    - global positioning system, 1440-2
    - photogrammetric surveys, 1440-3
    - procedures, 1440-1
    - reference, 1440-1
    - WSDOT monument database, 1440-2
  - Systems data and services, 130-1
- T**
- Taper, 910-6
  - TDM Strategic Plan, 120-9
  - Temporary right for construction (permit), 1410-3
  - Temporary road approach, 920-2
  - Terrain classification, 440-3
  - Traffic analysis, 130-2
    - for freeways, 1425-6 to 1425-9
    - for intersection at grade, 910-2
  - Traffic barriers: see Barriers
  - Traffic control, 810-1
    - construction work zone traffic controls, 810-1
    - intersections, 910-10
    - procedures, 810-2
    - strategy, 810-1
    - use of law enforcement in work zone, 810-1
    - work zone traffic control design checklist, 810-2
  - Traffic flow control, 860-3
    - HOV bypass, 860-4
    - ramp meters, 860-3
  - Traffic interchanges, 940-1
    - definitions, 940-2
    - documentation, 940-10
    - collector distributor roads, 940-8
    - connections, 940-6
    - design, 940-2
    - on two-lane highways, 940-9
    - patterns, 940-2
    - plans, 940-10
    - ramps, 940-4
    - ramp design speed, 940-4
    - ramp grade, maximum, 940-5
    - ramp widths, 940-5
    - ramp terminal intersections at crossroads, 940-9
    - references, 940-1
    - spacing, 940-3
  - Traffic island design, 910-7
  - Traffic control devices:
    - channelization, 910-4
    - pavement markings, 830-1
    - signals, 850-1
  - Traffic Operations Center (TOC), 860-2
  - Traffic Systems Management Center (TSMC), 860-2
  - Traffic lanes, 440-4
  - Trails, 1020-9
  - Transfer/transit center, 1060-6
    - bus berths, 1060-7
    - flow/movement alternatives, 1060-7
    - introduction, 1060-6
  - Transit, 1060-1
    - flyer stop, 1050-5
  - Transit benefit facilities, 1060-1
    - bus stops and pullouts, 1060-7
    - design criteria characteristics, 1060-10
    - disabled accessibility, 1060-12
    - intersection radii, 1060-11
    - park and ride lots, 1060-1
    - passenger amenities, 1060-10
    - roadway and vehicle design criteria characteristics, 1060-10
    - transfer/transit centers, 1060-6

Transitions, pavement, 620-4  
Transportation Demand Management, 120-9  
Transportation Facilities and Services of  
Statewide Significance, 120-6  
Transportation Improvement Program, 120-5,  
120-14  
Transportation Plan Relationships, 120-17  
Transportation Systems Management (TSM),  
120-3  
Travel data, 130-2  
Travel Demand Management (TDM), 120-9  
Travel Demand Management program, 120-10,  
120-12  
Travel services, 1030-1  
Traveled way, 440-2, 640-2, 700-2, 940-2,  
1010-2  
Traverse, specifications for, 1440-3  
Triangulation, specifications for, 1440-3  
Truck climbing lanes (see climbing lanes),  
1010-2  
Truck escape ramps (see emergency escape  
ramps), 1010-2  
Truck-Mounted Attenuator (TMA), 720-3  
Truck weigh site, 1040-1  
Turning path template, 910-13, 910-14, 1060-24  
Turning ramp lane widths, 430-1, 430-11  
Turning roadway widths, 640-2, 430-1, 430-6,  
430-7  
Turnouts, 1010-3  
Two-lane ramp meter with HOV bypass,  
1050-16, 1050-29  
Two-way left turn lanes, 910-5, 910-25  
Types of standard walls, 1140-4  
Typical bus shelter design, 1060-22

## U

Upland slope stabilization, 1350-2  
    deep-seated instability, 1350-2  
    shallow-seated instability, 1350-2  
    surface movement, 1350-2  
Use of law enforcement in work zone, 810-1  
Using a design matrix, 325-4  
    design levels, 325-4  
    design variances, 325-5  
Utilities, 1410-4  
Utility agreements, 240-10  
U-turns, 910-9

## V

Value engineering, 315-1  
    eight-phase job plan for VE studies,  
    315-5  
    implementation phase, 315-3  
    procedure, 315-1  
    request for value engineering study,  
    315-6  
    selection phase, 315-1  
    VE study team tools, 315-7  
Vegetation, 1320-1  
    design guidelines, 1320-2  
    discussion, 1320-1  
    documentation, 1320-3  
    establishment of vegetation, 1320-3  
    existing vegetation, 1320-2  
    general, 1320-1  
    plant material selection, 1320-3  
    preliminary plans, 1320-1  
    recommendation, 1320-1  
    references, 1320-1  
    reviews, 1320-1  
Vehicle turning path template, 910-4, 910-13,  
910-14, 1060-23, 1060-24  
Venture Washington, 860-1  
Vertical alignment, 630-1  
    alignment on structures, 630-2  
    design controls, 630-1  
    length of grade 630-2  
    maximum grades, 630-2  
    minimum grades, 630-2  
    minimum length of vertical curves, 630-2  
Vertical clearance, bridges, 1120-2  
VE study team tools, 315-7  
Videologging, 130-2  
Viewpoints, 1030-1  
Violation rate, definition, 1050-2

## W

Walkways, 1020-8  
Wall/slope selection, 1130-5  
    cost considerations, 1130-7  
    cut and fill considerations, 1130-5  
    facing options, 1130-7  
    feasible wall and slope heights and  
    applications, 1130-6  
    settlement and deep foundation support  
    considerations, 1130-6  
    summary, 1130-8  
    supporting structures or utilities, 1130-6

Walls, retaining, 1130-1  
 Walls, types of standard, 1140-4  
 Warrants for median barrier, 700-5, 700-15  
 Washington coordinate system, 1440-1  
 Washington State Patrol:  
     High Occupancy Vehicle (HOV)  
         facilities, 1050-6  
     Intelligent Transportation Systems, 860-2  
     median crossover, 960-1  
     planning, 120-12  
     protective screening, 1120-4  
     weigh sites, 1040-1  
 Washington's Transportation Plan (WTP),  
     120-4, 120-8, 120-9, 120-12, 120-15 to  
     120-18  
 Waste site, 1300-2, 1410-2  
 Watchable Wildlife Program, 120-12  
 Water quality permits, 240-7  
 Watercraft facilities, 1020-10  
 Waterway crossings, 1110-2  
 Weaving sections, length, 940-32  
 Weigh sites, truck, 1040-1  
     definitions, 1040-1  
     federal participation, 1040-4  
     memorandum of understanding to vehicle  
         weighing and equipment inspection  
         facilities, 1040-13  
     multilane highways, 1040-6  
     permanent facilities, 1040-2  
     planning, development, and  
     responsibilities, 1040-1  
     portable facilities, 1040-3  
     portable scale site, 1040-1, 1040-9  
     procedures, 1040-4  
     shoulder site, 1040-11, 1040-12  
     shoulder sites, 1040-4  
     two lane highways, 1040-7  
     vehicle inspection installation, 1040-8  
 Wetlands, 220-5  
 Wheelchair curb ramps, 1020-9  
 Widening:  
     bridge, 1110-4  
     pavement, 620-4  
 Widths:  
     bridge, 430-4, 430-5, 440-7, 440-8,  
         440-10, 440-12, 1120-2  
     HOV facilities, 1050-7  
     lane, 430-4, 440-4  
 Wildlife, Department of, 240-6  
 Wildlife warning reflectors, 830-5, 830-6  
 Work zone traffic control strategy, 330-2, 330-11,  
     810-1  
 Work zone traffic control design checklist, 810-1  
 Woven geotextiles, 530-1  
 WSDOT furnished items, 160-1  
 WSDOT monument database, 1440-2