

GENERAL NOTES

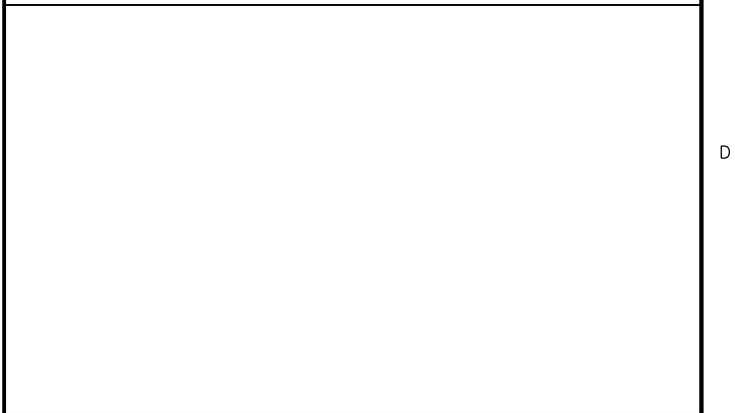

REFERENCES

REFERENCES

REVISIONS

ZONE	REV	DESCRIPTION	DATE	APPROVED

SYMBOL LIST		SYMBOL LIST (CONT.)	
	GATE VALVE (REMOTE OPERATED)		INDICATES DIRECTION OF FLOW
	BALL VALVE		TEMPERATURE GAUGE, LOCAL
	GATE VALVE		PRESSURE GAUGE
	GLOBE VALVE		PRESSURE/VACUUM GAUGE
	SWING CHECK VALVE		DIFFERENTIAL PRESSURE GAUGE
	PURIFIER		FLANGED JOINT
	STRAINER		CAP, PIPE END
	PUMP		UNION
	FILTER		TEE, STRAIGHT
	INDICATES PROCESS POINT		ELBOW, 90 DEGREE
	INDICATES LIQUID LEVEL		THERMOMETER WELL
	SYSTEM PIPING		
	VENT PIPING		

SYMBOL LIST (CONT.)	
	VALVE, ANGLE, FLANGED
	FLANGED VALVE, ANGLE, TURNED DOWN, HANDWHEEL SHOWN
	ELBOW, TURNED DOWN

DIAGRAM 4-A FUEL SCHEMATIC



PUGET SOUND CLEAN AIR AGENCY  
SEATTLE, WA

WSF BIODIESEL STUDY  
ISSAQUAH 130 FUEL SYSTEM MODIFICATIONS  
FUEL SYSTEM SCHEMATIC

THE GLOSTEN ASSOCIATES  
Consulting Engineers Serving the Marine Community

1201 Western Avenue, Suite 200  
Seattle, Washington 98101-2921  
TEL 206.624.7850  
FAX 206.682.9117  
WEB www.glosten.com

Drawn by	Date	Checked by	Date	Approved by	Date
DWC	12/07/07	DWL	12/07/07	PSS	12/07/07
Scale	Drawing Number	Sheet	of	Rev	
NO SCALE	07070-03	1	3		

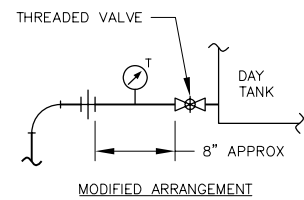
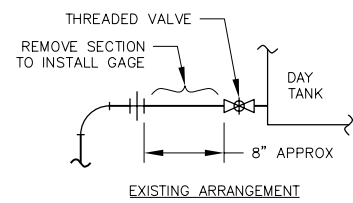

DETAIL 14-C  
DAY TANK SUCTION  
MODIFICATIONS

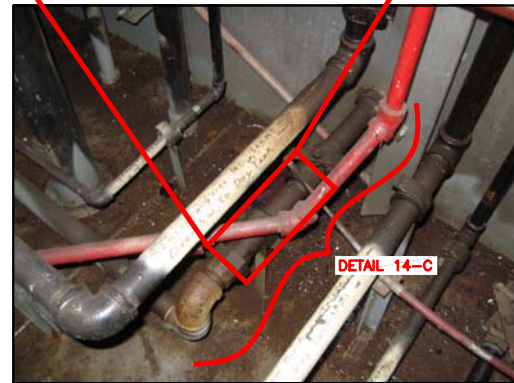

PHOTO 15-C  
DAY TANK SUCTION



PURIFIER SAMPLE LINES

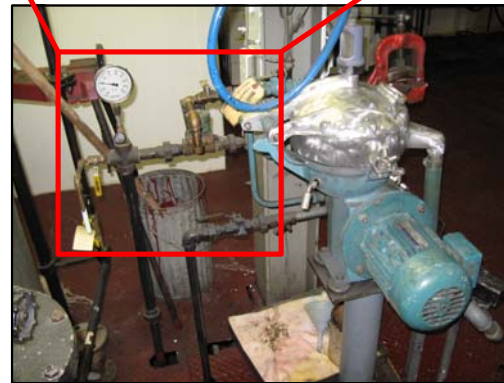
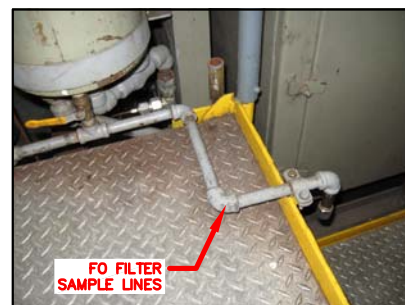

PHOTO 12-C  
EXISTING PURIFIER SAMPLE LINES  
(NO MODIFICATION REQUIRED)



PHOTO 10-C  
FO STORAGE TANK 1  
FILL/SUCTION



FO FILTER SAMPLE LINES



FO FILTER SAMPLE LINES

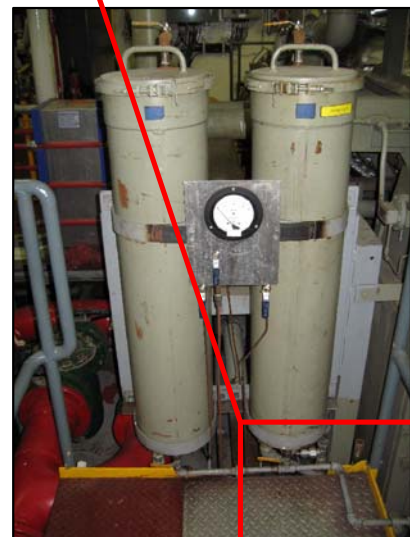

PHOTO 15-A  
EXISTING FUEL FILTER NO. 1 SAMPLE LINES  
(NO MODIFICATION REQUIRED)

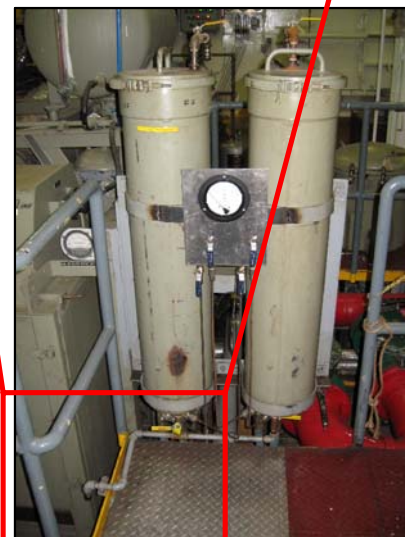

PHOTO 13-A  
EXISTING FUEL FILTER NO. 2 SAMPLE LINES  
(NO MODIFICATION REQUIRED)

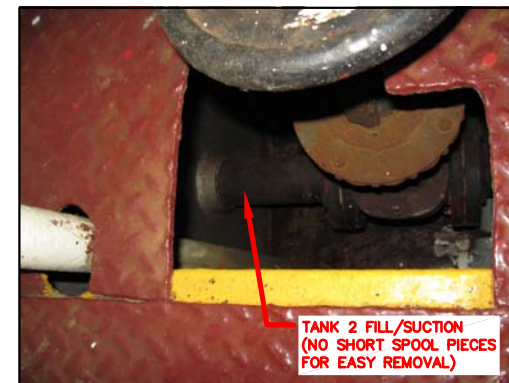

PHOTO 12-A  
FO STORAGE TANK 2  
FILL/SUCTION

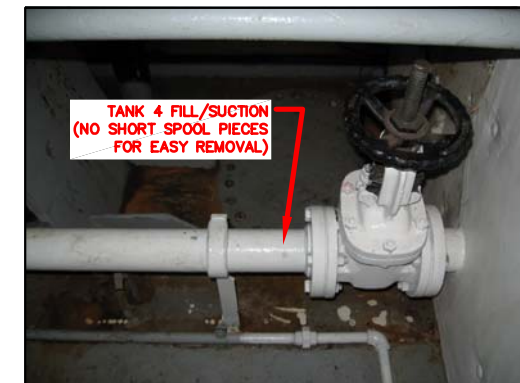



PHOTO 10-A  
FO STORAGE TANK 4  
FILL/SUCTION

 <p>DAVID W. LAPEERE STATE OF WASHINGTON EXPIRES 08/26/</p>	PUGET SOUND CLEAN AIR AGENCY SEATTLE, WA				
	WSF BIODIESEL STUDY ISSAQUAH 130 FUEL SYSTEM MODIFICATIONS FUEL SYSTEM MODIFICATIONS				
 <p>THE GLOSTEN ASSOCIATES Consulting Engineers Serving the Marine Community</p>		1201 Western Avenue, Suite 200 Seattle, Washington 98101-2921 TEL 206.824.7500 FAX 206.682.9117 WEB www.glosthen.com			
Drawn by DWC	Date 12/07/07	Checked by DWL	Date 12/07/07	Approved by PSS	Date 12/07/07
Scale NO SCALE	Drawing Number 07070-03		Sheet 2 of 3		Rev -

D

D

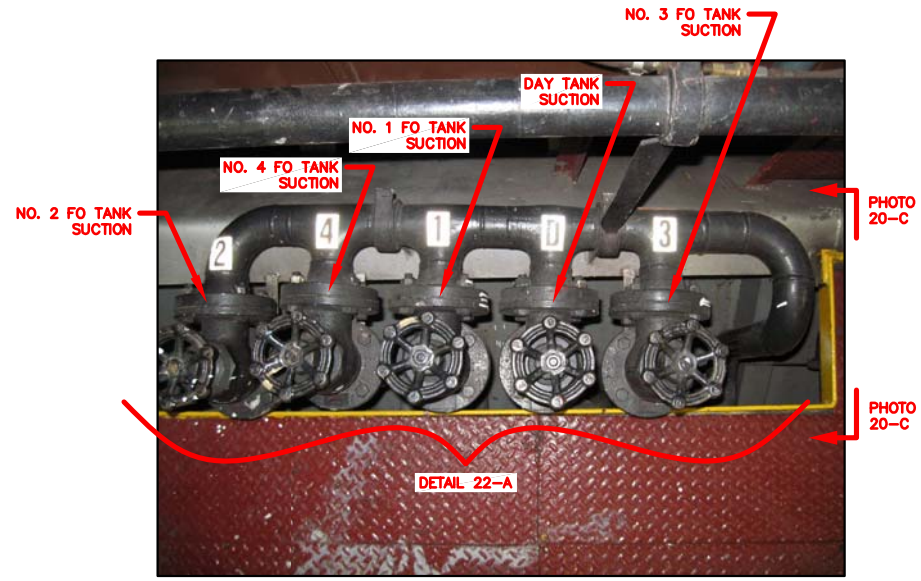

PHOTO 22-C  
FO TANK SUCTION MANIFOLD  
(OVERHEAD VIEW)

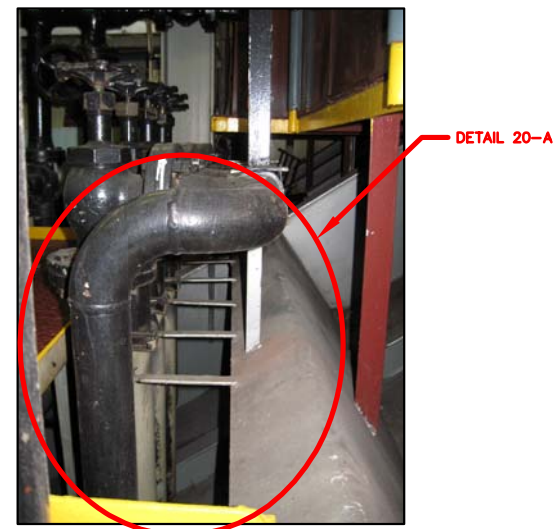

PHOTO 20-C  
FO TANK SUCTION MANIFOLD  
(SIDE PROFILE)

C

C

B

B

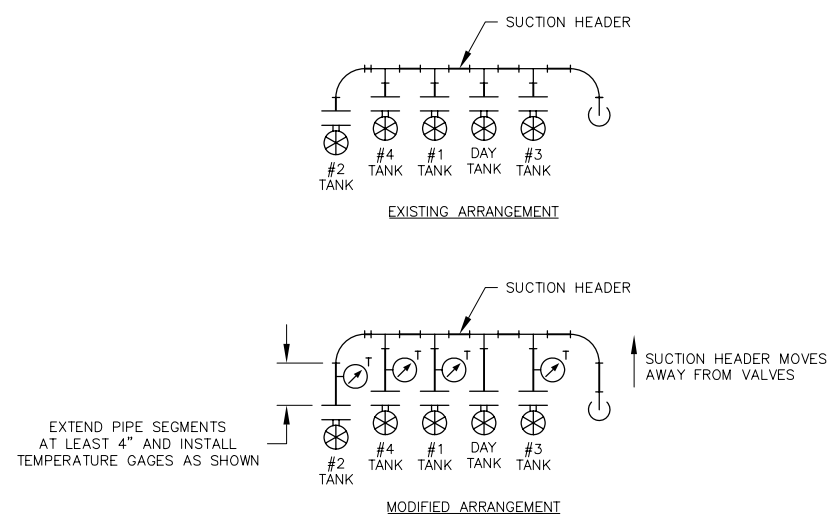

DETAIL 22-A  
FO TANK SUCTION MANIFOLD  
(OVERHEAD VIEW)

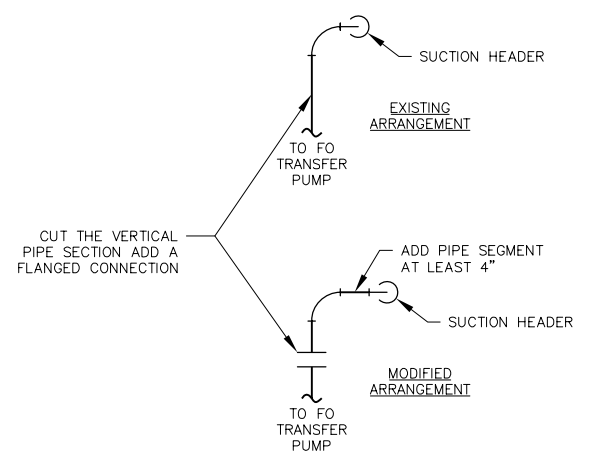

DETAIL 20-A  
FO TANK SUCTION MANIFOLD  
(SIDE PROFILE VIEW)

A

A

	PUGET SOUND CLEAN AIR AGENCY SEATTLE, WA				
	WSF BIODIESEL STUDY ISSAQUAH 130 FUEL SYSTEM MODIFICATIONS FUEL SYSTEM MODIFICATIONS				
	THE GLOSTEN ASSOCIATES Consulting Engineers Serving the Marine Community		1201 Western Avenue, Suite 200 Seattle, Washington 98101-2921 TEL 206.824.7500 FAX 206.822.9117 WEB www.glosten.com		
Drawn by DWC	Date 12/07/07	Checked by DWL	Date 12/07/07	Approved by PSS	Date 12/07/07
Scale NO SCALE	Drawing Number 07070-03	Sheet 3 of 3			

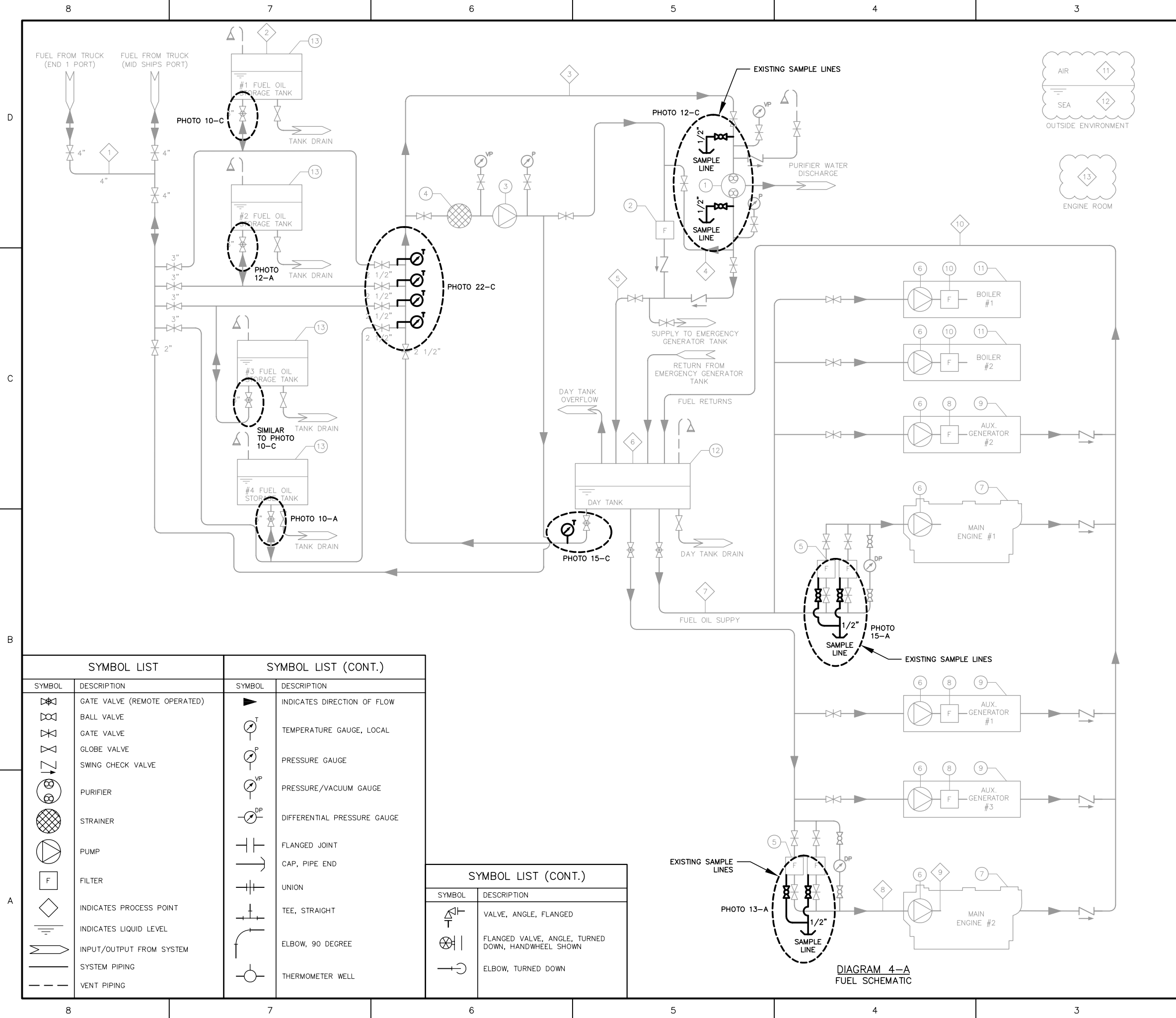

GENERAL NOTES

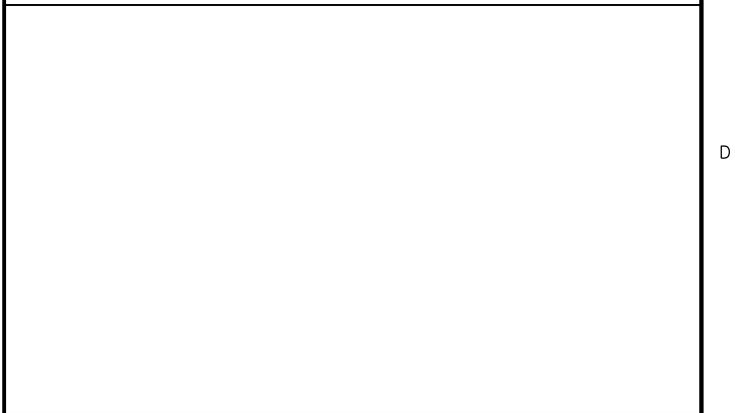

REFERENCES

REFERENCES

REVISIONS

ZONE	REV	DESCRIPTION	DATE	APPROVED

SYMBOL LIST	
	GATE VALVE (REMOTE OPERATED)
	BALL VALVE
	GATE VALVE
	GLOBE VALVE
	SWING CHECK VALVE
	PURIFIER
	STRAINER
	PUMP
	FILTER
	INDICATES PROCESS POINT
	INDICATES LIQUID LEVEL
	SYSTEM PIPING
	VENT PIPING

SYMBOL LIST (CONT.)	
	INDICATES DIRECTION OF FLOW
	TEMPERATURE GAUGE, LOCAL
	PRESSURE GAUGE
	PRESSURE/VACUUM GAUGE
	DIFFERENTIAL PRESSURE GAUGE
	FLANGED JOINT
	CAP, PIPE END
	UNION
	TEE, STRAIGHT
	ELBOW, 90 DEGREE
	THERMOMETER WELL

SYMBOL LIST (CONT.)	
	VALVE, ANGLE, FLANGED
	FLANGED VALVE, ANGLE, TURNED DOWN, HANDWHEEL SHOWN
	ELBOW, TURNED DOWN

DIAGRAM 4-A FUEL SCHEMATIC



PUGET SOUND CLEAN AIR AGENCY  
SEATTLE, WA

WSF BIODIESEL STUDY  
ISSAQUAH 130 FUEL SYSTEM MODIFICATIONS  
FUEL SYSTEM SCHEMATIC

**THE GLOSTEN ASSOCIATES**  
Consulting Engineers Serving the Marine Community

1201 Western Avenue, Suite 200  
Seattle, Washington 98101-2921  
TEL 206.624.7850  
FAX 206.682.9117  
WEB www.glosten.com

Drawn by	Date	Checked by	Date	Approved by	Date
DWC	12/07/07	DWL	12/07/07	PSS	12/07/07
Scale		Drawing Number		Rev	
NO SCALE		07070-03			



D

D

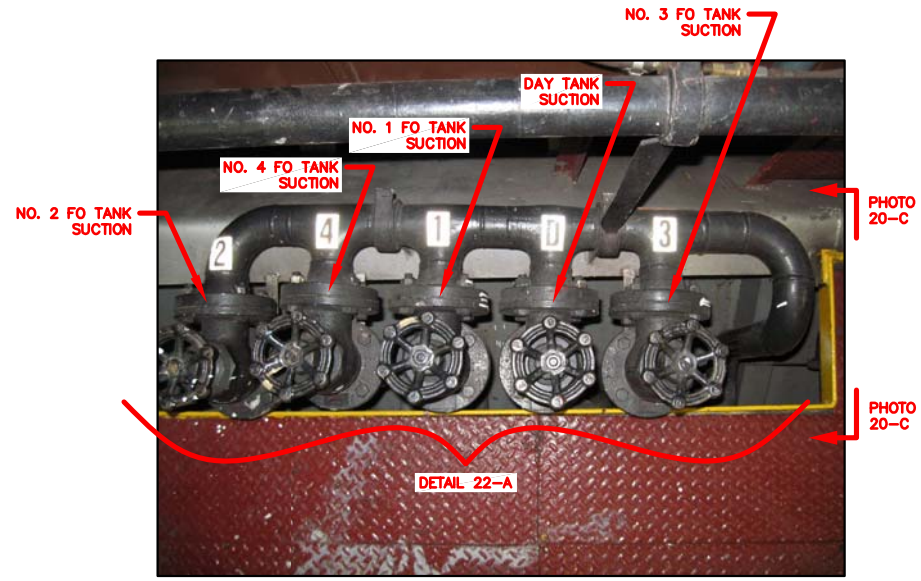

PHOTO 22-C  
FO TANK SUCTION MANIFOLD  
(OVERHEAD VIEW)

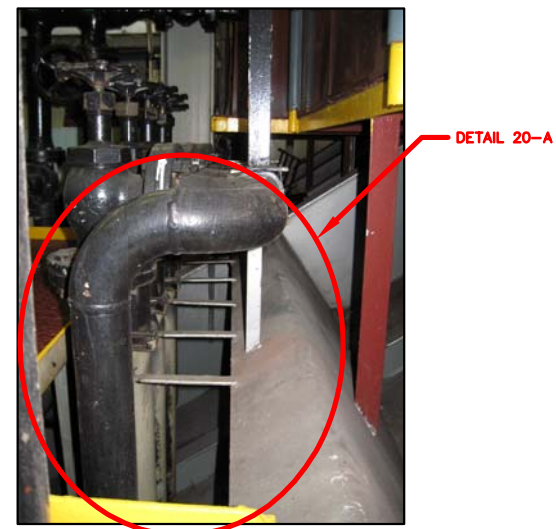

PHOTO 20-C  
FO TANK SUCTION MANIFOLD  
(SIDE PROFILE)

C

C

B

B

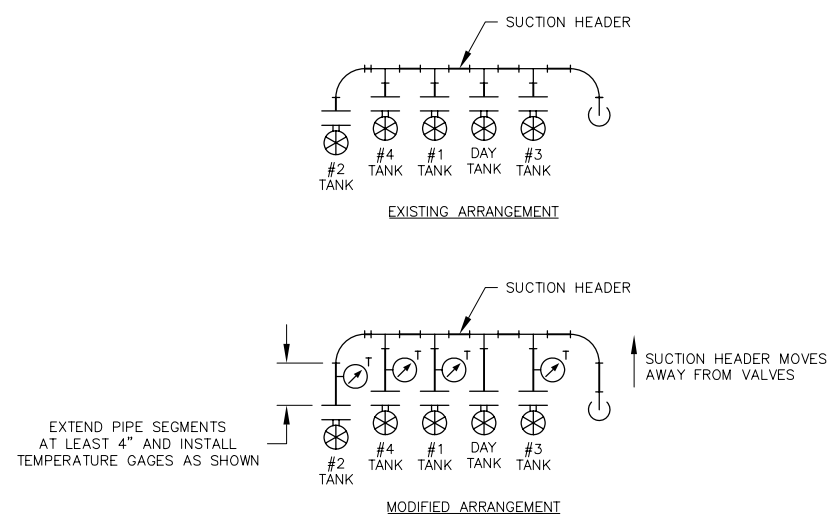

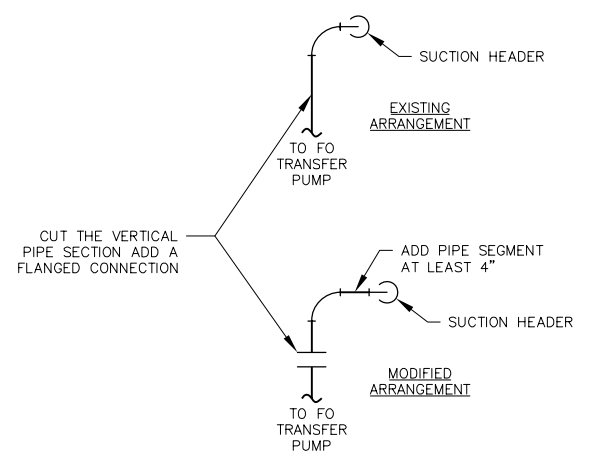

DETAIL 22-A  
FO TANK SUCTION MANIFOLD  
(OVERHEAD VIEW)



DETAIL 20-A  
FO TANK SUCTION MANIFOLD  
(SIDE PROFILE VIEW)

A

A

 EXPIRES 08/26/	PUGET SOUND CLEAN AIR AGENCY SEATTLE, WA				
	WSF BIODIESEL STUDY ISSAQUAH 130 FUEL SYSTEM MODIFICATIONS FUEL SYSTEM MODIFICATIONS				
 THE GLOSTIEN ASSOCIATES Consulting Engineers Serving the Marine Community		1201 Western Avenue, Suite 200 Seattle, Washington 98101-2921 TEL 206.824.7503 FAX 206.682.9117 WEB www.glostien.com			
Drawn by	Date	Checked by	Date	Approved by	Date
DWC	12/07/07	DWL	12/07/07	PSS	12/07/07
Scale	Drawing Number		Rev		
NO SCALE	07070-03		Sheet 3 of 3		