



**Washington State
Department of Transportation**

Local Agency Guidelines

M 36-63.38

June 2020

Local Programs
Engineering Services

Americans with Disabilities Act (ADA) Information: This material can be made available in an alternate format by emailing the Office of Equal Opportunity at wsdotada@wsdot.wa.gov or by calling toll free, 855-362-4ADA(4232). Persons who are deaf or hard of hearing may make a request by calling the Washington State Relay at 711.

Title VI Notice to Public: It is the Washington State Department of Transportation's (WSDOT) policy to assure that no person shall, on the grounds of race, color, national origin or sex, as provided by Title VI of the Civil Rights Act of 1964, be excluded from participation in, be denied the benefits of, or be otherwise discriminated against under any of its federally funded programs and activities. Any person who believes his/her Title VI protection has been violated, may file a complaint with WSDOT's Office of Equal Opportunity (OEO). For additional information regarding Title VI complaint procedures and/or information regarding our non-discrimination obligations, please contact OEO's Title VI Coordinator at 360-705-7090.

This manual provides local agencies with statewide policies and standards to follow when using Federal Highway Administration (FHWA) funds for transportation projects. Considerable effort has been made to provide guidance on how to accomplish the work under the current federal transportation act, Moving Ahead for Progress in the 21st Century (MAP-21). MAP-21 creates a streamlined and performance-based surface transportation program and builds on many of the highway, transit, bike, and pedestrian programs and polices established in 1991. Updating this manual is a continuing process. Questions, observations, and recommendations are invited. The [Comment Request Form](#) is provided to encourage comments. Please use it to transmit comments, including marked copies of manual pages, to WSDOT Local Programs.

Kathleen B. Davis
Director
Headquarters Local Programs

Comment Request Form

Date: _____

From: _____

Phone: _____

Email: _____

To: Director, Local Programs
Washington State Department of Transportation
Transportation Building
PO Box 47390
Olympia, WA 98504-7390

Subject: *Local Agency Guidelines* Comment

Recommendation for Improvement:

Chapter 11	Introduction	11-1
11.1	Purpose	11-1
11.2	Organization of the Manual	11-1
11.3	Updating Process	11-2
Chapter 12	FHWA Funding	12-1
12.1	General Discussion	12-1
12.2	Programming Projects	12-4
12.3	Coordination With Agencies	12-5
12.4	Statewide Transportation Improvement Program (STIP)	12-8
12.5	Funding Sources	12-10
12.6	FHWA Discretionary Programs	12-18
12.7	FHWA Fund Transfers to Another Federal Agency for Administration	12-19
12.8	Appendices	12-20
Appendix 12.81	MPO Planning Flowchart	12-21
Appendix 12.82	STP Lead Agencies	12-22
Chapter 13	Certification Acceptance Program	13-1
13.1	General Discussion	13-1
13.2	CA Features	13-2
13.3	CA Requirements	13-3
13.4	Application for CA	13-3
13.5	CA Compliance	13-4
13.6	Non-CA Status	13-4
13.7	Appendices	13-5
Appendix 13.71	Certification Acceptance Qualification Agreement	13-6
Appendix 13.72	Certification Acceptance Interview Form	13-8
Chapter 14	Developing Projects Using the Local Agency Guidelines	14-1
14.1	General Discussion	14-1
14.2	Project Development Process Overview	14-2
14.3	Projects Within Interstate Rights of Way	14-6
14.4	Project Development Process Flowchart and Checklist	14-7
14.5	Appendices	14-7
Appendix 14.51	Project Development Process Flowchart	14-8
Appendix 14.52	Project Development Checklist	14-9

Chapter 21 The Project Prospectus21-1

- 21.1 General Discussion 21-1
- 21.2 Procedure for Submitting the Planning Authorization Package..... 21-1
- 21.3 Procedure for Compiling the Project Authorization Package..... 21-1
- 21.4 Forms and Appendices 21-2
- 21.5 Forms..... 21-2
 - Appendix 21.41 Vacant..... 21-3
 - Appendix 21.42 Project Authorization Transmittal Items – Instructions..... 21-4
 - Appendix 21.43 Authorization Package Checklist 21-6
 - Appendix 21.44 Project Prospectus – Instructions..... 21-8
 - Appendix 21.45 County Code and WSDOT Region Numbers 21-13
 - Appendix 21.46 City Code Numbers..... 21-14
 - Appendix 21.47 Vacant..... 21-17
 - Appendix 21.48 Vacant..... 21-18
 - Appendix 21.49 Puget Sound Legislative Districts 21-19
 - Appendix 21.50 Vacant..... 21-20
 - Appendix 21.51 Washington State Congressional Districts 21-21
- Chapter 21 Forms Federal-Aid Prospectus Planning Scope of Work..... 21-22

Chapter 22 Local Agency Agreement 22-1

- 22.1 General Discussion 22-1
- 22.2 Preparation Procedure 22-2
- 22.3 Supplemental Agreement..... 22-2
- 22.4 Documented Cost Estimate..... 22-3
- 22.5 Forms and Appendices 22-3
 - Appendix 22.51 Documented Cost Estimates – Example 22-4
- Chapter 22 Forms Local Agency Agreement – Example 22-8

Chapter 23 Progress Billing (Reimbursement Costs) 23-1

- 23.1 General Discussion 23-1
- 23.2 Billing Procedures for Local Agency Ad and Award and Agency Force Work 23-1
- 23.3 Billing Procedures for State Ad and Award 23-3
- 23.4 Number and Timing of Submittals 23-3
- 23.5 Identification of Federal Aid Participating and Nonparticipating Charges 23-4
- 23.6 Billing Reviews 23-8
- 23.7 Forms and Appendices 23-8
 - Appendix 23.71 Vacant..... 23-9
 - Appendix 23.72 Local Programs Progress Billing – Instructions..... 23-10
 - Appendix 23.73 Inactive Justification Examples..... 23-13
 - Appendix 23.74 Certificate of Indirect Costs..... 23-14
 - Appendix 23.75 Vacant..... 23-15
 - Appendix 23.76 Local Programs Final Project Summary – Instructions 23-16
 - Appendix 23.77 Local Programs Quick Reference Travel Guide..... 23-17

Chapter 24	Environmental Processes	24-1
24.1	General Discussion	24-1
24.2	NEPA Classification	24-2
24.3	Early Project Coordination & Environmental Mitigation	24-7
24.4	Project Re-Evaluation	24-8
24.5	Supplemental Document	24-8
24.6	Other Federal Requirements	24-9
24.7	Tribal Consultation	24-9
24.8	Environmental Permitting	24-9
24.9	Appendices	24-9
24.10	NEPA Categorical Exclusions – A Guidebook for Local Agencies	24-9
24.11	Environmental Manual	24-9
24.12	Plain Talk Toolkit	24-9
24.13	Reader-Friendly Tool Kit	24-9
	Appendix 24.81 NEPA Categorical Exclusion Documentation Form	24-10
Chapter 25	Right of Way	25-1
25.1	General Discussion	25-1
25.2	Approval of Right of Way Acquisition Procedures	25-3
25.3	Preliminary ROW Activities	25-5
25.4	Right of Way Acquisition	25-6
25.5	Appraisal/Waiver Valuation – Administrative Offer Summary (AOS)	25-18
25.6	Appraisal Review	25-20
25.7	Agency Concurrence for Setting Just Compensation	25-22
25.8	Title	25-22
25.9	Negotiations	25-23
25.10	Donated Property	25-26
25.11	Administrative Settlements	25-27
25.12	Relocation	25-28
25.13	Right of Way Certification	25-29
25.14	ROW Certification vs URA Compliance	25-30
25.15	Property Management	25-32
25.16	Diaries	25-33
25.17	Oversight of Consultants Hired to Perform ROW Activities	25-35
25.18	ROW Training	25-35
25.19	Document Retention	25-36

25.20	Appendices	25-36
25.21	Local Programs Right of Way Services Website	25-36
	Appendix 25.170 Right of Way Plan Checklist	25-37
	Appendix 25.171 ROW Certification vs URA Compliance Case Studies	25-38
	Appendix 25.172 Sample Neighborhood Description	25-40
	Appendix 25.173 Vacant	25-41
	Appendix 25.174 Determining Whether Land or Property Rights or Interest are Needed	25-42
	Appendix 25.175 Determining the Type of Property Rights Necessary	25-43
	Appendix 25.176 No ROW Needed Verification Checklist	25-44
	Appendix 25.177 FHWA Early/Advanced Acquisition Options and Requirements Chart	25-45
	Appendix 25.178 Federal Aid Requirement Checklist	25-47
	Appendix 25.179 Acquisition Process Flowchart	25-49
	Appendix 25.180 LPA Certification Worksheet – Certificate 1 Sample	25-50
	Appendix 25.180a LPA Certificate 1 Worksheet – Instructions	25-51
	Appendix 25.181 LPA Certification Worksheet – Certificate 2 Sample	25-56
	Appendix 25.181a LPA Certificate 2 Worksheet – Instructions	25-57
	Appendix 25.182 LPA Certification Worksheet – Certificate 3 Sample	25-62
	Appendix 25.182a LPA Certificate 3 Worksheet – Instructions	25-63
Chapter 26	Disadvantaged Business Enterprises	26-1
26.1	General Discussion	26-1
26.2	Procedures	26-2
26.3	Contract Procedures	26-5
26.4	Consultant Agreement Procedures	26-10
26.5	Appendices	26-12
	Appendix 26.51 Vacant	26-13
	Appendix 26.52 Underutilized Disadvantaged Business Enterprise Utilization Certification	26-14
	Appendix 26.53 UDBE Written Confirmation Document	26-17
	Appendix 26.54 DBE On-Site Review for Construction Subcontractors/Regular Dealers/ Manufacturers	26-18
	Appendix 26.55 Project Office DBE On-Site Review for Architect & Engineering/ Professional Services Firms	26-21
	Appendix 26.56 Written Certification	26-23

Chapter 27	Equal Employment Opportunity and Training	27-1
27.1	General Discussion	27-1
27.2	Training	27-2
27.3	Contract Administration	27-3
27.4	Monitoring During Construction	27-4
27.5	Compliance Review	27-4
27.6	Forms	27-4
Chapter 28	Title VI Program	28-1
28.1	General Discussion	28-1
28.2	Title VI Plan Development	28-2
28.3	Reporting Requirements	28-3
28.4	Title VI Complaint Investigations	28-4
28.5	Title VI Compliance Reviews	28-5
28.6	Other Nondiscrimination Statutes Related to Title VI	28-5
28.7	Appendices	28-6
Appendix 28.71	Title VI Plan for Agencies Over 100,000 Population	28-7
Appendix 28.72	Nondiscrimination Agreement Population Under 100,000	28-28
Appendix 28.73	Annual Report for Agency With Population Over 100,000 – Example	28-39
Appendix 28.74	NDA Annual Report Population Under 100,000 – Example	28-56
Appendix 28.75	Title VI Complaint Log	28-58
Appendix 28.76	Title VI Compliance Review Questionnaire for Local Agencies	28-59
Appendix 28.77	USDOT Standard Title VI Assurances	28-62
Chapter 29	Section 504 and the Americans with Disabilities Act	29-1
29.1	General Discussion	29-1
29.2	Assurances	29-2
29.3	Administrative Requirements	29-2
29.4	Transition Plan, Program Access Plan, and Accessible Pedestrian Signal and Pushbutton Policy	29-3
29.5	Requirements for New Construction and Alterations in the Public Right of Way	29-4
29.6	Monitoring and Enforcement	29-6
29.7	Laws	29-7
29.8	Regulations	29-7
29.9	Resources	29-7
29.10	Appendices	29-7
Appendix 29.11	ADA Title II and Section 504 Regulatory References	29-8

Chapter 31	Using Consultants	31-1
31.7	Submittal of Consultant Contract Data	31-18
31.8	Oversight of the Agreement and Project Closure	31-18
31.9	Appendices	31-20
	Appendix 31.91 Advertisement – Example	31-21
	Appendix 31.92(a) Submittal Information Form (Prime)	31-23
	Appendix 31.92(b) Submittal Information Form (Subconsultant)	31-24
	Appendix 31.93 Request for Sole Source Consultant Services	31-26
	Appendix 31.94 Independent Estimate for Consulting Services	31-29
	Appendix 31.95 Record of Negotiations – Example	31-30
	Appendix 31.96 Performance Evaluation Consultant Services	31-31
	Appendix 31.97 Alleged Consultant Design Error Procedures	31-36
	Appendix 31.98 Consultant Claim Procedures	31-38
	Appendix 31.99 Consultant Draft scope and Independent Cost Estimate example	31-40
Chapter 32	Railroad/Highway Crossing Program	32-1
32.1	General Discussion	32-1
32.2	Selection of Appropriate Warning Devices	32-1
32.3	Project Development Process	32-4
32.4	Appendices	32-6
	Appendix 32.41 Signal Design – Shoulder Section	32-7
	Appendix 32.42 Signal Design – Curb Section	32-9
	Appendix 32.43 Railroad/Highway Grade Crossing Protection Sight Distance Diagram and Gate Warrant Form	32-11
	Appendix 32.44 Railroad Project Data Form	32-13
	Appendix 32.45 Type 3 Party Agreement – Example	32-14
	Appendix 32.46 Local Agency Railway Agreement	32-15
Chapter 33	Emergency Relief Program	33-1
33.1	Steps Following a Disaster	33-2
33.2	FHWA's Emergency Relief Program Guidelines	33-3
33.3	Reimbursable Expenses	33-5
33.4	Types of Emergency Relief Work	33-9
33.5	Contracts	33-12
33.6	Additional Project Requirements	33-13
33.7	Funding	33-14
33.8	FEMA Program Guidelines	33-14
33.9	Appendices	33-16
	Appendix 33.91 Local Agency Proclamation	33-17
	Appendix 33.92 Governor's Proclamation	33-18
	Appendix 33.93 Local Agency Detailed Damage Inspection Report	33-20
	Appendix 33.94 Emergency Work Contract	33-22

Chapter 34	Local Bridge Program	34-1
34.1	General Discussion	34-1
34.2	Bridge Condition Inspection Program	34-1
34.3	Quality Assurance and Quality Control Reviews	34-5
34.4	Local Bridge Program Call for Projects	34-6
34.5	Appendices	34-10
Appendix 34.51	NBIS Regulation – Qualifications of Personnel	34-11
Appendix 34.52	NBIS Regulation – Inspection Frequency	34-12
Appendix 34.53	Bridge Inspector Experience and Training Record	34-13
Appendix 34.54	Bridge Program Manager Agreement	34-14
Appendix 34.55	Bridge Records	34-16
Appendix 34.56	Individual Bridge Record	34-20
Appendix 34.57	Local Agency Bridge Program Quality Assurance Checklist	34-22
Chapter 41	General Project Types	41-1
41.1	General Discussion	41-1
41.2	Work Zone Safety and Mobility	41-2
41.3	Intelligent Transportation Systems (ITS)	41-2
41.4	Deviations	41-4
41.5	Appendices	41-5
Appendix 41.51	Deviation Analysis Format	41-6
Appendix 41.52	Systems Engineering Process “V” Diagram	41-7
Appendix 41.53	Intelligent Transportation Systems (ITS) Systems Engineering Analysis Worksheet	41-8
Appendix 41.54	FHWA Washington Division ITS Project Contracting Guidance September 2012	41-11
Chapter 42	City and County Design Standards for All Routes	42-1
42.1	Introduction	42-1
42.2	Committee Membership	42-2
42.3	Local Agency Design Matrices	42-3
42.4	Local Agency Design Matrix Definitions	42-4
42.5	Design Level D Standards for Two Way Roads and Streets	42-11
42.6	Roadway Geometrics	42-12
42.7	3R Projects	42-13
42.8	2R Projects	42-14
42.9	References	42-14
42.10	Appendices	42-16
Appendix 42.101	Local Agency Design Matrix Checklists	42-17

Chapter 43	Design Approval	43-1
43.1	General Discussion	43-1
43.2	Requirements for Design Approval	43-1
43.3	Bridge Design Approval	43-2
43.4	Value Engineering	43-2
43.5	Additional Data Required for Special Projects	43-4
43.6	Appendices	43-4
	Appendix 43.61 VE Assessment Report	43-5
	Appendix 43.62 Example of Design Approval Documentation	43-6
Chapter 44	Plans, Specifications, and Estimates	44-1
44.1	General Discussion	44-1
44.2	PS&E Requirements	44-2
44.3	Documents Requiring Professional Stamps	44-5
44.4	Contract Plans	44-5
44.5	Specifications	44-5
44.6	Estimates	44-8
44.7	Appendices	44-8
44.8	Forms	44-8
	Appendix 44.71 Local Agency Bid Proposal Package	44-9
	Appendix 44.72 City Letter of Financial Responsibility (for State Ad and Award Only) – Example	44-28
	Appendix 44.73 County Letter of Financial Responsibility (for State Ad and Award Only) – Example	44-29
	Appendix 44.74 Estimate and Grouping – Example	44-30
	Appendix 44.75 Local Agency Plans Preparation Checklist	44-38
	Appendix 44.76 Patented/Proprietary Items – PIF Instructions	44-43
	Appendix 44.77 Two-Week Advertisement – PIF Instructions	44-45
	Appendix 44.78 Mandatory Use of Borrow or Disposal Site – PIF Instructions	44-47
	Appendix 44.79 Agency Supplied Equipment – PIF Instructions	44-49
	Appendix 44.80 Agency Supplied Material – PIF Instructions	44-51
	Appendix 44.81 Local Agency Force Work– PIF Instructions	44-53
	Appendix 44.82 Tied Bids – PIF Instructions	44-57
	Appendix 44.83 Public Interest Finding – Example	44-59

Chapter 45	State Advertising and Award Procedures	45-1
45.1	General Discussion	45-1
45.2	Submittals	45-1
45.3	Procedures	45-1
Chapter 46	Local Advertising and Award Procedures	46-1
46.1	General Discussion	46-1
46.2	Procedures	46-2
46.3	Submittal of Award Data	46-6
46.4	Appendices	46-6
	Appendix 46.41 Advertisement – Example	46-7
	Appendix 46.42 Local Agency Funds – Award Letter Example	46-8
	Appendix 46.43 Voluntary Goal – Award Letter Example	46-9
	Appendix 46.44 Mandatory Goal – Award Letter Example	46-10
	Appendix 46.45 Contract Bond – Example	46-12
	Appendix 46.46 Vacant	46-14
Chapter 51	WSDOT Administered Projects	51-1
51.1	General Discussion	51-1
51.2	Preconstruction Conference	51-1
51.3	Changes and Extra Work	51-1
Chapter 52	Local Administered Projects	52-1
52.1	General Discussion	52-1
52.2	Preconstruction Conference	52-1
52.3	Quality Control	52-2
52.4	Progress Payments	52-6
52.5	Changes and Extra Work	52-7
52.6	Termination of Contract	52-8
52.7	Compliance With Federal Contract Provisions	52-8
52.8	Physical Completion of Construction	52-8
52.9	Projects within Interstate Rights of Way	52-10
52.10	Appendices	52-10
52.11	Forms	52-10
	Appendix 52.101 Preconstruction Conference Agenda – Example	52-11
	Appendix 52.102 Preconstruction Conference Minutes – Example	52-13
	Appendix 52.103 Letter Requesting WSDOT Project Inspection and Acceptance – Example	52-14
	Appendix 52.104 Materials Certification – Example	52-15
	Appendix 52.105 Weekly Statement of Working Days	52-16
	Appendix 52.106 Change Order	52-17
	Appendix 52.107 Exceptions to the WSDOT Construction Manual M 41-01	52-20

Chapter 53 Project Closure53-1

53.1 General Discussion 53-1

53.2 Closure 53-1

53.3 Project Reviews 53-2

53.4 Financial and Compliance Audit 53-3

53.5 Appendices 53-4

Appendix 53.51 Local Agency Project Management Review Checklist..... 53-5

Appendix 53.52 Final Inspection of Federal Aid Project 53-18

Appendix 53.53 Vacant 53-19

Appendix 53.54 Certified Payroll Example..... 53-20

Chapter 61 Local Agency Force Projects 61-1

61.1 General Discussion 61-1

61.2 PS&E Requirements 61-1

61.3 PS&E Approval..... 61-1

61.4 Approval for Use of Agency Forces..... 61-1

61.5 Fund Authorization 61-2

61.6 Contract Number..... 61-2

61.7 Construction Administration 61-2

61.8 Project By One Agency for Another Agency 61-4

61.9 Appendices 61-4

Appendix 61.91 Local Agency Force Preconstruction Conference – Example..... 61-5

List of Forms 1

Abbreviations and Glossary..... 1

11.1 Purpose

The *Local Agency Guidelines* is intended to help Washington's public agencies plan, design, construct, and maintain transportation facilities. To assist agencies in accomplishing these goals, the manual describes the processes, documents, and approvals necessary to obtain Federal Highway Administration (FHWA) funds to develop local transportation projects and defray their costs.

The manual is a compilation of information from many sources and is a reference source for administrative and field personnel in any governmental agency. To serve the needs of local agencies, the manual describes development requirements and outlines procedures for obtaining approval when local conditions warrant departures from adopted standards.

Local Programs is the division within the Washington State Department of Transportation (WSDOT) which serves local agencies. The Regional Local Programs Engineer, the local agency's contact person within WSDOT, is always available to assist local officials with answers to their questions about the manual.

11.2 Organization of the Manual

Using the glossary and the cross-references, readers should be able to find answers to most questions regarding procedural requirements for FHWA assisted transportation projects. The manual is organized to reflect the flow of a project through the major phases of development and to incorporate the differing developmental needs of different projects.

The manual is divided into six parts. Each part contains one or more chapters which describe the requirements for completing specific project development activities:

Chapters 11–14, *Guidelines Overview*, discuss:

- Describe the purpose and objective of this manual.
- Provide a list of acronyms and a list of FHWA funding programs for local projects.
- Explain the process for becoming certified to administer FHWA projects.
- Describe the procedure for coordinating local transportation programs with areawide planning agencies.
- Provide an overview of the project development process.

Chapters 11–14, *Appendices*, include:

- A flowchart summarizing major activities required to develop a transportation project.
- A checklist of required approvals.
- A checklist of tasks necessary to complete various project phases.

Chapters 21–28, General Project Development Processes, describe procedures which apply to all FHWA assisted transportation projects.

Chapters 31–34, Special Project Development, describe procedures essential to some types of projects but not needed on all projects.

Chapters 41–46, Design, describe design standards for obtaining design phase approvals which must be incorporated into local projects, preparation of contract documents, and contracting for construction. Some of the chapters will apply, depending on whether a project is to be administered by WSDOT or the local agency.

Chapters 51–53, Construction and Post-Construction, describe procedures for administering the project construction phase, describe procedures for closing out FHWA projects. Procedures for state and local construction administration are discussed in separate chapters.

Chapter 61, Local Agency Force Projects, describes procedures from project design approval through the closing of an FHWA project, using the agency's labor, equipment, and materials.

In each chapter, there is a general discussion section which gives background information, policy, and the rationale for the requirements. This is followed by a detailed description of requirements (procedures, documents, and approvals). In most cases, general discussion appears at the beginning of each chapter, while details of the process appear later in the chapters. Backup data, checklists, sample letters, and instructions for completing forms appear in appendices to each chapter.

11.3 Updating Process

Since FHWA funding programs and eligibility requirements frequently change, this manual is updated in April every year. If there are changes that need to be made immediately, the HQ Local Programs Office will issue a letter to all manual holders and CA Agencies. Agencies are encouraged visit the Local Programs website and sign up to receive emails notifications of updates.

Comments and suggestions for improvement of the manual are most welcome. They should be directed to the Region Local Programs Engineer, who will forward them to the WSDOT Local Programs Division where they will be considered in the next revision.

12.1 General Discussion

This chapter describes the distribution of Federal Highway Administration (FHWA) funds administered by the Washington State Department of Transportation's (WSDOT) Headquarters Local Programs, and presents the basic procedures for local agency participation.

FHWA funds may be used to reimburse project costs for general transportation planning, preliminary engineering, right of way acquisition, construction, and audits. FHWA funds may be expended only after WSDOT notifies the agency of federal authorization. FHWA funds are not eligible for lobbying efforts ([2 CFR Part 200.450](#)).

To use donated lands as part of the agencies' match to the project under certain conditions, see [Section 25.10](#), for details.

.11 FHWA Eligible Roadways – Under Fixing America's Surface Transportation Act (FAST), in order for projects to be eligible for FHWA funds, roadways must be functionally classified routes.

Specific programs require that in order to be eligible, the roadway must be identified as part of the National Highway System (NHS), or the Interstate System, which is a component of the NHS. The NHS provides an interconnected system of principal arterials and other highways serving major population centers, international border crossings, ports, airports, public and intermodal transportation facilities, and other major travel destinations to meet national defense needs and to serve interstate and interregional travel.

Routes included on the NHS are principal arterials, interstate highways, highways on the Strategic Highway Network (STRAHNET), major STRAHNET connectors, and congressional high priority routes.

Non-NHS routes include all other functionally classified routes (except rural minor collector and local access). The Act allows up to 15 percent of Surface Transportation Block Grant (STBG) rural dollars to be used on rural minor collectors.

.12 Federal-Aid Highway Program (FAHP) – This is an “umbrella” term that encompasses most of the federal programs providing highway funds to the states. The passage of the Fixing America's Surface Transportation Act (FAST Act) provides funds for transportation projects from the following federal programs (see [Section 12.5](#)):

- National Highway Performance Program (NHPP)
- Surface Transportation Block Grant (STBG)
- Congestion Mitigation and Air Quality (CMAQ)
- Highway Safety Improvement Program (HSIP)
- National Highway Freight Program (NHFP)
- Transportation Alternatives (Previously Transportation Alternatives Program) (TA)
- Ferry Boat Program (FBP)
- Emergency Relief Program (ER)

Washington has a unique approach to splitting federal highway funds between state and local government. There is a requirement to sub-allocate about half of the Surface Transportation Block Grant (STBG) funding to local entities based on population, and there is also metropolitan planning money for local organizations. Due to our state's history of collaboration and open discussion, the State provides more money to local governments than required by federal law. Since the Intermodal Surface Transportation Act (ISTEA) in 1991, Washington State has engaged in a discussion about how to split the Federal-Aid Highway Funds between WSDOT and local jurisdictions.

Historically, the funds have been distributed on a percentage basis. In general, the overall state/local distribution is an accumulation of the distribution of the individual Federal-Aid Highway Programs (FAHP). Where applicable, the distribution of each of the federal program areas is based on a data-driven approach, while also considering ownership and whether the program benefits the state or local system.

Federal Aid Highway Program (FAHP) Overview

The FAHP encompasses most of the federal programs providing highway funds to the states and is administered by the FHWA. The program is primarily funded from revenues collected by the United States Treasury from certain federal taxes on gasoline, tire sales, and other items, which taxes are deposited into the federal Highway Trust Fund.

The FHWA is the federal agency within the USDOT responsible for administering the FAHP, which is a reimbursement program. Washington is responsible for the operation and maintenance of federal-aid highways in the state.

Once projects are approved by FHWA and funds are obligated, the federal government makes payments for costs as they are incurred on projects. With few exceptions, the federal government does not pay for the entire cost of a federal-aid project. Federal reimbursements are typically required to be matched with non-federal funding sources (state and/or local funds). The maximum federal share is specified in the federal legislation authorizing the program. In Washington, the typical federal share has been adjusted to 86.5 percent to account for the amount of federal land in Washington.

1. Funding under the FAHP is provided through a multi-step funding cycle that includes: Authorization by Congress of the funding for various highway programs, typically on a multi-year basis (e.g., FAST Act, MAP-21, SAFETEA-LU, etc.). The authorization act defines the programs and establishes maximum funding levels. When an authorizing act establishes a program, it sets rules for the amount of funds available in a Federal Fiscal Year (FFY), a description of how the funds are to be distributed, the length of time during which the funds may be used, and a list of eligible activities. Through "contract authority," authorized amounts become available for obligation according to the provisions of the authorization act without further legislative action. By definition, contract authority is unfunded and a subsequent appropriations act is necessary to pay the obligations under contract authority.

2. **Apportionment and Allocation** – the authorization act sets the distribution of contract authority to be apportioned and/or allocated to the states. The authorized amount for a given FFY is distributed to the states through apportionments and allocations.
 - **Apportionments** – The distribution of funds using a formula provided in law is called an apportionment. Each FFY, the FHWA is responsible for apportioning authorized funding for the various highway programs among the states according to formulas established in statute. In general, apportionments are available for three years plus the year that they are apportioned. It is the practice in Washington to use the oldest apportionment available when obligating funds. This approach prevents the lapsing of apportionment.
 - **Allocations** – Some FHWA funding categories do not have a legislatively-mandated distribution formula, the distributions of funds are termed “allocations,” which may be made at any time during the FFY. In most cases, allocated funds are divided among states with qualifying projects applying general administrative criteria provided in the law, such as Ferry Boat Program.
3. **Obligation** – the federal government’s commitment to reimburse for the federal share of an approved project’s eligible costs. This commitment occurs when the project is approved and the project agreement is executed. FHWA distributes Obligation Authority to states proportionately based on each state’s share of apportioned and allocated revenues. The actual ratio of Obligation Authority to apportionment and allocations may vary from state to state, since some federal-aid programs are exempt from the obligation limitation. A state’s Obligation Authority (unlike its apportionments and allocations of authorized funding) must be obligated before the end of the FFY for which it is made available; if not, it will be redistributed to other states to help ensure that the total limitation nation-wide will be used.
4. **Appropriations** – Congress specifies the amount of funds available for the year to liquidate obligations as a means of balancing the annual level of highway spending with other federal budget priorities. The Obligation Limitation is the amount of authorized funding that Congress allows states to obligate in an individual year. This is a statutory budgetary control that does not affect the apportionment or allocation of funds. Rather, it controls the rate at which the funds can be used, and, in effect, can limit the amount of funds that can be used. WSDOT has been successful in obligating its full amount of Obligation Authority and the additional Obligation Authority made available to the state through the annual process of redistributing federal funds from those states and programs that are unable to utilize all of their obligation authority.
5. **Program Implementation** – covers the programming and authorization. In order to receive federal reimbursements for transportation projects, states are required to develop long-range transportation plans that are based on projections of state and federal funding. Projects are not eligible for federal reimbursements unless they are either directly identified or consistent with a long-range plan and included in the Statewide Transportation Improvement Program (“STIP”). The STIP requires FHWA and FTA approval.
 - **Traditional Approach.** WSDOT requests FHWA approval of the use of federal funding by phase (PE, RW, CN) for the appropriate federal share of the project. The project must be in the STIP and identifying the category and amount of federal funding. FHWA evaluates and verifies the project is eligible for

federal funding and meets a variety of federal requirements. Provided that all requirements are satisfied, FHWA authorizes federal participation in the project and obligates the federal share of project costs. (Additional requirements are outlined in subsequent chapters).

- Advance Construction (AC) Approach. WSDOT requests FHWA approval of AC to authorize a project in advance of the apportionment of federal-aid funds. Under AC, FHWA is asked to authorize the project without obligating federal funds. A state/local agency will provide the up-front financing for the project and then at a later date “convert” the AC project to a regular federal-aid project and obligate the full federal share of the project costs when sufficient Obligation Authority is available. At the time of conversion, state/local agency requests reimbursement for the federal share of costs incurred to date.
6. **Reimbursement** – The FAHP is a reimbursement program. As work progresses on a federal-aid project, WSDOT/local agency incur costs for the completed work and can pay for those costs from available state/local funds and/or request reimbursement. The state/local agency electronically transmits vouchers for the federal share of completed work and certifies the claims to FHWA/WSDOT for review and approval monthly. (see [Chapter 23](#))

12.2 Programming Projects

.21 Planning Requirements – The Federal Transportation Act requires a continuous, cooperative and comprehensive (3C) performance-based statewide and metropolitan multimodal transportation planning process. This process involves:

- Metropolitan Planning Organization (MPO) long-range transportation plans.
- MPO transportation improvement programs (MTIPs).
- A statewide long-range transportation plan.
- A Statewide Transportation Improvement Program (STIP).

The statewide planning process carries out a 3C performance-based multimodal transportation approach for making transportation investment decisions to support the national goals throughout the state. The process for developing the statewide plan and transportation improvement program shall include metropolitan and non-metropolitan local officials with responsibility for transportation, including transit operators, tribal nations, and federal land management agencies. At the state and federal levels, policies and procedures are established to provide for statewide coordination of transportation programs.

.22 Local Agency Transportation Programs – The local agency transportation program is a listing of prioritized projects that a local agency expects to begin during the next six years. Projects in the local agency transportation program are all FHWA, Federal Transit Administration (FTA), regionally significant projects regardless of funding source and other state or locally funded projects. All cities, towns, counties, tribal nations, and transit agencies are required to prepare and adopt their individual transportation programs annually.

- Cities and towns are required to prepare and adopt a six-year Transportation Program by June 30 annually and file a copy with the Secretary of Transportation not more than 30 days after adoption ([RCW 35.77.010](#)).

- Counties are required to prepare and adopt a six-year transportation program by December 31 annually and file copies with the County Road Administration Board (CRAB) and the Secretary of Transportation not more than 30 days after adoption ([RCW 36.81.121](#)).
- Tribal Nations are required to prepare a Tribal Transportation Improvement Program (TTIP) and forward it to the Bureau of Indian Affairs (BIA). ([25 CFR 170.400](#)).
- Transit agencies are required to prepare a six-year transit development plan by September 1st of each year and file a copy with WSDOT, the Transportation Improvement Board, cities, counties, and regional planning councils where the transit agency is located ([RCW 35.58.2795](#)).
- WSDOT prepares a 6-year project delivery plan based on identified system deficiencies and priorities by July 1 annually and makes the plan available for use in consulting with communities, metropolitan and non-metropolitan local officials.

Once the agency's transportation programs are adopted, federally funded and regionally significant projects are submitted to MPOs for inclusion in the Regional TIP. County lead agencies and rural cities can submit directly to WSDOT or the RTPo for inclusion in the STIP based on an agreed upon process.

WSDOT developed a web-based system for agencies to prepare their six-year transportation programs and submit them electronically. For additional information on the system, go to www.wsdot.wa.gov/localprograms/programmgmt/stip.htm.

12.3 Coordination With Agencies

.31 Metropolitan Planning Organizations (MPO) – An MPO is the policy board designated to carry out the metropolitan transportation planning process for an urbanized area with 50,000 or more population as designated by the Bureau of the Census. ([23 USC 134\(d\)](#) and [23 CFR Part 450](#)).

MPOs with populations over 200,000 are designated as Transportation Management Areas (TMAs). Some responsibilities of the TMA/MPO are:

- Carry out a 3C performance-based multimodal transportation planning process for decision making to support national performance goals.
- Prepare a 20-year metropolitan transportation plan (MTP) that is financially constrained and serves as a basis for the selection of projects in the MTIP.
- Develop programmatic mitigation plans to address the potential environmental impacts of future transportation projects.
- Develop a congestion management process, typically called a CMP.
- Develop criteria that relate to regional priorities, establish application procedures, project selection, inform local agency of selection, and monitor to ensure delivery of regional STP, CMAQ, and TAP funds that correlates with the MTP. Federal funds cannot be sub-allocated to individual jurisdictions or modes based on a predetermined percentage or formula ([23 CFR 450.326\(m\)](#)).
- Develop a four-year MTIP, which:
 - Is required to be updated at least once every four years and approved by the MPO and Governor or Governor's designee.
 - Contains projects consistent with the current metropolitan transportation plan.
 - Includes a list of prioritized projects for four years.

- Follows a documented public participation plan that provides reasonable opportunities for involvement in the metropolitan transportation planning process by interested parties.
 - Includes a financial plan for implementing the projects that is also consistent with reasonable expectation of available funding.
 - Includes sufficient descriptive project descriptions (such as type of work, termini, length, and other similar factors) to identify the project or phase of the project.
 - Contains projects being funded by Title 23, FHWA, or Title 49, FTA funding.
 - Estimates the total cost of the project (all phases, all funding sources).
 - Contains the amount of federal, state, and local funds to be obligated during each program year.
 - Contains regionally significant projects funded with federal funds other than those administered by FHWA or FTA and projects funded with non-federal funds.
 - Contains a project or identified phase of a project, only if full funding can reasonably be anticipated to be available for the project or phase within the time period contemplated for completion of the project or the identified phase (see STIP Appendix C).
 - Includes performance target achievement. The MTIP shall include, to the maximum extent practicable, a description of the anticipated effect of the TIP toward achieving the performance targets established in the metropolitan transportation plan, linking investment priorities to those performance targets.
- Each year, include a listing of obligated projects (including investments in pedestrian walkways and bicycle transportation facilities). The listing shall be published by March 30 of each year, identifying the Title 23 and/or Title 49, FHWA funds, and FTA funds that were obligated in the preceding calendar year. For each federally funded project, the listing shall include:
 - All federal funded projects authorized or revised to increase obligations in the previous calendar year.
 - The agency responsible for carrying out the project or phase.
 - Sufficient project descriptions (such as type of work, termini, length, and other similar factors) to identify the project or phase of the project.
 - The amount of federal funds requested in the TIP.
 - The federal funding obligated during the previous calendar year.
 - The federal funding remaining for subsequent years.
 - After the MPO TIP is approved, it is submitted to WSDOT through the web-based system for inclusion in the STIP.

.32 Regional Transportation Planning Organizations (RTPO) – As part of the Growth Management Act (GMA), the state legislature authorized the creation of RTPOs ([RCW 47.80](#)). RTPOs are voluntary organizations composed of local governments within a county, or within geographically contiguous counties, whose purpose is to coordinate transportation planning on a regional basis and to develop a regional transportation plan as applicable. Some RTPO responsibilities may include:

- Establish a cooperative planning process with public involvement.
- Provide a forum for state and local agencies to coordinate their planning.
- Certify that local plans are consistent with the GMA and the regional plan.

- Prepare a regional transportation plan that identifies regionally important transportation facilities, outline a strategy and approach for the region to guide system development and a financing plan.
- Develop a six-year RTIP which is required to be updated at least once every two years and includes a prioritized list of regional projects drawn from state, transit, tribal, city, and county transportation programs and how the program of projects will be financed.
- Develop criteria that relates to regional priorities, establish application procedures, project selection, inform local agency of selection, and monitor to ensure delivery of regional TAP funds. Federal funds cannot be sub-allocated to individual jurisdictions or modes based on a predetermined percentage or formula (23 CFR 450.324).

After the RTPO TIP is approved, it is submitted to WSDOT through the web-based system. Only the first four years of the RTPO TIP, County Lead agency and rural city transportation programs are included in the STIP.

A list of MPOs and RTPOs is at:

www.wsdot.wa.gov/nr/rdonlyres/91717186-9193-4054-807d-3b229d016fe8/0/mportpowsdotdirectory021113.pdf

A map of MPOs and RTPOs is at:

www.wsdot.wa.gov/nr/rdonlyres/cf5ead4f-f9c9-46f9-b97a-f0e7945f2254/0/mportpomapforweb.pdf

.33 County Lead Agencies – County lead agencies are responsible for developing a county-wide approach to select priority transportation projects in their respective boundaries. Transportation needs of the rural counties are often much different than the needs of metropolitan areas. Rural counties frequently partner with the smaller local jurisdictions to meet the broader needs of the county-wide transportation system. Responsibilities of county-lead agencies include:

- Develop criteria that relate to county-wide priorities, establish application procedures, project selection, inform local agencies of selection and monitor to ensure delivery of Surface Transportation Program (STP) funds. Federal funds cannot be sub-allocated to individual jurisdictions or modes based on a predetermined percentage or formula (23 CFR 450.326(m)).
- Include non-metropolitan local officials with responsibility for transportation, including tribal nations and provide for consideration of all modes of transportation.
- Public involvement through the respective agency's six-year program hearings and selection processes.

After projects are prioritized, selected, and approved through the county-wide process, the projects are programmed in the respective lead agency's transportation program. Upon adoption of the agency's transportation program, it is submitted for inclusion in the STIP. Each county lead agency works with its jurisdictions to ensure process for inclusion in the STIP.

.34 Local Agencies Outside MPOs – Local agencies outside MPOs are required to comply with the state six-year programming laws as well as federal law under the Federal Transportation Act, 23 USC, and 49 USC for any project they wish to finance with federal funds. Public involvement includes the six-year program hearings and the public comment processes for the local agency.

12.4 Statewide Transportation Improvement Program (STIP)

The Federal Transportation Act requires that each state develop a STIP as a condition to authorize federal funds for transportation projects. The STIP is a four-year prioritized program of transportation projects, compiled from rural transportation programs, RTIPs and MTIPs that have been found consistent with Regional and Metropolitan Transportation Plans along with the Washington Transportation Plan (WTP). The STIP includes projects such as pavement overlays, roadway widening, bridge replacement or repair, signal systems, safety enhancements, bicycle and pedestrian facilities, and transit or other multimodal improvements. Projects included in the STIP are funded by a combination of federal, state, and local sources. Federally funded aid projects must be included in the STIP before FHWA or FTA can authorize the expenditure of federal funds. Once projects are approved in the STIP, agencies may request project authorization with federal funds.

The STIP is developed annually beginning in October. A draft STIP is available for public review and comment in November on WSDOT's website. WSDOT submits the final STIP to FHWA and FTA, which is approved in January. The STIP is available on WSDOT's STIP web page that includes a searchable database. Monthly STIP amendments are submitted to FHWA/FTA for approval and are available for public review and comment on WSDOT's website concurrently for 10 calendar days.

The STIP includes:

- All TMA transportation improvement programs without change.
- All MPO transportation improvement programs without change.
- The first four years of all RTPO transportation improvement programs.
- The first four years of rural transportation programs for agencies not in an RTPO.
- Involvement of:
 - Local Agencies
 - Regional Transportation Planning Organizations
 - Transportation Management Areas
 - Metropolitan Planning Organizations
 - WSDOT
 - Transit Agencies
 - Tribal Nations
 - The Governor's Office

The basic required elements of the STIP are:

- All proposed highway and transit projects in the state funded under Title 23 and Title 49 USC, including federal lands projects.
- Consistent with the statewide transportation plan.
- In areas that are in a non-attainment status under the Clean Air Act for carbon monoxide, ozone, particular matter less than 10 microns in diameter (PM₁₀), or PM_{2.5}, include projects that conform with the State Implementation Plan (SIP).
- Consistent with expected available funding.
- Identify projects and selection priorities developed with appropriate consultation and coordination with local jurisdictions, metropolitan planning organizations, and federal lands agencies.
- Include regionally significant projects funded with federal funds other than those administered by FHWA or FTA, and projects funded with non-federal funds.
- Meet the requirements of 23 USC 135(e), Statewide Planning, coordination with local jurisdictions, and approved by FHWA and FTA.
- Include a project or identified phase of a project, only if full funding can reasonably be anticipated to be available for the project or phase within the time period contemplated for completion of the project or the identified phase.

The STIP shall include for each project or phase:

- Project descriptions (such as type of work, termini, length, and other similar factors) to identify the project or phase of the project.
- An estimate of the total project cost (all phases, all funding sources).
- The amount of federal, state, and local funds proposed to be obligated during each program year.
- Complete funding for the phase identified (all funding sources).

WSDOT is primarily responsible for implementing the Washington State STIP. This cannot be accomplished without recognizing the requirements of all transportation providers in developing their various transportation programs. Agencies within an MPO must submit projects to the MPO, who will then submit the projects to WSDOT for inclusion in the STIP. Agencies within a RTPO and/or County lead agency verify with the applicable agency the process regarding project submittals for inclusion in the STIP.

The following schedule shows the processes and responsibilities required by state and federal law to develop Washington's STIP. Many of the events on the schedule interact with others and require cooperation and communication among government agencies. The schedule is crucial to managing transportation funding. Agencies must plan adequate time for discussion and analysis and public involvement, as well as time to submit information for review.

Annual STIP Timeline	
Deadline	Description
June 30	Cities' and towns' six-year transportation programs are adopted.
July	Agencies and WSDOT submit projects for inclusion in the STIP to MPOs and RTPOs, as applicable.
July 31	Adopted transportation programs are due to WSDOT.
August/September	MPOs assemble regional TIPs and prepare analysis for conformity finding (as applicable).
August	WSDOT reviews draft MPO TIPs. As requested, WSDOT reviews draft RTPO TIPs, County Lead and city transportation programs.
September 1	Transit agencies six year plans are due.
September/October	WSDOT, FHWA and FTA review MTIPs for air quality conformity.
October	All MPO and RTPO TIPs are due to WSDOT when the October amendment is due.
November	WSDOT approves MPO TIPs. FHWA and FTA issue Regional Air Quality Conformity finding. WSDOT makes the draft STIP available for public review.
December	WSDOT submits the STIP to FHWA and FTA for approval.
December	Counties adopt annual budgets and six-year programs.
January	FHWA and FTA approve the STIP.

The STIP is amended each month through October. The STIP amendment schedule is available at www.wsdot.wa.gov/localprograms/programmngmt/stip.htm.

12.5 Funding Sources

The federal aid highway funding is administered through WSDOT, which is responsible for ensuring that federal and state requirements and procedures are followed. This responsibility is further documented in the FHWA and WSDOT Stewardship and Oversight agreement ([Chapter 13](#)). Once a project is selected to receive federal aid highway funding, the project *must* be developed in accordance with the federal requirements and procedures that apply to federal aid highway projects. All FHWA funded programs are reimbursement programs for financing transportation projects.

FHWA provides apportionment, allocations and obligation authority to each state. Distribution between WSDOT and locals is based upon the Governor's advisory group recommendation. MPOs, RTPOs and county lead agencies are notified accordingly of the annual funding available and the expectation that they deliver their proportionate share to ensure that FHWA funds are maximized. For additional details: www.wsdot.wa.gov/LocalPrograms/ProgramMgmt/funding.htm

.51 Surface Transportation Block Grant Program (formerly the Surface Transportation Program (STP)) – The STBG program provides flexible funding that may be used by WSDOT and local agencies for projects to preserve and improve the conditions and performance on any federal aid highway, bridge and tunnel projects on any public road, pedestrian and bicycle infrastructure, and transit capital projects, including intercity bus terminals.

For details on all eligible activities and additional details, go to www.fhwa.dot.gov/fastact

Agencies are expected to consider the relative importance of the route, roadway condition, and traffic impact on NHS routes as they prepare their six-year programs for their roadway systems. The local agencies and the responsible selection agencies will ensure their respective NHS routes are given priority in their programming process.

STBG Funding

- A portion of the STBG funding is suballocated to MPOs, RTPOs, and county lead agencies based on 2010 census population. The FAST Act requires the sub-allocated amount based on population to grow over the period of the Act (51% in FY 2016; 52% in FY 2017; 53% in FY 2018; 54% in FY 2019; 55% in FY 2020). The suballocated amounts are distributed as follows:
 - **Urbanized areas greater than 200,000** – Project selections are made by the MPOs in consultation with the State. These funds may be used anywhere within the planning area boundary of the MPO.
 - **Areas greater than 5,000 but no more than 200,000** – Funds are allocated to MPOs and county lead agencies and can only be used in areas encompassed by adjusted urban or urbanized area boundaries. Need to ensure that these funds are not used in any rural areas, regardless of whether they may be within an MPO's planning area.
 - **Areas with population of 5,000 or less (distributed based on rural lane miles)** – Funds are allocated to MPOs and county lead agencies and may be used anywhere that is outside of an adjusted urban or urbanized area boundaries. These funds can be used in rural areas including those encompassed by an MPO's planning area. Annually statewide, there is the ability for localities to utilize up to 15 percent of the amount reserved for rural areas for rural minor collector improvements.
- The remaining STBG is available for use in any area of the state and distribution is left to the discretion of the state. Local agencies are provided a proportion of these funds in their annual allocation that are distributed to all based on 75% total population/25% total county lane miles. Local Programs administration costs is taken off after initial allocations based on proportional share of the total allocation for each MPO and county lead agency.
- Two separate set-asides are included in the STBG funding:
 - Transportation Alternatives (described below)
 - Off-system bridges – this funding is combined with NHPP funding to total approximately \$45 million/annually for replacement, rehabilitation and preventative maintenance of local agency bridge on and off the federal aid system. (see [Chapter 34](#) or go to: www.wsdot.wa.gov/LocalPrograms/Bridge/Funding.htm)

The federal participation rate for STBG is 86.5 percent.

For details on all eligible activities go to: www.fhwa.dot.gov/fastact

.52 National Highway Performance Program (NHPP) – The NHPP program provides funding for the condition and performance of the National Highway System (NHS), for the construction of new facilities on the NHS, and to ensure that investments of Federal-aid funds in highway construction are directed to support progress toward the achievement of performance targets established in the State's asset management plan for the NHS. The NHPP program provides funding that may be used by WSDOT and local agencies for projects including: construction, reconstruction, resurfacing,

restoration, rehabilitation, and preservation of highways and bridges, including bridges on a non-NHS Federal-aid highway (if Interstate System and NHS Bridge Condition provision requirements are satisfied); bridge and tunnel inspection and evaluation, as well as training bridge and tunnel inspectors; transit capital; environmental restoration and mitigation; safety; construction, rehabilitation, or replacement of ferry boats and facilities; Intelligent Transportation Systems (ITS); and bicycle and pedestrian infrastructure.

FAST continues the focus on performance, accountability and performance targets nationally. This requirement has states develop a risk-based asset management plan for the NHS. To meet these requirements WSDOT utilizes the majority of the funding for preservation and improvements on state owned NHS facilities. In addition, locally owned NHS facilities are eligible to compete through the following statewide programs.

The statewide NHS Asset Management program. The objective of the program is to highlight the importance of preserving the roadway system by incentivizing agencies to use asset management strategies that provide cost-effective solutions to maximize the life expectancy of a NHS roadway. www.wsdot.wa.gov/LocalPrograms/ProgramMgmt/NationalHighwaySystem.htm

Also, approximately 6 percent of the NHPP program for local entities is dedicated to fund a portion of a statewide local agency competitive bridge program. (see [Chapter 34](#) or go to: www.wsdot.wa.gov/LocalPrograms/Bridge/Funding.htm)

For information on the designated local NHS routes, go to: www.fhwa.dot.gov/planning/national_highway_system/nhs_maps/section1122.cfm

For details on NHPP and eligible activities, go to: www.fhwa.dot.gov/fastact/factsheets/nhppfs.cfm
www.fhwa.dot.gov/specialfunding/nhpp/160309.cfm

.53 Highway Safety Improvement Program (HSIP) – The HSIP continues in the FAST Act to achieve a significant reduction in traffic fatalities and serious injuries on all public roads, including non-state owned public roads and roads on tribal lands. The HSIP requires a data-driven, strategic approach to improving highway safety on all public roads that focuses on performance.

- **Strategic Highway Safety Plan** – The safety program requires each state to develop and implement a strategic highway safety plan that is approved by the Governor. Washington State’s plan is called Target Zero. Target Zero identifies safety problems and includes strategies to improve them. As part of the plan, the state is required to develop an evaluation process to assess results and use the information for future improvements.

The two priority areas of Target Zero are run-off-the-road and intersection crashes. The numbers of serious and fatal crashes are used to develop a program split which equals 30% to WSDOT programs and 70% to local agencies, primarily cities and counties. The local responsibility includes crashes on city streets designated as state highways in cities that exceed 25,000 population. The program includes set-asides for High-Risk Rural Roadways (HRRR) and the Railway-Highway Crossing Program. Also, approximately \$2 million/biennium is provided for the Safe Routes to School (SRTS) program.

- **Local Safety Programs** – Safety projects selected must be consistent with the strategic highway safety plan. WSDOT has three programs to assist local agencies to address safety:
 - a. **City Safety Program** – The goal of the program is to fund the design/ preliminary engineering, right of way, and construction phases of projects that will reduce fatal and serious injury collisions on city streets in cities of any population and state highways that serve as arterials within cities with a population above 25,000. Projects are identified through a local road safety plan through utilization of crash data to address spot location improvements such as: specific intersections, compact roundabouts, mid-block locations or corridors, as applicable, or a systemic low cost, widespread, risk based approach throughout a city or over wide areas within a city.
 - b. **County Safety Program** – The goal of the program is to fund the design/ preliminary engineering, right of way, and construction phases of projects that will reduce run-off-road and intersection-related fatal and serious injury collisions on county roads. Projects are identified through a local road safety plan through utilization of crash data to identify and prioritize systemic low cost, widespread, risk based approach such as: high friction surface treatments, increase operations or visibility of traffic signals and/or signs, intersection conflict warning systems or specific intersections improvements including roundabouts, as applicable.
 - c) The Railway-Highway Crossing program provides funding for safety improvements to reduce the number of fatalities, injuries, and crashes at public grade crossings. The program must use at least 50% of these funds to install or upgrade protective devices at railroad crossings. Examples include gates, pedestrian crossings, signal systems, and signing. Funds may also be used to eliminate grade crossings by closing them or providing grade separation.

All projects funded through this program are required to report on subsequent crash data to FHWA for those years after completion of the project.

The federal participation rate for HSIP is 90 percent.

The FAST Act, established five safety performance measures for State Departments of Transportation (DOTs) to establish targets and report on annually. Targets are established based on the five-year rolling averages for: (1) Number of fatalities, (2) Rate of fatalities per 100 million VMT (vehicle miles traveled), (3) Number of serious injuries, (4) Rate of serious injuries per 100 million VMT, and (5) Number of non-motorized fatalities and non-motorized serious injuries. States are required to report annually and meet 4 of the 5 focus area targets to maintain compliance.

For details on all eligible activities, go to www.fhwa.dot.gov/fastact/guidance.cfm

.54 Transportation Alternatives – The FAST Act replaced the Transportation Alternative Program (TAP) with a set-aside of Surface Transportation Block Grant (STBG) program funding for transportation alternatives (TA). These set-aside funds include all projects and activities previously eligible under TAP, encompassing a variety of smaller-scale transportation projects, such as on-and off-road trail facilities, pedestrian and bicycle facilities, infrastructure projects for improving non-driver access to public transportation and enhanced mobility, community improvement activities, environmental mitigation, and safe routes to school projects.

Suballocation of TA

- 50 percent of TA funding is suballocated to MPOs, RTPOs, and county lead agencies based on 2010 census population as follows:
 - Urbanized areas greater than 200,000.
 - Areas greater than 5,000 but no more than 200,000.
 - Areas with population of 5,000 or less.
- The remaining 50 percent is available for use in any area of the state and distribution is left to the discretion of the state. At this time, approximately \$4 million/biennium is dedicated to the statewide Safe Routes to School program and the remaining is provided to the RTPOs.

WSDOT and MPOs are not eligible project sponsors for TA funds. However, State DOTs and MPOs may partner with an eligible project sponsor to carry out a project. Also, nonprofits are not eligible as direct grant recipients of TA funds unless, they are a designated transit agency, school, or responsible for the administration of local transportation safety programs.

The federal share for TA is 86.5 percent.

The FAST Act requires states and MPOs to report annually to USDOT on project applications and projects that are awarded TA funding. The USDOT must make these reports available to the public. The reports are based on each Federal Fiscal Year (FFY). The report is due from the MPO/RTPO/County by November 20th each year to WSDOT's Local Programs office in order to meet the FHWA deadline in December.

MPO/RTPO/County is to submit to WSDOT a report for each FFY that includes:

- The number of project applications received that FFY;
- The aggregate cost of the projects for which applications were received that FFY;
- The number of projects selected for funding that fiscal year, including:
 - Aggregate costs of the projects selected, and
 - Location of the projects selected.
- The types of projects to be carried out, based on the following seven categories:
 - Pedestrian and Bicycle Facilities
 - Recreational (recreational trail projects only)
 - Turnouts, Overlooks, Viewing Area
 - Historic Preservation
 - Environmental and Wildlife
 - Safe Routes to School
 - Other – Inventory, control or removal of outdoor advertising

For details on all eligible activities, go to www.fhwa.dot.gov/fastact/guidance.cfm

.55 Congestion Management and Air Quality (CMAQ) – The CMAQ program provides funding for transportation projects and programs that will reduce congestion and improve air quality for areas that do not meet the National Ambient Air Quality Standards (NAAQS) for ozone, carbon monoxide, or particulate matter (non-attainment areas), and for former nonattainment areas that are now in compliance (maintenance areas).

The Clean Air Act (CAA) of 1970 also provides for a set-aside for those areas with a classification for PM_{2.5} (particulate matter under 2.5 micrograms in diameter). For more information on Air Quality requirements, see the *Environmental Manual* M 31-11.

The primary intent is for these projects and programs to result in tangible reductions in oxides of nitrogen and sulfur (ozone precursors) and CO emissions within a timeframe to allow attainment as provided in the Clean Air Act Amendments (CAAA) of 1990. It is important to note that the Clean Air Act requires highest priority be given to the implementation of the transportation portions of applicable SIPs and Transportation Control Measures (TCMs) from applicable SIPs.

An evaluation and assessment of CMAQ projects and programs to determine the direct and indirect impact of the projects on air quality and congestion is required. Air quality benefits must be determined and documented to have projects qualify for CMAQ funds.

CMAQ funds are distributed to the five MPOs representing maintenance areas – Puget Sound Regional Council (PSRC), Spokane Regional Transportation Council (SRTC), Yakima Valley Conference of Governments (YVCOG), and Thurston Regional Planning Council (TRPC). FAST has a set-aside for MPOs designated as nonattainment or maintenance areas for PM_{2.5} that are to be used to address PM_{2.5} emissions. Tacoma, within PSRC, is designated as a maintenance area for PM_{2.5}.

Project planning activities are eligible only if the project leads directly to construction of a CMAQ project; that is, system planning and other non-project specific planning is not eligible. Developing computerized systems, such as a Geographic Information System, are not eligible. Studies to analyze future transportation needs are eligible only to the extent they are needed to develop project specific construction plans.

Sidewalk extensions and wheelchair ramps are eligible if they are incidental to an eligible CMAQ project, but are not eligible if they are the only work in the project. Paving projects for dust control are eligible only in areas where PM₁₀ nonattainment is or has been attributed to transportation sources.

If FTA determines eligibility, CMAQ funds may be transferred to FTA to purchase alternate fuel buses and refueling stations for bus fleets and transit conversion to alternate fuel and personal rapid transit systems. Converting municipal fleet operations to alternate fuel source such as compressed natural gas is eligible in areas that require conversion as a measure to mitigate noncompliance in the Clean Air Act.

The FAST Act requires WSDOT to report to FHWA annually on the CMAQ project obligations and associated air quality benefits for the project. MPOs annually provide WSDOT each obligated project's air quality benefits for submission into the national database of CMAQ investments, air quality benefits. The information is utilized by FHWA personnel for Congressional reporting and available to states and MPOs on an individual request basis. Also, FHWA has released a CMAQ Public Access System that

provides the opportunity for the general public to have access to the FHWA approved data at: https://fhwaapps.fhwa.dot.gov/cmaq_pub/

FAST requires performance measures be established by USDOT for states to use to assess traffic congestion and on-road mobile source emissions and target to address those performance measures to be set by the state. In Washington, PSRC (a Transportation Management Area over one million in population representing a maintenance area) is required to develop and update biennially a performance plan to achieve air quality and congestion reduction targets.

The federal participation for CMAQ is 86.5 percent.

For details on all eligible activities, go to www.fhwa.dot.gov/fastact/factsheets/cmaqfs.pdf

.56 Ferry Boat Program (FBP) – The FBP continues in FAST for the construction of ferry boats and for design, right of way, and construction of ferry terminal facilities. Funds will be allocated to states for distribution to the specific eligible public entity.

Federal aid highway funds are available for capital improvements to existing ferry facilities, as well as construction of new ferry facilities. Cost-effective preventive maintenance activities that extend the useful life of the ferry facility are also an eligible activity under 23 USC 116(e). However, operational costs of a ferry, such as costs of ferry service administration, crews, general maintenance, and fuel, are not eligible for direct federal aid highway funding.

Ferry entities are required to submit data to the national ferry database in order to be eligible for FBP funding. FBP funds will be allocated using the most current data to public owned ferry entities. FBP funds are available for three years and then withdrawn. Project scopes are required to be submitted to WSDOT for FHWA approval prior to inclusion in the STIP.

The federal participation is 80 percent.

For details on all eligible activities, go to www.fhwa.dot.gov/fastact/factsheets/ferryboatfs.cfm

.57 Emergency Relief (ER) Program – The FAST Act continues the Emergency Relief program, which provides funds for emergency repairs and permanent repairs on Federal-aid highways and roads, tribal transportation facilities, and roads on Federal lands that have suffered serious damage as a result of natural disasters or catastrophic failure from an external cause. Refer to [Chapter 33](#) for details.

.58 National Highway Freight Program (NHFP) – The FAST Act establishes a National Highway Freight Program to improve the efficient movement of freight on the National Highway Freight Network (NHFN) and support several goals, including—

- Investing in infrastructure and operational improvements that strengthen economic competitiveness, reduce congestion, reduce the cost of freight transportation, improve reliability, and increase productivity;
- Improving the safety, security, efficiency, and resiliency of freight transportation in rural and urban areas;
- Improving the state of good repair of the NHFN;
- Using innovation and advanced technology to improve NHFN safety, efficiency, and reliability;

- Improving the efficiency and productivity of the NHFN;
- Improving State flexibility to support multi-State corridor planning and address highway freight connectivity; and
- Reducing the environmental impacts of freight movement on the NHFN.
[23 U.S.C. 167 (a), (b)]

The WSDOT facilitated Freight Advisory Committee, which includes broad representation of local and freight stakeholders, prioritizes projects for the NHFP funding that is appropriated each biennium by the State Legislature.

The federal participation rate is 86.5 percent.

For details on all eligible activities, go to www.fhwa.dot.gov/fastact/guidance.cfm

.59 Ferry Boat Program (FBP) – The Moving Ahead for Progress in the 21st Century Act (MAP-21) revised 23 U.S.C. 147 and created the FBP for funding construction of ferry boats and terminal facilities and ferry maintenance facilities. The FAST Act continues to allocate FBP funds to States, U.S. territories, and Puerto Rico, and then further among eligible entities (ferry systems), based on a statutory formula.

The FAST Act continues to require the Bureau of Transportation Statistics to maintain a national ferry database. Ferry entities are required to submit data to the most recent collection of data for the national ferry database in order to be eligible for FBP funding. FBP funds will be allocated using the most current data. At the discretion of the Secretary, adjustments can be made to misreported or inconsistent data.

The FAST Act modified the formula, giving greater weight to the number of passengers carried by ferry systems. The formula is:

- 35% based on the number of ferry passengers, including passengers in vehicles, carried by each ferry system;
- 35% based on the number of vehicles carried by each ferry system; and
- 30% based on the total route nautical miles serviced by each ferry system.

Ferry Boat Program (FBP) funds are allocated differently than the federal formula funds (e.g., STBG, CMAQ, etc.). FHWA notifies each state that the Ferry Boat Program funds are available for the specific FFY. WSDOT notifies the Ferry Operator of the amount of funding available for that particular year.

Prior to obligation there are several steps that have been required since MAP-21 (2013).

- Scopes of work must be approved by FHWA prior to inclusion in the STIP
- Project must be included in the STIP
- Agency submits complete funding package for obligation (no later than July 1st)
- WSDOT requests FHWA funds be allocated to WA
- After funds are allocated WSDOT sends request to FHWA to obligate the funds

The FAST Act explicitly prohibits FBP funding for the construction or purchase, for private ownership, of a ferry boat, terminal facility, or other project. It also changes the mechanism used for selling, leasing, or otherwise disposing of Federally-funded ferry boats and terminal facilities.

The FAST Act requires for the FBP the funds are to be:

- Withdrawn from an eligible entity any allocated FBP funds that entity has not obligated by the end of the third fiscal year following the year in which State initially allocated the funds; and
- Redistributed those withdrawn funds (in accordance with the FBP formula described above) among other eligible entities.

12.6 FHWA Discretionary Programs

FHWA administers some discretionary programs through its various offices.

These discretionary programs represent special funding categories where FHWA solicits for candidates and selects projects for funding based on applications received. Each program has its own eligibility and selection criteria that are established by law, by regulation, or administratively. Below is a brief description of these programs.

.61 Federal Lands and Tribal Transportation Programs – The Federal Transportation Act continues to acknowledge the importance of access to federal and tribal lands. Recognizing the need for all public federal and tribal transportation facilities to be treated under uniform policies similar to the policies that apply to federal aid highways and other public transportation facilities, a unified program was created for federal lands transportation facilities, federal lands access transportation facilities, and tribal transportation facilities.

- **Federal Lands Transportation Program** – Provides funding for projects that improve access within federal lands, such as national forests, national wildlife refuges, national recreation areas and other federal public lands on transportation facilities in the national Federal Lands transportation inventory, and owned and maintained by the federal government. The National Park Service, U.S. Fish and Wildlife Service and U.S. Forest Service receive annual allocations identified in legislation. The Secretary decides allocation amounts for Bureau of Land Management, Bureau of Reclamation, U.S. Army Corps of Engineers, and eligible independent Federal agencies with natural resources and land management responsibilities.
- **Federal Lands Access Program** – Provides funding for projects on federal lands access transportation facilities that are located on or adjacent to, or that provide access to federal lands. The program supplements state and local resources for public roads, transit systems, and other transportation facilities that provide seamless access to high-use federal recreation sites or federal economic generators with federally-owned lands. Funds are distributed by formula based on recreational visitation, federal land area, federal public road mileage, and the number of federal public bridges. Programming decisions will be made locally using a tri-party model in each state comprised of representatives from FHWA, state DOT, and local government, in consultation with applicable Federal Land Management Agencies (FMLAs). A new federal match is required for these funds.
- **Tribal Transportation Program** – Provides funding for projects that improve access to and within Tribal lands. This program continues to provide set-asides for tribal bridge projects, tribal safety, program administration and tribal planning. FAST continues the statutory formula for distributing funds among tribes, based on tribal population, road mileage, and average tribal shares under the SAFETEA- LU Indian Reservation Road program.

.62 Other Discretionary Programs – The FAST Act also contains other nationwide competitive discretionary programs such as:

- Infrastructure For Rebuilding America (INFRA) Grants – A program initially established as the Nationally Significant Freight and Highway Projects (NSFHP) program to provide financial assistance or credit assistance—to nationally and regionally significant freight and highway projects.
- Transportation Investment Generating Economic Recovery (TIGER) discretionary grant program, provides a unique opportunity to invest in road, rail, transit, and port projects that promise to achieve national objectives. The TIGER program’s eligibility requirements allow project sponsors at the state and local level to obtain funding for multi-modal, multi-jurisdictional projects that are more difficult to support through traditional DOT programs.

For details on all eligible activities go to www.fhwa.dot.gov/fastact/guidance.cfm or www.transportation.gov/tiger.

12.7 FHWA Fund Transfers to Another Federal Agency for Administration

In the event an agency would like funds administered by another federal agency (FTA, BIA, WFL, etc.), the local agency must submit to WSDOT:

1. The project’s STIP page that reflects the funding is programmed in the first year,
2. A copy of the federal agency concurrence (email/letter) to accept FHWA funds and administer the project, and
3. Local agency request to transfer.

.71 Federal Transit Administration (FTA) Transfers – Funds may be transferred from FHWA to FTA for projects that are eligible under FTA. If the project is a traditional transit project, it should be transferred to FTA. If the project involves construction of roads or highways, it should stay with FHWA.

For projects that are not clearly transit or highway, the project sponsor should select the administering federal agency. This selection should be done in informal consultation with the two agencies and the Washington State Department of Transportation. Park and ride lots, Transportation Demand Management (TDM) activities, and intermodal facilities might be eligible under both agencies’ programs.

This matrix illustrates the FTA transfer options:

	FTA	FHWA
Transit Rolling Stock	X	
Park and Ride Lots	X	X
Pedestrian Ways	X	X
Refueling Bus	X	
Carpool and Vanpool	X	X
Regional Rideshare	X	X
Commuter Trip Reduction	X	X
Bikeways		X
Intermodal Station	X	
Bus and Signal Priority		X
Transit Maintenance and Operations	X	
Ferry Terminals	X	X
Passenger Ferry Vessels	X	
People Mover	X	
Auto Ferry Vessels-Metro (Puget Sound)	X	
Auto Ferry Vessels-Rural		X

If the project is to be implemented through FTA, the entire project, including all phases, should be transferred. In some instances, (some transit planning studies and selected projects not clearly defined above), funds to a transit agency may be approved through FHWA. Generally, these projects will have their scope of work and administrative oversight administered through WSDOT's Public Transportation Division.

Once FTA has reviewed the application and it is complete and ready for approval, FTA requests the transfer through Local Programs. Local Programs will request the transfer of funds from FHWA to FTA. FHWA action to transfer the funds is considered an obligation of federal funds. FTA will subsequently work with the grant recipient to utilize the transferred funds.

12.8 Appendices

- [12.81](#) MPO Planning Flowchart
- [12.82](#) STP Lead Agencies

Appendix 12.81 MPO Planning Flowchart

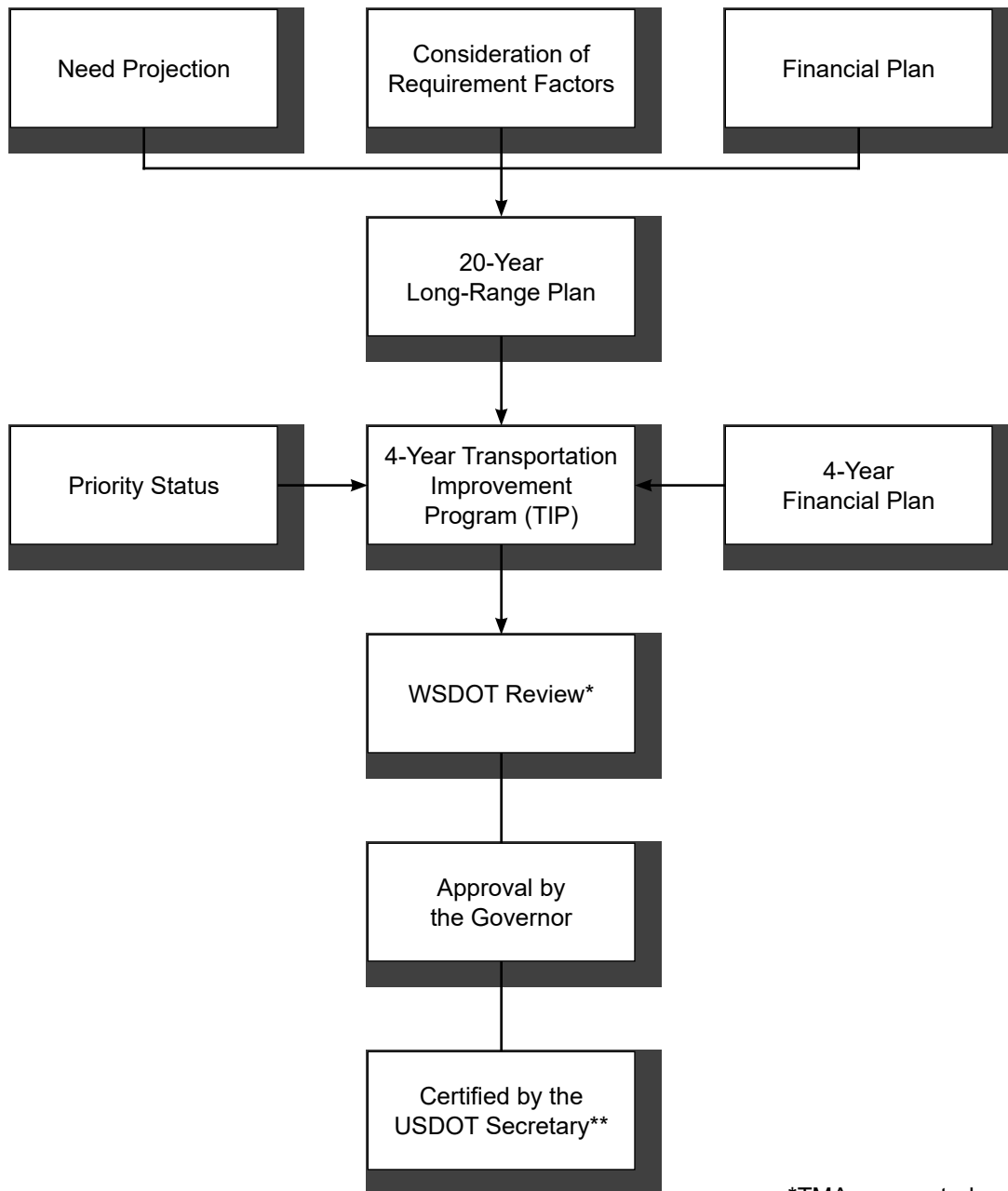

*TMAs exempted.
**TMAs only.

**Regional Planning and Programming Process
(Simplified Chart for MPOs)**

Appendix 12.82 STP Lead Agencies

Adams County
Benton-Franklin Council of Governments
Chelan-Douglas Transportation Council
Clallam County
Columbia County
Cowlitz-Wahkiakum Council of Governments
Ferry County
Garfield County
Grant County
Grays Harbor Council of Governments
Island County
Jefferson County
Kittitas County
Klickitat County
Lewis-Clark Valley MPO
Lewis County
Lincoln County
Mason County
Okanogan County
Pacific County
Pend Oreille County
Puget Sound Regional Council
San Juan County
Skagit Council of Governments
Skamania County
Southwest Washington Regional Transportation Council (RTC)
Spokane Regional Transportation Council
Stevens County
Thurston Regional Planning Council
Wahkiakim County
Walla Walla Valley MPO
Whatcom Council of Governments
Whitman County
Yakima Valley Conference of Governments

13.1 General Discussion

The Federal Highway Administration (FHWA) through a Stewardship Agreement, delegates authority to the Washington State Department of Transportation (WSDOT) for approving project development and construction administration. WSDOT has the option of delegating some or all of this authority to qualified local agencies, state or federal agencies, or Tribal governments. This procedure permits an agency to retain more of the approval authority at the local level when developing FHWA assisted transportation projects. WSDOT delegates this authority through a Certification Acceptance (CA) program. The CA program does not eliminate any project development procedures. Benefits of CA to a local agency include savings in time and money since the agency has the authority to develop, advertise, award, and manage its own projects.

CA requires local agencies to commit sufficient staff and other resources to project administration to ensure that all applicable state and federal requirements are met, and that the work can be accomplished efficiently. Once an agency has been certified, the certification agreement remains in effect indefinitely unless rescinded due to lack of performance or modified by one of the parties.

A CA agency has the option of requesting that WSDOT or another CA agency administer any given project.

By agreeing to accept federal aid funds, the local agency understands its roles and responsibilities with respect to carrying out the federal aid program. WSDOT is permitted to delegate certain activities, under its supervision, to local agencies (cities, counties, private organizations, or other state agencies) under federal regulation [23 CFR 1.11](#) and [635.105](#); however, WSDOT accepts responsibility for delegated activities.

FHWA is required by federal legislation to conduct verification activities to assure that WSDOT and the local agencies' implementation of the federal highway programs conform with laws, regulations and policies. Similarly per FHWA's delegation, WSDOT is also required to conduct verification activities to assure that local agency federal aid projects are implemented in conformance with federal aid requirements.

Certification Acceptance requirements for the right of way program are addressed in [Chapter 25](#). **Note:** Local agencies are not delegated the authority to certify right of way.

13.2 CA Features

A certified agency is the approving authority for administering FHWA funded projects in the following project items:

1. Design.
2. Utility agreements.
3. Railroad agreements.
4. Standard consulting engineering agreements.
5. Public hearings, findings, and orders.
6. Plans, specifications, and estimates.
7. Advertisement, award, and execution of construction contracts.
8. Construction administration.
9. Construction material testing and testing personnel.
10. Concurrence in Award of delegated projects.

All of the above functions should be administered per the responsibilities outlined in the Agency's approved CA Agreement.

WSDOT and FHWA retain approval authority for the following:

WSDOT

1. Design Deviations
2. Plans, Specification, and Estimate approval.
3. *Standard Specifications* Division 1 changes.
4. Public Interest Findings (local force work, agency supplied materials, proprietary items, etc.).
5. NEPA Categorical Exclusions per MOU, Section 106 Consultation.
6. Implementation of the Civil Rights Program Requirements (DBE, Title VI, ADA, and EEO/OJT).
7. Tied Bids approval (see [Appendix 44.82](#)).
8. Agency Certification Acceptance (CA) approval.
9. Project Final Acceptance.
10. Revisions to Agreements, when applicable.
11. Documentation/Project Management Reviews.
12. Concurrence in Award of DBE non-FHWA oversight projects.

FHWA

1. Authorization of FHWA funds.
2. Approval of National Environmental Protection Act (NEPA) and Endangered Species Act (ESA) environmental documents.
3. Right of way certification approval.
4. Approval of WSDOT's Civil Rights Programs (DBE, Title VI, EEO, ADA).
5. Buy America waiver approval.
6. Approval for Advertisement Period less than three weeks.
7. Approval of the *Local Agency Guidelines*.
8. Full oversight project approvals per Stewardship and Oversight Agreement. (Concurrence in Award, PS&E, Change Orders over \$200,000, etc.)

13.3 CA Requirements

1. Projects must be administered in accordance with the *Local Agency Guidelines*.
2. Projects must be administered utilizing a Professional Civil Engineer registered in the state of Washington who is either on staff as a public employee or is a contract employee designated as the agency's Engineer.
3. The agency shall have sufficient expertise and capability to perform and supervise the design, environmental, PS&E, and construction-administration phases of the project.
4. The agency must have designated an official approving authority for all WSDOT-delegated project approvals. This authority (e.g., agency executive or policy body) must officially approve each project step for which it is the approving authority, as identified in the agreement.

13.4 Application for CA

An agency applying to administer contracts under Certification Acceptance procedures must submit two copies of the Certification Acceptance Qualification Agreement and their Table of Organization to the Region Local Programs Engineer. A "Certification Acceptance Qualification Agreement" form is located at the end of this chapter and is also available through the WSDOT Region Local Programs Engineer.

After receiving the CA Qualification Agreement, the WSDOT Local Program's Project Development Engineer will conduct an interview with the local agency administrators to determine whether the agency is capable of administering an FHWA-funded project. Areas of consideration will be a determination of past performance, current staffing, overall capability, and knowledge of FHWA and state requirements.

Based on the interview, the Director, Local Programs will allow the agency to administer a project under a trial/mentoring status. Immediately following the completion of the project, a Project Management Review (PMR) will be performed to evaluate how the agency performs. A favorable PMR will result in the agency achieving CA status.

13.5 CA Compliance

The WSDOT Region Local Programs Engineer will consult and advise the CA agency concerning the project-management procedures to be followed. The level of this assistance will depend on the nature of each project and the demonstrated capabilities of the agency. In order to be reasonably certain that local agencies are administering FHWA funds in accordance with the *Local Agency Guidelines*, WSDOT will perform procedural reviews on selected local agency ad-and-award projects.

These reviews will be:

- Project Management Reviews (PMR) performed by Local Programs (see [Appendix 53.51](#) for review questions for PMR's and Documentation Reviews).
- Documentation Reviews performed by the Region Local Programs Engineer.

The agency may lose CA status, have its delegation of authority reduced to a project or phase of a project, or be placed on probationary CA. This may be the result of:

- A PMR or Documentation Review.
- An audit by the State Auditor.
- Final project inspection.
- The qualifications and experience of the agency staff are altered.
- A determination from any FHWA oversight activity.

If a vacancy occurs in the positions described in the CA Agreement as "Approving Authority," the Region Local Programs Engineer shall be notified and may schedule an interview of the replacement person.

The loss of CA status and reinstatement conditions will be outlined in a letter from Local Programs.

13.6 Non-CA Status

Responsible Charge

When Local Agencies elect to use consultants for engineering services, the local agency, as provided under [23 CFR 635.105\(b\)](#), shall provide a full-time employee of the agency to be in responsible charge of the project.

If an agency does not have CA status, the following two options are available for administration of a FHWA funded project

Option 1

- CA Agency Administering a Project for a Non-CA Agency

A non-CA agency enters into an Agreement with a CA agency to administer all aspects of the project. This requires approval by the Region Local Programs Engineer.

Option 2

The Region Local Programs Engineer acts as the CA for the agency and approves an agency to perform specific aspects of a project. An approved plan for the administration of the project is executed between the Region Local Program Engineer and the agency. This category allows projects of smaller sizes to be performed in part by the agency. The project plan shall address such issues as:

- Financing approvals – accounting/billing capabilities.
- Consultant involvement and monitoring. The agency must obtain the approval of the Region Local Programs Engineer prior to selection of a consultant.
- Development of design and design documentation.
- Development of plans, specifications, and estimates.
- Approval of contract documents.
- Advertising, award, execution of a contract.
- Contract oversight and documentation.
- Change order approval.
- Material approval.

13.7 Appendices

- [13.71](#) Certification Acceptance Qualification Agreement
- [13.72](#) Certification Acceptance Interview Form

Agency: [Click here to enter text.](#)

Agency Number: [Click here to enter text.](#)

The agency agrees to comply with the following requirements when developing all Federal Highway Administration (FHWA) projects under [Click here to enter text.](#) CA status.

1. Adherence to the *Local Agency Guidelines* and all policies and procedures promulgated by the Washington State Department of Transportation (WSDOT) which accomplish the policies and objectives set forth in Title 23, U.S. Code, Highways, and the regulations issued pursuant thereto.
2. The overall approval authorities and conditions will be as follows:
 - a. The project prospectus will be reviewed and approved by the following official.
[Click here to enter text.](#) (Position Title Only)
 - b. The local agency agreement will be reviewed and approved by the following official or officials.
[Click here to enter text.](#) (Position Title Only)
 - c. The designs and environmental documents will be reviewed and approved by the following state of Washington registered Professional Civil Engineer.
[Click here to enter text.](#) (Position Title Only)
 - d. The hearing's findings (if required) will be reviewed and approved by the following official or officials.
[Click here to enter text.](#) (Position Title or Titles Only)
 - e. The contract plans, specifications and estimate of cost will be reviewed and approved by the following state of Washington registered Professional Engineer.
[Click here to enter text.](#) (Position Title or Titles Only)
 - f. Agreements will be signed by the following responsible local official:
 - i. Railroad [Click here to enter text.](#) (Position Title Only)
 - ii. Utility [Click here to enter text.](#) (Position Title Only)
 - iii. Consultant [Click here to enter text.](#) (Position Title Only)
 - iv. Technical Services [Click here to enter text.](#) (Position Title Only)
 - g. The award of contract will be signed by the following responsible local official.
[Click here to enter text.](#) (Position Title Only)
 - h. All projects will be constructed in conformance with the Washington State Department of Transportation/American Public Works Association (WSDOT/APWA) current *Standard Specifications for Road, Bridge, and Municipal Construction* M 41-10 and such specifications that modify these specifications as appropriate. Multimodal enhancement projects shall be constructed in conformance with applicable state and local codes.
 - i. The contract administration will be supervised by the following state of Washington registered Professional Civil Engineer. [Click here to enter text.](#) (Position Title Only)
 - j. Construction administration and material sampling and testing will be accomplished in accordance with *Construction Manual* M 41-01 and the Local Agency Guidelines.

DOT 140-550
10/2015

3. The agency agrees that they have the means to provide adequate expertise and will have support staff available to perform the functions being subdelegated. The support staff may include consultant or state services.
4. The agency agrees that the signature on each project prospectus and local agency agreement will be consistent with section 2 above.
5. All projects under Certification Acceptance shall be available for review by the FHWA and the state at any time and all project documents shall be retained and available for inspection during the plan development and construction stages and for a three year period following acceptance of the project by WSDOT.
6. Approval of the local agency certification by the Director, Local Programs may be rescinded at any time upon local agency request or if, in the opinion of the Director, Local Programs, it is necessary to do so. The rescission may be applied to all or part of the programs or projects approved in the local agency certification.

Mayor or Chairman

Date

Washington State Department of Transportation

Approved By:

Director, Local Programs

Date

DOT 140-550
10/2015

Appendix 13.72 Certification Acceptance Interview Form



Certification Acceptance Interview Form

Agency: [Click here to enter text.](#)

Date: [Click here to enter text.](#)

Interview Conducted By: [Click here to enter text.](#)

Agency Representatives: [Click here to enter text.](#)

Table of Organization

Get copy from agency and review duties, requirements, and personnel currently filling.

Position Responsible for the Following Functions

Functions	Position Responsible
Six-Year Transportation Improvement Program	Click here to enter text.
Location/Design Approval	Click here to enter text.
PS&E Approval	Click here to enter text.
Approval of Materials Sources	Click here to enter text.
Construction Inspection	Click here to enter text.
Independent Assurance Sampling/Test	Click here to enter text.
Project Files	Click here to enter text.
Training Goal Attainment	Click here to enter text.
ADA Compliance/Monitoring	Click here to enter text.
Title VI	Click here to enter text.
Selection of Annual Program	Click here to enter text.
Environmental Documents	Click here to enter text.
Tied Bids	Click here to enter text.
Construction Administration	Click here to enter text.
Acceptance Sampling/Test	Click here to enter text.
Change Orders	Click here to enter text.
EEO Interviews/Monitoring	Click here to enter text.
DBE Compliance/Monitoring	Click here to enter text.
Consultant Services	Click here to enter text.

Consultants

For what areas does the agency expect to use consultants?

- | | |
|---|--|
| <input type="checkbox"/> Design | <input type="checkbox"/> Right of Way Relocation |
| <input type="checkbox"/> PS&E Preparation | <input type="checkbox"/> Construction Administration |
| <input type="checkbox"/> Right of Way Appraisal | <input type="checkbox"/> Construction Inspection |
| <input type="checkbox"/> Environmental | <input type="checkbox"/> Surveying |
| <input type="checkbox"/> Right of Way Negotiation | <input type="checkbox"/> Sampling and Testing |

Does the local agency utilize WSDOT's *Consultant Services Manual* in its consultant selection processes associated with federal aid projects? Yes No

Does the local agency have written procedures for the selection of consultants? Yes No

Comments: [Click here to enter text.](#)

If consultants are used, how will the agency monitor and control the consultant's work?

[Click here to enter text.](#)

Remind the agency that they will be in control of the consultant's work and that EEO, DBE, and training should be done by the agency.

Title VI

Does the local agency have a Title VI Plan and/or Nondiscrimination Agreement and is it up to date?

Yes No

Comments: [Click here to enter text.](#)

Right of Way

Does the agency have procedures approved by WSDOT for:

Right of Way Acquisitions: Yes No

Relocation: Yes No

Procedures for Ad, Award, and Execution of Contract

Position responsible for:

Approval to Advertise: [Click here to enter text.](#)

Prequalification of Bidders: [Click here to enter text.](#)

Award of Contract: [Click here to enter text.](#)

Execution of Contract: [Click here to enter text.](#)

Name of Legal Publication: [Click here to enter text.](#)

General Questions About Administration

Who decides on and approves deviations from design prior to submittal to the state for formal approval?:

[Click here to enter text.](#)

Describe ledger system: [Click here to enter text.](#)

Who will check payrolls, etc.?: [Click here to enter text.](#)

Describe the process for approving project special provisions: [Click here to enter text.](#)

Describe change order approval process (including those that affect the work of DBEs):
[Click here to enter text.](#)

Describe materials testing and approval process: [Click here to enter text.](#)

Describe agency requirements for project diary and inspectors daily report keeping:
[Click here to enter text.](#)

Describe agency process for approval of subcontractors: [Click here to enter text.](#)

How will the agency handle administration of more than one contract at the same time?:
[Click here to enter text.](#)

How will the agency handle inspection of several phases of project at same time (e.g., dirt work, electrical, paving, structure)?: [Click here to enter text.](#)

How will the agency respond if project engineer and/or inspector are unable to be on job site due to illness, etc.? Who will handle control of project if needed person cannot be there?:
[Click here to enter text.](#)

How does the agency manage traffic control?: [Click here to enter text.](#)

Are there written procedures for preconstruction conferences?: [Click here to enter text.](#)

Does the Agency Have These Necessary Manuals

- | | | |
|--|------------------------------|-----------------------------|
| WSDOT <i>Local Agency Guidelines</i> (LAG) M 36-63 | <input type="checkbox"/> Yes | <input type="checkbox"/> No |
| AASHTO <i>Policy on Geometric Design of Highways and Streets</i> | <input type="checkbox"/> Yes | <input type="checkbox"/> No |
| WSDOT <i>Construction Manual</i> | <input type="checkbox"/> Yes | <input type="checkbox"/> No |
| WSDOT/APWA <i>Standard Specifications</i> | <input type="checkbox"/> Yes | <input type="checkbox"/> No |
| APWA <i>Amendments</i> | <input type="checkbox"/> Yes | <input type="checkbox"/> No |
| WSDOT <i>Amendments and Standard Specifications</i> | <input type="checkbox"/> Yes | <input type="checkbox"/> No |
| <i>Standard Item Table</i> | <input type="checkbox"/> Yes | <input type="checkbox"/> No |
| MUTCD | <input type="checkbox"/> Yes | <input type="checkbox"/> No |
| WSDOT <i>Design Manual</i> M 22-01 | <input type="checkbox"/> Yes | <input type="checkbox"/> No |
| WSDOT <i>Standard Plans for Road and Bridge Construction</i> M 21-01 | <input type="checkbox"/> Yes | <input type="checkbox"/> No |
| WSDOT <i>Utility Manual</i> M 22-87 | <input type="checkbox"/> Yes | <input type="checkbox"/> No |
| WSDOT <i>Right of Way Manual</i> M 26-01 | <input type="checkbox"/> Yes | <input type="checkbox"/> No |
| SWIBS <i>Manual</i> | <input type="checkbox"/> Yes | <input type="checkbox"/> No |
| WSDOT <i>Hydraulics Manual</i> M 23-03 | <input type="checkbox"/> Yes | <input type="checkbox"/> No |
| WSDOT <i>DBE Program Plan</i> | <input type="checkbox"/> Yes | <input type="checkbox"/> No |
| WSDOT <i>Consultant Services Manual</i> M 27-50 | <input type="checkbox"/> Yes | <input type="checkbox"/> No |

Upcoming Federal Aid Projects

Project Title	Scheduled to Begin
Click here to enter text.	Click here to enter text.
Click here to enter text.	Click here to enter text.
Click here to enter text.	Click here to enter text.
Click here to enter text.	Click here to enter text.

Summary

Action to be taken by agency in following areas: Click here to enter text.

Comments From Reviewers

Click here to enter text.

Recommendation of Review

- Full administration by agency of all projects
- Administration by agency on a project-by-project basis
- Administration by agency for projects up to \$ Click here to enter text.
- Deny approval for certification acceptance
- Remove from certification acceptance status

Concurrence by Director, Local Programs

Director, Local Programs

Date

Chapter 14 *Developing Projects Using the Local Agency Guidelines*

14.1 **General Discussion**

The previous three chapters of this manual explained how local agencies may qualify to receive Federal Highway Administration (FHWA) funding for their transportation projects. The remainder of the manual explains procedures for developing specific projects.

Once a local agency has qualified to receive FHWA funds, as described in [Chapter 12](#), the next action is to apply for funds to develop specific projects in its transportation program. Depending on their size and complexity, different projects may require different development procedures. The remaining chapters of the manual are arranged to reflect these differences.

For projects selected by HQ Local Programs – Once a project has been awarded funds, the local agency is to complete the project as selected. In the event unforeseen conditions (e.g., environmental, right of way) are encountered requests for scope, schedule and budget adjustments may be considered.

Chapters [21–28](#), General Project Development Processes, describe activities required during preliminary engineering on all projects.

Chapters [31–34](#), Special Project Development Processes, describe activities that may be required on some projects.

Chapters [41–46](#), Design, and Chapters [51–53](#), Construction and Post Construction, offer the local agency a choice of procedures, depending on whether its projects are located in urban or rural areas and whether it or the state will administer its construction contracts.

Chapters [61](#), Local Agency Force Projects, describes procedures from project design approval through the closing of an FHWA project, using the agency's labor, equipment, and materials.

The specific requirements for a project may change as project development progresses and as more information about a project becomes available. Further details of the specific requirements are shown in the Project Development Process Flowchart and Checklist. The meanings of unfamiliar terms may be found in the Glossary. Once the local agency has identified the steps required on a particular project, only the parts in the manual that deal specifically with those steps need be referred to.

14.2 Project Development Process Overview

This section describes the project development process by setting forth project phases, documentation requirements, options for construction administration, and required reviews and approvals.

.21 Phases of Authorization – FHWA funds may be authorized for the following project phases:

1. Preliminary engineering or separate planning study.
2. Right of way acquisition.
3. Construction.

Phase Requirements When Utilizing FHWA Funds – For all phases, and at the time of each phase authorization, all funds necessary to complete the scope of work being authorized for the phase must be secured.

Preliminary Engineering Phase – FHWA Funds in PE Phase Only. For FHWA funds to be used in the PE phase of the project, the environmental documentation including FHWA NEPA approval, must be completed prior to advertising the project for construction. With no federal funds in the right of way or construction phases, the local agency must still follow federal environmental regulations and the Uniform Relocation Assistance and Real Property Acquisition Policies Act. A NEPA document must be approved by FHWA and all environmental commitments must be incorporated into the right of way and construction phases. Effective October 1, 2012 Section 1518 of MAP-21 amended the Buy America Statute. If any phase of a project (PE, RW, CN) within the scope of a NEPA document is awarded using Federal-aid funding then the Buy America provisions will apply to all construction phases within the scope of the NEPA document, regardless of the source of funding. Right of way must be acquired per the [Right of Way Manual M 26-01](#) and acquisition may proceed during the PE Phase in accordance with the manual.

Any study projects are excluded from NEPA approval, planning studies must be completed and a copy provided to WSDOT to close the project.

Note: Right of way acquisition or actual construction of the project must start prior to the close of the tenth federal fiscal year following the federal fiscal year in which preliminary engineering was authorized.

Right of Way Phase – FHWA Funds in Right of Way Phase. For FHWA funds to be used in the right of way phase of the project, the environmental documentation including FHWA NEPA approval, approved relocation plan (if applicable), Project Funding Estimate and approved right of way plan must be completed prior to FHWA R/W authorization. All property acquisitions and relocations must be completed prior to advertising the project and must comply with the Uniform Act and [49 CFR Part 24](#) or the local agency is at risk of repayment of all federal funds used in the project. All environmental commitments must be incorporated into the R/W and construction phases. (See also “Determining Whether or Not Land or Property Rights or interest are Needed” flowchart in [Appendix 25.174](#).)

Note: Construction of the project must start prior to the close of the tenth federal fiscal year following the federal fiscal year in which right of way was authorized.

Construction Phase – FHWA Funds in Construction Phase. All federal laws are triggered with federal funds in the construction phase; examples include NEPA, Title 23 USC, Uniform Relocation Assistance and Real Property Acquisition Policies Act, Buy America, and Davis-Bacon. After approval of the NEPA document, right of way certification, and the DBE/Training goals are established the construction phase can be authorized by FHWA. Once FHWA authorizes construction funding the local agency has authority to advertise the project. For Intelligent Transportation Projects (ITS) or projects that include ITS components (cameras, signal interconnect, fiber optic, etc.) agencies must complete and submit the ITS information form ([Appendix 41.53](#)) with the construction authorization request.

Documentation Requirements When Utilizing FHWA Funds	PE Phase: FHWA Funds in PE Phase Only ¹	R/W Phase: FHWA Funds in the R/W Phase ²	CN Phase: FHWA Funds in the Construction Phase ³
Required Documentation			
STIP	X	X	X
Approved NEPA	X ⁴	X ⁴	X ⁴
Approved Relocation Plan (if applicable)		X	
Project Funding Estimate		X	
Approved R/W Plan		X	
WSDOT Approved Right of Way Certification		X	X
DBE/Training Goals			X
Design per LAG Manual			X
Environmental per LAG Manual	X	X	X
R/W Acquisition per LAG Manual	X	X	X
Construction per LAG Manual			X
Title VI & Buy America provisions	X	X	X
Intelligent Transportation Systems Information Form (Appendix 41.53)			X

¹Local Agency must provide documentation after completion of the PE phase that the project has been or will be constructed with non-FHWA funds.

²Local Agency must provide documentation after completion of the PE and R/W phases that the project has been or will be constructed with non-federal funds.

³Local Agency must provide documentation after completion of the CN phase as documented in this manual.

⁴Any environmental commitments must be incorporated into the R/W and /or CN phases. NEPA is not required if it is a planning study only.

⁵Local Agencies must provide a completed form if the project includes ITS components (see [Appendix 41.53](#)).

.22 Documentation Required for Authorization of Funds

1. **Planning With STP Funds** – “Urban Transportation Planning” is an interdisciplinary process for developing and monitoring long- and short-range transportation plans and improvement programs. These plans and programs are formulated with due consideration of present and anticipated future social, economic, and environmental factors and the safety and mobility needs of the population of the urban area. It is a dynamic process, in that it is continuously monitored to accommodate changes of land use, economic conditions and other factors influencing travel patterns. Because of the vast amount of capital expenditures required in the implementation of transportation systems (both highway and transit related), these projects could radically influence land use development in an area or region. Due to the substantial influences that transportation improvements have on the character of the land, it is important that transportation improvements reflect the overall regional social and economic objectives pertaining to community development.

FHWA funded planning activities and studies are identified in Title 23, Part 420 USC, as activities not included in a work program but necessary in development of procedures and project identification.

For planning and Transportation Demand Management (TDM) funding, the following documents are required:

- a. Project prospectus planning scope of work ([Chapter 21](#)).
 - b. Local Agency Agreement ([Chapter 22](#)).
 - c. Evidence of STIP inclusion.
 - d. Documented cost estimate.
 - e. Updated Quarterly Project Report, if required.
2. **Preliminary Engineering Funds** – When applying for preliminary engineering funds only, the following documents are required:
 - a. Project Prospectus ([Chapter 21](#)).
 - b. Local Agency Agreement ([Chapter 22](#)).
 - c. Typical sections, vicinity map, and evidence of STIP inclusion.
 - d. Documented cost estimate
 - e. Updated Quarterly Project Report, if required.

3. **Right of Way Funds** – When applying for right of way funds, after preliminary engineering funds have developed right of way plans, the following documents are required, if appropriate:
 - a. Supplement to original Local Agency Agreement ([Chapter 22](#)).
 - b. FHWA approval of environmental documents ([Chapter 24](#)).
 - c. Relocation plan, if relocation is required ([Chapter 25](#)).
 - d. Approved Right of way plan ([Chapter 25](#)).
 - e. Right of way Project Funding Estimate or True-Cost estimate ([Chapter 25](#)).
 - f. Evidence of STIP inclusion.
 - g. Updated Quarterly Project Report, if required.
 4. **Construction Funds** – The following documents must be submitted to request construction funds:
 - a. Supplement to Local Agency Agreement. The agency’s proposed advertisement date must be noted on the supplement, or the original LAA if construction is the first phase authorized.
 - b. Right of way certification (if required).
 - c. Final FHWA approval of environmental documents ([Chapter 24](#)).
 - d. Evidence of STIP inclusion.
 - e. Updated project prospectus. To ensure utility and railroad work is adequately addressed ([23 CFR 635.309\(b\)](#)) local agencies are required to provide an updated, signed project prospectus at time of construction phase authorization.
 - f. Engineer’s Estimate.
 - g. Evidence of assignment of DBE/training goals.
 - h. Updated Quarterly Project Report, if required.
- .23 Construction Contract Administration** – The local agency has the option of:
1. Administering the contract if it has approved certification acceptance procedures and operates in compliance with [Chapter 13](#).
 2. Requesting that WSDOT administer the contract.
 3. Using its own forces to perform the work if operating under Certification Acceptance (CA) ([Chapter 61](#)).
 4. Requesting that another public agency (one operating under CA) perform the work ([Chapter 13](#)).
 5. Performing contract administration by a consultant ([Chapter 31](#) under CA).

14.3 Projects Within Interstate Rights of Way

Since all projects within the Interstate Rights of Way (R/W) have the potential to impact safety and operations on the Interstate route, they must incorporate Interstate design criteria and construction quality. It is the Federal Highway Administration's (FHWA) policy that all projects within the Interstate R/W should be administered by WSDOT. However, given the scope and extent of non-Interstate projects within the Interstate R/W, it is recognized that local agency administration of some projects may be acceptable, and all requests will be considered on a case-by-case basis.

Whenever a local agency proposes a project within the Interstate R/W, they must develop an agreement with WSDOT that clearly outlines their duties and responsibilities to maintain the integrity of the Interstate facility, from both the safety and quality perspectives. The agreement should be executed prior to design approval and must be executed prior to advertising for bids. The following requirements must be incorporated into the agreement:

Responsibilities – WSDOT and the local agency must each assign a project engineer.

Design – WSDOT must review and approve all highway plans, profiles, deviations, structural plans, false-work plans, shoring plans, and traffic control plans for any work within the Interstate R/W.

Plans, Specifications, and Estimates – WSDOT must review and approve the plans and specifications for any work within Interstate R/W.

Advertising and Award – The local agency must confer with the WSDOT project engineer on any pre-award issues affecting the quality and timing of the contract.

Construction – All construction, materials, and quality control requirements contained in the current editions of the [Standard Specifications](#) M 41-10 and [Construction Manual](#) M 41-01 must be incorporated into the agreement.

Contract Changes – All contract changes affecting work within the Interstate R/W must have the prior concurrence of the WSDOT project engineer.

Final Inspection – The final inspection of the project must be performed by WSDOT or the Region Construction (Operations) Engineer and must provide proof of their approval.

The agreement must be submitted to FHWA. FHWA reserves the right to assume full oversight of the project.

14.4 Project Development Process Flowchart and Checklist

The flowchart (see [Appendix 14.51](#)) and checklist (see [Appendix 14.52](#)) depict the sequence of major activities necessary to develop transportation projects using FHWA funds. The forms required for a project are shown on the list of forms. Since the type of work varies on projects, see [Construction Manual Chapter 11](#), for additional required forms.

It is recommended that a copy of the checklist be inserted in the project file and used to initiate and document the activities necessary to complete a project.

14.5 Appendices

- [14.51](#) Project Development Process Flowchart
- [14.52](#) Project Development Checklist

Project Development Process Flowchart

Phase	Process Activities	Chapter Reference
Initiate	00 Project Development Checklist	12 and 14
	00 Included in STIP	or
Design	00 Project Development Checklist	21 and 43
	00 Prepare Project Prospectus-Design Report	
	00 If Applicable, Engage Consultant	31
	00 Make Environmental Determination	24
	00 If Applicable, Request Design Deviation	41
Request Preliminary Engineering Funds	00 Project Development Checklist	43
	00 Location/Design, Public Hearing, and Approval	
	00 Complete Environmental Action	24
	00 Develop Right of Way Plans and Estimate	25
	00 Complete Relocation Plan	25
	00 Supplement to Local Agency Agreement	22
Request Right of Way Funds	00 Project Development Checklist	25
	00 Relocation and Right of Way Certification and Project Analysis	
	00 DBE Goals Set	26
	00 PS&E Approval	44
	00 Supplement to Local Agency Agreement	22
	00 For State Ad and Award, Financial Responsibility Letter	44
Request Construction Funds	00 Project Development Checklist	46
	00 Contract Number From the Region Local Programs Engineer	
Construction Administration	00 Notice to Minority Contractors Association (see Region Local Programs for Distribution Centers)	26
	00 Advertise for Bids	46
	00 For Certified Agency (CA), Approve Award and Notify Region Local Programs Engineer	46
	00 For WSDOT Administered Contracts, Award by WSDOT	45
	00 Award Data to Region Local Programs Engineer	46
	00 Preconstruction Conference	52
	00 Construction Administration (<i>Construction Manual M 41-01</i>)	52
Project Closure	00 Project Development Checklist	53
	00 Construction Completion Notice to Region Local Programs Engineer	
	00 Final Acceptance by FHWA	53
	00 Final Billing and Cost Report to Region Local Programs Engineer	23 and 53
Project Closure	00 Complete DBE Form	26
	00 Final Records	53
	00 Audit	53

No Environmental Studies, Right of Way, and Hearings Required

Appendix 14.52 Project Development Checklist



Project Development Checklist

Project Title: _____

Project Location: _____

Road or Street Number: _____ FA Program: _____

		Project in STIP
		Federal aid program form (Sheet 1 of Prospectus) to:
		<input type="checkbox"/> Metropolitan planning organization
		<input type="checkbox"/> Or WSDOT (Region Local Programs)
		<input type="checkbox"/> Nondiscrimination Agreement
		Program of project approved by appropriate agency
		Sheet 1
		<input type="checkbox"/> Project information, local agency project number
		<input type="checkbox"/> Description of proposed work and existing facility
		<input type="checkbox"/> Cost estimate of all phases
		<input type="checkbox"/> Proposed obligation date
		<input type="checkbox"/> Environmental determination (CE, EIS, EA)
		<input type="checkbox"/> Request species listing from USFWS, NMFS, DNR, and WDFW
		<input type="checkbox"/> Signature block
		Sheet 2
		<input type="checkbox"/> Geometric design data
		<input type="checkbox"/> Environmental considerations
		<input type="checkbox"/> Performance of work
		Sheet 3
		<input type="checkbox"/> Right of way relocation
		<input type="checkbox"/> Utility relocations
		<input type="checkbox"/> FAA Involvement
		<input type="checkbox"/> Signature
		<input type="checkbox"/> Local Agency Design Matrix Checklist, Appendix 42.101
		Prospectus Submittal Checklist, Appendix 21.41
		Billing address
		<input type="checkbox"/> Description of work matches prospectus
		<input type="checkbox"/> Check math on agreement
		<input type="checkbox"/> Federal aid matching percentage
		<input type="checkbox"/> Method of financing
		<input type="checkbox"/> Agreement signed by approving authority
		Project programmed
		Project application package to Region Local Programs Engineer:
		<input type="checkbox"/> Project prospectus with attachments (including Roadway Section if applicable)
		<input type="checkbox"/> Local Agency Agreement
		<input type="checkbox"/> Prospectus Submittal Checklist completed
		PE funds authorized by Local Programs
		Evaluate if WSDOT Access Permits are required

		Independent estimate for consultant services and recommendation (request) to approving authority
		Receive approval to advertise for consultant services
		Advertise for consultant services - see Appendix 31.74 (Must include Title VI language)
		Develop consultant evaluation selection criteria
		Select minimum of three best qualified firms
		Submit request for approval of selected firm to approving authority
		Conduct pre award audit (if necessary) before negotiations
		Approving authority approves selection, negotiation begins
		Negotiation completed – submit final draft of agreement, etc., to the approving authority
		Receive approval from approving authority
		Agreement signed by consultant
		Agreement executed by approving authority (consultant may now begin work)
		Notice to proceed sent to the consultant
		Send copy of agreement to Region Local Programs Engineer

		Oversee the consultant’s work and billings to ensure compliance with the agreement
		Prepare diary to record discussions and visitation with the consultant
		Check consultant billings regarding employee classification, wage rate, actual invoices for direct non salary costs, etc.
		Enter consultant payment on ledger system
		Conduct consultant employee interviews
		Establish and maintain a tracking system to monitor consultant agreement expiration dates

		<input type="checkbox"/> Request a NEPA kick-off meeting with the LPE and Local Programs Environmental Engineer (if warranted). Review the draft CE Documentation Form prior to the kick-off meeting <input type="checkbox"/> Submit completed drafts of discipline reports to WSDOT Region Local Programs for review by Local Programs Environmental Engineer <input type="checkbox"/> Submit completed discipline reports to WSDOT Region Local Programs <input type="checkbox"/> Obtain all necessary approvals

		Obtain concurrence from FHWA Area Engineer and Local Programs HQ that an EA is necessary.
		Submit preliminary environmental assessment to Region Local Programs
		Revise draft environmental assessment, based on Local Programs and FHWA comments
		WSDOT and FHWA approve environmental assessment
		Publish notice of availability for environmental assessment
		Publish opportunity for comment period and hearing, if held
		Submit FONSI package (including summary of comments received and responses, any revisions to the environmental assessment and FONSI) to Region Local Programs for review by Local Programs and FHWA
		FONSI issued by FHWA
		-or-
		Establish need to develop Environmental Impact Statement

		Obtain concurrence from FHWA Area Engineer and Local Programs HQ that an EIS is necessary.
		Submit draft Notice of Intent to Region Local Programs
		FHWA Publishes Notice of Intent Submit interdisciplinary team recommendations to project manager
		Develop public involvement plan
		Develop data inventory and evaluation from interdisciplinary team
		Submit preliminary discipline reports for review to Region Local Programs
		Submit completed discipline reports to Region Local Programs
		Submit preliminary Draft Environmental Impact Statement to Region Local Programs
		Receive WSDOT and FHWA comments on the preliminary draft of EIS
		Submit camera-ready Draft Environmental Impact Statement to Region Local Programs Engineer for WSDOT and FHWA signature
		Receive approval to publish Draft Environmental Impact Statement Distribute draft environmental impact statement to circulation list
		Publish notice of availability in Federal Register (minimum 45 days comment period)
		Advertise opportunity for public hearing
		Respond to all comments received and forward comments/responses to Region Local Programs for review by Local Programs
		Prepare and submit preliminary Final Environmental Impact Statement to Region Local Programs Engineer
		Receive comments from WSDOT and FHWA
		Receive approval to print Final Environmental Impact Statement
		Submit final Environmental Impact Statement to Region Local Programs Engineer for WSDOT and FHWA signature
		Circulate final Environmental Impact Statement
		Submit draft record of decision package to FHWA
		Final ROD issued by FHWA

		Submit project prospectus
		Submit design report
		Submit "Work Zone Safety and Mobility" report where applicable (see Section 41.2)
		Submit pavement design criteria
		Meet public hearing requirements
		Meet environmental requirements
		Concurrence with BA effect determinations
		ECS approval by FHWA
		For projects over \$50 million in the construction phase and bridge projects over \$40 million in the construction phase conduct a Value Engineering Study.
		For traffic signal projects, submit warrants for signalization to Region Local Programs Engineer
		Obtain location and design approval
		Publish design approval notice

		Project in STIP
		Complete design hearing requirements
		Approve right of way plan
		Submit right of way relocation plan (if required) to Region Local Programs Engineer
		Submit right of way project funding estimate or true cost estimate, supplement to Local Agency Agreement and FHWA approval of environmental documents, to Region Local Programs Engineer with request for right of way funds
		Receive authorization to acquire R/W from the Director, Local Programs
		Acquisition procedures approved by the ROW Program Manager, Local Programs
		Acquisition procedures current
		Set up documentation file for each parcel
		Set up commitment file
Appraisal		
		Appraiser approved by WSDOT
		Give landowner opportunity to accompany appraiser
		Signed appraiser certification in file
Appraisal Review		
		Appraisal reviewer approved by WSDOT
		Date of value determination precedes commencement of negotiations
		Just compensation set by agency
		Signed review appraiser certification in file
Negotiations		
		Prepare diary of all owner contacts
		Give owner written statement of just compensation (Offer Letter)
		Ensure that settlement contains construction clauses
		Obtain evidence of clear title
		Negotiator disclaimer statement in file
Relocation Plan		
		Approved by WSDOT
		Work with WSDOT relocation staff on all relocations
Project Completion		
		Complete relocation
		Complete acquisition
		Complete administrative settlement documentation
		Place a copy of deeds in file, include proof of payment in file
Send		
		Letter of certification sent from local agency to Region Local Programs Eng.
		LPA coordinator conducts certification review
		WSDOT's certification by ROW Program Manager, Local Programs

	<p>Review commitment and correspondence file</p> <p>When applicable, secure the following permits or interagency coordination:</p> <ul style="list-style-type: none"> <input type="checkbox"/> Airport roadway clearance from FAA <input type="checkbox"/> Coastal zone management compliance from DOE <input type="checkbox"/> For cultural, archeological, or historic sites SHPO contacted <input type="checkbox"/> Obtain concurrence letters for environmental determination <input type="checkbox"/> When waters modified or controlled Washington Department of Fish & Wildlife and DOE contacted regarding permitting <input type="checkbox"/> When stream is affected WDFW and DOE contacted regarding permitting <input type="checkbox"/> For timber supporting land, permit from DNR <input type="checkbox"/> When construction might reduce water quality, contact DOE <input type="checkbox"/> For quarries of 2 acres (0.81 ha) and 10,000 tons (9 091 metric tons) or more DNR contacted <input type="checkbox"/> Waters/wetlands – Army Corps of Engineers and DOE contacted <input type="checkbox"/> For navigable waterways, permit from Coast Guard obtained <input type="checkbox"/> If ESA-listed species are present in the project action area, U.S. Fish & Wildlife Service and National Marine Fisheries Services consulted <input type="checkbox"/> Utility agreement obtained <input type="checkbox"/> Railway agreement(s) obtained <input type="checkbox"/> On all federal aid projects, any revision to Division 1 of the Standard Specifications or APWA Division 1 General Special Provisions requires prior written approval from Local Programs
	<p>PS&E completed:</p> <ul style="list-style-type: none"> <input type="checkbox"/> Vicinity map <input type="checkbox"/> Summary of quantities <input type="checkbox"/> Pit, quarry, stockpile, and waste sites <input type="checkbox"/> Reclamation plans <input type="checkbox"/> Roadway sections <input type="checkbox"/> Plans/profiles <input type="checkbox"/> Utility <input type="checkbox"/> Structure notes <input type="checkbox"/> Signing <input type="checkbox"/> Illumination <input type="checkbox"/> Bridge plans <input type="checkbox"/> Traffic control plans <input type="checkbox"/> Detour plans <input type="checkbox"/> Standard plans <input type="checkbox"/> Sheets numbered and dated <input type="checkbox"/> Each sheet signed and stamped by Professional Engineer <input type="checkbox"/> Bridge plans, design calculations, and soil report to Region Local Programs Engineer (State Ad and Award only) <input type="checkbox"/> Form FHWA-1273 and latest amendment included <input type="checkbox"/> Log of test borings <input type="checkbox"/> Training requirements <input type="checkbox"/> EEO requirement clauses <input type="checkbox"/> For steel, included Buy America requirement <input type="checkbox"/> Traffic control special provisions <input type="checkbox"/> Specialty items <input type="checkbox"/> General special provisions and amendments arranged in order and indexed <input type="checkbox"/> Project proposal <input type="checkbox"/> Noncollusion Declaration <input type="checkbox"/> Contract <input type="checkbox"/> DBE Utilization Certification <input type="checkbox"/> Engineer's estimate complete

		PS&E completed: (continued) <input type="checkbox"/> DBE Utilization Certification <input type="checkbox"/> Engineer's estimate complete <input type="checkbox"/> Documentation for each item in engineer's estimate <input type="checkbox"/> Justification for nonparticipating items <input type="checkbox"/> Detailed documentation for lump sum items available in project files <input type="checkbox"/> Estimate to Region Local Programs Engineer <input type="checkbox"/> Training goal set by Local Programs <input type="checkbox"/> DBE goal set by Local Programs <input type="checkbox"/> Approval of local agency supplied materials <input type="checkbox"/> Sources approved by approving authority <input type="checkbox"/> Approval of stockpiling by the Director, Local Programs (when payment is requested for material when stockpiling aggregates, etc., for use on a future federal aid project) <input type="checkbox"/> Distribution of preliminary plans as determined by local agency
		Field review of PS&E (State Ad and Award only)
		Tied bids – Approval from WSDOT
		For State Ad and Award, financial responsibility letter with PS&E documents sent to Region Local Programs Engineer
		PS&E approved by approving authority
		Plans, contract specifications and estimate stamped, signed, and dated, and on file in the local agency office
		State and federal wage rates added to ad plans
		PS&E sent to Region Local Programs Engineer

Date or N/A	
	Project in STIP
	Send letter with the following attachments to Region Local Programs Engineer requesting construction funds: <input type="checkbox"/> Supplement to Local Agency Agreement, if project includes other phases <input type="checkbox"/> Letter of right of way certification <input type="checkbox"/> Final FHWA approval of environmental documents

	Get Local Programs Contract Number _____ from Region Local Programs Engineer
	Approve ad period of less than three weeks
	Publish notice of bid opening
	Date of publication for sealed bids

	Issued addendum (if within one week of bid opening, bid opening should be delayed)
	Opened bids
	Prepared bid tabulation sheet
	Checked submitted bids for tabulation errors
	Completed bid and bidders tabulation sheet
	Checked DBE participation project goals – verify DBE certification status
	Request DBE concurrence to award from Local Programs for contracts containing DBE Goals
	Determine responsive bid
	Determine contractor qualifications
	Contractor registered by Washington State Department of Labor and Industries
	Contractor licensed as required by the laws of the State of Washington

		The System for Award Management (SAM) has been checked and documented (www.sam.gov/portal/public/sam)
		Award recommendation sent to approving authority
		When low bid is over engineer's estimate, submit justification and letter of award recommendation to approving authority
		Submit supplement to Local Agency Agreement
		Supplement approved by Local Programs

		Establish contract award date _____
		Sent "Award Letter" to successful low bidder
		Sent request for a DBE Utilization Certification breakdown if a DBE goal was set
		Sent "Condition of Award" to successful low bidder if DBE goals are set in the contract
		Notify all unsuccessful bidders
		Return bid bonds
		Notify second and third bidders of holding bid bonds until execution
		Sent award data to the Region Local Programs Engineer: <ul style="list-style-type: none"> <input type="checkbox"/> Tabulation of bids <input type="checkbox"/> Engineer's estimate <input type="checkbox"/> Actual versus estimated costs shown in Local Agency Agreement <input type="checkbox"/> Award letter <input type="checkbox"/> DBE Utilization Certification, DOT Form 272-056A (if applicable) <input type="checkbox"/> DBE Written Confirmation Document, DOT Form 422-031 (if applicable) <input type="checkbox"/> Estimated date of contract completion or number of working days for the contract <input type="checkbox"/> Names and addresses of all firms that submitted a quote to the successful low bidder

Date of Award is Cutoff for Charging to Preliminary Engineering

		Sent contract and contract bond papers to contractor for signature
		"Certificate of Insurance" received from contractor
		Approving authority executed contract documents
		Notified the contractor by phone of the execution of the contract
		Executed a copy of the contract to contractor
		Sent notice to proceed to contractor, with cc to Region Local Programs Engineer
		Returned bid bonds to second and third bidders

		Notice of preconstruction conference to: <ul style="list-style-type: none"> <input type="checkbox"/> Contractor <input type="checkbox"/> Region Local Programs Engineer <input type="checkbox"/> Affected utility companies <input type="checkbox"/> Police department <input type="checkbox"/> Fire department <input type="checkbox"/> Hospital <input type="checkbox"/> Ambulance service <input type="checkbox"/> Post Office <input type="checkbox"/> Others _____ <input type="checkbox"/> _____ <input type="checkbox"/> _____
		Preconstruction conference agenda prepared
		Preconstruction conference held

		Minutes of meeting to: <input type="checkbox"/> Contractor <input type="checkbox"/> Subcontractors <input type="checkbox"/> Region Local Programs Engineer <input type="checkbox"/> Other attending persons <input type="checkbox"/> Invited but not represented agencies <input type="checkbox"/> Project file
		"Training Program": <input type="checkbox"/> Received from contractor <input type="checkbox"/> Approved by agency
		"Apprentice/Trainee": <input type="checkbox"/> Approval request from contractor <input type="checkbox"/> Approved by agency

		"Record of Material" received from WSDOT Materials Laboratory
		Contractor provides copies of permits obtained from other agencies and/or property owners: <input type="checkbox"/> Washington State Department of Wildlife/Fisheries-Hydraulic Permit <input type="checkbox"/> Washington State Department of Ecology <input type="checkbox"/> Irrigation Regionals <input type="checkbox"/> Burlington Northern Railroad <input type="checkbox"/> Union Pacific Railroad <input type="checkbox"/> Air Pollution Control Authority <input type="checkbox"/> _____ <input type="checkbox"/> _____ <input type="checkbox"/> _____
		Temporary water pollution control plan approved
		Agency requests updated ESA species listing every six months
		Approved contractor's progress schedule
		Received railroad insurance from contractor
		Construction diary started
		Inspector's diary started
		"Certification of Materials Origin" received from contractor
		Material source approval received
		Plans for falsework and forms: <input type="checkbox"/> Received from contractor <input type="checkbox"/> Approved by agency
		Required job site posters placed by contractor: <input type="checkbox"/> WH 1321 – Employee Rights Under the Davis-Bacon Act (project engineer to fill in contact information on the form prior to supplying to the contractor) <input type="checkbox"/> FHWA-1022 – Notice Federal Aid Project (project engineer to fill in contact information on the form prior to supplying to the contractor) <input type="checkbox"/> EEOC-P/E-1 – Equal Employment Opportunity IS THE Law <input type="checkbox"/> WHD Publication 1088 – Employee Rights Under the Fair Labor Standards Act <input type="checkbox"/> WHD Publication 1420 – Employee Rights and Responsibilities Under the Family and Medical Leave Act <input type="checkbox"/> WHD 1462 – Employee Polygraph Protection Act <input type="checkbox"/> WISHA F416-081-909 – Job Safety and Health Law <input type="checkbox"/> F242-191-909 – Notice to Employees (L&I) <input type="checkbox"/> F700-074-909 – Your Rights as a Worker in Washington State <input type="checkbox"/> EMS 9874 – Unemployment Benefits
		Daily construction signing records started (checked twice daily and recorded)
		Weekly statement of working days started
		Material acceptance sampler appointed

		Material independent assurance sampler appointed
		Appointed office engineer for progress estimates and final records
		Obtain a copy of the scale certifications
		Daily scale check
		Received FHWA Form 1391 for each July from contractor and subcontractors
		FHWA Form 1392 prepared and sent to Region Local Programs
		Received "Request to Sublet Work" and "Subcontractor or Agent Certification" from contractor
		Approved request to sublet (subject to 70 percent limit)
		Received "Intent to Pay Prevailing Wages" from contractor, subcontractors, and agents
		Received approved "Intent to Pay Prevailing Wages" from Labor and Industries (required before first payment)
		Checked first certified payroll from contractor and subcontractors to ensure payment of prevailing wages
		Conducted random check of each successive payroll
		Wage rate interviews conducted
		Checked employee interview wage rate against certified payroll and Labor and Industries approved prevailing rate
		Assigned Change Order Numbers _____ (Local Programs approval required when change order will alter the termini, character, or scope of work. Approval must be obtained before effective date of change order to be eligible for federal participation.) <input type="checkbox"/> Prepare change order that details basis and need for the change <input type="checkbox"/> Extension of time approved _____ days <input type="checkbox"/> Change order signed by contractor <input type="checkbox"/> Change order signed by surety (if required) <input type="checkbox"/> Verbal approval obtained from approving authority <input type="checkbox"/> Signed by approving authority <input type="checkbox"/> Original sent to contractor <input type="checkbox"/> Copy of approved change order sent to Region Local Programs Engineer <input type="checkbox"/> Supplement to Local Agency Agreement approved by the Director, Local Programs
		Obtained copy of monthly estimate <input type="checkbox"/> Verified and documented that DBE is performing a commercially useful function prior to making a monthly payment <input type="checkbox"/> Prepared estimate <input type="checkbox"/> Checked estimate <input type="checkbox"/> Estimate sent to contractor <input type="checkbox"/> Estimate received from contractor <input type="checkbox"/> Obtain all "Intent to Pay Prevailing Wages" forms (for first month only; no payment can be made to the contractor until the form is received)
		Overview of DBE Work (Chapter 26): <input type="checkbox"/> Verify work being done per Condition of Award Letter <input type="checkbox"/> Conduct on-site review(s) of each DBE to determine if the DBE is performing a commercially useful function (CUF) <input type="checkbox"/> Review change orders that affected DBE work <input type="checkbox"/> DBE goal change approved by the Director, Local Programs
		Overview of EEO (Chapter 27): <input type="checkbox"/> Agency designates an EEO officer <input type="checkbox"/> Conduct on-site compliance review <input type="checkbox"/> Monitor DOT Form 820-010 each month for each trade <input type="checkbox"/> Notify contractor of compliance or noncompliance with the contract provisions <input type="checkbox"/> Ensure EEO signs are posted

Initials	Date or N/A	Project Completion (Chapter 52)
		Prefinal inspection by local agency and contractor completed
		Final inspection by local construction agency and contractor completed
		Report of Non-American Made Material (GSP 0605.GR1) received from contractor
		Notice of completion sent to contractor
		Extension of time request with justification received from contractor
		Extension of time granted, _____ days
		Extension of time refused, _____ days
		_____ liquidated damages
		Letter sent notifying contractor of assessed liquidated damages
		Copy of completion notice requesting inspection and acceptance by Region
		Local Programs
		Contractor submitted claim
		No claim submitted
		Notice of completion to: _____
		Department of Labor and Industries
		Department of Revenue
		Received "Affidavit of Wages Paid" from contractor and subcontractors
		Received ESA species listing for the project every six months
		Received "Monthly Report of Amounts Credited as DBE Participation" from contractor
		Release received from Department of Labor and Industries
		Release received from Department of Revenue
		Comparison of preliminary and final quantities sent to approving authority
		Material certification form sent to approving authority
		Completed "Report of Contractor's Performance" for prime contractor
		As built plan completed (to be retained indefinitely)
		Final record book #1 completed
		Final estimate approved by the approving authority
		Final estimate received from contractor
		Paid final estimate
		Released retained percentage from escrow or mailed check to contractor

Initials	Date or N/A	Project Closure (Chapters 32 and 53)
		Completion letter sent to Region Local Programs Engineer (within 15 days after project is completed)
		Final billing sent to Region Local Programs Engineer (within 90 days after completion)
		Completed final field inspection by the Region Local Programs Engineer. Deficiencies (if any) will be noted on DOT Form 140-500.
		Resolve deficiencies found during the above field inspection
		Informed by Region Local Programs Engineer of WSDOT final billing approval

Chapter 21 *The Project Prospectus*

21.1 **General Discussion**

The Project Prospectus is the description of the proposed improvement which serves as the support document for Federal Highway Administration (FHWA) authorization of federal funds. The prospectus also provides a schedule which tells when the local agency anticipates obligating federal funds.

The Project Prospectus is one of the main items contained in the project authorization package discussed in this chapter. Other items in this package include the Local Agency Agreement ([Chapter 22](#)) and the items of supporting data listed in the Prospectus Submittal Checklist (DOT [Form 140-553](#)).

21.2 **Procedure for Submitting the Planning Authorization Package**

Local agencies must submit the following to the Region Local Programs Engineer for authorization:

- One copy of the completed Federal Aid Project Prospectus Planning Scope of Work.
- Original and one copy of the Local Agency Agreement signed by the approving authority ([Chapter 22](#)).
- Documented cost estimate ([Chapter 22](#)).
- STIP documentation.
- Vicinity map, if applicable.

21.3 **Procedure for Compiling the Project Authorization Package**

Local agencies must submit the following to the Region Local Programs Engineer for authorization:

- Prospectus Submittal Checklist.
- Original of the completed Project Prospectus.
- Original and one copy of the Local Agency Agreement signed by the approving authority ([Chapter 22](#)).
- Documented cost estimate ([Chapter 22](#)).
- Supporting data listed in the Prospectus Submittal Checklist (DOT [Form 140-553](#)).
- Original of the Environmental Classification Summary Form ([Chapter 24](#)).

A given project may not require all of the items in the checklist; however, the local agency must include all items that are relevant. Identify those items included with an “x” in the right column of the checklist. Many of the items listed in the checklist take place during the course of project development and are not complete at the time the prospectus is submitted. An agency may note such items on the checklist and submit them when they are completed. The latest point at which each item may be submitted is noted in [Appendix 21.42](#) describing the item in detail.

Incomplete, incorrect, or missing items will delay project authorization.

The first item in the project authorization package is the checklist.

The next item is the three-page Federal Aid Project Prospectus itself, which must be filled out with the current project information. The Federal Aid Project Prospectus is used for FHWA federal aid programming purposes along with providing the state and FHWA needed information about the proposed project, such as design and accident data. [Appendix 21.44](#) contains instructions for completing the prospectus. Agency codes and numbers are provided in Appendices [21.45](#) and [21.46](#).

21.4 Forms and Appendices

- [140-101](#) Local Agency Federal Aid Project Prospectus
- [140-553](#) Prospectus Submittal Checklist
- [21.40](#) Federal-Aid Prospectus Planning Scope of Work
- [21.41](#) Vacant
- [21.42](#) Project Authorization Transmittal Items – Instructions
- [21.43](#) Authorization Package Checklist
- [21.44](#) Project Prospectus – Instructions
- [21.45](#) County Code and WSDOT Region Numbers
- [21.46](#) City Code Numbers
- [21.47](#) Vacant
- [21.48](#) Vacant
- [21.49](#) Puget Sound Legislative Districts
- [21.50](#) Statewide Legislative Districts
- [21.51](#) Washington State Congressional Districts

21.5 Forms

Federal-Aid Project Prospectus Planning Scope of Work

Appendix 21.41 Vacant

Appendix 21.42 Project Authorization Transmittal Items – Instructions

The authorization package shall include:

1. **Authorization Package Checklist** – This checklist provides a summarized list of project elements and approvals that, when missing or unclear, can delay the authorization process. This checklist is required to be filled out and submitted with all authorization packages. Errors, inconsistencies, or missing items noted via the checklist must be corrected or appropriately addressed prior to submittal of authorization package.
2. **Project Prospectus** – (Attach completed prospectus submittal checklist.) To be included with original submittal, at time of construction phase authorization, and whenever there is a change in the scope of work, termini, right of way, or environmental classification. For planning projects, use the Project Prospectus Planning Scope of Work.

To ensure utility and railroad work is adequately addressed ([23 CFR 635.309\(b\)](#)) local agencies are required to provide an updated, signed project prospectus at the time construction phase authorization is requested.

3. **Vicinity Map** – A vicinity map of the project with the termini clearly marked must be submitted with the Project Prospectus. The map should be 8.5 inches (212.5 mm) by 11 inches (275 mm), and of a scale such that a reviewer can identify the project area in the field. Show the agency name, project title, project termini, north arrow, map scale, and nearest city or distance to the nearest city/town, or major road intersection.
4. **Typical Roadway or Pathway Section** – Attach a sketch of the proposed roadway or pathway section showing all data pertaining to the section, including side slopes and limits of right of way. Also indicate stationing and note any variations of the section throughout the stationing. If the design does not conform to the design standards (see Section 41.6), a request for deviation from these standards with complete justification is required.
5. **Typical Bridge Section (if necessary)** – Attach a sketch of the proposed bridge section showing all dimensions and type of construction and Structure ID #.

On bridge projects where approaches are to be included in the contract, include roadway section and length of the approaches. In cases where the structure consists of a main span and approach spans, the length of the approach spans should be indicated, if known.
6. **Local Agency Agreement** – This agreement is necessary on all projects. It must be submitted with the Project Prospectus. See [Chapter 22](#) for instructions on completing the agreement.
7. **Documented Cost Estimate** – All funds shown on the Local Agency Agreement must be supported by a documented cost estimate that is based on an agency's best estimate of cost. See [Chapter 22](#) for further explanation.

8. **STIP Documentation** – Attach copy of the page of the current STIP that shows your project.
9. **Design Matrix Checklist** – See [Appendix 42.101](#).
10. **Photos** – As required for ER sites and Railroad Crossings.
11. **Deviation Request** – See [Appendix 41.51](#).
12. **Environmental Considerations** – See [Chapter 24](#).
13. **Right of Way Requirements**
 - a. No right of way needed. Mark appropriate box on prospectus. This serves as the agency's right of way certification.
 - b. Right of way needed. Mark appropriate box on prospectus and refer to [Chapter 25](#) for further instructions.

Note: Right of Way is required if the project cannot be constructed within the pre-project right of way limits. This includes property rights whether temporary or permanent are needed to construct, operate and maintain the proposed project including any early/advanced acquisition. For assistance in determining whether or not ROW is needed refer to [Appendix 25.174](#).
14. **Right of Way Certification** – Required on all projects where right of way was acquired. Refer to [Chapter 25](#) for further explanation.
15. **Agreements/Easements With Railroads** – Refer to [Chapter 32](#) for instructions.
16. **Location and Design Approval** – For most projects, the Project Prospectus along with the data satisfying items 1 to 14 of this transmittal pavement design criteria and geometric design will be considered sufficient for the location and design report. For complicated projects requiring a more detailed location and design report, refer to [Chapter 43](#).
17. **Tied Bids** – If the project has tied bids (see [Chapter 44](#)), indicate the approval date. If the project is tied to another federally funded project, include the federal aid project number of the project, along with other information outlined in Section 44.

Local Programs Authorization Package Checklist

Agency: _____
 Project Title: _____
 Fed Aid/State Project #: _____

Funding Request	By Phase (check all that apply)				Non-Funding Request <input type="checkbox"/>
	PL*	PE**	RW	CN	
New Phase Authorization	<input type="checkbox"/>	<input type="checkbox"/>	<input type="checkbox"/>	<input type="checkbox"/>	
Phase Modification	<input type="checkbox"/>	<input type="checkbox"/>	<input type="checkbox"/>	<input type="checkbox"/>	

*PL - Planning. Used for stand-alone planning and study projects.
 **PE - Preliminary Engineering. This is the full design phase of a construction project. Once PE is authorized, the construction phase must be completed, or all federal expenditures must be repaid.

	Agency	Region	HQ
	Check	Check	Check
Miscellaneous Items	<input type="checkbox"/>	<input type="checkbox"/>	<input type="checkbox"/>

In addition to this checklist, all Region submittals must utilize the standard Region IDC, memo, or cover letter.
 If authorizing a subsequent phase on an existing project, has at least one bill for the prior phase been fully processed by Local Programs (Posted date is present in SPORT)? If not, supplement can't be processed.
 Has the scope changed (description of work, limits, staging, RW needs, etc.) since previous submittal? Y / N Y / N Y / N

Project Prospectus (DOT Form 140-101) - LAG Chapter 21

Are all three pages of the current form included?
 Does information (title, termini, description, RW needs, cost, etc.) agree with STIP/LAA/NEPA-CE?
 Is the project description written such that the project scope is clear to an average person?
 Are pages 1 and 3 signed?
 If the LPE or another agency is acting as CA, enter CA agency name below and include copy of CA agreement (LOU, MOU, etc).
 CA Agency: _____
 Are the Latitude and Longitudes (decimal format preferred) included and correct?
 Are Congressional and Legislative Districts included and correct?
 Project Zip Code includes the +4?
 Are estimated costs included for all phases of the project?
 Are the Functional Classification and Urban/Rural designation correct?
 Are the Right of Way, Utilities, and Railroad sections filled out?

Typical Sections & Vicinity Map - LAG Chapter 21

When necessary, are the Vicinity Map(s) and Roadway Section(s) included?
 Can someone unfamiliar with the project's location easily tell where it's located using the vicinity map?
 Are the project limits clearly marked on the map?
 Does the section include all elements, with dimensions, of the roadway prism?
 Are section changes, if applicable, throughout the project limits noted/displayed?

STIP/Funding Documentation - LAG Chapter 12

Is the currently approved STIP page included?
 Does STIP information (termini, description, etc.) match the LAA and Prospectus?
 Is the phase being authorized (or a later phase) programmed in the STIP?
 Is funding from all requested programs shown in the STIP?
 Are the requested funds supported by the STIP?
 If funded through a HQ managed program (ex. Bridge, HSIP), is the award letter included when these funds are first obligated?
 If funded through a HQ managed program, does the submitted scope match the project summary scope?

Local Agency Agreement (DOT Forms 140-039 & 140-041) - LAG Chapter 22

Is at least one LAA or LAA supplement, with an original signature, included?
 Current form used? (check revision date at bottom left)
 All pages of Agreement included?
 Are the Agency information, Project #, LAA #, Supplement #, and date of original agreement execution correct?
 Does project information (title, termini, length, description, etc.) agree with STIP/Prospectus/NEPA-CE?

Local Programs Authorization Package Checklist

	Agency	Region	HQ
Local Agency Agreement (DOT Forms 140-039 & 140-041) - LAG Chapter 22 [CONT.]	<input type="checkbox"/>	<input type="checkbox"/>	<input type="checkbox"/>
Is the reason for supplement accurate and up to date?			
Is the Project Agreement End Date (month, day, and year) included? Does it follow LAG guidance?			
When not authorizing a new phase, is the end date the same as shown on the previous agreement?			
If not, is adequate justification (see LAG 22.3) included to support changing the end date?			
Is the Advertisement Date (month, day, and year) included? Is it within 6 weeks of estimated CN authorization?			
If the ICR box is checked 'Yes', is the agency's current approved/self-certified rate documentation provided? It must clearly show a single rate to be used, the timeframe it covers, and the actual signature of approval/self-certification.			
If corrections made, are they initialed? If made by WSDOT is permission from Agency provided?			
Are all federal aid participation ratios being used listed?			
If de-obligating funds on any line, does it reduce obligation below expenditures?			
Are amounts calculated correctly and shown in the correct columns?			
Documented Cost Estimate - LAG 22.4 and Appendix 22.56	<input type="checkbox"/>	<input type="checkbox"/>	<input type="checkbox"/>
Is a Documented Cost Estimate included for each phase requesting/changing funds?			
Are total dollars on the LAA supported by the phase estimates?			
Does the estimate sufficiently demonstrate how the costs were determined?			
Right of Way - LAG Chapter 25	<input type="checkbox"/>	<input type="checkbox"/>	<input type="checkbox"/>
If authorizing RW, is a true cost estimate summary sheet included?			
Does the true cost estimate summary sheet support RW amounts shown on the LAA?			
If authorizing RW and Relocation is required, is the signature page of the approved Relocation Plan included?			
If authorizing CN, is the Local Programs approved RW Certification included?			
If RW acquired under the Government Acquisitions Provision, is approval documentation included?			
Environmental Documentation/Approval (NEPA) - LAG Chapter 24	<input type="checkbox"/>	<input type="checkbox"/>	<input type="checkbox"/>
Is an approved NEPA package (at least signature page) included?			
Does the description of work match the Prospectus/LAA/STIP?			
Is the footprint of the project within the limits of the NEPA approval?			
Do the NEPA-CE Part 3 RW responses agree with the STIP and Prospectus?			
Is the approval date within the last 3 years?			
If approval is older than 3 years, has the approval been re-evaluated by the environmental engineer?			
DBE Goals (LAG Chapter 26) - Tied Bid (LAG Chapter 44) - Local Forces (LAG Chapter 61)	<input type="checkbox"/>	<input type="checkbox"/>	<input type="checkbox"/>
If authorizing construction, is the DBE goal letter/e-mail included, or are the goals in SPORT?			
If construction includes a tied bid project, is the approved PIF included or noted in SPORT?			
If construction by Local Forces, is the approved PIF included or noted in SPORT?			

PROJECT NOTES (Provide additional information or explanation as necessary)

Appendix 21.44 Project Prospectus – Instructions

Federal Aid Project Number

Code the PREFIX and ROUTE number as outlined below:
(Do not fill in () to be used by WSDOT)

Prefix Code	Description
STPUL	Surface Transportation Block Grant (STBG) Urbanized Funds, population greater than 200,000 (Seattle/Tacoma, Spokane, Vancouver, Kennewick/Pasco)
STPUS	STBG Urban Funds, population from 5,001 to 200,000
STPR	STBG Rural Funds, population of 5,000 or less
HIPUL	Highway Infrastructure Program (HIP) Urbanized Funds, population greater than 200,000 (Seattle/Tacoma, Spokane, Vancouver, Kennewick/Pasco)
HIPUS	HIP Urban Funds, population from 5,001 to 200,000
HIPR	HIP Rural Funds, population of 5,000 or less
CM	Congestion Mitigation/Air Quality Program
RAIL	Safety program, elimination or protection of rail-highway hazards
HSIP	Safety program, hazard elimination program
BRS	Bridge replacement project on federal aid system in rural area, financed by Bridge Program
BHS	Bridge rehabilitation project on federal aid system in rural area, financed by Bridge Program
BRM	Bridge replacement project on federal aid system in urban areas, financed by Bridge Program
BHM	Bridge rehabilitation project on federal aid system in urban areas, financed by Bridge Program
BROS	Bridge replacement project not on the federal aid system, financed by Bridge Program
BHOS	Bridge rehabilitation project not on the federal aid system, financed by Bridge Program
ER	Project financed with Emergency Relief Funds
TAP	STBG Set-Aside (Transportation Alternatives) Funds

Route Code Description	Federal Aid Project Route Number	
	Single Route	Multiple Routes
STPUS/STPUL HIPUS/HIPUL	4-digit federal route number	Number is 99 followed by county number
STPR HIPR	4-digit federal route number	Number is Z9 followed by county number
HSIP	4-digit federal route number	Number is 000S
CM On-System	4-digit federal route number	Number is 99 followed by county number
CM Off-System	Use off-system rules	Same as single routes
TAP On-System (urbanized areas)	4-digit federal route number	Number is 99 followed by county number
TAP On-System (rural)	4-digit federal route number	Number is Z9 followed by county number
TAP Off-System	Use off-system rules	Same as single routes
RAIL On-System	4-digit federal route number	N/A
RAIL Off-System	Use off-system rules	N/A
ER	4-digit FHWA Disaster Number	Same as single routes
BRS/BHS	4-digit federal route number	Number is Z9 followed by county number
BRM/BHM	4-digit federal route number	Number is 99 followed by county number
BROS/BHOS	Use off-system rules	Same as single routes
Off-System County	Number is 20 followed by county number	Same as single routes
Off-System City	Number is city number	Same as single routes

Date	Date that form is filled out.
Federal Aid Project Number	Number assigned by Local Programs to each federal aid project.
DUNS#	Required. Enter your agency's Dun & Bradstreet provided DUNS number.
Local Agency Project Number	Alpha/numeric characters that your agency identifies.
Federal Employer Tax ID Number	Required. Indicate the agency's tax identification number.
Agency	Required. This is your agency's name.
CA agency	Check Yes or No as applicable.
Federal Program Title	Check 20.205 Highway Planning and Construction or Other Most local agency projects are 20.205.
Project Title	Write the project's title, as shown in TIP/STIP.
Project Latitude and Longitude	Enter the project start and end latitude and longitude in decimal format: Latitude N XX.XXXX Longitude W XXX.XXXX
Project Termini	Indicate the beginning and ending limits of the section to be improved. For railway/highway grade crossing projects, show the name of the railroad involved. For intersection projects write the name of the crossroad.
City Name	Name of the nearest city to where the work is to be performed. For projects that span more than one jurisdiction, list the city where most of the work will be done.
ZIP Code	5 plus 4 digit Zip Code of the location where the majority of the work will be done.
Begin Mile Post	Enter the beginning MP.
End Mile Post	Enter the ending MP.
Length of Project	Project length in miles.
Award Type	Mark the appropriate type.
City Number	For a city project, enter the city number from Appendix 21.46.
County Number	Enter the county number from Appendix 21.45.
County Name	Enter the county name in which the project is located.
WSDOT Region	Enter the WSDOT region abbreviation from Appendix 21.45 or 21.46.
Legislative District	Enter the legislative district(s) in which the project is located.
Congressional District	Enter the congressional district(s) in which the project is located.
Total Estimated Cost	Required for each phase of the project; estimate to the nearest hundred dollars.

Local Agency Funding	Required for each phase of the project; estimate to the nearest hundred dollars.
Federal Funds	Required for each phase of the project; estimate to the nearest hundred dollars.
Phase Start Date	Enter the month and year for each phase's expected authorization date.
Description of Existing Facility	Enter a description of the existing facility that includes an explanation of any substandard existing alignment and grade or other project deficiencies.
Description of Proposed Work	Enter a description of the proposed improvements. Indicate the major work elements involved, such as roadway reconstruction, bridge replacement, sidewalk construction, etc.
Local Agency Contact Person	Name and contact information for agency employee to be contacted in case of questions.
Project Prospectus Approval	<p>The project prospectus will be reviewed and approved by the agency. If the agency has CA status the designated authority per the CA agreement on file will sign the form. If the lead agency does not have CA status, either the Region Local Programs Engineer or another CA agency must also review the prospectus. All federal projects must be administered by or under the authority of a CA agency. When an entity other than the submitting agency is acting as the CA, a CA agreement (LOU, MOU, etc.) between the two must be included with the prospectus.</p> <p>The agency shall submit a revised project prospectus at construction phase authorization and any time the project termini, scope, right of way, or environmental classification is revised or modified.</p>
Type of Proposed Work	Check whether the project is new construction, 3-R, 2-R, etc., as described in Chapter 42 . Enter the Roadway Width and Number of Lanes for the proposed facility.
Geometric Design Data	Refer to design report data and/or Chapter 42 .
Performance of Work	<p>PE: Indicate who will be performing the work and the percentage of the work they will do.</p> <p>CN: Indicate if work is to be done by contract and/or local forces and the percentage to be done by each.</p>

Environmental Classification

Mark the appropriate NEPA class of the project as defined in [Chapter 24](#).

Class I, if the nature of the proposed improvement is likely to have a significant impact on the environment and an “Environmental Impact Statement” (EIS) is required. Check the box pertaining to the NEPA/SEPA/Section 404 Interagency Agreement if the project requires an individual permit from the U.S. Corps of Engineers.*

Class II, if the project is not expected to have a significant impact on the environment and a “Categorical Exclusion” (CE) is determined. Completion of the Environmental Classification Summary (ESC) is required.*

Class III, when the significance of the impact on the environment is not clearly established and an “Environmental Assessment” (EA) will be required. Check the box pertaining to the NEPA/SEPA/Section 404 Interagency Agreement if the project requires an individual permit from the U.S. Corps of Engineers.*

*This includes a biological assessment effect determination for each project.

Environmental Considerations

If the box for either a Class I or Class III category action is checked under the Environmental Classification section, make reference to the enclosed Environmental Classification Summary Form marked preliminary. If the project is a Class II “Projects That Require Documentation and FHWA Approval,” make reference to the enclosed Environmental Classification Summary Form, if available at this time, or in a brief narrative, describe the environmental impact of the proposed project.

Right of Way Requirements

- a. No Right of Way Needed. Check this box when the project can be accomplished within the existing right of way.
- b. Right of Way Needed. Check this box when the project requires additional right of way. In addition, check the applicable Relocation box.

Refer to Appendix 25.174 for assistance in determining whether or not Right of Way is needed.

Utility Statement

Check the box next to the statement that best fits your project.

Railroad Statement

Check the box next to the statement that best fits your project.

Description of Utility Relocation or Adjustments and Existing Major Structures Involved

Indicate the agency responsible for any relocation and/or

- a. Indicate the entity or entities responsible for any relocation and/or adjustments.
- b. Existing utilities - type of utility, publicly or privately owned, and any other pertinent information.
- c. Existing major structures – number, year built, overall length and conditions, roadway width, estimated or posted capacity, and proposed treatment of any substandard structures to remain in place.

Appendix 21.45**County Code and WSDOT Region Numbers**

County Name	WSDOT Region	County Code Number
Adams	EAST	01
Asotin	SC	02
Benton	SC	03
Chelan	NC	04
Clallam	OLY	05
Clark	SW	06
Columbia	SC	07
Cowlitz	SW	08
Douglas	NC	09
Ferry	EAST	10
Franklin	SC	11
Garfield	SC	12
Grant	NC	13
Grays Harbor	OLY	14
Island	NW	15
Jefferson	OLY	16
King	NW	17
Kitsap	OLY	18
Kittitas	SC	19
Klickitat	SW	20
Lewis	SW	21
Lincoln	EAST	22
Mason	OLY	23
Okanogan	NC	24
Pacific	SW	25
Pend Oreille	EAST	26
Pierce	OLY	27
San Juan	NW	28
Skagit	NW	29
Skamania	SW	30
Snohomish	NW	31
Spokane	EAST	32
Stevens	EAST	33
Thurston	OLY	34
Wahkiakum	SW	35
Walla Walla	SC	36
Whatcom	NW	37
Whitman	EAST	38
Yakima	SC	39

Appendix 21.46

City Code Numbers

City	County Code Number	WSDOT Region	City Code Number
Aberdeen	14	OLY	0005
Airway Heights	32	EAST	0010
Albion	38	EAST	0015
Algona	17	NW	0020
Almira	22	EAST	0025
Anacortes	29	NW	0030
Arlington	31	NW	0045
Asotin	02	SC	0050
Auburn	17	NW	0055
Bainbridge Island	18	OLY	0058
Battleground	06	SW	0060
Beaux Arts	17	NW	0070
Bellevue	17	NW	0075
Bellingham	37	NW	0080
Benton City	03	SC	0085
Bingen	20	SW	0090
Black Diamond	17	NW	0095
Blaine	37	NW	0100
Bonney Lake	27	OLY	0105
Bothell	17, 31	NW	0110
Bremerton	18	OLY	0115
Brewster	24	NC	0120
Bridgeport	09	NC	0125
Brier	31	NW	0127
Buckley	27	OLY	0130
Bucoda	34	OLY	0135
Burien	17	NW	0138
Burlington	29	NW	0140
Camas	06	SW	0145
Carbonado	27	OLY	0150
Carnation	17	NW	0155
Cashmere	04	NC	0165
Castle Rock	08	SW	0170
Cathlamet	35	SW	0175
Centralia	21	SW	0180
Chehalis	21	SW	0190
Chelan	04	NC	0195
Cheney	32	EAST	0200
Chewelah	33	EAST	0205
Clarkston	02	SC	0215
Cle Elum	19	SC	0220
Clyde Hill	17	NW	0225
Colfax	38	EAST	0230
College Place	36	SC	0235
Colton	38	EAST	0240
Colville	33	EAST	0250
Conconully	24	NC	0255
Concrete	29	NW	0260

City	County Code Number	WSDOT Region	City Code Number
Connell	11	SC	0265
Cosmopolis	14	OLY	0270
Coulee City	13	NC	0275
Coulee Dam	24	NC	0280
Coupeville	15	NW	0290
Covington	17	NW	0293
Creston	22	EAST	0295
Cusick	26	EAST	0300
Darrington	31	NW	0305
Davenport	22	EAST	0310
Dayton	07	SC	0315
Deer Park	32	EAST	0320
Des Moines	17	NW	0325
Dupont	27	OLY	0330
Duvall	17	NW	0335
East Wenatchee	09	NC	0350
Eatonville	27	OLY	0360
Edgewood	27	OLY	0362
Edmonds	31	NW	0365
Electric City	13	NC	0375
Ellensburg	19	SC	0380
Elma	14	OLY	0385
Elmer City	24	NC	0390
Endicott	38	EAST	0395
Entiat	04	NC	0405
Enumclaw	17	NW	0410
Ephrata	13	NC	0415
Everett	31	NW	0420
Everson	37	NW	0425
Fairfield	32	EAST	0430
Farmington	38	EAST	0440
Federal Way	17	NW	0443
Ferndale	37	NW	0445
Fife	27	OLY	0450
Fircrest	27	OLY	0455
Forks	05	OLY	0465
Friday Harbor	28	NW	0470
Garfield	38	EAST	0480
George	13	NC	0488
Gig Harbor	27	OLY	0490
Gold Bar	31	NW	0495
Goldendale	20	SW	0500
Grand Coulee	13	NC	0510
Grandview	39	SC	0515
Granger	39	SC	0520
Granite Falls	31	NW	0525

City	County Code Number	WSDOT Region	City Code Number
Hamilton	29	NW	0535
Harrah	39	SC	0540
Harrington	22	EAST	0545
Hartline	13	NC	0550
Hatton	01	EAST	0555
Hoquiam	14	OLY	0560
Hunts Point	17	NW	0570
Ilwaco	25	SW	0575
Index	31	NW	0580
Ione	26	EAST	0585
Issaquah	17	NW	0590
Kahlotus	11	SC	0595
Kalama	08	SW	0600
Kelso	08	SW	0605
Kenmore	17	NW	0609
Kennewick	03	SC	0610
Kent	17	NW	0615
Kettle Falls	33	EAST	0620
Kirkland	17	NW	0625
Kittitas	19	SC	0630
Krupp	13	NC	0635
La Center	06	SW	0640
La Conner	29	NW	0650
La Crosse	38	EAST	0655
Lacey	34	OLY	0643
Lake Forest Park	17	NW	0658
Lake Stevens	31	NW	0660
Lakewood	27	OLY	0665
Lamont	38	EAST	0668
Langley	15	NW	0670
Latah	32	EAST	0675
Leavenworth	04	NC	0680
Lind	01	EAST	0685
Long Beach	25	SW	0690
Longview	08	SW	0695
Lyman	29	NW	0705
Lynden	37	NW	0710
Lynnwood	31	NW	0715
Mabton	39	SC	0725
Malden	38	EAST	0730
Mansfield	09	NC	0735
Maple Valley	17	NW	0739
Marcus	33	EAST	0740
Marysville	31	NW	0745
Mattawa	13	NC	0750
McCleary	34	OLY	0720
Medical Lake	32	EAST	0755
Medina	17	NW	0760
Mercer Island	17	NW	0757
Mesa	11	SC	0765

City	County Code Number	WSDOT Region	City Code Number
Metaline	26	EAST	0770
Metaline Falls	26	EAST	0775
Mill Creek	31	NW	0778
Millwood	32	EAST	0780
Milton	17, 27	OLY	0785
Monroe	31	NW	0790
Montesano	14	OLY	0795
Morton	21	SW	0800
Moses Lake	13	NC	0805
Mossyrock	21	SW	0810
Mount Vernon	29	NW	0820
Mountlake Terrace	31	NW	0815
Moxee City	39	SC	0825
Mukilteo	31	NW	0830
Naches	39	SC	0835
Napavine	21	SW	0840
Nespelem	24	NC	0855
New Castle	17	NW	0858
Newport	26	EAST	0860
Newport Hills	17	NW	0863
Nooksack	37	NW	0865
Normandy Park	17	NW	0870
North Bend	17	NW	0875
North Bonneville	30	SW	0880
Northport	33	EAST	0885
Oak Harbor	15	NW	0895
Oakesdale	38	EAST	0890
Oakville	14	OLY	0900
Ocean Shores	14	OLY	0907
Odessa	22	EAST	0910
Okanogan	24	NC	0915
Olympia	34	OLY	0920
Omak	24	NC	0925
Oroville	24	NC	0935
Orting	27	OLY	0940
Othello	01	NC	0945
Pacific	17	NW	0950
Palouse	38	EAST	0955
Pasco	11	SC	0960
Pateros	24	NC	0970
PeEll	21	SW	0975
Pomeroy	12	SC	0985
Port Angeles	05	OLY	0990
Port Orchard	18	OLY	1000
Port Townsend	16	OLY	1005
Poulsbo	18	OLY	1010
Prescott	36	SC	1015
Prosser	03	SC	1020
Pullman	38	EAST	1025
Puyallup	27	OLY	1030

City	County Code Number	WSDOT Region	City Code Number
Quincy	13	NC	1040
Rainier	34	OLY	1050
Raymond	25	SW	1055
Rearadan	22	EAST	1060
Redmond	17	NW	1065
Renton	17	NW	1070
Republic	10	EAST	1075
Richland	03	SC	1080
Ridgefield	06	SW	1085
Ritzville	01	EAST	1090
Riverside	24	NC	1095
Rock Island	09	NC	1105
Rockford	32	EAST	1100
Rosalia	38	EAST	1115
Roslyn	19	SC	1120
Roy	27	OLY	1125
Royal City	13	NC	1127
Ruston	27	OLY	1130
St. John	38	EAST	1135
Sammammish	17	NW	1136
SeaTac	17	NW	1139
Seattle	17	NW	1140
Sedro Woolley	29	NW	1150
Selah	39	SC	1155
Sequim	05	OLY	1160
Shelton	23	OLY	1165
Shoreline	17	NW	1169
Skykomish	17	NW	1175
Snohomish	31	NW	1180
Snoqualmie	17	NW	1185
Soap Lake	13	NC	1190
South Bend	25	SW	1195
South Cle Elum	19	SC	1205
South Prairie	27	OLY	1210
Spangle	32	EAST	1215
Spokane	32	EAST	1220
Spokane Valley	32	EAST	1223
Sprague	22	EAST	1225
Springdale	33	EAST	1230
Stanwood	31	NW	1235
Starbuck	07	SC	1240
Steilacoom	27	OLY	1245
Stevenson	30	SW	1250
Sultan	31	NW	1255
Sumas	37	NW	1265
Sumner	27	OLY	1270
Sunnyside	39	SC	1275

City	County Code Number	WSDOT Region	City Code Number
Tacoma	27	OLY	1280
Tekoa	38	EAST	1285
Tenino	34	OLY	1290
Tieton	39	SC	1295
Toledo	21	SW	1300
Tonasket	24	NC	1305
Toppenish	39	SC	1310
Tukwila	17	NW	1320
Tumwater	34	OLY	1325
Twisp	24	NC	1330
Union Gap	39	SC	1335
Uniontown	38	EAST	1340
University Place	27	OLY	1343
Vader	21	SW	1345
Vancouver	06	SW	1350
Waitsburg	36	SC	1360
Walla Walla	36	SC	1365
Wapato	39	SC	1375
Warden	13	NC	1380
Washougal	06	SW	1385
Washtucna	01	EAST	1390
Waterville	09	NC	1395
Waverly	32	EAST	1400
Wenatchee	04	NC	1405
West Richland	03	SC	1425
Westport	14	OLY	1420
White Salmon	20	SW	1435
Wilbur	22	EAST	1440
Wilkeson	27	OLY	1445
Wilson Creek	13	NC	1450
Winlock	21	SW	1455
Winslow	18	OLY	1460
Winthrop	24	NC	1465
Woodinville	17	NW	1468
Woodland	08	SW	1470
Woodway	31	NW	1475
Yacolt	06	SW	1480
Yakima	39	SC	1485
Yarrow Point	17	NW	1490
Yelm	34	OLY	1495
Zillah	39	SC	1500

Appendix 21.47 Vacant

Appendix 21.48 Vacant

Appendix 21.49 Puget Sound Legislative Districts

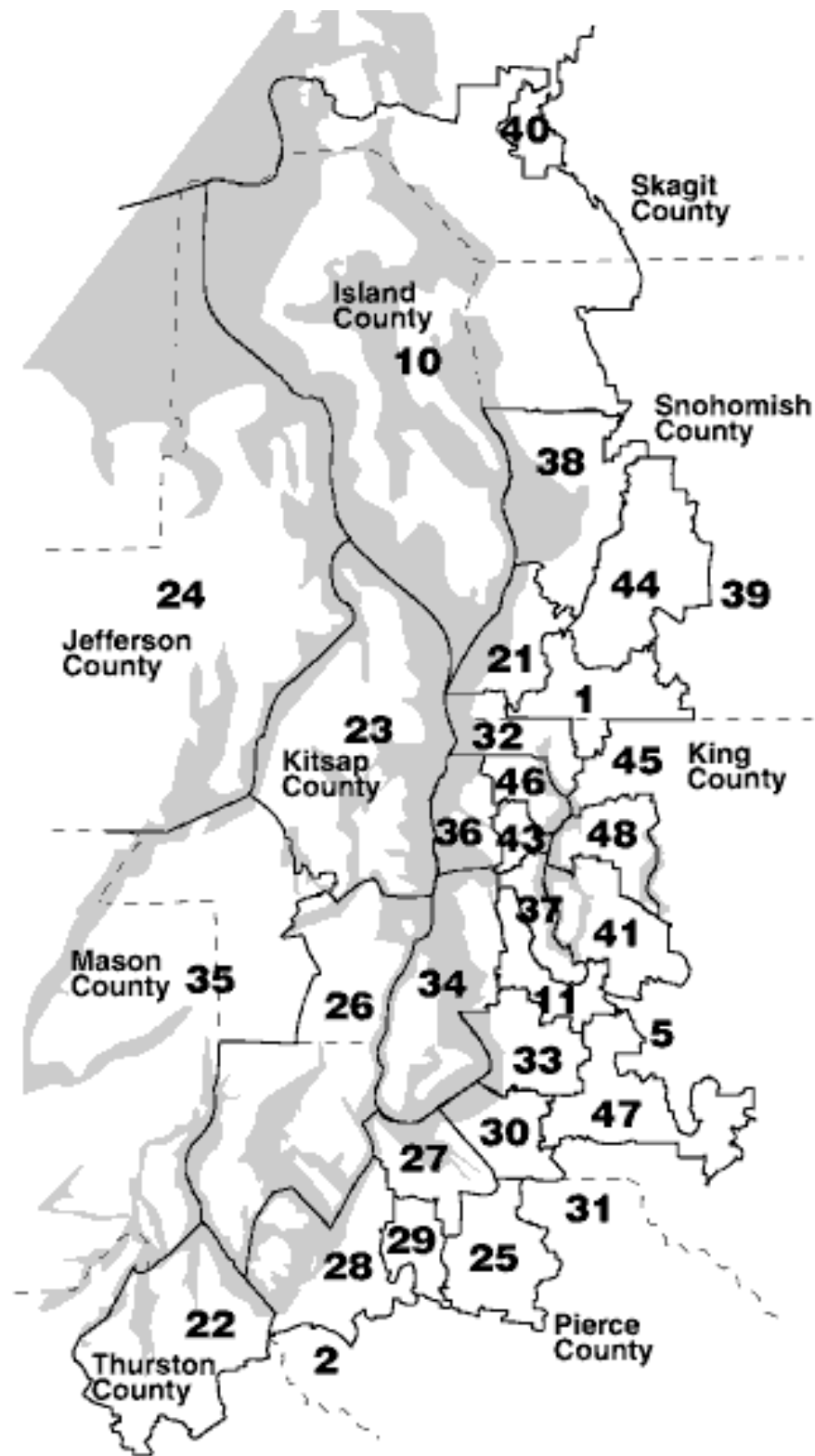

Appendix 21.50 Vacant

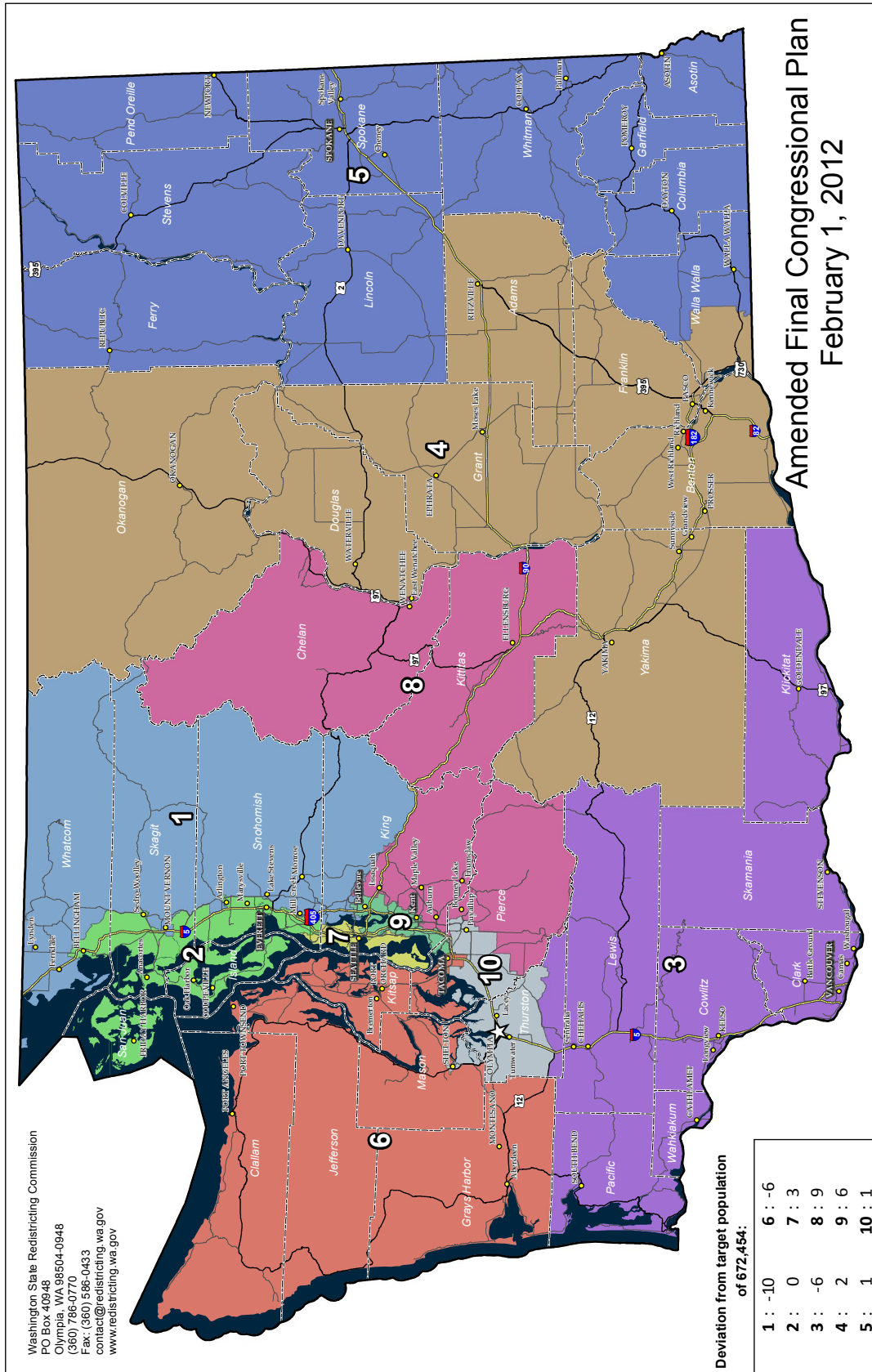



**Federal-Aid Prospectus
Planning Scope of Work**

Agency	Federal Aid Project Number
Project Title	
Federal Funding Program	Amount
Matching Funds	Total Amount
Project Area	
Background	
Type of Study (check all that apply) <input type="checkbox"/> Region <input type="checkbox"/> Area <input type="checkbox"/> Corridor <input type="checkbox"/> Intersection <input type="checkbox"/> Design <input type="checkbox"/> Feasibility <input type="checkbox"/> Modeling <input type="checkbox"/> Other _____	

DOT Form 272-090
Revised 09/2018

Environmental Considerations

TDM/TSM and Transit alternatives to be considered

DOT Form 272-090
Revised 09/2018

Scope of Work

Public Involvement Plan

DOT Form 272-090
Revised 09/2018

Cost Breakdown By Task

Deliverable Final Products

DOT Form 272-090
Revised 09/2018

Land Use Implications

Project Schedule

Project Agreement End Date _____

DOT Form 272-090
Revised 09/2018

Chapter 22 *Local Agency Agreement*

22.1 **General Discussion**

A Local Agency Agreement is an agreement between a local agency and the Washington State Department of Transportation (WSDOT). An agreement is prepared for each federal aid project, and it covers all phases of work involved in the project (preliminary engineering, right of way acquisition, construction). Its purpose is to ensure that the federal funds in the agreed-upon amount are spent in accordance with all applicable state and federal laws and regulations. The agreement also specifies the procedure for payment and reimbursement on the project.

If the federal aid participation ratio entered in the agreement is not the maximum rate allowed by the Federal Highway Administration (FHWA), then the participation ratio entered becomes the maximum rate allowed.

No costs are eligible for federal aid reimbursement until authorized in writing by WSDOT. This authorization is separate from the agreement.

The total cost of a project (including federal, state, agency, and private funds) must be shown on the Local Agency Agreement for each phase of work that includes federal or state funds. At the time of each phase authorization, all funds necessary to complete the scope of work for that phase must be secured.

Project Agreement End Date – All projects are required to have a Period of Performance which includes both a begin date and an end date. A project’s begin date is the date of FHWA authorization. Local agencies will be required to supply an estimated Project Agreement End Date for each federally authorized phase of a project. To ensure adequate time for the delivery of local projects, which are subject to state environmental requirements, substantial community involvement, eminent domain, and coordination with other local projects, WSDOT recommends when establishing the “Project Agreement End Date” local agencies consider:

- For **Planning Only** projects – WSDOT recommends local agencies estimate the end of the project’s period of performance and add three years.
- For **Preliminary Engineering** (PE – design) and **Right of Way** (RW) – WSDOT recommends local agencies estimate when each phase will be completed and add three years to each, due to the complications that may arise with environmental requirements and approvals and negotiating right of way with property owners and railroads.
- For **Construction** (CN) – WSDOT recommends local agencies estimate when construction will be completed and add three years, to provide adequate time to acquire all the necessary paperwork, releases, and negotiate any claims for closure of the project.

Note: Any costs incurred after the “Project Agreement End Date” are NOT eligible for federal reimbursement. All eligible costs incurred prior to the Project Agreement End Date must be submitted within 60 calendar days after the Project Agreement End Date or they become ineligible for federal reimbursement.

When authorizing construction, the agency's proposed advertisement date must be noted on the supplemental Local Agency Agreement, or the original LAA if construction is the first phase authorized. Local Agencies are expected to go to ad within six weeks of construction authorization.

All funds shown on the Local Agency Agreement must be supported by a documented cost estimate (23 CFR Part 630) that is based on an Agency's best estimate of costs. The cost estimate must demonstrate how the funds shown on the LAA were determined, and what information was used in the calculation.

22.2 Preparation Procedure

An original Local Agency Agreement signed by the approving authority must be submitted by the local agency to the Region Local Programs Engineer when the Project Prospectus (Chapter 21) is submitted. This agreement form will be retained by WSDOT. It is the responsibility of the local agency to submit an additional agreement form or a copy if they need an executed agreement for their files. To allow sufficient time for WSDOT review and execution, these documents should be submitted a minimum of 4 weeks prior to the time when federal authorization is desired.

Agreements containing errors will be returned to the local agency for correction. Any changes must be initialed by the approving authority (Chapter 13). To avoid this delay, the agency should check all figures prior to submittal, and if in doubt, request assistance from the Region Local Programs Engineer.

An agreement form and instructions are in DOT Form 140-039. Local agency cost estimates for each phase of a project are entered on the form, as well as the project name, length, termini, description, Project Agreement End Date, Proposed Advertisement Date (required for construction phase) and method of construction financing. These methods are described in the instructions of DOT Form 140-039.

Local agency resolutions or ordinances that may be needed are discussed in the instructions of DOT Form 140-039.

22.3 Supplemental Agreement

Funds requested beyond the amount set forth in a Local Agency Agreement, supplementing for the next phase of the project and/or a change to the Project Agreement End Date will require execution of a Supplemental Agreement.

Changes to the project funding must be made in accordance with this manual (see Chapter 12) and must be accompanied by documented cost estimates for phases already authorized or seeking authorization (23 CFR Part 630).

All projects shall submit a supplemental agreement to revise the federal funds obligated within 90 calendar days after it is determined that the estimated federal share of project costs has decreased by \$250,000 or more (23 CFR Part 630.106(4) Subpart A).

Federal approval is required to change a Project Agreement End Date. Therefore, Project Agreement End Date may only be changed during an authorized phase, through a supplement, if:

- a project has a change in the terms and conditions of the federal award (e.g., significant cost change or scope change); or

- adequate justification is provided for project schedule revision or other circumstances (e.g., litigation) and there is no change to the terms and conditions of the Federal project.

Note: Work undertaken after the Project Agreement End Date is NOT eligible for federal reimbursement. All eligible costs incurred prior to the Project Agreement End Date must be submitted for reimbursement within 60 calendar days after the Project Agreement End Date or they become ineligible for federal reimbursement.

A Supplemental Agreement form and instructions are in DOT Form 140-041. Like the original agreement form, the Supplemental Agreement form requires information about the project's name, length, termini, description, schedule and funding.

22.4 Documented Cost Estimate

A documented cost estimate is an itemized estimate of costs broken down by phase for a project. Preliminary engineering estimates can be based on a percentage of historical construction costs, or based on historical labor and equipment needs used to complete similar design efforts. Right of way estimates will be the right of way funding estimate ([Appendix 25.51](#)). Construction estimates will be the engineer's estimate, including construction engineering costs. Bid tabulations, or award data may be used to justify increases when completing Supplemental Agreements.

Acceptable references for building a documented estimate may be historical construction costs, estimates from recent similar work, WSDOT Unit Bid Analysis, or other estimating methods that clearly identify how the costs were determined. A cost estimate must be provided for each authorized phase on the Local Agency Agreement.

22.5 Forms and Appendices

- [140-039](#) Local Agency Agreement and Instructions
- [140-041](#) Local Agency Agreement Supplement and Instructions
- [22.51](#) Documented Cost Estimates – Example

Appendix 22.51 Documented Cost Estimates – Example

Documented Cost Estimate for Preliminary Engineering

Agency Cost through Dec. 31, 2008	\$16,144
Additional PE Agency Cost for 2009	
• PS & E Review	3,500
• Prepare Bid Documents	2,000
• Advertisement Process	<u>2,000</u>
	\$23,644
Agency PE Cost Estimate	\$24,000
Consultant PE Cost Estimate ((\$53,169 per consultant agreement))	\$54,000

Documented Cost Estimate for Construction

Construction Cost Estimate	\$420,385
Agency Construction Engineering (25%)	<u>\$105,096</u>
	\$525,481
Agency Construction Estimate	\$525,000
State Construction Engineering Estimate	\$ 50,000
Total Construction Cost Estimate	\$575,000

1/2

PS&E ESTIMATE

No.	Item	Unit	Amt.	Unit Costs	Item Cost	% of total
	Description	Unit				
PREPARATION						
1	Mobilization	L.S.	L.S.	L.S.	\$ 42,000	10.0%
2	Clearing and Grubbing	L.S.	1	3,000	\$ 3,000	0.7%
3	Remove Exist. Bridge	L.S.	1	30,000	\$ 30,000	7.1%
GRADING						
4	Roadway Excavation Incl.Haul	C.Y.	419	25	\$ 10,475	2.5%
5	Gravel Borrow Incl. Haul	C.Y.	138	15	\$ 2,070	0.5%
6	Embankment Compaction	C.Y.	73	5	\$ 365	0.1%
STRUCTURE						
7	Structure Excavation Class A Incl. Haul	C.Y.	177	50	\$ 8,850	2.1%
8	Shoring or Extra Excavation Cl. A	L.S.	1	17,000	\$ 17,000	4.0%
9	Gravel Backfill For Walls	C.Y.	12	50	\$ 600	0.1%
10	Epoxy-Coated St. Reinf. Bar For Bridge	LB	391	2.00	\$ 782	0.2%
11	Steel Reinforcing Bar for Bridge	LB	6,734	2.00	\$ 13,468	3.2%
12	Deficient Strength Conc. Price Adjustment	Dol.	1		\$ -	0.0%
13	Superstructure - Schmid Road Bridge	L.S.	1	130,000	\$ 130,000	30.9%
14	Concrete Class 4000 for Bridge	C.Y.	61	800	\$ 48,800	11.6%
15	Traffic Barrier	L.F.	107	200	\$ 21,400	5.1%
16	Membrane Waterproofing	S.Y.	106	50	\$ 5,300	1.3%
SURFACING						
17	Gravel Base	Ton	634	25	\$ 15,850	3.8%
18	Crushed Surfacing Base Course	Ton	190	50	\$ 9,500	2.3%
HOT MIX ASPHALT						
19	Asphalt Conc. Pavement Cl. A	Ton	165	175	\$ 18,375	4.4%
20	Asphalt Cost Price Adjustment	Dol.	1		\$ -	0.0%
EROSION/WATER POLLUTION CONTROL						
21	ESC Lead	Day	20	300	\$ 6,000	1.4%
22	Seeding Fertilizing and Mulching	L.S.	1	3,000	\$ 3,000	0.7%
23	Silt Fence	L.F.	160	5	\$ 800	0.2%
24	TESC	L.S.	1	8,000	\$ 8,000	1.9%
TRAFFIC						
25	Beam Guardrail Non-Flared Terminal	Each	3	2,500	\$ 7,500	1.8%
26	Beam Guardrail Transition Type 1	Each	3	2,000	\$ 6,000	1.4%
27	Permanent Signing	L.S.	1	1,000	\$ 1,000	0.2%
28	Project Temporary Traffic Control	L.S.	1	5,000	\$ 5,000	1.2%
OTHER ITEMS						
29	Water	M. Gal	10	125	\$ 1,250	0.3%
30	Trimming and Cleanup	L.S.	1	2,000	\$ 2,000	0.5%
31	SPCC	L.S.	1	2,000	\$ 2,000	0.5%
CONTRACT ITEM TOTAL					420,385	100.0%

2/4/2009

2/2

Opinion of Probable Construction Cost
30% Design Phase

Opinion of Probable Construction Cost - 30% Design	
ITEM	SUBTOTAL
1 Mobilization	\$ 80,000
2 Traffic Control	\$ 90,000
3 TESC	\$ 10,000
4 Clearing, Demo, and Grading	\$ 25,000
5 Storm Water	\$ 20,000
6 Utilities	\$ 20,000
7 Roeder Bridge	\$ 507,000
Subtotal ROEDER BRIDGE, TRANSPORTATION, AND UTILITIES	\$ 752,000
<hr/>	
Construction Contingency (25%)	\$ 188,000
Transportation and Utilities Construction Total	\$ 940,000
<hr/>	
Engineering and Project Management	
Project Management (\$45/hr x 400 hrs.)	\$ 18,000
Engineering Staff (\$40/hr x 200 hrs.)	\$ 8,000
Administrative Staff (\$35/hr x 200 hrs.)	\$ 7,000
Inspection Staff (\$40/hr x 675 hrs.)	\$ 27,000
Engineering and Project Management Total *	\$ 60,000
<hr/>	
Opinion of Probable Project Costs Total	\$ 1,000,000

*Note: Engineering and Project Management cost estimates are based on previous project costs similar in nature where the City is managing and overseeing a consultant and the construction. This accounts for approximately 1500 hours of engineering, project management, inspection, and staff time

2009 SIDEWALK IMPROVEMENTS
FEDERAL AID PROJECT NO. STP-

Preliminary Engineers Estimate of Probable Costs
Low Range of Costs

Sidewalk Improvements

Work for each item in this schedule shall be in accordance with the Specification Reference listed for each item below.

Item No.	Description of Item Write In Unit Price in Words	Plan Quantity	Unit of Quantity	Unit Price Dollars & Cents	Total Price Dollars & Cents
1	Mobilization per lump sum	1	LS	NA	\$ 110,000.00
2	Type A - Cement Concrete Curb and Gutter Project Length Minus Northern 2,500 feet per linear feet	5314	LF	\$ 25.00	\$ 132,850.00
3	Cement Concrete Sidewalk - 4" Depth Project Length (6 feet wide) per square yard	5209	SY	\$ 45.00	\$ 234,405.00
4	Cement Concrete Sidewalk/Driveway Approach - 6" Depth Every 100 Feet Along Project Length per each	78	EA	\$ 2,500.00	\$ 195,000.00
5	Cement Concrete Sidewalk Ramp - Type 2 Each Intersection per each	28	EA	\$ 1,500.00	\$ 42,000.00
6	Sawcut Asphalt Pavement Along Curb & Gutter per linear feet	5314	LF	\$ 2.00	\$ 10,628.00
7	Hot Mix Asphalt - (Commercial HMA) 2' Wide by 3" Deep Along Curb & Gutter per ton	300	TN	\$ 200.00	\$ 60,000.00

**2009 Sidewalk Improvements
SUMMARY**

Description of Item	Total
Sidewalk Improvements	\$ 854,883.00
Non-Specified Items	20% \$ 170,976.60
	7.7 % Tax \$ 78,991.19
Subtotal Construction Cost	\$ 1,104,850.79
Design and Inspection	20% \$ 220,970.16
TOTAL PROJECT COST	\$ 1,325,820.95

Chapter 22 Forms Local Agency Agreement – Example



**Washington State
Department of Transportation**

Agency

Address

Local Agency Agreement

CFDA No. 20.205
(Catalog or Federal Domestic Assistance)

Project No.

Agreement No.

For OSC WSDOT Use Only

The Local Agency having complied, or hereby agreeing to comply, with the terms and conditions set forth in (1) Title 23, U.S. Code Highways, (2) the regulations issued pursuant thereto, (3) 2 CFR Part 200, (4) 2 CFR Part 180 – certifying that the local agency is not excluded from receiving Federal funds by a Federal suspension or debarment, (5) the policies and procedures promulgated by the Washington State Department of Transportation, and (6) the federal aid project agreement entered into between the State and Federal Government, relative to the above project, the Washington State Department of Transportation will authorize the Local Agency to proceed on the project by a separate notification. Federal funds which are to be obligated for the project may not exceed the amount shown herein on line r, column 3, without written authority by the State, subject to the approval of the Federal Highway Administration. All project costs not reimbursed by the Federal Government shall be the responsibility of the Local Agency.

Project Description

Name

Length

Termini

Description of Work

Project Agreement End Date

Claiming Indirect Cost Rate

Proposed Advertisement Date

Yes No

Type of Work	Estimate of Funding		
	(1) Estimated Total Project Funds	(2) Estimated Agency Funds	(3) Estimated Federal Funds
PE			
% a. Agency			
% b. Other			
Federal Aid Participation Ratio for PE			
c. Other			
d. State			
e. Total PE Cost Estimate (a+b+c+d)	0.00	0.00	0.00
Right of Way			
% f. Agency			
% g. Other			
Federal Aid Participation Ratio for RW			
h. Other			
i. State			
j. Total R/W Cost Estimate (f+g+h+i)	0.00	0.00	0.00
Construction			
% k. Contract			
% l. Other			
m. Other			
Federal Aid Participation Ratio for CN			
n. Other			
o. Agency			
p. State			
q. Total CN Cost Estimate (k+l+m+n+o+p)	0.00	0.00	0.00
r. Total Project Cost Estimate (e+j+q)	0.00	0.00	0.00

Agency Official

By

Title

Washington State Department of Transportation

By

Director, Local Programs

Date Executed

Construction Method of Financing (Check Method Selected)

State Ad and Award

Method A - Advance Payment - Agency Share of total construction cost (based on contract award)

Method B - Withhold from gas tax the Agency's share of total construction cost (line 5, column 2) in the amount of

\$ _____ at \$ _____ per month for _____ months.

Local Force or Local Ad and Award

Method C - Agency cost incurred with partial reimbursement

The Local Agency further stipulates that pursuant to said Title 23, regulations and policies and procedures, and as a condition to payment of the federal funds obligated, it accepts and will comply with the applicable provisions set forth below. Adopted by official action on

_____, _____, Resolution/Ordinance No.

Provisions

I. Scope of Work

The Agency shall provide all the work, labor, materials, and services necessary to perform the project which is described and set forth in detail in the "Project Description" and "Type of Work."

When the State acts for and on behalf of the Agency, the State shall be deemed an agent of the Agency and shall perform the services described and indicated in "Type of Work" on the face of this agreement, in accordance with plans and specifications as proposed by the Agency and approved by the State and the Federal Highway Administration.

When the State acts for the Agency but is not subject to the right of control by the Agency, the State shall have the right to perform the work subject to the ordinary procedures of the State and Federal Highway Administration.

II. Delegation of Authority

The State is willing to fulfill the responsibilities to the Federal Government by the administration of this project. The Agency agrees that the State shall have the full authority to carry out this administration. The State shall review, process, and approve documents required for federal aid reimbursement in accordance with federal requirements. If the State advertises and awards the contract, the State will further act for the Agency in all matters concerning the project as requested by the Agency. If the Local Agency advertises and awards the project, the State shall review the work to ensure conformity with the approved plans and specifications.

III. Project Administration

Certain types of work and services shall be provided by the State on this project as requested by the Agency and described in the Type of Work above. In addition, the State will furnish qualified personnel for the supervision and inspection of the work in progress. On Local Agency advertised and awarded projects, the supervision and inspection shall be limited to ensuring all work is in conformance with approved plans, specifications, and federal aid requirements. The salary of such engineer or other supervisor and all other salaries and costs incurred by State forces upon the project will be considered a cost thereof. All costs related to this project incurred by employees of the State in the customary manner on highway payrolls and vouchers shall be charged as costs of the project.

IV. Availability of Records

All project records in support of all costs incurred and actual expenditures kept by the Agency are to be maintained in accordance with local government accounting procedures prescribed by the Washington State Auditor's Office, the U.S. Department of Transportation, and the Washington State Department of Transportation. The records shall be open to inspection by the State and Federal Government at all reasonable times and shall be retained and made available for such inspection for a period of not less than three years from the final payment of any federal aid funds to the Agency. Copies of said records shall be furnished to the State and/or Federal Government upon request.

V. Compliance with Provisions

The Agency shall not incur any federal aid participation costs on any classification of work on this project until authorized in writing by the State for each classification. The classifications of work for projects are:

1. Preliminary engineering.
2. Right of way acquisition.
3. Project construction.

Once written authorization is given, the Agency agrees to show continuous progress through monthly billings. Failure to show continuous progress may result the Agency's project becoming inactive, as described in 23 CFR 630, and subject to de-obligation of federal aid funds and/or agreement closure.

If right of way acquisition, or actual construction of the road for which preliminary engineering is undertaken is not started by the close of the tenth fiscal year following the fiscal year in which preliminary engineering phase was authorized, the Agency will repay to the State the sum or sums of federal funds paid to the Agency under the terms of this agreement (see Section IX).

If actual construction of the road for which right of way has been purchased is not started by the close of the tenth fiscal year following the fiscal year in which the right of way phase was authorized, the Agency will repay to the State the sum or sums of federal funds paid to the Agency under the terms of this agreement (see Section IX).

IX. Payment of Billing

The Agency agrees that if payment or arrangement for payment of any of the State's billing relative to the project (e.g., State force work, project cancellation, overpayment, cost ineligible for federal participation, etc.) is not made to the State within 45 days after the Agency has been billed, the State shall effect reimbursement of the total sum due from the regular monthly fuel tax allotments to the Agency from the Motor Vehicle Fund. No additional Federal project funding will be approved until full payment is received unless otherwise directed by the Director, Local Programs.

Project Agreement End Date - This date is based on your projects Period of Performance (2 CFR Part 200.309).

Any costs incurred after the Project Agreement End Date are NOT eligible for federal reimbursement. All eligible costs incurred prior to the Project Agreement End Date must be submitted for reimbursement within 60 days after the Project Agreement End Date or they become ineligible for federal reimbursement.

X. Traffic Control, Signing, Marking, and Roadway Maintenance

The Agency will not permit any changes to be made in the provisions for parking regulations and traffic control on this project without prior approval of the State and Federal Highway Administration. The Agency will not install or permit to be installed any signs, signals, or markings not in conformance with the standards approved by the Federal Highway Administration and MUTCD. The Agency will, at its own expense, maintain the improvement covered by this agreement.

XI. Indemnity

The Agency shall hold the Federal Government and the State harmless from and shall process and defend at its own expense all claims, demands, or suits, whether at law or equity brought against the Agency, State, or Federal Government, arising from the Agency's execution, performance, or failure to perform any of the provisions of this agreement, or of any other agreement or contract connected with this agreement, or arising by reason of the participation of the State or Federal Government in the project. PROVIDED, nothing herein shall require the Agency to reimburse the State or the Federal Government for damages arising out of bodily injury to persons or damage to property caused by or resulting from the sole negligence of the Federal Government or the State.

XII. Nondiscrimination Provision

No liability shall attach to the State or Federal Government except as expressly provided herein.

The Agency shall not discriminate on the basis of race, color, national origin, or sex in the award and performance of any USDOT-assisted contract and/or agreement or in the administration of its DBE program or the requirements of 49 CFR Part 26. The Agency shall take all necessary and reasonable steps under 49 CFR Part 26 to ensure nondiscrimination in the award and administration of USDOT-assisted contracts and agreements. The WSDOT's DBE program, as required by 49 CFR Part 26 and as approved by USDOT, is incorporated by reference in this agreement. Implementation of this program is a legal obligation and failure to carry out its terms shall be treated as a violation of this agreement. Upon notification to the Agency of its failure to carry out its approved program, the Department may impose sanctions as provided for under Part 26 and may, in appropriate cases, refer the matter for enforcement under 18 U.S.C. 1001 and/or the Program Fraud Civil Remedies Act of 1986 (31 U.S.C. 3801 et seq.).

The Agency hereby agrees that it will incorporate or cause to be incorporated into any contract for construction work, or modification thereof, as defined in the rules and regulations of the Secretary of Labor in 41 CFR Chapter 60, which is paid for in whole or in part with funds obtained from the Federal Government or borrowed on the credit of the Federal Government pursuant to a grant, contract, loan, insurance, or guarantee or understanding pursuant to any federal program involving such grant, contract, loan, insurance, or guarantee, the required contract provisions for Federal-Aid Contracts (FHWA 1273), located in Chapter 44 of the Local Agency Guidelines.

The Agency further agrees that it will be bound by the above equal opportunity clause with respect to its own employment practices when it participates in federally assisted construction work: Provided, that if the applicant so participating is a State or Local Government, the above equal opportunity clause is not applicable to any agency, instrumentality, or subdivision of such government which does not participate in work on or under the contract.

The Agency also agrees:

- (1) To assist and cooperate actively with the State in obtaining the compliance of contractors and subcontractors with the equal opportunity clause and rules, regulations, and relevant orders of the Secretary of Labor.
- (2) To furnish the State such information as it may require for the supervision of such compliance and that it will otherwise assist the State in the discharge of its primary responsibility for securing compliance.
- (3) To refrain from entering into any contract or contract modification subject to Executive Order 11246 of September 24, 1965, with a contractor debarred from, or who has not demonstrated eligibility for, government contracts and federally assisted construction contracts pursuant to the Executive Order.
- (4) To carry out such sanctions and penalties for violation of the equal opportunity clause as may be imposed upon contractors and subcontractors by the State, Federal Highway Administration, or the Secretary of Labor pursuant to Part II, subpart D of the Executive Order.

In addition, the Agency agrees that if it fails or refuses to comply with these undertakings, the State may take any or all of the following actions:

- (a) Cancel, terminate, or suspend this agreement in whole or in part;
- (b) Refrain from extending any further assistance to the Agency under the program with respect to which the failure or refusal occurred until satisfactory assurance of future compliance has been received from the Agency; and
- (c) Refer the case to the Department of Justice for appropriate legal proceedings.

The Agency agrees that all stages of construction necessary to provide the initially planned complete facility within the limits of this project will conform to at least the minimum values set by approved statewide design standards applicable to this class of highways, even though such additional work is financed without federal aid participation.

The Agency agrees that on federal aid highway construction projects, the current federal aid regulations which apply to liquidated damages relative to the basis of federal participation in the project cost shall be applicable in the event the contractor fails to complete the contract within the contract time.

VI. Payment and Partial Reimbursement

The total cost of the project, including all review and engineering costs and other expenses of the State, is to be paid by the Agency and by the Federal Government. Federal funding shall be in accordance with the Federal Transportation Act, as amended, 2 CFR Part 200. The State shall not be ultimately responsible for any of the costs of the project. The Agency shall be ultimately responsible for all costs associated with the project which are not reimbursed by the Federal Government. Nothing in this agreement shall be construed as a promise by the State as to the amount or nature of federal participation in this project.

The Agency shall bill the state for federal aid project costs incurred in conformity with applicable federal and state laws. The agency shall minimize the time elapsed between receipt of federal aid funds and subsequent payment of incurred costs. Expenditures by the Local Agency for maintenance, general administration, supervision, and other overhead shall not be eligible for federal participation unless a current indirect cost plan has been prepared in accordance with the regulations outlined in 2 CFR Part 200 - Uniform Admin Requirements, Cost Principles and Audit Requirements for Federal Awards, and retained for audit.

The State will pay for State incurred costs on the project. Following payment, the State shall bill the Federal Government for reimbursement of those costs eligible for federal participation to the extent that such costs are attributable and properly allocable to this project. The State shall bill the Agency for that portion of State costs which were not reimbursed by the Federal Government (see Section IX).

1. Project Construction Costs

Project construction financing will be accomplished by one of the three methods as indicated in this agreement.

Method A – The Agency will place with the State, within (20) days after the execution of the construction contract, an advance in the amount of the Agency's share of the total construction cost based on the contract award. The State will notify the Agency of the exact amount to be deposited with the State. The State will pay all costs incurred under the contract upon presentation of progress billings from the contractor. Following such payments, the State will submit a billing to the Federal Government for the federal aid participation share of the cost. When the project is substantially completed and final actual costs of the project can be determined, the State will present the Agency with a final billing showing the amount due the State or the amount due the Agency. This billing will be cleared by either a payment from the Agency to the State or by a refund from the State to the Agency.

Method B – The Agency's share of the total construction cost as shown on the face of this agreement shall be withheld from its monthly fuel tax allotments. The face of this agreement establishes the months in which the withholding shall take place and the exact amount to be withheld each month. The extent of withholding will be confirmed by letter from the State at the time of contract award. Upon receipt of progress billings from the contractor, the State will submit such billings to the Federal Government for payment of its participating portion of such billings.

Method C – The Agency may submit vouchers to the State in the format prescribed by the State, in duplicate, not more than once per month for those costs eligible for Federal participation to the extent that such costs are directly attributable and properly allocable to this project. Expenditures by the Local Agency for maintenance, general administration, supervision, and other overhead shall not be eligible for Federal participation unless claimed under a previously approved indirect cost plan.

The State shall reimburse the Agency for the Federal share of eligible project costs up to the amount shown on the face of this agreement. At the time of audit, the Agency will provide documentation of all costs incurred on the project. The State shall bill the Agency for all costs incurred by the State relative to the project. The State shall also bill the Agency for the federal funds paid by the State to the Agency for project costs which are subsequently determined to be ineligible for federal participation (see Section IX).

VII. Audit of Federal Consultant Contracts

The Agency, if services of a consultant are required, shall be responsible for audit of the consultant's records to determine eligible federal aid costs on the project. The report of said audit shall be in the Agency's files and made available to the State and the Federal Government.

An audit shall be conducted by the WSDOT Internal Audit Office in accordance with generally accepted governmental auditing standards as issued by the United States General Accounting Office by the Comptroller General of the United States; WSDOT Manual M 27-50, Consultant Authorization, Selection, and Agreement Administration; memoranda of understanding between WSDOT and FHWA; and 2 CFR Part 200.501 - Audit Requirements.

If upon audit it is found that overpayment or participation of federal money in ineligible items of cost has occurred, the Agency shall reimburse the State for the amount of such overpayment or excess participation (see Section IX).

VIII. Single Audit Act

The Agency, as a subrecipient of federal funds, shall adhere to the federal regulations outlined in 2 CFR Part 200.501 as well as all applicable federal and state statutes and regulations. A subrecipient who expends \$750,000 or more in federal awards from all sources during a given fiscal year shall have a single or program-specific audit performed for that year in accordance with the provisions of 2 CFR Part 200.501. Upon conclusion of the audit, the Agency shall be responsible for ensuring that a copy of the report is transmitted promptly to the State.

XIII. Liquidated Damages

The Agency hereby agrees that the liquidated damages provisions of 23 CFR Part 635, Subpart 127, as supplemented, relative to the amount of Federal participation in the project cost, shall be applicable in the event the contractor fails to complete the contract within the contract time. Failure to include liquidated damages provision will not relieve the Agency from reduction of federal participation in accordance with this paragraph.

XIV. Termination for Public Convenience

The Secretary of the Washington State Department of Transportation may terminate the contract in whole, or from time to time in part, whenever:

- (1) The requisite federal funding becomes unavailable through failure of appropriation or otherwise.
- (2) The contractor is prevented from proceeding with the work as a direct result of an Executive Order of the President with respect to the prosecution of war or in the interest of national defense, or an Executive Order of the President or Governor of the State with respect to the preservation of energy resources.
- (3) The contractor is prevented from proceeding with the work by reason of a preliminary, special, or permanent restraining order of a court of competent jurisdiction where the issuance of such order is primarily caused by the acts or omissions of persons or agencies other than the contractor.
- (4) The Secretary is notified by the Federal Highway Administration that the project is inactive.
- (5) The Secretary determines that such termination is in the best interests of the State.

XV. Venue for Claims and/or Causes of Action

For the convenience of the parties to this contract, it is agreed that any claims and/or causes of action which the Local Agency has against the State of Washington, growing out of this contract or the project with which it is concerned, shall be brought only in the Superior Court for Thurston County.

XVI. Certification Regarding the Restrictions of the Use of Federal Funds for Lobbying

The approving authority certifies, to the best of his or her knowledge and belief, that:

- (1) No federal appropriated funds have been paid or will be paid, by or on behalf of the undersigned, to any person for influencing or attempting to influence an officer or employee of any federal agency, a member of Congress, an officer or employee of Congress, or an employee of a member of Congress in connection with the awarding of any federal contract, the making of any federal grant, the making of any federal loan, the entering into of any cooperative agreement, and the extension, continuation, renewal, amendment, or modification of any federal contract, grant, loan, or cooperative agreement.
- (2) If any funds other than federal appropriated funds have been paid or will be paid to any person for influencing or attempting to influence an officer or employee of any federal agency, a member of Congress, an officer or employee of Congress, or an employee of a member of Congress in connection with this federal contract, grant, loan, or cooperative agreement, the undersigned shall complete and submit the Standard Form - LLL, "Disclosure Form to Report Lobbying," in accordance with its instructions.
- (3) The undersigned shall require that the language of this certification be included in the award documents for all subawards at all tiers (including subgrants, and contracts and subcontracts under grants, subgrants, loans, and cooperative agreements) which exceed \$100,000, and that all such subrecipients shall certify and disclose accordingly.

This certification is a material representation of fact upon which reliance was placed when this transaction was made or entered into. Submission of this certification as a prerequisite for making or entering into this transaction imposed by Section 1352, Title 31, U.S. Code. Any person who fails to file the required certification shall be subject to a civil penalty of not less than \$10,000 and not more than \$100,000 for each such failure.

XVII. Assurances

Local agencies receiving Federal funding from the USDOT or its operating administrations (i.e., Federal Highway Administration, Federal Transit Administration, Federal Aviation Administration) are required to submit a written policy statement, signed by the Agency Executive and addressed to the State, documenting that all programs, activities, and services will be conducted in compliance with Section 504 and the Americans with Disabilities Act (ADA).

Additional Provisions

Local Agency Agreement Supplement – Example



**Washington State
Department of Transportation**

Local Agency Agreement Supplement

Agency		Supplement Number
Federal Aid Project Number	Agreement Number	CFDA No. 20.205 (Catalog of Federal Domestic Assistance)

The Local Agency requests to supplement the agreement number noted above.
 All provisions in the basic agreement remain in effect except as modified by this supplement.
 The Local Agency certifies that it is not excluded from receiving Federal funds by a Federal suspension or debarment (2 CFR Part 180). Additional changes to the agreement are as follows:

Project Description

Name Length

Termini

Description of Work No Change

Reason for Supplement

Are you claiming indirect cost rate? Yes No Project Agreement End Date
 Does this change require additional Right of Way or Easements? Yes No Advertisement Date:

Type of Work		Estimate of Funding				
		(1) Previous Agreement/Suppl.	(2) Supplement	(3) Estimated Total Project Funds	(4) Estimated Agency Funds	(5) Estimated Federal Funds
PE %	a. Agency			0.00		
	b. Other			0.00		
Federal Aid Participation Ratio for PE	c. Other			0.00		
	d. State			0.00		
e. Total PE Cost Estimate (a+b+c+d)		0.00	0.00	0.00	0.00	0.00
Right of Way %	f. Agency			0.00		
	g. Other			0.00		
Federal Aid Participation Ratio for RW	h. Other			0.00		
	i. State			0.00		
j. Total R/W Cost Estimate (f+g+h+i)		0.00	0.00	0.00	0.00	0.00
Construction %	k. Contract			0.00		
	l. Other			0.00		
Federal Aid Participation Ratio for CN	m. Other			0.00		
	n. Other			0.00		
o. Agency				0.00		
	p. State			0.00		
q. Total CN Cost Estimate (k+l+m+n+o+p)		0.00	0.00	0.00	0.00	0.00
r. Total Project Cost Estimate (e+j+q)		0.00	0.00	0.00	0.00	0.00

The Local Agency further stipulates that pursuant to said Title 23, regulations and policies and procedures, and as a condition to payment of the Federal funds obligated, it accepts and will comply with the applicable provisions.

Agency Official

Washington State Department of Transportation

By
Title

By
Director, Local Program
Date Executed

Agency		Supplement Number
Federal Aid Project Number	Agreement Number	CFDA No. 20.205 (Catalog of Federal Domestic Assistance)

VI. Payment and Partial Reimbursement

The total cost of the project, including all review and engineering costs and other expenses of the State, is to be paid by the Agency and by the Federal Government. Federal funding shall be in accordance with the Federal Transportation Act, as amended, 2 CFR Part 200. The State shall not be ultimately responsible for any of the costs of the project. The Agency shall be ultimately responsible for all costs associated with the project which are not reimbursed by the Federal Government. Nothing in this agreement shall be construed as a promise by the State as to the amount or nature of federal participation in this project.

The Agency shall bill the state for federal aid project costs incurred in conformity with applicable federal and state laws. The agency shall minimize the time elapsed between receipt of federal aid funds and subsequent payment of incurred costs. Expenditures by the Local Agency for maintenance, general administration, supervision, and other overhead shall not be eligible for federal participation unless a current indirect cost plan has been prepared in accordance with the regulations outlined in 2 CFR Part 200 - Uniform Admin. Requirements, Cost Principles and Audit Requirements for Federal Awards, and retained for audit.

The State will pay for State incurred costs on the project. Following payment, the State shall bill the Federal Government for reimbursement of those costs eligible for federal participation to the extent that such costs are attributable and properly allocable to this project. The State shall bill the Agency for that portion of State costs which were not reimbursed by the Federal Government (see Section IX).

VII. Audit of Federal Consultant Contracts

The Agency, if services of a consultant are required, shall be responsible for audit of the consultant's records to determine eligible federal aid costs on the project. The report of said audit shall be in the Agency's files and made available to the State and the Federal Government.

An audit shall be conducted by the WSDOT Internal Audit Office in accordance with generally accepted governmental auditing standards as issued by the United States General Accounting Office by the Comptroller General of the United States; WSDOT Manual M 27-50, Consultant Authorization, Selection, and Agreement Administration; memoranda of understanding between WSDOT and FHWA; and 2 CFR Part 200.501 - Audit Requirements.

If upon audit it is found that overpayment or participation of federal money in ineligible items of cost has occurred, the Agency shall reimburse the State for the amount of such overpayment or excess participation.

IX. Payment of Billing

The Agency agrees that if payment or arrangement for payment of any of the State's billing relative to the project (e.g., State force work, project cancellation, overpayment, cost ineligible for federal participation, etc.) is not made to the State within 45 days after the Agency has been billed, the State shall effect reimbursement of the total sum due from the regular monthly fuel tax allotments to the Agency from the Motor Vehicle Fund. No additional Federal project funding will be approved until full payment is received unless otherwise directed by the Director, Local Programs.

Project Agreement End Date - This date is based on your projects Period of Performance (2 CFR Part 200.309).

Any costs incurred after the Project Agreement End Date are NOT eligible for federal reimbursement. All eligible costs incurred prior to the Project Agreement End Date must be submitted for reimbursement within 90 days after the Project Agreement End Date or they become ineligible for federal reimbursement.

VIII. Single Audit Act

The Agency, as a subrecipient of federal funds, shall adhere to the federal regulations outlined in 2 CFR Part 200.501 as well as all applicable federal and state statutes and regulations. A subrecipient who expends \$750,000 or more in federal awards from all sources during a given fiscal year shall have a single or program-specific audit performed for that year in accordance with the provisions of 2 CFR Part 200.501. Upon conclusion of the audit, the Agency shall be responsible for ensuring that a copy of the report is transmitted promptly to the State.

XVII. Assurances

Local Agencies receiving Federal funding from the USDOT or its operating administrations (i.e., Federal Highway Administration, Federal Transit Administration, Federal Aviation Administration) are required to submit a written policy statement, signed by the Agency Executive and addressed to the State, documenting that all programs, activities and services will be conducted in compliance with Section 504 and the Americans with Disabilities Act (ADA).

Chapter 23 Progress Billing (Reimbursement Costs)

23.1 General Discussion

All progress billings shall be submitted monthly to WSDOT Headquarters Local Programs by the local agency in accordance with the terms of the Local Agency Agreement ([Chapter 22](#)). Billings will not be accepted before the Local Agency Agreement is executed and authorization in writing has been received from the Washington State Department of Transportation (WSDOT).

The execution of the Local Agency Agreement does not constitute approval of federal funds. This authorization from WSDOT is separate from the Local Agency Agreement. This authorization may include Advance Construction (AC), where FHWA provides federal authorization so that projects can move forward at their own cost prior to FHWA funding being available to reimburse the local agency for costs incurred. When FHWA funding becomes available, project funds will be converted so that the local agency can submit reimbursement for costs incurred from the date of authorization forward. To minimize the financial impact to local agencies, Local Programs expedites conversions soon after the beginning of each FFY.

Once written authorization is provided the Agency agrees to show continuous progress through monthly billings. Failure to show continuous progress may result in your project becoming inactive, as described in [23 CFR 630.106](#) and subject to deobligation of federal aid funds and/or agreement closure.

The Local Agency Agreement, when completed, establishes a work order account which permits billing to the project. The Work Order Accounting Plan (WOAP) and the work order ledger may be seen at the region office where the Region Local Programs Engineer can answer questions pertaining to these items.

WSDOT assigns a contract number on all federal aid construction projects. This number identifies the project. It should be used in addition to the federal aid project number when corresponding with WSDOT.

23.2 Billing Procedures for Local Agency Ad and Award and Agency Force Work

Once Local Programs has executed the Local Agency Agreement and WSDOT has given the local agency written authority to proceed, the agency submits progress billings monthly for each phase of work. Any work that is performed before the official authorization date does not qualify for federal participation.

Also, Federal grant requirements nationwide have now been consolidated and detailed in [2 CFR 200](#), please refer to them for additional guidance and eligibility.

As part of the changes included in the CFR is specific to signature authority on reimbursement requests. Per [2 CFR 200.415\(a\)](#) – *To assure that expenditures are proper and in accordance with the terms and conditions of the Federal award and approved project budget, the annual and final fiscal reports or vouchers requesting payment under the agreements must include a certification, signed by an official who is authorized to legally bind the non-Federal entity.*

Effective December 1, 2016, all progress billings are submitted as follows:

1. Local Programs sends the local agency the original fund authorization letter.
2. The agency submits a progress billing ([Appendix 23.71](#)) to WSDOT Headquarters Local Programs in accordance with the Local Agency Agreement. The form must be completed in accordance with the instruction outlined in [Appendix 23.72](#).

All progress billings, including the final progress bill may be submitted electronically via email to hqlpbillings@wsdot.wa.gov or hard copy to

WSDOT Local Programs
PO BOX 47390
Olympia, WA 98504-7390

- All hard copy progress billings must have an original signature in order to be processed.
- All email progress billings must include all of the following in order to be processed:
 - Agency
 - Project title
 - Federal aid project number
 - Local Agency agreement number
 - Signature of the official who is authorized to legally bind the local agency, on the progress billing, as the progress billing form includes the following certification statement:

*“By **signing this report**, I certify to the best of my knowledge and belief that the report is true, complete, and accurate, and the expenditures, disbursements, and cash receipts are for the purposes and objectives set forth in the terms and conditions of the Federal award. I am aware that any false, fictitious, or fraudulent information, or the omission of any material fact, **may subject me to criminal, civil, or administrative penalties for fraud, false statements, false claims, or otherwise.** (US Code Title 18, Section 1001 and Title 31. Sections 3729-3730 and 3801-3812)”*

Note: State funds only projects must include a different certification statement on the progress billing form, refer to [Appendix 23.72](#).

The first progress billing requires the local agency to submit back-up documentation to:

- Support the reimbursement request. (e.g., consultant invoices, contractor pay estimates, staffing dates & hours worked, mileage logs, equipment rental, etc.) and
- Local Agency’s documentation confirming the individual signing the reimbursement request is authorized to legally bind the agency (council/commission resolution of delegation, etc). Therefore, to implement this requirement, will depend on the structure of your agency on who has this authority or has delegated this authority to another individual in the agency (e.g. Mayor (official) to the City Administrator, Public Works Director or Finance Director)

Thereafter, the billing period needs to be consecutive and if requested, documentation needs to support dates within that billing period. An explanation needs to be provided for billing periods that overlap. The amount claimed on the progress billing must be billed at the Federal Participation Rate per the Local Agency Agreement up to the maximum authorized amount. If not, an explanation must be provided with progress bill. Progress billings claiming zero dollars will only be processed when marked as the final billing.

All progress billings must be substantiated by the required standard documentation established in this manual, the [Construction Manual M 41-01](#), requirements of the contract documents, and as defined by FHWA and must be available for review.

Construction costs are not eligible for reimbursement until after the contract has been awarded. Exceptions may include contract advertisement, staking, etc. **However, a statement explaining these costs must be included with the progress billing.**

Upon completion of project, the local agency must submit a final bill (Appendix 23.71) clearly marked "Final Billing" and final project summary (Appendix 23.75) to the WSDOT Headquarters Local Programs. The purpose of this summary is for the Agency to report the total project costs including federal, state, local and other funds received. The form must be completed in accordance with the instructions outlined in Appendix 23.76. For more information on closures please refer to [Chapter 53](#).

23.3 Billing Procedures for State Ad and Award

Progress billings are submitted as follows:

- Requests for payment from contractors are submitted to the Regional Administrator in accordance with the Local Agency Agreement.
- The requests will be processed in the region using standard WSDOT procedures.

23.4 Number and Timing of Submittals

Progress billings will be numbered sequentially and submitted monthly.

If the billing is prepared properly, payment should normally be received within three weeks of submittal. If payment is not received within one month, the agency should contact WSDOT Headquarters Local Programs.

FHWA requires WSDOT to conduct a quarterly review of local agency inactive projects. Local Programs definition of an inactive project is any project for which no expenditures have been charged against the federal project for the past 9 months. Any project that meets this definition will require evaluation and documented justification for remaining open. If a federal project remains open without acceptable justification and supporting documentation for remaining open, the project is at risk of being closed by FHWA. Examples of reasonable justification can be found in [Appendix 23.73](#).

23.5 Identification of Federal Aid Participating and Nonparticipating Charges

Costs are eligible for Federal Highway Administration (FHWA) federal participation if claimed in accordance and in compliance with [23 CFR](#) and [2 CFR Part 200](#) – Uniform Administrative Requirements, Cost Principles, and Audit Requirements for Federal Awards.

No costs may be claimed for reimbursement if incurred prior to FHWA authorization to proceed with the work. All work must be programmed with FHWA.

All local governments and units of local governments that claim indirect costs under federal awards must prepare an Indirect Cost Rate Proposal (ICRP) and related documentation to support those costs. The ICRP must be prepared in accordance with the instructions and regulations outlined in Appendix VII to [2 CFR Part 200](#) – States and Local Government and Indian Tribe Indirect Cost Proposals.

- A local government that receives more than \$35 million in all direct Federal funding must submit its ICRP to its federal cognizant agency for indirect costs. The cognizant agency for indirect cost negotiations is the Federal agency providing the largest amount of direct Federal awards. A local government that has a current federally negotiated indirect cost rate approved by its cognizant agency may apply for a one-time extension of the rate for a period of up to four years as defined in [2 CFR Part 200.414](#), paragraph (g).
- Other local governments must develop and certify ([Appendix 23.74](#)) an ICRP in accordance with federal requirements and maintain the proposal and related supporting documentation for audit. These governmental departments or agencies are not required to submit their proposals unless they are specifically requested to do so by the cognizant agency for indirect costs.

If a local government has never received federal reimbursement for indirect costs they may be eligible to use a de minimis rate of 10% of their modified total direct costs. Eligible agencies that elect to use the de minimis rate must meet the requirements as defined in [2 CFR Part 200.414](#), paragraph (f).

Some costs have been deemed ineligible for federal participation. Ineligible costs include equipment purchase and repair (unless specifically approved by FHWA), future equipment replacement costs, and those costs unallowable under [2 CFR Part 200](#).

.51 Participating Functions – Classifications of work programmed with FHWA and eligible for federal aid:

- a. **Preliminary Engineering** – The work of locating and designing, making surveys and maps, sinking test holes, making foundation investigations, preparing plans, specifications and estimates, centerline, right of way plan preparation and other related preliminary work and incidental construction staking, to the extent such staking is necessary to review construction plans, and related general engineering preparatory to the letting of a contract for construction. The work may also include traffic counts, studies undertaken to determine traffic demands, holding of public hearings, preparation of right of way cost estimates, legal, and other costs incidental to the location and design of a highway project necessitating the acquisition of right of way thereon up to but not including the appraisal of individual parcels for acquisition purposes.

These engineering costs are generally incurred prior to the date of construction PS&E approval or the date construction plan changes are completed prior to the beginning of construction. The date of contract award is the cutoff for charging to preliminary engineering.

- b. **Acquisition of Rights of Way** – The continuation of preparation of right of way plans; appraisal for parcel acquisition; review of appraisals; preparation for and trial of condemnation cases; management of properties acquired; furnishing of relocation advisory assistance; and other related labor expenses. If RW costs are claimed after the date of contract award, please provide an explanation.
- Excess land (appraised value) including uneconomic remnants.
 - Improvements (appraised salvage value).
 - Right of way acquired after certification by the local agency that right of way necessary for a designated federal aid highway project has been acquired.
 - Judgments in condemnation cases not appealed when the attorney's closing report indicates a basis for appeal. The amount in excess of the review appraiser's determination of value is nonparticipating.
 - Landowners:
 - Attorneys' fees;
 - Witness fees;
 - Expert witness fees; or
 - Similar costs to a landowner based on value of the services rendered to him which are paid by the local agency in connection with acquisition of rights of way, regardless of whether such costs are included in court judgments or court costs in litigated condemnation cases, e.g., statutory evaluation allowance.
- c. **Construction Engineering** – The work of supervising construction activities; the inspection of construction and related mechanical aspects (e.g., staking necessary to review construction plans together with those staking activities necessary for the local agency to control construction operations); testing of materials incorporated into construction, checking shop drawings and measurements for and preparations of progress and final estimates, and as-built drawings. Construction engineering costs are generally incurred only after approval of the PS&E, a contract number is issued, and also incurred prior to:
- Completion date of the final contract pay estimate and its submission to the contractor;
 - The final date of charges for required material testing; or
 - Completion date of the separation of contract cost by code type, location, etc., whichever is applicable to that portion of the construction engineering phase involved.
- d. **Highway Planning** – The orderly and continuing assembly and analysis of information about highways, such as the history of highway development and their extent, dimensions and conditions, use, economic and social effects, costs, and future needs.

- e. **Research and Development** – The search for more complete knowledge of the characteristics of the highway system and the translation of the results of research into practice.
- f. **Administrative Settlement Costs-Contract Claims** – Services related to the review and defense of claims against federal aid projects.
- g. **Miscellaneous Functions** – Costs incurred for other activities which are properly attributable to, and for the benefit of, federal aid projects but are not assignable to any of the previously defined functions.
- h. **Construction Costs Other Than Contractor Payments**
 - Royalty expenses for material furnished by the local agency that are used by the contractor.
 - Temporary signs, traffic control labor, traffic control devices, and temporary illumination furnished by the local agency. The initial basic cost of traffic control devices purchased for use on the project is an authorized participating cost.
 - Work performed by local forces.

.52 Standards for Selected Items of Costs – The following are standards for determining the allowability of selected items of cost. In general, costs must be reasonable, necessary, and allocable to the specific project. The allowability of the selected items of cost is subject to the general policies and principles stated above.

a. **Salaries and Wages**

1. Subject to appropriate authorization requirements, federal funds may participate in the cost of salaries, wages, and related payroll expenses incurred for periods of time public employees are actively engaged, either directly or indirectly, in project-related activities. Timekeeping procedures need to provide for allocating employees' time to projects and/or other activities each day on an hourly basis. The timekeeping document, such as a time slip, time and attendance report, or time book, is the source document which must be available for examination by audit personnel to support direct labor costs claimed on any federal project. The document needs to be signed by both the employee and a responsible employee (supervisor) having knowledge that the time distribution is accurately reported.
2. Salaries, wages, and related payroll expenses of a local agency for maintenance, general administration, supervision and other overhead are not eligible for reimbursement.

b. **Travel and Transportation**

1. Federal funds may participate in the cost of commercial transportation, privately owned automobiles, and per diem or subsistence essential to the completion of the project and is performed in accordance with prescribed procedures.
2. Reimbursement may be made for use of privately owned automobiles and per diem or subsistence incurred in conformance with the established reimbursement policy of the travel policy ([Appendix 23.77](#)).

- c. **Employee Leave and Holidays**
 - 1. A local agency may claim reimbursement for the costs of leave, e.g., annual, sick, military, jury, that is earned, accounted for, and used in accordance with established procedures. The cost of such leave must be a liability of the local agency, must be equitably distributed to all activities, and the pro rata costs distributed to a federal aid project must be representative of the amount that is earned and accrued while working on the project.
 - 2. Compensatory leave granted by a local agency in lieu of payment of overtime to eligible employees may be claimed for reimbursement if accrued and granted under established policies on a uniform basis. Such leave costs must meet the criteria discussed in paragraph (a) of this section.
 - 3. Costs for other leave of a similar nature which may be peculiar to a specific local agency may also be reimbursed provided it meets the criteria set forth in paragraph (a) of this section.
- d. **Social Security, Retirement, and Other Payroll Benefits**
 - 1. Federal funds may participate in allocable costs incurred for social security, retirement, group insurance premiums, and similar items applicable to salaries and wages of public employees engaged in work in federal aid projects.
 - 2. The costs for such benefits must be a liability of the local agency and must meet the criteria set forth in paragraph 1 of c above.

.53 Utility Relocations, Adjustments, and Reimbursement – Federal participation is subject to the provisions of [23 CFR part 645, subpart A](#).

.54 Reimbursement for Railroad Work – Costs must be incurred per [23 CFR part 646, subpart B](#) and will be reimbursed in accordance with [23 CFR part 140, subpart I](#).

.55 Other Costs Allowable Subject to FHWA's Approval – Although some category of expenditures are not mentioned specifically in Part 140, "Reimbursement," of [23 CFR](#) as eligible for federal participation, should the local agency wish to seek federal participation it is allowed to request approval from the FHWA prior to billing. The expenditures that relate to the federal aid project should be well identified through proper documentation.

.56 Other Unallowable Costs – Other unallowable costs include those costs identified in [2 CFR Part 200](#).

23.6 Billing Reviews

Each year construction projects are selected for “Billing Reviews.” These reviews are conducted at the agency and include representatives of FHWA, WSDOT Local Programs, and the local agency. One or more progress bills for the selected project will be reviewed for compliance with documentation standards established in this manual, the *Construction Manual* M 41-01, requirements of the contract documents, and as defined by FHWA. During a billing review, the agency must have all the required backup documentation necessary to support the invoice. The documentation must be available and filed in a way that is easy for the reviewers to locate.

At the conclusion of the review, a report is generated by FHWA and issued to WSDOT Local Programs. The report will include descriptions of the items reviewed, the backup documentation located in the files to support the payments, and a “Supported or Unsupported” finding for each item. Any “unsupported” payment findings are considered improper payments which may require corrective action and possible repayment of federal funds. Local Programs provides a copy of the report to the agency and identifies any findings.

23.7 Forms and Appendices

140-575	Local Programs Final Project Summary
140-576	Local Programs Progress Billing
23.70	Certificate of Indirect Costs
23.71	Vacant
23.72	Local Programs Progress Billing – Instructions
23.73	Inactive Justification Examples
23.74	Certificate of Indirect Costs
23.75	Vacant
23.76	Local Programs Final Project Summary – Instructions
23.77	Local Programs Quick Reference Travel Guide

Appendix 23.71 Vacant

Appendix 23.72 Local Programs Progress Billing – Instructions

Progress Billing Form – After the Fund Authorization letter is received by the agency, a Local Programs Progress Billing form must be completed. (Appendix 23.71). Form is available for download on our website: www.wsdot.wa.gov/LocalPrograms/ProgramMgmt/forms.htm. **Note:** State funds only projects must use the State Aid Progress Billing form.

Funding Set Up – The amount of federal funding set up for a project is based on the local agency agreement. Column (7) should be compared with column (6) to ensure that the amounts requested are within the funding amount set up by the local agency agreement. Payments will not be made in excess of the amount in column (7). If the amount in column (6) exceeds the amount shown in column (7), a supplement to the local agency agreement must be submitted to reflect the revised cost before payment can be made.

Exception: Following the final settlement and closure of the agreement, a final payment may be made in excess of the amount authorized per agreement in column (7) up to, but not to exceed the total project Fund Authorization Amount. Consult your Region Local Programs Engineer for specific project information.

Coding Instructions – The Local Programs Progress Billing is arranged in the same manner as the local agency agreement though not all lines from the local agency agreement are shown on the Local Programs Progress Billing. The lines for state services are not included because state costs are billed separately. Since the state services are not shown, the totals for PE, RW, and Construction shown on the Local Programs Progress Billing will not agree with those shown on the local agency agreement. The Local Programs Progress Billing totals (column 7) will reflect the total amount available to the local agency based on the local agency agreement.

Data Required to Request Payment – As a minimum, only those line items for which payment is being requested need to be coded. The other lines can be left blank. The top portion of the form must include the following:

- **Agency Information: Agency Name, Address and Federal Tax ID or Statewide Vendor Number and Agency Use** – This space provided is for the agency's records and is not required to receive payment.
- **Project Information** – Federal Aid Project, Agreement Number, Last Supplement, Project Title, Project End Date.
- **Progress Billing Information** – Progress Bill No., Final Progress bill (yes/no), Billing periods, CN Award Date. The first progress billing must include the first date expenditures were actually incurred on the project after funds were authorized by the FHWA. Thereafter, the billing period needs to be consecutive and if requested, documentation needs to support dates within that billing period. Crosscheck the billing period dates against prior bills(s). If dates overlap, please provide a statement confirming that costs are new and have not been claimed on prior bills.

Details for Completing Local Programs Progress Billing Form

This form only reflects the amounts claimed and authorized for payment to the local agency. It does not include costs for state services.

To ensure correct calculations, enter amounts in column 3 and column 7 from the local agency agreement prior to entering the other columns. *The progress billing form contains formulas that auto calculate the amounts for columns 4, 6, and 8, while the other columns must be manually entered and/or calculated.

- Column (1)** Total Eligible This Period: Record the total eligible costs incurred for federal participation this period for each item of work. **(Agency must claim all eligible costs even if there is no authorized funding available).**
- Column (2)** Total Eligible to Date: Record the total amount previously claimed in column (2) plus new eligible in column (1). (This cell does not auto calculate)
- Column (3)*** Participation Rate: Enter the current participation percentage in the local agency agreement.
- Column (4)** Amount Claimed This Period: The form calculates this amount from column (1) multiplied by column (3). For manual calculation (Multiply column (1) by column (3) and enter in column (4). This represents the amount of funds claimed on the progress bill. Column (4) can never exceed column (1) and must be equal to the participation rate up to the authorized agreement amount.
- Column (5)** Amount Claimed Prior Period: Record the total amount previously claimed in column (6) (This cell does not auto calculate)
- Column (6)** Total Claimed to Date: The form calculates this amount from adding column (4) and column (5). For manual calculation add column (4) and column (5) and enter the total in column (6). **The total claimed to date for PE, R/W, and Construction cannot exceed the amount authorized shown in column (7). Refer to funding setup section.**
- Column (7) *** Amount Authorized Per Agreement: This is the total amount of funds authorized for each line item per the latest version of the Local Agency Agreement. Enter the amount from the Local Agency Agreement listed as the Estimated Federal Funds. Do not include funds setup for state services.
- Column (8)** Remaining Federal Funds: The form calculates this amount by subtracting column (6) from column (7). For manual calculation subtract column (6) from column (7) and enter the total in column (8). The difference represents the remaining funds available. **This column cannot be a negative value.** If negative, a supplement to the Local Agency Agreement must be prepared to receive full payment. Refer to funding setup section.

Preliminary Engineering

- Line a** Agency Work for PE: Eligible PE cost incurred by the local agency.
- Line b-c** Other PE: As shown on Local Agency Agreement, usually consultant cost.
- Line d** State Service: As shown on Local Agency Agreement, is not included on the progress billing.
- Line e** Total PE Cost: This is the total amount claimed and authorized for payment to the local agency within the PE phase. Column (7) on this line shows the total amount of federal funds set up for the local agency based on the latest version of the Local Agency Agreement.

Right of Way

- Line f** Agency Work for RW: Eligible RW cost incurred by local agency.
- Line g-h** Other RW: As shown on Local Agency Agreement, usually consultant cost.
- Line i** State Service: As shown on Local Agency Agreement, is not included on the progress billing.
- Line j** Total RW Cost: This is the total amount claimed and authorized for payment to the local agency within the RW phase. Column (7) on this line shows the total amount of federal funds set up for the local agency based on the latest version of the Local Agency Agreement.

Construction

- Line k** Contract: Eligible payments made to contractor. Contract Award date must be submitted before payment will be made.
- Lines l-n** Other CN: Other costs incurred by the local agency as indicated on the Local Agency Agreement, such as Day Labor, Agency Supplied Materials, etc.
- Line o** Agency Work for CN: Eligible cost incurred by the local agency. Construction costs are not eligible for reimbursement until after the contract has been awarded. See exceptions in [Section 23.2](#).
- Line p** State Service: As shown on Local Agency Agreement, is not included on the progress billing.
- Line q** Total CN Cost: This is the total amount claimed and authorized for payment to the local agency within the Construction phase. Column (7) on this line shows the total amount of federal funds set up for the local agency based on the latest version of the Local Agency Agreement.

Total Project

- Line r** Total Project Cost: Add the Total PE, Total RW, and Total CN. This is the total amount claimed and authorized for payment to the local agency. Column (7) on this line shows the total amount of federal funds for all phases of work for the local agency based on the latest version of the Local Agency Agreement. It does not include state services.

Have the signature designee sign and date the progress billing and distribute according to the instructions located at the bottom of the form and in [Section 23.2](#).

Example 1**State: Washington****FMIS Project # 0000001**

The project is for the acquisition of right of way and is considered valid remaining open for the settlement of one remaining parcel of land relative to the construction of the roadway improvement at Case Boulevard in the County. The parcel was successfully acquired through condemnation procedures, but final settlement of the last parcel remains to be adjudicated through the Superior Court. Although deposited the fair value of the property at time of taking, final cost is to be determined by the court. The balance of unexpended federal aid project funds is anticipated to be sufficient to cover the cost of the property. Final settlement date has not been established. Federal dollars may not be invoiced to FHWA until settlement has taken place; the costs remain in the file awaiting future release. We have initiated discussion with the right of way division to determine whether the cost of the final parcel should be reclassified as nonparticipating for federal aid to permit the project to progress to final acceptance and closure because of the inordinate and continuing delay in settlement.

Example 2**State: Washington****FMIS Project # 0000002**

The project is valid because further expenditures are anticipated. The project is a Safe Routes to School sidewalk improvement administered by the local agency. The construction was completed and inspected by the state on April 24, 2012; however, the balance of the construction contract cost has not been billed under the agreement because of a contractual wage rate complaint filed on July 11, 2012. The complaint alleges the contractor failed to pay its workers the required prevailing rate of wages. There is no specified time frame for the resolution/adjudication of the complaint and payment to the contractor may be delayed for a substantial period of time. A copy of the complaint action is on file in the offices of FHWA. WSDOT will monitor the matter and update FHWA accordingly.

Certificate of Indirect Costs

This is to certify that I have reviewed the indirect cost rate proposal submitted herewith and to the best of my knowledge and belief:

1. All costs included in this proposal (identify date) to establish billing or final indirect costs rates for (identify period covered by rate) are allowable in accordance with the requirements of the Federal award(s) to which they apply and the provisions of Appendix VII to 2 CFR Part 200, Subpart D (3), Required certification. Unallowable costs have been adjusted for in allocating costs as indicated in the indirect cost proposal.
2. All costs included in this proposal are properly allocable to Federal awards on the basis of a beneficial or causal relationship between the expenses incurred and the agreements to which they are allocated in accordance with applicable requirements. Further, the same costs that have been treated as indirect costs have not been claimed as direct costs. Similar types of costs have been accounted for consistently and the Federal Government will be notified of any accounting changes that would affect the predetermined rate.

I declare that the foregoing is true and correct.

Governmental Unit: _____

Signature: _____

Name of Official: _____

Title: _____

Date of Execution: _____

Appendix 23.75 Vacant

Appendix 23.76 **Local Programs Final Project Summary – Instructions**

The final progress bill must include a final summary. The purpose of this summary is for the Agency to report total project costs including federal, state, local and other funds received. This form can be downloaded at www.wsdot.wa.gov/localprograms/programmgmt/forms.htm

Exception – If a project is not completed and the Agency is billing remaining available funds with the possibility of incurring more eligible costs; do not mark the billing as a final bill. Upon completion of project, submit a final bill to report the eligible costs even if zero dollars are being claimed along with the final summary.

Required Data – This form is arranged in the same manner as the Local Agency Agreement.

The form must include the following:

- Agency Name, Project Title, Federal Aid Number and LA Agreement Number.
- Federal Participation Rate Authorized Amount, Authorized Dates, Project End Date. (Refer to the last supplement of the Local Agency Agreement).
- Type of work – Should align with Local Agency Agreement. (Add or remove lines on form as needed).
- Total Project Cost – Record all costs incurred on Project including Federal, State, Local other grants. (Add or remove lines from form as needed).
- Total Federal/State Claimed to date – Record the amount of funds reimbursed from WSDOT. This amount should mirror the amount on final progress billing column 6.
- Agency Funds – Record all costs (not reimbursed by WSDOT), that are considered Agency costs or that have been reimbursed from other Agencies, Grants, programs, etc.
- Endorsed statement by signature designee that all eligible costs have only been reimbursed by the Federal agreement and not by any other grant or funding source.

*Total Federal/State Claimed to date plus Agency Funds should equal Total Project Cost.

Have signature designee sign and date form and send to the WSDOT Headquarters Local Programs (address on form) or submit electronically via email to hq|pbillings@wsdot.wa.gov

Appendix 23.77 Local Programs Quick Reference Travel Guide

Meals

Must be in travel status during the entire department determined meal period

Same Day Travel

- Traveler must be in travel status for 11 hours
- Meals will be reimbursed at the rate in effect for the location of the traveler's last temporary duty station of the day
- Meals will be reported as taxable income to the traveler

Overnight Travel

- Meals will be reimbursed at the rate in effect for the area where the traveler stops for sleep. The rate for the last day of travel (return day) is the rate for the location where the traveler last stopped for sleep.
- Meals are not reported as taxable income

Meal Periods

- Breakfast: the hour and a half immediately prior to the start of the regularly scheduled shift
- Lunch: the time the employee normally eats or, if eating times vary, halfway through the regularly scheduled shift
- Dinner: the hour and a half immediately following the end of the regularly scheduled shift

Note: Meal periods on scheduled day off and flex day is the same as the predominant work schedule for the week or pay period. For example, an employee works 4-9's and 1- 4 hour schedule. Meal periods on day off and the 4 hour day are based on the 9 hour shift.

Per Diem Rates

Washington State Per Diem Map www.ofm.wa.gov/resources/travel.asp

Continental USA Per Diem Rates www.gsa.gov/portal/content/104877

Lodging

- Eligible when the temporary duty station is more than fifty miles (most direct route) from the traveler's official residence and official station (50 mile rule)
- Limited to the basic government room rate plus any applicable sales taxes and/or hotel taxes
- Lodging tips or gratuities will not be reimbursed
- Travelers are reimbursed actual cost, as evidenced by receipt, for a single basic room up to the maximum lodging rate (state government room rate. See per Diem rate links pg. 1).

Exceptions-50 Mile Rule

- Approvers may approve exception to the fifty mile rule in the following situations:
- When the amount of time between the close of business on the first day and the start of business on the second is 11 hours or less (based on 3 hours personal time and 8 hours of sleep)
- When health and safety of the traveler is of concern. This requires written approval attached to the Travel Expense Voucher

Exceptions-150% Rule

- Requires written pre-approval
- Approvers may approve exception to the 150% rule in the following situations:
- The costs in the area have escalated for a brief period of time during special events or disasters
- Accommodations are not available at or below the maximum lodging amount, and the savings achieved from occupying less expensive lodging at a more distant site are consumed by an increase in transportation and other costs. Note a cost analysis must accompany this condition
- The traveler attends a meeting, conference, convention, or training session where the traveler is expected to have business interaction with other participants in addition to scheduled events. Further, it is anticipated that maximum benefit will be achieved by authorizing the traveler to stay at the lodging facility where the meeting, conference, convention, or training session is held

150% Rule Calculation for Lodging Meals + Lodging= Total Per Diem x 1.5= 150%
Amount for lodging

Transportation

Privately Owned Vehicle (POV)

- Use of POV for personal reasons is reimbursable at the elective POV rate.
- The traveler's private insurance policy provides primary liability coverage when using POV for business travel -- Proof of insurance must be maintained for POVs used for state business
- Transporting unauthorized passengers in a POV is considered a personal decision. The State of Washington assumes NO responsibility for such unauthorized passengers under any circumstances

Common Non-Reimbursable Travel Costs

- Alcoholic Beverages
- Cost of the daily commute between the traveler's regular place of work, permanent duty station (or telework site) and home. This includes travel to work on day off.
- Tolls associated with the use of high occupancy toll (HOT) lanes
- Parking tickets or moving violations
- Meal costs incurred at the traveler's official duty station or official residence
- Meal costs when the traveler does not incur expenses for meals because they are furnished. This excludes continental breakfasts and airline meals.
- Lodging expenses incurred at a lodging facility located at either the traveler's official duty station or official residence.
- Lodging incurred at a lodging facility or temporary duty station located within 50 miles of either the official residence or official station.
- Lodging expenses when a traveler stays at a non-commercial lodging facility such as a private/family residence or state provided facility.
- Lodging expenses for family members accompanying the traveler
- Valet Services
- Entertainment expenses
- Out of pocket charges for vehicle service calls due to the negligence of the traveler
- Personal trip insurance
- Personal telephone calls
- Taxi fares, motor vehicle rental, and other transportation costs to or from places of entertainment and other non-state business.
- Any tips or gratuities associated with personal expenses.

Chapter 24 Environmental Processes

24.1 General Discussion

This chapter summarizes the regulations and federal coordination requirements that local agencies must follow on projects that receive funding from the Federal Highway Administration (FHWA). Detailed guidance for complying with the federal requirements is provided in the publication entitled *NEPA Categorical Exclusions – A Guidebook for Local Agencies* and in the [Environmental Manual M 31-11](#).

Projects involving federal funds, permits, or land are governed by a number of environmental requirements, including but not limited to:

- National Environmental Policy Act (NEPA) of 1969, 42 USC 4321, et. seq.
- Council on Environmental Quality Regulations for Implementing NEPA, 40 CFR, Part 1500, et. seq.
- Federal Highway Administration and Federal Transit Administration Implementing Regulations, 23 CFR, Parts 771, 772, and 774
- Environmental Impact and Related Procedures, 49 CFR, Part 622
- Section 7 of the Endangered Species Act (ESA), 50 CFR, Part 402
- Section 106 of the National Historic Preservation Act, 36 CFR, Part 800
- Presidential Executive Order 12898 – Environmental Justice
- Section 4(f) of the U.S. Department of Transportation Act of 1966

Prior to approval of final NEPA documents, FHWA regulations require that a subsequent phase of a project be programmed into the current State Transportation Improvement Plan (STIP). Eligible phases include Right of Way and Construction. In cases where no federal Right of Way or Construction funding is available for a subsequent phase, projects may be listed in the STIP by allocating local agency money for the subsequent project phase.

Approval of NEPA, in particular the final signature on the Categorical Exclusion Documentation Form, does not signify an approval of the State Environmental Policy Act (SEPA), nor any applicable local, state, and federal permits. Local agencies are responsible for ensuring compliance with SEPA and obtaining all applicable local, state, and federal permits. While the local agency may utilize the analysis completed in the NEPA process to assist in the completion of SEPA and applicable permits, NEPA approval must not be misconstrued as a guaranteed approval of any other local, state, or federal requirement. The local agency must work with other agencies, as appropriate, to provide the required analysis to complete their responsibilities under SEPA and other local, state, and federal permit and process requirements.

24.2 NEPA Classification

Projects subject to NEPA fall into one of the three following classifications:

- Class I Projects require preparation of an Environmental Impact Statement (EIS) because the action is likely to have significant adverse environmental impacts.
- Class II Projects are Categorical Exclusions (CE). These actions are not likely to cause significant adverse environmental impacts. They meet the definitions contained in 40 CFR 1508.4 and 23 CFR 771.117.
- Class III Projects require preparation of an Environmental Assessment (EA) because the project's impact on the environment is not clearly understood.

.21 NEPA Class I Projects (EIS) – Actions that are likely to have significant impact on the environment because of their effects on land use, planned growth, development patterns, traffic volumes, travel patterns, transportation services, natural resources, or because they are apt to create substantial public controversy. See Appendix B in the *NEPA Categorical Exclusions - A Guidebook for Local Agencies* and the EPM for guidance on preparing an EIS. Projects that usually require an EIS, as defined in 23 CFR 771.115, are:

- New controlled-access freeway.
- Highway project of four or more lanes in a new location.
- New construction or extension of fixed rail transit facilities (e.g., rapid rail, light rail, commuter rail, automated guideway transit).
- New construction or extension of a separate roadway for buses or high-occupancy vehicles not located within an existing highway facility.

Although examples are given, it is important to remember that the size and significance of the potential impacts determine the need for an EIS, not the size of the project.

.22 NEPA Class II Projects (CE) – Actions that meet descriptions contained in NEPA rules (40 CFR 1508.4, 23 CFR 771.117) and do not typically involve significant environmental impacts. Unless specifically requested by other agencies or due to either unusual circumstances or public controversy, these actions do not require an EIS or an EA. Class II projects typically:

- Do not induce significant impacts to planned growth or land use.
- Do not require the relocation of significant numbers of people.
- Do not have a significant impact on any natural, cultural, recreational, historic, or other resource.
- Do not involve significant air, noise, or water quality impacts.
- Do not have significant impacts on travel patterns.
- Do not otherwise, either individually or cumulatively, have any significant environmental impacts.

Class II Projects are subdivided into two subcategories, which determine the documentation and approval requirements.

- a. **C-list Categorical Exclusions (c-list CE)** – Class II Projects that do not require approval. The following federal actions meeting the CEQ and FHWA criteria for c-list CEs are listed in FHWA regulations (23 CFR 771.117 (c)) and can be approved by Local Programs without signature by FHWA:
 1. Activities which do not involve or lead directly to construction, such as planning and technical studies; grants for training and research programs; research activities as defined in 23 USC 307; approval of a unified work program and any findings required in the planning process pursuant to 23 USC 134; approval of statewide programs under 23 CFR part 630; approval of project concepts under 23 CFR part 476; engineering to define the elements of a proposed action or alternatives so that social, economic, and environmental effects can be assessed; and federal aid system revisions which establish classes of highways on the federal aid highway system.
 2. Approval of utility installations along or across a transportation facility.
 3. Construction of bicycle and pedestrian lanes, paths, and facilities.
 4. Activities included in the state's highway safety plan under 23 USC 402.
 5. Transfer of Federal lands pursuant to 23 USC 317 when the subsequent action is not an FHWA action.
 6. The installation of noise barriers or alterations to existing publicly owned buildings to provide for noise reduction.
 7. Landscaping.
 8. Installation of fencing, signs, pavement markings, small passenger shelters, traffic signals, and railroad warning devices where no substantial land acquisition or traffic disruption will occur.
 9. Emergency repairs under 23 USC 125.
 10. Acquisition of scenic easements.
 11. Determination of payback under 23 CFR part 480 for property previously acquired with federal aid participation.
 12. Improvements to existing rest areas and truck weigh stations.
 13. Ridesharing activities.
 14. Bus and rail car rehabilitation.
 15. Alterations to facilities or vehicles in order to make them accessible for elderly and handicapped persons.
 16. Program administration, technical assistance activities, and operating assistance to transit authorities to continue existing service or increase service to meet routine changes in demand.
 17. The purchase of vehicles by the applicant where the use of these vehicles can be accommodated by existing facilities or by new facilities which themselves are within a CE.

18. Track and railbed maintenance and improvements when carried out within the existing right of way.
19. Purchase and installation of operating or maintenance equipment to be located within the transit facility and with no significant impacts off the site.
20. Promulgation of rules, regulations, and directives.
21. Deployment of electronics, photonics, communications, or information processing used singly or in combination, or as components of a fully integrated system, to improve the efficiency or safety of a surface transportation system or to enhance security or passenger convenience. Examples include, but are not limited to, traffic control and detector devices, lane management systems, electronic payment equipment, automatic vehicle locaters, automated passenger counters, computer-aided dispatching systems, radio communications systems, dynamic message signs, and security equipment including surveillance and detection cameras on roadways and in transit facilities and on buses.
22. Projects, as defined in 23 U.S.C. 101, that would take place entirely within the existing operational right-of-way. Existing operational right-of-way refers to right-of-way that has been disturbed for an existing transportation facility or is maintained for a transportation purpose. This area includes the features associated with the physical footprint of the transportation facility (including the roadway, bridges, interchanges, culverts, drainage, fixed guideways, mitigation areas, etc.) and other areas maintained for transportation purposes such as clear zone, traffic control signage, landscaping, any rest areas with direct access to a controlled access highway, areas maintained for safety and security of a transportation facility, parking facilities with direct access to an existing transportation facility, transit power substations, transit venting structures, and transit maintenance facilities. Portions of the right-of-way that have not been disturbed or that are not maintained for transportation purposes are not in the existing operational right-of-way.
23. Federally-funded projects:
 - (i) That receive less than \$5,000,000 of Federal funds; or
 - (ii) With a total estimated cost of not more than \$30,000,000 and Federal funds comprising less than 15 percent of the total estimated project cost.
24. Localized geotechnical and other investigation to provide information for preliminary design and for environmental analyses and permitting purposes, such as drilling test bores for soil sampling; archeological investigations for archeology resources assessment or similar survey; and wetland surveys.
25. Environmental restoration and pollution abatement actions to minimize or mitigate the impacts of any existing transportation facility (including retrofitting and construction of stormwater treatment systems to meet Federal and State requirements under sections 401 and 402 of the Federal Water Pollution Control Act (33 U.S.C. 1341; 1342) carried out to address water pollution or environmental degradation.

26. Modernization of a highway by resurfacing, restoration, rehabilitation, reconstruction, adding shoulders, or adding auxiliary lanes (including parking, weaving, turning, and climbing lanes), if the action meets the constraints in paragraph (e) of this section.
 27. Highway safety or traffic operations improvement projects, including the installation of ramp metering control devices and lighting, if the project meets the constraints in paragraph (e) of this section.
 28. Bridge rehabilitation, reconstruction, or replacement or the construction of grade separation to replace existing at-grade railroad crossings, if the actions meet the constraints in paragraph (e) of this section.
 29. Purchase, construction, replacement, or rehabilitation of ferry vessels (including improvements to ferry vessel safety, navigation, and security systems) that would not require a change in the function of the ferry terminals and can be accommodated by existing facilities or by new facilities which themselves are within a CE.
 30. Rehabilitation or reconstruction of existing ferry facilities that occupy substantially the same geographic footprint, do not result in a change in their functional use, and do not result in a substantial increase in the existing facility's capacity. Example actions include work on pedestrian and vehicle transfer structures and associated utilities, buildings, and terminals.
- b. **D-list Categorical Exclusions (d-list CE)** – Class II Projects that typically require additional documentation and may require FHWA approval. The second part of CFR (23 CFR 771.117 (d)) is known as the “d-list”. Examples of d-list projects identified in 23 CFR 771.117 (d) include but are not limited to:
1. This section has been deleted.
 2. This section has been deleted.
 3. This section has been deleted.
 4. Transportation corridor fringe parking facilities.
 5. Construction of new truck weigh stations or rest areas.
 6. Approvals for disposal of excess right of way or for joint or limited use of right of way, where the proposed use does not have significant adverse impacts.
 7. Approvals for changes in access control.
 8. Construction of new bus storage and maintenance facilities in areas used predominantly for industrial or transportation purposes where such construction is not inconsistent with existing zoning and located on or near a street with adequate capacity to handle anticipated bus and support vehicle traffic.
 9. Rehabilitation or reconstruction of existing rail and bus buildings and ancillary facilities where only minor amounts of additional land are required and there is not a substantial increase in the number of users.

10. Construction of bus transfer facilities (an open area consisting of passenger shelters, boarding areas, kiosks and related street improvements) when located in a commercial area or other high activity center in which there is adequate street capacity for projected bus traffic.
11. Construction of rail storage and maintenance facilities in areas used predominantly for industrial or transportation purposes where such construction is not inconsistent with existing zoning and where there is no significant noise impact on the surrounding community.
12. Acquisition of land for hardship or protective purposes. Hardship and protective buying will be permitted only for a particular parcel or a limited number of parcels. These types of land acquisition qualify for a CE only where the acquisition will not limit the evaluation of alternatives, including shifts in alignment for planned construction projects, which may be required in the NEPA process. No project development on such land may proceed until the NEPA process has been completed.
 - (i) Hardship acquisition is early acquisition of property by the applicant at the property owner's request to alleviate particular hardship to the owner, in contrast to others, because of an inability to sell his property. This is justified when the property owner can document on the basis of health, safety or financial reasons that remaining in the property poses an undue hardship compared to others.
 - (ii) Protective acquisition is done to prevent imminent development of a parcel which may be needed for a proposed transportation corridor or site. Documentation must clearly demonstrate that development of the land would preclude future transportation use and that such development is imminent. Advance acquisition is not permitted for the sole purpose of reducing the cost of property for a proposed project.
 - a. Where a pattern emerges of granting CE status for a particular type of action, the FHWA will initiate rulemaking proposing to add this type of action to the list of categorical exclusions in paragraph (c) or (d) of this section, as appropriate.
13. Actions described in paragraphs (c)(26), (c)(27), and (c)(28) of this section that do not meet the constraints in paragraph (e) of this section.
 - a. Actions described in (c)(26), (c)(27), and (c)(28) of this section may not be processed as CEs under paragraph (c) if they involve:
 - (1) An acquisition of more than a minor amount of right-of-way or that would result in any residential or nonresidential displacements;
 - (2) An action that needs a bridge permit from the U.S. Coast Guard, or an action that does not meet the terms and conditions of a U.S. Army Corps of Engineers nationwide or general permit under section 404 of the Clean Water Act and/or section 10 of the Rivers and Harbors Act of 1899;

- (3) A finding of “adverse effect” to historic properties under the National Historic Preservation Act, the use of a resource protected under 23 U.S.C. 138 or 49 U.S.C. 303 (section 4(f)) except for actions resulting in *de minimis* impacts, or a finding of “may affect, likely to adversely affect” threatened or endangered species or critical habitat under the Endangered Species Act;
- (4) Construction of temporary access, or the closure of existing road, bridge, or ramps, that would result in major traffic disruptions;
- (5) Changes in access control;
- (6) A floodplain encroachment other than functionally dependent uses (e.g. bridges, wetlands) or actions that facilitate open space use (e.g., recreational trails, bicycle and pedestrian paths); or construction activities in, across or adjacent to a river component designated or proposed for inclusion in the National System of Wild and Scenic Rivers.

.23 NEPA Class III Projects (EA) – Actions that have uncertain or poorly understood impacts on the environment. The EA determines the extent and level of environmental impact. An EA may support a NEPA Finding of No Significant Impact (FONSI) or indicate that an EIS is warranted. The content and complexity of an EA will vary depending on the project. See Appendix C of the *NEPA Categorical Exclusions – A Guidebook for Local Agencies* and the EM for details on EA procedures and documentation requirements.

24.3 Early Project Coordination & Environmental Mitigation

Many projects require early coordination with a range of federal, state, local agencies and tribal governments to ensure there are a minimum of delays to permitting and construction. Local agencies are encouraged to coordinate and communicate with federal, state and local agencies and tribal governments to discuss technical issues. However, discussions related to environmental mitigation require the advance participation by the FHWA Area Engineer and/or the designated Local Programs Environmental Engineer to assure that all parties understand whether potential environmental mitigation measures will be eligible for federal reimbursement prior to a commitment being made.

Note that all elements of Emergency Repair (ER) project work require advance coordination and approval by FHWA to ensure that Federal participation is allowable.

When there are multiple federal lead agencies, early coordination between those agencies is crucial to ensure that all agencies’ NEPA requirements are met.

24.4 Project Re-Evaluation

Whenever single or cumulative conditions have occurred that might cause new or more severe environmental impacts, the local agency shall re-evaluate an environmental document.

A written re-evaluation is required when any one of the following conditions exists:

1. There is a change to the project scope. This requires a reevaluation even if the NEPA approval is less than three years old. (Some kinds of scope changes, such as those that include work outside of the previous study areas, are likely to result in a determination that a supplemental NEPA document is needed.)
2. An acceptable FEIS has not been submitted to FHWA within three years from the date of the DEIS circulation.
3. Federal approvals of major steps to advance the project (such as FHWA approval to acquire right of way or approval of PS&E) have not occurred within three years of NEPA approval (that is, FHWA's approval of the NEPA CE Documentation Form, issuance of a FONSI, or ROD).
4. There is a law change that is relevant to the information provided in the original document (i.e., a new species is listed as threatened or endangered under ESA). This is required even if the NEPA approval is less than three years old.
5. New information or circumstances relevant to environmental concerns and bearing on the proposed action or its impacts would result in significant environmental impacts not evaluated in the NEPA document. (This is likely to result in a determination that a supplemental NEPA document is needed.)

The re-evaluation needs to indicate whether any new information is known that alters the previous analysis and findings. If so, the local agency needs to conduct appropriate environmental studies to support the updated conclusions.

The re-evaluation is submitted in written form to the Region LPE. The Region LPE will transmit a copy of the re-evaluation to Local Programs for review and coordination with FHWA. Based on the findings of the re-evaluation, FHWA will determine if additional documentation is appropriate (for example, a supplemental EIS, updated EA or NEPA CE Documentation Form, depending on the original NEPA classification).

24.5 Supplemental Document

If a project re-evaluation results in a determination that the NEPA document must be supplemented, the supplement should follow the same procedures as those used for the original document. The scope of the supplement can be limited to the changes to the project. FHWA should be consulted regarding the scope and disciplines that must be analyzed.

24.6 Other Federal Requirements

The NEPA document must include information on how the project complies with other federal regulations and requirements. The federal requirements that most frequently pose the greatest risk to project schedules and timelines are those addressing cultural resources (Section 106 of the National Historic Preservation Act), federally listed endangered species (Section 7 of ESA) and parklands and historic properties (Section 4(f) of the Department of Transportation Act). The *NEPA Categorical Exclusions – A Guidebook for Local Agencies* provides guidance on meeting the federal regulations and requirements that must be considered under NEPA.

24.7 Tribal Consultation

In addition to the Section 106 process, FHWA and local agencies must consult with the affected tribes on projects that potentially affect treaty rights. Local Programs process for sharing discipline reports with tribes is described in the *NEPA Categorical Exclusions – A Guidebook for Local Agencies* (Appendix I). Tribal contact information is available online at www.wsdot.wa.gov/tribal/tribalcontacts.htm.

24.8 Environmental Permitting

The local agency is responsible for ensuring that all required permits and approvals are obtained prior to initiating construction. The links below will direct users to a brief description of the federal, state, and local environmental permits.

- Federal Permits (www.wsdot.wa.gov/environment/permitting/permitfsl.htm)
- State Permits (www.wsdot.wa.gov/environment/permitting/state.htm)
- Local Permits (www.wsdot.wa.gov/environment/permitting/local.htm)

The Governor's Office of Regulatory Assistance has developed a web-based tool to assist users to identify the permits that are required for different types of projects. This tool can be accessed at <http://apps.ecy.wa.gov/opas/>.

24.9 Appendices

24.81 NEPA Categorical Exclusion Documentation Form

24.10 NEPA Categorical Exclusions – A Guidebook for Local Agencies

www.wsdot.wa.gov/nr/rdonlyres/87901eb4-008a-43a0-9db7-2179e0bc939f/0/ecsguidebooksecure.pdf

24.11 Environmental Manual

www.wsdot.wa.gov/publications/manuals/m31-11.htm

24.12 Plain Talk Toolkit

wwwi.wsdot.wa.gov/library/pttoolkit.htm

24.13 Reader-Friendly Tool Kit

www.wsdot.wa.gov/environment/readerfriendly.htm

NEPA Categorical Exclusion Documentation Form



**Washington State
Department of Transportation**

NEPA Categorical Exclusion Documentation Form

Federal Aid Project Number		NEPA Start Date		Intent of Submittal <input type="checkbox"/> Preliminary <input type="checkbox"/> Final <input type="checkbox"/> Re-Evaluate	
Agency			Project Title		
County					
Beginning terminus: _____			Township(s): _____		
Ending terminus: _____			Range(s): _____		
Miles: _____			Section(s): _____		

Part 1 - Project Description (Attach Vicinity Map)

Part 2 - Categorical Exclusion & STIP

- Identify one CE from 23 CFR 771.117 (CE Guidebook - Appendix A) that fits the entire project
- Per 23 CFR Part 452(l) identify the subsequent project phase identified on the STIP? ROW Construction
- Attach a copy of the STIP page to the CE documentation form.

NEPA Approval Signatures

Local Agency Approving Authority Date Local Programs Environmental Engineer Date

Regional Local Programs Engineer Date Federal Highway Administration Date

Completed By (Print Official's Name)	Telephone (include area code)	E-mail Address
--------------------------------------	-------------------------------	----------------

DOT Form 140-100
Revised 12/2019

Part 3 - Permits, Approvals & Right of Way (ROW)								
Yes	No	Permit or Approval			Yes	No	Permit or Approval	
<input type="checkbox"/>	<input type="checkbox"/>	Corps of Engineers	<input type="checkbox"/> Sec. 10	<input type="checkbox"/> Sec. 404	<input type="checkbox"/>	<input type="checkbox"/>	Water Quality Certification - Section 401	
		<input type="checkbox"/> Nationwide Type _____ <input type="checkbox"/> Individual Permit No. _____			<input type="checkbox"/>	<input type="checkbox"/>	Issued By _____	
<input type="checkbox"/>	<input type="checkbox"/>	Coastal Zone Management Certification			<input type="checkbox"/>	<input type="checkbox"/>	Tribal Permit(s) (if any) _____	
<input type="checkbox"/>	<input type="checkbox"/>	Critical Areas Ordinance (CAO) Permit			<input type="checkbox"/>	<input type="checkbox"/>	Other Permits (List) _____	
<input type="checkbox"/>	<input type="checkbox"/>	Forest Practices Act Permit			<input type="checkbox"/>	<input type="checkbox"/>	Is permanent ROW acquisition needed? If yes, amount needed: _____ (acres/sq. ft.).	
<input type="checkbox"/>	<input type="checkbox"/>	Hydraulic Project Approval			<input type="checkbox"/>	<input type="checkbox"/>	Is any temporary ROW needed?	
<input type="checkbox"/>	<input type="checkbox"/>	Local Building or Site Development Permits			<input type="checkbox"/>	<input type="checkbox"/>	Is relocation required?	
<input type="checkbox"/>	<input type="checkbox"/>	Local Clearing and Grading Permit			<input type="checkbox"/>	<input type="checkbox"/>	Has ROW (property and/or property interests) been acquired for this project prior to the NEPA start date? If yes, documentation demonstrating compliance with 23 CFR 710.501 may be required.	
<input type="checkbox"/>	<input type="checkbox"/>	National Pollutant Discharge Elimination System (NPDES) Baseline General for Construction			<input type="checkbox"/>	<input type="checkbox"/>	Is a detour required? If yes, please attach detour information.	
<input type="checkbox"/>	<input type="checkbox"/>	Shoreline Permit						
<input type="checkbox"/>	<input type="checkbox"/>	State Waste Discharge Permit						
<input type="checkbox"/>	<input type="checkbox"/>	Water Rights Permit						

U.S. Coast Guard Permitting

- a. Does the project propose any new or modify **any** existing bridges or culverts crossing a waterway? Yes No
- b. If Yes, attach a copy of the jurisdictional determination email or letter from the U.S. Coast Guard.

Other Federal Agencies - Does the project involve any federal properties, approvals or funding from other/additional federal agencies? Yes No If Yes, please describe.

Part 4 - Environmental Considerations

Will the project involve work in or affect any of the following? Identify proposed mitigation. Attach additional pages or supplemental information if necessary.

1. Air Quality - Identify any anticipated air quality issues.

- Is the project exempt from Air Quality conformity requirements? Yes No
- a. If Yes, identify exemption - please refer to Appendix G in the CE Guidebook for a list of exemptions.
- b. Is the project included in the Metropolitan Transportation Plan? Yes No
If Yes, date Metropolitan Transportation Plan was adopted _____
- c. Is the project located in an Air Quality Non-Attainment Area or Maintenance Area for carbon monoxide, ozone or PM 10 or PM 2.5? Yes No

2. Critical and Sensitive Areas

- a. Is this project within a sole source aquifer? Yes No
If located within a sole source aquifer, is the project exempt from EPA approval?
If Yes, please list exemption: _____
If No, date of EPA approval: _____
- b. Will this project impact Species/Habitat other than ESA listed species? Yes No Explain your answer.
- c. Is this project within one mile of a Bald Eagle nesting territory, winter concentration area or communal roost?
 Yes No If Yes, the local agency must go to the US Fish & Website (<http://www.fws.gov/pacific/eagle/>) and work through the Do I Need a Permit? section.
- d. Are wetland present within the project area? Yes No If Yes, estimate the impact in acres: _____
Please attach a copy of the proposed mitigation plan.

DOT Form 140-100
Revised 12/2019

3. Cultural Resources/Historic Structures - Identify any historic, archaeological or cultural resources present within the project's Area of Potential Effects.

Does the project fit into any of the exempt types of projects listed in Appendix J of the CE Guidebook?

Yes No If Yes, note exemptions below.

If No: Date of DAHP concurrence: _____

Date of Tribal consultation(s) (if applicable): _____

Adverse effects on cultural/historic resources? Yes No

If Yes, date of approved Section 106 MOA: _____

4. Floodplains and Floodways

- a. Is the project located in a 100-year floodplain? Yes No
- b. If Yes, is the project located within a 100-year floodway? Yes No
- c. Will the project impact a 100-year floodplain? Yes No If Yes, describe impacts.

5. Hazardous and Problem Waste - Identify potential sources and type(s).

- a. Does the project require excavation below the existing ground surface? Yes No
- b. Will groundwater be encountered? Yes No
- c. Will any properties be acquired as part of this project? Yes No
- d. Is this site located in an undeveloped area (*i.e.* no buildings, parking, storage areas or agriculture)? Yes No
- e. Is the project located within a one-mile radius of a known Superfund Site? Yes No
- f. Is this project located within a ½-mile radius of a site or sites listed on any of the following Department of Ecology databases?
 Yes No If Yes, check the appropriate boxes below.
 - Voluntary Cleanup Program (VCP), State Cleanup Site (SCS), or Independent Cleanup Program (ICP)
 - Underground Storage Tank (UST)
 - Leaking Underground Storage Tank (LUST)
 - Confirmed and Suspected Contaminated Sites List (CSCSL)
- g. Has site reconnaissance (windshield survey) been performed? Yes No (Please identify any properties not identified in the Ecology or ERS database search as an attachment -- name, address and property use).
- h. Based on the information above and project specific activities, is there a potential for the project to generate, acquire or encounter contaminated soils, groundwater or surface water? Yes No

Please explain:

If you responded Yes to any of these questions above (5A - 5F or 5H), contact your Region LPE for assistance as a "Right-Sized" HazMat Analysis Report/Memorandum most likely will be required.

6. Noise

- a. Does the project involve constructing a new roadway? Yes No
- b. Is there a change in the vertical or horizontal alignment of the existing roadway? Yes No
- c. Does the project increase the number of through traffic lanes on an existing roadway? Yes No
- d. Is there a change in the topography? Yes No
- e. Are there auxiliary lanes extending 1-½ miles or longer being constructed as part of this project? Yes No
- f. If you answered Yes to any of the preceding questions, identify and describe any potential noise receptors within the project area and subsequent impacts to those noise receptors. Please attach a copy of the noise analysis if required.

If impacts are identified, describe proposed mitigation measures.

7. 4(f)/6(f) Resources: parks, recreation areas, wildlife refuges, historic properties, wild & scenic rivers, scenic byways

- a. Please identify and 4(f) properties within the project limits and the areas of impacts.

- b. Please identify any properties within the project limits that used funds from the Land & Water Conservation Fund Act.

- c. Please list any Wild and Scenic Rivers and Scenic Byways within the project limits.

8. Agricultural Lands -

- a. Are there agricultural lands within 300 feet of the project limits? Yes No If Yes, describe impacts:

- b. Are impacted lands considered to be unique and prime farmland? Yes No
 If Yes, date of project review by Natural Resource Conservation Service (NRCS): _____

9. Rivers, Streams (continuous or intermittent) or Tidal Waters

- a. Identify all waterbodies within 300 feet of the project limits or that will otherwise be impacted.

- b. Identify stream crossing structures by type.

DOT Form 140-100
 Revised 12/2019

10. Tribal Lands - Identify whether the project will occur within any Tribal lands, including reservation, trust and fee lands. Please do not list usual and accustomed area.

11. Water Quality/Stormwater

a. Will this project's proposed stormwater treatment facility be consistent with the guidelines provided by either WSDOT's HRM, DOE's stormwater management manual for eastern/western Washington or a local agency equivalent manual?

Yes No

If No, explain proposed water quality/quantity treatment for the new and any existing pollution generating impervious surface associated with the proposed project.

b. Amount of existing pollution generating impervious surface within the project limits: _____

c. Net new pollution generating impervious surface to be created as a result of this project: _____

d. Amount of proposed post-project untreated pollution generating impervious surface: _____

12. Previous Environmental Commitments

Describe previous environmental commitments that may affect or be affected by the project - if any.

13. Environmental Justice - Does the project meet any of the exemptions noted in Appendix L of the CE Documentation Guidebook? Yes No

If Yes, please note the exemption and appropriate justification in the space below.

If No, are minority or low-income populations located within a 0.50-mile of the project? Yes No

If No, attach appropriate data to support findings. If Yes, describe impacts and attach appropriate supporting documentation. Findings should be confirmed using at least two information sources. Please refer to the CE Guidebook for more information.

Part 5 - Biological Assessments and EFH Evaluations

1. Do any listed species potentially occur in the project's action area and/or is any designated critical habitat present within the project's action area? Yes No Attach species listings.

Affected ESA Listed Species	2. Will any construction work occur within 0.25 mile of any of the following?	3. Does the project involve blasting, pile driving, concrete sawing, rock-drilling or rock-scaling activity within one mile of any of the following?
Oregon Spotted Frog proposed critical habitat or suitable habitat?	<input type="checkbox"/> Yes <input type="checkbox"/> No	<input type="checkbox"/> Yes <input type="checkbox"/> No
Yellow-billed Cuckoo suitable habitat?	<input type="checkbox"/> Yes <input type="checkbox"/> No	<input type="checkbox"/> Yes <input type="checkbox"/> No
Spotted Owl management areas, designated critical habitat or suitable habitat?	<input type="checkbox"/> Yes <input type="checkbox"/> No	<input type="checkbox"/> Yes <input type="checkbox"/> No
Marbled Murrelet nest or occupied stand, designated critical habitat or suitable habitat?	<input type="checkbox"/> Yes <input type="checkbox"/> No	<input type="checkbox"/> Yes <input type="checkbox"/> No
Western Snowy Plover designated critical habitat?	<input type="checkbox"/> Yes <input type="checkbox"/> No	<input type="checkbox"/> Yes <input type="checkbox"/> No
Is the project within 0.25 mile of marine waters? If Yes explain potential effects on Killer Whales and on Marbled Murrelet foraging areas.	<input type="checkbox"/> Yes <input type="checkbox"/> No	<input type="checkbox"/> Yes <input type="checkbox"/> No

DOT Form 140-100
Revised 12/2019

Killer Whale designated critical habitat?	<input type="checkbox"/> Yes <input type="checkbox"/> No	<input type="checkbox"/> Yes <input type="checkbox"/> No
Grizzly Bear suitable habitat?	<input type="checkbox"/> Yes <input type="checkbox"/> No	<input type="checkbox"/> Yes <input type="checkbox"/> No
Gray Wolf suitable habitat?	<input type="checkbox"/> Yes <input type="checkbox"/> No	<input type="checkbox"/> Yes <input type="checkbox"/> No
Canada Lynx habitat?	<input type="checkbox"/> Yes <input type="checkbox"/> No	<input type="checkbox"/> Yes <input type="checkbox"/> No
Columbia White-tailed Deer suitable habitat?	<input type="checkbox"/> Yes <input type="checkbox"/> No	<input type="checkbox"/> Yes <input type="checkbox"/> No
Woodland Caribou habitat?	<input type="checkbox"/> Yes <input type="checkbox"/> No	<input type="checkbox"/> Yes <input type="checkbox"/> No
Streaked Horned Lark designated critical habitat or suitable habitat?	<input type="checkbox"/> Yes <input type="checkbox"/> No	<input type="checkbox"/> Yes <input type="checkbox"/> No
Taylor's Checkerspot designated critical habitat or suitable habitat?	<input type="checkbox"/> Yes <input type="checkbox"/> No	<input type="checkbox"/> Yes <input type="checkbox"/> No
Mazama Pocket Gopher designated critical habitat or suitable habitat?	<input type="checkbox"/> Yes <input type="checkbox"/> No	<input type="checkbox"/> Yes <input type="checkbox"/> No
Eulachon designated critical habitat or suitable habitat?	<input type="checkbox"/> Yes <input type="checkbox"/> No	<input type="checkbox"/> Yes <input type="checkbox"/> No
Rockfish proposed critical habitat or suitable habitat?	<input type="checkbox"/> Yes <input type="checkbox"/> No	<input type="checkbox"/> Yes <input type="checkbox"/> No
A mature coniferous or mixed forest stand?	<input type="checkbox"/> Yes <input type="checkbox"/> No	<input type="checkbox"/> Yes <input type="checkbox"/> No

- 4. Will the project involve any in-water work? Yes No
- 5. Will any construction work occur within 300 feet of any perennial or intermittent waterbody that either supports or drains to waterbody supporting listed fish? Yes No
- 6. Will any construction work occur within 300 feet of any wetland, pond or lake that is connected to any permanent or intermittent waterbody? Yes No
- 7. Does the action have the potential to directly or indirectly impact designated critical habitat for salmonids (including adjacent riparian zones)? Yes No
- 8. Will the project discharge treated or untreated stormwater runoff or utilize water from a waterbody that supports or drains into a listed-fish supporting waterbody? Yes No
- 9. Will construction occur outside the existing pavement? If Yes go to 9a. Yes No
 - 9a. Will construction activities occurring outside the existing pavement involve clearing, grading, filling or modification of vegetation or tree-cutting? Yes No
- 10. Are there any Federally listed Threatened or Endangered plant species located within the project limits? If Yes, please attach a list of these plant species within the action area. Yes No
- 11. Does a mature coniferous or mixed forest stand occur within 200' of the project site? Yes No

Analysis for No Effects Determination – If there are any Yes answers to questions in Part 5, additional analysis is required. Attach additional sheets if needed.

DOT Form 140-100
Revised 12/2019

Analysis for RRMP ESA 4(d) determination for NMFS – A local agency must be certified by the Regional Road Maintenance Forum to utilize 4(d).

Maintenance Category (check all that apply)

- | | | |
|--|---|---|
| <input type="checkbox"/> 1. Roadway Surface | <input type="checkbox"/> 6. Stream Crossings | <input type="checkbox"/> 11. Emergency Slide/Washout Repair |
| <input type="checkbox"/> 2. Enclosed Drainage Systems | <input type="checkbox"/> 7. Gravel Shoulders | <input type="checkbox"/> 12. Concrete |
| <input type="checkbox"/> 3. Cleaning Enclosed Drainage Systems | <input type="checkbox"/> 8. Street Surface Cleaning | <input type="checkbox"/> 13. Sewer Systems |
| <input type="checkbox"/> 4. Open Drainage Systems | <input type="checkbox"/> 9. Bridge Maintenance | <input type="checkbox"/> 14. Water Systems |
| <input type="checkbox"/> 5. Watercourses and Streams | <input type="checkbox"/> 10. Snow and Ice Control | <input type="checkbox"/> 15. Vegetation |

Describe how the project fits in the RRMP 4(d) Program:

Effect Determinations for ESA and EFH

If each of the questions in the preceding section resulted in a "No" response or if any of the questions were checked "Yes," but adequate justification can be provided to support a "no effect" determination, then check "No Effect" below. If this checklist cannot be used for Section 7 compliance (i.e., adequate justification cannot be provided or a "may effect" determination is anticipated), a separate biological assessment document is required.

- | | NMFS | USFWS | EFH Determination |
|--|-------|-------|--|
| <input type="checkbox"/> No Effect | _____ | _____ | <input type="checkbox"/> No Adverse Effect |
| <input type="checkbox"/> NLTAA - Date of Concurrence | _____ | _____ | <input type="checkbox"/> Adverse Effect - Date of NMFS concurrence _____ |
| <input type="checkbox"/> LTAA - Date BO Issued | _____ | _____ | |
| <input type="checkbox"/> RRMP 4(d) | _____ | _____ | <input type="checkbox"/> Not Applicable |

Part 6 - FHWA Comments

25.1 General Discussion

[LP ROW Services website](#)

The Washington State Department of Transportation (WSDOT) has overall responsibility to the Federal Highway Administration (FHWA) for the acquisition, management, and disposal of real property on all FHWA funded transportation projects in the state. WSDOT Local Agency Coordinators act as consulting experts to local governments in Washington State who are acquiring right of way for federally funded transportation projects. They independently provide high-level technical assistance, compliance monitoring, certification compliance reviews, as well as training and project support to local engineering and technical staff, their consultants and right of way professionals on behalf of WSDOT's Local Programs Division (Local Programs).

The acquisition process is regulated by Public Law 91-646 "Uniform Relocation Assistance and Real Property Acquisition Policies Act of 1970, as amended", [49 CFR Part 24, Chapter 8.26 RCW](#) and [WAC 468-100](#). Neither the Uniform Relocation Assistance and Real Property Acquisition Policies Act (URA) nor its implementing regulations at 49 CFR Part 24 allow the certification of right of way (ROW) to be sub-delegated to any agency or any agency with Certification Acceptance (CA) status.

[49 CFR 24.101\(b\)](#)
[49 CFR 24.101\(d\)](#)
[ROW Manual Section 25.2](#)
[LPA-001](#)
[LPA-003](#)

If there is federal funding on ANY phase of the project, Right of Way must be acquired in accordance with the following policies and procedures in order to be eligible for federal funding:

- **Agency's Approved ROW Procedures**
- **Federal/State requirements**
- **The guidelines outlined in this manual**
- **WSDOT's *Right of Way Manual***

The different project phases are the Preliminary Engineering Phase (P.E.), Right of Way phase (ROW), and Construction phase (CN),

ROW acquired prior to July 1, 1971, is exempt from the above policies and procedures. In addition, the local agency must comply with Title VI requirements identified in [Chapter 28](#).

[23 CFR 710.201\(h\)](#)

WSDOT may, by written agreement (approved ROW Procedures), use the services of land acquisition organizations of counties, municipalities, or other state or local governmental agencies for acquiring rights of way for FHWA projects. Any such organization may be used only if it is adequately staffed, equipped, and organized to provide such services, and if its practices and procedures are in substantial conformity with WSDOT accepted procedures.

It is the responsibility of WSDOT to fully inform political subdivisions of their responsibilities in connection with federally-assisted transportation projects and to provide training to the local agencies. It is the local agencies' responsibility to comply with the requirements of this chapter, the URA, and [49 CFR Part 24](#). The local agency will assess their staff's level of expertise with the requirements stated above. If the local agency determines their staff does not fully understand these requirements, it is their responsibility to request assistance and/or training to ensure the acquisition process is followed correctly.

It is essential that local agencies and WSDOT communicate freely and work closely together during the entire acquisition process to expedite projects and to assure that all federal and state requirements are met. Early notification to the Region Local Agency Coordinator (LAC) is required for projects with right of way acquisition when there are federal funds in any phase of the project.

.11 WSDOT Services – At the earliest possible date, the local agency should notify the LAC of upcoming federal-aid projects that have ROW activities. In addition, the local agency should advise the LAC of the need for WSDOT assistance. WSDOT is committed to an ongoing program that will provide effective assistance and guidance to local acquiring agencies. To this end, WSDOT will designate an LAC to act as consulting expert to local governments who are acquiring right of way for federally funded transportation projects. The LAC provides oversight and guidance on the federal acquisition process to ensure local agencies are acquiring, managing, and disposing of real property and real property interests consistent with state and federal regulations. ROW activities include title, appraisal, appraisal review, acquisition/negotiation, relocation, and property management activities (collectively referred to as acquisition or acquisition process).

[Chapter 31](#)

.12 Consultant Services – When the local agency does not have adequate staff to perform appraisal, negotiation, or relocation functions, it may contract for these services and obtain federal participation in the costs.

The local agency should contact the Region Local Programs Engineer for assistance in preparing any contract for services to assure FHWA participation in the contract. FHWA has determined that the consultant agreements for ROW services must meet the consultant contracting requirements.

25.2 Approval of Right of Way Acquisition Procedures

23 CFR 710.201(a)

23 CFR 710.201(h)

LPA-001

LPA-003

When an agency intends to use federal funds in any phase of a project, the agency must assure their ROW Procedures are current and approved prior to initiating ROW activities, and must demonstrate at the time of certification that current staff is qualified and that their procedures meet LAG manual requirements. ROW procedures are normally considered current if they are less than three years old, and there have been no changes to staff approved to perform ROW activities within the agency. Procedures will need to be updated for one or more of the following reasons:

1. Staffing changes
2. Approved procedures are more than three years old. However, if the local agency does not have a federal aid project in the foreseeable future, the procedures do not need to be updated even if they are beyond the three-year time period. If the local agency is thinking of doing early acquisition for an unfunded project, the local agency needs to have updated procedures.
3. A change is requested regarding who can perform specified activities.
4. Revisions to the ROW Program, such as statutory, regulatory, or policy changes.

Acquisition procedures are submitted on local agency letterhead to the Region Local Programs Engineer (LPE) for review prior to final execution by the local agency. Region Local Programs forwards the procedures through the LAC for approval. The local agency will be approved to acquire ROW based upon the submitted procedures.

The responsibilities and expectations for each of the agency ROW positions are defined in the Right of Way Procedures form. The level at which an agency will be approved will depend on the agency's staff qualifications. Qualifications should be specific to the right of way function for which the staff is listed. Local Program's notifies the local agency of the approval with a copy to the Region LAC. Periodic reviews of procedures will be conducted by the LAC for agencies acquiring ROW on federal aid projects. If through these periodic reviews it is determined that the local agency acquisition practices are not in full compliance, or the local agency no longer has staff qualified to perform a particular function, then WSDOT will determine what actions are required to achieve full compliance and the use of qualified staff.

Approved procedures will designate the title of the position. When staff changes or additions occur, the agency will submit the person's right of way experience and qualifications to the LAC.

Procedures shall include the following:

1. Agreement to comply with state and federal laws and FHWA regulations. The agency should agree to follow this manual and the [Right of Way Manual M 26-01](#) or the agency's own manual if they have a WSDOT/FHWA approved ROW manual.
2. Agreement will list agency's current staff and position(s) performing the separate functions of program administration, appraisal, appraisal review, acquisition, relocation, and property management. All agency staff who perform any of these separate functions should be listed. **Note:** Agency personnel such as administrators

and members of the executive branch who might participate in the acquisition of ROW for federal aid projects need to be aware that their actions must conform to the Uniform Act and [49 CFR Part 24](#).

[LAG 25.51](#)

[LAG 25.6](#)

[LAG 25.91](#)

3. Resumes for all current staff, including their position(s) and a brief statement of their qualifications pertaining to the function they are performing.

4. Waiver Valuation procedures.

[LAG 25.52](#)

[LPA-003](#)

5. A procedure for handling administrative settlements including the approving authority(s) and process.

[49 CFR 24.10](#)

[RCW 8.26.085](#)

[WAC 468-100-010](#)

[ROW Section 12-5.5](#)

Local Agencies must have a relocation appeal procedure in place, prior to starting relocation activities for any projects involving relocation assistance, as required by federal regulations. The agency shall notify the LAC prior to starting relocation activities.

Note: Local Agencies need to submit FHWA Annual ROW Statistical Report for active federal aid projects by **October 25th each year**. The data provided is for ROW activities from October 1 through September 30 and should reflect parcel activities that occurred within the reporting period.

.21 Acquiring Right of Way – Acquisition of ROW may be performed by the following entities:

- By a local agency that is adequately staffed, equipped, and organized to discharge its ROW responsibilities and has ROW procedures approved by WSDOT-Local Programs. Staff may consist of qualified contract personnel and/or licensed private Real Estate Brokers (see [RCW 18.85](#) in addition to or in lieu of regular employees of the agency).
- By another local agency that meets the requirements above.

25.3 Preliminary ROW Activities

[23 CFR 710.203\(a\)\(3\)](#) There are certain right of way activities that are eligible for preliminary engineering funds if those activities take place prior to National Environmental Policy Act (NEPA) approval or after NEPA approval but prior to the ROW being authorized. Those ROW activities that are eligible are identified in the table below:

Preliminary ROW Acquisition Activities Eligible for Preliminary Engineering Funds 23 CFR 710.203(a)(3)	Pre-NEPA or Post-NEPA & Pre ROW Authorization
Title Searches and Review	X
ROW Planning w/ROW Staff and/or Consultants	X
ROW Plan Preparation	X
ROW Design Development (determining ROW needs)	X
Public Meetings/Hearings (projects w/ROW)	X
ROW Estimates & Schedules (scoping)	X
PFE*/True Cost Estimate	X
Appraisals (including inspections) and Administrative Offer Summary (AOS)*	X
Right of Entry (testing, surveying, etc.)	X
Relocation Plan/Study (includes survey of occupants)*	X

*Completing an appraisal/project funding estimate (PFE)/Relocation Plan during the PE Phase is an agency risk decision. If a local agency chooses to complete an appraisal, PFE, or relocation plan too early, it may require a subsequent update or a new one to be completed again. FHWA cannot pay for an activity twice if the need for the second payment was due to a local agency's business decision. However, if the update is needed due to an unexpected delay beyond the local agency's control, the incurrence of expenses for a second time should be eligible expenses.

Agencies cannot start activities that could be considered negotiations with property owners pre-NEPA for the project, unless they are acquiring under [23 CFR 710.501](#) (LPA funded early acquisition) or Section 710.503 (protective buying and hardship acquisition). Early contact of occupants cannot give the appearance of initiation of negotiations. In addition, if the agency plans to request to use the value of the acquired property as a match, they need to meet the requirements in [23 CFR 710.501](#).

Local Programs conducts billing reviews each year for selected construction projects that will address any non-compliance issues.

25.4 Right of Way Acquisition

Appendix 25.178
LPA-011
LPA-012

When there is federal participation in **any** phase of a project (PE, RW and/or CN), federal regulations **must** be followed. The checklist of Federal Aid Requirements provides useful reminders and should be used as guidance to ensure compliance.

.41 Determining Whether or Not Right of Way (Acquisition) is Needed

1. **ROW (acquisition) Needed** is defined as land or property rights or interests necessary for construction, operation and/or maintenance of the proposed project, or any prior (advanced/early) acquisition that was acquired specifically for the current project. This includes temporary rights required to complete the construction as shown on the Plan, Specification & Estimate (PS&E) (such as placing personnel, materials, equipment, and machinery outside of existing ROW). If the property and/or property rights were acquired specifically for this project prior to NEPA start date the agency may be required to demonstrate compliance with [23 CFR 710.501](#). The agency should contact their region LPE and Environmental Engineer to determine whether additional documentation is required. If the property was purchased for use on the current project (e.g. advanced/early acquisition), then the ROW must have been acquired in accordance with the requirements of this manual.

Appendix 25.174
Appendix 25.175

Advanced/early acquisition is defined as prior acquisition of property and/or property rights or interests that was completed specifically for the current project prior to NEPA approval. This does not include properties within the existing ROW that were purchased as part of a previous project. Regardless of the funding source, advanced/early ROW acquisition parcels must be included in the ROW Certificate. Contact the LAC if you have questions.

- If it is later determined that ROW is needed, either a PFE or a True Cost Estimate, as applicable, a ROW Plan, and a Relocation Plan (if required) must be prepared and submitted to the Region LPE who will notify the Region LAC (who is responsible for review and approval). There are significant differences between the two forms of estimates and care must be used when selecting either the PFE or True Cost Estimate process. The Region LAC should be consulted when this decision is to be made. See Subsection 25.46 for explanations and requirements of the PFE and the True Cost Estimate.

2. **No ROW (acquisition) Needed** means that the proposed project can be built entirely within the agency's existing ROW. Existing ROW is defined as land already incorporated into the roadway facility or land certified under a previous federal aid project. Leases, permits and easements for construction activities, slopes, drainage, etc., whether temporary or permanent, are considered ROW acquisition.

If it can be documented that the land or property rights/interests were purchased for a purpose other than the transportation related project being certified then the Uniform Act and [49 CFR Part 24](#) requirements do not apply. This would be considered existing right of way.

LAG 25.44

[Appendix 25.174](#)[Appendix 25.175](#)[Appendix 25.176](#)[Appendix 43.62](#)

It is the responsibility of the local agency to determine that “No ROW” is needed for a project at the time the Design Approval Documentation form is completed and prior to the obligation of funding. This can be accomplished by applying the Sufficient Property Rights Flowcharts. The agency will complete and sign the Design Approval Documentation form that acknowledges they have completed reviewing existing property rights. In the case of a non-CA agency, the agency will work with the LPE. The No ROW Needed Verification Checklist is a tool that can be used during the local agency’s ROW determination process. Once the project has been fully designed and prior to advertising the project for construction, the agency shall verify that No ROW is needed for the project. Local agency staff must be qualified to sign acknowledging the ROW part of the Design Approval Documentation form and to perform the Program Administration function under their Approved ROW Procedures. Local Programs will provide training to local agency staff responsible for these functions. The training will focus on the importance of reviewing the PS&E to make sure it is consistent with the no ROW determination. Local Programs will maintain a list of CA agency reviewers who have completed the training. Non-CA agencies will need to work with WSDOT Local Programs staff to complete the verification process.

If ROW needs change, the agency will follow the current process of updating the design approval, project prospectus, and NEPA. It is also recommended that the agency provide an amendment to the Statewide Transportation Improvement Program (STIP).

.42 Acquiring Sufficient Property Rights – A local agency must acquire real property interests that are adequate for the construction, operation, and maintenance of the project ([23 CFR 1.23](#) and [710.201\(e\)](#)). The preference is for local agencies to purchase fee rights or temporary and permanent easements. However, there are circumstances when other real property interests can be considered. The details of these circumstances should be discussed with the LAC prior to submitting the Right of Way Plan for approval.

If the local agency is considering acquiring something other than fee or permanent easement real property interests, then they must provide documentation establishing how the real property interests they are acquiring satisfy the requirement for sufficient property rights. FHWA must be assured that their investment in the project is in the public interest and will last for a reasonable amount of time that is commensurate with the level of investment. There are no set guidelines that describe the appropriate term length, but 20 years is the absolute minimum term that should be considered. Longer terms may be required, and the higher the federal investment, the longer the term expected by FHWA. An analysis of the design life of the improvement must be done and the minimum term must equal the design life. Unless leases are with public agencies, leases should be considered only under rare and unusual circumstances since they typically have termination clauses that could require the removal of improvements with little notice, and possibly without cause. Things to consider include:

- Is the term of the real property interest at least as long as the life cycle of the improvement? When will major maintenance be required and does the property interest term extend to when the first major maintenance is expected?

- What is the likelihood for renewal of the term of the real property interest, or invocation of any provision for its termination?
- Can a rational explanation of why the project is a good investment for FHWA under such circumstances be provided?
- If the rights acquired are from a governmental agency, is there anything in their regulations that prevent them from granting the rights requested?

Note: If FHWA does not accept the local agency's justification, they must be prepared for FHWA to either make a finding that they have not acquired sufficient property rights (which would preclude ROW certification) or FHWA may consider a conditional approval that would require the local agency to either repay the project funding or reestablish a replacement improvement in a new location with their own funds (and the right of way for the new location must have been acquired in accordance with the Uniform Act).

The following situations are considered to be sufficient, and do not require the agency to complete a justification to be submitted for FHWA approval:

- **DNR aquatic lands** – DNR typically grants only term easements for uses of state-owned aquatic lands. The term of an easement will normally not exceed 30 years and is not renewable by policy. A new easement may be applied for one year in advance of the current easement agreement term expiration.
- **BPA (Bonneville Power Administration)** – BPA typically grants only revocable permits (Land Use Agreement Fee) for uses under their power lines.
- **WSDOT** – WSDOT typically grants only term leases and/or easements for uses of their property.
- **Bureau of Indian Affairs (BIA)** – BIA policy may vary by tribe as not all tribes are willing to grant permanent easements. Some tribes may grant only a non-permanent easement.

Government-Acquisitions (Political Subdivisions) – Examples of political subdivisions of the state of Washington are state, federal, counties, cities, towns, school districts, irrigation districts, etc. Government agencies are entitled to just compensation for the acquisition of property rights needed for federal aid transportation projects and the provisions of the URA will apply. Acquiring permanent rights or less than fee long-term rights should be done in accordance with Chapter 6 of the ROW Manual; however, there may be some deviation of URA requirements as legal authority may control how agencies transfer real property to other agencies.

The provisions of the URA ([49 CFR 24](#)) may not apply if the local agency needs to acquire temporary property rights from another agency to construct your project. The acquisition of these rights are generally through mutual consent and agreement between agencies using a permit or interlocal agency agreement. The risk is low that government agencies will not acquire the temporary proper rights from each other when constructing their federally funded transportation projects. WSDOT is making a risk-based decision to not certify temporary property rights acquired under a permit or interlocal agency agreement if there is mutual consent between agencies and the agencies have complied with the laws and regulations pertaining to the conveyance of property rights. In addition, a ROW phase will not be triggered if an agency only needs temporary property rights from another agency and no other rights are acquired for the project.

[ROW Chapter 11](#)

Use of WSDOT Property – The LAC should be contacted immediately when it is determined that the local agency project requires the use of WSDOT’s property. The LAC will advise the local agency of the process and timeline needed to acquire sufficient legal rights to construct and operate on WSDOT property. The length and type of use of WSDOT property will determine if it will be considered an acquisition and subject to certification requirements. If a local agency requires temporary use of property owned by WSDOT for the construction of a transportation project and those rights are obtained under a WSDOT general permit or agreement, WSDOT will not consider this part of the acquisition process and the permit would not be subject to ROW certification. This also applies if a local agency obtains permanent rights from WSDOT through a relinquishment. These activities are governed by 23 CFR Part 710 Subpart D, Real Property Management and are not Uniform Act activities, nor activities which must be addressed under the certification requirements found in federal regulations. The acquisition of all other permanent property rights and/or property interests acquired from WSDOT for a federally funded local agency project is subject to certification requirements. Your agency will need to work closely with the appropriate region Real Estate Services staff to acquire the necessary property rights.

[23 CFR 710.409](#)[23 CFR 620](#)[23 CFR 635.309](#)[Appendix 25.175](#)**.43 Determining Acquisition of Property and/or (Sufficient) Property Rights**

Fee – Fee title should be acquired when the agency needs the exclusive use and occupancy of the property for itself. Fee simple is the unqualified ownership and power of disposition of property; all rights to control, use, and transfer the property at will are acquired.

Easements – An easement is a transfer of an interest in land from one party to another providing a right or privilege to enjoy the property or a part of it for a particular, specific purpose that is not inconsistent with the owner’s use and enjoyment. Easements can be temporary, permanent, or for a specified term.

Permanent Easements – A permanent (perpetual) easement may be acquired when the agency needs a non-exclusive right to enter upon the property of another. A permanent easement for road, street, or highway purposes should include, but not be limited to, the right to occupy, construct, control, operate, maintain, and reconstruct the facility.

[LAG 25.42](#)

Non-Permanent Easements – An easement that has a defined term and expiration date. Some property owners, including state/federal agencies, are unwilling to grant permanent easements. Term easements may be acceptable provided the term equals the design life.

Temporary Easements – A temporary easement is used when the agency requires a property right which is temporary in nature, but are not part of the permanent right-of-way. Temporary rights expire by the terms in each individual temporary easement.

[49 CFR 24.101\(c\)\(2\)](#) **Permits** – A permit or right of entry is not an interest in land. It only provides basic permission to enter upon property to a named entity for a specific purpose, usually for a specific period of time. It cannot be transferred and can be terminated or revoked by the owner at will. In most situations, permits are used when no other property rights are to be acquired from the same ownership as part of the same project, and are normally obtained without the payment of compensation (commonly referred to as mutual benefits) because the provisions of the Uniform Act do not apply in these situations. The term mutual benefit is not defined in federal regulations and is often misunderstood and incorrectly applied by agencies to federal aid transportation projects. The use of a permit is acceptable when your agency is solely performing work exclusively for the benefit of the property owner, would not create a compensable damage, and is not needed to construct your project. Permits can be used with other agencies to perform work on their property, such as tying into another roadway. Permits are generally not considered sufficient to construct, operate or maintain proposed projects. When considering the use of permits or other property rights such as leases, rights of entry, land use licenses, etc. consult with the LAC.

[LAG 25.42](#) All rights acquired for the project, including advanced/early acquisitions must be shown on the right of way plan.

Property Right vs Right to Enter

	Property Right	Right to Enter (Permit)
ROW Chapter 6	Required/needed for the project	Not required/needed for the project
Exempt	Element of project design	Not part of project design
RCW 18.85.151(6)	Prior to offer	Post offer
RCW 18.85.081	Mitigation for compensable damage	Requested by owner
	Show rights on ROW plan	Not shown on ROW plan
	Valuation includes cost of item	No compensation paid
	Temporary Construction Easement (TCE) obtained	Permit obtained
	Transfers with ownership	Non-transferrable
	Sufficient for construction	Not sufficient for construction

[23 CFR 710.501\(a\)](#)
[NEPA Categorical Exclusions – A Guidebook for Local Agencies](#)

.44 Early/Advance Acquisitions – *Early acquisition* is defined in federal regulations, as the “...acquisition of real property by State or local governments in advance of Federal authorization or agreement.” In practical use, early acquisition refers to the acquisition of real property prior to the final NEPA decision on a project: The Record of Decision (ROD), for projects developed with an Environment Impact Statement (EIS); a Finding of No Significant Impact (FONSI), for projects developed with an Environmental Assessment (EA); or, a Categorical Exclusion (DCE/ECS). WSDOT has two types of early acquisitions; those that occur prior to the initiation of NEPA and those that occur after the initiation of NEPA but prior to NEPA approval.

1. Concurrent Early Acquisition-After the initiation of NEPA but prior to its approval.
2. Advanced Acquisition-Refers specifically to hardship acquisitions and protective buying. It is discussed further in subsection 4 below.

In each case, federal guidelines must be followed in the acquisition process. The local agency should place copies of any documentation pertaining to early or advance acquisition approval in the parcel acquisition file if it is required as described below. In addition, note the date and actions pertaining to such approval in the parcel acquisition diary.

An agency may use eminent domain, but the agency must be able to prove public use and necessity, which may be difficult when the environmental alternatives have not been evaluated or selected. The use of eminent domain on a locally-funded acquisition in advance of a project NEPA approval is a decision that the local agency should make after undertaking a risk analysis to determine if they want to proceed with the acquisition using eminent domain. The risk analysis should consider if the proposed project has multiple alignments that could be considered to address the transportation issue. If there is only one obvious alignment, the local agency's ability to prove public use and necessity is good, which makes the risk low. If there are multiple alignments to address the transportation issue, then the local agency should determine the property needs for the multiple alignments. If each alignment requires different parcels to address the transportation issue, then the agency's ability to prove public use and necessity may be low due to uncertainty of the need for the parcel, and the risk is higher.

23 CFR 710.501

For all early acquisitions prior to the initiation of the NEPA process, the local agency must show that the early acquisition did not influence the project through the decision or need to construct the project, the consideration of alternatives, or the selection of the design or location of the proposed improvement and demonstrate compliance with [23 CFR 710.501](#). The agency should contact their region LPE and Environmental Engineer to determine whether additional documentation is required. If NEPA cannot be approved, then the agency cannot incorporate the parcel into the project. If the project cannot be built without the parcel, then the entire project may be ineligible for federal funding. Concurrent early acquisition parcels will be covered under the overall NEPA evaluation.

23 CFR 710.501(b)

An agency may apply market value (or if donated, the current appraised value) toward their share of project costs, as long as they meet the requirements of [23 CFR 710.501\(b\)](#). The acquisition of early or advance ROW must not influence the environmental assessment for the project. Properties with a 4(f) Resource may not be purchased if the agency wants to apply the market value toward their share of project costs. The agency can only request match for the Just Compensation plus the Administrative Settlement, if applicable. The costs of the appraisal or any other documentation necessary to meet the requirements of [23 CFR 710.501\(b\)](#) are not eligible to be used as a match.

Appendix 25.177

Early and Advanced Acquisition Alternatives. There are five alternative methods (item #4 has two methods) of early and advanced acquisition provided in federal statutes and regulations. Each alternative has distinct conditions which must be met, as described below. However, there are certain specific conditions that every alternative must meet:

- The property must be lawfully obtained.
- The acquisition must fully comply with the Uniform Relocation Assistance and Real Property Acquisition Policies Act of 1970, as amended.

- Per 23 CFR 701.501(c)(5) and 771.113(d)(4) and 40 CFR 1506.1, these early acquisitions cannot have an adverse environmental impact or limit the choice of reasonable alternatives in the NEPA analysis for the project, or have an adverse environmental impact on the parcel. (e.g. If a building that would have been determined to be eligible for the National Register of Historic Places is acquired and demolished, this would be an adverse environmental impact on the parcel).
- Local agencies will not do early acquisition on properties that are protected under section 4(f) of the Department of Transportation Act of 1966, codified at 23 USC 138, and the regulations at 23 CFR 774.
- The acquisition must fully comply with Title VI of the Civil Rights Act of 1964.

Early Acquisition Options:

23 CFR 710.501(b)

1. **Agency-Funded, No Match or Reimbursement** – The agency may initiate acquisition of real property, using local funds, at any time it has legal authority to do so, based on program or project considerations prior to NEPA clearance. Pre-approval of the use of this option is not required from FHWA, and this option can be useful for corridor preservation, access management, or similar purposes. This option is used when the local agency will not be seeking either reimbursement or matching credit from FHWA. As noted above in the early acquisition alternatives, this alternative must fully comply with the Uniform Act and not have adverse environmental impacts or limits the choice of reasonable alternatives in the NEPA analysis for the project or the parcel.

23 CFR 710.501(c)

2. **Agency-Funded with Matching Credit** – In order for the Agency to use the acquisition costs of early acquisition as a credit toward the Agency’s matching share of a federal-aid project, the FHWA must concur in a written determination provided by the Agency that the acquisition did not influence the environmental assessment for the project or the parcel, including:
 - The decision on the need to construct the project.
 - The consideration of alternatives.
 - The selection of the design or location.
 - A statement that the property will be incorporated into a Federal-aid project.
 - The original project agreement covering the project was executed on or after June 9, 1998.

In determining the costs to apply credit for the matching share of the project, the local agency will use the historic cost of the acquisition. This cost is limited to the amount that was paid to acquire the property at the time of its acquisition, and excludes appraisal fees, relocation costs, and any other costs incurred beyond the acquisition price itself. When the historic acquisition costs cannot be reasonably obtained, or such cost was not typical for the time due to extenuating circumstances, the local agency may use the current fair market value of the property.

3. **Local-Funded with Reimbursement** – This option is not currently available in Washington State. [23 CFR 710.501\(d\)](#)

[23 CFR 710.501\(e\)](#)

4. **Federal-Funded Early Acquisition** – Consistent with federal legislation commonly referred to as MAP-21 (Moving Ahead for Progress in the 21st Century), a local agency may program an early acquisition project in the STIP and, after meeting the additional conditions listed below, request authorization to proceed with the acquisition and obtain federal funding participation. This early acquisition alternative is particularly useful for doing corridor preservation, as it does not require that the agency have a specific transportation project programmed or in development at the time the early acquisition, using federal funds is carried out.

There are some specific conditions that apply to this alternative:

- The early acquisition project must be included in the STIP.
- A NEPA analysis must be performed for the scope of the early acquisition project, and must be approved by FHWA. In most cases, if the purpose and need for this project is simply to acquire property and hold it until needed for a transportation project, the NEPA clearance would be done with a DCE/ECS. For the purpose of the NEPA analysis, and consistent with the federal requirement, an early acquisition project under this alternative is considered to have independent utility.
- Although the agency must follow the Uniform Act, as required for all other early acquisition alternatives, early acquisition under this alternative may not be carried out under the threat of eminent domain. If an agreement cannot be negotiated with a property owner, the agency will have to wait until a specific transportation project requiring this property has been completed through the NEPA process and FHWA funding is authorized for such project.
- Real property interests acquired under this option may not be developed until a specific transportation project requiring this property has been completed through the NEPA process and FHWA funding is authorized for such project.
- If the real property acquired under this alternative is not incorporated within 20 years in a project eligible for FHWA funding, FHWA will offset the State's federal funding by the amount of federal funds used in this early acquisition project.

[23 CFR 710.503\(a\)](#)

5. **Hardship Acquisition and Protective Buying (Advanced Acquisition Options).** In addition to the early acquisition options set out in 1 thru 4, federal regulations provide for doing advance acquisition under two options: Hardship and Protective Buying. (Unless otherwise stated elsewhere in this manual, the term “advance acquisition” will be understood to apply specifically to hardship and protective acquisition.) Normally, these two options will apply to a limited number of properties, whereas the early acquisition provisions of 1 thru 4 may apply to some or all properties on a project. Both options must meet these conditions:
- The project must be included in the currently approved STIP.
 - The state must have complied with the public involvement requirements addressed in federal regulations at 23 CFR parts 450 and 771.
 - If applicable, the Section 4(f) determination must have been made on these properties.
 - If applicable, the Section 106 requirements of the National Historic Preservation Act must have been completed on these properties.

- All other required NEPA clearances must have been completed on these properties.
- The conditions set out in Section 25.44 above also apply to hardship and protective buying.
- For federally-funded projects, FHWA approval for doing a hardship or protective acquisition is required.
- NEPA approval will be secured by following the 2015 Programmatic Categorical Exclusion Agreement.

23 CFR 710.503(c)

- A. **Hardship Acquisition** – A hardship acquisition is initiated by a property owner, not the acquiring agency, when the property owner provides a written statement that:
- Supports the hardship on the basis of health, safety, or financial reasons, and that remaining in the property would pose an undue hardship compared to others.
 - Documents the inability to sell the property at fair market value, within a time period that is typical for properties not impacted by the impending project.

Because hardship acquisitions are initiated by the property owner, this advance acquisition option is not practical as a part of WSDOT's project schedule. Note, also, that the state is NOT required by federal regulation to agree to a hardship purchase request.

23 CFR 710.503(d)

- B. **Protective Buying** – In order to do advance acquisition of a property under this option, the local agency must clearly demonstrate to FHWA (on federally-funded projects) that development of the property is imminent and such development would limit future transportation choices. A significant increase in cost may be considered as an element justifying a protective purchase.

Processing Early and Advanced Acquisitions. The decision whether to proceed with one of the early or advance acquisition options will be made by the local agency. In either case, if FHWA approval is required, as discussed in the earlier sections of this chapter, the request for FHWA approval will be processed through the Local Programs ROW section. It is important to remember that the standard acquisition process, as set out in this chapter, applies to early and advance acquisitions. The main difference between standard acquisition and early or advance acquisitions is that the latter often require additional documentation, such as the approval by FHWA of a request to do an advance acquisition.

49 CFR 24.101(b)(1)

WAC 468-100-101(2)(a)

49 CFR 24 Appendix A

.45 Voluntary Acquisition – A process called “Voluntary Acquisition,” which differs from “Donations and Willing Seller Transactions,” may on rare occasion be appropriate for acquisition of property, but only if all of the following circumstances apply:

- No specific site or property needs to be acquired, although the agency may limit its search for alternative sites to a general geographic area. Where a local agency wishes to purchase more than one site within a general geographic area on this basis, all owners are to be treated similarly.
- The property to be acquired is not part of an intended, planned, or designated project area where all or substantially all of the property within the area is to be acquired within specific time limits.

- The local agency will not acquire the property if negotiations fail to result in an amicable agreement, and the owner is so informed in writing.
- The local agency will inform the owner in writing of what it believes to be the market value of the property.

If these circumstances appear to apply to a project, the Voluntary Acquisition process may apply, but **must** be approved by the LAC before any steps are taken to initiate the acquisition process. If approved, steps to follow for voluntary acquisition are governed by federal and state regulations and shall include:

1. Clearly advise the property owner, in writing, prior to making any offers that the agency will be unable to acquire the property in the event that negotiations fail.
2. Provide the owner with an estimate of the fair market value of the property.
3. Provide relocation assistance to any tenants upon mutual acceptance by the acquiring agency and property owner.

If approved, the local agency must work closely with the LAC on all steps of the voluntary acquisition process.

Note: Real estate transactions using this process are subject to real estate excise tax. Also, the statutory evaluation allowance will not be reimbursable, as it is only required for acquisitions made under threat of eminent domain.

Mitigation sites – If a mitigation site is required as an environmental commitment for your project it does not meet the test of a voluntary transaction. Your agency is obligated to acquire a mitigation site for the project as failure to do so would likely result in the project becoming a “no go” and is not acceptable to FHWA. This is true even though your project may have multiple properties to choose from to comply with your environmental commitment.

.46T ROW Funding Estimates – There are two types of estimates:

1. **Project Funding Estimate (PFE)** is a detailed parcel-by-parcel estimate of total expected right of way acquisition costs and is used to obtain authorization and funding for the project. A PFE is **required** if any appraisals are planned to be waived, and the Agency intends to prepare waiver valuations for any of the parcels on the project. A PFE is based on market transactions (sales) that reflect the current real estate market. Ideally, it is completed by an appraiser, an appraisal reviewer, and a relocation expert. Other ROW staff with appropriate experience, including qualified consultants, may also prepare a PFE.
 - A PFE is prepared for every project where right of way will be acquired, unless all properties to be acquired are to be appraised or donated.
 - As a minimum, the PFE contains the following information.
 - A parcel-by-parcel list of right of way costs with project summary totals reported on the Right of Way Project Estimate and Cost Breakdown.
 - A project data package including sales, sales map, neighborhood and project description, scope of sales search and, if applicable, damage studies, cost to cure documentation, and Assumptions and Limiting Conditions.

Note: The PFE Parcel Worksheet is included in the data package. The information contained in the data package must be current (within six months). In certain situations, the data may be valid longer; however, the Appraiser who prepared the PFE must confirm in writing the data they previously provided, still represents market value as of the current date.

The Agent/appraiser assigned to do the PFE completes the estimate as follows:

- Inspect the project and becomes familiar with the engineering features of the plan.
- View individual parcels to determine the effects of acquisition.
- Prepares a Neighborhood and Project Description which defines existing uses, zoning, trends, transportation and utilities, economic influences, a synopsis of the project and its effect on parcels, and any changes in the aforementioned likely to be caused by the project.
- Gathers sufficient comparable land sales and listings for the various types of parcels and remainders within the project. All sales shall be inspected, photos taken and written up on Market Data Sheets. If the sales are to be used exclusively on parcels where the Agency has determined to waive the appraisal, the sales must be confirmed. In all other cases, a reasonable effort shall be made to confirm all sales. Unconfirmed sales will contain an explanation of the confirmation effort including the parties' names and phone numbers where attempts to make contact were unsuccessful.
- Prepares project and sales vicinity map.
- Prepares PFE Parcel Worksheet for each parcel on the project.
- Includes any applicable damage studies.
- Includes cost-to-cure documentation for estimates and/or bids.
- Includes applicable Assumptions and Limiting Conditions if data Package will be referred to in the preparation of Abbreviated Appraisals.

LPA-210

LPA-210b

Appendix 25.172

LPA-215

ROW Section 4-2

Note: *Right of Way Manual* Section 4-2. 42.1, paragraphs E, F, and G do not apply to local agencies.

LAG 25.52

2. **True Cost Estimate** can be used only when all parcels are to be appraised or donated. The ROW PFE **must** be used if the agency wishes to make use of the waiver valuation procedure. A True Cost Estimate is a parcel-by-parcel estimate of total expected right of way acquisition costs drawn from the County Assessor's records, from replacement cost schedules for minor site improvements or estimates from local vendors, and is used to obtain authorization and funding for the project; therefore, in many cases the level of expertise required for its preparation may be less stringent than for a PFE. However, if damages to the remainder are severe, particularly in the case of a reduction in the highest and best use of a remainder property, a True Cost Estimate cannot be used as a legitimate measure of the total expected right of way costs. In such a case, a PFE will be necessary. Local agencies are advised to contact their LAC when these types of situations arise.

A True Cost Estimate consists of three parts:

- Worksheet for each parcel to be acquired
- Table summarizing all estimated acquisition costs
- Project description.

.47 ROW Plan – A ROW Plan indicating the property required to build and maintain the transportation project is required. A right of way plan is a valuable visual-aid tool for negotiators, appraisers, and attorneys involved in acquisition transactions. It also helps property owners understand why and how their properties are being acquired.

[Appendix 25.170](#)

The Local Agency's ROW plan shall be considered approved upon seal and signature of a registered Professional Engineer or Professional Land Surveyor in accordance with [RCW 18.43.070](#) and [RCW 58.09](#). The ROW plan shall contain essential data needed for appraisal, negotiation, right of way certification activities, and illustrate the following information:

- Survey line or centerline for the alignment, including sufficient ties to physically locate the alignment. Please contact the LAC if other acceptable survey practices are proposed to establish the alignment.
- Sufficient information for preparation or verification of legal descriptions of the affected properties and types of property interests to be acquired.
- Width of the right of way (alignment), grade changes, and other design features/details of the construction.
- The property lines in their entirety and owner's names for each affected property, along with all contiguous parcels to the property being acquired and owned by the same owner, the parcel identification number; the calculated area(s) of the existing parcel(s); the areas to be acquired, including any easement areas; and the calculated area(s) of the remainder parcel(s).

It is recommended ROW plans illustrate the following additional information:

- For affected parcels, improvements within 100' feet of the existing ROW, including those improvements that may be damaged by the project (i.e. residences, commercial structures, signs, septic systems including reserve area, wells, driveways, fencing, irrigation systems).
- Vicinity Map showing the project limits.

A draft of the ROW plan should be submitted to the LAC for review and comment prior to its approval by the local agency.

.48 ROW Phase With Federal Funds – Prior to the authorization of federal funds for ROW, the following requirements must be met: compliance with Chapter 14, FHWA approval of environmental (NEPA) documents, and the submittal of the following documents to the Region LPE.

[Appendix 43.62](#)

- Local Agency Agreement Supplement.
- Funding estimate of probable ROW costs and expenses broken down by parcel.
- Approved ROW plan (part of Approved Design Documentation).
- WSDOT approved relocation plan (if relocation is required, contact the LAC for assistance).

The obligation of federal funding is the approval (authorization) by FHWA to participate in a share or portion of federally eligible expenditures on an agreed-upon scope of work (also known as a project). This commitment occurs when a project phase or additional funding for a phase is approved and the project agreement is authorized by FHWA. The dollar amount of federal funds approved on the project agreement is

known as the obligation of federal funds. Only after the local agency receives written authorization from Local Programs are costs incurred eligible for reimbursement. Once FHWA approval has been obtained for the obligation of funds for the ROW Phase, Local Programs will notify the local agency of authorization to proceed with ROW acquisition. Acquisition activities should not occur prior to the obligation of funds. No acquisition costs are eligible prior to this authorization, except those preliminary ROW costs that are allowable in the PE phase.

.49 ROW Phase with Local Agency Funds Only – If federal funds are to be used in any part of the project, or the property is later incorporated into a federally funded project, federal guidelines for acquisition of the ROW must be followed. The local agency must also follow the local agency's approved procedures, which typically requires the LAC to review all offers and supporting data before they are presented to the property owner.

[LAG 25.41](#)

The ROW plan and funding estimate package requirements also apply if federal funds are in any phase of the project.

Note: A PFE is not required unless the local agency intends to use the waiver valuation process for the preparation of AOSs. **The AOSs must be based on the PFE. A True Cost Estimate cannot substitute for a PFE when preparing waiver valuation.**

In order to minimize potential problems which may surface during the certification process, the local agency submits a copy of the ROW plan and Relocation Plan (if applicable) for review/approval before starting the acquisition process. A copy of the ROW plan must be made available at the time of certification.

25.5 Appraisal/Waiver Valuation – Administrative Offer Summary (AOS)

[ROW Chapter 4](#)

[49 CFR 24.102\(n\)\(3\)](#)

Negotiators cannot supervise appraisers, review appraisers, or waiver valuation preparers, unless FHWA approves a waiver of this requirement, and appraisers, review appraisers, or waiver valuation preparers shall not have any interest, direct or indirect, in the property being valued.

[49 CFR 24.103](#)

[WAC 468-100-102](#)

.51 Appraisal – The requirements pertaining to the appraisal of property to be acquired and an explanation of requirements for an acceptable appraisal report are provided in *Right of Way Manual* M 26-01 [Chapter 4](#). If desired, a listing of WSDOT approved fee appraisers and appraisal reviewers is available from the LAC or via a link on the WSDOT Real Estate Services website at www.wsdot.wa.gov/realestate.

[49 CFR 24.103\(d\)](#)

[WAC 468-100-102\(4\)](#)

The appraiser shall be an experienced, qualified appraiser. At a minimum, an appraiser should have a college degree or four years of active experience in the real estate field leading to a basic knowledge of real property interest valuation, or any combination of such experience and college study to provide a total of four years beyond high school graduation. An appraiser who is qualified under WSDOT criteria and on WSDOT's approved appraiser list will be considered qualified for FHWA projects.

[49 CFR 24.103\(a\)](#)

[WAC 468-100-102\(1\)](#)

[49 CFR Appendix 24.103](#)

[LPA-217](#)

[LPA-218](#)

The appraiser shall prepare an appraisal report which is a written document containing among other elements, the following:

1. The purpose of the appraisal which includes a statement of the estimated value and the rights or interests being appraised.

2. The estimate of just compensation for the acquisition. In the case of a partial acquisition, allocate the estimate of just compensation for the property to be acquired and for damages to remaining property in either the report or a separate statement.
3. The data and analyses (or reference to same) to explain, substantiate, and document the estimate of just compensation.

[49 CFR 24.103\(a\)\(2\)\(i\)](#)

4. An adequate description of the physical characteristics of the property being appraised, including items identified as personal property. Local Programs created templates that are available for use but are not required if the local agency has a similar form.

[49 CFR 24.102\(c\)\(1\)](#)

[49 CFR 24.102\(f\)](#)

[RCW 8.26.180\(2\)](#)

[WAC 468-100-102](#)

[ROW Appendix 4-1](#)

[Part 1\(A\)\(f\)](#)

Appraiser/Owner Contact – Property owners have the legal right to inspect the property with the appraiser. Every effort must be made to ensure that the property owner has been extended that opportunity for a joint inspection. The appraiser shall document in the appraisal report his or her attempts to contact the property owner, which shall include attempts to contact the property owner either by phone and/or in person. The appraiser should be flexible in his or hers schedule in order to accommodate the property owner. If contact cannot be made by telephone, the appraiser should send a letter explaining the need for the inspection and inviting the owner to join in the inspection. The letter shall be sent “Return Receipt” in order to document the attempt for contact.

[49 CFR 24.102\(c\)\(2\)\(ii\)](#)

[RCW 8.26.180\(2\)](#)

[WAC 468-100-102\(1\)](#)

.52 Waiver Valuation (commonly referred to as Administrative Offer Summary (AOS)) – In accordance with federal regulations, an appraisal and appraisal review can be waived in certain cases. To qualify, the just compensation, based on the ROW PFE, must be no greater than the waiver valuation limit as defined in the agency’s approved ROW procedures (typically \$25,000), **AND** the acquisition **must be uncomplicated**, with the only damages being minor cost to cure items. The combined estimate of the just compensation plus the cost to cure(s) cannot exceed the agency’s approved waiver limits. The PFE must be based on confirmed comparable sales and must reflect the current market.

For example, if the local agency plans to acquire a strip of land that they estimate is worth \$12,000, but the acquisition will change/limit the owner’s ability to develop their property at some point in the future, the Waiver Valuation Procedure **cannot** be used because it is no longer uncomplicated and an appraisal must be prepared by a qualified appraiser.

In such instances where the valuation is waived, just compensation should be based on current comparable sales. All data used to arrive at an estimate of just compensation must be included in the project file. When the waiver procedure is used, it is important that the local agency determines that the offer being made is fair and equitable.

[LPA-003](#)

In March 2013, WSDOT updated its AOS policy. The local agency must update their Waiver Valuation Procedure, to reflect the new policy. Otherwise, the agency must continue to offer an appraisal for all AOSs regardless of the amount, as specified in their procedures under the prior policy. Any project where acquisitions were initiated under a prior AOS policy must continue with that prior policy until completion of the project’s right of way phase.

If the LPA has updated their Waiver Valuation Procedure to reflect the new policy the following applies:

- If the AOS is \$10,000 or less, the offer must state that an administrative offer is being made and an appraisal has not been completed.
- If the AOS is \$10,001 or greater, the offer must state that an administrative offer is being made, that an appraisal has not been completed, and an appraisal will be prepared if requested by the property owner.

Waiver Valuation (AOS) Value Limits	
Condition A: \$10,000 or Less	Condition B: \$10,001 to \$25,000
No requirement to offer to provide property owner with an appraisal.	Offer letter must include provision that the agency will provide an appraisal at the property owner's request.

[Section 25.51](#)

Under Condition B, if the owner requests an appraisal, the local agency is **required** to provide and pay for one that meets the standards.

25.6 Appraisal Review

[49 CFR 24.104](#)
[WAC 468-100-103](#)
[ROW Chapter 5](#)

The reviewing appraiser should be knowledgeable of the property values in the project area. The depth of review should be in direct relationship to the difficulty of the particular appraisal. The reviewing appraiser must be either a WSDOT review appraiser, on the approved list of review appraisers maintained by WSDOT, or an employee of the acquiring local agency, who is authorized by their approved ROW procedures to review appraisals. To qualify as an agency review appraiser, an individual must, at a minimum, be a Certified General Appraiser with the Washington State Department of Licensing and have successfully completed at least one appraisal review training class approved by WSDOT.

The reviewing appraiser shall, at a minimum, complete a desk review of all appraisals. The local agency and/or reviewing appraiser may elect to complete a field review in lieu of a desk review. A field review shall include inspection of the subject property and all of the comparable sales used in determining the fair market value. All complex appraisal assignments shall be reviewed under a field review.

The reviewing appraiser shall examine the appraisal reports to determine that they:

1. Are complete in accordance with this manual and contain the criteria required by [Right of Way Manual Appendix 4-1 Appraisal Guide](#).
2. Follow accepted appraisal principles and techniques in the valuation of real property interest in accordance with existing state law.
3. Include consideration of compensable items, damage, and benefits, but do not include compensation for items non-compensable under state law.

LPA-214b

The reviewing appraiser shall place in the parcel file a signed and dated certification of value setting forth:

1. An estimate of just compensation including, where appropriate, the allocation of compensation for the property acquired and for damages to remaining property.
2. A listing of the buildings, structures, fixtures, and other improvements on the land which were considered part of the property to be acquired.
3. If applicable, a statement that there is an uneconomic remnant/remainder, and the value of the remainder.
4. A statement that the reviewing appraiser has no direct or indirect present or future interest in such property or in any monetary benefit from its acquisition.
5. A statement that the estimate has been reached independently, without collaboration or direction, and is based on appraisals and other factual data.

Please Note: A consulting firm may complete the appraisal and the appraisal review as long as the reports are completed independently. In addition, in order to avoid a conflict of interest the consultants performing the acquisition/negotiation cannot be involved in the appraisal and appraisal review process.

[49 CFR 24.102\(k\)](#)
[RCW 8.26.180\(9\)](#)
[RCW 47.12.160](#)
[ROW Section 5-5.2](#)
[ROW Section 6-1.2.F](#)
[ROW Section 6-11.1](#)

.61 Uneconomic Remainers – An uneconomic remainder is defined as a parcel of real property in which the owner is left with an interest after the partial acquisition of the owner’s property, and which the agency has determined has little or no value or utility to the owner.

For partial acquisitions, the review appraiser determines (if local agency staff) or recommends (if consultant) whether the remainder is uneconomic. If the remainder will no longer have utility to the owner, and the **local agency determines** that it is uneconomic, the local agency must offer to purchase the remainder from the property owner.

Detailed instructions regarding the review appraiser’s responsibilities for reporting and documenting uneconomic remainders can be found in the ROW Manual. Please note, it is WSDOT’s policy that even though a parcel may be considered to have little or no utility or value in the “before” situation, when an acquisition leaves a remainder, that remainder should be declared an “uneconomic remnant”. This step is not required by federal regulations. If your agency decides to follow WSDOT policy, it must apply it uniformly on the entire project.

25.7 Agency Concurrence for Setting Just Compensation

49 CFR 24.102(d)
RCW 8.26.180(3)
ROW Section 6-1.2.B
LPA-214b

It is the responsibility of the local agency to set just compensation. This can be done by adding a line to the bottom of the review appraiser's certificate as shown on the Local Agency Certificate of Value, to the bottom of the Administrative Offer Summary (AOS), or by stating the same information in a separate memo. In any case, the statement must be signed and dated by an employee of the agency who has approving authority **prior** to the time the offer is made. When a right of way plan revision occurs, a new AOS, appraisal and/or Certificate of Value may be required.

Before initiating negotiations for the acquisition of real property interests, the local **agency** shall establish the just compensation which **shall not** be less than the approved appraisal of the property and shall make a written offer to acquire in that amount. Appraisals are not required if an AOS has been prepared or if the owner has indicated a willingness to donate the ROW after being informed of their right to receive just compensation. If a waiver valuation was used to set just compensation, the negotiator must notify the property owner that they can request an appraisal be prepared in accordance with the agency's approved Waiver Valuation Procedure. (The threshold for offering an appraisal depends on the Agency's approved Waiver Valuation Procedure in place at the time of the offer). The local agency is responsible for providing and paying for this appraisal.

25.8 Title

ROW Chapter 8

The agency will acquire evidence of the condition of title for all properties from which real property interest rights are to be acquired. It is suggested that a preliminary title report be ordered from a title company, and the title to the property acquired cleared so that a policy of title insurance can be issued showing title vested in the agency subject only to those exceptions which can reasonably be accepted. If a title company is not used to provide this information, the acquisition file must include sufficient documentation to validate the signatories on the instruments and show that the interest acquired is free from unreasonable encumbrances.

Special care should be taken to insure that the parties shown as the vested owners by the title evidence are named correctly in the conveyance instruments, and that the parties signing are the same or have authority to sign. The notary acknowledgement form (jurat) should be appropriate for the status of the granting party.

In general, the elements necessary to acquire the needed real property interest(s) are:

1. Acquisition instruments signed by all parties with an interest in the fee title.
2. Releases from mortgages and deeds of trust. If the local agency determines that it wants to accept title subject to a monetary lien, the local agency should look to [Chapter 8](#) of the [ROW Manual](#) for guidance as to informing the owner of their potential risks.
3. Releases of encumbrances, such as easements, which adversely impact the rights being acquired.
4. Releases of priority liens, such as materialman's liens, judgments, state tax liens, and federal tax liens.

25.9 Negotiations

ROW Chapter 6
Exempt
RCW 18.85.151(6)
RCW 18.85.081

.91 Qualifications – For local agency staff to be approved to acquire property without direct supervision by the LAC, they must have either an Associate Degree in real estate or a Bachelor Degree or equivalent experience. In addition, they must have two years full-time experience in real estate acquisition, sales leasing, appraisal, title, escrow, or property management. One year of experience must be in eminent domain acquisition performed according to the provisions of the Uniform Act. Additional experience in eminent domain acquisition can replace education on a year-for-year basis.

Local agencies using staff to negotiate who do not have the necessary qualifications must work closely with the LAC as explained in the Procedures Approval letter.

RCW 18.85.011

If a local agency uses a consultant fee negotiator, the consultant must meet the applicable state licensing requirements. At a minimum, this must be a current, valid real estate salesperson's license issued by the State of Washington. Consultant fee negotiators must also have qualifications and experience generally equivalent to those for local agency staff negotiators.

.92 Separation of Functions – A separation of functions maintains the integrity of the acquiring agency's transactions. Thus, the appraisal, appraisal review, and negotiations for a parcel are performed by three different persons. It is recognized that the use of two separate individuals as appraiser and negotiator on a low-value acquisition can be both difficult and expensive. The use of a single qualified individual to both, appraise (or prepare an AOS) and negotiate a parcel is permitted where the value of the acquisition is \$10,000 or less. It should be noted that the appraisal shall be reviewed prior to negotiations, and the review appraiser shall be neither the appraiser nor the negotiator.

49 CFR 24.102(d)
49 CFR 24.102(e)
RCW 8.26.180(3)
ROW Section 6-1.2.C

.93 Offer/Summary Statement – Upon initiation of negotiations, the local agency shall provide the owner of real property and/or property rights to be acquired with a summary of the appraisal (they can provide the appraisal to fulfill this requirement), or if an AOS a copy of the comparable sales data, a written offer letter, including a summary of the basis for the amount it has established as just compensation for the proposed acquisition. At a minimum the offer letter shall include the following:

1. The amount established as just compensation.
2. A statement explaining that the offer is based either on an appraisal made by a qualified appraiser and reviewed by a qualified Review Appraiser, or an AOS under the Waiver Valuation Procedure. The local agency's current approved Waiver Valuation Procedure will determine their obligations for offering an appraisal if one was not performed.
3. Identification of the real property to be acquired, including the estate or interest being acquired.
4. Identification of improvements and fixtures considered to be part of the real property to be acquired.

5. The amount of just compensation for the real property to be acquired and any amount included for damages to remaining real property shall be separately stated. If the local agency does not provide a copy of the AOS/Appraisal then items addressed in the valuation that will be handled during construction shall be explained in the offer and a construction memo signed.

When a right of way plan revision occurs, a new AOS, appraisal and/or Certificate of Value may be required, especially if the acquisition area or the property interests to be acquired changes.

[LPA-350](#)

The local agency should review their current approved Waiver Valuation Procedure to confirm that the correct language is being used in the offer letter.

[Section 25.10](#)

[23 CFR 710.105\(b\)](#)

[23 CFR 710.305\(d\)](#)

[23 CFR 710.505](#)

[23 CFR 710.507](#)

[49 CFR 24.108](#)

[RCW 8.26.180\(10\)](#)

[WAC 468-100-106](#)

[ROW Section 6-1.2.J](#)

[LPA-383](#)

.94 Donation (see Also Section 25.10 Donated Property) – A donation may be accepted only after the owner has been informed in writing and has waived, in writing, their right to just compensation, and has released the local agency from its obligation to have the property appraised. This applies to individuals, businesses, corporations, other private entities, and non-federal government agencies (state, local and tribal governments). Non-federal governmental agencies must follow their laws and regulations relative to the conveyance of property and make sure they have the legal authority to donate. If a donation is accepted in advance of NEPA clearance, it is considered an early acquisition.

[LAG 25.21](#)

.95 Dedication – ROW obtained through normal zoning, subdivision, or building permit procedures may be incorporated into a federal aid project without jeopardizing participation in other project costs, provided such dedication does not constitute an unconstitutional taking. Dedicated land incorporated into the roadway facility is considered part of the existing ROW. As such, dedicated land is not required to be included in a right of way certification.

[RCW 8.25.020](#)

.96 Statutory Evaluation Allowance (SEA) – The local agency must notify the property owner of the availability of a SEA not to exceed \$750 to help defray the owner's expenses actually incurred in evaluating the agency's offer. Reimbursement made to the property owner shall not be delayed due to negotiated settlement or project delays.

The SEA requirement only applies to offers made under the threat of eminent domain. Therefore, when a local agency's offer is NOT under threat of eminent domain, either by choice or regulation (such as early/advance or voluntary acquisitions), the local agency does NOT have to notify the owner of the \$750 SEA. A local agency is not prohibited from offering the \$750 SEA on non-eminent domain offers; however, FHWA will not participate in the cost. Local agencies must be consistent in their policy on whether to offer the \$750 SEA to property owners, and apply it uniformly.

[49 CFR 24.9](#)

[WAC 468-100-009](#)

[LAG 25.16](#)

.97 Documentation – A diary or negotiator's log must be maintained for each parcel wherein each individual involved in a negotiation, a relocation, or a property management function shall enter and initial a suitable description of each contact and other information concerning that function. See [Section 25.15](#) for additional direction on preparing diaries. Upon request, the LAC will provide explanations and examples of adequate records.

When negotiations are complete, the negotiator shall keep in the project file a signed statement for each parcel that:

1. The written agreement embodies all considerations agreed to by the negotiator and the property owner.
2. The negotiator understands that the acquired property is for use in connection with a federal aid transportation project.
3. The negotiator has no direct or indirect interest in the property or in any monetary benefit from its acquisition, at present or in the future.
4. The agreement has been reached without any type of coercion.

.98 Negotiations by Mail – If no relocation is involved, the local agency may conduct ROW negotiations as follows:

1. Mail to the owner the fair-offer letter, a summary statement (explains nature of acquisition, conditions affecting remainder after construction, and other pertinent details which would have been explained in a face-to-face meeting with owner), the document of acquisition (deed, easement, or other document required for signature), property plat or sketch showing acquisition limits and effects on any remainder, and a copy of an acquisition brochure.
2. Within a reasonable period of time, typically about two weeks, make a follow-up phone call (documented in the diary). Answer questions or, if owner requests it, make an appointment for personal contact.
3. Follow normal procedures for further negotiations.

.99 Acquisition of Contaminated Properties – The local agency should take reasonable care to determine if properties needed for a project are contaminated. In the case where properties being acquired by the local agency will become part of a state highway, the local agency must involve WSDOT in the acquisition process as early as possible to ensure that the property will be in an acceptable condition for WSDOT to accept the transfer of ownership. The local agency should contact the LAC if they are considering acquisition of contaminated properties.

.100 Global Settlements – A global settlement is the combining of just compensation and relocation benefits into a lump sum settlement.

Because global settlements could compromise the entire project's federal aid eligibility, FHWA will not accept a project ROW certification if it includes a global settlement. The local agency should contact the LAC if they are considering global settlements.

.101 Functional Replacements – When publicly-owned real property, including land and/or facilities, is to be acquired for a federal aid highway project, in lieu of paying the fair market value for the real property interest, the local agency may provide compensation by replacing the publicly-owned real property with another facility which will provide equivalent utility.

The local agency must contact the LAC if they are considering a functional replacement. **FHWA will be involved in this process and will have final approval.**

[23 CFR 710.105\(b\)](#)

.102 Option to Purchase – One of the streamlining techniques the new regulations specifically provide for is the use of options to obtain a contractual right to acquire an interest in land. The use of an option to purchase can facilitate earlier acquisition of a property interest and, in some cases, may be structured to forestall development of the land until a clearly determined need of that property for the project has been established. This option also provides for the purchase of a right to temporarily control or restrict development of the property for a defined period. The use of options or purchase of temporary rights can save both time and costs for the project.

25.10 Donated Property

Section 25.94

[LPA-383](#)

Transportation Needs & You Brochure

[23 CFR 710.105\(b\)](#)

[23 CFR 710.305\(d\)](#)

[23 CFR 710.505](#)

[23 CFR 710.507](#)

[49 CFR 24.108](#)

[RCW 8.26.180\(10\)](#)

[WAC 468-100-106](#)

[ROW Section 6-1.2.J](#)

Donations of right of way can be accepted only after the owner (includes non-federal government agencies) has been fully informed by the local agency in writing of their rights to receive just compensation and has released (in writing) the local agency from its obligation to have the property appraised. A copy of the donation letter issued to the property owner informing them of their rights available and the donation letter acknowledgment signed by the owner must be included in each parcel file. It is acceptable for a local agency to have an informational discussion with a property owner prior to the initiation of negotiations and start of the appraisal process to see if a property owner is interested in donating property. This is acceptable as long as the local agency does not enter into negotiations or tell a property owner that the project will not move forward if they do not donate. Coercion is not allowed. If a local agency elects to have an informational meeting, they should provide an informal letter to the property owner explaining the donation process in general terms and provide the property owner with the Property Needs and You brochure explaining all of the compensation and benefits they are entitled to receive if they choose not to donate.

The donation clause must be included in the conveyance instrument. Section 323 of 23 USC provides for using the value of donated lands as part of the match against a local agency's contribution to the project. Certain conditions need be met:

- The credit may only be applied to a federal aid project if federal financial assistance was not used in any form to acquire the land. Credit to the matching share may not exceed the matching share of costs for that project and excess costs may not be utilized on other projects.
- The donation must be related to the project requiring the donated land.
- Donations of privately-owned real estate made after April 2, 1987, and subsequent to NEPA clearance, are eligible for credit purposes. If a donation is accepted prior to the initiation of NEPA you will need to contact the LPE to determine if additional information is required. The value of publicly-owned real estate donated after June 8, 1998, is eligible for match credit.

25.11 Administrative Settlements

[49 CFR 24.102\(i\)](#)
[ROW Section 6-12](#)

The Uniform Act requires that “The head of a federal agency shall make every reasonable effort to expeditiously acquire real property interests by negotiation.” Negotiation implies an honest effort by the acquiring local agency to resolve differences with property owners. Additionally, the legislative history of the Uniform Act indicates that offers can be flexible, and there is no requirement that they reflect a “take it or leave it position.” Negotiations should recognize the inexact nature of the process by which just compensation is determined. Further, the law requires an attempt by local agencies to expedite the acquisition of real property interests by agreements with owners and to avoid litigation and relieve congestion in the courts.

In addition to the mandates of the Uniform Act, there are significant cost savings which can be realized through an increased use of administrative and legal settlements. Cost savings are in the areas of salaries, witness fees, travel, per diem, court costs, etc.

FHWA and WSDOT encourage local agencies to carefully consider and maximize use of administrative settlements in appropriate situations.

[Section 25.10](#)

An administrative settlement or stipulated settlement is a negotiated settlement of a ROW acquisition case in which the local agency has administratively approved payment in excess of fair market value as shown on the local agency’s approved just compensation. Since relocation benefits by regulation cannot be waived, care should be taken not to include “relocation” in a blanket settlement (or global settlement) as the local agency may still be required to pay additional benefits as part of the relocation program.

1. **Any administrative settlement which exceeds the fair market value must be documented, thoroughly justified, and the rationale set forth in writing in order to be eligible for federal aid funds.** The extent of written explanation is a matter of judgment and should be consistent with the circumstances and the amount of money involved. If the local agency has any doubt as to eligibility, it should obtain prior approval from LAC.
2. The local agency shall document the following and make it available for review by LAC if it is not already part of the agency’s approved procedures:
 - a. Identify the responsible official who has the authority to approve administrative settlements.
 - b. Describe the procedure for handling administrative settlements.
3. The designated local agency representative may approve an administrative settlement when it is determined that such action is in the public interest. In arriving at a determination to approve an administrative settlement, the designated official must give full consideration to all pertinent information. The settlement must include an analysis of the circumstances of each individual parcel and provide justification as to why the administrative settlement is in the public’s best interest. This documentation shall be completed and approved by the designated local agency official prior to payment(s) being made. The list below is a sample of items to be considered for an administrative settlement, and should **not** be used as a template.

- The negotiator's recorded information, including parcel details, estimates, bids, research information, all available appraisals, including the owner's and the owner's rationale for increased compensation. This is the most important part of the justification.
- Recent trends in court awards in cases involving similar acquisition and appraisal problems and the length of time it takes to get on the court's schedule.
- A statement can be made that condemnation will take additional time and money, but do not attach a dollar amount to the statement since it would be speculative. You should include items such as updating the appraisal for trial, pretrial, conference, staking of right of way, attorney's expenses, and witness fees (appraisers, consultants, etc.) will be additional incurred costs. You should not speculate about increased project costs resulting from a delay. You could try to quantify your administrative costs resulting from condemnation proceedings such as additional staff time.
- Describe the trial risks based on experience in the particular jurisdiction (e.g., county, city).

Note: Specific information about the parcel, including copies of appraisals, estimates, bids, research information, etc., **must** carry the most weight in the justification.

Administrative
Settlement
eLearning Course

For additional guidance, reference [Appendix 25.173](#) and the [Right of Way Manual](#) Section 6-12. Local agency staff responsible for writing and approving Administrative Settlements should take the web based training on how to write an effective administrative settlement. The course can be accessed by clicking from our Local Programs ROW Services Webpage using the following link: www.wsdot.wa.gov/LocalPrograms/ROWServices/Training.htm

The course is estimated to take 1 to 2 hours to complete.

25.12 Relocation

[49 CFR 24 Subpart C](#)
[ROW Chapter 12](#)

Local agencies that have trained staff and are approved by WSDOT through the procedures process to provide relocation services may do so. All other local agencies should contact their LAC for advice on contracting with private consultants. WSDOT does not maintain a list of qualified relocation consultants.

[49 CFR 24.205\(a\)](#)
[RCW 8.26.065\(1\)](#)
[WAC 468-100-205\(1\)](#)
[ROW Section 12-4.2](#)

If a project includes relocation, the local agency must submit a relocation plan to WSDOT for approval **prior** to starting ROW activities. If there are federal funds in the ROW Phase, the relocation plan must be approved before ROW funding can be authorized.

[LAG 25.43](#)

To maintain a project's federal aid eligibility, a relocation plan needs to be submitted and approved prior to starting ROW activities, even if there are no federal funds in a ROW Phase. **This is also true in the case of early or advanced acquisition.**

You may contact WSDOT for sample relocation plans or refer to [Right of Way Manual Chapter 12](#) for guidance. Contact the LAC for assistance in preparing relocation plans and carrying out relocation activities.

25.13 Right of Way Certification

Spot check reviews are a proactive measure intended to lessen the risk that local agencies engage in improper practices that result in irreversible problems, compliance issues that could delay, stop ROW certification, or risk federal funding on current and/or future federal aid projects. Such risks are reduced by elevating the local agency's awareness of the LAC's project monitoring and by providing an early opportunity for the LAC to help the agency identify problems before they become compliance issues. The LAC acquisition file review process is intended to ensure that the agency has in fact completed the ROW acquisition process in compliance with federal regulations before we make our certification to FHWA. The major difference between a spot check review and a certification review is that the project is not complete, so the focus is on the actions taken by the agency up to the point of spot check review for compliance with the URA. The benefit of performing a spot check review, is regulatory compliance issues can often be caught early enough in the process that corrective actions may be resolved at the LAC level. Another benefit is the prevention of regulatory compliance issues during the certification review.

The LAC will perform spot check reviews on selected federal aid or federal aid eligible projects. The number of spot check reviews is dependent upon the scope of the project, complexity of acquisitions, the agency's level of experience, and past performance. Spot check reviews are not required on all projects, unless required by the local agency's Approved ROW Procedures (as specified in the cover letter by Local Programs). However, the LAC is required to perform spot check reviews on active projects of those local agencies having past performance problems, required by ROW Procedures, or if the local agency lacks sufficient experience acquiring ROW under the URA.

Prior to ROW certification, the local agency must ensure that the ROW plans were reviewed and approved as part of the design approval, and are consistent with the PS&E (see [Appendix 43.62](#)).

23 CFR 635.309(c)

After ROW acquisition has been completed and about two months before the federal aid project is to be advertised for contract, the ROW certification on agency letterhead must be submitted to the LPE. FHWA does not formally approve certifications on non-Interstate projects as they have delegated approval of all certificate 1, 2, and conditional 3s (time-based) and excepted parcel 3s on non-Interstate projects to WSDOT. Local Programs will allow local agencies, with proper justification and Local Programs approval, to extend the time-based cert 3 from bid opening to issuance of the Notice to Proceed (NTP) to the contractor. For all non-Interstate Certificates, the actual certification date for federal aid projects is the date on the Local Programs Certification Concurrence Letter sent to FHWA. Local Programs Concurrence is required prior to advertisement. For Interstate projects, FHWA will only approve Excepted Parcel Certificate 3s, and the actual certification date is the FHWA approval letter date. Please note the approval process for ROW certifications for local agencies is different from what appears in Chapter 17 of the ROW Manual. ROW certification is a requirement for construction authorization. Since local agencies are expected to go to ad within six weeks of construction authorization (See [Section 22.1](#)), ROW certification should not occur too far in advance of the anticipated ad date.

The certification provides the following information and assurances.

1. Sufficient property rights to construct, operate, and maintain the facility as shown on PS&E has been acquired.
2. Right of way has been acquired in accordance with Uniform Act requirements.
3. Relocation assistance has been completed in accordance with the Uniform Act and meets the requirements of [Right of Way Manual Chapter 12](#).
4. Properties acquired in advance of NEPA Clearance (including donations) shall be identified by parcel number. (This information could take the form of an address or a county tax ID if parcel numbers are not assigned.)

[23 CFR 635.309\(c\)\(1\)](#) For specifics on certification types, definition, procedures, requirements, and examples, see [Right of Way Manual Chapter 17](#). **Note:** Under federal regulation, a Certificate 1 can be utilized by a local agency if the agency obtains a negotiated or stipulated possession and use agreement. This is different from the procedures in Chapter 17 of the ROW Manual. In addition, certificate 2s must be updated to a certificate 1 in order for the agency to have all the necessary rights to operate and maintain the facility.

If additional property rights are needed after the certification of the project, any subsequent acquisition must be certified. Please note provisions should be made to ensure the contractor does not enter onto any property until the local agency has legal and physical possession, and the project has been re-certified.

25.14 ROW Certification vs URA Compliance

[Section 25.2](#) Right of Way Acquisition Procedures apply to all federal aid projects regardless of whether the project is to be certified. For example, if the condition of the agency's ROW Procedures requires the LAC to review parcel files prior to making first offers, your agency must comply.

[2 CFR 200](#)
[Appendix 25.171](#) Based on changes to federal requirements, specifically the implementation of [2 CFR 200](#), in order for local agencies to maintain federal eligibility of federal funds utilized in a project prior to construction, certain federal requirements must be met even though the project is being constructed using local funds. Compliance with the Uniform Relocation Assistance and Real Property Acquisition Policies Act of 1970, as amended (URA) is mandatory.

RW Documentation Requirements Based on Funding Source When a Project has RW Acquisition	ROW Certificate	URA Compliance
FHWA Funds in PE Phase		X
FHWA Funds in RW Phase	X	
FWHA Funds in CN Phase	X	
100% Local Funds Only – Federalized by NEPA		X
100% Local Funds Only – Project involves Interstate		X

ROW Certificate – Construction Authorization (prior to advertising for construction bids)

[23 CFR 635.309\(b\)](#)
[23 CFR 635.309\(c\)](#)
[49 CFR 24.101](#)
[ROW Chapter 17](#)

Per [23 CFR 635.309\(b\) and \(c\)](#), the ROW certification procedure for federally-assisted highway projects identifies the acquisition status of necessary ROW for the purpose of advancing a project to construction. This regulation is specific to construction authorization only and is the only time that a ROW certification is issued by Local Programs/FHWA. Title 23 requires that acquiring local agencies comply with [49 CFR Part 24](#). The requirements of [49 CFR 24.101](#) apply to any acquisition of real property for programs or projects where there is federal financial assistance in any part of project costs. The phase program or project means any activity or series of activities undertaken by a Federal Agency or with federal financial assistance received or anticipated in any phase of an undertaking in accordance with the federal funding agency guidelines. The certification process outlined in [Chapter 17](#) of the [ROW Manual](#) must be followed if federal funds are planned in the Construction or ROW Phase of the project.

URA Compliance – Non-Construction Authorization

If federal funds of any amount are used in the PE phase the project is required to follow the URA. This also applies to projects which have been federalized by NEPA or involve Interstate when local funds are used. For example, a project that has been split into two or more separate projects, but is covered by one NEPA document is required to follow the URA when any portion of the overall project involves federal funding.

[49 CFR 24.101](#)

Title 23 requires that acquiring agencies comply with [49 CFR Part 24](#). The requirements of [49 CFR 24.101](#) apply to any acquisition of real property for programs or projects where there is Federal financial assistance in any part of project costs. The phase program or project means any activity or series of activities undertaken by a Federal Agency or with Federal financial assistance received or anticipated in any phase of an undertaking in accordance with the Federal funding Agency guidelines.

In addition to the URA, the local agency must adhere to additional ROW requirements listed in [23 CFR 710](#), environmental requirements, Buy America, and Title VI requirements.

URA Compliance is required if:

- Federal funds in the PE Phase only
- Locally funded but federalized by NEPA
- Locally funded but involves interstate

ROW Project Compliance Reviews (CR):

- In order to be reasonably certain that local agencies are administering FHWA funds in accordance with the Local Agency Guidelines; WSDOT may perform reviews on selected local agency projects that are locally funded but involve interstate, locally funded but federalized by NEPA, or federal funds are only in the PE phase.

Note: If a local agency later seeks federal funding in the ROW or CN phase a ROW certification will be required.

25.15 Property Management

[23 CFR 710.403\(e\)](#)

If using FHWA funding, the acquiring agency shall establish property management policies and procedures that will assure control and administration of ROW, excess lands, and improvements acquired. FHWA does not prescribe how local agencies track income or expenditures from the sale or lease of excess real property acquired with federal funds. However, the federal share of income derived from the sale or lease of property that was acquired with federal fund can ONLY be used for activities permitted under Title 23.

In an audit, the local agency would be expected to produce documentation to show they are in compliance with the regulations. These procedures shall establish:

1. Property records showing:
 - a. An inventory of all improvements acquired as a part of the ROW.
 - b. An accounting of excess properties acquired with FHWA funding.
 - c. An accounting of the property management expenses and the rental payments received.
 - d. An accounting of the disposition of improvements and the recovery payments received.
2. Methods for accomplishing the clearing of ROW when such clearance is performed separately from the control for the physical construction of the project.
3. The methods for employing private firms or public agencies for the management of real property interests.
4. The methods for accomplishing the disposition of improvements through resale, salvage, owner retention, or other means.

[23 CFR 710.403\(d\)](#)

[ROW Chapter 11](#)

If the local agency permits an owner or tenant to occupy the real property acquired on a rental basis for a short term or for a period subject to termination by the local agency on short notice, the amount of rent required shall not exceed the fair rental value of the property to a short-term occupier.

Property management activities shall be handled in a manner consistent with the public interest and designed to reflect the maximum long-range public benefit.

The local agency is responsible for the preservation of the improvements and for reasonable safety measures when it has acquired ownership and possession of the property.

[23 CFR 710.409](#)

[LPA-407](#)

Should rights of way, including uneconomic remnants, acquired with FHWA funds become excess, they may be disposed of (sale, lease, easement, etc.) only with the approval of Local Programs. To request approval, the local agency must complete and submit form [LPA-407](#). Once approved, the local agency will receive a written notification from the Local Programs Right of Way Manager that they can move forward with their disposal process.

[23 CFR 710.403\(e\)](#) If the disposal is to a private party, the local agency must determine fair market value through the valuation process. FHWA will either be credited for its share of the net proceeds of the sale or lease payment, or the local agency may use the federal share of the net proceeds for activities eligible for funding under Title 23 of the United States Code for transportation purposes. A disposal may be made to a governmental agency for a continued public highway use without charge, and no credit to FHWA is required; however, a reversionary clause is required in the deed per [23 CFR 710.403](#).

FHWA approval is required for disposal (sale, lease, easement, etc.) of any rights of way or uneconomic remnants sold at less than fair market value. The local agency will need to provide a written request showing the exception is in the overall public interest based on social, environmental, or economic benefits, or is for a non-proprietary governmental use. Upon approval, the local agency will include a reversion clause in the deed.

[23 CFR 710.105\(b\)](#) Federal regulations provide for the use of airspace for non-highway purposes above, at, or below the highway's established gradeline, lying within the approved ROW limits. Allowing a ROW Use Agreement for recreational activities could result in the parcel becoming a protected 4(f) resource; costs associated with mitigating impacts to these resources will not be eligible for federal aid participation. The airspace may be put to various public and private uses, such as parks, play areas, parking, trails, etc., as long as it does not interfere with the roadway operations and does not create a safety hazard to the traveling public. Any such lease will need to describe what activities are allowed on the land.

Where an acquiring local agency has acquired sufficient legal right, title, and interest in the ROW of a highway on a federal aid system to permit the use of certain airspace, the right to temporary or permanent occupancy or use of such airspace may be granted by the state subject to prior FHWA approval. If the use of airspace is contemplated, the LAC should be contacted for more detailed policies and procedures that must be considered.

Upon disposal of ROW by deed, license, lease, permit, easement or similar instrument, the local agency shall include the required Title VI lease/deed provisions, as outlined in [Chapter 28](#) (Exhibit 2C).

25.16 Diaries

[49 CFR 24.9](#)
[WAC 468-100-009](#)
ROW Chapters [3](#), [6](#), [8](#),
[9](#), [12](#), and [13](#)

.161 General – The diary (also can be referred to as a negotiator's log) is one of the most important elements of an acquisition or relocation file. It is crucial that it be accurate and complete, for it is frequently the only document in a file that explains how a difficult or complex real property interest transaction proceeded. Diaries are also often the only written documentation that is available to show that ROW transactions were done in compliance with the Uniform Act and [49 CFR Part 24](#). Therefore, diaries need to provide a complete record of the transaction. They need to be well organized and factual, and they should be written to be understandable by someone unfamiliar with the transaction. Also, they should reference any appropriate documents in the file such as brochures provided to property owners or estimates obtained to support an administrative record.

Each diary entry shall clearly show the month, day, and year of the contact; the name of the individual who made such a contact; how the contact was made (i.e., in person or by phone) and the name(s) of the individual(s) contacted. Each diary entry shall provide a summary of the contact. It is not sufficient to enter a simple posting of events as they occurred. For example, merely recording that the agent presented an offer or that “discussions were held” on a given date is not sufficient. The entry should indicate, at the least, where the event took place, what questions the owner asked and what answers the agent supplied. These elements are at the very heart of the negotiation process, and when an acquisition becomes difficult or negotiations break down, a well written diary may be the most important document protecting the acquiring agency’s interests.

Multiple contacts should not be combined into one diary entry. These entries need to be made as soon as possible to ensure accuracy. Upon completion of activity entry, the specialist should initial each entry. Electronic diaries are recommended. Once a diary is complete, it must be dated and signed at the end.

Diary entries need to be limited to a recitation of the facts because the diary is subject to the rights of discovery by all parties in any court proceeding or appeal case. **All persons** who participate in negotiations with a property owner to acquire real property interests, whether a staff or consultant agent/negotiator, a member of an agency’s administrative or executive branch, or an agency’s attorney, shall maintain an appropriate diary or log of such activities and discussions with the property owner.

A collection of emails pertaining to the acquisition of a parcel does not constitute a diary. Information taken directly from email correspondence often contributes to a good diary, but care should be taken to exclude extraneous information.

If during the LAC Certification Review, it becomes necessary for a Diary to be corrected, amended, or for additional information to be added this must be accomplished through a Supplemental Diary. The original Diary shall NOT be altered in order to correct erroneous or add missing information.

25.17 Oversight of Consultants Hired to Perform ROW Activities

[23 CFR 710.201\(a\)](#)

[23 CFR 710.201\(b\)](#)

[23 CFR 710.201\(h\)](#)

[LAG 25.2](#)

The local agency (typically the person approved to perform the “Program Administration” function on the Approved ROW Procedures) is responsible for overseeing the delivery of the ROW Program on federal aid roadway projects for their local agency. The local agency must ensure ROW activities are carried out in compliance with federal and state laws, regulations, policies and procedures; therefore the local agency must be involved in all conversations between the LAC and the consultant. Local Programs’ obligation is to the project owner, not the consultant so any guidance provided will be to the local agency.

Oversight of ROW consultants includes, but may not be limited to:

- Early involvement with LAC
- Use of consultant contract template approved by Local Programs;
- Management of scope of work;
- Management of ROW contracts;
- Management of and QA/QC deliverables (ROW plans, PFEs, relocation plans, administrative settlement justifications, recommendations/requests for payment, files, etc.);
- Review and approval of actions and decisions recommended by consultants; and
- Overall responsibility for decisions that are outside the purview of consultant functions.

[LAG Chapter 31](#)

The following checklists are available as a tool for the local agency to use in the oversight of the consultant’s work product.

- LPA020 – Project Oversight Review Checklist
- LPA021 – Parcel Oversight Review Checklist
- LPA022 – Relocation Oversight Review Checklist

25.18 ROW Training

The LAC provides/facilitates annual structured training open to all LPAs and consultants that address the requirements for a federal aid project. If requested or the LAC determines the need, the LAC provides one-on-one or group project-specific training to LPAs on the URA and the ROW process on federal aid projects and/or any projects wishing to preserve federal aid eligibility. This training should be tailored for the project according to the local agency’s approved procedures and the ROW acquisitions needed for the project. For instance, if the local agency is using consultants, the training should be for the local agency’s management approval activities (e.g., agency approval of just compensation, agency approval of administrative settlements, going to condemnation).

25.19 Document Retention

[23 CFR 710.201\(e\)](#) The acquiring local agency shall maintain adequate records of its acquisition and property management activities. Acquisition records, including records related to owner or tenant displacements, and property inventories of improvements acquired shall be in sufficient detail to demonstrate compliance with [23 CFR 710.201\(e\)](#) and 49 CFR Part 24. These records shall be retained at least three years after construction is authorized.

If a local agency acquires a property or property interests under Early Acquisition procedures and later wishes to incorporate the property into a federally funded project, the local agency will need to maintain records for that parcel so they do not jeopardize federal participation on the project or their ability to incorporate the property into their project.

25.20 Appendices

Cautionary Note: Please contact your LAC prior to modifying any templates in the appendices.

- [25.170](#) Right of Way Plan Checklist
- [25.171](#) ROW Certification vs URA Compliance Case Studies
- [25.172](#) Sample Neighborhood Description
- [25.173](#) Vacant
- [25.174](#) Determining Whether Land or Property Rights or Interest are Needed
- [25.175](#) Determining the Type of Property Rights Necessary
- [25.176](#) No ROW Needed Verification Checklist
- [25.177](#) FHWA Early/Advanced Acquisition Options and Requirements Chart
- [25.178](#) Federal Aid Requirement Checklist
- [25.179](#) Acquisition Process Flowchart
- [25.180](#) LPA Certification Worksheet – Certificate 1 Sample
- [25.180a](#) LPA Certificate 1 Worksheet – Instructions
- [25.181](#) LPA Certification Worksheet – Certificate 2 Sample
- [25.181a](#) LPA Certificate 2 Worksheet – Instructions
- [25.182](#) LPA Certification Worksheet – Certificate 3 Sample
- [25.182a](#) LPA Certificate 3 Worksheet – Instructions
- [43.62](#) Example of Design Approval Document

25.21 Local Programs Right of Way Services Website

[Right of Way Services Home](#)

- [Laws & Regulations](#)
- [Manuals & Resources](#)
- [Clarification & Guidance](#)
- [ROW Training & Education](#)
- [LPA Forms & Brochures](#)

Appendix 25.170 Right of Way Plan Checklist

The following checklist is provided as an aid to completing a new right of way plan based on [Section 25.4](#) of the Local Agency Guidelines and [WAC 332-130](#).

- A vicinity map showing the project limits and total parcel details for parcels too large to show on the individual plan sheet.
 - The survey line or centerline of the alignment.
 - The old and new RW limits with sufficient ties to the survey line to allow a legal description to be written for all rights to be acquired.
 - Show all rights to be acquired including fee simple acquisitions, permanent easements and temporary easements. Include advanced acquisition parcels.
 - The total ownership boundaries of all parcels showing all rights to be acquired.
 - The parcel identification number and owner name.
 - Contiguous parcels owned by the same owner.
 - Verify that the legal description of each parcel has been plotted correctly.
 - The calculated area of the parcel(s) to be acquired.
 - The calculated area of the remainder.
 - Make sure the total, right of way and remainder areas add up correctly.
 - Make sure the curve data is correct and matches the information and stationing on the plan.
 - Any improvements within 100' of the existing RW line.
 - Cross reference notes to existing RW plans, Records of Survey or other documentation.
 - Label grade intersection stations.
 - Provide necessary backup calculations and title reports.
 - Seal and signature of register professional engineer or professional land surveyor in accordance with [RCW 18.43.070](#) and [RCW 58.09](#).
 - Design features, width of the new highway (alignment), grade changes, and other detail of the construction.
- Verify that the requirements of [WAC 332-130](#) have been met, including:
- Basis of Bearing
 - North Arrow
 - Text size
 - No shading on the plan.
 - Identification of corners used to control the alignment
 - A description of all monuments shown

Appendix 25.171 ROW Certification vs URA Compliance Case Studies

URA COMPLIANCE LETTER CASE STUDIES

Case Study #1

=====NEPA=====

Project Federal Funds in PE Local Funds in ROW & CN
--

Background information: This local agency has federal funds in the preliminary engineering (PE) phase and local funds support the rest of the project. The agency will not seek federal participation in ROW or Construction (CN) of the project.

Guidance: Since Local Programs is not administering funds for construction of this project, it would not require a Construction Authorization ROW Certificate. The acquisition of ROW on this project would however, need to follow the requirements set forth in the URA. It would be the expectation of the acquiring agency to make sure the requirements of the URA were followed on all real property interests acquired for the project. WSDOT Local Programs would issue a URA Compliance Letter. If the agency comes back later and seeks federal funds in ROW or CN phases, a ROW Certification will be required.

Note: Federal funds for the project are from a source other than FHWA and the federal funding is in ROW or Construction, the local agency would follow the normal Construction Authorization ROW Certificate process.

Case Study #2

=====NEPA=====

Project 1 (Phase 1) Federal Funds in CN	Project 2 (Phase 2) Federal Funds in ROW & CN	Project 3 (Phase 3) Federal Funds in CN
--	--	--

Background information: A project that has been split into three separate projects, but is covered by one NEPA document. NEPA covers each of the 3 separate projects, all projects (aka phases, stages, segments) have ROW acquisition, project 1 has federal funds in construction, project 2 has federal funds in ROW, and project 3 has federal funds in construction.

Guidance: Each of the 3 projects would require a ROW Certification when they are ready to have construction authorized. The process outlined in Chapter 17 of the ROW Manual – Construction Authorization ROW Certificate should be followed.

Case Study #3

-----NEPA-----

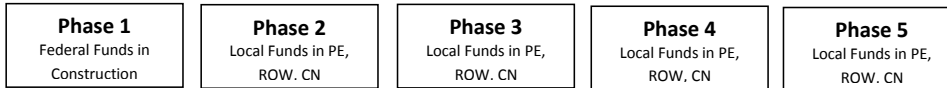

Background information: NEPA covers all 5 phases of the project, all phases have ROW acquisition, phase 1 is the only phase with federal financial assistance – the rest is being done with local funds.

Guidance: Since there is a \$1 of federal funding in this project the URA applies to all phases. In addition, the local agency must adhere to environmental requirements, Buy America, and Title VI requirements. The first phase has federal funds in construction so it will need to be certified using a Construction Authorization ROW Certificate. Phases 2 through 5 have only local funds so while they are required to follow the URA they do not require a Construction Authorization ROW Certificate. Since the entire project is covered by one NEPA document and one of the phases had federal funds, the entire project is considered to be federalized. Since Local Programs is not administering any federal funds for phases 2 through 5 of this project, it would not require a Construction Authorization ROW Certificate. The acquisition of ROW on this project would however, need to follow the requirements set forth in the URA. It would be the expectation of the acquiring agency to make sure the requirements of the URA were followed on all real property interests acquired for the project. WSDOT Local Programs would issue a URA Compliance Letter. Note: Local Programs has no direct involvement in locally funded projects. However, because the project has been federalized, Phase 1 of the project could be as risk if the agency fails to comply with the URA on phases 2 – 5.

Case Study #4

-----SEPA-----

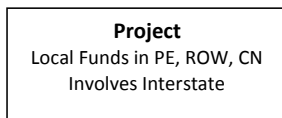

Background information: The local agency is using local funds for the entire project, PE, ROW, and CN. A portion of the project involves changes to interstate right of way, including limited access.

Guidance: Since changes to interstate limited access require approval of FHWA, NEPA will be required which creates a federal nexus (federalized) requiring the agency to comply with the URA. In addition, the local agency must adhere to environmental requirements, Buy America, and Title VI requirements. A URA Compliance Letter will be issued.

Appendix 25.172 Sample Neighborhood Description

SAMPLE NEIGHBORHOOD DESCRIPTION FOR PROJECT: YAKIMA COUNTY: SUNSET HILL ROAD WIDENING No. 311

Date: October 21, 1986

The project vicinity is rural Yakima County lying about 25 miles (40 km) westerly of Yakima city limits in an area commonly called Sunset Hill. The county road connecting the area to the city of Yakima is the Sunset Hill Road, which is currently a two-lane arterial. The area is primarily devoted to agricultural uses, such as cattle raising and forest products, but also is developing with single family lot subdivisions and ranchette residential uses. This part of the county is becoming a bedroom area for commuters to Yakima and several commercial uses have developed along the Sunset Hill Road. Zoning here is Agricultural (AG) minimum 20 acres (8 ha), with areas bordering the Sunset Hill Road zoned Single Family Residential (SR 13), minimum 13,000 square feet (1210 square meters) per site, and a strip along said arterial between Henderson Road and White Bluff Boulevard being zoned for commercial and/or office uses (CPD), with a minimum area required of 15,000 square feet (1 395 square meters) per site. Utilities available along Sunset Hill Road are Puget Power, West Yakima Water (Community System), PNB telephone, and sewers are by individual septic systems (soils percolate adequately). There appears to be minimal demand for new commercial development along Sunset Hill Road.

Traffic along the Sunset Hill Road is heavy during the rush hour. Hence, the proposed project is to widen this arterial to four traffic lanes with a dual-left turn lane in the center. A traffic light is planned at the intersection of Henderson Road. The project will be at present grade and will include curbing. Access points will be controlled at existing locations. The right of way needed is a 20-foot (6-meter) strip of fee land from each side of Sunset Hill Road between Henderson Road and White Bluff Boulevard.

Eleven parcels will be affected: seven homes, a tree farm (2,000 acres (810 ha) in size), one convenience store, a small wholesale lumber mill, and a new professional (medical) office complex. One of the residences is partially in the take and possibly will require relocating the owner-occupant family. A machine shed on the lumber mill site is partially in the take and it contains tenant-owned equipment. The convenience store's gasoline dispensers and canopy are partially in the take. About 10 of the 40 parking stalls for the medical office are in the taking, possibly resulting in loss of one tenant. The project should generally benefit the neighborhood by improving traffic flow during the rush hour. The neighborhood should continue to moderately change from agricultural to single family uses, with no major zoning changes immediately foreseeable, since neighborhood commercial services should remain adequate for the next five or more years.

Appendix 25.173 Vacant

Appendix 25.174 Determining Whether Land or Property Rights or Interest are Needed

Determining Whether Land or Property Rights or Interest are Needed

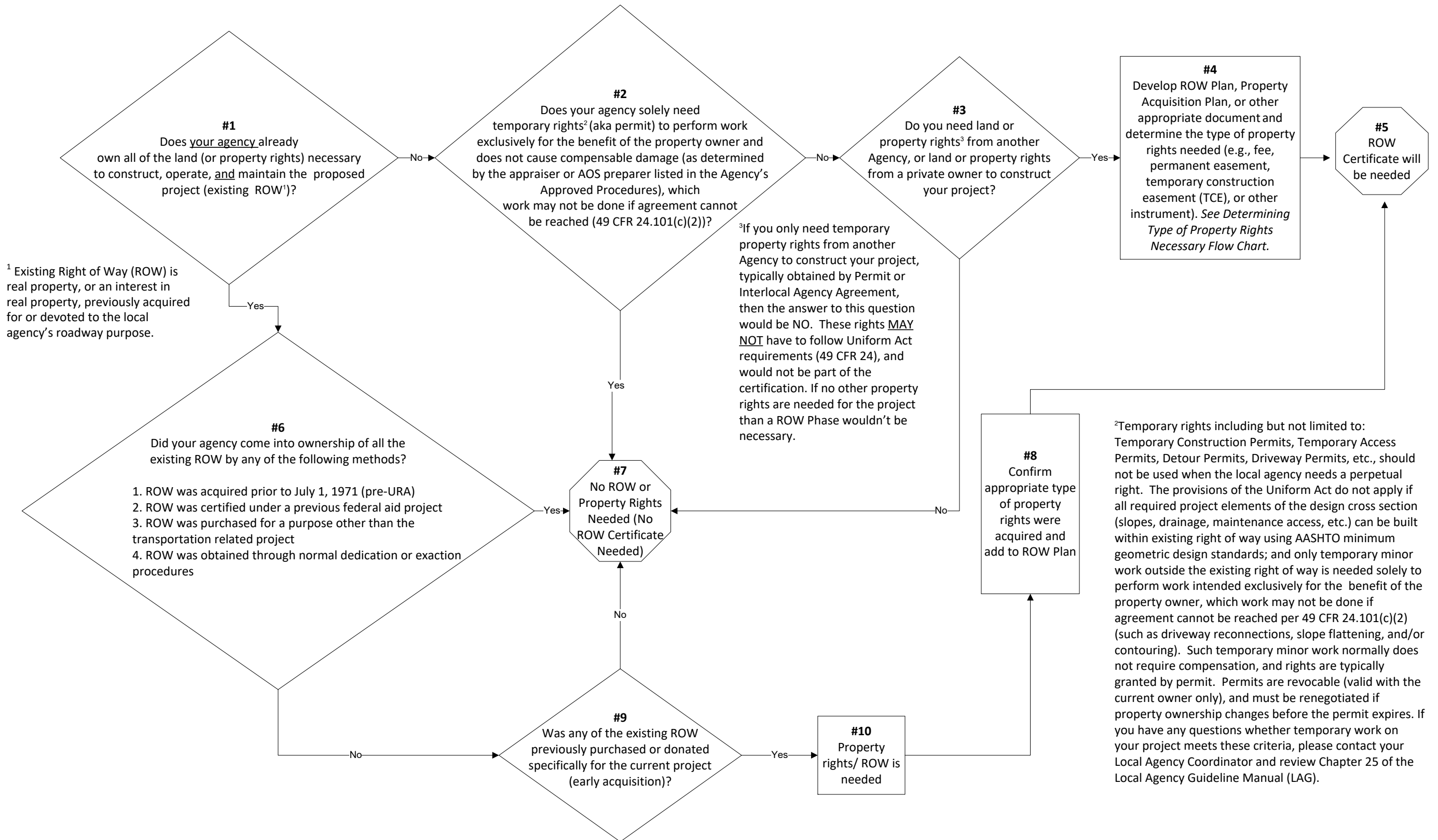

Revised April 2019

Appendix 25.175 Determining the Type of Property Rights Necessary

Determining the Type of Property Rights Necessary

You may have a parcel or multiple parcels that fits more than one of these situations.

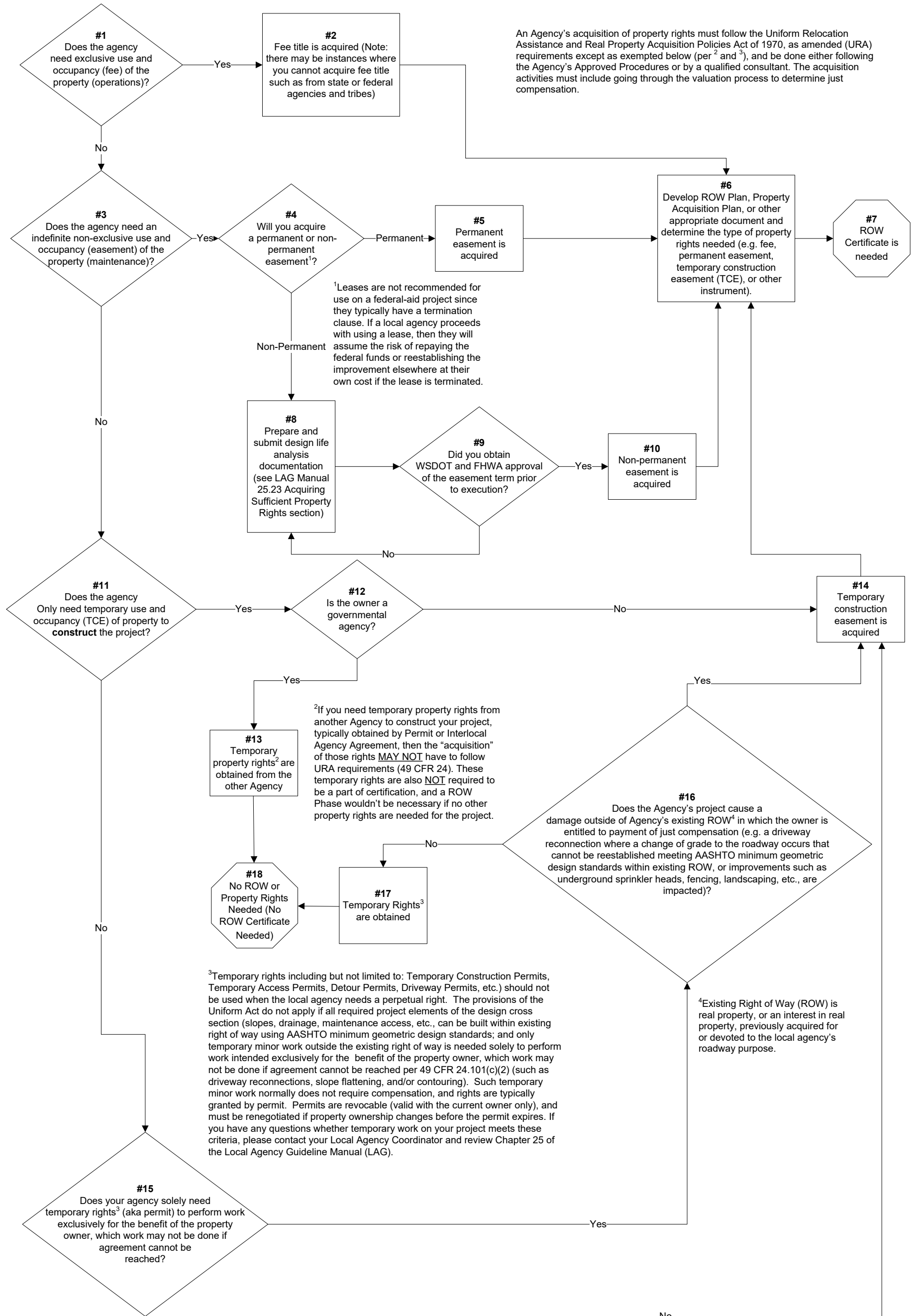

Revised April 2019

Appendix 25.176 No ROW Needed Verification Checklist

No Right-of-Way (ROW) Needed Verification Checklist

This verification checklist is a tool to be used during the completion of the Project Prospectus (Appendix 21.47) to aid in determining if ROW is needed for a project . Please verify each of the following statements by comparing the ROW plan against the PS&E (refer to Appendix 25.174 & Appendix 25.175 for additional guidance):	Yes	N/A
The project can be constructed, operated AND maintained entirely within the acquiring agency's existing ROW , which was obtained under one or more of the following methods:		
1. ROW acquisition occurred prior to July 1, 1971/the Uniform Act ;		
2. ROW was certified under a previous federal aid project ;		
3. ROW was purchased for a purpose other than this project , and is no longer needed for its original purpose; and/or		
4. ROW was obtained through normal dedication or exaction procedures not related to this project (there was no unconstitutional taking).		
Early acquisition or donation was not obtained specifically for this project .		
The acquiring agency does not need to obtain any interest in, or possession of, real property (including temporary uses, easement , access rights , air rights and/or airspace) to construct, operate and maintain the proposed project .		
The acquiring agency solely needs temporary rights to perform work exclusively for the benefit of the property owner and does not cause compensable damages , which work may not be done if agreement cannot be reached.		
Real property improvements are not encroaching into the existing ROW and/or airspace .		
If all the answers to the above are "Yes" or "NA" then no ROW acquisition is needed, sign the Design Approval Documentation form (Appendix 43.62) and place a copy in the project file.		

By: Approving Authority

Print Name

Date

Regulatory Definitions:

Access rights mean the right of ingress to and egress from a property that abuts a street or highway.

Acquiring agency means a State agency, other entity, or person acquiring real property for title 23 of the United States Code purposes.

Acquisition means activities to obtain an interest in, and possession of, real property.

Air rights mean real property interests defined by agreement, and conveyed by deed, lease, or permit for the use of airspace.

Airspace means that space located above and/or below a highway or other transportation facility's established grade line, lying within the horizontal limits of the approved right-of-way or project boundaries.

Damages means the loss in value attributable to remainder property due to severance or consequential damages, as limited by State law, that arise when only part of an owner's property is acquired.

Donation means the voluntary transfer of privately owned real property for the benefit of a public transportation project without compensation or with compensation at less than fair market value.

Early acquisition means acquisition of real property by State or local governments in advance of Federal authorization or agreement.

Easement means an interest in real property that conveys a right to use a portion of an owner's property or a portion of an owner's rights in the property.

Program or project means any activity or series of activities undertaken by a Federal Agency or with Federal financial assistance received or anticipated in any phase of an undertaking in accordance with the Federal funding Agency guidelines.

Real property means land and any improvements thereto, including but not limited to, fee interests, easements, air or access rights, and the rights to control use, leasehold, and leased fee interests.

Right-of-way means real property and rights therein used for the construction, operation, or maintenance of a transportation or related facility funded under title 23 of the United States Code.

Uniform Act means the Uniform Relocation Assistance and Real Property Acquisition Policies Act of 1970, as amended (Public Law 91-646, 84 Stat. 1894), and the implementing regulations at 49 CFR Part 24.

DOT 140-577
5/2019

Page 1 of 1

Appendix 25.177 FHWA Early/Advanced Acquisition Options and Requirements Chart

Early Acquisition (EA) Options & Requirements
(23 CFR 710.501)

Acquiring ROW Options	Require NEPA Decision	Allow 4F Properties	Start Acquisition	Request Reimbursement/ Credits	Comply w/ Federal Law*	Subject to Condemnation	Requirements
1) State-funded early Acquisition without Federal Credit or Reimbursement 23 CFR 710.501(b) 23 USC 108(c)(1)	NO	No, if the State wishes to maintain Federal eligibility for future Federal assistance on any part of the transportation project.	When legally permissible by State Law.	N/A	Yes, if the project maintains Federal eligibility.	YES, if State law allows	A State may carry out early acquisition entirely at its expense. However, a State may maintain eligibility for future Federal assistance on a project. To maintain eligibility, early acquisition must comply with the following requirements of 23 CFR 710.501(c)(1)-(5): <ul style="list-style-type: none"> • Property lawfully obtained by the State agency; • Not 4F property; • Acquisitions and relocations comply with the Uniform Act; • State agency complies with Title VI of the Civil Rights Act; • FHWA concurs with the State that the Early Acquisition did not influence the NEPA decision for the proposed project including: <ul style="list-style-type: none"> – The need to construct, – The consideration of alternatives, or – The selection of design or location.
2) State-funded Early acquisition eligible for future credit 23 CFR 710.501(c)	NO	NO	When legally permissible by State law.	Request credit for the portion of the property after incorporated in the Federal-aid project	YES	YES, if State law allows	<ul style="list-style-type: none"> • Property lawfully obtained by the State agency; • Not 4F property; • Acquisitions and relocations comply with the Uniform Act; • State agency complies with Title VI of the Civil Rights Act; • FHWA concurs with the State that the Early Acquisition did not influence the NEPA decision for the proposed project including: <ul style="list-style-type: none"> – The need to construct, – The consideration of alternatives, or – The selection of design or location; • Property is incorporated in the project to which the credit will be applied; and • The amount of the credit may be current fair market value or historic acquisition cost to acquire; however, this credit must be applied consistently within the project. 23 U.S.C. 323(b)(2).
3) State-funded Early Acquisition Eligible for future reimbursement 23 CFR 710.501(d) 23 USC 108(c)	NO	NO	When legally permissible by State law.	After NEPA is completed and real property interests are incorporated in a Title 23 project and all applicable requirements are met.	YES	YES, if State law allows	<ul style="list-style-type: none"> • Property lawfully obtained by the State agency; • Not 4F property; • Acquisitions and relocations comply with the Uniform Act; • State agency complies with Title VI of the Civil Rights Act; • FHWA concurs with the State that the Early Acquisition did not influence NEPA for the proposed project including: <ul style="list-style-type: none"> – The need to construct, – The consideration of alternatives, – The selection of design or location; • State has a mandatory, comprehensive, and coordinated land use, environmental, and transportation planning process under State law, and the Governor has determined in advance that the acquisition is consistent with the State transportation planning process; • The State actually selects the alternative for which the real property interest is acquired pursuant to NEPA; • Prior to approval for Federal participation, NEPA is completed; and • Reimbursement is based on the usual costs to acquire—23 CFR 710.203(b)(1).

**Early Acquisition (EA) Options & Requirements
(23 CFR 710.501)**

Acquiring ROW Options	Require NEPA Decision	Allow 4F Properties	Start Acquisition	Request Reimbursement/ Credits	Comply w/ Federal Law*	Subject to Condemnation	Requirements
4) Federally funded Early Acquisition (Stand-alone project) 23 CFR 710.501(e) 23 USC 108(d)	YES, NEPA decision required for the early acquisition, stand- alone project only (not the transportation project). (Usually a CE)	NO	After NEPA is complete for the Early Acquisition Project	This is a reimbursable, stand- alone, Federal-aid Project based on FHWA authorization to proceed with acquisition	YES	NO	<ul style="list-style-type: none"> • State certifies and FHWA concurs that the following requirements have been met: <ul style="list-style-type: none"> – State has authority to acquire under State law; – Is for a Title 23 eligible transportation project and does not involve 4F properties; – Will not cause significant adverse environmental impacts as a result of the EA project or from cumulative effects of multiple EA projects; – Will not limit the choice or otherwise influence the NEPA decision of FHWA; – Will not prevent the lead agency from making an impartial decision as to alternatives; – Is consistent with the State transportation planning process under 23 U.S.C. 135; – Complies with other applicable Federal laws (including regulations); – Will be acquired through negotiation, without the threat or use of condemnation. – Will not reduce or eliminate relocation benefits under the Uniform Act and Title VI of the Civil Rights Act; – The Early Acquisition project is in the Transportation Improvement Plan; and – NEPA for the Early Acquisition project is complete and approved by FHWA. • Real property interests acquired cannot be developed in anticipation of the transportation project until a NEPA decision for that transportation project has been completed. No development activity related to demolition, site preparation, or construction that is not necessary to protect health or safety may be undertaken. • If reimbursement is made and the real property interests are not incorporated in a project within 20 years, FHWA must offset the amount against Federal-aid funds apportioned to the State. • Eligibility for Relocation Assistance—a person is considered displaced when required to move from the real property as a direct result of a binding written agreement for the purchase of the real property interest. Options to purchase and similar agreements do not create an immediate commitment and do not create eligibility. <p>Note: The “Option” to purchase the property at a later day allows the property to remain occupied limiting the risk of blight in the neighborhood due to vacant buildings.</p>

**Advance Acquisition (AA) Options & Requirements
(23 CFR 710.503)**

Acquiring ROW Options	Require NEPA Decision	Allow 4F Properties	Start Acquisition	Request Reimbursement/ Credits	Comply w/ Federal Law*	Subject to Condemnation	Requirements
1) Protective Buying 23 CFR 710.503	**Yes typically a CE. See 23 CFR 771.117(d)(12)	Yes, if consultation is completed on 4F.	Usually during the NEPA process.	After property is incorporated in the Federal-aid project.	YES	YES, if State law allows	Development of the property is imminent.
2) Hardship Acquisition 23 CFR 710.503	**Yes typically a CE. See 23 CFR 771.117(d)(12)	Yes, if consultation is completed on 4F.	Usually during the NEPA process.	After property is incorporated in the Federal-aid project.	YES	YES, if State law allows. See comment	A request for hardship acquisition based on a property owner’s written submission. Note: While the agency may condemn if a settlement cannot be reached on a hardship acquisition, great care should be taken to ensure that the decision is warranted both for the property owner and the agency.

*Relevant Federal Law includes the Uniform Act, Title VI Civil Rights Act, and Federal Regulations (primarily, 23 CFR Part 710).

**Note: Protective Buying and Hardship Acquisitions usually occur during the transportation project’s NEPA phase. However, prior to approving an AA, NEPA clearance is necessary for the AA parcels. This requires the AA parcels to be carved out from the overall project so that NEPA clearance provided on those parcels, typically in the form of a CE.

Appendix 25.178 Federal Aid Requirement Checklist



Federal Aid Requirement Checklist

Informational Only

Agency: [Click here to enter text.](#) Region: [Click here to enter text.](#) Date: [Click here to enter text.](#)

Project Federal Aid Number: [Click here to enter text.](#)

Project Name: [Click here to enter text.](#)

Federal Funds Will Be Used For:

PE: [Click here to enter text.](#) R/W: [Click here to enter text.](#) CONST.: [Click here to enter text.](#)

Persons Will Be Displaced: Yes No

Right of Way Acquired for This Project: Yes No

Reminders	Comments
1. Real property must be appraised before initiation of negotiations with the owner, per 49 CFR 24.102(c) and 24.108.	Click here to enter text.
2. Owners must be given an opportunity to accompany each appraiser during his inspection of the property, per 49 CFR 24.102(c).	Click here to enter text.
3. The acquiring agency must establish just compensation before initiation of negotiations with the owners, per 49 CFR 24.102(d).	Click here to enter text.
4. No increase or decrease in the FMV due to the project except physical deterioration, is to be considered in the valuation of the property, per 49 CFR 24.103(d).	Click here to enter text.
5. Appraisals are not to give consideration nor include any allowance for relocation assistance benefits.	Click here to enter text.
6. The owner is not to be left with an uneconomic remnant that the acquiring agency did not offer to acquire, per 49 CFR 24.102(k).	Click here to enter text.
7. The owner is to be given a written statement of the amount offered as just compensation, and where appropriate, the compensation for real property to be acquired and the compensation for damages, if any, to the remaining real property shall be separately stated in the written statement, per 49 CFR 24.102(e).	Click here to enter text.

<p>8. No owner shall be required to surrender possession before the agreed purchase price has been paid or the approved amount of compensation has been paid into the court, per 49 CFR 24.102(j).</p>	<p>Click here to enter text.</p>
<p>9. No lawful occupant shall be required to move unless the occupant has been given at least 90 days advance written notice of the earliest date by which the occupant may be required to move, per 49 CFR 24.203(c).</p>	<p>Click here to enter text.</p>
<p>10. The rental amount charged to owners and/or tenants permitted to occupy the property subsequent to acquisition must not exceed the fair rental value for such occupancy, per 49 CFR 24.102(m).</p>	<p>Click here to enter text.</p>
<p>11. No action must be taken to advance condemnation, defer negotiations or condemnation or taken any other action coercive in nature in order to compel an agreement on the price to be paid for the property, per 49 CFR 24.102(h).</p>	<p>Click here to enter text.</p>
<p>12. The acquiring agency must acquire an equal interest in all buildings, etc., located upon the real property acquired, per 49 CFR 24.105.</p>	<p>Click here to enter text.</p>
<p>13. The acquiring agency must pay recording fees, transfer taxes, etc.; penalty costs for pre-payment of a pre-existing mortgage and the pro rata share of real property taxes paid subsequent to vesting title in the acquiring agency, per 49 CFR 24.106.</p>	<p>Click here to enter text.</p>
<p>14. No property owner can voluntarily donate his property prior to being informed of his right to receive just compensation.</p>	<p>Click here to enter text.</p>
<p>15. Provisions have been made for rodent control should it be necessary.</p>	<p>Click here to enter text.</p>
<p>16. No owner was intentionally required to institute legal proceedings to prove the fact of the taking of his real property.</p>	<p>Click here to enter text.</p>

Prepared by: [Click here to enter text.](#)

Title: [Click here to enter text.](#)

Acquisition Process

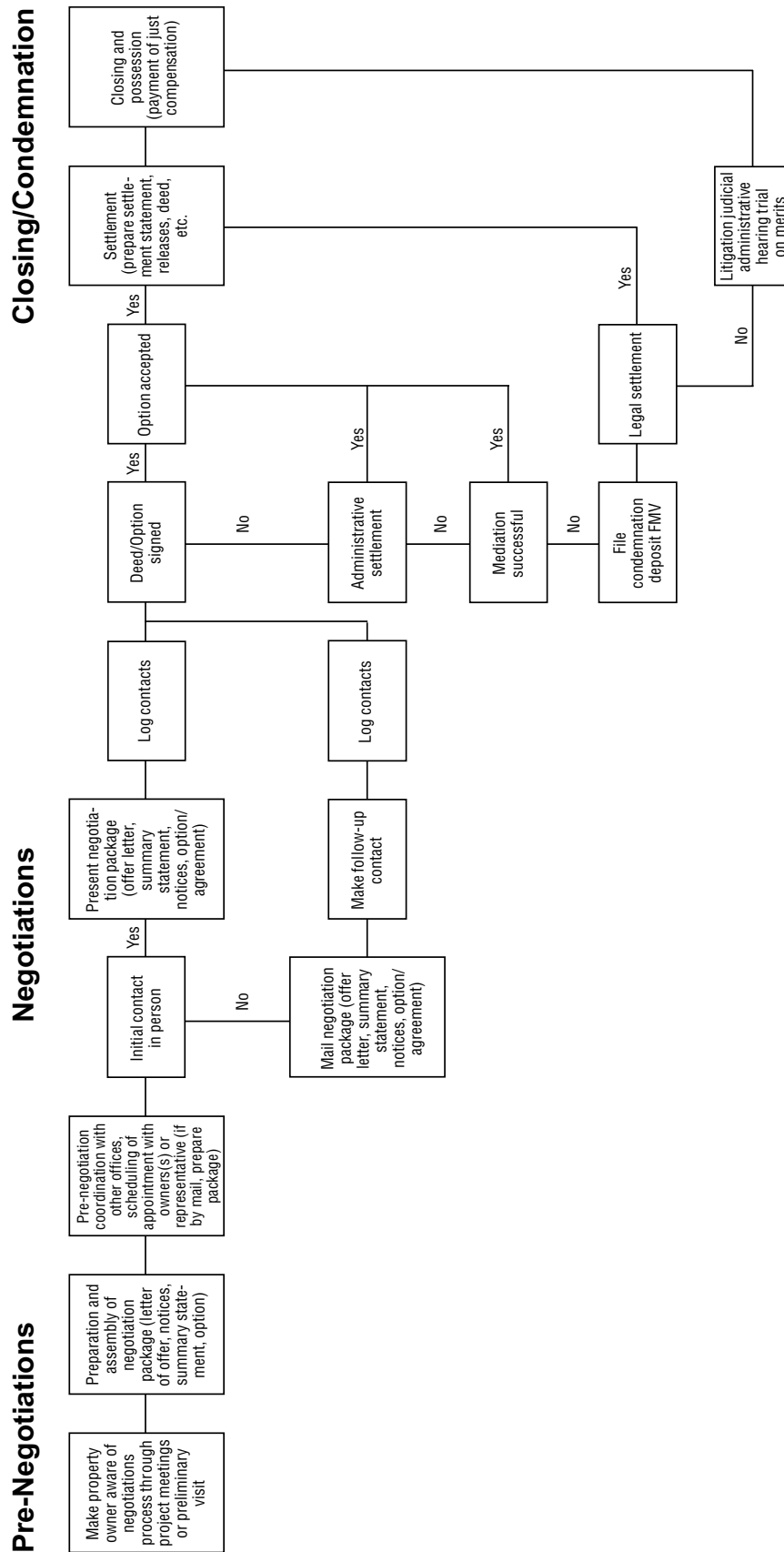

Appendix 25.180 LPA Certification Worksheet – Certificate 1 Sample

Certificate No. 1
 Agency: ABC County
 Project Title: NW Gold Trail Project F.A. No.: STPU 2145(001)

R/W Plan Sheet #	ACQUISITION										RELOCATION							
	Parcel Number	Owner	Pre-NEPA	Fee	Access Rights	Esmt.* P/N/L	Date Esmt.* N/L Expires	Effective Date TCE	Date TCE Expires	Effective Date Permit or Right of Entry	Date Permit or Right of Entry Expires	Date Acquired	None	Res.	Bus.	Farm	NPO	PPD
106	022605-9000	Norris		X								1/21/15						X
	022605-9215												X					
106	022605-9216	Money	X	X		P		2/1/15	8/30/15			2/1/15						
	022605-9325																	
107	022605-9326	Big Blue Diner		X	X	P		2/1/15	8/30/15			2/1/15			X			
108	022605-9456	Strand	X	X								3/1/15		2				
109	022605-9165	State Parks				N	4/30/45					4/30/15	X					
111	022605-8500	Dreamy		X								4/1/15		1				
			2	5	1	3	1	2		0				3	1	0	0	1

Easement Key
P=Permanent/perpetual
N=Non-Permanent (defined term)*
L=Lease*

*Non-permanent easements and leases subject to FHWA approval

Appendix 25.180a LPA Certificate 1 Worksheet – Instructions

Certificate 1 Worksheet Instructions to Complete Form

Worksheet Format:

Please do not alter the form by adding or deleting columns as it will affect formulas that automatically compute based on data entered into the spreadsheet. Rows can be added or deleted based on need. It is recommended that adding or removing rows occur between row 4 and row 23.

Creating a List within a Cell:

GENERAL		
R/W Plan Sheet #	Parcel Number	Owner
106	022605-9000	Norris
	022605-9215	
106	022605-9216	Money
	022605-9325	
	022605-9326	
107	022605-9327	Big Blue Diner

A list of information can be added to a single cell by clicking the “Alt” key at the same time and clicking on the “Return” key.

Selecting Correct Form:

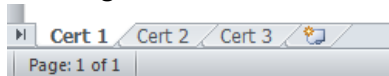

The excel spreadsheet is set up as a single workbook with tabs at the bottom left corner of the screen. Select the Cert 1 tab to complete the worksheet.

Electronic Worksheet Instructions:

R/W Plan Sheet #	Parcel Number	Pre-NEPA Fee	Access Rights	Esmt.* P/N/L	Date Esmt.* N/L Expires

Enter the ROW plan sheet number on which the parcel is shown. Parcels should be listed in sequential order according to the ROW plans.

RES-397a – Instructions for Certificate 1 Worksheet
Created 6/2015

The electronic instructions to complete the worksheet are embedded in each title cell of row 3. Either hover the mouse of the title cell or left click in the cell and the instructions will appear. Once you remove the mouse or click on another cell the instructions will disappear.

Header:

Certificate No. 1
 Agency: Name of Agency
 Project Title: Project Title F.A. No.: Federal Aid No.

Agency Name: Enter acquiring agency name.
Project Title: Enter complete project title which was used on the STIP.
F.A. No.: Enter the federal aid number for the project.

General Section:

GENERAL		
R/W Plan Sheet #	Parcel Number	Owner

R/W Plan Sheet #: Enter the ROW plan sheet number on which the parcel is shown. Parcels should be listed in sequential order according to the ROW plans.
Parcel Number: The parcel numbers should be listed in the order shown on the ROW plans. Enter the parcel number as identified on the Right of Way Plan. If there are multiple parcels numbers making up the larger parcel determination, they should be shown as a single entry on one line to ensure the parcel count is accurate(use Alt enter function). Please note ROW Plans should be consistent with the certification worksheet.
Owner: Enter the owner name (last name, first name or business name). If there are multiple owners, they should be shown as a single entry on one line to ensure the parcel count is accurate(use Alt enter function).

Acquisition Section:

ACQUISITION									
Pre-NEPA	Fee	Access Rights	Esmt.* P/N/L	Date Esmt.* N/L Expires	Effective Date TCE	Date TCE Expires	Effective Date Permit or Right of Entry	Date Permit or Right of Entry Expires	Date Acquired

RES-397a – Instructions for Certificate 1 Worksheet
 Created 6/2015

Pre NEPA: If an offer was made on a parcel prior to environmental approval (NEPA), place an "X" in cell. For all offers made on parcels after environmental approval this field should be left blank.

Fee: If fee simple rights (exclusive use and occupancy) were acquired from any portion of the parcel, place an "X" in the cell.

Access Rights: Access rights apply to limited access facilities (such as interstate, WSDOT access breaks). If access rights (including light, view, and air) were acquired from any portion of the parcel, place an "X" in the cell.

Esmt.* P/N/L: If a permanent (perpetual), non-permanent (defined term), or lease was acquired from any portion of the parcel, place an "P" for permanent easement, or an "N" for non-permanent easement, or an "L" for lease in cell. *If something less than a permanent easement is acquired FHWA approval is required.

Date Esmt.* N/L Expires: If you have FHWA approval to acquire a non-permanent easement or lease, enter the expiration date identified in the easement/lease in this cell. This column is not used in the case of a permanent easement.

Effective Date TCE: If a temporary easement is acquired for construction purposes on any portion of the parcel, enter the start date of the TCE. This is normally the same date as the date acquired. This is the date the agency has legal and physical possession, which is also referred to as the payment available date. Possession cannot occur prior to payment to the property owner. In the case of donations, the effective date is the possession date.

Date TCE Expires: Enter the date the temporary construction easement expires as specified in the temporary easement. Agencies should always use a specific expiration date to avoid clouding a property owner's title.

Effective Date Permit or Right of Entry: Permits or right of entries are obtained for any portion of the parcel from other agencies to perform work on their property and normally without payment of compensation, such as tying into another jurisdiction's road. Situations that involve temporary work between agencies, does not have to follow the URA process. If a permit or right of entry was obtained for construction activities required for the project, enter the start date of the permit or right of entry. This is normally the same date as the date acquired. Preliminary testing or studies in advance of construction activities are not required to be certified since the work is not part of the PS&E. Also, "beneficial" permits from private property owners are not required to be certified since the work is not required for the project itself and can be eliminated from the contract if the owner were to revoke the permit.

Date Permit or Right of Entry Expires: Enter the date the permit or right of entry expires as specified in the permit or right of entry.

Date Acquired: Date acquired is the date the agency has legal and physical possession, which is also referred to as the payment available date. Possession cannot occur prior to payment to the property owner. If the payment is mailed, the agency should add 5 days to the mailing date. In the case of donations, the effective date is the possession date. Enter the date the property was acquired. This must be filled in for each acquisition listed (on a Cert 1) even if the same date appears in other columns.

NOTE: Refer to the Sufficient Property Rights flow chart (Appendix 25.174 & 25.175) for actual definition of property rights.

Relocation Section:

RELOCATION					
Non-Residential					
None	Res.	Bus.	Farm	NPO	PPO

None: If there was no relocation on the parcel place "X" in cell. Even in situations where projects have no relocation, the cell should not be left blank.

Res: If your project displaced a residential owner or tenant occupant from the parcel place an "X" in the cell. If there are multiple displaced persons for one parcel number, type in the number (you will need to change any other cells in the column marked with an "x" to a number) and change the formula in the total row to auto sum.

Bus.: If your project displaced a business, including qualifying residential landlords (not to be confused with a business that has to relocate personal property only), place an "X" in the cell. If there are multiple displaced businesses for one parcel number, type in the number (you will need to change any other cells in the column marked with an "x" to a number) and change the formula in the total row to auto sum.

Farm: If your project displaced a farm, place an "X" in the cell. If there are multiple displaced farms for one parcel number, type in the number and change the formula in the total row to auto sum.

NPO: If your project displaced a Non-Profit Organization (NPO), place an "X" in the cell. If there are multiple displaced NPOs for one parcel number, type in the number (you will need to change any other cells in the column marked with an "x" to a number) and change the formula in the total row to auto sum.

PPO: If your project displaced Personal Property Only (PPO), place an "X" in the cell. If there are multiple PPO displacements for one parcel number, type in the number (you will need to change any other cells in the column marked with an "x" to a number) and change the formula in the total row to auto sum.

Calculated Totals Section:

GENERAL			ACQUISITION										RELOCATION					
R/W Plan Sheet #	Parcel Number	Owner	Pre-NEPA	Fee	Access Rights	Esmt.* P/N/L	Date Esmt.* Expires	Effective Date TCE	Date TCE Expires	Effective Date Permit or Right of Entry	Date Permit or Right of Entry Expires	Date Acquired	None	Res.	Bus.	Farm	NPO	PPO
	0		0	0	0	0	0	0		0			0	0	0	0	0	0

Column Totals: Each column has a formula at the bottom that will "count" the box if it has data in it. The calculations will happen automatically so there is no need to alter or enter information in this section. The totals should be reconciled with the ROW plan to ensure all rights were acquired.

If you have multiple displacements for one parcel you will need to type in the number of displacements in the appropriate column and then change the formula in the total row from a "CountA" to an "Auto Sum".

Example:

Certificate No. 1
 Agency: ABC County
 Project Title: NW Gold Trail Project F.A. No.: STPU 2145(001)

R/W Plan Sheet #	GENERAL		ACQUISITION								RELOCATION									
	Parcel Number	Owner	Pre-NEPA	Fee	Access Rights	Esmt.* P/N/L	Date Esmt.* N/L Expires	Effective Date TCE	Date TCE Expires	Effective Date Permit or Right of Entry	Date Permit or Right of Entry Expires	Date Acquired	Non-Residential							
													None	Res.	Bus.	Farm	NPO	PPD		
106	022605-9000	Norris		X								1/21/15	X							X
	022605-9215																			
106	022605-9216	Money	X	X		P		2/1/15	8/30/15			2/1/15	X							
	022605-9325																			
	022605-9326																			
107	022605-9327	Big Blue Diner		X		P		2/1/15	8/30/15			2/1/15			X					
108	022605-9456	Strand	X	X	X							3/1/15		2						
109	022605-9165	State Parks				N	4/30/45					4/30/15	X							
111	022605-8500	Dreamy		X								4/1/15		1						
	6		2	5	1	3	1	2		0			3	1	0	0	0	0	1	

Easement Key
 P=Permanent/Perpetual
 N=Non-Permanent (defined term)*
 L=Lease*
 *Non-permanent easements and leases subject to FHWA approval

Best practices:

ROW Plan – for ease of certification it is recommended that you do not rely solely on Tax Identification numbers as they do not define a parcel acquisition. It is better to assign a parcel number that will identify the entire acquisition which could encompass multiple tax parcel numbers.

If your agency uses both tax parcel numbers and assigned numbers, the use of numbers must be consistent between the ROW plan, ROW certification, parcels, and all file documents.

Appendix 25.181 LPA Certification Worksheet – Certificate 2 Sample

Certificate No. 2
 Agency: ABC County
 Project Title: NW Gold Trail Project F.A. No.: STPU 2145(001)

GENERAL		ACQUISITION										RELOCATION							
R/W Plan Sheet #	Parcel Number	Owner	Pre-NEPA	Fee	Access Rights	Esmt.* P/N/L	Date Esmt.* N/L Expires	Effective Date TCE	Date TCE Expires	Effective Date Permit or Right of Entry	Date Permit or Right of Entry Expires	Date Acquired	Possession Date (P&U Only)	None	Res.	Bus.	Farm	NPO	PPO
106	022605-9000	Norris		X								1/21/15		X					X
	022605-9215																		
106	022605-9216	Money	X	X		P		2/1/15	8/30/15			2/1/15		X					
	022605-9325																		
107	022605-9326	Big Blue Diner		X		P		2/1/15	8/30/15			2/1/15				X			
108	022605-9456	Strand	X	X	X							3/1/15							
109	022605-9165	State Parks		X		N	4/30/45					4/30/15		X					
111	022605-8500	Dreamy		X								4/1/15			1				
112	022605-7852	Kort		X									3/6/15						
	6		2	5	1	3	1	2		0					3	1	0	0	1

Easement key
 P=Permanent/perpetual
 N=Non-Permanent (defined term)
 L=Lease*

*Non-permanent easements and leases subject to FHWA approval

Appendix 25.181a LPA Certificate 2 Worksheet – Instructions

Certificate 2 Worksheet Instructions to Complete Form

Worksheet Format:

Please do not alter the form by adding or deleting columns as it will affect formulas that automatically compute based on data entered into the spreadsheet. Rows can be added or deleted based on need. It is recommended that adding or removing rows occur between row 4 and row 23.

Creating a List within a Cell:

GENERAL		
R/W Plan Sheet #	Parcel Number	Owner
106	022605-9000	Norris
	022605-9215	
106	022605-9216	Money
	022605-9325	
	022605-9326	
107	022605-9327	Big Blue Diner

A list of information can be added to a single cell by clicking the “Alt” key at the same time and clicking on the “Return” key.

Selecting Correct Form:

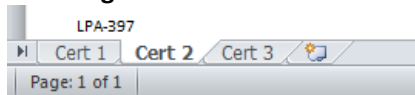

The excel spreadsheet is set up as a single workbook with tabs at the bottom left corner of the screen. Select the Cert 2 tab to complete the worksheet.

Electronic Worksheet Instructions:

R/W Plan Sheet #	Parcel Number	Pre-NEPA Fee	Access Rights	Esmt.* P/N/L	Date Esmt.* N/L Expires

Enter the ROW plan sheet number on which the parcel is shown. Parcels should be listed in sequential order according to the ROW plans.

RES-397b – Instructions for Certificate 2 Worksheet
Created 6/2015

The electronic instructions to complete the worksheet are embedded in each title cell of row 3. Either hover the mouse of the title cell or left click in the cell and the instructions will appear. Once you remove the mouse or click on another cell the instructions will disappear.

Header:

Certificate No. 2
 Agency: Name of Agency
 Project Title: Project Title F.A. No.: Federal Aid No.

Agency Name: Enter acquiring agency name.
Project Title: Enter complete project title which was used on the STIP.
F.A. No.: Enter the federal aid number for the project.

General Section:

GENERAL		
R/W Plan Sheet #	Parcel Number	Owner

R/W Plan Sheet #: Enter the ROW plan sheet number on which the parcel is shown. Parcels should be listed in sequential order according to the ROW plans.
Parcel Number: The parcel numbers should be listed in the order shown on the ROW plans. Enter the parcel number as identified on the Right of Way Plan. If there are multiple parcels numbers making up the larger parcel determination, they should be shown as a single entry on one line to ensure the parcel count is accurate(use Alt enter function). Please note ROW Plans should be consistent with the certification worksheet.
Owner: Enter the owner name (last name, first name or business name). If there are multiple owners, they should be shown as a single entry on one line to ensure the parcel count is accurate(use Alt enter function).

Acquisition Section:

ACQUISITION											
Pre-NEPA	Fee	Access Rights	Esmt.* P/N/L	Date Esmt.* N/L Expires	Effective Date TCE	Date TCE Expires	Effective Date Permit or Right of Entry	Date Permit or Right of Entry Expires	Date Acquired	Possession Date (P&U Only)	

Pre NEPA: If an offer was made on a parcel prior to environmental approval (NEPA), place an "X" in cell. For all offers made on parcels after environmental approval this field should be left blank.
Fee: If fee simple rights (exclusive use and occupancy) were acquired from any portion of the parcel, place an "X" in the cell.

RES-397b – Instructions for Certificate 2 Worksheet
 Created 6/2015

Access Rights: Access rights apply to limited access facilities (such as interstate, WSDOT access breaks). If access rights (including light, view, and air) were acquired from any portion of the parcel, place an "X" in the cell.

Esmt.* P/N/L: If a permanent (perpetual), non-permanent (defined term), or lease was acquired from any portion of the parcel, place an "P" for permanent easement, or an "N" for non-permanent easement, or an "L" for lease in cell. *If something less than a permanent easement is acquired FHWA approval is required.

Date Esmt.* N/L Expires: If you have FHWA approval to acquire a non-permanent easement or lease, enter the expiration date identified in the easement/lease in this cell. This column is not used in the case of a permanent easement.

Effective Date TCE: If a temporary easement is acquired for construction purposes on any portion of the parcel, enter the start date of the TCE. This is normally the same date as the date acquired. This is the date the agency has legal and physical possession, which is also referred to as the payment available date. Possession cannot occur prior to payment to the property owner. In the case of donations, the effective date is the possession date.

Date TCE Expires: Enter the date the temporary construction easement expires as specified in the temporary easement. Agencies should always use a specific expiration date to avoid clouding a property owner's title.

Effective Date Permit or Right of Entry: Permits or right of entries are obtained for any portion of the parcel from other agencies to perform work on their property and normally without payment of compensation, such as tying into another jurisdiction's road. Situations that involve temporary work between agencies, does not have to follow the URA process. If a permit or right of entry was obtained for construction activities required for the project, enter the start date of the permit or right of entry. This is normally the same date as the date acquired. Preliminary testing or studies in advance of construction activities are not required to be certified since the work is not part of the PS&E. Also, "beneficial" permits from private property owners are not required to be certified since the work is not required for the project itself and can be eliminated from the contract if the owner were to revoke the permit.

Date Permit or Right of Entry Expires: Enter the date the permit or right of entry expires as specified in the permit or right of entry.

Date Acquired: Date acquired is the date the agency has legal and physical possession and reached final settlement, which is also referred to as the payment available date. Possession cannot occur prior to payment to the property owner. If the payment is mailed, the agency should add 5 days to the mailing date. In the case of donations, the effective date is the possession date. Enter the date the property was acquired. This must be filled in for each parcel acquired except in the case where final settlement has not been reached (see possession date below) even if the same date appears in other columns.

Possession Date (P&U Only): The possession date is the date the agency has the right to occupy and use the portion of the parcel needed for the project. Enter the date the agency obtained possession and use of the property. Possession cannot occur prior to payment to the property owner. In the case of a negotiated P&U, if the payment is mailed, the agency should add 5 days to the mailing date. If the payment is deposited into the court in the case of stipulated P&U, enter the date of receipt by the court clerk's office. This is only applicable in situations in which all necessary rights of way have not been acquired because final settlement has not been reached.

NOTE: Refer to the Sufficient Property Rights flow chart (Appendix 25.174 & 25.175) for actual definition of property rights.

RES-397b – Instructions for Certificate 2 Worksheet
Created 6/2015

Page 3

Relocation Section:

RELOCATION					
Non-Residential					
None	Res.	Bus.	Farm	NPO	PPO

None: If there was no relocation on the parcel place "X" in cell. Even in situations where projects have no relocation, the cell should not be left blank.

Res: If your project displaced a residential owner or tenant occupant from the parcel place an "X" in the cell. If there are multiple displaced persons for one parcel number, type in the number (you will need to change any other cells in the column marked with an "x" to a number) and change the formula in the total row to auto sum.

Bus.: If your project displaced a business, including qualifying residential landlords (not to be confused with a business that has to relocate personal property only), place an "X" in the cell. If there are multiple displaced businesses for one parcel number, type in the number (you will need to change any other cells in the column marked with an "x" to a number) and change the formula in the total row to auto sum.

Farm: If your project displaced a farm, place an "X" in the cell. If there are multiple displaced farms for one parcel number, type in the number and change the formula in the total row to auto sum.

NPO: If your project displaced a Non-Profit Organization (NPO), place an "X" in the cell. If there are multiple displaced NPOs for one parcel number, type in the number (you will need to change any other cells in the column marked with an "x" to a number) and change the formula in the total row to auto sum.

PPO: If your project displaced Personal Property Only (PPO), place an "X" in the cell. If there are multiple PPO displacements for one parcel number, type in the number (you will need to change any other cells in the column marked with an "x" to a number) and change the formula in the total row to auto sum.

Calculated Totals Section:

GENERAL			ACQUISITION										RELOCATION							
R/W Plan Sheet #	Parcel Number	Owner	Pre-NEPA	Fee	Access Rights	Esmt.* P/N/L	Date Esmt.* N/L Expires	Effective Date TCE	Date TCE Expires	Effective Date Permit or Right of Entry	Date Permit or Right of Entry Expires	Date Acquired	Possession Date (P&U Only)	None	Res.	Bus.	Farm	NPO	PPO	
	0		0	0	0	0	0	0		0				0	0	0	0	0	0	0

Column Totals: Each column has a formula at the bottom that will “count” the box if it has data in it. The calculations will happen automatically so there is no need to alter or enter information in this section. The totals should be reconciled with the ROW plan to ensure all rights were acquired.

If you have multiple displacements for one parcel you will need to type in the number of displacements in the appropriate column and then change the formula in the total row from a “CountA” to an “Auto Sum”.

Example:

Certificate No. 2
Agency: ABC County
Project Title: NW Gold Trail Project F.A. No.: STPU 2145(001)

R/W Plan Sheet #	Parcel Number	Owner	ACQUISITION										RELOCATION										
			Pre-NEPA	Fee	Access Rights	Easmt.* P/N/L	Date Easmt.* N/L Expires	Effective Date TCE	Date TCE Expires	Effective Date Permit or Right of Entry	Date Permit or Right of Entry Expires	Date Acquired	Possession Date (P&U Only)	None	Res.	Bus.	Farm	NPO	PPD				
106	022605-9000	Norris		X											1/21/15							X	
106	022605-9215																						
106	022605-9216	Money	X	X		P		2/1/15	8/30/15						2/1/15								X
	022605-9325																						
	022605-9326																						
107	022605-9327	Big Blue Diner		X		P		2/1/15	8/30/15						2/1/15			X					
108	022605-9456	Strand	X	X	X										3/1/15			2					
109	022605-9165	State Parks				N	4/30/45								4/30/15			X					
111	022605-8500	Dreamy		X											4/1/15			1					
112	022605-7852	Wort		X											3/6/15								
	6		2	5	1	3	1	2							0			3	1	0	0	1	

Easement Key
 PPermanent/Perpetual
 NNon-Permanent (defined term)*
 LLease*
*Non-permanent easements and leases subject to FHWA approval

Best practices:

ROW Plan – for ease of certification it is recommended that you do not rely solely on Tax Identification numbers as they do not define a parcel acquisition. It is better to assign a parcel number that will identify the entire acquisition which could encompass multiple tax parcel numbers.

If your agency uses both tax parcel numbers and assigned numbers, the use of numbers must be consistent between the ROW plan, ROW certification, parcels, and all file documents.

Appendix 25.182a LPA Certificate 3 Worksheet – Instructions

Certificate 3 Worksheet Instructions to Complete Form

Worksheet Format:

Please do not alter the form by adding or deleting columns as it will affect formulas that automatically compute based on data entered into the spreadsheet. Rows can be added or deleted based on need. It is recommended that adding or removing rows occur between row 4 and row 23.

Creating a List within a Cell:

GENERAL		
R/W Plan Sheet #	Parcel Number	Owner
106	022605-9000	Norris
	022605-9215	
106	022605-9216	Money
	022605-9325	
	022605-9326	
107	022605-9327	Big Blue Diner

A list of information can be added to a single cell by clicking the “Alt” key at the same time and clicking on the “Return” key.

Selecting Correct Form:

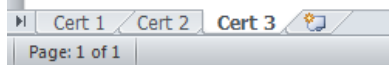

The excel spreadsheet is set up as a single workbook with tabs at the bottom left corner of the screen. Select the Cert 3 tab to complete the worksheet.

Electronic Worksheet Instructions:

R/W Plan Sheet #	Parcel Number	Pre-NEPA	Fee	Access Rights	Esmt.* P/N/L	Date Esmt.* N/L Expires

Enter the ROW plan sheet number on which the parcel is shown. Parcels should be listed in sequential order according to the ROW plans.

The electronic instructions to complete the worksheet are embedded in each title cell of row 3. Either hover the mouse of the title cell or left click in the cell and the instructions will appear. Once you remove the mouse or click on another cell the instructions will disappear.

Header:

Certificate No. 3
 Agency: Name of Agency
 Project Title: Project Title F.A. No.: Federal Aid No.

Agency Name: Enter acquiring agency name.
Project Title: Enter complete project title which was used on the STIP.
F.A. No.: Enter the federal aid number for the project.

General Section:

GENERAL		
R/W Plan Sheet #	Parcel Number	Owner

R/W Plan Sheet #: Enter the ROW plan sheet number on which the parcel is shown. Parcels should be listed in sequential order according to the ROW plans.
Parcel Number: The parcel numbers should be listed in the order shown on the ROW plans. Enter the parcel number as identified on the Right of Way Plan. If there are multiple parcels numbers making up the larger parcel determination, they should be shown as a single entry on one line to ensure the parcel count is accurate(use Alt enter function). Please note ROW Plans should be consistent with the certification worksheet.
Owner: Enter the owner name (last name, first name or business name). If there are multiple owners, they should be shown as a single entry on one line to ensure the parcel count is accurate(use Alt enter function).

Acquisition Section:

ACQUISITION											
Pre-NEPA	Fee	Access Rights	Esmt.* P/N/L	Date Esmt.* N/L Expires	Effective Date TCE	Date TCE Expires	Effective Date Permit or Right of Entry	Date Permit or Right of Entry Expires	Date Acquired	Possession Date (P&U) Only	Estimated Possession Date

Pre NEPA: If an offer was made on a parcel prior to environmental approval (NEPA), place an "X" in cell. For all offers made on parcels after environmental approval this field should be left blank.
Fee: If fee simple rights (exclusive use and occupancy) were acquired from any portion of the parcel, place an "X" in the cell.

Access Rights: Access rights apply to limited access facilities (such as interstate, WSDOT access breaks). If access rights (including light, view, and air) were acquired from any portion of the parcel, place an "X" in the cell.

Esmt.* P/N/L: If a permanent (perpetual), non-permanent (defined term), or lease was acquired from any portion of the parcel, place an "P" for permanent easement, or an "N" for non-permanent easement, or an "L" for lease in cell. *If something less than a permanent easement is acquired FHWA approval is required.

Date Esmt.* N/L Expires: If you have FHWA approval to acquire a non-permanent easement or lease, enter the expiration date identified in the easement/lease in this cell. This column is not used in the case of a permanent easement.

Effective Date TCE: If a temporary easement is acquired for construction purposes on any portion of the parcel, enter the start date of the TCE. This is normally the same date as the date acquired. This is the date the agency has legal and physical possession, which is also referred to as the payment available date. Possession cannot occur prior to payment to the property owner. In the case of donations, the effective date is the possession date.

Date TCE Expires: Enter the date the temporary construction easement expires as specified in the temporary easement. Agencies should always use a specific expiration date to avoid clouding a property owner's title.

Effective Date Permit or Right of Entry: Permits or right of entries are obtained for any portion of the parcel from other agencies to perform work on their property and normally without payment of compensation, such as tying into another jurisdiction's road. Situations that involve temporary work between agencies, does not have to follow the URA process. If a permit or right of entry was obtained for construction activities required for the project, enter the start date of the permit or right of entry. This is normally the same date as the date acquired. Preliminary testing or studies in advance of construction activities are not required to be certified since the work is not part of the PS&E. Also, "beneficial" permits from private property owners are not required to be certified since the work is not required for the project itself and can be eliminated from the contract if the owner were to revoke the permit.

Date Permit or Right of Entry Expires: Enter the date the permit or right of entry expires as specified in the permit or right of entry.

Date Acquired: Date acquired is the date the agency has legal and physical possession and reached final settlement, which is also referred to as the payment available date. Possession cannot occur prior to payment to the property owner. If the payment is mailed, the agency should add 5 days to the mailing date. In the case of donations, the effective date is the possession date. Enter the date the property was acquired. This must be filled in for each parcel acquired except in the case where final settlement has not been reached (see possession date below) even if the same date appears in other columns.

Possession Date (P&U Only): The possession date is the date the agency has the right to occupy and use the portion of the parcel needed for the project. Enter the date the agency obtained possession and use of the property. Possession cannot occur prior to payment to the property owner. In the case of a negotiated P&U, if the payment is mailed, the agency should add 5 days to the mailing date. If the payment is deposited into the court in the case of stipulated P&U, enter the date of receipt by the court clerk's office. This is only applicable in situations in which all necessary rights of way have not been acquired because final settlement has not been reached.

Estimated Possession or Clear Date: This column is only used if there are parcels excepted from the certification which are shown at the bottom of the spreadsheet highlighted in orange. Enter the date the agency estimates they will obtain possession or the date the parcel will be cleared for certification (occupants relocated, improvements cleared from the right of way, cost to cures completed).

NOTE: Refer to the Sufficient Property Rights flow chart (Appendix 25.174 & 25.175) for actual definition of property rights.

Relocation Section:

RELOCATION					
Non-Residential					
None	Res.	Bus.	Farm	NPO	PPO

- None:** If there was no relocation on the parcel place "X" in cell. Even in situations where projects have no relocation, the cell should not be left blank.
- Res:** If your project displaced a residential owner or tenant occupant from the parcel place an "X" in the cell. If there are multiple displaced persons for one parcel number, type in the number (you will need to change any other cells in the column marked with an "x" to a number) and change the formula in the total row to auto sum.
- Bus.:** If your project displaced a business, including qualifying residential landlords (not to be confused with a business that has to relocate personal property only), place an "X" in the cell. If there are multiple displaced businesses for one parcel number, type in the number (you will need to change any other cells in the column marked with an "x" to a number) and change the formula in the total row to auto sum.
- Farm:** If your project displaced a farm, place an "X" in the cell. If there are multiple displaced farms for one parcel number, type in the number and change the formula in the total row to auto sum.
- NPO:** If your project displaced a Non-Profit Organization (NPO), place an "X" in the cell. If there are multiple displaced NPOs for one parcel number, type in the number (you will need to change any other cells in the column marked with an "x" to a number) and change the formula in the total row to auto sum.
- PPO:** If your project displaced Personal Property Only (PPO), place an "X" in the cell. If there are multiple PPO displacements for one parcel number, type in the number (you will need to change any other cells in the column marked with an "x" to a number) and change the formula in the total row to auto sum.

Calculated Totals Section:

GENERAL			ACQUISITION										RELOCATION							
R/W Plan Sheet #	Parcel Number	Owner	Pre-NEPA	Fee	Access Rights	Emt.* P/N/L	Date Emnt.* N/L Expires	Effective Date TCE	Date TCE Expires	Effective Date Permit or Right of Entry	Date Permit or Right of Entry Expires	Date Acquired	Possession Date (P&U) Only	None	Res.	Bus.	Farm	NPO	PPO	Estimated Possession Date
	0		0	0	0	0	0	0	0	0	0	0	0	0	0	0	0	0	0	

Column Totals: Each column has a formula at the bottom that will "count" the box if it has data in it. The calculations will happen automatically so there is no need to alter or enter

information in this section. The totals should be reconciled with the ROW plan to ensure all rights were acquired.

If you have multiple displacements for one parcel you will need to type in the number of displacements in the appropriate column and then change the formula in the total row from a "CountA" to an "Auto Sum".

Example:

Certificate No. 3
Agency: ABC County
Project Title: NW Gold Trail Project F.A. No.: STPU 2145(001)

GENERAL			ACQUISITION										RELOCATION					Estimated Possession or Clear Date			
R/W Plan Sheet #	Parcel Number	Owner	Pre-NEPA	Fee	Access Rights	Easmt.* P/N/L	Date Easmt.* N/L Expires	Effective Date TCE	Date TCE Expires	Date Permit or Right of Entry Expires	Date Right of Entry Expires	Date Acquired	Possession Date (P&U Only)	None	Res.	Non-Residential					
																Bus.	Farm	NPO	PPD		
106	022605-9000	Norris		X								1/21/15								X	
106	022605-9215	Money	X	X		P		2/1/15	8/30/15			2/1/15		X							
	022605-9325																				
	022605-9326																				
107	022605-9327	Big Blue Diner		X		P		2/1/15	8/30/15			2/1/15					X				
108	022605-9456	Strand	X	X	X							3/1/15			2						
109	022605-9165	State Parks				N	4/30/45					4/30/15		X							
111	022605-8500	Dreamy		X								4/1/15			1						
112	022605-7852	Kort		X								5/2/15	3/6/15	X							
106 & 107	022605-9512	Blossom		X										X							10/15/15
108	022605-7256	Falkner		X		P								X							10/15/15
	6		2	5	1	3	1	2	0					3	1	0	0	1			

Easement Key
 P=Permanent/Perpetual
 N=Non-Permanent (defined term)*
 L=Lease*
*Non-permanent easements and leases subject to FHWA approval

Excepted Parcels

Best practices:

ROW Plan – for ease of certification it is recommended that you do not rely solely on Tax Identification numbers as they do not define a parcel acquisition. It is better to assign a parcel number that will identify the entire acquisition which could encompass multiple tax parcel numbers.

If your agency uses both tax parcel numbers and assigned numbers, the use of numbers must be consistent between the ROW plan, ROW certification, parcels, and all file documents.

26.1 General Discussion

A 10 percent National aspirational goal was established by U.S. DOT for the participation of Disadvantaged Business Enterprises (DBEs) in transportation contracting, as a tool to evaluate equal opportunity in the award and administration of U.S. DOT-assisted contracting and address the effects of past and current discrimination. Requirements of the DBE Program, as prescribed in [49 CFR Part 26](#) and USDOT's official interpretations (i.e. Questions and Answers), apply to all recipients (and subrecipients) of highway, transit, and airport funds.

A local agency, when participating in programs funded in whole or in part with federal funds made available by the Washington State Department of Transportation (WSDOT), must adhere to WSDOT's DBE Participation Plan.

While WSDOT's Office of Equal Opportunity (OEO) has the overall responsibility for administration and implementation of WSDOT's DBE Program, local agencies (as subrecipients) also have an important role to ensure that their federally-assisted contracts are administered in accordance with [49 CFR Part 26](#) and the state's approved DBE Program Participation Plan, which is available on WSDOT's website.

WSDOT's OEO, in coordination with Local Programs, will conduct compliance reviews of the local agency's administration of the DBE Plan. Local agencies found to be in noncompliance may be subject to formal enforcement action (suspense or loss of federal funds and/or CA status). A finding of noncompliance will result from the failure to comply with the requirements of WSDOT's DBE Plan.

The following assurance statement shall be included in all federally-assisted advertisements, agreements, contracts, and all subcontracts:

- *The contractor, subrecipient, or subcontractor shall not discriminate on the basis of race, color, national origin, or sex in the performance of this contract. The contractor shall carry out applicable requirements of 49 CFR Part 26 in the award and administration of USDOT-assisted contracts. Failure by the contractor to carry out these requirements is a material breach of this contract which may result in the termination of this contract or such other remedy as the recipient deems appropriate, which may include, but is not limited to: (1) Withholding monthly progress payments; (2) Assessing sanctions; (3) Liquidated damages, or (4) Disqualifying the contractor from future bidding as non-responsible.*

26.2 Procedures

1. **Local Agency DBE Liaison Officer** – The local agency is responsible for ensuring program compliance and monitoring its contractor’s and/or Consultant’s DBE activities. To accomplish this, a DBE liaison officer must be appointed by the Local Agency. This liaison officer must be an administrator responsible to the chief executive of the agency. This administrator should have the authority to delegate the responsibility to the people who perform the contractor compliance function. The liaison officer’s duties are to ensure compliance with the DBE Plan by the local agency and by their contractors/consultants.
2. **DBE Firm(s) Certification** – The Washington State Office of Minority and Women’s Business Enterprise (OMWBE) is the sole authority in the State of Washington to perform certification of all minority business enterprises, women business enterprises, and socially and economically disadvantaged business enterprises for programs administered by any State, local, or Federal agency. This statutory authorization extends to and binds all USDOT DBE Program recipients in the State of Washington. In order to count as DBE participation by prospective bidders on federally funded projects, firms must be currently, certified by OMWBE. The directory of currently certified DBE firms is available on the OMWBE’s website. The directory list can be accessed via OMWBE’s website at omwbe.diversitycompliance.com (Diversity Management and Compliance System - DMCS) or by calling 360-664-9770 or toll free (866) 208-1064. Firms not listed in the OMWBE’s database will not count towards DBE participation on new contracts.
3. **UDBE Firm(s) Certification** – WSDOT is required to maintain a narrowly tailored DBE Program, which means that only groups which face discrimination can participate in the race or gender-conscious portion of the program.

Based on the results of WSDOT’s 2012 DBE Disparity Study, and subsequent waiver, participation by non-minority women owned DBEs cannot be counted towards race/gender-conscious DBE goals. Non-minority women-owned DBE firms do, however, remain part of the overall DBE program and can be counted as race/gender-neutral participation.

While the waiver is in place, all other certified DBE firms are being referred to as Underutilized Disadvantaged Business Enterprises (UDBE). UDBE firms are a subset of the DBE certification. To determine if a firm is a UDBE (and therefore able to count towards race/gender conscious UDBE goals), refer to OMWBE’s DBE Directory of Certified Firms (e.g., Search Certified Firm Directory, then Search by Reference at bottom of page). UDBE firms count as participation towards the COA goals for federally funded contracts awarded after June 1, 2017.

4. **Establishment of Project UDBE Goals** – The Local Programs Project Development Engineer will review each construction project or consultant agreement to determine if it involves work or scope elements that are conducive to UDBE participation. To initiate this review, the local agency must submit an engineer's estimate for a construction project or a detailed scope and cost estimate for a consultant agreement with their suggested UDBE goal, to the Region Local Programs Engineer when the contract work or consultant agreement scope is determined. The estimate must show the item quantities or scoping costs of the project.
 - Construction funding will NOT be obligated prior to the project review and determination of UDBE goals.
 - PE costs will be obligated, but the Local Agency CANNOT advertise for Consultant Services, prior to a UDBE goal determination for the agreement.

For alternate construction contracting delivery (such as Design-Build), Local Agencies shall request approval from Region Local Programs Engineer. If a local agency has any other projects tied to a federally funded project that utilizes one set of bid documents, the total of both projects are considered as a federal aid project for UDBE goal setting purposes.

The goals for federal aid projects will be set under one of the following categories based on the projected participation level during the year to achieve WSDOT's overall goal:

- Mandatory Goal
- Voluntary Goal

The Local Programs Project Development Engineer will then establish a UDBE goal for the construction contract or consultant agreement. The elements considered by WSDOT in determining state and local agency project contract or consultant goals are as follows:

A. Elements

- a. Geographical location of the project;
- b. Type(s) of work included in the project, i.e., structure, roadway, new construction;
- c. Availability of UDBE firms certified to perform the type(s) of work;
- d. Potential subcontractable items.
- e. Total dollar value of the contract.

The attainment accomplished through this analysis will be reviewed periodically to determine the appropriateness of the method of setting goals.

B. Goal Setting Process

- a. Review the department's overall UDBE goal and the means to meet the goal.
 - b. If the contract includes federal funds, a UDBE goal is considered.
 - c. If the total agreement or contract amount is under \$100,000.00 then a Mandatory goal is not assigned. However, a Voluntary goal of 10% will apply to the agreement or contract. (Shown in DMCS as FSBE goal of 10%.)
 - d. Review the bid items and determine which scopes of work that the prime contractor/consultant is likely to perform (i.e., the prime contractor is required to perform at least 30% of the project total, while it is recommended for a prime consultant). Typically, grouped types of work that exceed 30% are considered as possible prime contractor/consultant work and are not considered when evaluating for UDBE goal calculation.
 - e. Evaluate the remaining bid items and determine which items are typically grouped for subcontracting (e.g. traffic control, electrical, guardrail, etc.).
 - f. Of these items, determine which ones lend themselves to UDBE participation. In other words, are there UDBEs shown in OMWBE's Directory of Certified Firms that are certified to perform the types of work likely to be subcontracted.
 - i. Mobilization is not an item considered when determining which items a prime contractor will subcontract to another contractor. This is not to say that subcontractors (UDBE or non-UDBE) do not include mobilization costs in their quotes, or that they are not paid for mobilization – only that mobilization is not considered a subcontract item when determining a UDBE goal.
 - ii. Force Account work will be considered at 50%
 - g. No UDBE goal shall be set at less than 2%.
4. **DBE Provisions in the Plans, Specifications, and Estimates (PS&E)** – After the mandatory or voluntary goals are determined, the applicable WSDOT General Special Provision (GSP), for the type of goal set, as outlined above shall be included in the PS&E. These GSPs are available on the WSDOT website or from the Region Local Programs Engineer. Only the WSDOT GSPs are approved for use on a FHWA funded project.

To complete the UDBE requirements in the PS&E one of the following applies. When a mandatory goal is established, DOT [Form 272-056U](#), UDBE Utilization Certification, DOT [Form 422-031U](#), UDBE Written Confirmation, DOT Form 272-058, Underutilized Disadvantaged Business Enterprise Trucking Credit Form **MUST** be included. These forms shall be included in the proposal given to each bidder. These forms are available from the Region Local Programs Engineer.

When a voluntary goal is established, the UDBE Utilization Certification and the UDBE Written Confirmation forms are not required. However, the contractor shall submit a SBE plan to Local Agency **PRIOR** to receiving notice to proceed. The Local Agency will forward the SBE plan to the Region Local Programs Engineer within **15 days** of contractor beginning work.

26.3 Contract Procedures

1. **Bid Opening** – Each bid proposal must be reviewed to determine if the bid is responsive. For a contract with goals, each proposal shall contain the UDBE Utilization Certification, UDBE and Written Confirmation form, and the UDBE Trucking Credit Form completed by the contractor. If the prime is proposing to use a UDBE broker they must also submit the broker agreement as part of the bid package.

Failure to accurately complete these forms will be considered as evidence that the proposal is nonresponsive and, therefore, is not eligible for award.

2. **Is the DBE/UDBE Firm Certified by OMWBE** – The UDBE firm named by the contractor in the bid proposal shall be certified as a UDBE firm by OMWBE and currently shown in the (DMCS) to be eligible for work on a FHWA funded project. To verify whether a firm is certified as a UDBE and eligible to perform work on a FHWA funded project, you must refer to OMWBE's Directory of Certified Firms which is available at www.omwbe.diversitycompliance.com and document your effort in the project file. Suspended DBE Firms will not be shown in DMCS. Firms that are suspended (and not shown) cannot be used to meet the condition of award goal nor be counted as DBE/UDBE participation on any new contracts issued subsequent to the date of suspension. Questions related to the content of the directory can be directed to OMWBE at 360-664-9770 or toll free 866-208-1064. To meet the goals for the project, DBE firms that are not certified or certified UDBE firms that are suspended at the time of bid opening will not be accepted by the local agency for participation, as a Condition of Award (COA) Contractor/ Subcontractor on the project.

3. **Selection of the Successful Bidder**

A. Selection of Successful Bidder (when a mandatory goal is established)

- a. The successful bidder shall be selected on the basis of having submitted the lowest responsive bid and, in order to be responsive, making good faith efforts to meet the UDBE goal. The bidder can meet this requirement in either of two ways:
 1. Documenting that it has obtained enough UDBE participation (commitments) to meet the goal; or,
 2. Documenting that it has made adequate Good Faith Efforts (GFE) to meet the established UDBE goal. A bidder is required to submit GFE documentation with their proposal only in the event that the bidder's efforts to solicit sufficient UDBE participation were unsuccessful.

GFE means that the bidder must show that it took all necessary and reasonable steps to achieve the UDBE goal, and by their scope, intensity, and appropriateness to the objective, the bidder could reasonably be expected to obtain sufficient UDBE participation, even if the bidder was not fully successful in meeting the established UDBE goal. Efforts done as a matter of form or for the sake of appearance are not considered “good faith efforts” to meet the contract requirements for UDBE utilization.

- b. Should the low and otherwise responsive bidder fail to attain the goal and not provide adequate GFE documentation in the bid submittal, its bid will be determined to be nonresponsive, and the next low responsive bid will be reviewed for acceptance.

Agencies that have projects with mandatory UDBE goals, shall submit the bid tabs, the UDBE Utilization Certification, the UDBE Written Confirmation Document, the UDBE Trucking Credit form, and any broker agreements (as applicable) of the apparent low bidder, to the Region Local Programs Engineer (LPE) to obtain concurrence to award, **before** the contract is officially awarded to the apparent low bidder. Failure to gain LPE concurrence **prior to award** on every project with UDBE goals and subsequent award of a contract to a nonresponsive bidder will jeopardize the project’s federal funding.

- c. If the apparent low bidder submits GFE documentation with the bid, the Local Agency will submit the documentation to Local Programs for approval action prior to awarding the project. GFE documentation must include copies of each UDBE and non-UDBE subcontractor quote submitted to the bidder when a non-UDBE subcontractor was selected over a UDBE for work on the contract.

B. After Award – The Local Agency will request that the apparent low bidder submit a description of the specific bid items each UDBE subcontractor named in the UDBE Utilization Certification will perform, within five (5) working days following the award. This description, dollar amount, and name of the UDBE firm is identified in the award letter and made Condition of the Award (COA) of the contract.

C. Administrative Reconsideration – If Local Programs determines that the apparent successful bidder failed to meet the UDBE goal and that GFE was inadequate, the bidder will have the right to request reconsideration. The Bidder must request within 48 hours of notification of being nonresponsive or forfeit the right to reconsideration.

- a. WSDOT’s decision on reconsideration shall be made by an official who did not take part in the original determination that the bidder failed to meet the goal (as described above).

- b. The bidder shall have the opportunity to meet in person with said official to discuss their good faith effort package. The bidder's position must be based on its bid submittal. The bidder may provide further explanation/clarification of the information and materials in the bid submittal, but no new material or information will be considered by the official in reaching a decision on reconsideration.
 - c. WSDOT shall send the bidder a written decision on reconsideration, explaining the basis for their findings.
 - d. The result of the reconsideration process is not administratively appealable to the USDOT.
- D. **Brokering** – If the apparent low bidder selects an UDBE Broker (or a service provider for providing a bona fide service) to meet part of the established UDBE goal, a UDBE Broker Agreement is required to be submitted as part of the Proposal or as a Supplement to the Bid. To be considered responsive, the Broker Agreement shall document the fees or commissions charged. The fee/commission shall be reasonable as determined by WSDOT.
- E. **Trucking** – When a UDBE Trucking firm is used to meet the established UDBE goal, the UDBE Trucking Credit Form (DOT Form 272-058) is required to be submitted as part of the Proposal or as a Supplement to the Bid. The Form shall identify the items to be hauled, the type of trucks to be used, and the number of trucks currently owned by the UDBE firm.
4. **Condition of Award Letter** – The condition of award letter carries the same contractual obligation as the contract specifications and is only required when a mandatory goal is established for a project. An example of a zero goal award letter appears in [Appendix 46.43](#) and an example of a mandatory goal award letter appears as [Appendix 46.44](#). The information contained in the body of these examples must be included in the local agency award letter. If a portion of an item is sublet to a UDBE and the remainder is done by the contractor or another subcontractor, the UDBE's work must be shown in detail. Also, any UDBE suppliers and manufacturers shall be shown.

Send a copy of this letter, a copy of the "Underutilized Disadvantaged Business Enterprise Utilization Certification and a copy of the "UDBE Written Confirmation Document" to the Region Local Programs Engineer as a part of the award documentation submittal explained in [Chapter 46](#).

Attach a copy of the letter to the contract papers that you send to your contractor for signature. The Region Local Programs Engineer shall be provided information on subletting by UDBE contractors.

5. **Between Award and Execution** – The contractor shall provide all of the information described in the GSPs including a bidders' list for all categories (zero and mandatory goals). The list shall include all firms (names and addresses) that submitted a bid or quote (successful and unsuccessful) in an attempt to participate on the project. The local agency shall immediately notify the Region Local Programs Engineer by email with the name and address of the successful contractor for forwarding to the OEO's contract compliance officer.

Similarly, the Local Agency shall provide WSDOT with a list of all bidders (successful and unsuccessful) who submitted a bid on the prime contract.

6. **Monitoring DBEs During Construction** – The local agency must place special emphasis on the DBE requirements at the preconstruction conference. Changes to the work of a Condition of Award UDBE shall be handled in accordance with the GSP. All change orders affecting the work of DBEs shall be submitted to the Region Local Programs Engineer for concurrence prior to executing the change order.

Project diary documentation of the DBEs' activities on the project must be performed in the same manner as is done on the prime contractor and any other subcontractor's activities.

In order to receive credit for UDBE participation (count towards the contract goal) a DBE firm must be performing a Commercially Useful Function (CUF) on that contract. See GSPs for additional information on CUF.

Hence, in addition to the project diary, the local agency must document that each DBE working on the project is performing a Commercially Useful Function (CUF). The form "DBE On-Site Review" shall be used by the local agency for purposes of documenting CUF for each DBE contractor/consultant. See [Appendix 26.54](#) for the DBE On-Site form (and instructions) for Construction Subcontractors/Regular Dealers/Manufacturers; and [Appendix 26.55](#) for the DBE On-Site review form for Architect & Engineering/Professional Services Firms. DBE On-site reviews must be conducted:

- At the start of work, and/or
- At the peak period of work, and
- Whenever changes in the performance of the work warrants its completion.

The review should be completed per on-site observations, documentation review, and interviews of contractor's personnel. If there is evidence that a DBE firm may not be performing a CUF, immediately contact your Region Local Programs Engineer.

This completed form becomes a part of the local agency's project records and a copy of the completed form submitted to Region Local Programs Engineer within **14 days** of form completion.

The WSDOT GSP, Disadvantaged Business Enterprise Participation Plan, and [Chapter 1](#) of the [Construction Manual](#) M 41-01 shall be followed to ensure compliance with DBE Program requirements.

WSDOT's Office of Equal Opportunity (OEO) may also perform in-depth CUF's on DBE firms performing work on Federal-aid local agency projects (as OEO determines necessary/appropriate).

7. **Prompt Payment (Progress and Return of Retainage)** – Local agencies must comply with State and Federal prompt payment laws. In addition, local agencies are expected to monitor and enforce the prompt payment requirements under State Law (as well as [49 CFR Part 26.29](#)), as regards their contracts with prime contractors. Monitoring prompt payment requires the contracting agency to verify that payments to subcontractors are commensurate with the subcontractors' work scope, and are processed/issued within the allowed timeframe. Prompt payment violations on Federal-aid contracts are a violation of the DBE program, which is considered a breach of contract. When violations are found to exist, local agencies must enforce the terms of the contract by taking appropriate enforcement action.

State law requires payment to subcontractor within ten days of receipt by the prime contractor. Refer to 2016 *Standard Specifications* Section 1-08, Prosecution and Progress along with [RCW 39.04.250](#), [RCW 39.76.011](#), [RCW 39.76.020](#), and [RCW 39.76.040](#) for more detailed "Prompt Payment" requirements.

8. **During Construction** – The prime contractor shall enter all payment information into the WSDOT DMCS (wsdot.diversitycompliance.com) each month for all federal aid projects and select state funded projects. The prime contractor shall enter the amounts, received from the agency and the amounts paid to all firms involved with the contract (Zero payments shall be marked accordingly). All firms shall confirm the payments amount received from the prime contractor each month and the local agency shall verify these entries in the WSDOT Diversity Compliance System. All payment information shall be entered monthly and include the actual date of the payment.
9. **Upon Completion** – The prime contractor will record in the system, when the final payment is made to each firm and when the final payment for the project is received from the agency. Subcontractor and firms must confirm the receipt of the final payment. The agency shall make notification of final project payment to the Local Programs Project Development Engineer at the completion of the project.

In addition, for each contract, local agencies must document (in the form of a Written Certification see [Appendix 26.56](#)) that it has reviewed the contracting records and monitored the work site and determined that work committed to the UDBEs at contract award (and subsequently) was actually performed by said UDBEs – See [Appendix 26.56](#).

10. **Records and Reports** – The local agency will maintain such records and provide such reports as necessary to ensure full compliance with WSDOT's UDBE Participation Plan.

Upon request from the OMWBE, WSDOT, or the USDOT operating administrations (e.g., FHWA), the local agency shall submit the records deemed necessary for inspection, auditing, and review purposes.

26.4 Consultant Agreement Procedures

The consultant agreement procedures for the DBE administration differ somewhat from the construction contract approval process outlined above, as the agreement is negotiated after selection of the most qualified firm to perform the scope of work.

1. **Selection of the most qualified Firm** – After selection and negotiations with the most qualified firm and before contract execution, the Local Agency must submit the UDBE Plan and Good Faith Effort (GFE) documentation, if applicable, that was submitted by the successful firm to the Region Local Programs Engineer for concurrence. During this review, Local Programs will review the plan and GFE documentation to see if proposed UDBE firms are certified to perform the scope of work and any GFE documentation that was submitted as part of the UDBE Plan before concurrence to execute the agreement is given to the Local Agency.
2. **A Monitoring the DBE's during the life of the Agreement** – The Local Agency must place a special emphasis on the approved UDBE Plan during the life of the agreement. The consultant shall report monthly (to the local agency) on its progress towards achieving the commitments outlined in the UDBE Plan. The agency must inquire and monitor the plan to make sure the consultant is on track to meet the planned goal and if any changes are needed to the plan to ensure that the approved goal is met. If changes are needed to the original UDBE plan the local agency must submit them to the Region Local Programs office for concurrence prior to documenting that approval with an executed supplement to the consultant agreement.

In order to receive credit for DBE participation (count towards the contract UDBE goal) a DBE firm must be performing a Commercially Useful Function (CUF) on that contract. Local agency must document that each DBE working on the project is performing a Commercially Useful Function (CUF). The form “DBE On-Site Review” shall be used by the local agency for purposes of documenting CUF for each DBE consultant. See [Appendix 26.55](#) for the DBE On-Site review form for Architect & Engineering/Professional Services Firms. DBE On-site reviews must be conducted:

- At the start of work, and/or
- At the peak period of work, and
- Whenever changes in the performance of the work warrants its completion.

If there is evidence that a DBE firm may not be performing a CUF, immediately contact your Region Local Programs Engineer.

This completed form becomes a part of the local agency's project records. Additional forms are available from your Region Local Programs Engineer.

The WSDOT Local Agency Consultant Agreements and Underutilized Disadvantaged Business Enterprise Participation Plan shall be followed to ensure compliance with the DBE Program requirements.

WSDOT's Office of Equal Opportunity (OEO) may also perform in-depth CUF's on DBE firms performing work on Federal-aid local agency projects (as OEO determines necessary/appropriate).

- Prompt Payment (Progress Payment)** – Local agencies must comply with State and Federal prompt payment laws. In addition, local agencies are expected to monitor and enforce the prompt payment requirements under State Law (as well as 49 CFR Part 26.29), as regards their contracts with prime consultants. Monitoring prompt payment requires the contracting agency to verify that payments to subconsultants are commensurate with the subconsultants' work scope, and are processed within the allowed timeframe. Prompt payment violations on Federal-aid contracts are a violation of the DBE program, which is considered a breach of contract. When violations are found to exist, local agencies must enforce the terms of the contract by taking appropriate enforcement action.

State law requires payment to subconsultant(s) within ten days of receipt by the prime consultant. Refer to [RCW 39.04.250](#), [RCW 39.76.011](#), [RCW 39.76.020](#), and [RCW 39.76.040](#) for more detailed "Prompt Payment" requirements.

- During Contracting Period** – The prime consultant shall enter all payment information into the WSDOT DMCS (wsdot.diversitycompliance.com) each month for all federal aid projects and select state funded projects. The prime consultant shall enter the amounts, received from the agency and the amounts paid to all firms involved with the contract (Zero payments shall be marked accordingly). All firms shall confirm the payments amount received from the prime consultant each month and the local agency shall verify these entries in the WSDOT Diversity Compliance System. All payment information shall be entered monthly and include the actual date of the payment.
- Upon Completion** – The prime consultant will record in the system, when the final payments are made to each firm and when the final payment for the project is received from the agency. Subcontractor and firms must confirm the receipt of the final payment. The agency shall make notification of final project payment to the Local Programs Project Development Engineer at the completion of the project.

In addition, for each contract, local agencies must document (in the form of a Written Certification, see [Appendix 26.56](#)) that it has reviewed the contracting records and monitored the work site and determined that work committed to the UDBEs at contract award (and subsequently) was actually performed by said UDBEs – See [Appendix 26.56](#).

- Records and Reports** – The local agency will maintain such records and provide such reports as necessary to ensure full compliance with WSDOT's UDBE Participation Plan.

Upon request from the OMWBE, WSDOT, or the USDOT operating administrations (e.g., FHWA), the local agency shall submit the records deemed necessary for inspection, auditing, and review purposes.

26.5 Appendices

- 26.51 Vacant
- 26.52 Underutilized Disadvantaged Business Enterprise Utilization Certification
- 26.53 UDBE Written Confirmation Document
- 26.54 DBE On-Site Review for Construction Subcontractors/Regular Dealers/
Manufactures
- 26.55 Project Office DBE On-Site Review for Architect & Engineers/Professional
Service Firms
- 26.56 Written Certification

Appendix 26.51 Vacant

Underutilized Disadvantaged Business Enterprise Utilization Certification



**Washington State
Department of Transportation**

Underutilized Disadvantaged Business Enterprise Utilization Certification

To be eligible for Award of this Contract the Bidder shall fill out and submit, as a supplement to its sealed Bid Proposal, an Underutilized Disadvantaged Business Enterprise (UDBE) Utilization Certification. The Contracting Agency shall consider as non-responsive and shall reject any Bid Proposal that does not contain a UDBE Utilization Certification which properly demonstrates that the Bidder will meet the UDBE participation requirements in one of the manners provided for in the proposed Contract. **Refer to the instructions on Page 2 when filling out this form or the Bid may be rejected. An example form has been provided on Page 3.** The successful Bidder's UDBE Utilization Certification shall be deemed a part of the resulting Contract.

Box 1: _____ certifies that the UDBE firms listed below have been contacted regarding participation on this project. If this Bidder is successful on this project and is awarded the Contract, it shall assure that subcontracts or supply agreements are executed with named UDBEs. (If necessary, use additional sheets.)

Box 2: _____

Column 1 Name of UDBE <small>(See instructions)</small>	Column 2 Project Role <small>(See instructions)</small>	Column 3 Description of Work <small>(See instructions)</small>	Column 4 Dollar Amount Subcontracted to UDBE <small>(See instructions)</small>	Column 5 Dollar Amount to be Applied Towards Goal <small>(See instructions)</small>

Underutilized Disadvantaged Business Enterprise Condition of Award Contract Goal _____ Total UDBE Commitment Dollar Amount _____
Box 3 Box 4

5 By checking Box 5 the Bidder is stating that their attempts to solicit sufficient UDBE participation to meet the COA Contract goal has been unsuccessful and good faith effort will be submitted in accordance with Section 1-02.9 of the Contract

DOT Form 272-056U
Revised 03/2018

Instructions for Underutilized Disadvantaged Business Enterprise Utilization Certification Form

Box 1: Name of Bidder (Proposal holder) submitting Bid.

Box 2: Name of the Project.

Column 1: Name of the Underutilized Disadvantaged Business Enterprise (UDBE). UDBE Firms can be found using the search tools under the Firm Certification section of the Diversity Management and Compliance System web page <https://wsdot.diversitycompliance.com> Repeat the name of the UDBE for each Project Role that will be performed.

Column 2: The Project Role that the UDBE will be performing as follows;

- Prime Contractor
- Subcontractor
- Subcontractor (Force Account)
 - Work sublet as Force Account must be listed separately.
- Manufacturer
- Regular Dealer
 - Work sublet to a Regular Dealer must be listed separately.
 - Regular Dealer status must be approved prior to Bid submittal by the Office of Equal Opportunity, Washington State Department of Transportation, on each Contract.
- Broker
 - Work sublet to a Broker must be listed separately.

List each project role to be performed by a single UDBE individually on a separate row(s). The role is used to determine what portion of the amount to be subcontracted (Column 4) may be applied toward meeting the goal (column 5).

Column 3: Provide a description of the work to be performed by the UDBE. The work to be performed must be consistent with the Certified Business Description of the UDBE provided at the Diversity Management and Compliance System web page <https://wsdot.diversitycompliance.com>

- A Bidder subletting a portion of a bid item shall state **“Partial”** and describe the Work that is included.
 - For example; “Electrical (Partial) – Trenching”.
- “Mobilization” will not be accepted as a description of Work.

Column 4: List the total amount to be subcontracted to each UDBE for each Project Role they are performing.

Column 5: This is the dollar amount for each line listed in the certification that the prime intends to apply towards meeting the COA Contract goal. It may be that only a portion of the amount subcontracted to a UDBE in Column 4 is eligible to be credited toward meeting the goal **See Note 1, Note 2, Note 3**. The Contracting Agency will utilize the sum of this column (Box 4) to determine whether or not the bidder has met the goal. In the event of an arithmetic error in summing column 5 or an error in making appropriate reductions in the amounts in column four, **See Note 1, Note 2, Note 3**, then the mathematics will be corrected and the total (Box 4) will be revised accordingly.

Note 1: For Work sublet as Force Account the bidder **may only claim 50%** of the amount subcontracted (Column 4) towards meeting the goal (Column 5). This information will be used to demonstrate that the UDBE contract goal is met at the time that the bidder submits their bid. For example; amount sublet as force account = \$100,000 (Column 4) equates to $(\$100,000 \times 50\%) = \$50,000$ (Column 5) to be applied towards the goal.

Note 2: For Work sublet to a Regular Dealer the bidder **may only claim 60%** of the cost of the materials or supplies (Column 4) towards meeting the goal (Column 5). For example; Material cost = \$100,000 (Column 4) equates to $(\$100,000 \times 60\%) = \$60,000$ (Column 5) to be applied towards the goal

Note 3: For Work sublet to a Broker the bidder **may only claim the fees** paid to a Broker towards meeting the goal (Column 4). For example; amount sublet to a broker = \$100,000 (Column 4) equates to $(\$100,000 \times \text{reasonable fee \%}) = \$$ (Column 5) to be applied towards the goal.

Box 3: Box 3 is the COA Contract goal which is the minimum required UDBE participation. The goal stated in the Contract will be in terms of a dollar amount or a percentage in the Contract. When expressed as a percentage you must multiply the percentage times the sum total of all bid items as submitted in the Bidder’s Proposal to determine the dollar goal and write it in Box 3. In the event of an error in this box, the Contracting Agency will revise the amount accordingly.

Box 4: Box 4 is the sum of the values in column 5. **This value must equal or exceed the COA Contract goal amount written in Box 3 or;**

Box 5: Check Box 5 if insufficient UDBE Participation has been achieved and a good faith effort is required. Refer to the subsection titled, *Selection of Successful Bidder/Good Faith Efforts (GFE)* in the Contract.

See the Disadvantaged Business Enterprise Participation specification in the Contract for more information.

DOT Form 272-056U
Revised 02/2018



Underutilized Disadvantaged Business Enterprise Utilization Certification

To be eligible for Award of this Contract the Bidder shall fill out and submit, as a supplement to its sealed Bid Proposal, an Underutilized Disadvantaged Business Enterprise (UDBE) Utilization Certification. The Contracting Agency shall consider as non-responsive and shall reject any Bid Proposal that does not contain a UDBE Utilization Certification which properly demonstrates that the Bidder will meet the UDBE participation requirements in one of the manners provided for in the proposed Contract. **Refer to the instructions on Page 2 when filling out this form or the Bid may be rejected. An example form has been provided on Page 3.** The successful Bidder's UDBE Utilization Certification shall be deemed a part of the resulting Contract.

Box 1: A Plus Construction Company _____ certifies that the UDBE firms listed below have been contacted regarding participation on this project. If this Bidder is successful on this project and is awarded the Contract, it shall assure that subcontracts or supply agreements are executed with named UDBEs. (If necessary, use additional sheets.)

Box 2: US 395, Spokane City Limits to Stevens County Line - Paving and Safety _____

Column 1 Name of UDBE (See instructions)	Column 2 Project Role (See instructions)	Column 3 Description of Work (See instructions)	Column 4 Dollar Amount Subcontracted to UDBE (See instructions)	Column 5 Dollar Amount to be Applied Towards Goal (See instructions)
A Plus Construction Company	Prime	Asphalt and concrete paving, asphalt milling, preleveling and pavement repair	N/A	900,000
In the Line Services, Inc.	Subcontractor (Force Account)	Crack sealing	20,000	10,000
In the Line Services, Inc.	Subcontractor	Guideposts, joint seal, pavement markers, temporary signage, construction sign installation	200,000	200,000
The Everything Guys, LLC	Regular Dealer	Rental and sales of highway construction and related equipment and materials	100,000	60,000
Optimus Prime Trucking, Inc.	Subcontractor	Dump Trucking	50,000	50,000
Metalheads, Inc.	Manufacturer	Dowel Bars	75,000	75,000
Erosion Under Control Co.	Broker	Erosion control blankets, straw bales and wattles, sand bags	15,000	250

EXAMPLE

Underutilized Disadvantaged Business Enterprise Condition of Award Contract Goal 356,968.16 Box 3 Total UDBE Commitment Dollar Amount 1,295,250 Box 4

5 By checking Box 5 the Bidder is stating that their attempts to solicit sufficient UDBE participation to meet the COA Contract goal has been unsuccessful and good faith effort will be submitted in accordance with Section 1-02.9 of the Contract

DOT Form 272-056U
Revised 02/2018

Appendix 26.53 **UDBE Written Confirmation Document**



Underutilized Disadvantaged Business Enterprise (UDBE) Written Confirmation Document

See Contract Provisions: *UDBE Document Submittal Requirements*
Disadvantaged Business Enterprise Participation

THIS FORM SHALL ONLY BE SUBMITTED TO A UDBE THAT IS LISTED ON THE CONTRACTOR'S UNDERUTILIZED DISADVANTAGED BUSINESS ENTERPRISE UTILIZATION CERTIFICATION.

THE CONTRACTOR SHALL COMPLETE PART A PRIOR TO SENDING TO THE UDBE.

PART A: To be completed by the bidder

The entries below shall be consistent with what is shown on the Bidder's Underutilized Disadvantaged Business Enterprise Utilization Certification. Failure to do so will result in Bid rejection.

Contract Title: _____

Bidder's Business Name: _____

UDBE's Business Name: _____

Description of UDBE's Work: _____

Dollar Amount to be Applied Towards UDBE Goal: _____

Dollar Amount to be Subcontracted to UDBE*: _____
*Optional Field

PART B: To be completed by the Underutilized Disadvantaged Business Enterprise

As an authorized representative of the Underutilized Disadvantaged Business Enterprise, I confirm that we have been contacted by the Bidder with regard to the referenced project for the purpose of performing the Work described above. If the Bidder is awarded the Contract, we will enter into an agreement with the Bidder to participate in the project consistent with the information provided in Part A of this form.

Name (printed): _____

Signature: _____

Title: _____

Address: _____ Date: _____



**DBE/UDBE/FSBE Commercially Useful
Function On-Site Review for
Construction Contractors/Subcontractors**

Purpose: This form serves as written certification that the elements of work performed by a Disadvantaged Business Enterprise (DBE) contractor were monitored and evaluated according to the Commercially Useful Function and counting requirements of 49 Code of Federal Regulation Part 26.55. This form also contains data and questions to supplement monitoring of payments, termination of work, or changes in contract scope that may require prompt action to ensure final compliance.

This form is to be completed at the peak of work, anytime there is a significant change in the DBE/UDBE's work scopes, and yearly for multi-year projects. Once the Project Engineer Office has completed its portion of the review, **this form shall be sent to the Region Office of Equal Opportunity Compliance Specialist within 10 calendar days of completion.**

This form is to be completed based upon the reviewer's determination through observations and review of pertinent documents.

Section I: Project and Payment Data – To be completed by Project Engineer Officer

Contract Number		Contract Name	
Prime Contractor		DBE Goal %	Region/Local Agency
DBE Subcontract Amount	DBE Commitment Amount		Approx. % of DBE Work Complete
DBE Start Date	Total Payments to DBE to Date	Federal Aid No.	
DBE Firm Name		DBE Employee Interviewed	
DBE Firm Owner		DBE Employee Interviewed Title	
DBE Site Supervisor (if not owner)			
Certification Type: <input type="checkbox"/> UDBE <input type="checkbox"/> DBE <input type="checkbox"/> Federal Small Business Enterprise (FSBE)			
DBE Contract Type: <input type="checkbox"/> Prime Contractor <input type="checkbox"/> Subcontractor <input type="checkbox"/> Lower-tier Subcontractor <input type="checkbox"/> Trucking/Hauling			
DBE Contract Arrangement: <input type="checkbox"/> Furnish and Install <input type="checkbox"/> Labor Only <input type="checkbox"/> Owner/Operator			

Description of work to be performed by the DBE according to the approved Request to Sublet/Bid Item Breakdown form:

Termination/Partial Termination/Underrun **Section Not Applicable**

1. Have there been any changes in the project's scope that would affect the DBE's commitment? Yes No N/A
If yes, please provide an explanation below.

DOT Form 272-052
Revised 06/2020

<p>2. Provide the dollar value of any work committed to the COA DBE that was terminated or partially terminated, or was performed by another firm without WSDOT's prior written consent.</p>
<p>3. If written concurrence was not obtained, did the PEO deny payment to the prime for work that was performed by another firm originally committed to the DBE? If no, please provide an explanation below.</p> <p style="text-align: right;"><input type="checkbox"/> Yes <input type="checkbox"/> No <input type="checkbox"/> N/A</p>
<p>4. Did the DBE perform at least 75% of its subcontract with its own forces? If no, please provide an explanation below.</p> <p style="text-align: right;"><input type="checkbox"/> Yes <input type="checkbox"/> No <input type="checkbox"/> N/A</p>
<p>5. Were adjustments made in counting participation where the DBE itself subcontracted any portion of its work to a non-DBE? If no, please provide an explanation below.</p> <p style="text-align: right;"><input type="checkbox"/> Yes <input type="checkbox"/> No <input type="checkbox"/> N/A</p>
<p>6. Did the prime make every good faith effort to replace the value of work under the commitment not performed by the DBE for any reason? If no, please provide an explanation below.</p> <p style="text-align: right;"><input type="checkbox"/> Yes <input type="checkbox"/> No <input type="checkbox"/> N/A</p>

DOT Form 272-052
Revised 06/2020

Section II: Project Engineer Office/Local Agency Observations and Interviews

DBE Employee Interview Questions

1. Is the person supervising you either the DBE firm owner or a Site Supervisor employed by the DBE firm? Yes No N/A
If no, please provide an explanation below.

2. Does your Site Supervisor direct and schedule all work activities, including material deliveries, without assistance from the Prime or upper tier contractor? Yes No N/A
If no, please provide an explanation below.

3. Do you work exclusively for the DBE firm on this project and not for any other contractors performing work on this project? Yes No N/A
If no, please provide an explanation below.

DBE Site Supervisor Questions (if supervision not being performed by the DBE Owner)

4. As Site Supervisor, are you a regular, fulltime, employee of the DBE Firm? Yes No N/A
If no, please provide an explanation below.

Project Office DBE On-Site Review for Architect & Engineering/Professional Services Firms



DBE/UDBE/FSBE On-Site Review Form/ Commercially Useful Function Architect & Engineering/Professional Services Firm

Purpose: This form serves as written certification that the elements of work performed by a Disadvantaged Business Enterprise (DBE) contractor were monitored and evaluated according to the Commercially Useful Function and counting requirements of 49 Code of Federal Regulation Part 26.55. This form also contains data and questions to supplement monitoring of payments, termination of work, or changes in contract scope that may require prompt action to ensure final compliance.

This form is to be completed once the subconsultant is actively engaged in their scope of work, anytime there is a significant change in the DBE/UDBE's work scopes, yearly for multi-year project, and for each primary scope of work. **This form must be submitted to Region OEO staff within 10 calendar days of its completion.** If the form is submitted with missing/incomplete information, it will be returned to the Project Engineer's Office for completion.

This form is to be completed based upon the reviewer's determination through observations and review of pertinent documents.

For DBE Firms located out of state, interview with DBE will likely need to be accomplished by available technology or telephone.

Section I: Project and Payment Data - To be filled out by Project Manager

1. Contract Number	2. Prime Consultant
3. Project Name	
4. DBE Goal	5. Region/Local Agency
6. DBE Subconsultant \$	7. DBE Commitment \$
8. % of DBE Work Completed	
9. DBE Start Date	10. DBE Total Payment to Date
11. DBE Company Name	12. DBE Company Owner
13. DBE Representative	14. DBE Representative Title
15. DBE is performing as: <input type="checkbox"/> Prime Consultant <input type="checkbox"/> Sub-consultant	
16. Certification Type: <input type="checkbox"/> UDBE <input type="checkbox"/> DBE <input type="checkbox"/> Federal Small Business Enterprises (FSBE)	
17. Consultant Type: <input type="checkbox"/> Architectural <input type="checkbox"/> Engineering <input type="checkbox"/> Surveying <input type="checkbox"/> Real Estate Appraisal <input type="checkbox"/> Right of Way Appraisal <input type="checkbox"/> Other:	

18. Provide a brief description of the DBE's scope of work as observed:

DOT Form 272-051
Revised 06/2020

19. The following questions pertain only to DBE participation submitted to meet a commitment goal:

a. Is the description of work in the DBE's subconsultant agreement/contract consistent with the prime's DBE commitment?

Yes No, if "No", how was this resolved? N/A

b. Was the amount of work performed by the DBE, to include any changes, able to meet the original DBE commitment amount? *Please describe/explain the changes and process followed to address the situation (e.g., termination, substitution, change order documenting change, etc.).*

Section II: Observation - To be filled out by the Project Manager	YES	NO	N/A
---	-----	----	-----

1. Is the DBE Project Manager exclusively employed by the DBE firm? If no, please provide explanation below:	<input type="checkbox"/>	<input type="checkbox"/>	<input type="checkbox"/>
---	--------------------------	--------------------------	--------------------------

2. Is the DBE Project Manager or classification of the DBE Staff shown on the monthly invoice or Payroll? (Request for copies of monthly invoices/payroll) If no, please provide explanation below:	<input type="checkbox"/>	<input type="checkbox"/>	<input type="checkbox"/>
--	--------------------------	--------------------------	--------------------------

3. Is the DBE Project Manager shown on any other firms' invoice? If no, please explain:	<input type="checkbox"/>	<input type="checkbox"/>	<input type="checkbox"/>
--	--------------------------	--------------------------	--------------------------

DOT Form 272-051
Revised 06/2020



Washington State
Department of Transportation

Final DBE Utilization Plan Report

Project Number	Federal-Aid Project Number	Region/Agency
----------------	----------------------------	---------------

Contract Title

Agency's Certification

I certify that the contracting records have been reviewed and the on-site performance have been monitored. I determined that work committed to the listed DBE's under this contract was actually performed by the listed DBE's.

X _____
Project Manager or Engineer Signature Required

Printed Signature Name

Business Phone Number

Date of Signature

A final report of DBE Contract Payment Reports must be attached in order to certify that the contracting records and on-site performance of the Disadvantaged Business Enterprises has been monitored in compliance with 49 CFR 26.37.

WSDOT Contract Original to:

Temporary Final Project Records/Project Engineer

Copies to:

Region OEO File

Local Agency Original to:

Project Record

Copies to:

WSDOT Local Programs Project Manager or Project Engineer

DOT Form 272-055
Revised 10/2017

27.1 General Discussion

To effectively assure Equal Employment Opportunity (EEO), it is the policy of the Federal Highway Administration (FHWA) to require that all federal aid highway construction contracts include specific requirements to implement the Title VI Program (Chapter 28), related civil rights laws and regulations. These specific requirements apply to contractors and all their subcontractors (not including material suppliers) holding subcontracts of \$10,000 or more. To be eligible for federal aid funds, the local agency must comply with the civil rights requirements.

The following statement shall be accepted by local agencies and contractors as their operating policy:

It is the policy of this Company to ensure that applicants are employed, and that employees are treated during employment, without regard to their race, religion, sex, color, national origin, or disability. Such action shall include: employment upgrading, demotion, or transfer; recruitment or recruitment advertising; layoff or termination; rates of pay or other forms of compensation; and selection for training, including apprenticeship, trainees, and/or on-the-job training.

Local agencies and their contractors must each designate an EEO officer to ensure compliance with the EEO Title VI, Section 504, and training policy.

The Washington State Department of Transportation (WSDOT) will monitor both the local agency and its contractors for compliance as part of the normal project management reviews and through contract compliance reviews of selected contracts.

The local agency, by signature to the Local Agency Agreement, agrees to the following:

1. To assist and cooperate actively with the state in obtaining contractor and subcontractor compliance with the equal opportunity clause and rules, regulations, and relevant orders of the FHWA and/or Secretary of Labor.
2. To furnish the state such information as it may require for the supervision of such compliance and otherwise assist the state in the discharge of its primary responsibility for securing compliance.
3. To refrain from entering into any contract or contract modification subject to Executive Order 11246 of September 24, 1965, as amended, with a contractor, supplier or consultant debarred from, or who has not demonstrated eligibility for, government contracts and federally-assisted construction contracts pursuant to the Executive Order and other pertinent rules, laws, and regulations.

4. To carry out such sanctions and penalties for violation of the equal opportunity clause as may be imposed upon contractors and subcontractors by the state, FHWA, or the Secretary of Labor pursuant to Part II, Subpart D of the Executive Order.

In addition, the agency agrees that if it fails or refuses to comply with these undertakings, the state may take any or all of the following actions:

- Cancel, terminate, or suspend the Local Agency Agreement in whole or in part.
- Refrain from extending any further assistance to the agency regarding the failure or refusal to comply until satisfactory assurance of future compliance has been received from the agency.
- Refer the case to the Department of Justice for appropriate legal proceedings.

The local agency must consult the WSDOT/APWA *Standard Specifications, Amendments, General Special Provisions*, and the [Construction Manual](#) M 41-01 to administer the EEO and training programs.

27.2 Training

To meet federal requirements, each contract must comply with applicable GSPs and Form FHWA-1273.

Training goals are established by the Local Programs Operations Engineer on selected federal aid construction contracts. The goals are set based on the formula developed by WSDOT, and the goal setting process takes into account the following factors:

1. The dollar amount of the project (normally Local Programs will not set goals on projects of less than \$500,000).
2. Type of work. Project must lend itself to training.
3. Availability of minorities and women for training.
4. Geographic location of the project.
5. Duration of the work (normally Local Programs will not set training goals on projects of less than 75 working days).

The training hours are established on the amount of labor, opportunity and location of each federally assisted project. The Local Programs Project Development Engineer determines the training hours for each project. The local agency must submit an engineer's estimate for the duration of the contract including estimated number of working days to the Region Local Programs Engineer as a basis for the Local Programs Project Development Engineer to set goals. (The training goals and DBE goals are established at the same time.)

27.3 Contract Administration

.31 General – The local agency has the responsibility to:

1. Conduct preconstruction conferences during which EEO and training Special Provisions for federal aid contracts are discussed with the contractor. (Emphasis should be made regarding the applicability of goal-by-craft versus average-of-all-crafts.)
2. Ensure that the contractor posts and maintains notices and posters setting forth the contractor's EEO policy. A supply of OFCCP Poster No. 1420, Equal Employment Opportunity is the Law, shall be made available to the contractor.
3. Monitor on-site compliance with the EEO and training Special Provisions of federal aid contracts.
4. Ensure that their contractors locate, qualify, and increase the skills of minority groups, women employees, and applicants for employment as specified in the training provisions.
5. Prepare and/or ensure the preparation of the required EEO and training reports.

.32 EEO Reports

1. **PR 1391** – This report is submitted by the contractor and subcontractors showing all the employees in the work force including an ethnic breakdown on their federal aid highway construction projects under construction during the month of July. The report is a summation of employees on the last payroll period in which work was performed during the month of July. The local agency retains this form in its project files.
2. **PR 1392** – Summation of the July PR 1391 reports received from all contractors and subcontractors that were working on federally-assisted projects during the month of July. This report is prepared by the local agency and sent to the Region Local Programs Engineer by August 30. The Region Local Programs Engineer will summarize agencies PR1392 into one PR1392. This summarized report is due at WSDOT Local Programs by September 10 annually.
3. **DOT Form 820-010 Monthly Employment Utilization Report** – This report includes the total work hours for each employee classification in each trade in the covered area for the monthly report period. This form will be kept in the Contractors' files and does not need to be submitted to the local agency. These forms are utilized when the annual EEO compliance reviews (see [Section 27.5](#)) of the randomly selected contractors are conducted by the WSDOT OEO office.

.33 Training Reports

1. **DOT Form 272-060 Federal Aid Highway Construction Annual Project Training Report** – This report is maintained by the local agency's Project Engineer as trainees are approved. Question 10 is to be completed from the project payroll/trainee records. DOT Form 272-060 is due in the Region Local Programs office by December 10.

2. **DOT Form 272-061 Federal Aid Highway Construction Cumulative Training Report**
– This report extracts the information taken from DOT Form 272-060. The Region Local Programs Engineer prepares this report which is due in the Headquarters by December 20.

27.4 Monitoring During Construction

.41 EEO – During the project construction, the local agency must monitor the contractor's performance to ensure compliance with its Title VI and Section 504 EEO policy. To accomplish this, the local agency must designate an EEO Officer. The EEO Officer's duties are to conduct reviews with the contractor, maintain records, reports, and required Title VI statistical data concerning the contractor's performance, and ensure that the local agency itself is in compliance with its EEO policy.

.42 Training – When training hours are assigned to the project, the local agency must verify that the trainee is on the project and is receiving beneficial training in accordance with the approved training program. When trainees are on a project, the local agency shall periodically conduct interviews with them to determine if they are receiving the training as specified in the approved training program. The "Trainee Questionnaire" form or similar forms should be used to document the employee interviews and the contractor's compliance with the training requirement.

The contractor will submit certified monthly detailed invoices showing the related weekly payroll number, name of the trainee, total hours trained under the program, previously paid hours, hours due, and the dollar amount due this estimate. These invoices must be kept with the project records and will become part of the temporary final records to be retained for three years after acceptance of the project by WSDOT and FHWA.

.43 Complaints – The local agency will send any complaints filed against contractors by trainees to the Region Local Programs Office who will forward them to Local Programs for appropriate action.

27.5 Compliance Review

In addition to the selected compliance review of local agency contracts by WSDOT External Civil Rights Branch (ECRB), the Local Programs Operations Engineer's Office will review Title VI and Section 504 EEO and training compliance during its regular project management reviews. If, upon such examination, it is determined that further review is needed, Local Programs may initiate a further investigation.

The evaluation of the local agency's and its contractor's compliance is based on the provisions included in the contract.

27.6 Forms

See [Chapter 11](#) of the *Construction Manual* M 41-01.

28.1 General Discussion

Local agencies, as recipients of Federal financial assistance, are required to comply with various nondiscrimination laws and regulations, including Title VI of the Civil Rights Act of 1964.

Title VI of the Civil Rights Act of 1964 prohibits discrimination based on race, color, and national origin in the provision of benefits and services. Additional nondiscrimination laws include the Federal-aid Highway Act of 1973, which added sex (gender) as a protected class; and Section 504 of the Rehabilitation Act and the Americans with Disabilities Act, which prohibits discrimination on the basis of disability.

The Civil Rights Restoration Act of 1987 clarified the broad institution-wide application of Title VI and other nondiscrimination statutes. The term “program or activity” means all of the operations of Federal-aid recipients, subrecipients, and contractors, whether such programs and activities are federally funded or not.

Similar to WSDOT, local agencies are expected to comply with the U.S. Department of Transportation’s (USDOT) Title VI regulations contained in 49 CFR Part 21, and the Federal Highway Administration’s (FHWA) regulations contained in 23 CFR 200. In addition, local agencies are expected to address Environmental Justice and Limited English Proficiency consistent with the guidance provided by WSDOT. If local agencies receive Federal Transit Administration (FTA) funds, they should refer to FTA’s Title VI Circular C4202.1B.

These federal regulations require WSDOT to obtain assurances from their subrecipients that they agree to maintain records and submit reports on its programs and activities; that the subrecipient will comply with Title VI, and that the assurances provide a right to enforcement. Each local agency that receives Federal funds through WSDOT is required to establish a Title VI Program to ensure that the provision of benefits and services, and transportation decision-making are conducted in a nondiscriminatory manner. This Title VI Program includes a requirement for local agencies to submit a plan specifying how it will implement their Title VI responsibilities.

Agencies serving a population of 100,000 or more are required to have a Title VI Plan. Agencies serving a population less than 100,000 may use an abbreviated Title VI Plan, a Nondiscrimination Agreement.

28.2 Title VI Plan Development

A Title VI Plan is a legal document that imposes individual legal liabilities to the signatory agency that are not transferable. Each local agency must develop a Title VI compliance document that reflects its individual transportation program structure. WSDOT will provide each local agency the technical support it needs to develop a Title VI Plan, or a Title VI Nondiscrimination Agreement, for agencies with populations of less than 100,000.

1. **Plan Scope** – The Title VI Plan describes how recipients of federal financial assistance will develop and implement their Title VI Program.
2. **Plan Format** – A specific format is not prescribed. Sample formats are contained in [Appendix 28.71](#) and [28.72](#).

[Appendix 28.71](#) has an example Title VI Plan for large agencies serving a population of 100,000 or more. Large local agencies should use this example to prepare their plan that is to contain the categories listed in item C below (Key Points to Consider in Developing Plan).

[Appendix 28.72](#) has a boilerplate for small agencies serving a population of less than 100,000 to use in developing their Abbreviated Title VI Plan/ Nondiscrimination Agreement.

If there are questions on these examples, please contact your Region Local Programs Engineer.

Larger agencies (populations greater than 100,000) having a Title VI Plan already approved for a different federally funded program, have the option to submit the existing Title VI Plan for approval or create a new one. Agencies can submit their plans through the Region Local Program Engineer for review by WSDOT's OEO. The WSDOT OEO will review the plan in accordance with Federal requirements. If necessary, supplemental information will be requested prior to approval.

3. **Key Points to Consider In Developing a Plan** – These points are incorporated in the Nondiscrimination Agreement shown in [Appendix 28.72](#) for cities under 100,000 population.
 - a. **Policy Statement** – The policy statement reflects the agency's commitment to Title VI compliance, including all related Federal laws and regulations, and is signed by the agency's Chief Executive Officer (CEO).
 - b. **Authorities** – This section cites all relevant Federal statutes, regulations, executive orders and other legislation.
 - c. **Organization and Staffing** – This section identifies the Title VI Coordinator and program area Title VI Specialists within the organization directly responsible for the management and administration of the Title VI Program. The Plan is to include an organization chart that describes the reporting relationship between the designated Title VI Specialists within each program emphasis area and the designated agency Title VI Coordinator.

- d. **Program Emphasis Areas** – This section describes the federal aid transportation program areas (i.e., Planning, Research, Design, Education and Training, Right of Way, Construction, Maintenance), the areas' legal/operational authorities, and assigns Title VI compliance monitoring responsibilities to each area.
- e. **Title VI Standard Assurances and Its Appendices (DOT 1050.2A)** – The USDOT 1050.2A Standard Title VI Assurances ([Appendix 28.77](#)) must be completed and signed by the agency's Chief Executive Officer (CEO), and made a part of the agency's Title VI Program Plan/Nondiscrimination Agreement. The Appendices associated with the USDOT Assurances must be inserted into every contract/agreement (regardless of funding source) as described in the Assurances document. For consultant contracts, see Exhibit F of [Appendix 31.79](#). The agency's CEO signs these assurances.
- f. **Complaint Procedures** – This section outlines the process for filing complaints and the investigative process. It also identifies the agency staff positions responsible for this process, and the time limits for the submission of complaints and completion of investigations (60 days per 23 CFR 200.9(b)(3)).
- g. **Table of Contents** – This section enables the reader to quickly locate particular sections of the Plan.

28.3 Reporting Requirements

Local agencies are to provide the following reports and/or data to WSDOT related to their transportation program:

Annual Title VI Update and Accomplishment Report

All agencies with approved Title VI Plans or Nondiscrimination Agreements are to annually prepare a report of their Title VI Program implementation compliance activities. This report is due one year from the date of approval of the Title VI plan and then annually on that same date. This is to describe the transportation activities and any changes that occurred during the year, as well as planned efforts (goals) for the coming year. This Annual Title VI Update and Accomplishment Report is to be completed by each agency and forwarded to the Region Local Programs Engineer, who will forward it to Local Programs for transmittal to WSDOT's OEO for review and approval. If there has been a change in the agency's CEO, an updated Assurances document is required to be submitted with the Update report.

Examples of Annual Reports are outlined in [Appendix 28.73](#) for agencies over 100,000 population and [Appendix 28.74](#) for agencies with population under 100,000.

Revisions to the Local Agency's Title VI Plan or Nondiscrimination Agreement

The Plan is to contain current information on names of staff and any other needed revisions. Agencies must submit substantial revisions to their Title VI Plan or Nondiscrimination Agreement to the Region Local Programs Engineer for transmittal to Local Programs for submittal to WSDOT's OEO as soon as they occur for review and approval. Substantial revisions may be the filing of the agency's new CEO signature, administrative changes in the agency's Title VI Program administrative structure and staffing, or changes to the plan's complaint procedures, etc.

Local agencies only need to submit a revised Title VI document when program changes such as the ones described above take place.

28.4 Title VI Complaint Investigations

The local agency is responsible for investigating all Title VI discrimination complaints occurring within the federal aid transportation program or its activities, unless the complaint filed is against the local agency. Complaints naming a local agency as a respondent shall be forwarded to the Region Local Programs Engineer, who will in turn forward it to Local Programs. WSDOT's OEO will investigate these complaints. Each local agency's Title VI Plan will have External Complaint Procedures to assist them in conducting a timely, fair and impartial investigation.

All Title VI investigations are to be completed within 60 days of acceptance of a complaint.

A Log of Complaints must be maintained by each agency, and submitted annually as part of the agency's Title VI Annual Update. The Log of Complaints must contain the following information for each complaint filed:

- The name and address of the person filing the complaint.
- The date of the complaint.
- The basis of the complaint.
- The disposition of the complaint.
- The status of the complaint.

A Log of Complaints is shown in [Appendix 28.75](#).

Only qualified, well-trained investigators should conduct these investigations. No agency is allowed to investigate a complaint against itself.

All findings from state or local investigations are preliminary and subject to the concurrence of FHWA Headquarters Civil Rights (HCR). FHWA HRC will render final decisions in all cases including those investigated by WSDOT. There are no administrative appeal forums in Title VI complaints. Once FHWA HCR issues its final agency decision (FAD), a complainant in disagreement with such determination may file an appeal with the appropriate US District Court.

28.5 Title VI Compliance Reviews

WSDOT/FHWA will conduct periodic reviews of compliance with Federal Title VI regulations as follows:

1. **Compliance Review** – The WSDOT Title VI Coordinator will notify Local Programs and work through the Region Local Programs Engineers to make arrangements to conduct periodic compliance reviews of local agencies having approved Title VI Plans/Nondiscrimination Agreements. The compliance review will focus on how effectively the local agency has implemented Title VI. Documentation is gathered and individuals with Title VI responsibilities are interviewed as part of the review process. The local agency will be notified in writing of the scheduled date and the documents that will be required for the on-site review.
2. **Local Agency Found in Compliance** – If no deficiencies are found during the on-site review, the local agency will be informed at the conclusion of the review, followed by a written notice of compliance.
3. **Local Agency Found in Noncompliance** – If deficiencies are identified during the review, the local agency will be apprised of them at the conclusion of the review, followed by written notice, and given 90 days to correct them. After an agency corrects deficiencies, it will be notified in writing that it is in compliance.

If a local agency does not correct Title VI Program deficiencies identified by WSDOT or FHWA, it may be subject to sanctions including the suspension of FHWA funding.

4. **Local Agency Responsibilities** – Local agencies administering federal aid contracts are required to conduct on-site compliance reviews of prime contractors and subcontractors. Agencies needing assistance in conducting on-site reviews should contact their Region Local Programs Engineer.

28.6 Other Nondiscrimination Statutes Related to Title VI

Limited English Proficiency – LEP (Executive Order 13166) – As noted above, one of the bases covered under Title VI is national origin. One type of national origin discrimination is discrimination based on a person's inability to speak, read, write, or understand English. The federal government and those receiving federal financial assistance (recipients, subrecipients, contractors) must take reasonable steps to ensure that LEP persons have meaningful access to the programs, services, and information those entities provide. This may require providing written and/or oral communications in a language other than English. More information regarding LEP responsibilities can be found at www.lep.gov/recipbroch.html and at www.usdoj.gov/crt/cor/lep/dotlep.htm.

Environmental Justice (Executive Order 12898) – Procedures for addressing environmental justice may be found in [Chapter 24](#) of this manual, as well as [Chapter 458](#) of the *Environmental Procedures Manual* M 31-11.

28.7 Appendices

- [28.71](#) Title VI Plan for Agencies Over 100,000 Population
- [28.72](#) Nondiscrimination Agreement Population Under 100,000
- [28.73](#) Annual Report for Agency With Population Over 100,000 – Example
- [28.74](#) NDA Annual Report Population Under 100,000 – Example
- [28.75](#) Title VI Complaint Log
- [28.76](#) Title VI Compliance Review Questionnaire for Local Agencies
- [28.77](#) USDOT Standard Title VI Assurances

Appendix 28.71 Title VI Plan for Agencies Over 100,000 Population

Title VI Plan for Agencies Over 100,000 Population

_____ Agency
Federally Funded Transportation Program
TITLE VI PLAN

_____ Agency Commissioners

_____ Agency Administrator

_____ Public Works Director

Prepared by: _____

Grants & Compliance Manager
(Title VI Coordinator)
Office of Budget and Information Services

Appendix III Lease/Deed Provisions 18

I. Policy Statement, Authorities, and Citations

- A. **Policy of Nondiscrimination** – _____
 Agency assures that no person shall on the grounds of race, color, national origin, or sex as provided by Title VI of the Civil Rights Act of 1964, and the Civil Rights Restoration Act of 1987 (P.L. 100.259) be excluded from participation in, be denied the benefits of, or be otherwise subjected to discrimination under any Agency sponsored program or activity. _____
 Agency further assures every effort will be made to ensure non-discrimination in all of its programs and activities, whether those programs and activities are federally funded or not.
- In the event _____ Agency distributes federal aid funds to another entity, _____
 Agency will include Title VI language in all written agreements and will monitor for compliance.
- Title VI compliance is a condition of receipt for federal funds. Assurance of compliance, therefore, falls under the proper authority of the Board of Agency Commissioners pursuant to its budgetary authority and responsibility. The Agency Administrator and Title VI Coordinator are authorized to ensure compliance with provisions of this policy and with the law, including the requirements of 23 Code of Federal Regulation (CFR) 200 and 49 CFR 21.

 Agency Administrator

 Date

- B. **Authorities** – Title VI of the 1964 Civil Rights Act provides that no person in the United States shall on the grounds of race, color, national origin, or sex be excluded from participation in, be denied the benefits of, or be otherwise subjected to discrimination under any program or activity receiving federal financial assistance.
- The Civil Rights Restoration Act of 1987 broadened the scope of Title VI coverage by expanding the definition of terms “programs or activities” to include all programs or activities of federal aid recipients, subrecipients, and contractors, whether such programs and activities are federally assisted or not (Public Law 100-259 [S. 557] March 22, 1988).
- C. **Additional Citations** – Title VI of the Civil Rights Act of 1964; 42 USC 2000d to 2000d-4; 42 USC 4601 to 4655; 23 USC 109(h); 23 USC 324; DOT Order 1050.2; EO 12250; EO 12898; 28 CFR 50.3

II. Organization, Staffing, and Structure

A. Organizational Chart – Reporting Relationships

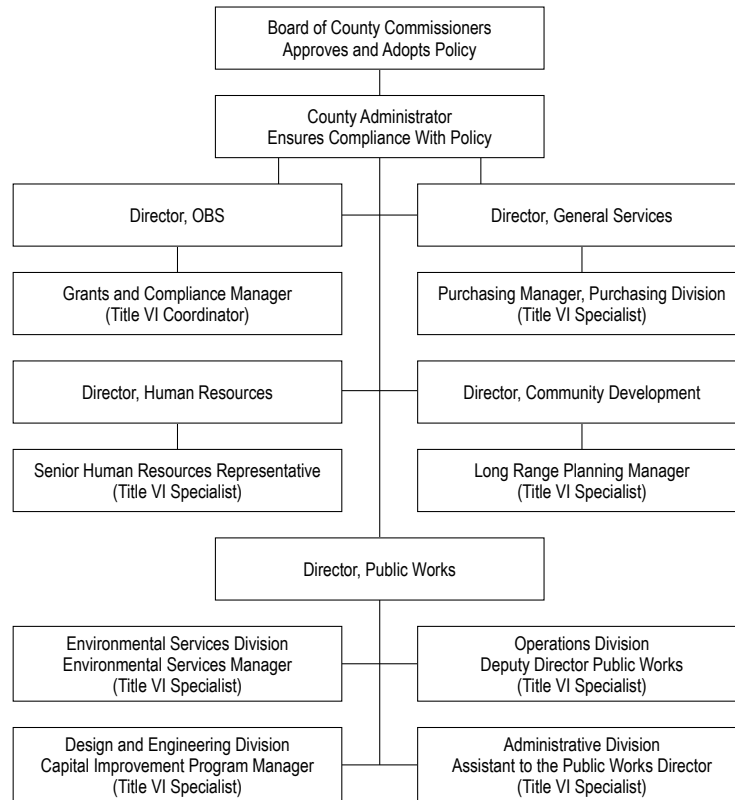

B. Staffing and Structure

Agency Administrator – The Agency Administrator is authorized to ensure compliance with provisions of the Agency’s policy of nondiscrimination and with the law, including the requirements of 23 CFR Part 200 and 49 CFR Part 21. The Agency’s grants compliance function and Title VI coordination shall be performed under the authority of the Agency Administrator.

Title VI Coordinator – _____ Agency has created a position of Grants and Compliance Manager to perform the duties of the Title VI Coordinator (Coordinator) and ensure implementation of the Agency’s Title VI Federally Funded Transportation Program. The Grants and Compliance Manager has other duties and responsibilities in addition to Title VI. Although the Grants and Compliance Manager reports to the Director of the Office of Budget and Information Services (OBIS), their direct supervisor, this position shall have an indirect reporting relationship and access to the Agency Administrator.

Title VI Specialists – Additionally, the Agency has designated Title VI Specialists (Specialists) in departmental special emphasis program areas. The Specialists, designated below, shall work in concert with the Title VI Coordinator. These key programs or department areas are subject to receiving federal assistance through grants or other types of transportation related funding, or are responsible for implementing Agency directives and policies to ensure civil rights compliance and equal opportunity. The Specialists will work with the Coordinator to ensure their respective departments and programs comply with Title VI regulations and assurances, meet the objectives of the Title VI Plan, meet federal and state reporting requirements, and provide adequate training opportunities for applicable staff.

Title VI Specialists will work with the Coordinator to ascertain Title VI compliance by contractors, subcontractors, consultants, suppliers and other subrecipients under federally funded projects or programs. Specialists will ensure applicable Title VI provisions and requirements are included in contractual agreements to prime contractors and subrecipients. Specialists will work with the Coordinator to obtain statistical data on race, color, national origin, handicap/disability, age and sex of participants in, and beneficiaries of federally funded _____ Agency transportation programs.

Each of the Specialists will maintain data relative to their respective special emphasis program area, designated below. The Coordinator shall use the data to complete annual Title VI reports and for other administrative needs.

Public Works Design and Engineering – Capital Improvement Program Manager

Environmental Services Environmental Services Manager

Operations – Deputy Director Public Works

Administration – Assistant to the Public Works Director

Community Development – Long Range Planning Manager

Human Resources – Senior Human Resources Representatives

General Services Purchasing – Purchasing Manager

III. Title VI Plan Implementation and Program Administration

Title VI Coordinator’s Responsibilities and Program Administration – As authorized by the Agency Administrator, the Title VI Coordinator is responsible for initiating, monitoring, and ensuring _____ Agency’s compliance with Title VI requirements as follows:

- A. **Program Administration** – Administer the Title VI program and coordinate implementation of the plan. Ensure compliance with the assurances, policy, and program objectives. Perform Title VI program reviews to assess administrative procedures, staffing, and resources; provide recommendations as required to the Agency Administrator and Director of OBIS.
- B. **Complaints** – Review written Title VI complaints that may be received by _____ Agency following the adopted procedural guidelines (see Section V – Complaint Procedures). Ensure every effort is made to resolve complaints informally at the local or regional level.

- C. **Data Collection** – Review the statistical data gathering process performed by Title VI Specialists periodically to ensure sufficiency of data for meeting the requirements of Title VI program administration. (See Section VII – Special Emphasis Program Areas.)
- D. **Environmental Impact Statements** – Ensure that available census data are included as a part of all Environmental Impact Statements/Assessments (EIS/EIA) conducted by Public Works (PW) for projects receiving Federal Highway Administration or other federal assistance.
- E. **Training Programs** – Conduct or facilitate training programs on Title VI issues and regulations for Agency employees; and facilitate Title VI training for appropriate staff, contractors and subrecipients. A summary of training conducted will be reported in the annual update.
- F. **Title VI Plan Update** – Review and update the _____ Agency Transportation Program, Title VI Plan as needed or required. Present updated plan to the Agency Administrator for approval; submit amended Plan to WSDOT.
- G. **Annual Accomplishment Report** – Prepare an annual report of Title VI accomplishments and changes to the program in the preceding federal fiscal year; identify goals and objectives for the upcoming year as required; and submit by October 15.
- H. **Public Dissemination** – Work with Agency staff to develop and disseminate Title VI program information to _____ Agency employees and subrecipients, including contractors, subcontractors, consultants, and subconsultants and beneficiaries, as well as the general public. Public dissemination may include postings of official statements, inclusion of Title VI language in contracts or other agreements, website postings, and annual publication of the Agency’s Title VI Policy Statement in newspaper(s) having a general circulation, and informational brochures. Ensure public service announcements or notices are posted of proposed projects, hearings, meetings, or formation of public advisory boards, in newspapers or other media reaching the affected community. Ensure the full utilization of available minority publications or media; and, where appropriate, provide written or verbal information in languages other than English.
- I. **Elimination of Discrimination** – Work with the Public Works Department, Human Resources, and other Agency offices to establish procedures for promptly resolving deficiencies, as needed. Recommend procedures to identify and eliminate discrimination that may be discovered in any Agency processes.
- J. **Maintain Legislative and Procedural Information** – Federal laws, rules, and regulations, WSDOT guidelines, the current _____ Agency Title VI Plan, Annual Accomplishment Reports, and other resource information pertaining to the implementation and administration of the Agency’s Title VI program will be maintained and updated by the Coordinator. Information will be made available to other Agency departments or the public as requested or required.

IV. NHI Education and Title VI Training

In keeping with adopted _____ Agency policy of nondiscrimination, departmental procedures will be established or followed for Public Works employees to have equal access to applicable educational and training opportunities. Public Works staff will maintain program administration documentation and data necessary for preparation of annual Title VI reports, and will routinely supply the necessary data to the Title VI Coordinator.

- A. **National Highway Institute (NHI) Education** – The Coordinator will be notified when training for the National Highway Institute courses or workshops become available to Agency Public Works employees. The Director of the Department of Public Works will establish policy for the selection of participants interested in taking part in the National Highway Institute Training workshops to ensure that no one is denied participation or subjected to discrimination on the basis of race, color, national origin or sex. A report will be completed and forwarded to the Coordinator upon completion of each educational seminar or course throughout the course of the year, which shall include the name of each participant, their title, division, sex and ethnicity for use in completing the annual Title VI accomplishment report.
- B. **Title VI Training** – The Coordinator is responsible for overall Title VI related training and staff development for Title VI Specialists and other Agency employees. The Coordinator will organize or conduct a minimum of one internal Title VI training session annually. The Coordinator will organize and facilitate the provision of Title VI training sessions for consultants, contractors, and subcontractors periodically. WSDOT’s Office of Equal Opportunity Internal and External Civil Rights Branch and the Contract Compliance Office may be asked to provide applicable training.
- C. **Selection of Instructors** – The Coordinator will collaborate with the Agency’s Purchasing Division to ensure Agency policy is followed in the selection of instructors for _____ Agency Public Works training courses/ workshops, and ensure equal opportunity in the selection process for all training contracts. Per adopted policy, the Agency will provide accessibility to Minority/Women/Disadvantage Business Enterprise consulting and training firms to compete for training contracts.

V. Complaint Procedures – Allegations of Discrimination in Federally-Assisted Programs or Activities

- A. **Overview** – These procedures cover all complaints filed under Title VI of the Civil Rights Act of 1964 as amended, Section 504 of the Rehabilitation Act of 1973, Civil Rights Restoration Act of 1987, and the Americans with Disabilities Act of 1990, relating to any program or activity administered by _____ Agency, as well as to subrecipients, consultants, and contractors. Intimidation or retaliation of any kind is prohibited by law.

The procedures do not deny the right of the complainant to file formal complaints with other state or federal agencies or to seek private counsel for complaints alleging discrimination. Every effort will be made to resolve complaints informally at the Agency and subrecipient level. The option of informal mediation meeting(s) between the affected parties and a designated mediator may be utilized for resolution.

B. Procedures

1. Any individual, group of individuals, or entity that believes they have been subjected to discrimination prohibited by nondiscrimination requirements may file a written complaint with _____ Agency Human Resources, Public Works or Board of Agency Commissioners. A formal complaint must be filed within 180 calendar days of the alleged occurrence. The Agency will not officially act or respond to complaints made verbally.
2. Upon receiving the written complaint, _____ Agency will determine its jurisdiction, acceptability, need for additional information, and the investigative merit of the complaint. In some situations, the Agency may request the Washington State Department of Transportation (WSDOT) Office of Equal Opportunity conduct the investigation. In the event WSDOT handles the investigation, they will follow their adopted procedures for investigating discrimination complaints, per their current State Title VI Plan.
3. If the complaint is against a subrecipient, consultant, or contractor, under contract with the Agency the appropriate division and/or agency shall be notified of the complaint, within 15 calendar days.
4. Once the Agency decides its course of action, the complainant and the respondent will be notified in writing of such determination within five calendar days. The complaint will be logged into the records of the Title VI Coordinator, and the basis for the allegation identified including race, color, national origin, handicap/disability, age, or sex.
5. In cases where _____ Agency assumes investigation of the complaint, the Agency will provide the respondent with the opportunity to respond to the allegations in writing. The respondent will have ten calendar days upon receipt, to furnish the Agency with his/her response to the allegations.

6. Within 60 days of receipt of the complaint, the Coordinator or WSDOT investigator will prepare a written investigative report for the Agency Engineer and Agency Administrator. The report shall include a narrative description of the incident, identification of persons interviewed, findings and recommendations for disposition.
7. The recommendation shall be reviewed by the Prosecuting Attorney's office (PA). The PA may discuss the report and recommendations with the Coordinator and other appropriate departmental staff. The report will be modified as needed and made final for its release to the parties.
8. Once the investigative report becomes final, briefings will be scheduled with each party within 15 days. Both the complainant and the respondent shall receive a copy of the investigative report during the briefings and will be notified of their respective appeal rights.
9. A copy of the complaint and _____ Agency's investigative report will be issue to WSDOT's External Civil Rights Branch (or the appropriate oversight agency) within 60 calendar days of the receipt of the complaint.
10. If the complainant or respondent is not satisfied with the results of the investigation of the alleged discriminatory practice(s) he or she shall be advised of their rights to appeal the agency's decision to WSDOT, U.S. Department of Transportation or U.S. Department of Justice. The complainant has 180 calendar days after the appropriate agency's final resolution to appeal to USDOT. Unless new facts not previously considered come to light, reconsideration of the final determination by the investigating agency will not be available.
11. An annual Log of Complaints must be maintained by each agency. The Log of Complaints must contain the following information for each complaint filed:
 - The name and address of the person filing the complaint.
 - The date of the complaint.
 - The basis of the complaint.
 - The disposition of the complaint.
 - The status of the complaint.

Only qualified, well-trained investigators should conduct these investigations. No agency is allowed to investigate a complaint against itself.

VI. Subrecipient Review and Remedial Action Procedures

- A. **Title VI Review of Subrecipients of Federal Aid Highway Funds** – Public Works Specialists and the Coordinator will assist WSDOT to periodically conduct Title VI compliance reviews. Title VI Specialists and Public Works staff will review select recipients of federal aid highway or other federal funds, to ensure adherence to Title VI requirements (see Section VII). The Coordinator and Specialists will work cooperatively to periodically confirm operational guidelines provided to consultants, contractors, and subrecipients, including Title VI language, provisions, and related requirements, as applicable.
- B. **Post-Grant Reviews** – The Coordinator will collaborate with Specialists and Public Works staff to conduct periodic post grant reviews of select recipients of federal highway funds or other federal funds, for roads, sidewalks, bridges, municipal construction, etc. to ensure adherence to Title VI requirements (see Section VII). Appropriate staff will periodically confirm that operational guidelines provided to consultants, contractors and subrecipients include Title VI language and provisions and related requirements, where applicable.
- C. **Remedial Action** – When irregularities occur in the administration of federal aid highway programs at either the Agency or subrecipient levels, corrective action will be taken to resolve identified Title VI issues.

_____ Agency will seek the cooperation of the consultant, contractor or other subrecipient in correcting deficiencies found during periodic reviews. _____ Agency will provide technical assistance and guidance, upon request, to support voluntarily compliance by the subrecipient. When conducting Title VI compliance reviews, the Agency will reduce to writing any recommended remedial action agreed upon by the Agency and subrecipient, and provide a copy of the letter within a period not to exceed 45 days.

Subrecipients placed in a deficiency status will be given a reasonable time, not to exceed 90 days after receipt of the deficiency letter, to voluntarily correct deficiencies. When a subrecipient fails or refuses to voluntarily comply with requirements within the allotted time frame,

_____ Agency will submit to WSDOT and FHWA copies of the case file and a recommendation that the subrecipient be found in noncompliance.

A follow-up review will be conducted within 180 days of the initial review to ascertain if the subrecipient has complied with the Title VI Program requirements in correcting deficiencies previously identified. If the subrecipient refuses to comply, _____ Agency and WSDOT may, with FHWA's concurrence, initiate sanctions per 49 CFR 21.

VII. Title VI Implementation Activities in Special Emphasis Program Areas

A. Planning and Location Activities

1. **Planning Process** – The Agency Engineer has responsibility for providing long-range planning (through a service agreement with Community Development), program development, and capital programming necessary to provide efficient transportation services to Agency citizens. The Agency Engineer annually updates and coordinates _____ Agency’s six-year plan for transportation improvement programs and projects. The update also informs other _____ Agency jurisdictions of the current planning direction for transportation needs. Projects included in the update are the result of evaluation and prioritization of needs in various transportation areas. The evaluation process includes input from various divisions in the department, cities, local jurisdictions and organizations, citizen groups, and private individuals. All six-year plans must be consistent with the adopted Comprehensive Plan approved under the State’s Growth Management Act.
2. **Authorities** – _____ Agency Code; 23 CFR 450; [RCW 35.77](#); [RCW 36](#); [RCW 47.06](#); [RCW 47.80](#)
3. **Public Involvement in Planning Activities and Title VI**
 - a. Invite participation of a cross section of the populace from social, economic, and ethnic groups in the planning process by disseminating written program information to minority media and ethnic organizations, and providing public service announcements for all local media, when forming citizen advisory committees or planning board, and requesting involvement.
 - b. Public Works staff will obtain demographic statistics at applicable community meetings and public hearings involving transportation planning sessions. Data will be gathered through use of a voluntary self-reporting form which includes race, gender, and national origin. Copies of the completed forms will be provided to Title VI Coordinator after each meeting.
 - c. To ensure access to public meetings, evening meetings will be conducted in a variety of community buildings throughout the Agency, including those along transit routes, ensure translation services are available if anticipated, and ensure public meetings are held in predominantly minority communities when transportation projects will specifically impact those communities.

B. Consultant Contracts Activities

1. **Consultant Contracts Administration** – The D&E Division is responsible for recommending consultant firms to the Agency Engineer for final selection, negotiation and award. The Division administers awarded consultant contracts.
2. **Authorities** – _____ Agency Ordinance 90-81; WSDOT *Local Agency Guidelines*; 48 CFR 31; 23 CFR 172
3. **Consultant Selection Process** – Public Works staff will request qualifications from consulting engineering firms specializing in various aspects of civil engineering which may relate to public works projects and the development of construction plans and special provisions for roads and bridges, design work associated with structures, performing environmental studies or preparing NEPA or SEPA documents for public works projects.

Consultant selection from the certified list maintained by the Purchasing Division adheres to Washington State regulations (RCWs) and is consistent with _____ Agency vendor policies.

4. Title VI Assurances and Provisions

- a. Include applicable Disadvantaged Business Enterprise (DBE) goals in designated projects, and seek to proactively achieve the goal(s).
- b. Include Title VI assurance and provision language in all federally funded consultant contracts. Periodically review documents and language to ensure compliance with current laws and regulations. Provide a copy of the form of the contract to the Coordinator, and any amendments or updates that may occur over time.
- c. A Public Works Specialist will maintain updated demographic data on the utilization of women-and minority-owned consulting firms. As they occur, a copy of the award letter will be provided to the Coordinator for use in preparing the Annual Update Accomplishment Report.

C. Design and Engineering/Environmental Activities

1. The Public Works Design and Engineering Division is responsible for the Capital Improvement Program (CIP) and environmental permitting for projects. Studies are performed to assess various environmental factors as they relate to the implementation of the Agency's Annual Road Program, including evaluating demographic data.
2. **Authorities** – _____ Agency Ordinance; WSDOT *Local Agency Guidelines*; *Standard Plans* WSDOT/APWA - M 21-01; Title 23, USC 109(d), 14(a), 217, 315 and 402(a); 23 CFR 1204.4; 23 CFR 771; EO 12898; 49 CFR 1.48(b)(33) and 1.48(c)(2); National Environmental Policy Act of 1969, 42 USC 4321; 40 CFR Part 1500; 49 CFR Part 622; *Environmental Procedures Manual* M 31-11; EO 12898

3. Design/Environmental Review Process and Title VI

- a. Depending on the scope, complexity, and impacts of a project, a National Environmental Policy Act (NEPA), NEPA Categorical Exclusion, NEPA Environmental Assessment, State Environmental Policy Act (SEPA) checklist, SEPA Determination of Non Significance, or NEPA and/or SEPA Environmental Impact Statement will be completed.
- b. Monitor compliance with Title VI requirements in all aspects of conducting Environmental Impact Statements or Assessments. Provide a comprehensive summary of the demographic and environmental data elements to be considered by the EIS/EIA process to the Coordinator; including updated summary lists as applicable. Incorporate into the review process, adequate.
- c. Time for the Coordinator to review and comment, as applicable, on the draft EIS/EIA to ensure there are no violations of the Federal Civil Rights Act, as amended, as a result of the agency's federal aid highway activities.
- d. In order to ensure dissemination of information and foster participation from affected populations, the Public Works staff will place public notices in applicable general and minority media; select accessible locations and times for public hearings or meetings, and arrange for translation services as needed; particularly in projects impacting predominantly minority communities. Ensure the public has information pertaining to their rights to call or write the department to view plans and discuss environmental problems.
- e. Public Works staff will obtain demographic data at community meetings and public hearings pertaining to the transportation design phase. Data will be gathered through use of a voluntary sign-up form which includes race, gender, and national origin. Copies of the voluntary self-reporting forms will be provided to the Coordinator after each meeting.
- f. Public Works staff shall provide a copy of the Annual Construction Report to the Title VI Coordinator in or around April of each year. The Coordinator shall work with the Agency GIS Department to generate a map of the federally funded transportation projects to include demographic data of the neighborhoods affected by the projects.

D. Right of Way Activities

1. **Real Property Services** – The Local Programs Right of Way section oversees the appraisal and acquisition of real property and relocation assistance services for federally funded public works projects. The right of way acquisition process entails appraisal of property, negotiation of terms and conditions for acquisition, and assistance in the relocation of displaced individuals, businesses, farm operations, nonprofit organizations, and property management. The Real Estate Services Office is located in the Development Division.
2. **Authorities** – *Right of Way Manual* M 26-01; 23 CFR 130; 49 CFR 24; RCW 8.26; RCW 47; WAC 468-100

3. Right of Way Activities and Title VI

- a. Ensure equal opportunity in all aspects of procuring real estate service contracting and appraisal agreements. Follow adopted Agency vendor procurement policies in the acquisition of contracted services.
- b. Utilize current OMWBE directories identifying fee appraiser organizations and the Washington State Department of Transportation's list of certified fee appraisers when seeking services. Maintain data on awards to minority and female appraisers, and provide data to the Title VI Coordinator on a quarterly basis.
- c. Follow the guidelines in the *Right of Way Manual* M 26-01 for property acquisition as well as applicable laws and regulations, including Title VI and Section 504.
- d. Adhere to departmental policy of apprising affected property owners, tenants, and others involved in right of way acquisition of their rights and options regarding negotiation, relocation, condemnation and other aspects of the acquisition process.
- e. Provide copies of the relocation assistance literature produced by WSDOT and a copy of the _____ Agency Title VI Compliance brochure to all affected parties.
- f. Incorporate Title VI language and assurance statements in all brochures that are provided to property owners and tenants impacted by a highway transportation project. Monitor all program functions for compliance with Title VI provisions throughout real estate acquisition process.
- g. Ensure that appraised values and communications associated with the appraisal and negotiation operations result in equitable treatment.
- h. Ensure comparable replacement dwellings are available and assistance is given to all displaced persons and entities by the property acquisition process.
- i. Maintain statistical data including race, color, national origin, and sex on all relocatees affected by federally funded projects, and provide detailed demographic data quarterly to the Title VI Coordinator.

E. Construction and Maintenance Activities

1. **Construction Management Section** – This section is located in the Design and Engineering Division, and is responsible for administration of all new construction contracts and inspecting bridges. The D&E Division is responsible for oversight and the administration of transportation construction projects, as set forth by policy decisions and supervision of the Agency Engineer.
2. **Authorities** – *Construction Manual* M 41-01; *Maintenance Manual* M 51-01; *Local Agency Guidelines* M 36-63; *Standard Specifications for Road, Bridge, and Municipal Construction* M 41-10.

3. **Maintenance** – The Operations Division is responsible for the efficient program for maintaining Agency roads, bridges, and parks/grounds by economically utilizing the resources of contractors, equipment, and materials.
4. **Authorities** – *Maintenance Manual* M 51-01; *Construction Manual* M 41-01; *Standard Specifications for Road, Bridge and Municipal Construction* M 41-10; Clark Agency Road Standards
5. **Construction and Maintenance Activities and Title VI**
 - a. Review all federally funded projects for application of DBE goals. As appropriate, include DBE provisions in those projects with designated goals. Include Title VI language in bid announcements and applicable construction documents, as stipulated in the Agency’s Title VI Policy Statement (p. 2) and Assurances (Addendum 2, p. 14-15) herein.
 - b. Award construction contracts on the basis of lowest responsive bidder, as well as meeting DBE requirements. Include Title VI language in prime contract award letters to encourage utilization of DBE subcontracts and vendors.
 - c. Ensure that prime contractors with DBE requirements award contracted work to qualified DBEs which perform commercially useful functions.
 - d. Monitor all maintenance and construction operations to ensure nondiscrimination throughout all operations.
 - e. Coordinate the gathering of maintenance and construction information regarding DBE participation for the Annual Title VI Report; and provide to the Coordinator.

Exhibit 1 – _____ Agency Title VI Notice to the Public

_____ Agency hereby gives public notice that it is the Agency's policy to assure full compliance with Title VI of the Civil Rights Act of 1964, the Civil Rights Restoration Act of 1987, and related statutes and regulations in all programs and activities. Title VI requires that no person shall, on the grounds of race, color, sex, or national origin be excluded from the participation in, be denied the benefits of, or be otherwise subjected to discrimination under any Federal Aid Highway program or other activity for which _____ Agency receives federal financial assistance.

Any person who believes they have been aggrieved by an unlawful discriminatory practice under Title VI has a right to file a formal complaint with _____ Agency. Any such complaint must be in writing and filed with the _____ Agency Title VI Coordinator within one hundred, eighty (180) days following the date of the alleged discriminatory occurrence. Title VI Discrimination Complaint Forms may be obtained from the Human Resources office at no cost to the complainant by calling xxx-xxx-xxxx.

Exhibit 2 – _____ Agency Title VI Assurances

The Agency of _____ in the State of Washington, (hereinafter referred to as the “Recipient”), HEREBY AGREES THAT as a condition to receiving any federal financial assistance from the U.S. Department of Transportation will comply with Title VI of the Civil Rights Act of 1964, 78 Stat. 252, 42 USC 2000d--42 USC 2000d--4 (hereinafter referred to as the Act), and all requirements imposed by or pursuant to Title 49, Code of Federal Regulations, Department of Transportation, Subtitle A, Office of the Secretary Part 21, Nondiscrimination in Federally-Assisted Programs of the Department of Transportation--Effectuation of Title VI of the Civil Rights Act of 1964 (hereinafter referred to as the Regulations), and other pertinent directives, to the end that in accordance with the Act, Regulations, and other pertinent directives, no person in the United States shall, on the grounds of race, color, sex, or national origin be excluded from participation in, be denied the benefits of, or be otherwise subjected to discrimination under any program or activity for which the Recipient receives federal financial assistance through the Washington State Department of Transportation, including the U.S. Department of Transportation and Federal Highway Administration, and HEREBY GIVES ASSURANCE THAT it will promptly take any measures necessary to effectuate this agreement. This Assurance is required by Subsection 21.7(a)(1) of the Regulations.

More specifically and without limiting the above general assurance, the Recipient hereby gives the following specific assurances to its Federal Aid Highway Program:

1. That the Recipient agrees that each “program” and each “facility” as defined in Subsections 21.23(e) and 21.23(b) of the Regulations, will be (with regard to a “program”) conducted, or will be (with regard to a “facility”) operated in compliance with all requirements imposed by, or pursuant to, the Regulations.
2. That the Recipient shall insert the following notification in all solicitations for bids for work or material subject to the Regulations made in connection with the Federal Aid Highway Program, and in adapted form in all proposals for negotiated agreements:

_____ Agency in accordance with Title VI of the Civil Rights Act of 1964 and 78 Stat. 252, 42 USC 2000d--4 and Title 49, Code of Federal Regulations, Department of Transportation, Subtitle A, Office of the Secretary, Part 21, Nondiscrimination in Federally-Assisted Programs of the Department of Transportation issued pursuant to such Act, hereby notifies all bidders that it will affirmatively ensure that any contract entered into pursuant to this advertisement, disadvantaged business enterprises as defined at 49 CFR Part 26 will be afforded full opportunity to submit bids in response to this invitation and will not be discriminated against on the grounds of race, color, national origin, or sex in consideration for an award.

3. That the Recipient shall insert the clauses of Appendix 1 of this Assurance in every contract subject to the Act and the Regulations.

4. That the Recipient shall insert the clauses of Appendix 2 of this Assurance, as a covenant running with the land, in any deed from the United States effecting a transfer of real property, structures, or improvements thereon, or interest therein.
5. That where the Recipient receives federal financial assistance to construct a facility, or part of a facility, the Assurance shall extend to the entire facility and facilities operated in connection therewith.
6. That where the Recipient receives federal financial assistance in the form, or for the acquisition of real property, or an interest in real property, the Assurance shall extend rights to space on, over or under such property.
7. That the Recipient shall include the appropriate clauses set forth in Appendix 3 of this Assurance, as a covenant running with the land, in any future deeds, leases, permits, licenses, and similar agreements entered into by the Recipient with other parties: (a) for the subsequent transfer of real property acquired or improved under the Federal Aid Highway Program; and (b) for the construction or use of or access to space on, over or under real property acquired, or improved under the Federal Aid Highway Program.
8. That this Assurance obligates the Recipient for the period during which federal financial assistance is extended to the program, or is in the form of, personal property, or real property or interest therein or structures or improvements thereon, in which case the Assurance obligates the Recipient or any transferee for the longer of the following periods: (a) the period during which the property is used for a purpose for which the federal financial assistance is extended, or for another purpose involving the provision of similar services or benefits; or (b) the period during which the Recipient retains ownership or possession of the property.
9. The Recipient shall provide for such methods of administration for the program as are found by the Secretary of Transportation, or the official to whom s/he delegates specific authority to give reasonable guarantee that it, other recipients, subgrantees, contractors, subcontractors, transferees, successors in interest, and other participants of federal financial assistance under such program will comply with all requirements imposed or pursuant to the Act, the Regulations, and this Assurance.
10. The Recipient agrees that the United States has a right to seek judicial endorsement with regard to any matter arising under the Act, the Regulations, and this Assurance.

THIS ASSURANCE is given in consideration of and for the purpose of obtaining any and all federal grants, loans, contracts, property, discounts or other federal financial assistance extended after the date hereof to the Recipient by the U.S. Department of Transportation under the Federal Aid Highway Program and is binding on it, other recipients, subgrantees, contractors, subcontractors, transferees, successors in interest and other participants in the Federal Aid Highway Program. The person whose signature appears below is authorized to sign this Assurance on behalf of the Recipient.

**Exhibit 2A – _____, _____
Agency Administrator Date**

**1 – Title VI Assurances For Consultants, Contractors, Subcontractors, Suppliers,
and Manufacturers**

_____ Agency will insert or add the following clauses into every contract subject to the Act and Regulations associated with the receipt of federal financial assistance:

During the performance of this contract, the contractor, for itself, its assignees and successors in interest (hereinafter referred to as the “contractor”) agrees as follows:

1. **Compliance With Regulations** – The contractor shall comply with the Regulations Relative to Nondiscrimination in Federally-Assisted Programs of the Department of Transportation (hereinafter DOT), Title 49, Code of Federal Regulations, Part 21, as they may be amended from time to time, (hereinafter referred to as the Regulations), which are herein incorporated by reference and made a part of this contract.
2. **Nondiscrimination** – The contractor, with regard to the work performed during the contract, shall not discriminate on the grounds of race, color, sex, or national origin in the selection and retention of subcontractors, including procurement of materials and leases of equipment. The contractor shall not participate either directly or indirectly in the discrimination prohibited by Section 21.5 of the Regulations, including employment practices when the contract covers a program set forth in Appendix B of the Regulations.
3. **Solicitations for Subcontracts, including Procurement of Materials and Equipment** – In all solicitations either by competitive bidding or negotiations made by the contractor for work to be performed under a subcontract, including procurement of materials or leases of equipment, each potential subcontractor or supplier shall be notified by the contractor of the contractor’s obligations under this contract and the Regulations relative to nondiscrimination on the ground of race, color, sex, or national origin.
4. **Information and Reports** – The contractor shall provide all information and reports required by the Regulations or directives issued pursuant thereto, and shall permit access to its books, records, accounts, other sources of information, and its facilities as may be determined by _____ Agency or the Washington State Department of Transportation to be pertinent to ascertain compliance with such Regulations, orders and instructions. Where any information required of a contractor is in the exclusive possession of another who fails or refuses to furnish this information, the contractor shall so certify to _____ Agency, or the Washington State Department of Transportation as appropriate, and shall set forth what efforts it has made to obtain the information.

5. **Sanctions for Noncompliance** – In the event of the contractor’s noncompliance with the nondiscrimination provisions of this contract, _____ Agency and the Washington State Department of Transportation shall impose such contract sanctions as it, or the Federal Highway Administration may determine to be appropriate, including, but not limited to:
- a. Withholding of payments to the contractor under the contract until the contractor complies, and/or;
 - b. Cancellation, termination, or suspension of the contract, in whole or in part.
6. **Incorporation of Provisions** – The contractor shall include the provisions of paragraphs (1) through (6) in every subcontract, including procurement of materials and leases of equipment, unless exempt by the Regulations, or directives issued pursuant thereto. The contractor shall take such action with respect to any subcontractor or procurement as _____ Agency or the U.S. Department of Transportation, Federal Highway Administration, may direct as a means of enforcing such provisions including sanctions for noncompliance.
- Provided, however, that in the event a contractor becomes involved in, or is threatened with, litigation with a subcontractor or supplier as a result of such direction, the contractor may request _____ Agency enter into such litigation to protect the interests of the Agency and, in addition, the contractor may request the United States to enter into such litigation to protect the interests of the United States.

Exhibit 2B – Granting and Habendum Clauses

When _____ Agency is the recipient of real property, structures or improvements thereon, or interest therein from the United States, the following clauses shall be included in any and all deeds affecting or recording the transfer of property:

GRANTING CLAUSE

NOW, THEREFORE, _____ Agency, as authorized by law, will accept title to the lands and maintain the project constructed thereon, in accordance with Title 23, United States Code, the Regulations for the Administration of Federal Aid for Highways and the policies and procedures prescribed by the Federal Highway Administration of the Department of Transportation and, also in accordance with and in compliance with all requirements imposed by or pursuant to Title 49, Code of Federal Regulations, Department of Transportation, Subtitle A, Office of the Secretary, Part 21, Non-Discrimination in Federally-Assisted Programs of the Department of Transportation (hereinafter referred to as the Regulations) pertaining to and effectuating the provisions of Title VI of the Civil Rights Act of 1964 (78 Stat. 252:42 USC 2000d to 2000d--4) does hereby remise, release, quitclaim, and convey unto _____ Agency all the right, title, and interest of the Department of Transportation in and to said land described in Exhibit A attached hereto and made a part thereof.

HABENDUM CLAUSE

TO HAVE AND TO HOLD said lands and interests therein unto _____ Agency, and its successors forever, subject, however, to the covenants, conditions, restrictions and reservations herein contained as follows, which will remain in effect for the period during which the real property or structures are used for a purpose for which the federal financial assistance is extended or for another purpose involving the provision of similar services or benefits and shall be binding on _____ Agency, its successors, and assigns.

_____ Agency, in consideration of the conveyance of said lands and interests in lands, does hereby covenant and agree as a covenant running with the land for itself, its successors and assigns, that (1) no person shall on the grounds of race, color, sex, or national origin be excluded from participation in, be denied the benefits of, or be otherwise subjected to discrimination with regard to any facility located wholly or in part on, over, or under such lands hereby conveyed (,) and¹ (2) that _____ Agency, shall use the lands and interests in lands so conveyed, in compliance with all requirements imposed by or pursuant to Title 49, Code of Federal Regulations, Department of Transportation, Subtitle A, Office of the Secretary, Part 21, Non-Discrimination of Federally-Assisted Programs of the Department of Transportation--Effectuation of Title VI of the Civil Rights Act of 1964, and as said Regulations may be amended (,) and (3) that in the event of breach of any of the above mentioned nondiscrimination conditions, the Agency shall have a right to reenter said lands and facilities on said land, and the above described land and facilities shall thereon revert to and vest in and become the absolute property of the Department of Transportation and its assigns as such interest existed prior to this instruction.

¹ Reverter Clause and related language to be used only when it is determined that such a clause is necessary in order to effectuate the purposes of Title VI of Civil Rights Act of 1964.

Exhibit 2C – Lease/Deed Provisions

Upon receipt of federal financial assistance to construct a facility or part of a facility, the Recipient agrees to include these clauses in all future deeds, licenses, leases, permits, or similar instruments entered into by _____ Agency pursuant to the provisions of Title VI Assurances, item 7:

The LESSEE, for himself or herself, his or her heirs, personal representatives, successors in interest, and assigns, as a part of the consideration hereof, does hereby covenant and agree as a covenant running with the land that in the event facilities are constructed, maintained, or otherwise operated on the said property described in this lease, for a purpose for which a US Department of Transportation program or activity is extended or for another purpose involving the provision of similar services or benefits, the LESSEE shall maintain and operate such facilities and services in compliance with all other requirements imposed pursuant to Title 49, Code of Federal Regulations, U.S. Department of Transportation, Subtitle A, Office of the Secretary, Part 21, Non-Discrimination in Federally-Assisted Programs of the U.S. Department of Transportation--Effectuation of Title VI of the Civil Rights Act of 1964, as said Regulations may be amended.

That in the event of breach of any of the above nondiscrimination covenants, the Agency shall have the right to terminate the lease, and to reenter and repossess said land and the facilities thereon, and hold the same as if said lease had never been made or issued.

The following shall be included in all deeds, licenses, leases, permits, or similar agreements entered into by _____ Agency pursuant to the provisions of Title VI Assurances, Item 7.

The LESSEE, for himself or herself, his or her personal representatives, successors in interest, and assigns, as a part of the consideration hereof, does hereby covenant and agree as a covenant running with the land that (1) no person, on the grounds of race, color, sex, or national origin shall be excluded from participation in, be denied the benefits of, or be otherwise subjected to discrimination in the use of said facilities, (2) that in the construction of any improvements on, over or under such land and furnishing of services thereon, no person on the grounds of race, color, sex, or national origin shall be excluded from participation in, denied the benefits of, or otherwise be subjected to discrimination, (3) that the LESSEE shall use the premises in compliance with all requirements imposed by or pursuant to Title 49, Code of Federal Regulations, U.S. Department of Transportation, Subtitle A, Office of the Secretary, Part 21, Non-Discrimination in Federally-Assisted Programs of the U.S. Department of Transportation--Effectuation of Title VI of the Civil Rights Act of 1964, and as said Regulations may be amended.

That in the event of breach of any of the above nondiscrimination covenants, the Agency shall have the right to terminate the lease, and to re-enter and repossess said land and the facilities thereon, and hold the same as if said lease had never been made or issued.

Nondiscrimination Agreement Population Under 100,000

**Washington State Department of Transportation
and Name of Recipient Policy Statement**

The (Name of Recipient), hereinafter referred to as the “Recipient” assures that no person shall on the grounds of race, color, national origin, or sex, as provided by Title VI of the Civil Rights Act of 1964, and the Civil Rights Restoration Act of 1987 (P.L. 100.259) be excluded from participation in, be denied the benefits of, or be otherwise subjected to discrimination under any program or activity. The Recipient further assures every effort will be made to ensure nondiscrimination in all of its programs and activities, whether those programs and activities are federally funded or not.

The Civil Rights Restoration Act of 1987, broadened the scope of Title VI coverage by expanding the definition of terms “programs or activities” to include all programs or activities of federal aid recipients, sub-recipients, and contractors/consultants, whether such programs and activities are federally assisted or not (Public Law 100259 [S.557] March 22, 1988).

In the event the Recipient distributes federal aid funds to a sub-recipient, the Recipient will include Title VI language in all written agreements and will monitor for compliance.

The Recipient’s (Name of person/division), is responsible for initiating and monitoring Title VI activities, preparing reports and other responsibilities as required by 23 Code of Federal Regulation(CFR) 200 and 49 Code of Federal Regulation 21.

Signature

Title

Date

**Title VI Program
Organization and Staffing**

Pursuant to 23 CFR 200, (Name of Recipient) has designated a Title VI Coordinator who is responsible for Attachment 1, which describes the hierarchy for (Name of Recipient)’s Title VI Program, including an organization’s chart illustrating the level and placement of Title VI responsibilities.

Assurances**49 CFR Part 21.7**

The (Name of the Recipient), hereby gives assurances:

1. That no person shall on the grounds of race, color, national origin, and sex, be excluded from participation in, be denied the benefits of, or be otherwise subjected to discrimination under any program or activity conducted by the recipient regardless of whether those programs and activities are federally funded or not. Activities and programs which the recipient hereby agrees to carry out in compliance with Title VI and related statutes include but are not limited to:
 - List all major Transportation programs and activities of the recipient and Title VI responsibilities for each one of them. Include information as Attachment 2 to this Nondiscrimination Agreement.
2. That it will promptly take any measures necessary to effectuate this agreement.
3. That each Transportation program, activity, and facility (i.e., lands change to roadways, park and ride lots, etc.) as defined at 49 CFR 21.23(b) and (e), and the Civil Rights Restoration Act of 1987 will be (with regard to a program or activity) conducted, or will be (with regard to a facility) operated in compliance with the nondiscriminatory requirements imposed by, or pursuant to, this agreement.
4. That these assurances are given in consideration of and for the purpose of obtaining any and all federal grants, loans, contracts, property, discounts or other federal financial assistance extended after the date hereof to the recipient by the Washington State Department of Transportation (WSDOT) under the federally-funded program and is binding on it, other recipients, subgrantees, contractors, sub-contractors, transferees, successors in interest and other participants. The person or persons whose signatures appear below are authorized to sign these assurances on behalf of the Recipient.
5. That the Recipient shall insert the following notification in all solicitations for bids for work or material subject to the Regulations and made in connection with all federally-funded programs and, in all proposals for negotiated agreements.

The Recipient, in accordance with Title VI of the Civil Rights Act of 1964, 78 Stat. 252, 42 U.S.C. 2000d to 2000d-4 and Title 49, Code of Federal Regulations, Department of Transportation, Subtitle A, Office of the Secretary, Part 21, Nondiscrimination in Federally-Assisted Programs of the Department of Transportation issued pursuant to such Act, hereby notifies all bidders that it will affirmatively ensure that in any contract entered into pursuant to this advertisement, disadvantaged business enterprises as defined at 49 CFR Part 26 will be afforded full opportunity to submit bids in response to this invitation and will not be discriminated against on the grounds of race, color, national origin, or sex in consideration for an award.

6. That the Recipient shall insert the clauses of Appendix 1 of this Agreement in every contract subject to the Act and the Regulations.
7. That the Recipient shall insert the clauses of Appendix 2 of this Agreement, as a covenant running with the land, in any deed from the United States effecting a transfer of real property, structures, or improvements thereon, or interest therein.
8. That the Recipient shall include the appropriate clauses set forth in Appendix 3 of this Agreement, as a covenant running with the land, in any future deeds, leases, permits, licenses, and similar agreements entered into by the Recipient with other parties: (a) for the subsequent transfer of real property acquired or improved under a federal aid program; and (b) for the construction or use of or access to space on, over or under real property acquired, or improved under a federal aid program.
9. The Recipient agrees that the United States has a right to seek judicial enforcement with regard to any matter arising under the Act, the Regulations, and this agreement.

Implementation Procedures

This agreement shall serve as the recipient's Title VI plan pursuant to 23 CFR 200 and 49 CFR 21.

For the purpose of this agreement, "Federal Assistance" shall include:

1. Grants and loans of federal funds.
2. The grant or donation of federal property and interest in property.
3. The detail of federal personnel.
4. The sale and lease of, and the permission to use (on other than a casual or transient basis), Federal property or any interest in such property without consideration or at a nominal consideration, or at a consideration which is reduced for the purpose of assisting the recipient, or in recognition of the public interest to be served by such sale or lease to the recipient.
5. Any federal agreement, arrangement, or other contract which has as one of its purposes, the provision of assistance.

The recipient shall:

1. Issue a policy statement, signed by the head of the recipient, which expresses its commitment to the nondiscrimination provisions of Title VI. The policy statement shall be circulated throughout the recipient's organization and to the general public. Such information shall be published where appropriate in languages other than English.
2. Take affirmative action to correct any deficiencies found by WSDOT or the United States Department of Transportation (USDOT) within a reasonable time period, not to exceed 90 days, in order to implement Title VI compliance in accordance with this agreement. The head of the recipient shall be held responsible for implementing Title VI requirements.

3. Designate a civil rights coordinator who has a responsible position in the organization and easy access to the head of the recipient. The civil rights coordinator shall be responsible for initiating and monitoring Title VI activities and preparing required reports.
4. The civil rights coordinator shall adequately implement the civil rights requirements.
5. Process complaints of discrimination consistent with the provisions contained in this agreement. Investigations shall be conducted by civil rights personnel trained in discrimination complaint investigation. Identify each complainant by race, color, national origin or sex, the nature of the complaint, the date the complaint was filed, the date the investigation was completed, the disposition, the date of the disposition, and other pertinent information. A copy of the complaint, together with a copy of the recipient's report of investigation, will be forwarded to WSDOT's Office of Equal Opportunity (OEO) within 10 days of the date the complaint was received by the recipient.
6. Collect statistical data (race, color, national origin, sex) of participants in, and beneficiaries of the Transportation programs and activities conducted by the recipient.
7. Conduct Title VI reviews of the recipient and sub-recipient contractor/consultant program areas and activities. Revise where applicable, policies, procedures and directives to include Title VI requirements.
8. Attend training programs on Title VI and related statutes conducted by WSDOT OEO.
9. Prepare a yearly report of Title VI accomplishments for the last year and goals for the next year. This report is due one year from the date of approval of the Nondiscrimination Agreement and then annually on the same date.
 - a. Annual Work Plan – Outline Title VI monitoring and review activities planned for the coming year; state by which each activity will be accomplished and target date for completion.
 - b. Accomplishment Report – List major accomplishments made regarding Title VI activities. Include instances where Title VI issues were identified and discrimination was prevented. Indicate activities and efforts the Title VI Coordinator and program area personnel have undertaken in monitoring Title VI. Include a description of the scope and conclusions of any special reviews (internal or external) conducted by the Title VI Coordinator. List any major problem(s) identified and corrective action taken. Include a summary and status report on any Title VI complaints filed with the recipient.

Discrimination Complaint Procedure

1. Any person who believes that he or she, individually, as a member of any specific class, or in connection with any disadvantaged business enterprise, has been subjected to discrimination prohibited by Title VI of the Civil Rights Act of 1964, the American with Disabilities Act of 1990, Section 504 of the Vocational Rehabilitation Act of 1973 and the Civil Rights Restoration Act of 1987, as amended, may file a complaint with the recipient. A complaint may also be filed by a representative on behalf of such a person. All complaints will be referred to the recipient's Title VI Coordinator for review and action.
2. In order to have the complaint consideration under this procedure, the complainant must file the complaint no later than 180 days after:
 - a. The date of alleged act of discrimination; or
 - b. Where there has been a continuing course of conduct, the date on which that conduct was discontinued.

In either case, the recipient or his/her designee may extend the time for filing or waive the time limit in the interest of justice, specifying in writing the reason for so doing.
3. Complaints shall be in writing and shall be signed by the complainant and/or the complainant's representative. Complaints shall set forth as fully as possible the facts and circumstances surrounding the claimed discrimination. In the event that a person makes a verbal complaint of discrimination to an officer or employee of the recipient, the person shall be interviewed by the Title VI Coordinator. If necessary, the Title VI Coordinator will assist the person in reducing the complaint to writing and submit the written version of the complaint to the person for signature. The complaint shall then be handled according to the recipient's investigative procedures.
4. Within 10 days, the Title VI Coordinator will acknowledge receipt of the allegation, inform the complainant of action taken or proposed action to process the allegation, and advise the complainant of other avenues of redress available, such as WSDOT and USDOT.
5. The recipient will advise WSDOT within 10 days of receipt of the allegations. Generally, the following information will be included in every notification to WSDOT:
 - a. Name, address, and phone number of the complainant.
 - b. Name(s) and address(es) of alleged discriminating official(s).
 - c. Basis of complaint (i.e., race, color, national origin, or sex)
 - d. Date of alleged discriminatory act(s).
 - e. Date of complaint received by the recipient.
 - f. A statement of the complaint.
 - g. Other agencies (state, local, or federal) where the complaint has been filed.
 - h. An explanation of the actions the recipient has taken or proposed to resolve the issue raised in the complaint.

6. Within 60 days, the Title VI Coordinator will conduct an investigation of the allegation and based on the information obtained, will render a recommendation for action in a report of findings to the head of the recipient. The complaint should be resolved by informal means whenever possible. Such informal attempts and their results will be summarized in the report of findings.
7. Within 90 days of receipt of the complaint, the head of the recipient will notify the complainant in writing of the final decision reached, including the proposed disposition of the matter. The notification will advise the complainant of his/her appeal rights with WSDOT, or USDOT, if they are dissatisfied with the final decision rendered by the Recipient. The Title VI Coordinator will also provide WSDOT with a copy of this decision and summary of findings upon completion of the investigation.
8. Contacts for the different Title VI administrative jurisdictions are as follows:
 - Washington State Department of Transportation
Office of Equal Opportunity, Title VI Program
PO Box 47314
Olympia, WA 98466
360-705-7098
 - Federal Highway Administration
Washington Division Office
711 Capitol Way South, Suite 501
Olympia, WA 98501
360-534-9325

Sanctions

In the event the recipient fails or refuses to comply with the terms of this agreement, WSDOT may take any or all of the following actions:

1. Cancel, terminate, or suspend this agreement in whole or in part;
2. Refrain from extending any further assistance to the recipient under the program from which the failure or refusal occurred until satisfactory assurance of future compliance has been received from the recipient.
3. Take such other action that may be deemed appropriate under the circumstances, until compliance or remedial action has been accomplished by the recipient.
4. Refer the case to the Department of Justice for appropriate legal proceedings.

**WASHINGTON STATE
DEPARTMENT OF TRANSPORTATION:**

Signature

Director of the Office of Equal Opportunity
Title

Date

NAME OF RECIPIENT:

Signature

Title

Date

Appendix 1

During the performance of this contract, the contractor/consultant, for itself, its assignees and successors in interest (hereinafter referred to as the “contractor”) agrees as follows:

1. **Compliance With Regulations** – The contractor shall comply with the Regulations relative to nondiscrimination in federally-assisted programs of United States Department of Transportation (USDOT), Title 49, Code of Federal Regulations, Part 21, as they may be amended from time to time, (hereinafter referred to as the Regulations), which are herein incorporated by reference and made a part of this contract.
2. **Nondiscrimination** – The contractor, with regard to the work performed by it during the contract, shall not discriminate on the grounds of race, color, sex, or national origin in the selection and retention of sub-contractors, including procurement of materials and leases of equipment. The contractor shall not participate either directly or indirectly in the discrimination prohibited by Section 21.5 of the Regulations, including employment practices when the contract covers a program set forth in Appendix B of the Regulations.
3. **Solicitations for Subcontracts, Including Procurement of Materials and Equipment** – In all solicitations either by competitive bidding or negotiations made by the contractor for work to be performed under a sub-contract, including procurement of materials or leases of equipment, each potential sub-contractor or supplier shall be notified by the contractor of the contractor’s obligations under this contract and the Regulations relative to nondiscrimination on the grounds of race, color, sex, or national origin.
4. **Information and Reports** – The contractor shall provide all information and reports required by the Regulations or directives issued pursuant thereto, and shall permit access to its books, records, accounts, other sources of information, and its facilities as may be determined by the contracting agency or the appropriate federal agency to be pertinent to ascertain compliance with such Regulations, orders and instructions. Where any information required of a contractor is in the exclusive possession of another who fails or refuses to furnish this information, the contractor shall so certify to WSDOT or the USDOT as appropriate, and shall set forth what efforts it has made to obtain the information.
5. **Sanctions for Noncompliance** – In the event of the contractor’s noncompliance with the nondiscrimination provisions of this contract, the contracting agency shall impose such contract sanctions as it or the USDOT may determine to be appropriate, including, but not limited to:
 - Withholding of payments to the contractor under the contract until the contractor complies, and/or;
 - Cancellation, termination, or suspension of the contract, in whole or in part

6. **Incorporation of Provisions** – The contractor shall include the provisions of paragraphs (1) through (5) in every subcontract, including procurement of materials and leases of equipment, unless exempt by the Regulations, or directives issued pursuant thereto. The contractor shall take such action with respect to any sub-contractor or procurement as the contracting agency or USDOT may direct as a means of enforcing such provisions including sanctions for noncompliance.

Provided, however, that in the event a contractor becomes involved in, or is threatened with, litigation with a sub-contractor or supplier as a result of such direction, the contractor may request WSDOT enter into such litigation to protect the interests of the state and, in addition, the contractor may request the USDOT enter into such litigation to protect the interests of the United States.

Appendix 2

The following clauses shall be included in any and all deeds affecting or recording the transfer of real property, structures or improvements thereon, or interest therein from the United States.

GRANTING CLAUSE

NOW THEREFORE, Department of Transportation, as authorized by law, and upon the condition that the state of Washington will accept title to the lands and maintain the project constructed thereon, in accordance with Title 23, United States Code, the Regulations for the Administration of Federal Aid for Highways and the policies and procedures prescribed by the United States Department of Transportation and, also in accordance with and in compliance with all requirements imposed by or pursuant to Title 49, Code of Federal Regulations, Department of Transportation, Subtitle A, the Department of Transportation WSDOT (hereinafter referred to as the Regulations) pertaining to and effectuating the provisions of Title VI of the Civil Rights Act of 1964 (78 Stat. 252: 42 USC 2000d to 2000d - 4) does hereby remise, release, quitclaim, and convey unto the state of Washington all the right, title, and interest of the Department of Transportation in and to said land described in Exhibit A attached hereto and made a part thereof.

HABENDUM CLAUSE

TO HAVE AND TO HOLD said lands and interests therein unto the state of Washington, and its successors forever, subject, however, to the covenants, conditions, restrictions and reservations herein contained as follows, which will remain in effect for the period during which the real property or structures are used for a purpose for which the federal financial assistance is extended or for another purpose involving the provisions of similar services or benefits and shall be binding on the state of Washington, its successors, and assigns.

The state of Washington, in consideration of the conveyance of said lands and interests in lands, does hereby covenant and agree as a covenant running with the land for itself, its successors and assigns, that (1) no person shall on the grounds of race, color, sex or national origin, be excluded from participation in, be denied the benefits of, or be otherwise subject to discrimination with regard to any facility located wholly or in part on, over, or under such lands hereby conveyed (,)and)* (2) that the state of Washington, shall use the lands and interests in lands so conveyed, in compliance with all requirements imposed by or pursuant to Title 49, Code of Federal Regulations, Department of Transportation, Subtitle A, Office of the Secretary, Part 21, Non-Discrimination of Federally-Assisted Programs of the Department of Transportation -- Effectuation of Title VI of the Civil Rights Act of 1964, and as said Regulations may be amended (,) and (3) that in the event of breach of any of the above mentioned nondiscrimination conditions, the department shall have a right to reenter said lands and facilities on said land, and the above described land and facilities shall thereon revert to and vest in and become the absolute property of the Department of Transportation and its assigns as such interest existed prior to this instruction.

Appendix 3

The following clauses shall be included in all transportation related deeds, licenses, leases, permits, or similar instruments entered into by (Recipient) pursuant to the provisions of Assurance 8.

The LESSEE, for himself or herself, his or her heirs, personal representatives, successors in interest, and assigns, as a part of the consideration hereof, does hereby covenant and agree as a covenant running with the land that in the event facilities are constructed, maintained, or otherwise operated on the said property described in this lease, for a purpose of which a Department of Transportation program or activity is extended or for another purpose involving the provision of similar services or benefits, the LESSEE shall maintain and operate such facilities and services in compliance with all other requirements imposed pursuant to Title 49, Code of Federal Regulations, Department of Transportation, Subtitle A, Office of the Secretary, Part 21,

Nondiscrimination in Federally-Assisted Programs of the Department of Transportation--Effectuation of Title VI of the Civil Rights Act of 1964, as said Regulations may be amended.

That in the event of breach of any of the above nondiscrimination covenants, the STATE shall have the right to terminate the lease, and to reenter and repossess said land and the facilities thereon, and hold the same as if said lease has never been made or issued.

The following shall be included in all deeds, licenses, leases, permits, or similar agreements entered into by the Washington State Department of Transportation pursuant to the provisions of Assurance 8.

The LESSEE, or himself or herself, his or her personal representatives, successors in interest, and assigns, as a part of the consideration hereof, does hereby covenant and agree as a covenant running with the land that (1) no person, on the grounds of race, color, sex, or national origin, shall be excluded from participation in, be denied the benefits of, or be otherwise subjected to discrimination in the use of said facilities, (2) that in the construction of any improvements on, over or under such land and furnishing of services thereon, no person on the grounds of race, color, sex, and national origin shall be excluded from participation in, denied the benefits of, or otherwise be subjected to discrimination, (3) that the LESSEE shall use the premises in compliance with all requirements imposed by or pursuant to Title 49, Code of Federal Regulations, Department of Transportation, Subtitle A, Office of the Secretary, Part 21, Nondiscrimination in Federally-Assisted Programs of the Department of Transportation--Effectuation of Title VI of the Civil Rights Act of 1964, and as said Regulations may be amended.

That in the event of breach of any of the above nondiscrimination covenants, the STATE shall have the right to terminate the lease, and to reenter and repossess said land and the facilities thereon, and hold the same as if said lease had never been made or issued.

¹ Reverter Clause and related language to be used only when it is determined that such a clause is necessary in order to effectuate the purpose of Title VI of the Civil Rights Act of 1964.

Annual Report for Agency With Population Over 100,000 – Example

Section I Policy Statement

A copy of Title VI Policy Statement is attached in Appendix of this report.

Section II Organization, Staffing, and Structure

A. Organization

Outline your organization and how it works with your Title VI Policy.

B. Staffing

Describe your agency staff and how they interact in the program.

C. Structure

Describe the Structure of your program, the following is an example only. Your agency may have a different approach.

Table II.C.1 shows Title VI Special Emphasis Program Area Liaisons within XYZ Agency. For this update, program area elements include planning, location, design, environmental services, real estate services (right of way), construction, and education and training. The program area liaisons work directly with the Title VI Specialist in the Office of the Title VI Coordinator. All liaison positions have been filled at this time.

Table II.C.1 – Title VI Special Emphasis Program Area Liaisons			
Name	Gender/ Ethnicity	Title	Program
John Smith	Male/Caucasian (example only)	Managing Engineer	Engineering/Planning/Design and Construction
Mary Ramirez	Female/Hispanic (example)	Project/Program Manager III	Education/Training for Construction
		Program Analyst IV	Education/Training for Administration
		Program Analyst IV	Education/Training for Maintenance
		Project/Program Manager III	Education/Training for Construction
		Program Analyst IV	Education/Training for Administration

Section III Title VI Monitoring and Review Process

A. Actions to Promote Internal and External Compliance With Title VI

List actions, meetings, scheduled events, etc., that help your agency promote both internal and external compliance with Title VI program.

Internal – In detail explain your agency’s activities and interaction within your organization in this area.

External – Detailed explanation of your agency’s activities outside the agency that promote your Title VI program.

B. Title VI Compliance Reviews During This Report Period

- List and bullet reviews conducted during the past year, name the reviewers and dates of the reviews.

Section IV Title VI Complaints During This Report Period

Either: “Received no complaints against the (Agency Name and Division) in the fiscal year 2003-2004.”

OR something like: “The two complaints alleged one incident of denial of bus services by the (Agency Name and Division). The complaints alleged discrimination based on race. (Agency Name) resolved these cases.”

Section V Accomplishment Report for Each Program Area

The following information describes the location of the major program functions within (Your Agency Name) and identifies accomplishments, applicable operational guidelines, process, and responsibilities of the various sections.

Appendix _____ lists staff summarized by gender and race for the following Special Emphasis areas: Planning, Design, Construction, Maintenance Services, and Environmental.

A. Planning

Example – The Road Services Division is responsible for developing short and long-range plans that provide efficient transportation services to the citizens of (Agency Name).

Division staff coordinates with other government agencies, private groups, and the public to develop comprehensive plans that meet the transportation needs of (Agency Name). The Division provides staff and technical assistance to regional transportation groups and serves as liaison for planning with the Puget Sound Regional Council.

A.1 Number of Consultant Projects for Planning Awarded During This Reporting Period and Dollar Value – No consultant contracts for planning were awarded during FY 2004.

A.2 Efforts Made to Utilize Minority and Female Consultants and Subconsultants in Federally-Assisted Contracts – It is the policy of (Agency Name) to comply with 49 Code of Federal Regulations, Part 26, to ensure that Disadvantaged Businesses, including minorities and women, have an equal opportunity to receive and participate in federally-assisted contracts. (Agency) does not exclude any person from participation in, deny any person the benefits of, or otherwise discriminate in connection with the award or performance of any contract covered by 49 CFR Part 26 on the basis of race, color, sex, or national origin. Efforts made to use minority and female consultants during FY 2004 include the following outreach activities:

- **Disadvantaged Business Enterprise (DBE) Goals** – As part of (Agency Name) outreach efforts to use minority and female consultants, when appropriate, proposals include a Disadvantaged Business Enterprise (DBE) goal. Certified DBE firms can encompass small, minority and women-owned firms. As a condition of award, the successful bidder must make good faith efforts to meet this DBE goal. The proposer establishes good faith efforts when it documents that it has obtained enough DBE participation to meet the DBE goal; or documents that it has made adequate efforts to do so although unsuccessful.
- **Consultants Selection Procedures** – Consultants are selected according to the procedures outlined in the RCW, and *Local Agency Guidelines* procedures for federally-assisted projects. (Agency Name) encourages all consultant firms that are registered in Washington State to conduct business and who possess the requisite professional license(s) to present their qualifications for highway design projects.

The (Agency Name) solicits firms for inclusion on the Architecture and Engineering, Professional Services, and the Construction Small Works Rosters in accordance with RCW 39.80 and (Agency Name) practices. (Agency Name) places an advertisement in various news media to include the (Names of Publications) and various minority newspapers that have existing contracts with the Agency. Advertisement is conducted a least twice during a year to encourage consultant firms to apply for placement on the rosters.

- **Public Pre-Proposal Meetings** – Other outreach efforts to support the use of minority and female consultants include conducting public pre-proposal meetings to provide information concerning the scope of work and available subcontracting opportunities associated with projects. These meetings are open to all interested parties.

A.3 Studies Conducted Which Provide Data Relative to Minority Persons, Neighborhoods, Income Levels, Physical Environments, and Travel Habits – The agency will continue to review all proposed projects for their potential to have a disproportionate impact on low-income and minority populations that are subject to additional consideration in accordance with applicable Title VI and Environmental Justice provisions. (Agency Name) unincorporated areas do not typically require substantial analysis to determine that the potentially affected areas do not meet thresholds for consideration as low-income or minority communities. However, (Specific Project name if applicable), does require such analysis.

A.4 Hearings Held During the Report Period and Efforts Utilized to Ensure Citizen Participation, Particularly Minorities, and Women – The Number of These Individuals and the Capacity of Their Participation – No hearings were conducted in FFY 2004. There were seven community advisory group meetings and one other public meeting conducted.

(Agency Name) continues to use the Washington State Department of Transportation (WSDOT) form for collecting data on public hearing and public meeting attendees for Title VI reporting requirements, per Title 23, Code of Federal Regulations, Part 200.9(b)(4). See Appendix for a copy of the form used by (Agency Name) at its public meetings. Appendix summarizes the forms collected during FFY 2004.

B. Location

(Agency Name) emphasis over the past several years has been the improvement of existing Rights of Way and corridors. There has been no activity in the (Agency Name)'s Location Program. When future corridors are considered, the Location Program will be one of the tools used by the (Agency Name) to help determine their feasibility.

B.1 Number of Complaints Filed – None during this report period.

B.2 Identification of Titles, Ethnicity, and Gender of Employees in the Location Program – Not applicable this reporting period. Agency Name currently has no staff assigned to location duties since there has been no activity in that area.

B.3 Number of Environmental Impact Statements Reviewed During the Report Period, Including a Summary of Comments on EIS Where Minority, Handicapped, Elderly, Etc., Communities Were Adversely Impacted – None during this report period.

B.4 Number of Consultants Contracts Involving Project Development Activities – None during this report period.

B.5 Number of Public Hearings Held During the Report Period Concerning Location of a Project, Including How the Hearings Were Advertised and Notification to Minorities – None during this report period.

B.6 Encouragement of Minority Leaders to Provide Suggestions and Ask Questions on Location of Highways – Not applicable during this report period. No new highways were located during this report period.

B.7 Need to Use Bilingual Advertisements, Announcements, Notices, Etc., During the Report Period – None during this report period.

C. Design

Design activities are performed by (fill in appropriate information about your design process.

C.1 Number of Consulting Firms With Design Contracts, Including the Number of These Contracts Held by Minority Firms and Women-Owned Firms/Dollar Value – For FFY 2004, 23 consulting firms were engaged in design contracts. For reporting purposes, work order and task order contracts that have multiple awards are considered contracts awarded. The accompanying tables summarize the number of contracts awarded, including work order and task order contracts, and the sum of those contract awards by prime and subconsultant.

Table V.C.1 provides the number of contracts and total dollar value awarded to minority firms and women-owned firms as prime consultants with design contracts.

Table V.C.1 – Design Contracts-Prime				
Name of Firm	Certification Status	Ethnicity	# Contracts Awarded (includes work and task orders)	Sum of Contract Awards (rounded to nearest thousand)

Table V.C.2 contains information on the number of minority firms and women-owned firms who currently have subcontracts, their certification status, ethnicity, and sum of contract awarded dollar value.

Table V.C.2 – Minority, Women-Owned Firms With Consultant Subcontracts				
Name of Firm	Certification Status	Ethnicity	# Contracts Awarded (includes work and task orders)	Sum of Contract Awards (rounded to nearest thousand)

--	--	--	--	--

C.2 Efforts to Increase Minority and Female Participation in Obtaining Consultant Contracts

- **Procurement Information System** – (Agency Name) requests Letters of Interest, Statement of Qualifications and Proposals from all firms qualified and interested in providing professional services for contracts awarded by the (Agency Name). (Agency Name) posts information on current Requests for Proposals on its Internet Website. Proposals identify the types of sub consulting opportunities that may be available on the project for informational purposes.
- **Advertisement in Local Papers and Agency Procurement Website** – (Agency Name) advertises Requests for Proposals for consulting services in local papers and on its Procurement Website. The scope, size and duration of these contracts vary in size to promote diversity in the number and size of firms competing for these awards. Some contracts are for complete design services on a single project. Others may be for environmental reviews, traffic analysis, mediators or a wide range of professional services. (Agency Name) solicits some small A&E contracts (under \$150K) from Consultants using its A&E Roster.
- **Advance Information on Upcoming Contract Opportunities** – During Federal Fiscal Year 2004, (Agency Name) efforts to use minority and female consultants included providing advance information on upcoming contract opportunities to DBE’s to include small, minority and women-owned businesses.
Describe Agency involvement in this area.
- **Newsletter Distribution** – Describe activities that may pertain to this type of information.
- **Grassroots Level Outreach Efforts** – Describe any activities that your agency has conducted in this arena.
- **Office of Business Relations and Economic Development** – Describe any activity this type of division may undertake in your community.
- **Collaboration With Other Local Governments** – Description of activity.

C.3 Public Hearings Held During the Design Phase of Any Highway – Description of any activity in this area.

C.4 Employees in the Design Program Area, including Ethnicity and Sex, Including Efforts to Increase Minority and Female Representation Where (low, high?) – See Appendix for information on employees.

During this report period, recruitment staff in the Design area actively participated in the following job fairs and forums: List participation if relevant.

C.5 Complaints Filed in the Design Program Area – None during this report period.

C.6 Significant Problem Areas, Accomplishments, and Actions to Take During the Ensuing Year – No significant problem areas were identified during this report period.

D. Environmental Unit

The Environmental Unit of the (Agency Name) works to ensure the promotion of environmental integrity in the design, construction, and maintenance of transportation systems that serve the needs of the Agency’s various communities. This section responds to the requirements of the

National Environmental Policy Act (NEPA) and the State Environmental Policy Act (SEPA) to ensure that projects undertaken by (Agency Name) meet these provisions, as required by Washington State and the Federal Government.

During FFY 2004, the (Agency Name, Division, Section) conducted () NEPA and () SEPA environmental reviews. The completed environmental reviews did not identify impacts to minority or economically disadvantaged communities. During FYE 2003 staff from (Agency Name) and WSDOT completed the technical studies pertaining to socio-economic impacts and Title VI/Environmental Justice considerations. The results from those studies have been incorporated into the draft review versions of the Draft EIS. Those initial drafts have been revised to clarify Title VI/Environmental Justice information and address specific comments from WSDOT. Following its approval by WSDOT and FHWA, (Agency Name) anticipates issuing the Draft EIS in 2005.

See Appendix for the list of names for each project that was subject to an environmental review during FY 2004. A copy of the SEPA exemption determination and determination of nonsignificance is included for each project.

E. Real Estate Services (Right of Way)

Describe your Agency Real Estate Services Responsibility in the Title VI Plan.

The property acquisition process follows the *Right of Way Manual* M 26-01 and all applicable laws and regulations, including Title VI and Section 504. The acquisition process includes appraisal of property, negotiation of terms and conditions for acquisition, and relocation assistance, as well as property management.

E.1 Civil Rights Complaints in the following Real Estate Services (Right of Way) Areas

- E.1.a. **Appraisals** – None during this report period.
- E.1.b. **Negotiations** – None during this report period.
- E.1.c. **Relocation Assistance and Payments** – None during this report period.
- E.1.d. **Property Management** – None during this report period.

E.2 Number of Appraisers Utilized During the Reporting Period – During FFY 2004, four appraisers were utilized, two females, two males and no minorities. The appraisers are (Firm Name or Agency Name) employees. Decisions to obtain new appraisers are based on need and vacancies. There are no vacancies at this time. There were no contracts for appraisers during this reporting period.

E.3 Number of Negotiations During the Report Period and Disparity in Contract Negotiations Between Minorities and Non-Minorities – There were negotiations during this report period. No disparity in contract negotiations was noted.

E.4 Concerns Raised by Minorities or Women Regarding Their Options in the Negotiation Phase – None during this report period.

E.5 Number of Relocations During the Report Period – There were no relocations during FFY 2004.

E.6 Concerns Raised by Minorities or Women on Replacement Housing, Referral Housing, and Advisory Services – None.

E.7 Opportunities for Minorities and Women to Obtain Contracts Awarded for Providing Relocation Assistance – In-house relocation assistance services are conducted according to the rules guidelines of the federal Uniform Relocation Act (CFR24), RCW 8.26, and the WSDOT

relocation manual and LAG agreement. Staff attend project open houses to present relocation services and benefits, and later meet individually with affected relocatees to negotiate and finalize benefit awards.

F. Construction and Maintenance Services

The Construction Services Group provides guidance and oversight for the administration of transportation construction projects. The (Agency Name) Road Maintenance Operations Section is responsible for the preservation and upkeep of roads and bridges.

F.1 Civil Right Complaints Involving Competitive Bidding Procedures – There were no complaints involving competitive bidding procedures during the reporting period.

F.2 Summary of Efforts Made by the Title VI Coordinator to Encourage the Use of Minority Individuals, Firms, or Agencies to Obtain Maintenance Agreements or Contracts – Summarize your Agency’s effort in this area.

F.3 Procedures Reviewed to Assure Subcontract Agreements, First and Second Tier, Material Supply and Equipment Lease Agreements During the Report Period – Description of your Agency procedures.

F.4 Significant Accomplishments and/or Action Items for the Ensuing Year – Continue monitoring disadvantaged, minority, women, and small business participation in (Agency Name) Road construction contracting.

G. Education and Training

G.1 During the Reporting Period, Efforts Made to Encourage Participation by Minorities and Women in the NHI’s Educational Program – Description of this activity, if applicable

G.2 Types of NHI Sponsored Programs and Number of (Agency Name) Participants, Including Minorities and Women – Description of activity in this area by your Agency.

G.3 Identify Staff Responsible for Training by Job Title, Ethnicity, and Gender – Staff within (Agency Name) Office of Civil Rights (Agency Name) provides guidance to departments on their responsibilities and reporting requirements for Title VI.

Table V.G.1 shows staff responsible for Title VI training to departments by job title, ethnicity, and gender.

Table V.G.1 – Title VI Training Staff Within the Office of the Title VI Coordinator			
Name	Job Title	Ethnicity	Gender
	Title VI Coordinator	Caucasian	Female
	Civil Rights Specialist	African-American	Male

G.4 Civil Rights Complaints Filed Concerning Training and Educational Opportunities and any Corrective Actions Taken – No complaints were filed during this reporting period.

H. Administration

H.1 List of Employees by Ethnicity and Gender in Each of the Title VI Program Areas – Please refer Appendix for a summarization of the ethnicity and gender of employees in the respective program areas.

H.2 Summarize All Activities Undertaken During the Reporting Period Which Provide for

Assurances of Title VI Compliance With Contractors, and by Contractors (i.e., are Title VI compliance included in all contracts and consultant agreements; were reviews made to ensure contractors and consultants are adhering to Title VI requirements; are contractors and/or consultants appraised of Title VI implications and issues) – The following is a summary of activities undertaken during the reporting period that provide for assurances of Title VI compliance with contractors, and by contractors.

- **Title VI Training**
- **Dissemination of (Agency Name) Title VI Policy Statement** – (Agency Name) Title VI Policy Statement is included in a post award packet of informational materials that the Agency Name sends to prime contractors. The post award packet includes information on the (Agency Name) reporting requirements and is sent to all prime contractors for each contract that has been publicly bid and advertised.
- **Title VI Provisions in All (Agency Name) Federally Funded Contracts** – All federally funded contracts administered by (Agency Name) contain Title VI provisions (FHWA form 1273).
- **Analysis Worksheet Reviews for All Advertised Construction Bids and Proposals** – SAMPLE: “Contract Compliance Specialists located in the Business Development and Contract Compliance Office receive and review Subcontracting/Apprenticeship Availability Analysis Worksheets for projects advertised for construction bids. The worksheet identifies the specific scopes of work, if any, which may be available for performance by subcontractors. Specifications (FHWA form 1273) defining Title VI requirements are included in the contract documents with a requirement that these provisions be included in all amendments, supplements and lower tier contracts entered into by the contractor. (Contract documents also include GSP 01-07.11 language relating to the Requirements for Nondiscrimination.) Goals are established for the participation of Disadvantaged Business Enterprises, where applicable.”
- **Public Pre-Proposal Meetings** – No public pre-proposal meetings were held during this reporting period.
- **Inclusion of Goals on Federally-Assisted Contracts** – Staff in the (Section of your Agency) review federally-assisted contracts for DBE goals.
- **Nondiscrimination Provisions in Contracts** – All (Agency Name) contracts, including federally-assisted contracts, contain nondiscrimination provisions to ensure and heighten awareness that (Agency Name) will not tolerate discriminatory practices.

H.3 Title VI Training During the Period – Table V.H.3 lists the FFY 2004 Title VI training/meetings and attendees.

Table V. H.3 – Title VI Trainings/Meetings		
Date	Type of Training	Audience

Appendix A

Form – Title VI Compliance Statement for use in public meetings/hearings Voluntary Title VI Public Involvement

Title VI of the Civil Rights Act of 1964 requires (Agency Name) to gather statistical data on participants and beneficiaries of the agency’s federal aid highway programs and activities. (Agency Name) collects information on race, color, national origin and gender of the attendees to this public meeting to ensure the inclusion of all segments of the population affected by a proposed project.

(Agency Name) wishes to clarify that this information gathering process is completely voluntary and that you are not required to disclose the statistical data requested in order to participate in this meeting. This form is a public document.

The completed forms will be held on file in (Agency Name) Department of Transportation. For further information regarding this process, please contact the Title VI Coordinator by phone at _____ or email at _____.

Please respond to the following questions:

Project Name	Date
Meeting Location	

Name (please print)	Gender <input type="checkbox"/> Male <input type="checkbox"/> Female
General ethnic identification categories (check one): <input type="checkbox"/> Caucasian <input type="checkbox"/> Hispanic American <input type="checkbox"/> American Indian/Alaskan Native <input type="checkbox"/> African American <input type="checkbox"/> Asian/Pacific Islander <input type="checkbox"/> Other _____	
Color	National Origin

After you complete this form, please fold it and place it inside the designated box on the registration table.

Thank you for your cooperation!

Appendix B

The following table summarizes staff gender and race by the respective program areas.

DOT 140-561
10/2015

Page 9 of 17

Special Emphasis Area	Race	Gender	
		Female	Male
Design	Asian	15	17
	Black	3	1
	Caucasian	13	42
	Filipino	1	2
	Hispanic	2	2
	Other	1	
	Design Total		35
Environmental Services Unit	Black	2	
	Caucasian	9	5
	Hispanic		1
Environmental Services Unit Total		11	6
Planning	Asian	2	5
	Black		1
	Caucasian	6	10
Planning Total		8	16
Construction and Maintenance Services	Asian	2	6
	Black		2
	Caucasian	6	12
Construction and Maintenance Services Total		8	20
Grand Total		62	106

Appendix C

State Environmental Project Assessments (Sepa) Exemption Determinations and Determinations of Nonsignificance

Project Number	Project Name	NEPA/SEPA Type*
		SCE
		SCE
		SCE/NCE
		SCE/NCE
		SCE
		SCE
		SCE
		SCE
		SCE
		SCE
		SCE
		SCE
		SCE
		SCE
		SCE
		SCE/NCE
		ECL/NCE
		SCE
		SCE/NCE
		SCE
		SCE

*Type: NCE=NEPA Categorical Exclusion; EA=Environmental Assessment; NEIS=NEPA Environmental Impact Statement; SCE=SEPA Categorical Exemption; ECL=Environmental Checklist; SEIS=SEPA Environmental Impact Statement

Appendix D

(Agency Name) Title VI Implementation Plan Revised September 2004

1. **Internal Dissemination Goal** – To complete internal dissemination of (Agency Name)'s revised Title VI Plan and FFY 2004 Title VI Update Report before December 1, 2004.

 (Agency Name)'s Title VI Coordinator has distributed copies of its original Title VI Plan and assurances to Agency departments, (Agency Name) Council, (Agency Name) Civil Rights Commission, Department of Transportation Division Managers and the Office of the Prosecuting Attorney. Such distribution occurred on or before December 2000. The updated Plan dated September 2002 was disseminated in December 2002. The Plan as revised in 2004, along with the FFY 2004 Title VI Update Report will be circulated by December 1, 2004.

 The Title VI Specialist and Special Emphasis Area Liaisons (as defined in the plan) received copies of the original plan and will receive copies of the updates promptly for incorporation into operational manuals, guidelines, and procedures.
2. **External Dissemination Goal** – Public notification of (Agency Name)'s Title VI Plan will be on going.
 - A. (Agency Name) will publicize (Agency Name)'s policy statement, as included in the Title VI Plan, in local minority and community-based newspapers. The (Agency Name)'s Title VI Plan will be made available to the public upon request. Additionally, the (Agency Name) Title VI Policy Statement and Complaint procedure may be found on the internet at .
 - B. The (Agency Name) will continue to distribute copies of the Title VI Plan to contractor organizations upon request. Additionally, the (Agency Name) will make copies of the plan available to all prime contractors, subcontractors, consultants and suppliers currently participating on (Agency Name) public works projects receiving federal financial aid upon request. The (Agency Name) will also make copies available to other firms providing goods and services to (Agency Name) upon their request.
 - C. The (Agency Name) will include the appropriate Title VI nondiscrimination language and any implementing requirements FHWA may issue in all solicitations for competitive bidding or negotiated procurements with federal aid for construction, professional services and purchase of materials or equipment.
3. **Training Goal** – To ensure that (Agency Name) employees involved in the project management and the contracting practice are knowledgeable on potential Title VI issues (ongoing).
 - A. Title VI Specialists and Liaisons are strongly encouraged to participate in training programs and workshops offered through Washington State Department of Transportation and others. Additionally, the Title VI Coordinator, in communicating with the Title VI Liaisons and Specialists, informs (Agency Name) employees of any new training opportunities upon notification from other external agencies.
 - B. Additionally, Staff in conjunction with staff in the (Agency Name) Department of Transportation, Road Division, will continue to develop new training for (Agency Name) staff.

C. The (Agency Name)'s Title VI Coordinator shall oversee training to include staff involved in (Agency Name)'s contracting processes. The Title VI Specialist will conduct the training. Training will occur throughout the year and will be specific to the Road Services and Contracting Divisions of (Agency Name) initially. This training will include information on:

- The role of _____ as the Title VI Coordinating agency.
- Technical Assistance on Title VI matters.
- Title VI reviews of program areas.
- Procedures for the prompt processing of complaints of discrimination.
- The necessity of updating the Title VI Plan to reflect organizational policy or implementation changes.

The (Agency Name)'s Title VI Coordinator will request Department Directors and Managers to inform employees of new training opportunities upon notification from the Coordinator's office. Such opportunities may include courses offered by WSDOT, as well as from other outside agencies.

D. The (Agency Name) will provide a training schedule to the Washington State Department of Transportation's Office of Equal Opportunity Title VI Coordinator.

E. The (Agency Name)'s Title VI Coordinator shall maintain information gathered from training records for inclusion in annual report updates.

4. **Information Collection for Annual Updates Goal** – To establish and implement processes and procedures for collection of information required for inclusion in annual update report.

A. The Title VI Specialist and Liaisons will assist the Title VI Coordinator in gathering and maintaining information on specific program areas and affected (Agency Name) departments.

B. (Agency Name) will work with Liaisons and a designated Data Coordinator to collect and report on the information required by WSDOT for the Title VI Annual Update.

C. Information for reports will be obtained from sources such as on-site compliance reviews (internal and external), checklists, review guides, questionnaires, public meeting sign in sheets, personnel inventory and employment utilization forms and inquires from the public. The Office of the Title VI Coordinator will compile this information for inclusion in the annual update reports as required.

5. **Complaint Resolution Goal** – To ensure that complaints are resolved in a professional and timely manner.

The (Agency Name)'s Title VI Coordinator will investigate all complaints of Title VI violations as appropriate. The (Agency Name) will use procedures outlined in the Title VI Plan to investigate such complaints. The objective of the investigation will be to determine whether prohibited discrimination has occurred or could occur, and to take steps to remedy the situation. To accomplish this, the Title VI Coordinator shall coordinate the following:

- A. Identification of the basis for the complaint.
- B. Identification of sources of information.
- C. Fact finding interviews with aggrieved persons, witnesses and the alleged violator.

- D. Development of a statement of finding-of-facts and information relevant to the issue/basis for the complaint.
 - E. Informal dispute resolution.
 - F. Report of findings in a manner that includes a conclusion and determination of future actions to take.
 - G. Provision for possible appeal of the decision to the FHWA. The (Agency Name)'s Title VI Coordinator will consult with WSDOT before commencing investigations to determine which agency should properly investigate.
6. **Annual Title VI Update Report Goal** – To provide detailed information on activities performed in implementing (Agency Name)'s Title VI Plan and to document accomplishments.

The Annual Title VI Update Report will include detailed information regarding the implementation activities related to (Agency Name)'s Title VI Plan and the (Agency Name)'s accomplishments. Specific areas that will be covered in the Annual Report include, but may not be limited to the following:

- A. Organization and Staff Profile
- B. Title VI Monitoring and Review Process
- C. Complaints and Investigations
- D. Special Emphasis Program Area Activities and Accomplishments
- E. Title VI Administration
- F. Training
- H. Accomplishments Report for Current Year

Appendix E

(Agency Name) Title VI Policy Statement

(Agency Name) assures that no person shall on the grounds of race, color, national origin, or sex, as provided by Title VI of the Civil Rights Act of 1964 and as amended, and the Civil Rights Restoration Act of 1987 (P.I. 100.259) be excluded from participation in, be denied the benefits of, or be otherwise subjected to discrimination under any program or activity receiving Federal financial assistance from the Washington State Department of Transportation.

(Agency Name) further assures every effort will be made to ensure nondiscrimination in all of its programs and activities, whether those programs or activities are federally funded or not.

In the event (Agency Name) distributes federal aid funds to another governmental entity or other sub-recipient, (Agency Name) will include Title VI language in all written agreements and will monitor for compliance.

(Agency Name)'s Office of the Title VI Coordinator is responsible for initiating and monitoring Title VI activities, preparing required reports and other (Agency Name) responsibilities as required by 23 CFR 200 and 49 CFR 21.

(Agency Name) Executive

Date

Appendix F

Title VI Forms

(Agency Name) provides Title VI forms to participants at public meetings (see Appendix A). In 2004 two forms were completed and turned in by participants.

Title VI Public Involvement forms were made available at the (fill in appropriate information).

Title VI Public Involvement forms were made available at the Sth Park Bridge EIS Community Advisory Group meetings on April 6, April 20, and May 4, 2004 at the Concord Elementary School Library, 723 S. Concord Street in Seattle, but no forms were submitted.

Title VI Public Involvement forms were made available at the (Fill in the Name) on (Fill in the Date) at (Fill in location), but no forms were submitted. (OR: Two forms were submitted according to actual circumstance.)

Title VI Public Involvement forms were made available at the (Fill in the Name) on (Fill in the Date) at (Fill in location), but no forms were submitted. (OR: Two forms were submitted according to actual circumstance.)

Title VI Public Involvement forms were made available at the (Fill in the Name) on (Fill in the Date) at (Fill in location), but no forms were submitted. (OR: Two forms were submitted according to actual circumstance.)

These forms are kept on file in the (Section of your Agency) and in the Office of the Title VI Coordinator.

Appendix G

Sample Organizational Chart

DOT 140-561
10/2015

Page 17 of 17

Appendix 28.74 NDA Annual Report Population Under 100,000 – Example

1. Report any changes in the organizational structure since the last reporting period.
Example: New Title VI Coordinator, new planning or public works directors, etc.
 - Report should identify the changes in the racial/gender composition of those persons involved in the transportation decision making, including planning and advisory staff.
 - If no changes have been made, please indicate that accordingly.
2. Using the most current data available (through Census or Washington State Office of Financial Management), describe the demographics within your jurisdiction.
 - a. Describe any required Title VI activities and/or studies conducted that provided data relative to minority persons, neighborhoods, income levels, physical environment, and travel habits.
 - b. How was the information utilized or Title VI provisions and needs applied in each study or activity?
3. List any Public outreach activities during the reporting period such as:
Public announcements and/or communications for meetings, hearings, project notices. Include the following:
 - a. How were special language needs assessed? List the special language needs assessments conducted.
 - b. What outreach efforts did you utilize to ensure that minority, women, low-income, and LEP population groups were provided equal opportunity to participate in those outreach activities. (Examples: Provided materials in other languages, met with local social services agencies, advertised in a minority publications.)
 - c. List the special language services provided. Note the professional language service provided including the name of the service, date provided, number of persons served, and any other relevant information.
 - d. List any costs incurred for translations and interpreters for each activity.

4. List all the transportation related contracts (federal and others) that were executed during the reporting period. (Please include construction, consultant agreements for planning, design, engineering, environmental, research, maintenance, etc.)
 - Include dollar value of each.
 - Other than advertising in your local legal publication, what outreach was made to the DMWBE firms that a contracting opportunity existed within your agency?
 - Identify the DMWBE contracts that were awarded and their dollar amount.
 - Is there a Title VI Nondiscrimination statement included in all contracts and public notices?
 - How did your organization ensure that minority, women and disadvantaged firms were provided equal opportunity to participate in the contracting arena?
5. Summarize any transportation projects that identify potential impacts to minority and/or low-income Environmental Justice (EJ) populations, i.e., impacts such as displacements, increased noise, bisecting neighborhoods. Note the following:
 - How impacts were minimized/mitigated.
 - Also include a statement, if applicable, on projects that specifically benefit community cohesion such as: adding sidewalks, improving access to properties that improve access for EJ populations.
6. If ROW has been acquired for a transportation project, please describe:
 - Identify the number of minority, low-income, elderly and disabled persons affected.
 - The efforts that were made to address Limited English Proficiency issues (including use and cost of translators, outreach efforts for each reported activity).
 - Describe any concerns raised by minorities and women regarding appraisals, negotiations, relocation assistance and payments. What actions were taken to resolve those issues?
7. List and describe any Title VI related complaints, as a result of transportation activities and projects. Include:

What was the allegation or concern?

 - Procedures used.
 - Action taken.
 - Resolution.

Appendix 28.75 Title VI Complaint Log



**Washington State
Department of Transportation**

Title VI Complaint Log

Case Number	Complainant/ Address	Filing Date	Basis	Status	Disposition

Compliance Review Questionnaire for Local Agencies

Local Agency: [Click here to enter text.](#)

Date: [Click here to enter text.](#)

Name/Title: [Click here to enter text.](#)

1. Administration

a. Staff Composition and Program Administration

- i. Provide breakdown of your administrative staff by race, color, national origin, sex, and their positions.
[Click here to enter text.](#)
- ii. How many federally funded projects have you managed during the last two years? Dollar amount?
[Click here to enter text.](#)
- iii. Have you designated an EEO Officer or Title VI Coordinator? Provide name and time in the position.
[Click here to enter text.](#)
- iv. Do you have a Title VI Policy, Assurances and Plan in place? Provide proof of public dissemination of your Title VI policy.
[Click here to enter text.](#)

b. Complaint Procedure

- i. Do you have a Title VI complaint procedure for external discrimination complaints?
If so, please provide a copy. To what extent is the community aware of it?
[Click here to enter text.](#)
- ii. Have you received any Title VI related complaints during the past two years? If so, how many? What were the outcomes? Where there any Title VI complaint lodged by beneficiaries or participants? If so, explain the issues involved.
[Click here to enter text.](#)
- iii. Do you have a Title VI Notice to Public? If so, please provide copy.
[Click here to enter text.](#)

c. Training

- i. Has your staff received any training (formal or informal) regarding Title VI?
[Click here to enter text.](#)
- ii. Are you considering scheduling Title VI training sometime soon? If so, when and who will present it?
[Click here to enter text.](#)

2. Planning Activities

a. Public Involvement

- i. Are minority members of the community invited to participate in public hearings?
[Click here to enter text.](#)
- ii. How do you go about doing that?
[Click here to enter text.](#)

- iii. Were accessible location, adequate time, and translation services considered or provided during the coordination of hearings?
[Click here to enter text.](#)
- iv. Is the Hearing Coordinator keeping records in attendance? Is the information broken down by race, color, national origin, and sex (by visual identification)?
[Click here to enter text.](#)
- v. Have planning manuals, directives, guidelines, and policies been reviewed for Title VI compliance purposes?
[Click here to enter text.](#)

3. Consultant Contracts Activities

- a. Are Title VI assurances and provisions included on consultant contracts?
[Click here to enter text.](#)
- b. Are DBE goals being included and met for consultant contracts? If not, what provisions have been taken to meet them?
[Click here to enter text.](#)
- c. Have directives, operational procedures, guidelines, and policies been reviewed for Title VI compliance purposes?
[Click here to enter text.](#)

4. Design/Environmental Activities

- a. Are minority members of the community invited to participate in public hearings?
[Click here to enter text.](#)
- b. How do you go about doing that?
[Click here to enter text.](#)
- c. Are accessibility of locations, adequate time, and translation services considered during the coordination of hearings? Was any other effort made to promote maximum attendance by those affected by the project, including member of minority communities?
[Click here to enter text.](#)
- d. Is the Hearing Coordinator keeping records in attendance? Is the information broken down by race, color, national origin, sex, (by visual identification)?
[Click here to enter text.](#)
- e. Have location and design manuals, directives, operational procedures, -guidelines, and policies been reviewed for Title VI compliance purposes?
[Click here to enter text.](#)
- f. Is statistical data being collected on race, color, national origin, and sex on communities affected by a construction project?
[Click here to enter text.](#)

5. Right of Way Activities

- a. Are DBE goals for real estate appraisers being met? If not, what provisions have been taken to help reach these goals?

[Click here to enter text.](#)

- b. Is Title VI language being incorporated in all acquisition, negotiation, property management communications, and contracts?

[Click here to enter text.](#)

- c. Are Title VI language and assurance statements being included in all surveys for property owners and tenants after the conclusion of all business?

[Click here to enter text.](#)

- d. Are all values and communications associated with appraisals conducted in an equitable fashion?

[Click here to enter text.](#)

- e. Do deeds, permits, and leases contain Title VI compliance clauses?

[Click here to enter text.](#)

- f. Is statistical data being gathered on race, color, national origin, and sex for all relocates?

[Click here to enter text.](#)

g. Construction and Maintenance Activities

- a. Have contractor selection procedures been reviewed to determine uniformity in their application to minority and nonminority contractors?

[Click here to enter text.](#)

- b. Are minority contractors and subcontractors being informed about contracting opportunities with your organization?

[Click here to enter text.](#)

- c. Are construction rules and regulations being applied in an equitable fashion?

[Click here to enter text.](#)

- d. Have you received any complaints within the last two years?

[Click here to enter text.](#)

- e. Are Title VI assurances being included in all contracts, subcontracts, and material supply agreements?

[Click here to enter text.](#)



U.S. Department of Transportation
Office of the Secretary of Transportation

DOT 1050.2A

SUBJECT: DOT STANDARD TITLE VI ASSURANCES AND NON-DISCRIMINATION PROVISIONS

1. **PURPOSE.** This order updates DOT 1050.2, Standard DOT Title VI Assurances.
2. **SCOPE.** This order applies to the Office of the Secretary and the operating administrations with regard to any program for which Federal financial assistance is authorized under a law administered by the U.S. Department of Transportation.
3. **BACKGROUND.** Section 21.7(a) of Title 49, Code of Federal Regulations, Department of Transportation, Subtitle A, Office of the Secretary, Part 21, Nondiscrimination in Federally-Assisted Programs of the Department of Transportation – Effectuation of Title VI of the Civil Rights Act of 1964, requires that all applications for Federal financial assistance from the Department of Transportation must contain Title VI Assurances. This order requires the Office of the Secretary and each operating administration to secure from applicants and recipients receiving Federal financial assistance the attached Standard DOT Title VI Assurances. The reverter clause in Appendices B and C of the assurances should be used only when it is determined that such a clause is necessary in order to make clear the purposes of Title VI. The assurances may be supplemented by additional paragraphs by the Office of the Secretary and operating administrations desiring to expand the assurances in order to make them more applicable to a particular program. All such changes or expansions shall be coordinated with the Departmental Office of Civil Rights.
4. **RESPONSIBILITIES.**
 - a. **The Departmental Director of Civil Rights** will monitor compliance with this order, including review of any expansion or addenda to the Standard DOT Title VI Assurances and Non-Discrimination Provisions by the Assistant Secretary for Administration or an operating administration.
 - b. **The Assistant Secretary for Administration**, with respect to programs for which Federal financial assistance is requested from the Office of the Secretary, shall assure that all applications include the attached Standard DOT Title VI Assurances and Non-Discrimination Provisions.
 - c. **The Head of Each Operating Administration**, with respect to programs for which Federal financial assistance is requested from the operating administrations, shall assure that all applications include the attached Standard DOT Order 1050.2, Standard Title VI Assurances and Non-Discrimination Provisions.

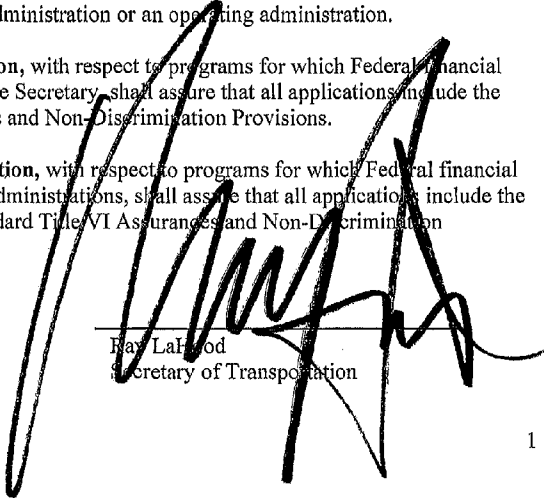

Ray LaHood
Secretary of Transportation

The United States Department of Transportation (USDOT)

Standard Title VI/Non-Discrimination Assurances

DOT Order No. 1050.2A

The (**Title of Recipient**) (herein referred to as the "Recipient"), HEREBY AGREES THAT, as a condition to receiving any Federal financial assistance from the U.S. Department of Transportation (DOT), through (**Title of Modal Operating Administration**), is subject to and will comply with the following:

Statutory/Regulatory Authorities

- Title VI of the Civil Rights Act of 1964 (42 U.S.C. § 2000d *et seq.*, 78 stat. 252), (prohibits discrimination on the basis of race, color, national origin);
- 49 C.F.R. Part 21 (entitled *Non-discrimination In Federally-Assisted Programs Of The Department Of Transportation—Effectuation Of Title VI Of The Civil Rights Act Of 1964*);
- 28 C.F.R. section 50.3 (U.S. Department of Justice Guidelines for Enforcement of Title VI of the Civil Rights Act of 1964);

Modal Operating Administration may include additional Statutory/Regulatory Authorities here.

The preceding statutory and regulatory cites hereinafter are referred to as the "Acts" and "Regulations," respectively.

General Assurances

In accordance with the Acts, the Regulations, and other pertinent directives, circulars, policy, memoranda, and/or guidance, the Recipient hereby gives assurance that it will promptly take any measures necessary to ensure that:

*"No person in the United States shall, on the grounds of race, color, or national origin, be excluded from participation in, be denied the benefits of, or be otherwise subjected to discrimination under any program or activity," for which the Recipient receives Federal financial assistance from DOT, including the (**Title of Modal Operating Administration**).*

The Civil Rights Restoration Act of 1987 clarified the original intent of Congress, with respect to Title VI and other Non-discrimination requirements (The Age Discrimination Act of 1975, and Section 504 of the Rehabilitation Act of 1973), by restoring the broad, institutional-wide scope and coverage of these non-discrimination statutes and requirements to include all programs and activities of the Recipient, so long as any portion of the program is Federally assisted.

Modal Operating Administration may include additional General Assurances in this section, or reference an addendum here.

Specific Assurances

More specifically, and without limiting the above general Assurance, the Recipient agrees with and gives the following Assurances with respect to its Federally assisted (**Name of Appropriate Program**):

1. The Recipient agrees that each "activity," "facility," or "program," as defined in §§ 21.23 (b) and 21.23 (e) of 49 C.F.R. § 21 will be (with regard to an "activity") facilitated, or will be (with regard to a

“facility”) operated, or will be (with regard to a “program”) conducted in compliance with all requirements imposed by, or pursuant to the Acts and the Regulations.

2. The Recipient will insert the following notification in all solicitations for bids, Requests For Proposals for work, or material subject to the Acts and the Regulations made in connection with all (Name of Appropriate Program) and, in adapted form, in all proposals for negotiated agreements regardless of funding source:

“The (Title of Recipient), in accordance with the provisions of Title VI of the Civil Rights Act of 1964 (78 Stat. 252, 42 U.S.C. §§ 2000d to 2000d-4) and the Regulations, hereby notifies all bidders that it will affirmatively ensure that any contract entered into pursuant to this advertisement, disadvantaged business enterprises will be afforded full and fair opportunity to submit bids in response to this invitation and will not be discriminated against on the grounds of race, color, or national origin in consideration for an award.”

3. The Recipient will insert the clauses of Appendix A and E of this Assurance in every contract or agreement subject to the Acts and the Regulations.
4. The Recipient will insert the clauses of Appendix B of this Assurance, as a covenant running with the land, in any deed from the United States effecting or recording a transfer of real property, structures, use, or improvements thereon or interest therein to a Recipient.
5. That where the Recipient receives Federal financial assistance to construct a facility, or part of a facility, the Assurance will extend to the entire facility and facilities operated in connection therewith.
6. That where the Recipient receives Federal financial assistance in the form, or for the acquisition of real property or an interest in real property, the Assurance will extend to rights to space on, over, or under such property.
7. That the Recipient will include the clauses set forth in Appendix C and Appendix D of this Assurance, as a covenant running with the land, in any future deeds, leases, licenses, permits, or similar instruments entered into by the Recipient with other parties:
 - a. for the subsequent transfer of real property acquired or improved under the applicable activity, project, or program; and
 - b. for the construction or use of, or access to, space on, over, or under real property acquired or improved under the applicable activity, project, or program.
8. That this Assurance obligates the Recipient for the period during which Federal financial assistance is extended to the program, except where the Federal financial assistance is to provide, or is in the form of, personal property, or real property, or interest therein, or structures or improvements thereon, in which case the Assurance obligates the Recipient, or any transferee for the longer of the following periods:
 - a. the period during which the property is used for a purpose for which the Federal financial assistance is extended, or for another purpose involving the provision of similar services or benefits; or
 - b. the period during which the Recipient retains ownership or possession of the property.
9. The Recipient will provide for such methods of administration for the program as are found by the Secretary of Transportation or the official to whom he/she delegates specific authority to give reasonable guarantee that it, other recipients, sub-recipients, sub-grantees, contractors, subcontractors, consultants, transferees, successors in interest, and other participants of Federal financial assistance

under such program will comply with all requirements imposed or pursuant to the Acts, the Regulations, and this Assurance.

- 10. The Recipient agrees that the United States has a right to seek judicial enforcement with regard to any matter arising under the Acts, the Regulations, and this Assurance.

Modal Operating Administration may include additional Specific Assurances in this section.

By signing this ASSURANCE, *[Name of the recipient]* also agrees to comply (and require any sub-recipients, sub-grantees, contractors, successors, transferees, and/or assignees to comply) with all applicable provisions governing the *[insert Agency name]* access to records, accounts, documents, information, facilities, and staff. You also recognize that you must comply with any program or compliance reviews, and/or complaint investigations conducted by the *[insert Agency name]*. You must keep records, reports, and submit the material for review upon request to *[insert Agency here]*, or its designee in a timely, complete, and accurate way. Additionally, you must comply with all other reporting, data collection, and evaluation requirements, as prescribed by law or detailed in program guidance.

[Name of Recipient] gives this ASSURANCE in consideration of and for obtaining any Federal grants, loans, contracts, agreements, property, and/or discounts, or other Federal-aid and Federal financial assistance extended after the date hereof to the recipients by the U.S. Department of Transportation under the *(Name of Appropriate Program)*. This ASSURANCE is binding on *[insert State]*, other recipients, sub-recipients, sub-grantees, contractors, subcontractors and their subcontractors', transferees, successors in interest, and any other participants in the *(Name of Appropriate Program)*. The person(s) signing below is authorized to sign this ASSURANCE on behalf of the Recipient.

(Name of Recipient)

by _____
(Signature of Authorized Official)

DATED _____

APPENDIX A

During the performance of this contract, the contractor, for itself, its assignees, and successors in interest (hereinafter referred to as the "contractor") agrees as follows:

1. **Compliance with Regulations:** The contractor (hereinafter includes consultants) will comply with the Acts and the Regulations relative to Non-discrimination in Federally-assisted programs of the U.S. Department of Transportation, (Title of Modal Operating Administration), as they may be amended from time to time, which are herein incorporated by reference and made a part of this contract.
2. **Non-discrimination:** The contractor, with regard to the work performed by it during the contract, will not discriminate on the grounds of race, color, or national origin in the selection and retention of subcontractors, including procurements of materials and leases of equipment. The contractor will not participate directly or indirectly in the discrimination prohibited by the Acts and the Regulations, including employment practices when the contract covers any activity, project, or program set forth in Appendix B of 49 CFR Part 21. *[Include Modal Operating Administration specific program requirements.]*
3. **Solicitations for Subcontracts, Including Procurements of Materials and Equipment:** In all solicitations, either by competitive bidding, or negotiation made by the contractor for work to be performed under a subcontract, including procurements of materials, or leases of equipment, each potential subcontractor or supplier will be notified by the contractor of the contractor's obligations under this contract and the Acts and the Regulations relative to Non-discrimination on the grounds of race, color, or national origin. *[Include Modal Operating Administration specific program requirements.]*
4. **Information and Reports:** The contractor will provide all information and reports required by the Acts, the Regulations, and directives issued pursuant thereto and will permit access to its books, records, accounts, other sources of information, and its facilities as may be determined by the Recipient or the (Title of Modal Operating Administration) to be pertinent to ascertain compliance with such Acts, Regulations, and instructions. Where any information required of a contractor is in the exclusive possession of another who fails or refuses to furnish the information, the contractor will so certify to the Recipient or the (Title of Modal Operating Administration), as appropriate, and will set forth what efforts it has made to obtain the information.
5. **Sanctions for Noncompliance:** In the event of a contractor's noncompliance with the Non-discrimination provisions of this contract, the Recipient will impose such contract sanctions as it or the (Title of Modal Operating Administration) may determine to be appropriate, including, but not limited to:
 - a. withholding payments to the contractor under the contract until the contractor complies; and/or
 - b. cancelling, terminating, or suspending a contract, in whole or in part.
6. **Incorporation of Provisions:** The contractor will include the provisions of paragraphs one through six in every subcontract, including procurements of materials and leases of equipment, unless exempt by the Acts, the Regulations and directives issued pursuant thereto. The contractor will take action with respect to any subcontract or procurement as the Recipient or the (Title of Modal Operating Administration) may direct as a means of enforcing such provisions including sanctions for noncompliance. Provided, that if the contractor becomes involved in, or is threatened with litigation by a subcontractor, or supplier because of such direction, the contractor may request the Recipient to enter into any litigation to protect the interests of the Recipient. In addition, the contractor may request the United States to enter into the litigation to protect the interests of the United States.

A

APPENDIX B

CLAUSES FOR DEEDS TRANSFERRING UNITED STATES PROPERTY

The following clauses will be included in deeds effecting or recording the transfer of real property, structures, or improvements thereon, or granting interest therein from the United States pursuant to the provisions of Assurance 4:

NOW, THEREFORE, the U.S. Department of Transportation as authorized by law and upon the condition that the (Title of Recipient) will accept title to the lands and maintain the project constructed thereon in accordance with (Name of Appropriate Legislative Authority), the Regulations for the Administration of (Name of Appropriate Program), and the policies and procedures prescribed by the (Title of Modal Operating Administration) of the U.S. Department of Transportation in accordance and in compliance with all requirements imposed by Title 49, Code of Federal Regulations, U.S. Department of Transportation, Subtitle A, Office of the Secretary, Part 21, Non-discrimination in Federally-assisted programs of the U.S. Department of Transportation pertaining to and effectuating the provisions of Title VI of the Civil Rights Act of 1964 (78 Stat. 252; 42 U.S.C. § 2000d to 2000d-4), does hereby remise, release, quitclaim and convey unto the (Title of Recipient) all the right, title and interest of the U.S. Department of Transportation in and to said lands described in Exhibit A attached hereto and made a part hereof.

(HABENDUM CLAUSE)

TO HAVE AND TO HOLD said lands and interests therein unto (Title of Recipient) and its successors forever, subject, however, to the covenants, conditions, restrictions and reservations herein contained as follows, which will remain in effect for the period during which the real property or structures are used for a purpose for which Federal financial assistance is extended or for another purpose involving the provision of similar services or benefits and will be binding on the (Title of Recipient), its successors and assigns.

The (Title of Recipient), in consideration of the conveyance of said lands and interests in lands, does hereby covenant and agree as a covenant running with the land for itself, its successors and assigns, that (1) no person will on the grounds of race, color, or national origin, be excluded from participation in, be denied the benefits of, or be otherwise subjected to discrimination with regard to any facility located wholly or in part on, over, or under such lands hereby conveyed [,] [and]* (2) that the (Title of Recipient) will use the lands and interests in lands and interests in lands so conveyed, in compliance with all requirements imposed by or pursuant to Title 49, Code of Federal Regulations, U.S. Department of Transportation, Subtitle A, Office of the Secretary, Part 21, Non-discrimination in Federally-assisted programs of the U.S. Department of Transportation, Effectuation of Title VI of the Civil Rights Act of 1964, and as said Regulations and Acts may be amended[, and (3) that in the event of breach of any of the above-mentioned non-discrimination conditions, the Department will have a right to enter or re-enter said lands and facilities on said land, and that above described land and facilities will thereon revert to and vest in and become the absolute property of the U.S. Department of Transportation and its assigns as such interest existed prior to this instruction].*

(*Reverter clause and related language to be used only when it is determined that such a clause is necessary in order to make clear the purpose of Title VI.)

B

APPENDIX C

CLAUSES FOR TRANSFER OF REAL PROPERTY ACQUIRED OR IMPROVED UNDER
THE ACTIVITY, FACILITY, OR PROGRAM

The following clauses will be included in deeds, licenses, leases, permits, or similar instruments entered into by the (Title of Recipient) pursuant to the provisions of Assurance 7(a):

- A. The (grantee, lessee, permittee, etc. as appropriate) for himself/herself, his/her heirs, personal representatives, successors in interest, and assigns, as a part of the consideration hereof, does hereby covenant and agree [in the case of deeds and leases add "as a covenant running with the land"] that:
1. In the event facilities are constructed, maintained, or otherwise operated on the property described in this (deed, license, lease, permit, etc.) for a purpose for which a U.S. Department of Transportation activity, facility, or program is extended or for another purpose involving the provision of similar services or benefits, the (grantee, licensee, lessee, permittee, etc.) will maintain and operate such facilities and services in compliance with all requirements imposed by the Acts and Regulations (as may be amended) such that no person on the grounds of race, color, or national origin, will be excluded from participation in, denied the benefits of, or be otherwise subjected to discrimination in the use of said facilities.
- B. With respect to licenses, leases, permits, etc., in the event of breach of any of the above Non-discrimination covenants, (Title of Recipient) will have the right to terminate the (lease, license, permit, etc.) and to enter, re-enter, and repossess said lands and facilities thereon, and hold the same as if the (lease, license, permit, etc.) had never been made or issued.*
- C. With respect to a deed, in the event of breach of any of the above Non-discrimination covenants, the (Title of Recipient) will have the right to enter or re-enter the lands and facilities thereon, and the above described lands and facilities will there upon revert to and vest in and become the absolute property of the (Title of Recipient) and its assigns.*

(*Reverter clause and related language to be used only when it is determined that such a clause is necessary to make clear the purpose of Title VI.)

C

APPENDIX D

CLAUSES FOR CONSTRUCTION/USE/ACCESS TO REAL PROPERTY ACQUIRED
UNDER THE ACTIVITY, FACILITY OR PROGRAM

The following clauses will be included in deeds, licenses, permits, or similar instruments/agreements entered into by (Title of Recipient) pursuant to the provisions of Assurance 7(b):

- A. The (grantee, licensee, permittee, etc., as appropriate) for himself/herself, his/her heirs, personal representatives, successors in interest, and assigns, as a part of the consideration hereof, does hereby covenant and agree (in the case of deeds and leases add, "as a covenant running with the land") that (1) no person on the ground of race, color, or national origin, will be excluded from participation in, denied the benefits of, or be otherwise subjected to discrimination in the use of said facilities, (2) that in the construction of any improvements on, over, or under such land, and the furnishing of services thereon, no person on the ground of race, color, or national origin, will be excluded from participation in, denied the benefits of, or otherwise be subjected to discrimination, (3) that the (grantee, licensee, lessee, permittee, etc.) will use the premises in compliance with all other requirements imposed by or pursuant to the Acts and Regulations, as amended, set forth in this Assurance.
- B. With respect to (licenses, leases, permits, etc.), in the event of breach of any of the above Non-discrimination covenants, (Title of Recipient) will have the right to terminate the (license, permit, etc., as appropriate) and to enter or re-enter and repossess said land and the facilities thereon, and hold the same as if said (license, permit, etc., as appropriate) had never been made or issued.*
- C. With respect to deeds, in the event of breach of any of the above Non-discrimination covenants, (Title of Recipient) will there upon revert to and vest in and become the absolute property of (Title of Recipient) and its assigns.*

(*Reverter clause and related language to be used only when it is determined that such a clause is necessary to make clear the purpose of Title VI.)

D

APPENDIX E

During the performance of this contract, the contractor, for itself, its assignees, and successors in interest (hereinafter referred to as the “contractor”) agrees to comply with the following non-discrimination statutes and authorities; including but not limited to:

Pertinent Non-Discrimination Authorities:

- Title VI of the Civil Rights Act of 1964 (42 U.S.C. § 2000d *et seq.*, 78 stat. 252), (prohibits discrimination on the basis of race, color, national origin); and 49 CFR Part 21.
- The Uniform Relocation Assistance and Real Property Acquisition Policies Act of 1970, (42 U.S.C. § 4601), (prohibits unfair treatment of persons displaced or whose property has been acquired because of Federal or Federal-aid programs and projects);
- Federal-Aid Highway Act of 1973, (23 U.S.C. § 324 *et seq.*), (prohibits discrimination on the basis of sex);
- Section 504 of the Rehabilitation Act of 1973, (29 U.S.C. § 794 *et seq.*), as amended, (prohibits discrimination on the basis of disability); and 49 CFR Part 27;
- The Age Discrimination Act of 1975, as amended, (42 U.S.C. § 6101 *et seq.*), (prohibits discrimination on the basis of age);
- Airport and Airway Improvement Act of 1982, (49 USC § 471, Section 47123), as amended, (prohibits discrimination based on race, creed, color, national origin, or sex);
- The Civil Rights Restoration Act of 1987, (PL 100-209), (Broadened the scope, coverage and applicability of Title VI of the Civil Rights Act of 1964, The Age Discrimination Act of 1975 and Section 504 of the Rehabilitation Act of 1973, by expanding the definition of the terms “programs or activities” to include all of the programs or activities of the Federal-aid recipients, sub-recipients and contractors, whether such programs or activities are Federally funded or not);
- Titles II and III of the Americans with Disabilities Act, which prohibit discrimination on the basis of disability in the operation of public entities, public and private transportation systems, places of public accommodation, and certain testing entities (42 U.S.C. §§ 12131 – 12189) as implemented by Department of Transportation regulations at 49 C.F.R. parts 37 and 38;
- The Federal Aviation Administration’s Non-discrimination statute (49 U.S.C. § 47123) (prohibits discrimination on the basis of race, color, national origin, and sex);
- Executive Order 12898, Federal Actions to Address Environmental Justice in Minority Populations and Low-Income Populations, which ensures discrimination against minority populations by discouraging programs, policies, and activities with disproportionately high and adverse human health or environmental effects on minority and low-income populations;
- Executive Order 13166, Improving Access to Services for Persons with Limited English Proficiency, and resulting agency guidance, national origin discrimination includes discrimination because of limited English proficiency (LEP). To ensure compliance with Title VI, you must take reasonable steps to ensure that LEP persons have meaningful access to your programs (70 Fed. Reg. at 74087 to 74100);
- Title IX of the Education Amendments of 1972, as amended, which prohibits you from discriminating because of sex in education programs or activities (20 U.S.C. 1681 *et seq.*).

E

29.1 General Discussion

This chapter summarizes the regulations and implementing requirements local agencies shall follow regarding services, programs, and activities in or that affect the public right of way.

Section 504 of the *Rehabilitation Act of 1973 (Section 504)* states that no person with a disability shall be excluded from participation in, denied the benefits of, or be subjected to discrimination under any program or activity that receives Federal funding. This includes both transportation and non-transportation funding. Transportation funding includes funding from the United States Department of Transportation (USDOT) or the operating administrations under it (Federal Highway Administration, Federal Transit Administration, Federal Railroad Administration, Federal Aviation Administration, Research and Special Programs Administration, National Highway Traffic Safety Administration, or the U.S. Coast Guard).

Section 504 extends to the entire operations of a recipient or subrecipient, regardless of the specific funding source of a particular operation. Section 504 Regulations ([49 CFR Part 27.5](#)) define a recipient as any public entity that receives Federal financial assistance from the USDOT or its operating administrations either directly or through another recipient. An example of a recipient is WSDOT an example of a subrecipient is a local agency receiving USDOT funds through WSDOT, for projects/programs/activities administered by the local agency.

All public entities shall follow *the Americans with Disabilities Act of 1990 (ADA)*, regardless of funding sources. The ADA is mirrored after Section 504 but extends the reach of Federal accessibility laws to include those agencies that are not recipients or subrecipients of Federal funding. Title II ([28 CFR Part 35](#)) of the ADA specifically pertains to state and local governments.

The respective Federal funding agency (FHWA) and WSDOT will ensure that local agencies comply with Section 504 and the ADA. For more information about Section 504 and the ADA, please see WSDOT Equal Opportunity ADA website: www.wsdot.wa.gov/EqualOpportunity/ADA.htm

Local agency public works staff should also refer to Chapter 42 of the Local Agency Guidelines (LAG) for technical information specific to public right-of-way facilities.

29.2 Assurances

Each local agency that receives Federal funding from the USDOT or its operating administrations (such as FHWA) shall submit a written assurance that all of its services, programs, and activities will be conducted in compliance with Section 504 and the ADA. The assurance shall be signed by the Agency Executive, and submitted to each agency (such as WSDOT) administering funds for the USDOT or an operating administration.

Federal aid projects administered through WSDOT require a Local Agency Agreement between the local agency and WSDOT. That agreement may serve as the local agency's assurance of compliance with Section 504 and the ADA as long as it is signed by the Agency Executive and states the following:

In accordance with Section 504 and the ADA, the Agency shall not discriminate on the basis of disability in any of its programs, services, or activities.

29.3 Administrative Requirements

The following list and [Appendix 29.11](#) summarize some of the key requirements of Section 504 and the ADA. Note that when a requirement cites a number of employees, that number is the number of paid permanent, temporary, and contract employees regardless of whether the employees are full or part time.

- Each agency, regardless of the number of employees and funding sources, shall ensure that its services, programs, and activities are accessible to persons with disabilities. Some things this includes are:
 - Transportation and community evacuation elements of emergency management programs/plans
 - Communications. Communications with persons with disabilities shall be as effective as communications with other persons. This applies to all forms of communications, including information posted on an agency's website (ref. Section 508 of the Rehabilitation Act and the ADA), emergency services communications, pedestrian signal systems, etc.
 - Maintenance of programs and facilities. This includes maintaining accessibility of pedestrian facilities that may be impacted by overgrown vegetation, snow/ice, severe heaving/cracking of surfaces, construction work zones, etc. Pedestrian signals/pushbuttons must also be accessible and maintained in working order.
 - New construction and altered facilities.
- Each agency regardless of the number of employees shall designate at least one person as its ADA/504 Coordinator. The individual designated as the ADA/504 Coordinator is responsible for coordinating ADA/Section 504 compliance throughout the agency. The agency shall provide the name, office address, and telephone number of the ADA/504 Coordinator both internally and externally. This information is required to be posted in areas likely to be viewed by employees and the general public (such as the agency's Web page, etc.).
- Each agency regardless of the number of employees shall adopt and publish grievance/complaint procedures. These procedures shall be posted internally and externally and be made available in alternative formats that address the needs of persons with mobility, visual, and hearing disabilities. This information is required to be posted in areas likely to be viewed by employees and the general public (such as the agency's Web page).

- Each agency, regardless of the number of employees, shall provide public notice of its ADA provisions. This notice shall contain a brief description about how the agency will address ADA accessibility in its employment, communications, policies, and resolution of complaints. This notice shall be placed in locations and/or facilities that are accessible internally and externally and be available in alternative formats that address the needs of persons with mobility, visual, and hearing disabilities. Information placed on the agency's Web page counts as posting externally.
- Each agency, regardless of the number of employees, shall conduct a self-evaluation of its policies, programs, services, and activities to determine whether Section 504/ADA accessibility requirements are being met. This includes all public right-of-way facilities. See [Appendix 29.11](#). Each agency shall provide an opportunity for interested parties (i.e., persons with disabilities/advocacy groups) to participate in the process.
- Each agency with 50 or more employees shall develop a transition plan (See Section 29.4) when structural modifications, identified through a self-evaluation process, are necessary to achieve program accessibility under the ADA. While Section 504 regulations contain similar requirements, there is no employee threshold and the regulation is not as descriptive as the ADA regulations. Therefore, each agency with fewer than 50 employees that is a recipient or subrecipient of Federal financial assistance shall develop a program access plan. See [Section 29.4](#) for the requirements of these plans.

An agency's self-evaluation and transition plan must cover all of the agency's programs (including facilities), services, and activities. The information contained in this chapter is intended to provide local agency transportation departments (i.e., public works) with guidance/expectations for addressing ADA accessibility requirements associated with public right-of-way facilities.

29.4 Transition Plan, Program Access Plan, and Accessible Pedestrian Signal and Pushbutton Policy

Each agency shall provide an opportunity for interested parties (i.e., persons with disabilities/advocacy groups) to participate in the process to develop a transition plan or program access plan.

FHWA considers transition plans and program access plans to be living documents. The applicable plan should be used in conjunction with the planning and prioritizing of projects, and for monitoring progress on completing modifications. If the time period of the plan is longer than one year, the plan shall identify steps that will be taken during each year of the transition period. FHWA also recommends that the plan be updated annually until all planned modifications have been completed.

Transition Plan

As stated in [Section 29.3](#) of this chapter, agencies with 50 or more employees (ADA), regardless of funding source, shall develop a transition plan when structural modifications are necessary to achieve ADA compliance. Based on the agency's self-evaluation, at a minimum the plan shall:

- Identify the physical obstacles in the public entity's facilities that limit the accessibility of its programs or activities to individuals with disabilities, including those within the public right of way.

- Describe in detail the methods that will be used to make the facilities accessible.
- Specify the schedule for each facility and/or obstacle to be retrofitted. FHWA recommends that an agency include the estimated cost of each modification as part of the schedule, to assist in the budget and/or Transportation Improvement Program (TIP) preparation.
- Identify the official responsible for implementation of the plan. This is typically the agency's Executive, or the agency's designated ADA/504 Coordinator who has the authority to act on behalf of the agency's Executive.

Program Access Plan

As stated in [Section 29.3](#), agencies with fewer than 50 employees and a recipient of Federal financial assistance are required to develop a program access plan. Similar to a transition plan, agencies shall:

- Identify the physical obstacles in the public entity's facilities that limit the accessibility of its programs or activities to individuals with disabilities, including those within the public right of way.
- Describe in detail the methods/actions needed to make the facilities accessible.
- Specify a schedule (milestones) of when the agency plans to make the necessary modifications.

Accessible Pedestrian Signal and Pushbutton (APS) Policy

Based on input from the U.S. Department of Justice (DOJ), it is FHWA's policy to require recipients and subrecipients (of FHWA funding) to establish a "reasonable and consistent" policy for installing accessible pedestrian signals and pushbuttons (APS) on all alteration and new construction projects, consistent with the requirements of Title II of the ADA ([28 CFR Part 35.151](#)) and Section 504 regulations ([49 CFR Part 27.7\(c\)](#)). This policy should be part of a transition plan, program access plan, or a stand-alone document if a transition plan or program access plan has not yet been completed. FHWA and WSDOT will work with local agencies to ensure that all new and altered pedestrian signal and pushbutton installations are usable by persons with visual disabilities.

29.5 Requirements for New Construction and Alterations in the Public Right of Way

Title II of the ADA requires that new and altered facilities be designed and constructed to be readily accessible to and usable by persons with disabilities.

New Construction

New construction projects address the construction of a new roadway, interchange, or other transportation facility where none existed before. New construction is expected to meet the highest level of ADA accessibility unless it is structurally impracticable to achieve full compliance. Full compliance will be considered structurally impracticable only when, in rare circumstances, the unique characteristics of terrain prevent full compliance.

Alterations

The vast majority of construction projects undertaken by local agency public works/ transportation departments are classified as alterations. An alteration is a change that affects or could affect the usability of a facility or part of a facility. Alterations include reconstruction, major rehabilitation, widening, resurfacing (e.g., asphalt overlays and mill and fill), signal installation and upgrades, and projects of similar scale and effect. Alterations to existing facilities shall meet new construction standards unless it is technically infeasible to do so. If full ADA compliance cannot be achieved in an alteration, the agency shall alter the facility to provide the maximum degree of accessibility possible. The feasibility meant by this standard is physical possibility only. Neither cost nor schedule are factors in determining whether the ADA standards can be met, nor are they factors in determining the feasibility of complying with the standard.

An alteration project shall be planned, designed, and constructed so that the required accessibility improvements occur at the same time as the alteration. If a project involves resurfacing the street, connections between the sidewalk and street crossings (i.e., curb ramps) are considered to be within the scope of the alteration project. Any accessibility issues shall be addressed in conjunction with the resurfacing project, either prior to or at the same time as the resurfacing project. For the requirements for curb ramps during resurfacing projects, see USDOJ-USDOT's Joint Technical Assistance document, dated July 8, 2013 and the Supplement to this document, dated December 1, 2015; and a FHWA recorded webinar from FHWA, dated March 1, 2016.

Safe Harbor for Alterations

Both the Section 504 and ADA requirements contain a "safe harbor" provision. However, there is a difference in the timeline associated with the Section 504 safe harbor provision and the ADA safe harbor provision.

If an agency receives Federal financial assistance from USDOT – either directly or through another USDOT recipient (such as WSDOT), the agency is subject to the 2004 ADA Accessibility Guidelines (2004 ADAAG).

This became effective in 2006 when the USDOT adopted the 2004 ADA Accessibility Guideline (2004 ADAAG) into its Section 504 regulations. This document is known as the 2004 ADA Standards. The 2004 Standards have a "safe harbor" provision for curb ramps. The provision is that if a curb ramp was constructed or altered prior to November 29, 2006, and complies with either the 1991 ADA Standards for Accessible Design (1991 ADA Accessibility Guidelines) or the Uniform Federal Accessibility Standards (UFAS), it does not need to be modified as part of a roadway resurfacing project. If this is not the case, or if the curb ramp is in disrepair then the curb ramp and its detectable warnings (truncated domes) must shall be brought into compliance with the 2004 Standards) at the time of an alternation. As mentioned above in Section 29.1, if an agency receives Federal financial assistance from USDOT – either directly or through another DOT recipient (such as WSDOT), then the agency is subject to the 2004 ADAAG as part of the USDOT Section 504 regulations.

For those agencies who are not a recipient or subrecipient of Federal financial assistance from USDOT, the safe harbor provision in the 2010 ADA Standards for Accessible Design (2010 Standards) applies. Under the 2010 Standards' safe harbor provision, if curb ramps were built or altered (in existing facilities) prior to March 15, 2012 and if they

comply with the 1991 Standards or the UFAS, they do not need to be modified as part of a resurfacing project.

However, if an existing curb ramp does not comply with either the 1991 Standards or the UFAS (including if the curb ramp is in a state of disrepair), then the Safe Harbor provision does not apply and the curb ramp would need to be brought into compliance with the 2010 Standards at the time of roadway alteration.

When curb ramps or abutting sidewalks abutting ramps are altered, they shall be reconstructed to meet the 2010 Standards. For additional curb ramp design guidance, see LAG manual Chapter 42.

Documentation for Structural Impracticability and Maximum Extent Feasible

While ADA/Section 504 regulations do not require documentation of the application of structural impracticability nor maximum extent feasible, both FHWA and the U.S. Access Board recommend that these instances be documented so the agency can support its decisions if challenged at a later date. The documentation of these instances should reveal the standard of care that guided engineering judgments. While careful documentation will not protect an agency against complaint, evidence of the considerations that led to the specific project solution may be persuasive in discussions with stakeholders or in court.

As described in the *Design Manual* M 22-01, WSDOT has a documentation procedure for applications of maximum extent feasible in alteration projects on state routes. If a local agency applies maximum extent feasible to a pedestrian facility located on a state route, it is WSDOT's expectation that the agency follow the WSDOT documentation procedure described in the *Design Manual* M 22-01. The completed documentation should be contained in local agency project files to document the agencies design efforts in complying with the ADA/Section 504 requirements.

If a local agency finds the need to apply maximum extent feasible to a pedestrian facility that is not located on a state route, the WSDOT documentation procedure does not need to be followed. However, it is highly recommended that the agency develop its own documentation protocol for such situations that is consistent with the FHWA and U.S. Access Board recommendations.

29.6 Monitoring and Enforcement

Responsibility for monitoring and enforcement of Section 504 rests with the Federal funding agency (such as FHWA). While USDOJ has the ultimate enforcement authority for ADA compliance, USDOJ has delegated monitoring and enforcement responsibility to several Federal executive agencies including the USDOT and its operating administrations (such as FHWA).

FHWA requires WSDOT to monitor and enforce the compliance with both Section 504 and the ADA of any entity receiving disbursement of either state or Federal funding through WSDOT. FHWA monitors WSDOT and local agency compliance through various means such as process and program reviews, construction inspections, PS&E reviews, and complaint investigations. If noncompliance is found, and the noncompliance is not corrected to FHWA's satisfaction, FHWA may terminate existing Federal funding or refuse to grant future funding.

29.7 Laws

- 29 USC 794 - Section 504 of the Rehabilitation Act of 1973 (as amended by the Civil Rights Restoration Act of 1987)
- 42 USC 12111 - Americans with Disabilities Act (Title II)

29.8 Regulations

- [28 CFR Part 35](#) (Title II) “Nondiscrimination on the Basis of Disability in State and Local Government Services”
- [49 CFR Part 27](#) (Section 504) “Nondiscrimination on the Basis of Disability in Programs or Activities Receiving Federal Financial Assistance”
- [49 CFR Part 37](#) “Transportation Services for Individuals with Disabilities (ADA)”
- [49 CFR Part 38](#) “Americans with Disabilities Act (ADA) Accessibility Specifications for Transportation Vehicles”

29.9 Resources

- Chapters [1510](#) and [1515](#) of the *Design Manual* M 22-01
- [Chapter 42](#) of this manual

29.10 Appendices

- [29.11](#) ADA Title II and Section 504 Regulatory References

Appendix 29.11 ADA Title II and Section 504 Regulatory References

ADA Title II and Rehabilitation Act Section 504 Regulatory References	Requirements for agencies with less than 50 employees	Requirements for agencies with 50 or more employees
Programs, Services, and Activities: Ensure that programs, services, and activities are accessible to persons with disabilities. (28 CFR Part 35.150(a) and (c))	✓	✓
ADA/504 Coordinator: Designate at least one responsible employee (ADA/504 Coordinator) and make the name and contact information available internally and externally. (28 CFR Part 35.107(a) and 49 CFR Part 27.13(a))	✓	✓
Complaint/Grievance Procedures: Adopt and publish complaint/grievance procedures. (28 CFR Part 35.107(b) and 49 CFR Part 27.13(b))	✓	✓
Notice of ADA Provisions: Provide a public notice of how the agency will address ADA accessibility in its employment, communications, policies, and resolution of complaints. (28 CFR 35.106)	✓	✓
Self-evaluation²: Evaluate all services, policies, and practices for barriers that restrict / limit persons with disabilities from access to services, programs, and activities. (28 CFR Part 35.105(a) and 49 CFR Part 27.11(c)(2)(i) and (v))	✓	✓
Self-evaluation²: Maintain the completed self-evaluation on file and make it available for public inspection for at least three years following its completion. (28 CFR Part 35.105(c) and 49 CFR Part 27.11(c)(3)(ii):	✓	✓
Transition Plan²/Program Access Plan: Develop a transition plan or program access plan that outlines the structural modifications that must be made to those services, programs, and activities that are not accessible. (28 CFR Part 35.150(d) and 49 CFR Part 27.11(c)(2)(ii))	✓ program access plan	✓ transition plan (post it on the agency's website)
Accessible Pedestrian Signal and Pushbutton (APS) Policy²: Develop a "reasonable and consistent" policy for installing accessible pedestrian signals and pushbuttons when a transition plan has not yet been completed. (28 CFR Part 35.130 and 35.160a(1) and 49 CFR Part 27.7(c))	✓	✓

Notes:

¹Employees include paid permanent, temporary, and contract employees regardless of whether the employees are full or part time.

²Complete self-evaluations, and develop transition plans, program access plan and APS policies by engaging persons with disabilities and/or their advocates (28 CFR Parts 35.105 and 35.150 and 49 CFR Part 27.11(c)(2)).

Chapter 31 *Using Consultants*

To be eligible for reimbursement of Federal Highway Administration (FHWA) funds for payments to a consultant, the procedures in this chapter must be followed. If a Local Agency elects to retain the consultant at its own cost, state law must be followed.

This chapter covers agreements for architects, landscape architects, land surveying, and engineering services outlined in [RCW 39.80](#) (see [Section 31.1](#)). The definitions of these four professions are described in [RCW Chapters 18.08, 18.43, and 18.96](#). These will be referred to as architectural and engineering (A&E) services, or engineering services, in this chapter. These include:

- Professional services of an architectural or engineering nature that are required to be performed or approved by a person licensed, registered, or certified to provide the service needed.
- Professional services of an architectural or engineering nature performed by contract that are associated with research, planning, development, design, construction, alteration, or repair of real property.
- Professional services of an architectural or engineering nature, or incidental services, which members of the architectural and engineering profession perform services, including but not limited to studies, investigations, surveying and mapping, value engineering, construction phase services, soils engineering, and other related services.

This chapter also covers Non-A&E Professional Service agreements. Examples of professional services typically include, but are not limited to:

- Material testing (as long as the consultant is delivering test results only, not performing an analysis or producing a discipline report).
- Financial and economic analyses.
- Environmental planning—as opposed to environmental engineering.
- Legal services.
- Management consulting not related to A&E projects.
- Media and public involvement; marketing services.
- Research.
- Scientific studies.
- Appraisal services not related to A&E projects.
- Real Estate activities including acquisition, relocation, appraisal, appraisal review, and property management
- Expert witness services for litigation.

Throughout this chapter the term “project” means the work to be undertaken by the consultant.

The basic steps for entering into a consultant agreement are:

1. Determine the need for services.
2. Advertise the need for services.
3. Evaluate the applicants' qualifications.

4. Select the most qualified firm.
5. Negotiate with the most qualified firm.
6. Execute the contract (Agreement, Exhibits, and Supplements – see appendices).

31.1 A&E Services Consultants

A&E consultant services include the following:

1. Professional or technical expertise to accomplish a specific study, project, task, or other work statement.
2. Any phase of project development, as well as special studies or other assignments within any phase.
3. Periodic examination and consultation or full-time technical inspection during the construction phase.
4. Consultant design and preparation of plans, specifications, and estimates is common when an Agency's staff is small or when an Agency needs additional expertise.

Consultant services do not include purchased services provided by a vendor to accomplish routine, continuing, and necessary services. These may be acquired through use of purchased service agreements. Purchased services include services for equipment maintenance and repair, operation of a physical plant, security, computer hardware and software maintenance, data entry, key punch services, computer time-sharing, contract programming, and analysis ([RCW 39.26](#)).

Section 319 of Public Law 101-121 prohibits federal funds from being expended by consultants or subconsultants who receive a federal contract, grant, loan, or cooperative agreement to pay, any person for influencing or attempting to influence a federal Agency or Congress in connection with awarding any of the above.

11. Determine the Need for A&E Consultant Services – Before an Agency advertises for A&E consultant services, Agencies must have a clear definition of the work to be accomplished. This includes identification of:

1. The nature and scope of effort required.
2. The technical requirements and qualifications of the consultant services needed.
3. The level of funding resources available.
4. The time frame for performing the work.
5. The expected results and products to be received (deliverables).
6. An independent agency cost estimate (see [Appendix 31.94](#)).
7. The establishment of consultant contract DBE goal.

If assistance is needed in describing the desired scope of work, the Agency should seek information from the Region Local Program Engineer or from other Local Agencies that have had similar projects.

Selection of the most qualified consultant firm is based on evaluations, therefore Agencies must develop clear selection guidelines (see [Section 31.13](#)). The selection criteria should enable the Agency to identify and select the consultant best qualified to meet the Agency's needs and ensure that the selected consultant understands and provides services for the Agency's needs in the most cost-effective manner.

The three agreement types are lump sum, cost plus fixed fee, and negotiated hourly rates (see [Section 31.42](#)). The Agency should determine the type of agreement to be developed with the consultant (though this may be modified during negotiations with the selected consultant). Consultant agreements are available at www.wsdot.wa.gov/localprograms.

Consultant selection shall provide for maximum open and free competition and should provide opportunities for small and disadvantaged business enterprises to obtain an equitable share of the work, consistent with the project scope and capabilities of available small and disadvantaged owned firms.

A&E consultants may be solicited for:

1. A specific project.
2. A specific stage of a project (i.e., Design Report).
3. Engineering services (i.e., supporting services of an Agency's staff in studies, design).
4. For more than one project (i.e., several small bridge design projects) or multiple phases of a single project.
5. Or a combination of the above.

.11a Multi-Phase Projects – In the case of projects covering two or more distinct phases, when the cost for the second phase depends on decisions reached during the first phase, the agreement should cover only the first phase. The agreement for preliminary engineering should state that the consultant may be considered for subsequent phases provided this option was identified in the advertised solicitation. The consultant's engagement to complete subsequent phases depends upon the consultant's satisfactory performance on prior work and upon negotiation of an agreement for the subsequent phase(s). The Agency is not obligated to use the same consultant firm for all phases. Separate consultant agreements may be considered for each phase (e.g., one for preliminary engineering and another for construction engineering).

.11b Environmental Assessment/Environmental Impact Statement/Environmental Classification Summary – The first agreement would include preliminary engineering through final approval of the environmental documents. Preparation of the PS&E could be under a separate agreement with continuation of the original consultant at the option of the Agency, provided this was stated in the original advertisement.

.11c Engineering Management Consultants – While an engineering management consultant may assist an Agency in fulfilling its responsibilities, the Agency cannot delegate these responsibilities to a consultant or to another Agency. A consultant serving in a management role for an Agency, and then managing consultant agreements with its own firm, is a conflict of interest.

.12 Advertise the Need for A&E Consultant Services – State law, [RCW 39.80](#), requires that each Agency must advertise that Agency’s requirement(s) for architectural services, land surveying services, or engineering services. An Agency can comply with these requirements by publishing an announcement on each occasion when A&E consultants are required by the Agency.

The need for consultant services must be advertised at least one day per week for two consecutive weeks (14 day minimum) in the area newspaper used for publication of legal notices. A three week minimum response time from the initial date of publication should be provided to consultants. These advertisements may be supplemented by additional advertisements in special interest publications such as the Daily Journal of Commerce, trade magazines, or publications utilized by disadvantaged business enterprises.

Agencies may also publish an announcement for emergent need contracts. There are four disciplines in which an agency may advertise for and award contracts to multiple firms to assist agencies if unexpected needs arise during construction. These disciplines include:

- **Geotechnical** – Investigations include the assessment of the risk to humans, property and the environment from natural hazards such as earthquakes, landslides, sinkholes, soil liquefaction, debris flows and rockfalls.
- **Hydraulics** – These activities include roadways threatened by a river and/or the occurrence of scour.
- **Archeological** – Investigations include surveying the construction site and analyzing any findings if construction activities caused disturbance to potential cultural resources or human skeletal remains.
- **Environmental** – These activities involve contacting resource agencies, documenting all construction activities that may require mitigation and monitoring in-water work activities

Agencies would award contracts to several firms that meet the required criteria. Agencies will then rotate work through all of the firms selected. These agreements will be for a **one year** period of time and will include a “not to exceed” dollar amount. An agency may extend the agreement for one additional year provided the original dollar amount was not exceeded.

.12a Advertisement Content – The advertisement should contain the following information (see [Appendix 31.91](#) for an advertisement example):

1. A project title and estimated start and end date.
2. The scope and nature of the project, including technical requirements for which services are required and the address of a representative of the Agency who can provide further details.
3. Solicitations of qualification statements, referred to as Requests for Qualifications (RFQ) from consultants, must incorporate a clear and accurate description of the technical requirements for the service to be procured, including any special conditions or certifications required. (Example Submittal Information Forms to obtain consultant qualifications for Prime and Subconsultants are contained in [Appendix 31.92\(a\)](#) and [31.92\(b\)](#), respectively.)

4. Solicitations must clearly set forth sufficient detail on how applicant qualifications will be evaluated. These may include but are not limited to key personnel, firm experience, ability to meet schedule, past performance, in-house expertise, familiarity with WSDOT/FHWA standards, and DBE approach and commitment.
5. Nonengineering service applicants should be asked to provide estimates for the man-hours and classifications needed to complete the project.
6. In the event that a project covers multiple phases (see [Section 31.11a](#)), the Agency is not obligated to utilize the original consultant for subsequent phases. If the Agency desires this option, the advertisement must state the possibility of a multi-phase agreement at the discretion of the contracting Agency.
7. All prospective consultants must be advised that federally funded projects will be held to Federal EEO requirements.
8. Consultants will also be held to ADA and Civil Rights language for the employing Agency.
9. **Local Agencies must be in compliance with Chapter 28 and their Title VI Agreement. Therefore, when advertising for Consultant Services, the following Title VI language must be included in advertisement:**

“The (Local Agency) in accordance with Title VI of the Civil Rights Act of 1964, 78 Stat. 252, 42 U.S.C. 2000d to 2000d-4 and Title 49, Code of Federal Regulations, Department of Transportation, subtitle A, Office of the Secretary, Part 21, nondiscrimination in federally assisted programs of the Department of Transportation issued pursuant to such Act, hereby notifies all bidders that it will affirmatively ensure that in any contract entered into pursuant to this advertisement, disadvantaged business enterprises as defined at 49 CFR Part 26 will be afforded full opportunity to submit bids in response to this invitation and will not be discriminated against on the grounds of race, color, national origin or sex in consideration for an award.”

1. Response due date.
2. Publication dates.

Specific project cost estimates shall not be requested until a consultant has been selected.

.13 A&E Consultant Evaluation and Selection Process – The Local Agency must establish guidelines for technical evaluation of the qualifications received, determination of finalists for the purpose of written or oral discussions, and selection for agreement award. Consultants will be selected based upon the qualifications they present. For A&E related services, fees for services cannot be considered during the selection process.

One of the following must be utilized as part of the consultant selection process:

1. **“Live” Interviews and Presentation of the RFQ by Consultant Individuals or Teams** – This provides interaction with the Agency and showcases the consultant’s presentation skills. This approach is best for larger, more complex projects, but does increase travel time and costs to the applicant. Video presentation or teleconferencing may be considered as an alternative to reduce travel costs.

2. **Telephone Interviews** – This provides for interaction but eliminates travel time and cost. This approach is useful for smaller projects.
 - A. Exceptions to the competitive process used for consultant selection:
 1. **Subsequent Phasing** – Selection of a consultant to perform subsequent project phases may only occur if this option was advertised originally (i.e., Phase 1 Preliminary Engineering, Phase 2 Right of Way, Phase 3 Construction Engineering).
 2. **Contract Amendments** – Amendments that do not significantly alter the scope of work can be renegotiated with the existing consultant. However, this should not be used to avoid the responsibility of providing competition for consultant selection.
 3. **Emergency** – To address a set of unforeseen circumstances beyond the Agency’s control which present a real, immediate threat to the proper performance of essential functions, or may result in the material loss or damage to property, bodily injury, or loss of life if immediate action is not taken (see [Chapter 33](#)).
 4. **Sole Source** – Sole source agreements may be requested from Local Programs when the consultant provides professional or technical expertise of such a unique nature that the consultant is clearly and justifiably the only practicable source to provide the service. The Local Agency must provide the Region Local Programs Engineer written justification (see [Appendix 31.93](#)) for requesting this option based upon:
 - a. The unique nature of the services and/or the unique qualifications, abilities, or expertise of the consultant to meet the Agency’s needs (e.g., are they highly specialized or one-of-a-kind? What is their past performance, their cost effectiveness (learning curve), and/or the follow-up nature of the required services?).
 - b. Other special circumstances that may be relevant such as confidential investigations, copyright restrictions, or time constraints.
 - c. Availability of consultants in the location required. Local Programs must approve all consultant procedures that are exceptions to the competitive process
 - B. **Documentation of Selection** – Following consultant selection, the Local Agency shall retain the following documentation in the project file:
 1. The names of a minimum of three consultants considered for the work (excluding exceptions detailed above).
 2. Consultant selected and reasons why this consultant was chosen over the others.
 3. Prior to executing an agreement agencies must verify consultant status with the *System for Award Management* (SAM) at www.sam.gov/portal/public/sam to determine if the consultant has been excluded from bidding on a federal aid contract. SAM is the electronic version of the Lists of Parties Excluded from Federal Procurement and Nonprocurement Programs (Lists), which identifies those parties that have been suspended,

debarred, or otherwise excluded from bidding on federal procurement and nonprocurement contracts. Consultant agreements awarded to firms listed on the Excluded Parties Listing will not be eligible for federal aid reimbursement.

31.2 Non-A&E Professional Services Consultants

Professions outside the fields described in [RCW 39.80](#) may provide such consulting services such as long range planning and studies, economic analyses, and real estate activities. These consulting services are provided through professional services agreements ([RCW 39.26](#)). The basic difference between professional services and A&E consultants is that consultant fees may be considered in selecting professional services consultants, but cannot be considered in selecting A&E services consultants.

Real Estate consulting activities include acquisition, relocation, appraisal, appraisal review and property management and can be contracted under a Non A&E professional services agreement under authority of [RCW 39.26](#).

The Local Agency is to work with Local Programs Real Estate section on right of way non-A&E professional services agreements.

.21 Determine the Need for Professional Services Consultants – Before an Agency advertises for a professional services consultant, the agency must have a clear definition of the work to be accomplished. This includes identification of:

1. The nature and scope of effort required.
2. The technical requirements and qualifications of the consultant services needed.
3. The level of funding resources available.
4. The time frame for performing the work.
5. The expected results and products to be received.
6. An independent agency cost estimate (see [Appendix 31.94](#)).
7. The establishment of consultant contract DBE goal.

If assistance is needed in describing the desired scope of work, the Agency should seek information from the Region Local Program Engineer or from other Local Agencies that have had similar projects.

The Agency should develop selection guidelines for all to understand, because selection of the most qualified consultant firm is based upon evaluations by the Agency. The selection criteria should enable the Agency to identify and select the consultant best qualified to meet the Agency's needs and ensure that the selected consultant understands and provides the Agency's needs in the most cost-effective manner.

The Agency should determine the type of agreement to be developed with the consultant. (This may be modified during negotiations with the selected consultant.) The basic agreement types are lump sum, cost plus fixed fee and negotiated hourly rates, (see [Section 31.42](#)).

Consultant selection shall provide for maximum open and free competition and should provide opportunities for small and disadvantaged business enterprises to obtain an equitable share of the work, consistent with the project scope, and capabilities of available small and disadvantaged owned firms.

Professional Services consultants may be solicited for:

1. A specific study (i.e., Economic Study).
2. A specific project (i.e., Acquisition of Real Estate).
3. A specific task (i.e., Real Estate negotiations).
4. Or a combination of the above.

.22 Advertise the Need for Professional Services Consultants – State law ([RCW 39.26](#)) requires that each Agency must competitively solicit that Agency’s requirement for professional services. An Agency can comply with these requirements by using a competitive solicitation process that provides an equal and open opportunity to qualified parties.

The need for consultant services must be advertised at least one day per week for two consecutive weeks (14 day minimum) in the area newspaper used for publication of legal notices. A three week minimum response time from the initial date of publication should be provided to consultants. These advertisements may be supplemented by additional advertisements in special interest publications such as the Daily Journal of Commerce, trade magazines, or publications utilized by disadvantaged business enterprises.

.22a Advertisement Content – The advertisement should contain the same information listed in [Section 31.12a](#) (see [Appendix 31.91](#) for an advertisement example).

.23 Professional Services Consultant Evaluation and Selection Process – The Local Agency must establish guidelines for technical evaluation of the qualifications received, determination of finalists for the purpose of written or oral discussions, and selection for agreement award. Consultants will be selected based upon the qualifications they present. Fees may be considered as an evaluation factor in the professional services selection process, but it is not a “low-bid” consultant selection where the low bidder wins the contract automatically.

One of the following is required as part of the consultant selection process:

1. **Written Response Only to the Request for Qualifications (RFQ)** – This approach is best for smaller, clearly defined projects, or projects which are heavily reliant upon their written presentation such as environmental reports.
2. **“Live” Interviews and Presentation of the RFQ by Consultant Individuals or Teams** – Provides for interaction with the Agency and showcases the consultant’s presentation skills. This approach is best for larger, more complex projects but does increase travel time and costs to the applicant. Video presentation or teleconferencing may be considered as an alternative to reduce travel costs.
3. **Telephone Interviews** – Provides for interaction but eliminates travel time and cost. This approach is useful for smaller projects.

Exceptions to the competitive process used for consultant selection:

4. **Sole Source** – Sole source agreements may be requested from Local Programs when the consultant provides professional or technical expertise of such a unique nature that the consultant is clearly and justifiably the only practicable source to provide the service. The Local Agency must provide the Region Local Programs Engineer written justification (see [Appendix 31.93](#)) for requesting this option based upon:
 - A. The unique nature of the services and/or the unique qualifications, abilities, or expertise of the consultant to meet the Agency's needs (e.g., are they highly specialized or one-of-a-kind? what is their past performance, their cost effectiveness (learning curve), and/or the follow-up nature of the required services?).
 - B. Other special circumstances that may be relevant such as confidential investigations, copyright restrictions, or time constraints.
 - C. Availability of consultants in the location required.
5. **Emergency** – To address a set of unforeseen circumstances beyond the Agency's control which present a real, immediate threat to the proper performance of essential functions or may result in the material loss or damage to property, bodily injury, or loss of life, if immediate action is not taken (see [Chapter 33](#)).
6. **Contract Amendments or Added Scope (beyond the original advertisement)** – Amendments that do not significantly alter the scope of work can be renegotiated with the existing consultant. However, this should not be used to avoid the responsibility of providing competition for consultant selection.

Local Programs must approve consultant procedures that are exceptions to the competitive process.

.24 Document Selection – Following consultant selection, the Local Agency shall retain the following documentation in the project file:

1. The names of a minimum of three consultants considered for the work (excluding exceptions detailed above); and
2. Justification for the consultant selected, including the reasons why this consultant was chosen over the others.

Prior to executing an agreement agencies must verify consultant status with the System for Award Management (SAM) at www.sam.gov/portal/public/sam to determine if the consultant has been excluded from bidding on a federal aid contract. SAM is the electronic version of the Lists of Parties Excluded from Federal Procurement and Nonprocurement Programs (Lists), which identifies those parties that have been suspended, debarred, or otherwise excluded from bidding on federal procurement and nonprocurement contracts. Consultant agreements awarded to firms listed on the Excluded Parties Listing will not be eligible for federal aid reimbursement.

31.3 Establishment of Consultant Roster

To efficiently obtain consultant services, a process for developing and maintaining a consultant “Roster” is necessary. Agencies may establish and maintain a continuous “Roster” to which interested and qualified firms may apply. This “Roster” **must** be maintained annually.

Each agency **must** submit the “Roster” selection procedures to the Regional Local Program Engineer for **review and approval**. The “Roster” selection procedures must address the following:

1. Process of invitation to be included on the “Roster”.
2. Process of encouraging firms to submit or update qualifications and performance data.
3. Guidelines for technical evaluation and ranking of firms to establish the “Roster”.
4. Threshold and formal process for Second Tier competition (see WSDOT
5. [Consultant Service Manual](#) Appendix Y).
6. Nondiscrimination/equal opportunity for DBE consultants

When using the “Roster”, the federal aid project must be identified prior to the consultant selection process. No “Roster” consultant may be awarded more than one federal aid contract from the “Roster” at a time. When active contracts are complete, the consultant’s name will be returned to “available” status.

31.4 Negotiation With Selected Firm, A&E, and Non-A&E Professional Services

The Local Agency will notify the consultant of their selection in writing, meet with the consultant to reach a complete and mutual understanding of the scope of services, and begin negotiations on the terms of the agreement.

In this meeting with the selected consultant, the Local Agency should include key people with appropriate technical expertise within the Agency to ensure that their concerns are addressed. The following are typically discussed while developing an agreed upon scope of services:

1. A list of meetings the consultant is expected to attend, expected location of the meetings, and key personnel.
2. The anticipated design schedule. The Local Agency shall designate the basic premises and list criteria to be used in design development.
3. Any special services required.
4. Complexity of the design.
5. Safety and operational considerations.
6. Environmental considerations.
7. Survey and geotechnical testing requirements.
8. Inspection services during construction.
9. Quality control during construction.

10. Preparation of forms, letters, and documents.
11. Property map preparation.

.41 Agency Preparation for Negotiations – Following receipt of the consultant's proposal, Agency responsibilities include:

Compare the consultant's proposal with the Agency's own estimate, examining the scope of work, work hours, and estimate of cost. (See [Appendix 31.94](#), Independent Estimate for Consulting Services, DOT Form 140-012.) The Agency is to prepare its independent cost estimate using:

1. The salary rates by position from the consultant's Payroll Register.
2. Multiplying these by the Agency's estimates of staff hours by position for work elements.
3. Apply the consultant's overhead rate and profit/fixed fee (see below) to develop the total project staff cost estimate.

The Agency will use this independent estimate, along with estimates of nonsalary costs, to negotiate the agreement with the consultant.

1. Ensure the consultant has divided the project into work units and related time units in such a manner that the estimate can be readily reviewed for work hours, rates of pay, overhead, profit, and itemized direct nonsalary costs.
2. Request records to confirm the consultant's rates (i.e., their Payroll Register, giving payroll rates by name and position of staff working on the project).
3. Request the consulting firm's indirect cost rate from the WSDOT Consulting Services Office (see Section 31.6 for indirect cost rate details).
4. Calculate the consultant's profit/fixed fee amount. WSDOT's procedure for calculating this is described in [Consultant Services Manual](#) M 27-50, Appendix AA. The fee is determined through evaluation of the following:
 - A. Degree of risk.
 - B. Relative difficulty of work.
 - C. Size of job.
 - D. Period of performance.
 - E. Assistance of agency.
 - F. Subconsulting.
 - G. An acceptable profit for a federally funded project may not exceed 15 percent of the total of direct labor plus overhead costs or the fixed fee/profit percentage may not exceed 35 percent of direct labor costs only. Maximum allowable profit percentage rates (20 to 35 percent) are reserved for the most difficult, complex, and risky projects. Mark-ups are not allowed on direct "nonsalary" costs.

- H. A Management Reserve Fund (MRF) may be established to be used for:
1. Overruns of direct salary and overhead costs that might occur under the existing scope of work, or
 2. The consultant to perform additional work that is outside the agreement or supplement's scope of work (but within the scope of the advertised project).

The maximum MRF set up at the beginning of the agreement is \$100,000 or 10 percent of the agreement, whichever is less. If the original MRF is less than \$100,000, the MRF may be increased by preparing a supplement to a total accumulative amount that cannot exceed \$100,000, (or exceed the cumulative 10 percent). An MRF cannot be included in a Lump Sum agreement. The Agency cannot authorize, and the consultant cannot utilize, the MRF until a task order is set up. To set up a task order, the Agency and consultant must negotiate the scope, schedule, and budget for the increase in direct salary and overhead costs, or the increase in additional work to use all or a portion of the MRF.

5. Record and retain an explanation of differences in work hours or costs between the Agency's independent estimate and the negotiated consultant fee.

.42 Agreement Types/Payment Options – The following are the types of agreements that contain acceptable methods of payment for FHWA funded projects. Consultant agreements are available at www.wsdot.wa.gov/localprograms.

1. **Lump Sum** – This type of agreement is only appropriate where the scope of work (quantity and type) can be clearly defined in advance. It is not recommended for construction engineering agreements. The agreement should state the exact service to be provided within a specific time frame, and when the lump sum payment is to be made. Payments may also be paid in installments as the work proceeds.
 - Scope of work changes and Management Reserve Funds are not allowed with this type of payment.
 - Lump sum payments are generally used for investigations, studies, and basic services on design projects. A qualified representative for the Agency must prepare, date, and sign an estimate detailing the hours required for each type of work, as well as the hourly rate. Lump Sum contracts cannot be supplemented.
2. **Actual Costs Plus a Fixed Fee** – This type of agreement is used when the extent, scope, complexity, character, or duration of the work cannot be reasonably determined in advance. The consultant is reimbursed for all eligible direct and indirect costs within defined limits, plus a predetermined amount as a fixed fee. The costs for methods 1-3 above are determined by:
 - A. Salaries of employees with time directly chargeable to the project and salaries of principals for the time they are productively engaged in work necessary to fulfill the terms of the agreement. Actual rates of pay for employees and principals actively involved in the project will be included in each agreement.
 - B. Direct nonsalary costs incurred in fulfilling the terms of the agreement. Travel costs, (excluding air, train, and rental car costs), shall be in accordance with the Agency's travel rules and procedures. Air, train and rental car costs shall be reimbursed in accordance with 48 CFR Part 31.205-46 "Travel Costs."

- C. The consultant's overhead schedule must be prepared in compliance with CFR Part 31. The indirect costs must be allowable, allocable, and properly segregated. "Indirect cost rates shall be updated on an annual basis in accordance with the consultant's annual accounting period and in compliance with the Federal cost principles." 23 CFR 172.11(b)(1)
- D. Management reserve funds are an Agency option and are to address overruns of direct salary and overhead costs that might occur under the existing scope of work or a need for additional work beyond the existing agreement scope of work, but within the advertised project scope of work.
- E. Profit/fixed fee is derived by considering the degree of risk, relative difficulty of work, size of job, period of performance, assistance by the Agency, and subconsulting assumed by the consultant at the time of the negotiations (see [Section 31.41](#)).

Shown as exhibits to the agreement are the consultant's estimate of work, direct labor rates, indirect cost rate and fixed fee.

- 3. **Specific Rates of Pay** – This type of agreement is based upon specific rates of pay for each class of employee and is appropriate for relatively minor items of work of indeterminable extent. This method requires constant and direct control of the time and class of employees used by the consultant. This rate of pay is established through:
 - A. **Negotiated Hourly Rate** – The rate of pay is established through use of the consultant firm's payroll register, the indirect cost rate obtained from WSDOT's Consultant Services Office, plus the calculation of the consultant's profit/fixed fee. (See [Section 31.41](#) for guidance in developing the independent estimates of these costs for use in negotiations with the consultant firm.) The following items also apply to negotiated hourly rate agreements.
 - 1. Direct nonsalary costs incurred in fulfilling the terms of the agreement. Travel costs, (excluding air, train, and rental car costs), shall be in accordance with the Agency's travel rules and procedures. Air, train, and rental car costs shall be reimbursed in accordance with 48 CFR Part 31.205-46 "Travel Costs." The consultant's overhead schedule must be prepared in compliance with 48 CFR Part 31. The indirect costs must be allowable, allocable and properly segregated.
 - 2. Profit/fee is derived by considering the degree of risk, relative difficulty of work, size of job, period of performance, assistance by the Agency, and subconsulting assumed by the consultant at the time of the negotiations (see [Section 31.41](#)). "Fixed fee means a sum expressed in U.S. dollars established to cover the consultant's profit and other business expenses not allowable or otherwise included as a direct or indirect cost."
23 CFR 172.3

Prime consultants cannot markup subconsultants contracts, however the fee (profit) should be negotiated to reflect a percentage of subcontracting relative to the percentage of work by the prime consultant. Subcontracting is then one of several considerations when determining a reasonable profit. Justification for the profit should be included in the record of contract negotiations.

.43 Agency/Consultant Negotiations – Negotiate an agreement with the selected consultant and retain a record of these negotiations (see [Appendix 31.95](#)). Negotiations may include the following:

1. The Agency negotiator and the consultant meet in person or by telephone and go over any significant areas of discrepancy between the Agency estimate and consultant proposal. Either the consultant satisfactorily explains differences or agrees to address concerns in a revised proposal.
2. The Agency reviews revised proposals and revises their detailed cost analysis accordingly. Steps 1 and 2 are repeated, if required.
3. The consultant submits a final fee proposal.
 - A. Provide a final offer in writing.
 1. The final agreement must specify the maximum amount payable.
 2. The basis for establishing the maximum amount should be documented.
 3. Procedures for adjustments to the maximum amount to accommodate changes in the work distribution or workload shall be explained.
 - B. When unresolved differences exist between the consultant and Local Agency, the Agency shall notify the Region Local Programs Engineer. The Local Programs Engineer will review and confirm that the Agency has followed all the required procedures and will notify the Agency of the finding. The Agency will then notify the consultant in writing that negotiations are terminated and proceed to the next highest ranked consultant to begin the negotiation process again. Negotiation steps and records will be repeated with the alternate consultant selected.

31.5 Consultant Agreements, Exhibits, and Supplements to Agreements, A&E, and Non-A&E Professional Services

When the **total cost** of consulting services (including supplements) is \$10,000 or more, Local Agencies must use the Local Agency Standard Consultant Agreements. (Consultant Agreement forms are available online at www.wsdot.wa.gov/localprograms. The agreement completion date establishes the last possible date the consultant may work, and be paid for that work, utilizing federal funds. **Any work performed after expiration of the agreement will be considered non-federally participating.** It is of the utmost importance that the Agency monitors the project completion date and extend the date by supplemental agreement, if appropriate, **prior** to the completion date.

The time period for completion of the agreement is dependent upon the complexity of the project's scope of work. The duration may vary from two years for a relatively simple project, to six or more years for a complex project having multiple phases of work.

.51 Vacant

.52 Supplements to the Agreements – An agreement shall be supplemented in writing when work that falls outside the scope of the original agreement is requested, when supplemental language to the consultant agreement is desired, or when there is a need for time extension or wage adjustment. This may be done by a supplemental agreement only when the agreement completion date has not expired. (Supplemental

Agreement forms are available online at www.wsdot.wa.gov/localprograms.) The work in the supplement must have been included in the advertisement for consultant services regarding the original agreement.

The supplemental agreement should include:

1. A statement that the original agreement will be supplemented to add/change/amend conditions.
2. A scope of work described in sufficient detail to clearly outline what additional work the consultant is to do or what changes are authorized to the existing scope.
3. The method of payment, i.e., cost-plus-fixed-fee, specified hourly rate, daily rate, and any indirect cost. (**Note:** Always include a maximum amount payable.) Section V of the original agreement should be reviewed prior to negotiating any supplements.
4. A specific time for beginning/continuing work under the supplement and completing the project in calendar days or day and month of the year.
5. A summary of the estimated costs of the original agreement plus those of the supplement(s).
6. Provisions that give both parties of the agreement the authority to act.
7. Specific rates of pay shall be established for the supplemental agreement in the same manner as described in [Section 31.42](#), Agreement Types/Payment Options, Sub-Part d, Specific Rates of Pay.

.53 Patent or Royalty Rights – Agreements that involve research, developmental, experimental, or demonstration work may include patent or royalty rights. In this case, the Consultant Agreement should be supplemented by adding the appropriate language to account for this. The Region Local Programs Engineer is to be contacted for assistance in developing these supplemental agreements.

.54 Risk Management and Added Insurance Requirements – The Agency may change Section XII of the Consultant Agreement to reduce the requirement for the Consultant Professional Liability from one million dollars to the amount of the Agreement; whichever is the lesser of the two. This should be done for work that involves minimal risk, such as studies. For many consultant firms, covering the one million dollar liability would be an added cost to their overhead or directly to the project.

In the event the Agency determines that added liabilities or an insurance policy are warranted beyond the amount allowed in the consultant agreement, they should negotiate this with the Consultant after the selection process is complete. This ensures that engineering qualifications, rather than the ability to obtain insurance, is the criteria for selection.

The Agency will determine the sufficiency of insurance normally provided within the consultant's overhead costs, and will identify the costs beyond that amount on Exhibit H. This exhibit is not needed if the consultant agreement provisions are used.

These costs will be considered direct project costs, and will not be billed to an FHWA funded project. In the event that Exhibit H is warranted, it should be sent with the risk analysis to the Region Local Programs Engineer for approval, who will forward it to Headquarters for review, prior to execution by the Agency and the consultant.

The Agency risk analysis should show that the work warrants this added cost and that consideration has been given to less costly solutions, including assuming the risk; insuring the risk outside of the agreement as an Agency cost; or adding a third tier of engineering overview to check the work.

To calculate the risk requires an ability to judge the likely amount of a jury's award if liability is determined. A suggested method is to determine the number of comparative cases presently existing within this state and to develop the probabilities based upon historic awards.

31.6 Indirect Cost Rates

The Agency will utilize a consultant's Indirect Cost Rate (ICR) that is compliant with 48 CFR Part 31 of the Federal Acquisition Regulation (FAR), or has been approved through the Safe Harbor Indirect Cost Rate Pilot Program.

"Indirect cost rates shall be updated on an annual basis in accordance with the consultant's annual accounting period and in compliance with the Federal cost principles." 23 CFR 172.11(b)(1)

Once the ICR is established, "A consultant's accepted indirect cost rate for its 1-year applicable accounting period shall be applied to contracts; however, once an indirect cost rate is established for a contract, it may be extended beyond the 1-year applicable period, through the duration of the specific contract, provided all concerned parties agree. Agreement to the extension of the 1-year applicable period shall not be a condition or qualification to be considered for the work or contract award." 23 CFR 172.11(b)(3)(vi)

If a consultant does not have a FAR compliant ICR, it is their responsibility to review the eligibility requirements of the Safe Harbor program (www.wsdot.wa.gov/Audit/SafeHarbor.htm).

Consulting firms that use the Safe Harbor Rate will still be required to have an accounting system capable of accumulating and tracking direct labor and other direct costs by contract, segregating indirect costs, and removing unallowable costs. These basic accounting system functions are essential for accurate billing of costs under a cost-reimbursement contract. Additionally, the expectation will be for the firm to establish a cost history for the eventual development of a FAR compliant indirect cost rate for the firm, based on actual cost data.

Consultants who do not qualify or choose not to enroll in the Safe Harbor will be subject to a review by the WSDOT Consultant Service Office (CSO). CSO will utilize a risk assessment process to provide WSDOT the necessary assurance that the consultant's accounting practices are FAR compliant. There are multiple tools that consultants may submit to assist CSO review such as the following:

- An audit conducted by another governmental agency that conforms to 48 CFR Part 31;
- An audit conducted by an independent CPA that conforms to 48 CFR Part 31
- A WSDOT approved ICR provided by the Internal Audit Office (IAO)

If the consultant does not have any of the above, the consultant may submit their ICR schedule to the CSO for review. The CSO will perform a review of the consultant's proposed rate using the 48 CFR part 31 to adjust line item costs on the ICR and determine a provisional ICR rate. The CSO will notify the consultant of these adjustments. The consultant will decide whether these adjustments are fair and reasonable and notify the CSO whether they agree or disagree with the determination.

If the consultant does not have an ICR, the CSO may establish a provisional ICR of 100% and a recommended fixed fee of 10% or less of direct labor and overhead. This rate would be effective from the end of the consultant's fiscal year plus 180 days.

During that time it is expected that the consultant will develop an ICR which would conform to the requirement outlined in 48 CFR Part 31. Each firm has the option of providing an Indirect Cost Rate or qualifying for the Safe Harbor program. Please choose one of those options listed below and provide the documentation listed with your request for a rate. Incomplete submission of documents for review will not be evaluated.

For the Safe Harbor Program

Documents needed include:

- Labor Checklist
- Examples of timesheets
 - For smaller firms – one for each person

Link to Safe Harbor: www.wsdot.wa.gov/Audit/SafeHarbor.htm

CSO review of an Indirect Cost Rate

Documents needed include:

- Indirect Cost Rate Schedule (ICR)
- FHWA Certification Document
- Consultant Information Worksheet
- Timesheet & Labor System Checklist

All requests for the Safe Harbor Program or for an Indirect Cost Rate review must be sent to ConsultantRates@wsdot.wa.gov, include the words "Local Programs" in the subject line of your email. The following information must also be included:

- Number of active local agency contracts, including the contract amount.
- Number of local agency contracts, including the contract amount for the previous fiscal year.

The documents listed above are available at www.wsdot.wa.gov/localprograms.

31.7 Submittal of Consultant Contract Data

After the execution of the consultant contract, the local agency must submit the following information to the Region Local Program Engineer within **30 days** of execution:

- A signed copy of the Local Agency Consultant Agreement
- Exhibit B – DBE Participation
- Exhibit D – Prime Consultant Cost Computations
- Exhibit E – Sub-consultant Cost Computations
- Diversity Management & Compliance System (DMCS) contact information as follows,

Agency	Contractor
Name:	Name:
Title:	Title:
Phone:	Phone:
Email:	Email:

Failure to submit the above listed information, before work begins, will result in delay of reimbursement of the billed cost, until the information is received.

31.8 Oversight of the Agreement and Project Closure

The Local Agency shall assign one of its personnel as project administrator to work with the consultant. The project administrator's responsibilities are to:

1. Prepare supplements to existing agreements for services beyond the scope of the original agreement and include the Agency's independent estimate of the costs for the work involved.
2. Ensure that no work is done or costs incurred until the agreements and supplements are approved by the approving authority and executed by the proper parties.
3. Conduct regular meetings with the consultant to track progress, evaluate consultant's progress in achieving its commitments as identified in its DBE Participation Plan, and identify potential concerns.
4. Act as a liaison between the Agency and the consultant to assure compliance with the terms of the agreement, including OEO provisions and the use of mandatory forms.
5. Monitor the consultant's progress reports to ensure that problem areas are reported and corrective action taken.
6. Make sure that all work is within the agreement's scope of work.
7. Establish controls to monitor the time for completion of the agreement to ensure that the specified time limitations are not exceeded.
8. Ensure the accuracy of bills presented by the consultant and their consistency with the work performed.

9. Maintain cumulative cost records to assure that costs are allowable, allocable, and reasonable. Track bills to ensure compliance with agreement and fixed fees.
10. Review bills to ensure that the appropriate Indirect Cost Rate is being applied.
11. Establish controls to prevent overpayment of the agreement.
12. Enter monthly payments received from Local Agency and payments made to all firms into the WSDOT Diversity Management and Compliance System – DMCS (wsdot.diversitycompliance.com).
13. Monitor the DBE's for the duration of the agreement (i.e., conduct DBE on-site reviews). The Local Agency must comply with the requirements as described in Chapter 26. Termination or substitution of DBE's shall be submitted to the Region Local Program Engineer for concurrence prior to executing the contract supplement.
14. Ensure that all terms and conditions of the agreement have been met prior to final release of the consultant.

.81 Invoicing – The invoice will include the following:

1. All employees who worked on the project during the billing period;
2. The classification of each employee, the hours worked, the actual hourly payroll rate, and the amount billed; and
3. Direct nonsalary costs. Nonsalary costs should be supported for auditing purposes by copies of the invoice or billing instruments the consultant received for payment. Either the consultant or the Agency may retain these copies.

The Local Agency may disallow claimed cost, which are not adequately supported by documentation.

.82 Documentation – Original documents may include but are not limited to signed time sheets, invoices, payroll records, rental slips, and gasoline tickets that support the costs billed to WSDOT. In compliance with 48 CFR part 31, the consultant is responsible for maintaining records, including supporting documentation that costs claimed have been incurred and are allocable to the agreement. Time sheets should document hours worked, the billing rate of pay, and must be signed by the supervisor or his designee and the employee. Records will be retained for a period of three years after receipt of final payment.

.83 Closure – Upon completion of the work under the consultant agreement, the Agency will ensure that all terms, conditions of the agreement have been complied with and that all services to be performed under the agreement have been completed prior to final release of the consultant. The Local Agency should evaluate the consultant's performance and retain this in their records (see [Appendix 31.96](#)).

.84 Alleged Consultant Design Error – There may be times during a construction contract that a potential error or omission in the design is discovered. Other times an error or omission is discovered after the work is completed. [Appendix 31.97](#) establishes the procedures to follow if this occurs.

.85 Consultant Claim Procedures – Most contract claims are based on requests for additional payment beyond was agreed to when the consultant agreement was executed. There are two circumstances that usually lead to this request:

- The first is when the consultant’s understanding of the consultant agreement expectations is different than that of the local agency.
- The second is when the consultant has been asked, or believes they have been asked, to perform work outside the original scope work.

[Appendix 31.98](#) outlines the procedures to be followed by both the consultant and the agency to consider a potential claim.

31.9 Appendices

- [31.91](#) Advertisement – Example
- [31.92\(a\)](#) Submittal Information Form (Prime)
- [31.92\(b\)](#) Submittal Information Form (Subconsultant)
- [31.93](#) Request for Sole Source Consultant Services
- [31.94](#) Independent Estimate for Consulting Services
- [31.95](#) Record of Negotiations – Example
- [31.96](#) Performance Evaluation Consultant Services
- [31.97](#) Alleged Consultant Design Error Procedures
- [31.98](#) Consultant Claim Procedures
- [31.99](#) Consultant Draft scope and Independent Cost Estimate example

Appendix 31.91 Advertisement – Example

(AGENCY NAME) NOTICE TO CONSULTANTS FOR (PROJECT NAME)

The (AGENCY NAME) solicits interest from consulting firms with expertise in Civil and Structural Engineering Design. This agreement will be for approximately (TIME FRAME) in duration with the option for the (AGENCY NAME) to extend it for additional time and money if necessary. Consultants will be considered for the following project.

The (AGENCY NAME) reserves the right to amend terms of this “Request for Qualifications” (RFQ) to circulate various addenda, or to withdraw the RFQ at any time, regardless of how much time and effort consultants have spent on their responses.

Project Description

The work to be performed by the CONSULTANT consists of preparing preliminary engineering design for improvements to 36th Street East to Rainier Boulevard East. The proposed improvements include widening the road to accommodate four lanes of traffic, improving intersection radii, increasing left turn storage, revisions to existing signal systems in order to accommodate the proposed improvements, and construction of retaining walls to provide for roadway widening. This project has (*insert assigned UDBE agreement goal, if a voluntary goal was assigned, insert Voluntary 10% SBE*) goal. The major features of the project are as follows:

- Approximately 1.74 miles of widening for two additional lanes.
- Improving intersection radii to meet design standards.
- Environmental documentation and preparation of permit applications.
- Signal modifications and design.
- Structural design for retaining walls and culvert extensions/replacements.
- Determination of R/W needs and R/W plan preparation.

The (AGENCY NAME) reserves the right to retain the services of the successful firm(s) for any subsequent phases (R/W, CN) associated with this/these project(s).

Evaluation Criteria

Submittals will be evaluated and ranked based on the following criteria:

- 1) Qualification of Proposed Project Manager
- 2) Qualifications/Expertise of Firm
- 3) Ability to meet schedule
- 4) Approach to project
- 5) Familiarity with WSDOT/FHWA standards
- 6) Past Performance/References
- 7) Approach to meet the DBE goal or SBE goal (DBE Participation Plan or SBE Plan)

Submittal

Submittals should include the following information: Firm name, phone and fax numbers; Name of Principal-in-Charge and Project Manager; and Number of employees in each firm proposed to project.

DOT 140-564
5/2019

Page 1 of 2

Please submit FOUR copies of your Statement of Qualifications to: (*AGENCY NAME, ADDRESS, and CONTACT PERSON*) no later than 10:00 a.m. on June 28, 2015. Submittals will not be accepted after that time and date. Any questions regarding this project should be directed to (*AGENCY CONTACT PERSON*), at (*AGENCY PHONE*).

Americans with Disabilities Act (ADA) Information

The (*AGENCY NAME*) in accordance with Section 504 of the Rehabilitation Act (Section 504) and the Americans with Disabilities Act (ADA), commits to nondiscrimination on the basis of disability, in all of its programs and activities. This material can be made available in an alternate format by emailing (*AGENCY CONTACT PERSON*) at (*EMAIL ADDRESS*) or by calling collect (*AGENCY PHONE*).

Title VI Statement

The (*AGENCY NAME*) in accordance with Title VI of the Civil Rights Act of 1964, 78 Stat. 252, 42 U.S.C. 2000d to 2000d-4 and Title 49, Code of Federal Regulations, Department of Transportation, subtitle A, Office of the Secretary, Part 21, nondiscrimination in federally assisted programs of the Department of Transportation issued pursuant to such Act, hereby notifies all bidders that it will affirmatively ensure that in any contract entered into pursuant to this advertisement, disadvantaged business enterprises as defined at 49 CFR Part 26 will be afforded full opportunity to submit bids in response to this invitation and will not be discriminated against on the grounds of race, color, national origin, or sex in consideration for an award.”

Dates of publication in the (*NEWSPAPER of RECORD*): (*Date of first publication*), and (*Date of second publication*).

Appendix 31.92(a) Submittal Information Form (Prime)

Submittal Information Form (Prime)

Project Name or Roster Category: Click here to enter text.

Prime

Firm Name: Click here to enter text.

Address: Click here to enter text.

Phone: Click here to enter text.

Fax: Click here to enter text.

Company Website: Click here to enter text.

Federal Tax ID Number: Click here to enter text.

Unified Business Identifier Number: Click here to enter text.

D/M/WBE Certification Number: Click here to enter text.

Year Firm Established: Click here to enter text.

SIC Code (Name): Click here to enter text.

NAICS Code (Name): Click here to enter text.

Contact Person Regarding This Submittal's Information: Click here to enter text.

Firm Type

- | | | |
|--|---|--|
| <input type="checkbox"/> Sole Proprietor | <input type="checkbox"/> Partnership | <input type="checkbox"/> C – Corp. |
| <input type="checkbox"/> Limited Partnership | <input type="checkbox"/> Subchapter S Corp. | <input type="checkbox"/> Limited Liability Company |

Annual Gross Receipt

- | | | |
|---|---|--|
| <input type="checkbox"/> \$0 to \$1 Million | <input type="checkbox"/> \$1 Million to \$5 Million | <input type="checkbox"/> \$5 Million to \$10 Million |
| <input type="checkbox"/> \$10 Million to \$15 Million | <input type="checkbox"/> Over \$15 Million | |

Firms Areas of Expertise

Click here to enter text.

Note:

Firm Name: Please ensure that the firm name listed is the same firm name that is legally assigned to the federal tax ID number. Please **do not** use: DBA's – Doing Business As; Combination names when two firms are working together; derivatives of your legal name; Acronyms; etc.

Unified Business Identifier (UBI) Number: If your firm does not have a UBI number for Washington State, please put pending in the box. You will be required to acquire a UBI Number if you are awarded the contract.

Appendix 31.92(b) Submittal Information Form (Subconsultant)



**Washington State
Department of Transportation**

True Cost Parcel Worksheet

Project: [Click here to enter text.](#)

Parcel # [Click here to enter text.](#)

Notes: [Click here to enter text.](#)

Assessor's Tax Parcel Number(s): [Click here to enter text.](#)

Zone Size Min. = [Click here to enter text.](#)

Assessed Value Land = [Click here to enter text.](#)

A.V. Bldg.#1 = [Click here to enter text.](#) Bldg.#2 = [Click here to enter text.](#) Bldg.#3 = [Click here to enter text.](#)

Bldg.#4 = [Click here to enter text.](#)

Total Property Assessed Value = [Click here to enter text.](#)

R/W Map Info

Before Area = [Click here to enter text.](#) Fee Take = [Click here to enter text.](#) After Area = [Click here to enter text.](#)

Permanent Esmt Take = [Click here to enter text.](#)

Temporary Esmt Take = [Click here to enter text.](#)

Property Costs:

Total Take = [Click here to enter text.](#) (total property A.V. x 1.20) = \$ [Click here to enter text.](#)

Or

Or

Partial Take:

Fee Land = [Click here to enter text.](#) @ \$ [Click here to enter text.](#) (A.V. land per unit) x 1.20 = \$ [Click here to enter text.](#)

Yard/Site Improvements in Take @ Administrative Lump Sum = \$ [Click here to enter text.](#)

Major Building in Take @ (A.V. of Bldg. # [Click here to enter text.](#)) x 1.20 = \$ [Click here to enter text.](#)

Perm. Esmt. = [Click here to enter text.](#) @ \$ [Click here to enter text.](#) (A.V. land per unit) = \$ [Click here to enter text.](#)

Temp. Esmt. = [Click here to enter text.](#) @ \$ [Click here to enter text.](#) (A.V. land per unit) x 10% = \$ [Click here to enter text.](#)

TOTAL PROPERTY COSTS (put in column 2 of True Cost) = \$ [Click here to enter text.](#)

Administrative Costs (put in respective columns of True Cost):

- | | |
|---|--|
| 1. Appraisal Fee = Click here to enter text. | 5. Prop. Mgmt. Services = Click here to enter text. |
| 2. Appraisal Review Fee = Click here to enter text. | 6. Relocation Services = Click here to enter text. |
| 3. Negotiation Fee = Click here to enter text. | 7. Relocation Payments = Click here to enter text. |
| 4. Title and Escrow Fee = Click here to enter text. | 8. Condemn & Incidentals = Click here to enter text. |

True Cost Estimate

1 Parcel Number	2 Just Compen (Offer)	3 Appraisal Fee Costs	4 Appraisal Review Fee Costs	5 Negotiation Fee Costs	6 Title, Escrow Costs	7 Prop. Mgmt. Service Costs	8 Relocation Service Costs	9 Relocation Payments	10 Condemn. and Incid. Costs	11 Total Parcel Costs
Total R/W Costs										

Project: [Click here to enter text.](#) **FA #:** [Click here to enter text.](#)

Date: [Click here to enter text.](#)

Appendix 31.93 Request for Sole Source Consultant Services

Request for Sole Source Consultant Services

Checklist for Submitting a Request for Sole Source Consulting Services (Adapted in part from a WSDOT Memorandum: Request for Consultant Services, A&E Services Project Specific Sole Source)

The following checklist must be provided with requests to use sole source consultant services, rather than competitive bid procedures, on a project:

Agency: [Click here to enter text.](#)

Date: [Click here to enter text.](#)

Project Title: [Click here to enter text.](#)

Federal-Aid Number: [Click here to enter text.](#)

1. Checklist for a Supplement to an Existing Agreement

Description of the Existing Project:

Initials	Date or N/A	Checklist Items for a Supplement to an Existing Agreement
		Date the project was originally advertised.
		Date the original Agreement was executed.
		Completion date of the original Agreement.
		Total dollar amount of the original Agreement Click here to enter text.
		Date Supplemental Agreement Number 1 was executed.
		Completion date of Supplemental Agreement Number 1.
		Total dollar amount of Supplemental Agreement Number 1.
		Describe the reason(s) for Supplemental Agreement Number 1.

(Note: Using an electronic form of this checklist, provide the above information for each existing Supplemental Agreement, numbering the Supplements sequentially.)

2. Checklist for Both a New Agreement and Supplement to an Existing Agreement

Initials	Date or N/A	Checklist Items – New and Supplements to Agreements
		Describe the proposed project for the Sole Source Agreement: Click here to enter text.
		State the specific intended purpose of the Agreement and describe the services and/or deliverables that are needed: (Note: If two or more phases of work are anticipated, describe each phase separately.) Click here to enter text.
		Date that the sole source consulting services are desired. Click here to enter text.
		Duration of work/phase 1 of work Click here to enter text.

Initials	Date or N/A	Checklist Items – New and Supplements to Agreements
		<p><i>(Repeat this line for each phase of work, numbering them sequentially.)</i></p> <p>Describe the funding sources of the project (including participation percentages):</p> <p>Click here to enter text.</p>
		<p>Provide the estimated cost of the services that will be performed by the sole source consultant:</p> <p>Click here to enter text.</p>
		<p>Provide the estimated cost of services to be provided by a subconsultant:</p> <p>Click here to enter text.</p>
		<p>Describe the work to be performed by a subconsultant:</p> <p>Click here to enter text.</p>
		<p>Provide justification for the use of sole source consultant services (i.e., how it was determined that competitive procurement is not appropriate for this project) by giving an explanation to the items listed below:</p> <p>Click here to enter text.</p>
		<p>Describe the unique nature of the services and/or the unique qualifications, abilities or expertise of the consultant to meet the agency's needs (e.g., describe how they are highly specialized or one-of-a-kind, include other factors which may be considered, such as what is their past performance, cost effectiveness [learning curve], and /or the follow-up nature of the required services):</p> <p>Click here to enter text.</p>
		<p>Describe other special circumstances which may be relevant, such as confidential investigations, copyright restrictions or time constraints. If time constraints are applicable, identify when the agency was on notice of the need for the services and the entity that imposed the constraints, explain the authority (if not obvious) of the entity to impose them, and provide the timelines within which the work must be accomplished.</p> <p>Click here to enter text.</p>
		<p>Describe the availability of consultants in the location required (e.g., if the proposed consultant is the only source available in the geographical area, state the basis for this conclusion and the rationale for limiting the size of the geographical area selected):</p> <p>Click here to enter text.</p>
		<p>Disadvantaged Business Enterprise (DBE) goals may apply on a federally funded project. Explain reason(s) for waiving DBE participation goals:</p> <p>Click here to enter text.</p>

Agency

Signature of Agency Official

Date

Recommended Approval

Region Local Programs Engineer

Date

Approval

Local Programs

Date

Appendix 31.94 Independent Estimate for Consulting Services

Independent Estimate For Consultant Services Worksheet

Agency:	Federal Project No.:
Project Name:	
Prepared By:	Date:

Type of Services	Estimated Cost	Comments
Planning		
Surveying		
Project Management		
Geotechnical Engineering		
Geometrics / Hydraulics Engineering		
Structural Engineering		
Traffic Engineering		
Environmental & permitting		
Public Involvement		
Real Estates Services		
Architectural Services		
Mechanical / Electrical Engineering		
Construction Management		

Total \$0.00

Indirect Cost Rate Cost (in percent) _____ \$0.00
 Fix Fee (in percent) _____ \$0.00

Reimbursable

A. Travel and Per Diem _____
 B. Reproduction Expenses _____
 C. Computer Expense _____
 D. Communication _____
 E. Sampling and Testing _____
 F. Outside Consultants _____
 G. Other _____
 Total: \$0.00

Sub-Total \$0.00

*Contingencies _____ \$0.00

* Use only on Cost plus Fix Fee agreement **Grand Total** **\$0.00**

Appendix 31.95 Record of Negotiations – Example

Name and Job Title: John Doe, PW Contracts Manager

----- (signature)

Action	Date
1. Consulting firm of Acme Consulting selected.	2/15/99
2. Independent cost estimate of \$953,000.00 prepared by agency to address the following*: Develop design for Timermann Rd. Realignment from MP 53 to MP 57; including pre-engineering services of biological assessment, & NEPA/SEPA documentation.	2/25/99
3. Meeting held with consultant to ensure thorough understanding of the scope of work.	2/20/99
4. Consultant provided scope of work; request for proposal solicited.	2/15/99
5. Consultant submitted proposal in the amount of \$1,203,000.00.	2/27/99
6. Agency compared proposal with independent estimate and negotiation objectives were established	3/3/99
7. Agency negotiator contacted/met with the consultant and identified the following as items which needed revision (i.e., excessive or insufficient principal/ management involvement, high overhead, unallowable costs). **Mark-ups on two subconsultants for environmental work not allowable; overhead rate of 35 percent too high based on nature of the work and degree of risk; consultant management and principal attendance redundant at meetings; subconsultant time excessive*	3/5/99
8. Agency revised detailed cost estimate based on negotiations.**	3/15/99
9. Consultant submitted revised proposal with following changes: ** Removed \$53,000 in subconsultant mark-ups; overhead rate reduced to 26 percent; reduced management attendance with principal to two meetings.*	3/20/99
10. Agency accepted final fee proposal of \$1,000,000.00 to address the following: Develop design for Timermann Rd. Realignment from MP 53 to MP 57; including pre-engineering services of biological assessment, and NEPA/SEPA documentation to be completed by Ace Engineering Services as subconsultant.*	3/23/99
11. <i>(or alternately) Agency could not agree to final proposal and notified the consultant in writing of this fact.</i>	3/23/99

The negotiations were conducted in good faith to ensure the fees were fair and reasonable. The procedures outlined in this manual were followed.

*Additional detail should be expanded upon with documentation.

**These steps should be repeated as often as necessary, with documentation.

This example has been simplified and does not include the level of detail typically found in a complete record of negotiations.

Performance Evaluation Instructions

How

- Form should be reviewed and discussed with the Consultant prior to contract negotiations. Establish your expectations.
- Supplementary forms are available from the Consultant Services Office which expand the considerations for each criteria (e.g. "Schedule: A. Achieved schedule; B. Prompt response to review comments; C. Adapted to changes by WSDOT; D. Notified WSDOT early, regarding schedule impactors").
- If evaluation criterion number 7, "Other" is relevant (e.g. public involvement or volume of work) that criterion must be specified and mutually agreeable in advance.
- Score accurately. A "7" is respectable; "9" is exceptional, it should be rare.

When

Final Evaluation

- Always complete and distribute a performance evaluation at the point of termination of the agreement.
- See distribution at bottom of form.

Interim Evaluation

- Interim evaluations should be performed as follows:
 1. At phase transitions.
 2. When any project management changes occur.
 3. To alert a consultant to poor performance.
 4. Annually if none of the other conditions occur.
- Distribute as usual.

Subconsultant Evaluation

- For subconsultants with significant project participation (more than \$100,000) an evaluation is recommended. Ensure coordination and review with the prime consultant prior to distribution.
- Distribute similar to usual. Include prime consultant and subconsultant.

Why

- Scores from these evaluations factor into "Past Performance" ratings, which are used to help determine selection of future consultants. Meaningful evaluations help us hire the best.

Performance Evaluation Instructions

How

- Form should be reviewed and discussed with the Consultant prior to contract negotiations. Establish your expectations.
- Supplementary forms are available from the Consultant Services Office which expand the considerations for each criteria (e.g. "Schedule: A. Achieved schedule; B. Prompt response to review comments; C. Adapted to changes by WSDOT; D. Notified WSDOT early, regarding schedule impactors").
- If evaluation criterion number 7, "Other" is relevant (e.g. public involvement or volume of work) that criterion must be specified and mutually agreeable in advance.
- Score accurately. A "7" is respectable; "9" is exceptional, it should be rare.

When

Final Evaluation

- Always complete and distribute a performance evaluation at the point of termination of the agreement.
- See distribution at bottom of form.

Interim Evaluation

- Interim evaluations should be performed as follows:
 1. At phase transitions.
 2. When any project management changes occur.
 3. To alert a consultant to poor performance.
 4. Annually if none of the other conditions occur.
- Distribute as usual.

Subconsultant Evaluation

- For subconsultants with significant project participation (more than \$100,000) an evaluation is recommended. Ensure coordination and review with the prime consultant prior to distribution.
- Distribute similar to usual. Include prime consultant and subconsultant.

Why

- Scores from these evaluations factor into "Past Performance" ratings, which are used to help determine selection of future consultants. Meaningful evaluations help us hire the best.



Consultant Services Evaluation Supplement

Consultant Name	Evaluation Type <input type="checkbox"/> Interim <input type="checkbox"/> Subconsultant <input type="checkbox"/> Final
Consultant Address	Project Title
	Agreement Number
Performance Rating Scale (From Average Scores)	
$\frac{10}{\text{Superior}}$ $\frac{9}{\text{Above Reqmnts}}$ $\frac{8}{\text{Meets Reqmnts}}$ $\frac{5}{\text{Below Reqmnts}}$ $\frac{2}{\text{Poor}}$ $\frac{1}{\text{Poor}}$	

Negotiation and Cost / Budget Criteria

1. Negotiations	
Sub-Criteria	Score
A. Adhered to WSDOT guidelines on fee.	
B. Met negotiation schedule.	
C. Open and honest communications.	
D. Willingness to compromise.	
E.	
F.	
Total Score	
Average Score (Total Score / Number of sub-criteria rated)	
Comments	

2. Cost / Budget	
Sub-Criteria	Score
A. Finished within budget, including all supplements.	
B. Appropriate level of effort.	
C. Reasonable direct, non-salary expenses.	
D.	
E.	
F.	
Total Score	
Average Score (Total Score / Number of sub-criteria rated)	
Comments	

Schedule and Technical Quality Criteria

Consultant Name	Agreement Number
-----------------	------------------

3. Schedule	
Sub-Criteria	Score
A. Achieved schedule (Including all supplements).	
B. Prompt response to review comments.	
C. Adapted to changes by WSDOT.	
D. Notified WSDOT early regarding schedule "impactors."	
E.	
F.	
Total Score	
Average Score (Total Score / Number of sub-criteria rated)	
Comments:	

4. Technical Quality	
Sub-Criteria	Score
A. Work products meet standards; where "practical."	
B. Performed appropriate quality control.	
C. Responds to review comments in subsequent submission.	
D. Sought opportunities to incorporate innovative designs.	
E. Delivered "compatible" electronic files.	
F. Implemented procedures to control construction costs.	
G.	
H.	
Total Score	
Average Score (Total Score / Number of sub-criteria rated)	
Comments:	

Communication and Management Criteria

Consultant Name	Agreement Number
-----------------	------------------

5. Communications	
Sub-Criteria	Score
A. Produced clear, concise oral and written communication.	
B. Demonstrates an understanding of oral and written instructions.	
C. Communicated at intervals appropriate for the work.	
D. Respects and uses lines of communications.	
E.	
F.	
G.	
Total Score	
Average Score (Total Score / Number of sub-criteria rated)	
Comments:	

6. Management	
Sub-Criteria	Score
A. Provided creative cost control measures / ideas.	
B. Submitted appropriate, periodic, accurate progress reports.	
C. Accurate and timely invoicing.	
D. Conducted meetings efficiently.	
E. Limited the number of consultant-initiated contract modifications / supplements.	
F. Coordinated with WSDOT effectively; was a "team player."	
G. Responsive	
H. Managed subconsultants effectively.	
I.	
J.	
Total Score	
Average Score (Total Score / Number of sub-criteria rated)	
Comments:	

Appendix 31.97 Alleged Consultant Design Error Procedures

The purpose of this appendix is to establish a procedure to determine if a consultant's alleged design error is of a nature that exceeds the accepted standard of care. In addition, it will establish a uniform method for the resolution and/or cost recovery procedures in those instances where the agency believes it has suffered some material damage due to the alleged error by the consultant.

Step 1 Potential Consultant Design Error(s) is Identified by Agency's Project Manager

At the first indication of potential consultant design error(s), the first step in the process is for the Agency's project manager to notify the Director of Public Works or Agency Engineer regarding the potential design error(s). For federally funded projects, the Region Local Programs Engineer should be informed and involved in these procedures. (**Note:** The Director of Public Works or Agency Engineer may appoint an agency staff person other than the project manager, who has not been as directly involved in the project, to be responsible for the remaining steps in these procedures.)

Step 2 Project Manager Documents the Alleged Consultant Design Error(s)

After discussion of the alleged design error(s) and the magnitude of the alleged error(s), and with the Director of Public Works or Agency Engineer's concurrence, the project manager obtains more detailed documentation than is normally required on the project. Examples include: all decisions and descriptions of work; photographs, records of labor, materials and equipment.

Step 3 Contact the Consultant Regarding the Alleged Design Error(s)

If it is determined that there is a need to proceed further, the next step in the process is for the project manager to contact the consultant regarding the alleged design error(s) and the magnitude of the alleged error(s). The project manager and other appropriate agency staff should represent the agency and the consultant should be represented by their project manager and any personnel (including sub-consultants) deemed appropriate for the alleged design error(s) issue.

Step 4 Attempt to Resolve Alleged Design Error with Consultant

After the meeting(s) with the consultant have been completed regarding the consultant's alleged design error(s), there are three possible scenarios:

- It is determined via mutual agreement that there is not a consultant design error(s). If this is the case, then the process will not proceed beyond this point.
- It is determined via mutual agreement that a consultant design error(s) occurred. If this is the case, then the Director of Public Works or Agency Engineer, or their representatives, negotiate a settlement with the consultant. The settlement would be paid to the agency or the amount would be reduced from the consultant's agreement with the agency for the services on the project in which the design error took place. The agency is to provide LP, through the Region Local Programs Engineer, a summary of the settlement for review and to make adjustments, if any, as to how the settlement affects federal reimbursements. No further action is required.
- There is not a mutual agreement regarding the alleged consultant design error(s). The consultant may request that the alleged design error(s) issue be forwarded to the Director of Public Works or Agency Engineer for review. If the Director of Public Works or Agency Engineer, after review with their legal counsel, is not able to reach mutual agreement with the consultant, proceed to Step 5.

Step 5 Forward Documents to Local Programs

For federally funded projects all available information, including costs, should be forwarded through the Region Local Programs Engineer to LP for their review and consultation with the FHWA. LP will meet with representatives of the agency and the consultant to review the alleged design error(s), and attempt to find a resolution to the issue. If necessary, LP will request assistance from the Attorney General's Office for legal interpretation. LP will also identify how the alleged error(s) affects eligibility of project costs for federal reimbursement.

- If mutual agreement is reached, the agency and consultant adjust the scope of work and costs to reflect the agreed upon resolution. LP, in consultation with FHWA, will identify the amount of federal participation in the agreed upon resolution of the issue.
- If mutual agreement is not reached, the agency and consultant may seek settlement by arbitration or by litigation.

Appendix 31.98 Consultant Claim Procedures

The purpose of this appendix is to describe a procedure regarding claim(s) on a consultant agreement. The following procedures should only be utilized on consultant claims greater than \$1,000. If the consultant's claim(s) are a total of \$1,000 or less, it would not be cost effective to proceed through the outlined steps. It is suggested that the Director of Public Works or Agency Engineer negotiate a fair and reasonable price for the consultant's claim(s) that total \$1,000 or less.

This appendix will outline the procedures to be followed by the consultant and the agency to consider a potential claim by the consultant.

Step 1 Consultant Files a Claim with the Agency Project Manager

If the consultant determines that they were requested to perform additional services that were outside of the agreement's scope of work, they may be entitled to a claim. The first step that must be completed is the request for consideration of the claim to the Agency's project manager.

The consultant's claim must outline the following:

- Summation of hours by classification for each firm that is included in the claim;
- Any correspondence that directed the consultant to perform the additional work;
- Timeframe of the additional work that was outside of the project scope;
- Summary of direct labor dollars, overhead costs, profit and reimbursable costs associated with the additional work; and
- Explanation as to why the consultant believes the additional work was outside of the agreement scope of work.

Step 2 Review by Agency Personnel Regarding the Consultant's Claim for Additional Compensation

After the consultant has completed step 1, the next step in the process is to forward the request to the Agency's project manager. The project manager will review the consultant's claim and will meet with the Director of Public Works or Agency Engineer to determine if the Agency agrees with the claim. If the FHWA is participating in the project's funding, forward a copy of the consultant's claim and the Agency's recommendation for federal participation in the claim to the WSDOT Local Programs through the Region Local Programs Engineer. If the claim is not eligible for federal participation, payment will need to be from agency funds.

If the Agency project manager, Director of Public Works or Agency Engineer, WSDOT Local Programs (if applicable), and FHWA (if applicable) agree with the consultant's claim, send a request memo, including backup documentation to the consultant to either supplement the agreement, or create a new agreement for the claim. After the request has been approved, the Agency shall write the supplement and/or new agreement and pay the consultant the amount of the claim. Inform the consultant that the final payment for the agreement is subject to audit. No further action is needed regarding the claim procedures.

If the Agency does not agree with the consultant's claim, proceed to step 3 of the procedures.

Step 3 Preparation of Support Documentation Regarding Consultant's Claim(s)

If the Agency does not agree with the consultant's claim, the project manager shall prepare a summary for the Director of Public Works or Agency Engineer that included the following:

- Copy of information supplied by the consultant regarding the claim;
- Agency's summation of hours by classification for each firm that should be included in the claim;
- Any correspondence that directed the consultant to perform the additional work;
- Agency's summary of direct labor dollars, overhead costs, profit and reimbursable costs associated with the additional work;
- Explanation regarding those areas in which the Agency does/does not agree with the consultant's claim(s);
- Explanation to describe what has been instituted to preclude future consultant claim(s); and
- Recommendations to resolve the claim.

Step 4 Director of Public Works or Agency Engineer Reviews Consultant Claim and Agency Documentation

The Director of Public Works or Agency Engineer shall review and administratively approve or disapprove the claim, or portions thereof, which may include getting Agency Council or Commission approval (as appropriate to agency dispute resolution procedures). If the project involves federal participation, obtain concurrence from WSDOT Local Programs and FHWA regarding final settlement of the claim. If the claim is not eligible for federal participation, payment will need to be from agency funds.

Step 5 Informing Consultant of Decision Regarding the Claim

The Director of Public Works or Agency Engineer shall notify (in writing) the consultant of their final decision regarding the consultant's claim(s). Include the final dollar amount of the accepted claim(s) and rationale utilized for the decision.

Step 6 Preparation of Supplement or New Agreement for the Consultant's Claim(s)

The agency shall write the supplement and/or new agreement and pay the consultant the amount of the claim. Inform the consultant that the final payment for the agreement is subject to audit.

Appendix 31.99

Consultant Draft scope and Independent Cost Estimate example

Independent Estimate For Consultant Services Worksheet

Agency:	Example	Federal Project No.:	xxxx(xxx)
Project Name:	Main Street Safety Improvements		
Prepared By:	Project Engineer	Date:	10/31/16

Draft Project Scope:

- Approximately 1.74 miles of widening for two additional lanes on Main Street
- Improving intersection radii to meet design standards and ADA
- Environmental documentation and preparation of permits
- Structural design for retaining walls
- Construction administration

Type of Services	Estimated Cost	Comments
Planning		
Surveying	\$3,600.00	2-person crew / one week
Project Management	\$15,740.00	10% of project
Geotechnical Engineering		
Geometrics / Hydraulics Engineering	\$90,000.00	3-person team / 15 weeks
Structural Engineering	\$9,600.00	Walls / 1-person 4 weeks
Traffic Engineering	\$2,200.00	WZTC - 1 person 1 week
Environmental & permitting	\$10,000.00	NEPA/Section 106/Permits
Public Involvement		
Real Estates Services		
Architectural Services		
Mechanical / Electrical Engineering		
Construction Management	\$42,000.00	1.75-person team / 60 days
Total	\$173,140.00	

Indirect Cost Rate Cost (in percent)	<u>170.00%</u>	<u>\$294,338.00</u>
Fix Fee (in percent)	<u>30.00%</u>	<u>\$51,942.00</u>

Reimbursable

A. Travel and Per Diem	<u>\$2,000.00</u>
B. Reproduction Expenses	<u>\$3,000.00</u>
C. Computer Expense	<u> </u>
D. Communication	<u> </u>
E. Sampling and Testing	<u> </u>
F. Outside Consultants	<u> </u>
G. Other	<u> </u>
Total:	\$5,000.00

Sub-Total \$524,420.00

*Management Reserve	<u>\$10,000.00</u>	*Management Reserve	<u>\$10,000.00</u>
---------------------	--------------------	---------------------	--------------------

* Use only on Cost plus Fix Fee agreement **Grand Total** **\$534,420.00**

Chapter 32 *Railroad/Highway Crossing Program*

32.1 **General Discussion**

The purpose of this program is to reduce the number of fatalities and injuries at public highway-rail grade crossings through the elimination of hazards and/or the installation/upgrade of protective devices at crossings.

The program focus is on adding protection to crossing projects that demonstrate a need for safety and efficiency.

Funding for this program is discussed in [Chapter 12](#).

ROW Requirements for Railroads are discussed in [Chapter 25](#).

The first alternative to be investigated for improving a grade crossing is closure and/or consolidation with nearby grade crossing. Consolidation will reduce train-vehicle accident potential and maintenance costs. It is also possible that important accessibility may be reduced and unacceptable rerouting of vehicular traffic will result. Nevertheless, when improvement alternatives are considered, these factors should not preclude the consideration of crossing consolidation and the resulting benefits. Removal of crossing surfaces, erection of barriers, and other costs associated with closing a crossing are eligible under this program.

It is the position of the Federal Highway Administration that funding on railroad-highway grade separation projects will only be approved where closure of associated at-grade crossing(s) is imminent. When the grade separation project is opened, the at grade crossing must be closed.

The standards contained in this chapter are to be considered minimum standards for projects. They may be inadequate if extraordinarily hazardous conditions exist. In these cases, higher levels of protection should be provided.

32.2 **Selection of Appropriate Warning Devices**

References:

[Manual on Uniform Traffic Control Devices](#)

[Design Manual M 22-01](#)

FHWA Railroad-Highway Grade

Crossing Handbook

.21 Passive Protection – These devices include signing and pavement markings. The crossbuck sign is the responsibility of the railroad. All other signs and pavement markings are the responsibility of the local agency and are eligible for reimbursement.

.22 Design Standards for Active Protection – Active grade crossing traffic control devices include all signals, bells, and gates or other devices or methods that inform motorists and pedestrians of the approach or presence of trains, locomotives, or railroad cars on at grade intersections. The majority of the devices are automatically activated by the train. Active protection may be appropriate for those locations which have an exposure factor (trains per day times vehicle ADT) greater than 1,500 or are located on railroad main lines. However, a site specific evaluation of train and vehicle traffic volumes and speeds, rural or urban location, potential danger to a large number of people, sight distance and accident history should be completed before making a decision. The basic active protection device consists of post-mounted flashing lights. Gates should be added when any one of the conditions listed in

[Appendix 32.43](#) exist. Additional cantilevered flashing lights should be provided if any one of the conditions listed in [Appendix 32.43](#) apply. Unless special circumstances exist, all cantilevered installations should include gates. Signal lenses shall be 12 inches in diameter. The design standards are illustrated in [Appendix 32.41](#) and [32.42](#) and are in addition to those found in the *Manual on Uniform Traffic Control Devices* (MUTCD). MUTCD design standards also apply.

- a. **Post-Mounted Signals** – These flashing light signals are normally placed to the right of approaching highway traffic on all roadway approaches to a crossing. The design standards included as appendices to this division show the minimum dimensions for the following cases:

[Appendix 32.41](#) – Shoulder Section

[Appendix 32.42](#) – Curb Section

- b. **Automatic Gates** – Automatic gates should be added to post-mounted signals when any one of the following conditions is present:
- Multiple main line railroad tracks.
 - Multiple tracks at or in the vicinity of the crossing which may be occupied by a train or locomotive so as to obscure the visibility of another train approaching the crossing.
 - High-speed train operation combined with limited sight distance at either single or multiple track crossings (see [Appendix 32.43](#)).
 - A combination of high speeds and moderately high volumes of highway and railroad traffic.
 - Either a high volume of vehicular traffic, high number of train movements, school buses, or trucks carrying hazardous materials, unusually restricted sight distance, continuing accident occurrences, or any combination of these conditions.

When utilizing gates, the departure side of the crossing is usually left open to allow highway traffic to escape from the crossing.

- c. **Cantilevered Signals** – Cantilevered flashing light signals should be added to post-mounted signals and gates when any one of the following conditions is present:
- There are considerable distractions near or beyond the crossing which would compete for the driver's attention.
 - Traffic or parking conditions are such that the view of a post-mounted flashing light signal could be blocked.
 - The angle of approach to the crossing is acute and post-mounted signals could go undetected.
 - The highway has two or more lanes in each direction.
 - The highway carries high-speed and high-volume traffic.

Unless special circumstances exist, all cantilevered installations should include gates. The design standards included as appendices to this division show the minimum dimensions for the following cases:

[Appendix 32.41](#) – Shoulder Section

[Appendix 32.42](#) – Curb Section

All crossing sites will be reviewed and recommendations made by a diagnostic team consisting of representatives of the Federal Highway Administration (FHWA), railroad, WUTC, local agency, and the Washington State Department of Transportation (WSDOT)

- d. **Traffic Signals at or Near Grade Crossings** – When highway intersection traffic control signals are within 200 feet of a grade crossing, control of the traffic flow should be designed to provide the vehicle operators using the crossing a measure of safety at least equal to that which existed prior to the installation of such signal. Accordingly, design, installation, and operation should be based upon a total systems approach in order that all relevant features may be considered (see [MUTCD](#) Section 8C-6).

.23 Traffic Barriers – A railroad signal may be a point hazard warranting the use of a traffic barrier or crash cushion. Traffic barrier and crash cushion guidelines are shown in Section 710 of the [Design Manual](#) M 22-01. A guardrail should be installed if the speed limit is greater than 35 mph.

.24 Approaches – Funding to improve road approaches for safety purposes may be considered as a part of signalization projects on a case-by-case basis. Approach work for safety improvement includes profile corrections to reduce approach grades at main line locations.

.25 Crossing Surfaces – Funding to improve crossing surfaces may be considered as a part of signalization projects on a case-by-case basis. The street or highway must have an ADT of at least 7,500 in order to be considered.

.26 Illumination – Railroad grade crossings may be considered for illumination where a nighttime accident pattern is known to exist or is likely to occur. These projects will be considered on a case-by-case basis.

32.3 Project Development Process

.31 Project Application Package – A local agency wishing to develop a project to provide protection at a railroad/highway crossing must follow the application process outlined in [Chapter 21](#), including all support information listed in [Appendix 21.41](#).

The railroad should be contacted during the project development process to provide notification of the proposed project and to obtain relevant data on train movements. Nearly all rail trackage in Washington State is operated by the Union Pacific or Burlington Northern Santa Fe. The contact person for these railroads are listed below:

Terrel A. Anderson	Richard W. Wagner
Manager Industry & Public Projects	BNSF Railway Mgr. Public Projects for WA.
9451 Atkinson Street	2454 Occidental Avenue South Ste 2D
Roseville, CA 95747	Seattle, WA 98134
Office: 916-789-5134	Office: 206-625-6152

A list of Short Line Railroad contacts is located on the website located at www.utc.wa.gov/regulatingIndustries/transportation/rail/Pages/RailroadCompanies.aspx

The Region Local Programs Engineer will assist in determining the owner of the trackage and the appropriate contact person if necessary. In completing the Project Application Package, sufficient preliminary engineering funds should be requested to cover the agency's PE costs as well as an additional \$3,000 to \$5,000 to cover the railroad's costs. The additional dollars for PE work done by the railroad should be shown under "other" on the Local Agency Agreement.

If existing devices are to be removed, the agency will notify the Local Programs Operations Engineer who will determine the salvage rights and values, and determine the railroad's credit to the FHWA, if they are federal property.

.32 Preparation of Project Data – When preliminary engineering funding has been approved, the agency should submit the necessary project data to the railroad along with a notice to proceed. [Appendix 32.44](#) shows a Railroad Project Data Form which provides a railroad with data to prepare an estimate of cost. The data required by the railroad is traffic lane widths, shoulder widths, curbs and sidewalks, angle at which the highway crosses the tracks, and the legal description of the crossing location. The location of any underground and overhead utilities in the area which will be excavated for the signal foundation should also be included.

.33 Railroad Agreement and Petition – Upon completion of the signal layout and design, the local agency will prepare the standard agreement shown in [Appendix 32.46](#) and a petition to the Washington State Utilities and Transportation Commission for installation of the crossing protection as required by [RCW 81.53.261](#). At this time, the railroad will also request construction authorization and the local agency should proceed with the construction authorization process as per [Section 32.34](#). The drawing shall form part of the agreement.

The petition and the agreement will be forwarded to the railroad for execution and returned to the local agency. The local agency will file the petition with the WUTC. The WUTC will review the petition and, if appropriate, issue an order directing installation of the crossing protection.

.34 Construction Administration and Project Closure – Upon receipt of construction authorization, the railroad will order material and proceed with construction.

Approximately five to eight months are required to obtain the signal material. The railroad will attempt to coordinate construction with other projects in the area to more effectively utilize crews.

The local agency is responsible for all work associated with a railroad agreement, from date of authorization for the railroad to proceed with the work through final completion of the work, subsequent closing of the agreement, and completion of the final audit.

The local agency is required to document the work performed by the railroad to ensure that the railroad's billing can be verified, thereby leaving an audit trail. This documentation may be performed by random oversight which is defined as on-site reviews two or three times a week while the railroad is working.

The documentation should be a record in the form of a diary and supplemental reports of the work performed by the railroad. This record shall be sufficiently complete to establish a record of the following:

- Number and general type of labor and supervision and number of hours chargeable to the agreement work.
- Number and type of major items of equipment used and number of hours chargeable to the agreement work.
- Description of work accomplished.
- Major items of material installed.
- Major items of material removed and disposition, i.e., salvage, scrap, junk.
- Details concerning any changes or extra work or other conditions affecting the work.

Within 30 days of project completion, the railroad will notify the local agency by letter that construction is completed. The local agency requests final billing from the railroad.

The local agency and the WUTC will be notified when the signals are completed and in operation. The agency should notify the Region Local Programs Engineer when the project is completed and submit any railroad and agency billings.

WSDOT will perform the final inspection and send a 90 day closure letter to the local agency (see [Chapter 53](#)).

32.4 Appendices

- 32.41 Signal Design – Shoulder Section
- 32.42 Signal Design – Curb Section
- 32.43 Railroad/Highway Grade Crossing Protection Sight Distance Diagram and Gate Warrant Form
- 32.44 Railroad Project Data Form
- 32.45 Type 3 Party Agreement – Example
- 32.46 Local Agency Railway Agreement

Appendix 32.41 Signal Design – Shoulder Section

Metric

SHOULDER SECTION ELEVATION VIEW FOR SUBMITTAL

DIMENSIONS
 A = _____ (1)
 B = _____
 C = _____
 D = _____
 E = _____

AGENCY _____
 PROJECT NO _____ ITEM NO _____
 LOCATION _____
 RAILROAD(S) _____

(1) Multilane facility only
 Number of lanes to be protected = _____
 Amount of future widening = _____
 (2) Gate Length = _____
 (3) Number of pairs of flashing lights = _____

Top of foundation to be at the same elevation of the traveled roadway and no more than 100 mm above the surface of the ground.

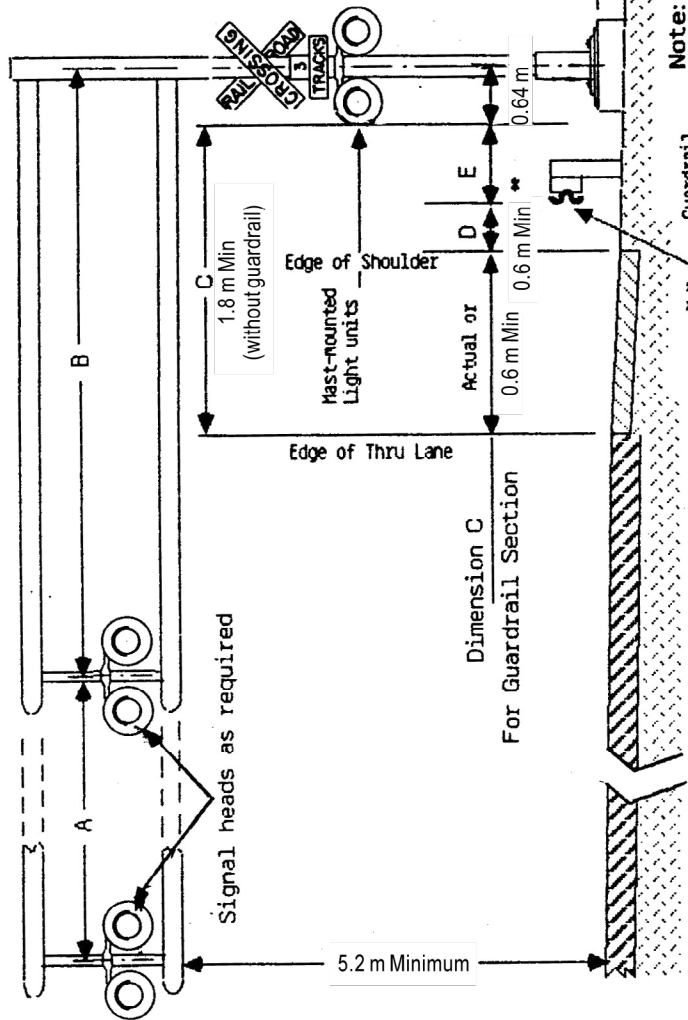

Note: For Guardrail placement details see standard plan C-2, " Case 3 placement " in the WSDOT Standard Plan Manual.

DATE _____ BY _____

ELEVATION VIEW

No Scale

* 0.6 m shy to face of rail is required for shoulder width of 1.8 m or less
 ** Not required for posted speeds of 60 Km/h
 *** 0.7 m Minimum

English

SHOULDER SECTION ELEVATION VIEW FOR SUBMITTAL

DIMENSIONS
 A = _____ (1)
 B = _____
 C = _____
 D = _____
 E = _____ ****

(1) Multilane facility only
 Number of lanes to be protected = _____
 Amount of future widening = _____
 (2) Gate Length = _____
 (3) Number of pairs of flashing lights = _____

Top of foundation to be at the same elevation of the traveled roadway and no more than 4 inches above the surface of the ground.

AGENCY _____
 PROJECT NO _____ ITEM NO _____
 LOCATION _____
 RAILROAD(S) _____

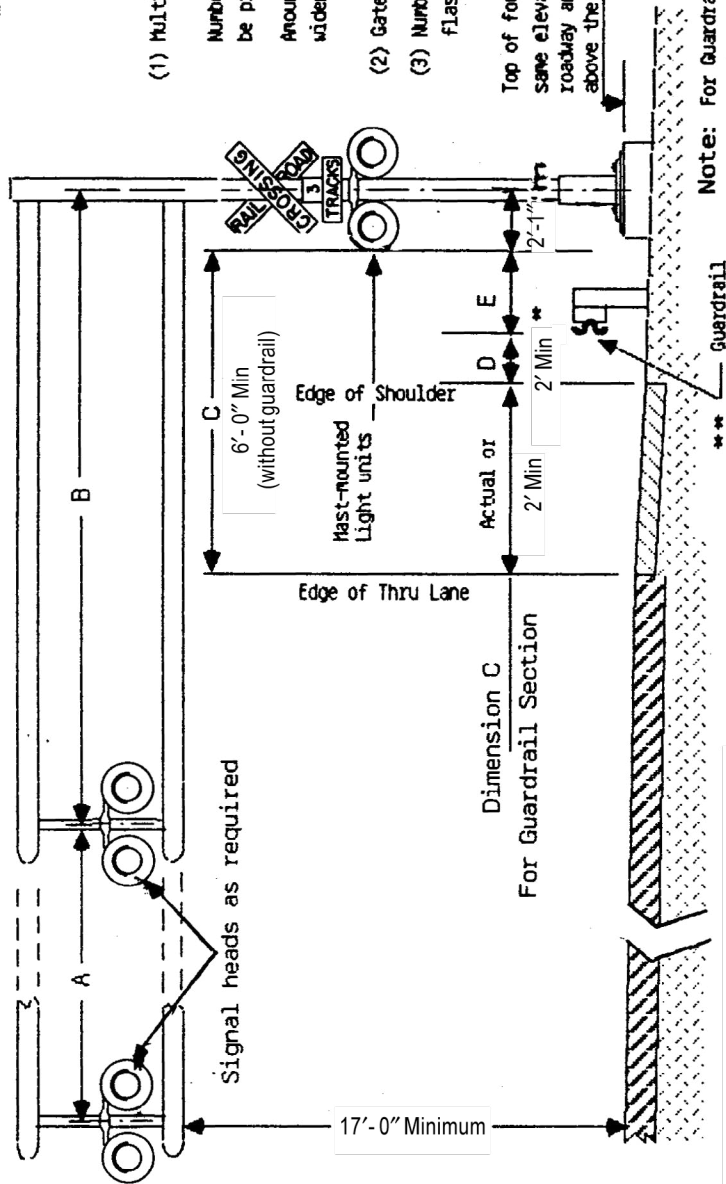

Note: For Guardrail placement details see standard plan C-2. " Case 3 placement " in the USDOT Standard Plan Manual.

ELEVATION VIEW
No Scale

DATE _____ BY _____

* 2' shy to face of rail is required for shoulder width of 6' or less
 ** Not required for posted speeds of 35 mph or less
 *** 3'-0" Minimum

Appendix 32.42 Signal Design – Curb Section

Metric

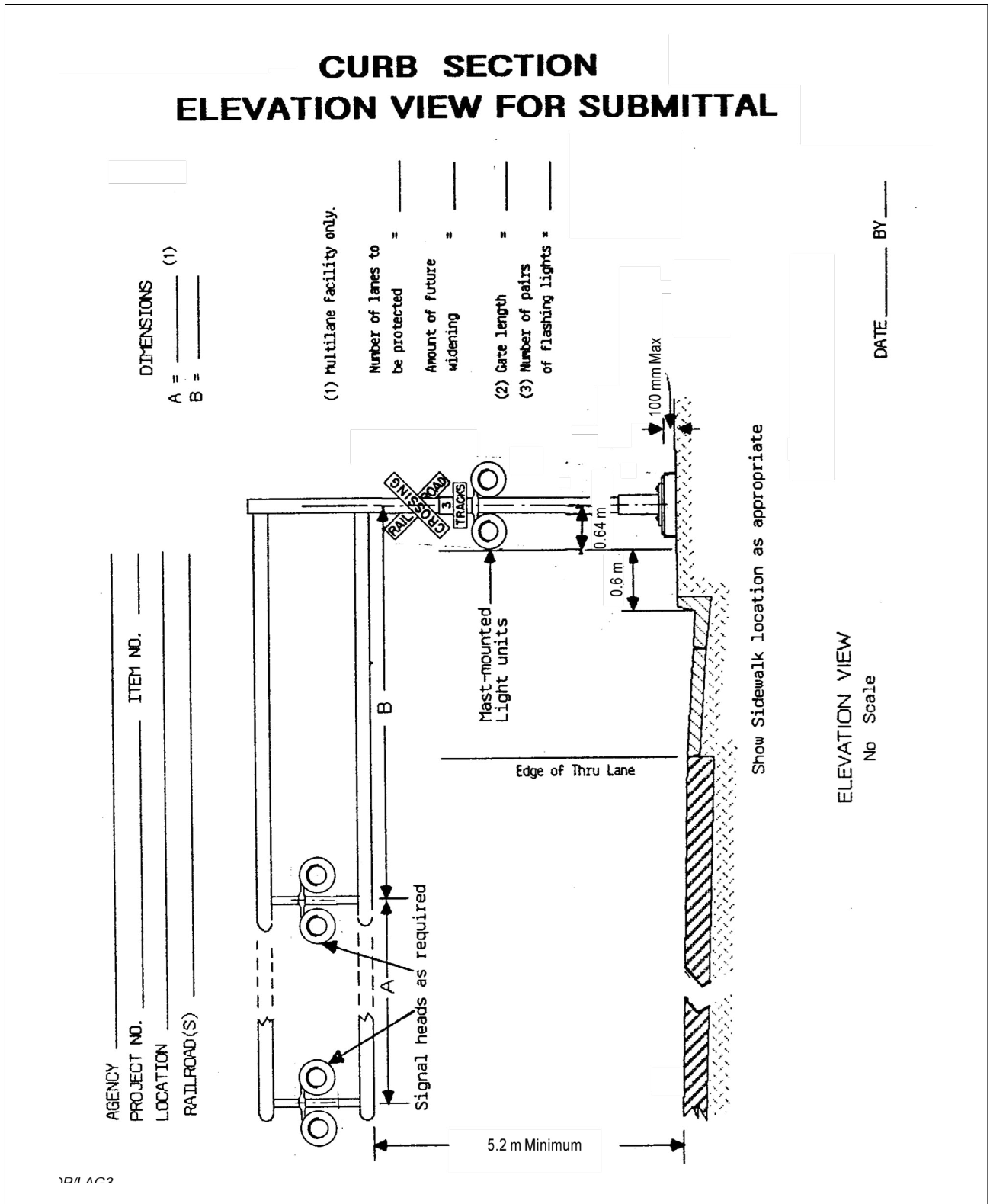

English

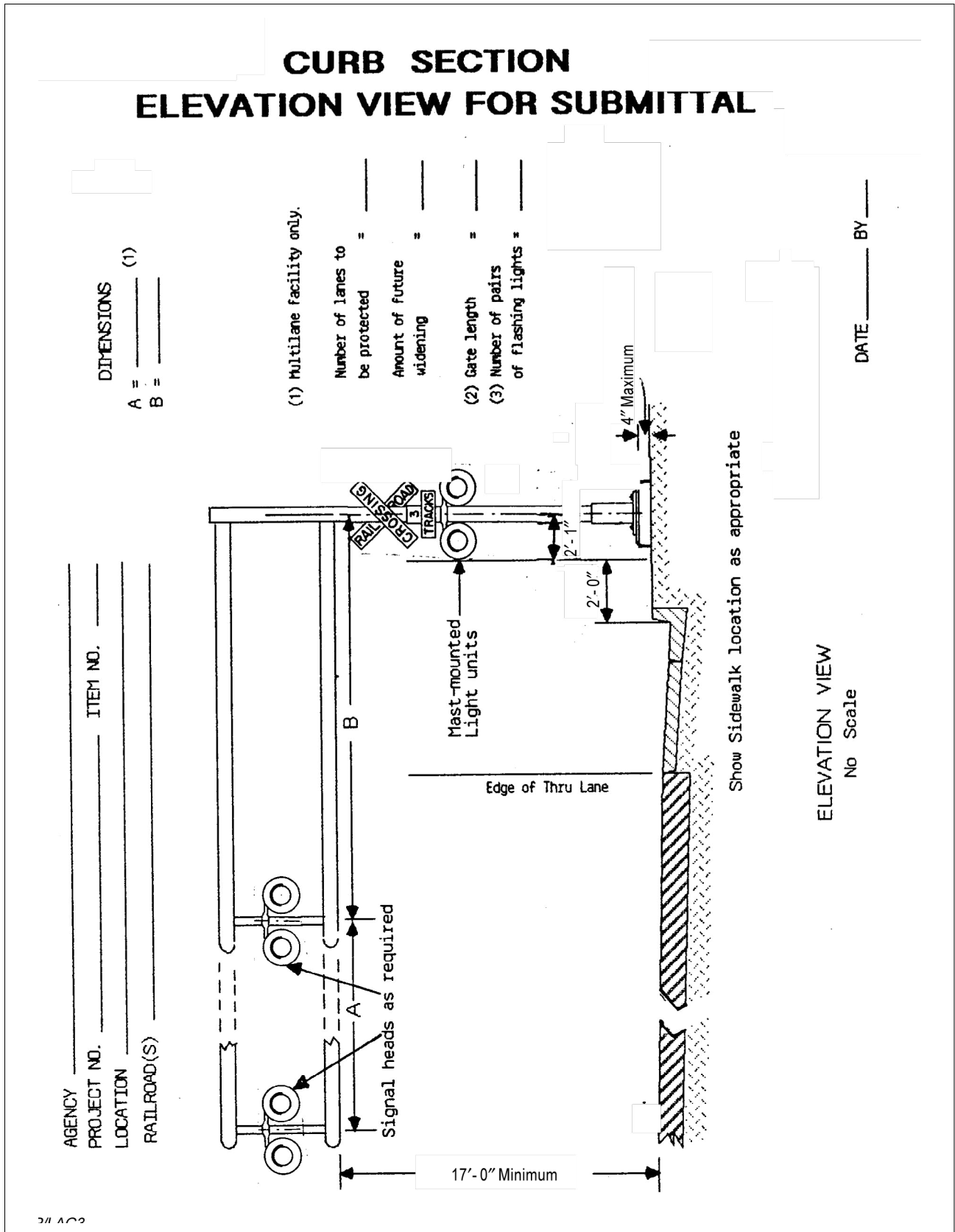

Appendix 32.43

Railroad/Highway Grade Crossing Protection Sight Distance Diagram and Gate Warrant Form

Metric

Case 1 Departure From Stop		Case 2 Moving Vehicle									
Train Speed (km/h) V_T		Vehicle Speed (km/h) V_v									
	0	20	30	40	50	60	70	80	90	100	110
		$f = 0.40$	0.40	0.38	0.35	0.33	0.31	0.30	0.30	0.29	0.28
		Distance along railroad from crossing - d_T (meters)									
20	95	50	40	40	40	40	40	45	45	50	50
40	185	100	80	75	75	80	85	85	90	95	100
60	275	145	120	115	115	115	125	130	135	145	155
80	355	195	160	150	150	155	165	170	180	190	205
100	455	240	200	190	190	195	205	215	225	235	255
120	550	290	240	225	225	230	245	255	265	285	305
140	640	335	285	265	260	270	285	300	310	330	355
		Distance along highway from crossing - d_H (meters)									
		25	40	55	70	95	120	150	180	215	255

Required design sight distance for combination of highway and ain vehicle speeds; 19.5 m truck crossing a single set of tracks at 90°.

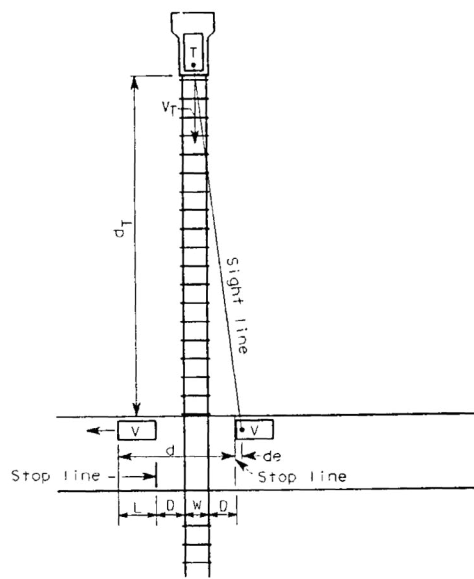

CASE 1
(stopped vehicle)

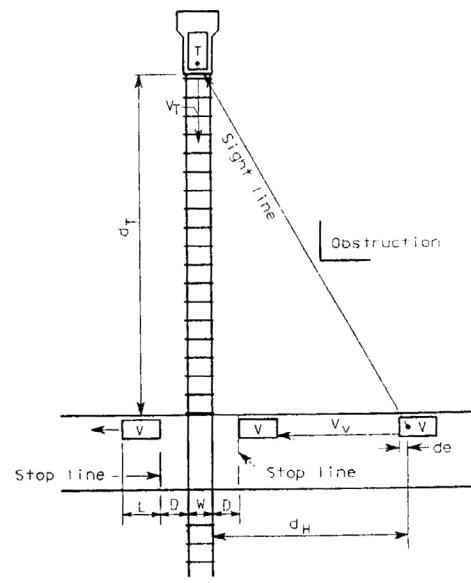

CASE 2
(moving vehicle)

Adjustments must be made for skew crossings.
 Assumed flat highway grades adjacent to and at crossings.
 W = Distance between outer rails (single track $W = 1.5$ m)
 D = Distance from stop line to nearest rail (assumed 4.5 m)
 d_e = Distance from driver to front of vehicle (assumed 3.0 m)

d_H = Sight distance along highway
 d_T = Sight distance along railroad tracks
 V_v = Velocity of vehicle
 f = Coefficient of friction
 V_T = Velocity of train
 L = Length of vehicle (assumed 19.5 m)

10-2005-004 100

English

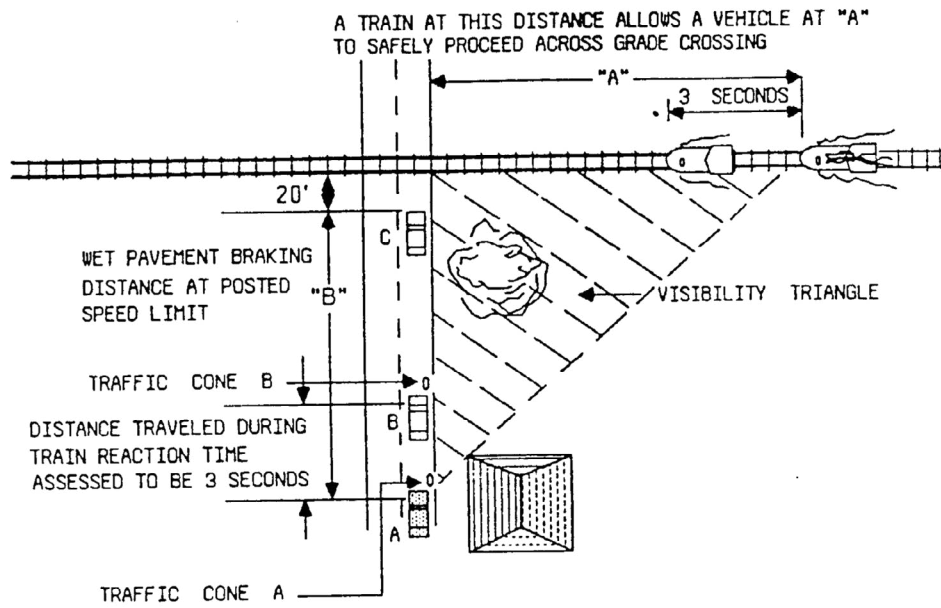

Required Design Sight Distances for Combinations of Highway and Train Vehicle Speeds

Train Speed	Highway Speed in MPH							
	0	10	20	30	40	50	60	70
	Distance Along Railroad from Crossing ("A")							
10	162	126	94	94	99	107	118	129
20	323	252	188	188	197	214	235	258
30	484	378	281	281	295	321	352	387
40	645	504	376	376	394	428	470	516
50	807	630	470	470	492	534	586	644
60	967	756	562	562	590	642	704	774
70	1,129	882	656	656	684	750	822	904
80	1,290	1,008	752	752	788	856	940	1,032
90	1,450	1,134	844	844	884	964	1,056	1,160
	Distance Along Highway from Crossing ("B")							
	20	65	125	215	330	470	640	840

Note: 1 mph = 1.61 kph and 1 foot = .304 meters

Appendix 32.44 Railroad Project Data Form

RAILROAD PROJECT DATA

Furnish Appropriate Information to Railroad With Each Project

1. Agency Name _____
2. Location of Crossing _____
3. Number of Traffic Lanes _____ Railroad Tracks _____
4. Crossing Number Available from Railroad _____
5. Statistics:

A _____	B _____	C _____	D _____	E _____	F _____	G _____	H _____	I _____	J _____	K _____
---------	---------	---------	---------	---------	---------	---------	---------	---------	---------	---------

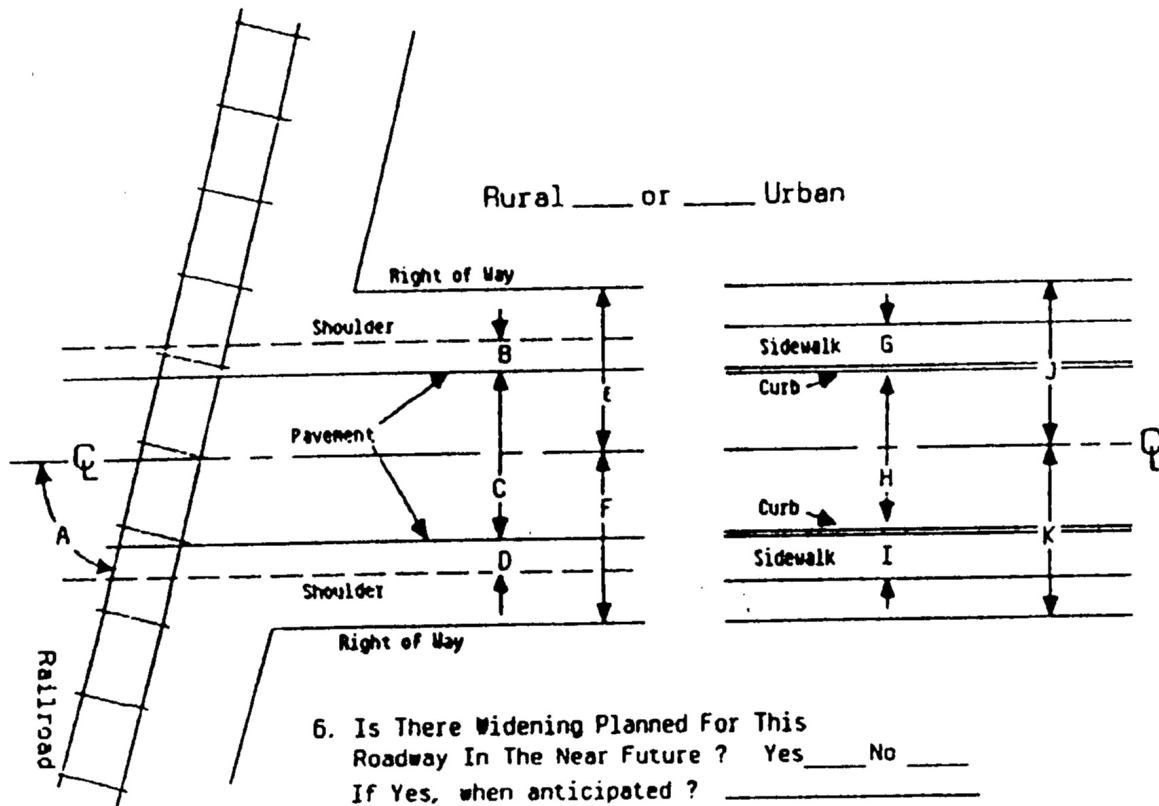

6. Is There Widening Planned For This Roadway In The Near Future ? Yes _____ No _____
 If Yes, when anticipated ? _____
 If within 3 years, provide a profile of the proposed approach roadway and show proposed ultimate dimensions on above plan.

Appendix 32.45 Type 3 Party Agreement – Example

Name _____ Date _____
Address _____
City, State, Zip _____ Agency _____
Job Title _____
FA Project Number _____
Contract _____

Dear:

This letter is intended as a Memorandum of Understanding between the _____ Railroad, _____ County, and the Washington State Department of Transportation. These three organizations will be referred to in this memorandum as the “Railroad Company,” the “County,” and the “State,” respectively.

Authority for this memorandum is based on an agreement _____, executed by the State on _____. The work described herein and covered by the subject agreements is to be performed under Project Number _____, State Contract No. _____.

It is necessary to provide a method of reimbursement to the Railroad Company for the cost of providing flagging and protective service and devices resulting from the construction operations of the contractor, as set forth in the above noted agreement. Therefore, the following procedures for the submittal and payment of bills for such costs are established:

Flagging costs incurred by the Railroad Company as a result of the operations of the County’s contractor shall be at the contractor’s expense. The Railroad Company will submit bills for these expenses to the State, the State will pay the bills and deduct such monies paid from the amounts due the contractor on monthly estimates.

Upon completion of the project, the full amount of the estimated flagging costs, as set aside by the State as a part of the Contract Work Order Accounting Plan, less the amount paid to that date, will be retained by the State for a period of 150 calendar days after said completion. After the 150-day period, the State will refund to the contractor the balance of the retained fund, or if the retained funds are insufficient, the contractor will be billed for the additional costs incurred by the Railroad Company.

Your signature and the signature of the appropriate company officer, in the spaces provided, will indicate acceptance of the provisions of this memorandum by your respective agencies.

Sincerely,
Director, Local Programs

cc: Region Local Programs Engineer

[Click here to enter text.](#)

Title: _____
City or County _____

[Click here to enter text.](#)

Title: _____
Railroad Company _____



**Local Agency Railway Agreement
Federal Aid Safety Projects
Highway-Railway Grade Crossing
Warning Devices**

Local Agency _____ Project Number _____

Railway _____ Agreement Number _____

The above parties having complied, or hereby agreeing to comply, with the terms and conditions set forth in (1) Title 23, U.S. Code, Highways, (2) the regulations issued pursuant thereto, and (3) the Policies and Procedures promulgated by the Washington State Department of Transportation, relating to grade crossing warning devices, hereby agree to proceed with the accomplishment and completion of the project hereinafter described.

Project Description

Local Agency Road Name _____

Location _____

Railway Line Name _____

Location _____

Description of Work

The site plan attached hereto as Exhibit C further describes the work.
Construction is estimated to be completed in _____ days, following execution of this agreement and authorization to proceed.

Estimate of Cost

Type of Work	Labor	Non-Labor	Total
1. Install Warning Devices (Type)			0
a. Freight Material Handling			0
b. Equipment Rental			0
c. Expenses			0
d. Salvage			0
e. Other			0
2. Engineering and Accounting			0
3. Liability Insurance			0
4. Labor Surcharge			0
5. Other Work by Railroad* <input type="checkbox"/> Yes <input type="checkbox"/> No Exhibit A attached hereto			0
6. Total Project Costs	0	0	0

* If detail is required, attached Exhibit A. Insert Exhibit A totals in this line.

The above parties further stipulate that they agree to and will comply with the provisions set forth in the reverse hereof and made a part of this agreement. Where a franchise or permit exists, the parties shall determine to what extent the franchise or permit is superseded by this agreement. Such determination should be in writing and attached as part of the agreement.

Repair or replacement of damaged or obsolete signals. The cost of repair or replacement of the signals shall be borne on the ratio of _____ percent Local Agency and _____ percent railway.

This agreement shall inure to the benefit of and be binding on the parties hereto, their successors and assigns.

Adopted by Resolution/Ordinance No. _____ Railroad Official _____

Local Agency Official _____ Title _____

Date _____ Date _____

If the damage to a signal is caused by highway traffic, Local Agency will cooperate with the Railway in determining the location and identification of the parties responsible to the extent of making accident records available.

If said damaged signals cannot, through age, be maintained or require replacement by virtue of the obsolescence, then the cost of replacing the signals shall be negotiated by the Local Agency and the Railway as specified on the front hereof, with such state, federal, or other public funds as may be available at the time such replacement becomes necessary.

VIII. Disposition of Signals No Longer Required

If for any reason, signals shall no longer be required at grade crossing and, in the opinion of the Railway and WSDOT Local Programs, they are not obsolete, the state will take ownership and arrange to have them relocated to some other grade crossing. If said relocation is agreed upon by the WSDOT Local Programs and the Railway, the divisions of cost of such relocation shall be agreed upon between the Local Agency and the Railways prior to such removal. If for any reason the signals shall no longer be required at the grade crossings and in the opinion of the Railway and WSDOT Local Programs the signals are obsolete, the Railway may remove the signals and credit the Local Agency with the value of salvage recovered less cost of removal. The funds credited by the Railway will be reimbursed to the FHWA.

VIII. Relocation Required by Improvement

In the event that either railway or highway improvement will necessitate a rearrangement of relocation or alternation of the existing signals at said crossing, the party whose improvement causes such changes shall bear the entire cost thereof without expense to the other party. The Railway and WSDOT Local Programs will make the decision as to whether the signals or control circuits will be obsolete or inadequate to accommodate an improvement, subject to conformance with the policies and procedures promulgated by the Washington State Department of Transportation relating to grade crossing warning devices.

IX. Nondiscrimination Provision

If the Railway enters into a contract or agreement with a contractor to perform any of the work which the Railway is required to perform under the terms of this agreement, the Railway for itself, its assigns, and successors in interest, agrees that it will not unlawfully discriminate in its choice of contractors and will include all the nondiscrimination provisions set forth in Exhibit B, attached hereto and made a part hereof, in any such contract or agreement.

X. Buy America Requirements

The requirements of 23 C.F.R., section 635.410, "Buy America" apply to this project.

XI. Audit of Federal Aid Project

The Department, if services of a consultant are required, shall be responsible for audit of the consultant's records to determine eligible federal aid costs on the project. The report of said audit shall be in the Department's files and made available to the state and the federal government.

An audit shall be conducted by the Department's Internal Audit Office in accordance with generally accepted governmental auditing standards as issued by the United States General Accounting Office by the Comptroller General of the United States; WSDOT Directive D27-50, Consultant Authorization, Selection, and Agreement Administration; and Office of Management and Budget circular A-128.

If upon audit, it is found that an overpayment of federal money in ineligible items of cost has occurred, the Railway shall reimburse the Local Agency for the amount of such overpayment in excess of participation (see Section VIII). The funds credited by the Railway will be reimbursed to the FHWA.

I. Scope of Work

The Railway will provide all the work, labor, materials, and services to install the warning devices hereinafter called "signals" as described and set forth in the "Project Description" and "Estimate of Cost."

The Railway will provide all the work, labor, materials, and services to install the warning devices hereinafter called "signals" as described and set forth in the "Project Description" and "Estimate of Cost."

The Local Agency shall perform those services necessary to facilitate the processing of all necessary documents required for the orderly progress of the project in accordance with the policies and procedures of the Washington State Department of Transportation (hereinafter called "Department") and the Federal Aid Policy Guide of the Federal Highway Administration (hereinafter called "FHWA."

The Local Agency shall install without expense to the Railway advance warning signs, standard pavement markings for railroad crossings, and guardrails or barriers to protect the signals from highway traffic when such protection is required.

II. Funding

The project will be financed in conformity with FHWA regulations adopted for safety improvement projects authorized in the Transportation Equity Act for the 21st Century.

III. Payment

Upon written authorization by the Local Agency, the Railway may proceed with the project. Following execution of this agreement, progress bills may be submitted to the Local Agency for the cost of labor, materials, and other services provided to date of billings and as shown in the Estimate of Cost or supplemental estimates of cost furnished by the Railway and accepted by the Local Agency, the Local Agency shall pay such progress billings promptly upon receipt. Final and detailed billing of all incurred costs shall be made by the Railway within one year of project completion, and the Local Agency shall pay all eligible amounts of such bill, less progress payments previously made.

The Local Agency agrees to reimburse the Railway for the amount shown in the Estimate of Cost for the actual cost of labor, materials, and other services furnished by the Railway pursuant to this agreement, provided the costs are eligible.

IV. Availability of Records

All project records in support of all costs incurred and expenditures are to be kept and maintained by the Railway and by the Local Agency in accordance with Subchapter B, Subpart H or Section 140.922(c) of the C.F.R.

The records shall be open to inspection by the Department and FHWA at all reasonable times and shall be retained and made available for such inspection for a period of not less than three years from the final payment of any funds to the Railway.

V. Maintenance of Facility

Upon completion of installation, the Railway shall operate and maintain the signals as required by law. The Local Agency will maintain the advance warning signs, the standard pavement markings for railroad crossings, and protecting barriers or guardrails at Local Agency expense. However, in the event that any existing or future legislation makes federal, state, or other public funds available for the operation, maintenance, repair, or replacement of signals at grade crossings, the Local Agency shall cooperate with the Railway to secure said funds for the operation, maintenance, repair, or replacement of the signals installed pursuant hereto. This agreement may be supplemented and amended as necessary for the operation and maintenance of said signals to qualify for such funds.

VI. Repair or Replacement of Damaged or Obsolete Facility

In the event one or more of the signals installed under this agreement are partially or wholly destroyed and its or their replacement value or cost of repairing cannot be recovered from the person or persons responsible for such destruction, then in that event, cost of repair of the signals or cost of installation of a new signal or signals shall be borne on a ratio agreed upon by the Railway and the Local Agency as specified on the front hereof.

Chapter 33 *Emergency Relief Program*

This chapter provides information and instructions on procedures applicable to emergency projects funded by FHWA under the Emergency Relief (ER) Program. Agencies should notify the Region Local Programs Engineer of damages to roadway systems caused by an emergency/disaster.

When an emergency exceeds the capability of state and local government, federal assistance can be requested from FHWA (ER and ERFO) and FEMA for the purposes noted below:

- The Federal Highway Administration (FHWA) under Title 23, USC, Section 125 provides Emergency Relief (ER) funds for the restoration of all damaged public roads and bridges except for rural minor collectors and local roads.
- FHWA's Western Federal Lands Highway Division Office directly handles ERFO funds (Emergency Relief for Federally Owned Lands) for repairs to roads on federal lands (Forest Service, Park Service, etc.) that are not federal-aid highways (rural minor collectors and local roads).
- Federal Emergency Management Agency (FEMA) provides federal funds under Public Law 93-288, the Stafford Act, for restoration of damaged roads and bridges on rural minor collectors and local roads not on federal lands.

Congress annually authorizes \$100 million nationwide for FHWA's ER program. The type of events that qualify for ER funding are:

- A widespread natural disaster. Examples are floods, hurricanes, severe storms, earthquakes, volcanic eruptions, landslides, or tidal waves.
- A catastrophic failure. This is defined as the sudden and complete failure of a major element or segment of roadway system that causes a disastrous impact to transportation services. The cause must be external to the facility, such as a truck hitting a bridge and causing it to collapse.

References

- State of Washington Comprehensive Emergency Management Plan
- WSDOT [Emergency Relief Procedures Manual](#) M 3014, February 2012
- USDOT/FHWA *Emergency Relief Manual*, Updated May 31, 2013
- USDOT/FHWA *ERFO Disaster Assistance Manual*, October 2014
- The Stafford Act, April 2013

33.1 Steps Following a Disaster

Local Agency Process – Outlined below are the initial steps a local agency follows immediately after a disaster.

1. **Initial Notification** – A local Emergency Management Office immediately notifies the Washington State’s Emergency Management Division (EMD) via the fastest means possible.
2. **Local Agency Proclamation** – A proclamation is signed by elected official(s) in accordance with the State of Washington Comprehensive Emergency Management Plan. In accordance with [RCW 38.52](#), the state and each political subdivision (e.g., local agency) have prepared a Comprehensive Emergency Plan which is put into effect when a disaster occurs ([Appendix 33.91](#)).
3. **Recording Site Specific Costs** – It is very important to document all expenses incurred by an agency in coping with the disaster or catastrophe. Records must be site specific, identified by route, M.P. and/or by cross street identifiers within the route. Cost records must have supporting documentation for labor, equipment, and materials. Failure to document costs as outlined above is a major reason for ineligibility findings.
4. **Additional Data Gathering** – Agencies should gather evidence of the disaster such as newspaper clippings and photos. This information is helpful in the preparation of the field reports to request emergency relief funds.
5. **Requesting State Assistance** – During and immediately after the disaster, the local Emergency Management Office conducts “damage assessments” to determine the magnitude, dollar value, effects, and impacts of the emergency/disaster. There may be a site visit from the Local Programs Engineer and FHWA.

It is very important to make timely and accurate damage reports to the EMD. These reports should describe the disaster and any local response. The “Incident Report” and “Disaster Analysis Report” forms provided by EMD and completed by the local agency (see Comprehensive Emergency Management Plan) are approved means of providing such a report. In addition, this notification should include the local agency’s “Proclamation of Emergency.”

6. **Proclamation by the Governor** – From the information received EMD will inform the Governor’s Office. If the situation warrants state assistance, EMD will coordinate the state response to supplement the efforts of local governments. The Governor will proclaim a State of Emergency when necessary. The Governor’s proclamation is required to obtain assistance under both ER and FEMA ([Appendix 33.92](#)).

From this point on, the processing of ER or FEMA projects are different, and the procedures are shown separately in the following sections.

33.2 FHWA's Emergency Relief Program Guidelines

The Emergency Relief (ER) Program is administered by FHWA through WSDOT. To qualify for ER funds the damages to be corrected must have resulted from the declared disaster or catastrophic failure (as described above) and be for emergency opening, repair, or reconstruction of roadways and bridges on federally functionally classified routes except for rural minor collectors and local roads and streets. In addition, the total federal share of statewide damage for the entire event must exceed \$700,000. Individual sites must have \$5,000 or more in repair costs; exceed heavy maintenance; not be a pre-existing condition; and not already programmed for construction with federal aid funding to be eligible for ER funds.

Eligible temporary or emergency repairs ([Section 33.41](#)), to minimize damage, protect facilities or restore essential traffic, accomplished within 180 calendar days after the first day of the actual disaster occurrence may be eligible for 100 percent ER funds. Repairs performed beyond 180 days after the actual occurrence of the disaster will be funded at the current program participation ratio for the federal aid route affected. Permanent restoration and any work beyond what is needed to minimize damage, protect facilities or restore essential traffic which is completed concurrently with or incidental to the emergency repairs will be funded at the current program participation ratio for the federal aid route affected.

.21 Application for Federal Assistance – WSDOT and local agencies are empowered to immediately begin emergency repairs to restore essential traffic service and to prevent further damage to the roadways. Properly documented costs will later be reimbursed if FHWA determines the disaster event and damaged sites are eligible. The determination of eligibility/noneligibility does not usually occur until approximately 60 days after the incident period. However, the following steps should be ongoing during this interval.

1. **Letter of Intent** – WSDOT prepares and transmits to FHWA a “letter of intent” to apply for ER program funds per the requirements. The letter of intent includes: an estimate of the damage on WSDOT eligible roadways; an estimate of damage on local agency’s eligible roadways; and notifies FHWA that WSDOT intends to request ER funds. This request usually follows the Governor’s proclamation.
2. **FHWA Division Acknowledgment** – The FHWA Division response to WSDOT directs WSDOT and local agencies to proceed with emergency repairs: to restore essential travel; to protect remaining facilities; to reduce the extent of damage; to begin preliminary engineering consisting of surveys, design, and preparation of construction plans; to perform any work which is incidental to the emergency operation; and to use local forces, contracts and/or equipment-rental contracts as necessary to perform the work.
3. **Approval of ER Events** – Upon reviewing damaged sites and/or information regarding damaged sites, FHWA Division Office will determine if the event qualifies for ER funds and will notify WSDOT of the determination typically as part of the letter of acknowledgment. WSDOT Local Programs is informed accordingly and notifies the affected local agencies.

.22 FHWA Approval of Damaged Sites – From the time the disaster/emergency occurs local agency forces are out working to protect their transportation investments. The local agency will work with the Region Local Programs Engineer (LPE) to determine if the damage is likely eligible by describing the damage, review the site or photos, and estimate repair costs. If the damage is likely eligible then they will need to work with the LPE to prepare a Detailed Damage Inspection Report (DDIR).

If the disaster damage is eligible for ER funds, DDIRs are prepared to summarize the amount and scope of reimbursement for temporary repairs, emergency repairs, incidental repairs, and permanent restoration work. To better understand the damage and the repair to the agency's transportation system, the Region Local Programs Engineer may contact the agency to coordinate an onsite visit with a FHWA representative, at a mutually agreed upon time. If an agency has good documentation (including plenty of photographs), then site visits may not be necessary.

The agency will need to prepare a package of all relevant information for review by Local Programs and FHWA. In many cases, the emergency work will already have been completed. Accurate and detailed records are required to verify the expenditures. The package is to include:

1. **Detailed Damage Inspection Report (DDIR)** – The DDIR (see Forms) is prepared by the agency and submitted for review to the LPE. The DDIR should include all pertinent information pertaining to the site's damage caused by the ER event and a breakdown of damage estimates or actual costs (as applicable) of the work identified. Completion of the DDIR is a joint effort by FHWA, WSDOT Local Programs, and local agency personnel.

It is important that the DDIR document the scope of the approved repairs, but it is not critical that the cost estimate be precise at the time of the DDIR (the cost estimate can be refined later). It is important that the damage inspections be completed as soon after the event as possible, even if final cost data is not yet available. The approved DDIR serves as the basic justification and cost document. Each agency receives a copy of the approved DDIR.

If the local agency agreement exceeds any amount on the DDIR by more than 10 percent or significant scope change, a revised DDIR will need to be approved by FHWA.

2. **Maps** – A vicinity map showing the location of the damage (can be agency-wide or site by site).
3. **Visual Aids** – Photographs, newspaper articles, and related documents (i.e., sketches, video tapes) are necessary to show the actual damage.
4. **Records** – Agency records must be site-specific [identified by M.P., route, or cross street identifiers] for each eligible federal aid route. Costs must be supported by labor, equipment and material records or contract documents. This is necessary to obtain full reimbursement. (These records are critical for the long-term but need not be fully complete at the time of the DDIR since the DDIRs cost estimate can be just that – an estimate.)

5. **Additional Data** – This will include any items FHWA requests. Because a significant amount of time may have elapsed since the disaster, the local agency may have to fund restoration costs while waiting for reimbursement. In many cases, the emergency work will already have been completed. Therefore, accurate and detailed records are required to verify the expenditures.

33.3 Reimbursable Expenses

.31 Eligible Costs – The following is the basic information on FHWA guidance regarding emergency relief procedures for reimbursement under the ER Program. This is also outlined in the USDOT/FHWA *Emergency Relief Manual* May 31, 2013.

Only certain items of repair or reconstruction of roads, streets, and bridges are eligible under the emergency relief program. FHWA will participate in costs when they are properly supported and documented and when such costs are directly attributable and properly allocable to ER projects. For a site to qualify it must: exceed heavy maintenance; not be a pre-existing condition; and not already be programmed for federal aid funding. For the purposes of the ER Program, heavy maintenance is repair work that is usually accomplished by highway agencies in repairing damage normally expected from seasonal or occasionally different natural conditions, doesn't disrupt essential traffic for more than a short period of time (often less than 1-2 days), and can be repaired with equipment and labor forces commonly available to State or Local maintenance crews. Work is considered already programmed if construction funding for it is included in the State Transportation Improvement Program (STIP).

The emergency conditions most frequently experienced in Washington State are those resulting from damage to highways caused by unseasonal severe storms which create flooding conditions. The processing of claims for damage by typhoons, tidal waves (or tsunamis), earthquakes, severe storms, landslides, volcanic eruptions, and other catastrophes will normally follow the criteria established for flood disasters. ER funds may participate in the emergency repair or reconstruction of: pavements or other surface courses; shoulders; embankments; cut slopes; natural and constructed drainage channels, including riprap, cribbing, or other bank control features; guardrail; bridges; retaining walls; signs and traffic control devices; culverts; bike and pedestrian paths, and fencing.

The ER program will only fund those activities: beyond heavy maintenance; required to restore essential travel; to prevent additional damage to the roadway; and work required to restore the roadway to its pre-disaster condition. Types of these eligible costs are as follows:

1. **Debris Removal** – This includes clearing debris from the traveled way, the cut and fill slopes, the clear zone and in some cases the drainage systems associated with damaged project sites.

This does not include the clearing of trees and other debris from all areas within the right of way. If debris is not obstructing traffic, in safety clear zones, or a drainage facility, removal of that debris would not be eligible for ER funds. Only debris on the facility or posing an immediate threat (including the immediate clear zone) to the facility will be considered emergency repair eligible for 100% reimbursement.

All other debris removal will be considered permanent repair and will be reimbursed at the pro-rata. In the event that debris removal (both emergency and permanent) is completed at the same time and cannot be documented separately, a reasonable negotiated split between emergency and permanent must be determined that is acceptable to FHWA or all debris removal at the site will be treated as permanent restoration and reimbursed at the pro-rata share for the facility.

If an ER event is declared to be an emergency or a major disaster by the President under the Stafford Act and debris removal is eligible for assistance under Sections 403, 407, or 502 of the Act, debris removal previously eligible for ER funding may no longer be eligible if it is eligible for FEMA funding instead. Presidential declarations are not common in Washington State.

2. **Traffic Control** – For ER eligible roadways traffic control devices such as barrels, barricades and signs; the establishment of detour routes; and enforcement of detours and road closures by law enforcement personnel are eligible for funding. ER reimburses the local agency and the state enforcement agencies for regular and overtime rates on ER eligible routes for performing disaster related traffic control activities. Documentation of hours, routes, etc., is required for reimbursement.
3. **Landscaping** – Landscaping and functional planting are eligible when incidental to otherwise eligible damage.
4. **Active Construction Contracts** – Damage due to the ER event within the limits of an active construction contract may also be eligible for ER funds. To be eligible damage must be due to the event, involve project elements that are in place and accepted by the owner, and clearly not be the responsibility of the contractor (e.g., not due to inadequate protection of disturbed areas). The work must be done by change order ([Section 52.5](#)).
5. **Detour Routes** – Establishment or construction of detours is eligible for ER funding if it can be shown that the detour will relieve excess traffic directly attributed to the eligible disaster. To be eligible, the detour must be designated which means the detour route is officially signed to reroute traffic around the damaged roadway. Routine maintenance of detours is not eligible, but repair of detour routes whether or not they are federal aid eligible, is eligible for ER funding. Ferry or transit service may be eligible where an alternate existing route may not be practical.
6. **Administrative Expenses** – Administrative expenses as listed below are also eligible for reimbursement.
 - a. **Regular and Extra Employees** – Regular salaries, overtime salaries and wages of all the regular and extra employees directly engaged in work on ER projects are eligible for reimbursement. Timekeeping procedures should provide for allocating employees' time to projects and/or other activities each day on an hourly basis. The timekeeping document, such as a time slip, time and attendance report, or time book, is the source document which must be available for examination by audit personnel to support direct labor costs claimed on any ER project. The document should be signed by a responsible employee having knowledge that the time distribution is accurately reported.

- b. **Payroll Additives** – Usually referred to as a labor surcharge, a set percentage over and above the total direct labor costs charged to a project is eligible for participation. This surcharge is to cover costs of various types of leave allowances, industrial accident insurance coverage and other employee benefits. The allowable percentage rates will consist of the agency's calculated rates which normally vary from year to year. Therefore, the records used in developing percentage rates should be preserved under suitable control conditions to assure availability for examination when requested. The acceptable percentage rate may be applied only to direct labor costs.
7. **Engineering and Right of Way** – Only that preliminary engineering, right of way, and construction engineering that are necessary, reasonable, and directly attributable to repair of eligible damages are eligible for ER reimbursement. Administrative costs are not eligible.
8. **Traffic Damage** – Generally damages of roadway surfaces due to traffic damage is not eligible for ER funds, but may be for surface damage repair (1) on any public road when it is caused by vehicles making repairs to federal eligible roadways, (2) on any public road officially designated a detour route around a damaged federal eligible roadway, and (3) on any federal eligible roadway when damage is caused by vehicles responding to a disaster.
9. **Overlays** – Where entire sections of roadway are damaged and need to be constructed, new surfacing is eligible. Roadways submerged during flooding, but suffering no significant damage, are not eligible.
10. **Raising Grades** – For traditional flooding, temporary work, fill material and minimum riprap to raise roadway grades to maintain essential traffic service during flooding is eligible. Roadways temporarily raised to maintain essential traffic service and that suffer no significant damage as a result of the flood and work to permanently provide a higher grade (recompact fill and provide permanent surfacing) are not eligible. Contact your Region Local Programs Engineer to have them consult with FHWA on raising grades in basin flooding situations.
11. **Slides** – The removal of rock and mud slides is eligible. To be eligible for correction to provide a safe roadway, such a slide must be associated with the overall natural disaster or by itself qualify as a natural disaster. Projects to stabilize the slide area to protect the roadway or to relocate the roadway are eligible when justified as a betterment.
12. **Traffic Control Devices** – The cost of repair and replacement of traffic control devices (traffic signal, traffic control signs) is eligible only if such damage exceeds heavy maintenance.
13. **Roadside Appurtenances** – The cost of repair and replacement of roadside appurtenances (guardrail, bridge rails, impact attenuators, right of way fences, etc.) is eligible if such damage exceeds heavy maintenance.

14. **NEPA Process** – An ER repair project may need to incorporate added features to mitigate impacts of associated items such as wetlands, noise, endangered species, etc. A general rule of thumb to follow: if the added feature is related to a betterment that is eligible for ER participation, then the mitigation feature is probably eligible for ER funding; if the betterment is not justified for ER funding, any added feature related to the betterment is probably not eligible for ER funding. Contact your Region Local Programs Engineer to have them consult with FHWA on your specific situation.
15. **Outside of the Roadway Right of Way** – Generally, damage repair activities outside the roadway right of way is not eligible for ER funding. The exception to this would be work (riprap, bank protection, etc.) associated with a stream channel adjacent to a roadway when the work is directly related to protection of the roadway.
16. **Supplies and Materials** – Engineering and general office supplies of an expendable nature, charged from stock or purchased for a particular project, and properly identified on the stock-issue slip or vendor's invoice with the project charged, are eligible for ER funding participation.
17. **Equipment** – The use of applicant-owned equipment or equipment owned by, and rented from, another public entity, or equipment rented from commercial sources (provided rental costs are reasonable) which is necessary for the work authorized under an ER project will be eligible for participation.
18. **Indirect Cost** – Costs that are not allocable to a specific project such as a general overall assessment of damage, administration, overhead, general supervision, contract administration other than construction engineering, and project planning and scheduling are considered indirect costs that may be eligible for ER funding if the agency has an indirect cost rate that complies with 2 CFR 200. For additional guidance concerning indirect costs, please contact your LPE.

.32 Ineligible Costs – The ER Program is intended to correct disaster damage to highways. The ER program does not provide emergency transportation services (e.g., ambulances, helicopters), compensation for material, equipment, or economic losses (e.g., stockpiled material, maintenance equipment, lost revenue). Also, non-federal eligible roads, bridges and trails are not eligible for ER funds but can be submitted to FEMA for reimbursement. Below are descriptions of work that is ineligible for reimbursement:

1. **Heavy Maintenance** – The purpose of the ER program is to address major, widespread damage that disrupts essential traffic along Federal-aid highways. When a disaster has caused damage requiring heavy maintenance or work frequently performed by the applicant's maintenance crews, repairs are usually not eligible. Heavy maintenance is work which is less severe, doesn't disrupt essential traffic for more than a short period of time (often less than 1-2 days), and usually can be performed by agencies in repairing damage normally expected from seasonal and occasionally unusual natural conditions or occurrences. It includes work at a site, required as a direct result of a disaster, that can reasonably be accommodated by an agency's maintenance, emergency or contingency program. For the purposes of determining if work at a site is heavy maintenance or work eligible under the ER Program, the type of work, the volume or amount of work, the cost per site, and the abilities of the local agency will be considered.

2. **Snow Removal** – Snow removal is not eligible for ER funds.
3. **Prior Scheduled Work.** Work already scheduled for repairing or replacing deficient facilities with federal aid funds, which are damaged during a disaster, will not be eligible for ER funds. Work is considered already scheduled if construction funding for it is included in the STIP. This work should be funded as originally intended.
4. **Traffic Damage** – Repair of roadway surface damage caused by traffic, even if the roadway was inundated or the subgrade saturated, is not eligible, except as noted in [Section 33.31 item 8](#).
5. **Frost Heaving** – Damage to roadway subbase and base materials due to inundation or because of freezing and resultant frost heaves, even if the roadbed has been saturated by flood waters, is not eligible for repair using ER funds.
6. **Applicant-Owned Material** – Replenishment of destroyed or damaged stockpiles of materials for both maintenance and construction that have not been incorporated into the roadway is not eligible for replacement under the ER program. Repair or replacement of damaged facilities such as maintenance sheds or equipment is not eligible for ER funds.
7. **Erosion Damage** – Minor erosion damage due primarily or wholly to rainfall and resulting from surface saturation of slopes and embankments, rather than flood waters, is considered heavy maintenance and is not eligible.
8. **Mitigation/Preventative Work Prior to Disaster** – Preventative work to avoid damage to a highway facility in anticipation of a disaster is not eligible for ER funding (e.g., work to prevent scour at a bridge site in anticipation of high rainfall and potential flooding).
9. **Catastrophic Failure from Internal Cause** – If the catastrophic failure is due to an internal cause, such as gradual and progressive deterioration or lack of proper maintenance, it is not eligible for ER funding.
10. Project delay costs or lost toll revenues are not eligible.
11. Radiological contamination with no incidental structural damage is not eligible for ER funding.

33.4 Types of Emergency Relief Work

.41 Temporary Emergency Repairs – The intent of temporary operations, including emergency repairs, is to restore essential traffic which cannot wait for a finding of eligibility and programming of a project. Emergency repair work should be accomplished in a manner which will reduce additional work required for permanent repairs. Temporary emergency repair work, accomplished within the first 180 days after the occurrence of the disaster, may be eligible for 100 percent federal aid.

Local agencies will need to coordinate with resource agencies for accelerated permit requirements. Local agencies will need to meet all local and state requirements.

The use of ER funds for temporary repairs to roadways will normally be limited to the amount necessary to bring the washed-out fills and slip-outs back to grade with a gravel surface. However, in most cases these emergency repairs to roadways will not be constructed to true line and grade. They will usually follow the terrain and be

constructed in the easiest and fastest manner. The repair to the road, nevertheless, should be good enough so traffic can travel over it safely at a speed reasonable for the site conditions. Where routes handle heavy traffic, an appropriate type of bituminous surface as a temporary repair will be eligible for short sections of roadway.

.42 Incidental Restoration – Incidental restoration that is more economical or practical to perform as an associated part of the emergency repairs may be eligible. This incidental restoration work can be performed with the emergency work provided it is properly documented and authorized in the DDIR. Incidental restoration work will be funded at the prorata share.

.43 Permanent Restoration – Permanent restoration is funded at the prorata share for the route regardless of when the work is done. Permanent restoration shall be administered using normal Federal aid procedures that include written authorization, NEPA clearance, design approval, permits, right of way certification, PS&E, advertisement period, etc. Permanent restoration work must begin within two federal fiscal years after the end of the federal fiscal year in which the event occurred.

Permanent restoration may involve one or more of the following categories of work:

1. **Restoration-In-Kind** – The ER program provides for repair and restoration of highway facilities to predisaster conditions. Restoration-in-kind is the expected predominant type of repair to be accomplished with ER funds. Any additional features or changes in character from that of the predisaster facility are generally not eligible for ER funding unless they can be justified because of construction, economy, and prevention of future recurring damage or technical feasibility.
2. **Replacement In-Kind** – If WSDOT and FHWA agree that it is not technically or economically feasible to restore a damaged facility to its pre-disaster condition, a comparable replacement facility may be warranted. Such replacement facility (roadways and/or bridges) should be designed to the current geometric and construction standards. In addition, the replacement facility should be evaluated and incorporating cost effective features that will make the facility more resilient and reduce the risk of damage from future events should be considered.

ER participation may be prorated. Where the replacement project exceeds ER eligibility limitations, the ER share of project cost will be limited to the estimated cost of the ER eligible replacement roadway or bridge.

Where relocation is necessary, each case must be considered carefully to determine what part of the relocation is eligible for ER funding. When relocation is being considered, the new location should be evaluated to determine its susceptibility to climate change damage.

3. **Betterments** – Betterments are defined as (1) added protective features, such as the rebuilding of roadways at a higher elevation, or the lengthening of bridges, or (2) changes which modify the function or character of the facility from its pre-disaster condition, such as additional lanes, or added access control. Betterments are generally not eligible for ER funding unless justified on the basis of economy, suitability and engineering feasibility and reasonable assurance of preventing future similar damage. Betterments should be obvious and quickly justified

without extensive public hearing, environmental, historical, right of way or other encumbrances. The justification must weigh the costs of the betterment against the probability of future recurring eligible damage and repair costs.

Upgrading that results from construction of replacement facilities to current standards as defined above is not considered a betterment requiring further justification. However, with respect to roadways, increases in capacity or a change in character of the facility would be considered betterments and are not justified for ER participation.

Betterments resulting from environmental or permit requirements beyond the control of the agency are eligible for ER funds, if these betterments are normally required when the agency makes repairs of a similar nature in its own work.

Minor relocations and alignment shifts are frequently advisable and are generally eligible for ER participation. However, any design changes made to avoid damage which could be expected to occur infrequently is questionable. Added features of appropriate protection, such as slope stabilization, slope protection and slide prevention measures wherever practicable, must have proper support. Slide stabilization work has been declared ineligible in problem areas where slides recur regularly. The cost of monitoring slide stabilization measures after completion of the initial stabilization is not eligible. ER participation in the initial construction does not create a continuing ER responsibility for future additional work.

Betterments which are eligible for reimbursement will be addressed, agreed to and documented on the DDIR or approved separately by WSDOT and FHWA in response to a local agency request justifying the proposed betterment.

4. **Replacement of Culverts** – Upgrading culverts to current standards must be specifically related to eligible disaster damage repair. Damaged culverts are eligible for repair in kind. Destroyed culverts are eligible for replacement to current standards. Area-wide upgrading of deficient culverts on an area or route basis is not eligible.
5. **Deficient Bridges** – This category includes structural deficiencies only. It does not consider waterway opening, functional obsolescence or serviceability, etc. Permanent repair of a structurally deficient damaged bridge is eligible for ER funding if the replacement is not already under construction or if the construction phase of the bridge replacement is not scheduled in the approved STIP.

ER eligibility criteria for two common situations are provided below:

- a. Bridge is damaged and is repairable.
 - Reasonable emergency repair to restore travel.
 - Permanent repair of damage if such repair also removes the structural deficiency.
 - Permanent repair of disaster damage if other funds are used to simultaneously correct the structural deficiencies. This involves situations where undamaged portions of a bridge still render the bridge structurally deficient.

- No permanent repair if construction phase of replacement bridge is scheduled in the STIP at the time of the event.
 - No permanent repair if bridge was deficient at the time of the event and the bridge will remain deficient after permanent repairs are made.
- b. Bridge is destroyed or repair is not feasible.
- Reasonable emergency repair to restore traffic.
 - New comparable replacement structure to current design standards and to accommodate design-year traffic volume if bridge is not scheduled for replacement.
 - No permanent repair if construction phase of a replacement bridge is scheduled in the STIP at the time of the event.

33.5 Contracts

The onslaught of a disaster requires quick reaction by local agencies to protect the traveling public and the remaining facility. The initial actions taken by local agency personnel are usually reimbursable if they meet the ER program requirements. The initial repairs may be accomplished using local agency forces, solicited contracts and/or sole source contracts, as described below. These are all allowable during the initial impact to agencies. When agencies use these methods, documentation of their procedures are required for reimbursement.

Permanent restoration work normally should be undertaken by competitively bid construction contracts ([Chapter 52](#)). All federal requirements (i.e., FHWA-1273, Title VI, Davis-Bacon, Buy America, Federal Wage Rates, DBE, etc.,) must be included in the same manner as a typical nondisaster federal aid project.

.51 Local Agency Forces – Due to the emergency character of the work, state and local agency forces ([Chapter 61](#)) and/or negotiated equipment rental contracts with owner/operators may be used in handling a considerable portion of the emergency repairs. An owner/operator is defined as someone who owns and operates their own equipment, with no other employees on a payroll, at a negotiated hourly operated rate. Local agencies may supplement their own forces by using the Public Works Emergency Response Mutual Aid Agreement or other interlocal agreements as appropriate. The intent is to restore essential traffic and stabilize any hazardous conditions caused by a disaster.

A formal finding for local agency forces work for temporary emergency repairs is not required. WSDOT approval is required for reimbursement of local agency forces work on permanent restoration work.

.52 Solicited Contract – This type of contract may be warranted due to the emergency character of the work. A minimum of three contractors/material suppliers are contacted and asked to submit bids on specific units of work. A source for these contractors would be the local agency's small works roster. These contracts shall be based on force account procedures ([Standard Specifications](#) 1 09.6), unit bid items or a combination of the two. These contracts will have a set of plans and specifications which may be abbreviated but must contain all federal requirements ([Section 33.63](#)).

The intent is to restore essential traffic and stabilize any hazardous conditions caused by a disaster or as noted on the DDIR. Unless emergency circumstances make it impossible or unfeasible to do so, provisions of 23 USC 112(c) which requires a sworn statement of noncollusion shall apply.

Likewise, a written summary must be prepared showing how the solicitation was done, who was contacted, and the responses by the contractors/material suppliers.

The agencies may use the Emergency Work Contract template ([Appendix 33.94](#)) for the purpose of Temporary Emergency Repairs and / or Incidental Restoration work.

.53 Sole Source Contract – Approval by WSDOT is required to use this type of contract. The approval may be given verbally or at the time of the onsite review (DDIR). The intent is to restore essential traffic and stabilize any hazardous conditions caused by a disaster or as noted on the damage inspection report. These contracts shall be based on force account procedures ([Standard Specifications 1-09.6](#)), unit bid items or a combination of the two. These contracts will have a set of plans and specifications which may be abbreviated but must contain all federal requirements ([Section 33.63](#)).

The type of work allowed for using a sole source contract include:

- Only one contractor in the area to perform the work.
- A contractor on-site under a current contract.
- The work is defined as specialty work.

Documentation is required justifying the use of a sole source contract.

The solicited contracts and sole source contracts must verify contractors status with the System for Award Management (SAM) to ensure the contractors are not excluded from working on federal aid contracts (Section 46.27).

33.6 Additional Project Requirements

.61 Design Standards – Reconstruction of damaged roadway and bridge facilities must be to adequate standards, including appropriate safety features. Reconstruction of extensively damaged facilities, including betterment projects when adequately justified, should be to the current design standards. Roadways and bridges may be replaced with a facility which meets current geometric and construction standards required for the type and traffic volume which such facility will carry over its design life.

.62 Environmental Impact Assessment – Emergency repairs during or immediately after a natural disaster are generally classified as categorical exclusions as are general permanent repairs if they are replacements in kind ([23 CFR 771.117\(c\)\(9\)](#) and [40 CFR 1508.4](#)).

.63 Abbreviated Plans – The use of abbreviated plans may be acceptable as long as it provides essential information necessary to describe the work to be accomplished and determine the reasonableness of unit prices for contract or force account work.

33.7 Funding

WSDOT Local Programs will process all the required data and submit it to FHWA for fund authorization. A standard funds request package should include:

- Project checklist with supporting data as appropriate ([Chapter 21](#)).
- Pictures of the affected site (before and after).
- A **signed** copy of the DDIR.

When submitting projects for funding, multiple sites on the same federal route or area within a local agency's jurisdiction may be grouped together under one Local Agency Agreement and Project Prospectus provided individual site information is included. Headquarters' approval for grouping sites is required prior to submittal.

Project fund requests which exceed the original DDIR must have a detailed explanation of the additional work required to complete the work. If the work done is outside the scope of the DDIR, concurrence by FHWA will need to be coordinated through the Region Local Programs Engineer prior to fund authorization. Any work to be done per the finding of a geotechnical report needs to be pre-approved by FHWA through the Region Local Programs Engineer.

All projects which involve a contract must follow the guidelines outlined in [Chapter 46](#). All further action, including processing, billing, and payment, will be in accordance with [Chapter 23](#).

Final vouchers, inspection, audit, and project closure are accomplished in accordance with [Chapter 53](#).

33.8 FEMA Program Guidelines

Federal Emergency Management Agency (FEMA) provides funding for restoration of damaged roads and bridges not eligible for ER, individual assistance and public assistance. Off system roads, bridges and trails (no matter where the initial funding came from) are eligible for FEMA reimbursement. Although neither FHWA nor WSDOT is involved in disaster relief project funding for non-federal aid roads/streets, this section has been included for informational purposes. For additional information, call 1-800-562-6108.

Federal share payable is 75 percent of the eligible costs for damage described under FEMA's emergency activities. Overtime only, on non ER eligible routes, for debris removal, emergency protective measures and traffic control is also reimbursable at 75 percent by FEMA.

The FEMA program provides federal reimbursement of eligible costs to repair, restore, reconstruct or replace damaged roadway facilities not eligible for ER. This includes emergency opening and permanent restoration.

Before funds are made available, the Governor must proclaim a state of emergency and request assistance from the President for assistance. The President must declare either an emergency or a major disaster.

The Disaster Recovery Manager of FEMA and Washington State's Governor's Authorized Representative are responsible for determining program eligibility based on criteria established by the federal government. The Governor's Representative is responsible for the program's administration.

Applying for Federal Assistance

1. **Governor's Request for Federal Assistance** – Based on the preliminary damage assessments, the EMD prepares the Governor's request letters, for the Governor's signature, which are submitted through FEMA to the President of the United States.
2. **Presidential Declaration** – If the President determines that the situation warrants federal assistance, the President declares either an emergency or major disaster and invokes the applicable sections of the FEMA regulations.
3. **Federal/State Agreement** – After the President makes the declaration of emergency, the Governor and the FEMA Administrator sign a federal/state agreement for federal, state and local participation.

Actions After Federal Funding Approval

1. **Preparation of Damage Survey Reports (DSR)** – EMD and FEMA jointly establish disaster field offices to coordinate federal and state response.
2. **Applicant Briefings – Eligibility Determination** – The Governor's Representative and Federal Disaster Recovery Manager will conduct applicant briefings. These briefings are for local elected officials, program administrators and accountants/bookkeepers. Local representatives are told what kind of assistance they will receive and the process to obtain the assistance. WSDOT Local Programs will provide a representative at the briefing to discuss the ER program.
3. **Determination Review** – In most cases, if not all, the Governor's Representative and the Disaster Recovery Manager will review and determine eligibility of the DSRs in the disaster field office. Those not determined in the disaster field office will be followed up by both the Governor's Representative and the Disaster Recovery Manager at a later date.
4. **State Requirements** – The Governor's Representative will coordinate with fisheries and wildlife departments to review each project's DSR and determine if a hydraulic permit approval is required.
5. **Project Modifications** – The applicant does the work and if a time extension, scope, or fiscal modification is required, the applicant makes a request to the Governor's Representative for consideration.
6. **Project Closure** – When the work has been completed, the applicant submits a Statement of Documentation to the Governor's Representative. The Governor's Representative determines whether or not final inspections need to be conducted based on program guidelines. Projects will be audited as part of the Single Audit Act by the State Auditors Office. Once all the program requirements have been met and final payment made, the Governor's Representative will send a close-out letter to the applicant.

When the federal audit or review is completed, the FEMA Regional Office forwards the reimbursement request to their National Office. The FEMA National Office forwards the final payment through the state's EMD, and closes out the project application.

33.9 Appendices

- [33.91](#) Local Agency Proclamation
- [33.92](#) Governor's Proclamation
- [33.93](#) Local Agency Detailed Damage Inspection Report
- [33.94](#) Emergency Work Contract

Appendix 33.91 Local Agency Proclamation

Date

WHEREAS, the _____ County Department of Community Development/Division of Emergency Management has reported to the Board of County Commissioners, that beginning on _____, 19___, unusual weather conditions, consisting of heavy snowfall followed by rain, have caused a disaster by creating extensive flooding in parts of _____ County; and

WHEREAS, extensive damage has occurred and is still occurring to county roads and bridges, private roads, homes, businesses, and farmland; and

WHEREAS, persons and property are and will be damaged unless further efforts are taken to reduce the threat to life and property; and

WHEREAS, there is a present emergency which necessitates activation of the _____ County Disaster Preparedness Plan and utilization of emergency powers granted pursuant to RCW 36.40.180 and RCW 38.52.070(2), therefore

BE IT RESOLVED BY THE BOARD OF _____ COUNTY COMMISSIONERS:

SECTION 1

It is hereby declared that there is an emergency due to the flooding conditions in _____ County. Therefore, designated departments are authorized to enter into contracts and incur obligations necessary to combat such disaster, protect the health and safety of persons and property, and provide emergency assistance to the victims of such disaster.

SECTION 2

Each designated department is authorized to exercise the powers vested under Section 1 of this resolution in the light of the urgency of an extreme emergency situation without regard to time-consuming procedures and formalities prescribed by law (excepting mandatory constitutional requirements).

Board of County Commissioners

[Click here to enter text.](#) County, Washington

Chairperson, [Click here to enter text.](#)

Commissioner, [Click here to enter text.](#)

Commissioner, [Click here to enter text.](#)

Note: Mailed to all county newspapers on above date.

cc: Washington State Emergency Management, re. notification by phone
Washington State Department of Transportation, Region Local Programs Engineer

JAY INSLEE
Governor



STATE OF WASHINGTON
Office of the Governor

PROCLAMATION BY THE GOVERNOR

15-15

WHEREAS, from November 13 through 18, 2015, a series of severe storms struck Washington State, producing high winds and extreme rainfall resulting in major flooding, saturated soils, landslides, stream bank and slope erosion, fallen tree limbs, broken and uprooted trees, and flying debris; and

WHEREAS, throughout the State, these storms caused three confirmed deaths, injuries to citizens, significant power outages, evacuations, temporary road closures and detours, rail line closures, ferry system and airline cancellations, and extensive damage to homes, businesses, public utilities, public facilities, electrical power systems, infrastructure, and property, in addition to creating sheltering needs for impacted citizens, threatening fragile and at-risk populations, and jeopardizing the health and safety of citizens with special medical needs; and

WHEREAS, erosion, landslides, and flooding resulting from these storms has been exacerbated in some areas of the State due to major wildfire damage in July through September 2015 that left large areas of land burned clear of trees and other vegetation; and

WHEREAS, blocked and damaged roadways caused by these storms resulted in limited access impacts complicating the provision of response and recovery efforts by emergency responders, businesses, and utilities to address the aftermath of these storms; and

WHEREAS, state agencies and local jurisdictions are coordinating resources to address damaged and blocked roadways, assess damage caused by the storms, and implement damage repairs; and

WHEREAS, the storm damage and its effects continue to impact the life and health of our citizens, as well as the property and infrastructure of Washington State, all of which is a public disaster that affects life, health, property, or the public peace; and

WHEREAS, the Washington State Military Department activated the State Emergency Operations Center, implemented emergency response procedures, and is coordinating resources to support local officials in alleviating the immediate social and economic impacts to people, property, and infrastructure, and is continuing to assess the magnitude of the event.

NOW, THEREFORE, I, Jay R. Inslee, Governor of the state of Washington, as a result of the above-noted situation and under Chapters 38.08, 38.52, and 43.06 RCW, do hereby proclaim that a State of Emergency exists in all counties in the state of Washington, and direct the plans and procedures in the *Washington State Comprehensive Emergency Management Plan* be

implemented. State agencies and departments are directed to utilize state resources in accordance with the Washington State Comprehensive Emergency Management Plan and to do everything reasonably possible to assist affected political subdivisions in an effort to respond to and recover from the event.

As a result of this event, I also hereby order into active state service the organized militia of Washington State to include the National Guard and the State Guard, or such part thereof as may be necessary in the opinion of the Adjutant General, to perform such duties as directed by competent authority of the Washington Military Department in addressing this event. Additionally, the Washington State Military Department, Emergency Management Division, is instructed to coordinate all incident-related assistance to the affected areas.

Signed and sealed with the official seal of the state of Washington this 18th day of November, A.D. Two-thousand and Fifteen at Olympia, Washington.

By:

_____/s/_____
Jay Inslee, Governor

BY THE GOVERNOR:

_____/s/_____
Secretary of State

Local Agency Detailed Damage Inspection Report



**Washington State
Department of Transportation**

Detailed Damage Inspection Report FHWA Emergency Relief

Applicant Click here to enter text.	County Choose an item.	FHWA Disaster No. Click here to enter text.
Location of Damage Click here to enter text. Route is on BIA's inventory classified as Tribal Transportation Facility (TTF): <input type="checkbox"/>	Milepost From MP To MP	Revision Number Click here to enter text.
Date, Cause, and Description of Damage Click here to enter text.	Local/State Project or No(s) Click here to enter text.	
Functional Class Choose an item.		

A breakdown of the cost estimate can be provided as a separate document attached to the DDIR. If the cost estimate (including preliminary and construction engineering) increases by 10% a revised DDIR must be approved by FHWA.

Temporary/Emergency Repair (work that is necessary to restore essential traffic, minimize the extent of damage, or protect the remaining facilities.) Click here to enter text.	Temporary/Emergency Repair <input type="checkbox"/> 100% Federal Aid Original Estimate Click here to enter text. Revised Estimate Click here to enter text.	
Method of Work: <input type="checkbox"/> Local/State Force Account <input type="checkbox"/> Emergency Contract		
Incidental Repair (The remaining portion of the work that is completed during the temporary/emergency repair.) Click here to enter text.	Incidental Repair Federal Aid % <input type="checkbox"/> 86.5% <input type="checkbox"/> 90.66% <input type="checkbox"/> 100% Original Estimate Click here to enter text. Revised Estimate Click here to enter text.	
Method of Work: <input type="checkbox"/> Local/State Force Account <input type="checkbox"/> Emergency Contract		
Permanent Restoration (This work is eligible for Federal participation at the normal pro-rata share and is administered using normal Federal-aid procedures.) Click here to enter text.	Permanent Restoration Federal Aid % <input type="checkbox"/> 86.5% <input type="checkbox"/> 90.66% <input type="checkbox"/> 100%	
	Preliminary Engineering Click here to enter text.	
	Right of Way Click here to enter text.	
	Construction Click here to enter text.	
	Total Perm. Restoration Click here to enter text.	
	Revised Total Perm. Restoration Click here to enter text.	
Method of Work: <input type="checkbox"/> Local/State Force Account <input checked="" type="checkbox"/> Contract		
	WSDOT Annual Indirect Cost Rate Click here to enter text.	
	Total Estimated Cost Click here to enter text.	
	Revised Total Estimated Cost Click here to enter text.	
Recommendation for Eligibility <input type="checkbox"/> Yes <input type="checkbox"/> No	Local Agency Representative	Date
Recommendation for Eligibility <input type="checkbox"/> Yes <input type="checkbox"/> No	State Representative	Date
FHWA Recommendation <input type="checkbox"/> Eligible <input type="checkbox"/> Ineligible	FHWA Engineer	Date

Instructions for filling out form

Location of Damage: Provide the name or route number of road, bridge number(s) if applicable and any other pertinent information to help identify the location of the damage.

Description of Damage: Describe how the event caused the damage, what damage the event caused, and why the damage is eligible for ER funding.

Functional Classification: Select from dropdown See functional classification mapping application (<http://www.wsdot.wa.gov/mapsdata/travel/hpms/functionalclass.htm>).

- Rural or Urban Interstate
- Rural or Urban Other Freeway/Expressway
- Rural or Urban Principal Arterial
- Rural or Urban Minor Arterial
- Rural or Urban Major Collector
- Urban Minor Collector

Temporary/Emergency Repair: Describe the work and provide a total cost estimate of work that is necessary to restore essential traffic, minimize the extent of damage, or protect the remaining facilities. A breakdown of the cost estimate can be provided as a separate document attached to the DDIR. Work in this box typically requires minimal preliminary engineering, geotechnical studies, structural analysis, or environmental review. These repairs are usually within the capabilities of the State and local maintenance forces and most will be performed on a force account or an emergency contract basis. Temporary/Emergency Repair Work is categorically excluded from NEPA requirements under 23 CFR 771.117(c)(9). This work must meet the emergency provisions of all other environmental regulations, such as ESA, Section 106, 4f. Most of these emergency provisions require that the regulatory agency be notified prior to beginning work.

Incidental Repair Work: Describe the work and provide a total cost estimate of work that was completed incidental to the Temporary/Emergency Repair Work. A breakdown of the cost estimate can be provided as a separate document attached to the DDIR. This work was not necessary to restore essential traffic, minimize the extent of damage, or protect the remaining facilities; this work is eligible for federal participation at the normal pro rata share for the facility type. Work in this box typically requires minimal preliminary engineering, geotechnical studies, structural analysis, or environmental review. These repairs are usually within the capabilities of the State and local maintenance forces and most will be performed on a force account or an emergency contract basis. Incidental Repair Work is generally categorically excluded from NEPA requirements under 23 CFR 771.117(c)(9). This work must meet the emergency provisions of all other environmental regulations, such as ESA, Section 106, 4f. Most of these emergency provisions require that the regulatory agency be notified prior to beginning work.

Permanent Restoration Work (Describe the work and provide a cost estimate for work performed as part of the Permanent Restoration. A breakdown of the cost estimate can be provided as a separate document attached to the DDIR. Permanent restoration shall be administered using normal Federal aid procedures that include written authorization, NEPA clearance, design approval, permits, right of way certification, PS&E, advertisement period, etc. The federal participation on eligible work will be at the normal pro rata share for the facility type (Interstate 90.66% Non-Interstate 86.5%) regardless of when the work is done. Betterments typically fall into this category of work; proper justification documentation for the betterments should be attached. Funding for this work may not be needed immediately (especially construction funding). Include documentation if funding is not needed immediately.

Appendix 33.94 Emergency Work Contract



Emergency Work Contract

THIS AGREEMENT, made and entered into this day of ,
between the (Agency name) and

<p>Contractor's name & address:</p>
--

Herein called the Contractor.

WITNESSETH:

That in consideration of the terms and conditions contained herein and made a part of this agreement, the parties hereto covenant and agree as follows:

I. The Contractor shall do all work and furnish all tools, materials, and equipment for:

<p>Description of work:</p>
--

in accordance with directions of the Engineer and in accordance with the Standard Specifications for Road and Bridge Construction (20__), Amendments to the Standard Specifications and the Special Provisions which are, by this reference, incorporated herein and made a part hereof and, shall perform any changes in the work in accord with the Contract Documents.

II. The (Agency name) hereby promises and agrees with the Contractor to employ and does employ the Contractor to do and cause to be done the above-described work and to complete and finish the same in accordance with the provisions of the of the Standard Specifications for Road Bridge and Municipal Construction, in the manner and upon conditions provided for in this contract.

III. The Contractor for himself and for his heirs, executors, administrators, successors, and assigns, does hereby agree to full performance of all covenants required of the Contractor in the Contract, and shall finish and complete all work describe in the contract no later than thirty (30) working days from the executed day and year first written below.

IV. The Contractor agrees to abide by all Federal Regulations as required including prevailing wage rates, Buy America policy, Americans with Disability Act (ADA), Davis-Bacon, and all provisions of the attached form 1273 incorporated herein as part of this contract.

V. It is further provided that no liability shall attach to the Agency by reason of entering into this contract, except as provided herein.

VI. A contract Bond will be required: Yes No

Title VI

The (Local Agency) in accordance with Title VI of the Civil Rights Act of 1964, 78 Stat. 252, 42 USC 2000d to 2000d-4 and Title 49, Code of Federal Regulations, Department of Transportation, Subtitle A, Office of the Secretary, Part 21, Nondiscrimination in Federally-Assisted Programs of the Department of Transportation issued pursuant to such Act, hereby notifies all bidders that it will affirmatively ensure that in any contract entered into pursuant to this advertisement, disadvantaged business enterprises as defined at 49 CFR Part 26 will be afforded full opportunity to submit bids in response to this invitation and will not be discriminated against on the grounds of race, color, national origin, or sex in consideration for an award.

Non-Collusion Declaration

By signing this contract, hereby declare, under penalty of perjury under the laws of the United States that the following statements are true and correct:

1. That the undersigned person(s), firm, association or corporation has (have) not, either directly or indirectly, entered into any agreement, participated in any collusion, or otherwise taken any action in restraint of free competitive bidding in connection with the project for which this proposal is submitted.
2. That by signing the signature page of this proposal, I am deemed to have signed and to have agreed to the provisions of this declaration.

NOTICE TO ALL CONTRACTORS
To report rigging activities call: **1-800-424-9071**

The U.S. Department of Transportation (USDOT) operates the above toll-free "hotline" Monday through Friday, 8:00 a.m. to 5:00 p.m., eastern time. Anyone with knowledge of possible bid rigging, bidder collusion, or other fraudulent activities should use the "hotline" to report such activities.

The "hotline" is part of USDOT's continuing effort to identify and investigate highway construction contract fraud and abuse and is operated under the direction of the USDOT Inspector General. All information will be treated confidentially and caller anonymity will be respected.

IN WITNESS WHEREOF, the Contractor has executed this instrument, on the day and year first below written and the authorized officer of _____ has caused this instrument to be executed by and in the name of the said Agency on the day and year first below written.

Executed by the Contractor this day of , .

CONTRACTOR		LOCAL AGENCY	
Signature	<input type="text"/>	Signature	<input type="text"/>
Printed	<input type="text"/>	Printed	<input type="text"/>
Title	<input type="text"/>	Title	<input type="text"/>
Date	<input type="text"/>	Date	<input type="text"/>

1 (August 6, 2012)

2 In accordance with Buy America requirements contained in 23 CFR 635.410, the major
3 quantities of steel and iron construction material that is permanently incorporated into
4 the project shall consist of American-made materials only. Buy America does not apply
5 to temporary steel items, e.g., temporary sheet piling, temporary bridges, steel
6 scaffolding and falsework.

7
8 Minor amounts of foreign steel and iron may be utilized in this project provided the cost
9 of the foreign material used does not exceed one-tenth of one percent of the total
10 contract cost or \$2,500.00, whichever is greater.

11
12 American-made material is defined as material having all manufacturing processes
13 occurring domestically. To further define the coverage, a domestic product is a
14 manufactured steel material that was produced in one of the 50 States, the District of
15 Columbia, Puerto Rico, or in the territories and possessions of the United States.

16
17 If domestically produced steel billets or iron ingots are exported outside of the area of
18 coverage, as defined above, for any manufacturing process then the resulting product
19 does not conform to the Buy America requirements. Additionally, products
20 manufactured domestically from foreign source steel billets or iron ingots do not
21 conform to the Buy America requirements because the initial melting and mixing of
22 alloys to create the material occurred in a foreign country.

23
24 Manufacturing begins with the initial melting and mixing, and continues through the
25 coating stage. Any process which modifies the chemical content, the physical size or
26 shape, or the final finish is considered a manufacturing process. The processes include
27 rolling, extruding, machining, bending, grinding, drilling, welding, and coating. The
28 action of applying a coating to steel or iron is deemed a manufacturing process.
29 Coating includes epoxy coating, galvanizing, aluminizing, painting, and any other
30 coating that protects or enhances the value of steel or iron. Any process from the
31 original reduction from ore to the finished product constitutes a manufacturing process
32 for iron.

33
34 Due to a nationwide waiver, Buy America does not apply to raw materials (iron ore and
35 alloys), scrap (recycled steel or iron), and pig iron or processed, pelletized, and reduced
36 iron ore.

37
38 The following are considered to be steel manufacturing processes:

- 39
40 1. Production of steel by any of the following processes:
41
42 a. Open hearth furnace.
43
44 b. Basic oxygen.
45
46 c. Electric furnace.
47
48 d. Direct reduction.
49
50 2. Rolling, heat treating, and any other similar processing.
51
52 3. Fabrication of the products.

06051.GR1 1

1
2
3
4
5
6
7
8
9
10
11
12

- a. Spinning wire into cable or strand.
- b. Corrugating and rolling into culverts.
- c. Shop fabrication.

A certification of materials origin will be required for any items comprised of, or containing, steel or iron construction materials prior to such items being incorporated into the permanent work. The certification shall be on DOT Form 350-109EF provided by the Engineer, or such other form the Contractor chooses, provided it contains the same information as DOT Form 350-109EF.

06051.GR1 2

REQUIRED CONTRACT PROVISIONS FEDERAL-AID CONSTRUCTION CONTRACTS
FHWA-1273 -- Revised May 1, 2012

- I. General
- II. Nondiscrimination
- III. Nonsegregated Facilities
- IV. Davis-Bacon and Related Act Provisions
- V. Contract Work Hours and Safety Standards Act Provisions
- VI. Subletting or Assigning the Contract
- VII. Safety: Accident Prevention
- VIII. False Statements Concerning Highway Projects
- IX. Implementation of Clean Air Act and Federal Water Pollution Control Act
- X. Compliance with Governmentwide Suspension and Debarment Requirements
- XI. Certification Regarding Use of Contract Funds for Lobbying

ATTACHMENTS

- A. Employment and Materials Preference for Appalachian Development Highway System or Appalachian Local Access Road Contracts (included in Appalachian contracts only)

I. GENERAL

1. Form FHWA-1273 must be physically incorporated in each construction contract funded under Title 23 (excluding emergency contracts solely intended for debris removal). The contractor (or subcontractor) must insert this form in each subcontract and further require its inclusion in all lower tier subcontracts (excluding purchase orders, rental agreements and other agreements for supplies or services).

The applicable requirements of Form FHWA-1273 are incorporated by reference for work done under any purchase order, rental agreement or agreement for other services. The prime contractor shall be responsible for compliance by any subcontractor, lower-tier subcontractor or service provider.

Form FHWA-1273 must be included in all Federal-aid design-build contracts, in all subcontracts and in lower tier subcontracts (excluding subcontracts for design services, purchase orders, rental agreements and other agreements for supplies or services). The design-builder shall be responsible for compliance by any subcontractor, lower-tier subcontractor or service provider.

Contracting agencies may reference Form FHWA-1273 in bid proposal or request for proposal documents, however, the Form FHWA-1273 must be physically incorporated (not referenced) in all contracts, subcontracts and lower-tier subcontracts (excluding purchase orders, rental agreements and other agreements for supplies or services related to a construction contract).

2. Subject to the applicability criteria noted in the following sections, these contract provisions shall apply to all work performed on the contract by the contractor's own organization and with

the assistance of workers under the contractor's immediate superintendence and to all work performed on the contract by piecework, station work, or by subcontract.

3. A breach of any of the stipulations contained in these Required Contract Provisions may be sufficient grounds for withholding of progress payments, withholding of final payment, termination of the contract, suspension / debarment or any other action determined to be appropriate by the contracting agency and FHWA.

4. Selection of Labor: During the performance of this contract, the contractor shall not use convict labor for any purpose within the limits of a construction project on a Federal-aid highway unless it is labor performed by convicts who are on parole, supervised release, or probation. The term Federal-aid highway does not include roadways functionally classified as local roads or rural minor collectors.

II. NONDISCRIMINATION

The provisions of this section related to 23 CFR Part 230 are applicable to all Federal-aid construction contracts and to all related construction subcontracts of \$10,000 or more. The provisions of 23 CFR Part 230 are not applicable to material supply, engineering, or architectural service contracts.

In addition, the contractor and all subcontractors must comply with the following policies: Executive Order 11246, 41 CFR 60, 29 CFR 1625-1627, Title 23 USC Section 140, the Rehabilitation Act of 1973, as amended (29 USC 794), Title VI of the Civil Rights Act of 1964, as amended, and related regulations including 49 CFR Parts 21, 26 and 27; and 23 CFR Parts 200, 230, and 633.

The contractor and all subcontractors must comply with: the requirements of the Equal Opportunity Clause in 41 CFR 60-1.4(b) and, for all construction contracts exceeding \$10,000, the Standard Federal Equal Employment Opportunity Construction Contract Specifications in 41 CFR 60-4.3.

Note: The U.S. Department of Labor has exclusive authority to determine compliance with Executive Order 11246 and the policies of the Secretary of Labor including 41 CFR 60, and 29 CFR 1625-1627. The contracting agency and the FHWA have the authority and the responsibility to ensure compliance with Title 23 USC Section 140, the Rehabilitation Act of 1973, as amended (29 USC 794), and Title VI of the Civil Rights Act of 1964, as amended, and related regulations including 49 CFR Parts 21, 26 and 27; and 23 CFR Parts 200, 230, and 633.

The following provision is adopted from 23 CFR 230, Appendix A, with appropriate revisions to conform to the U.S. Department of Labor (US DOL) and FHWA requirements.

1. Equal Employment Opportunity: Equal employment opportunity (EEO) requirements not to discriminate and to take affirmative action to assure equal opportunity as set forth under laws, executive orders, rules, regulations (28 CFR 35, 29 CFR 1630, 29 CFR 1625-1627, 41 CFR 60 and 49 CFR 27) and orders of the Secretary of Labor as modified by the provisions prescribed herein, and imposed pursuant to 23 U.S.C. 140 shall constitute the EEO and specific affirmative action standards for the contractor's project activities under this contract. The provisions of the Americans with Disabilities Act of 1990 (42 U.S.C. 12101 et seq.) set forth under 28 CFR 35 and 29 CFR 1630 are incorporated by reference in this contract. In the execution of this

contract, the contractor agrees to comply with the following minimum specific requirement activities of EEO:

a. The contractor will work with the contracting agency and the Federal Government to ensure that it has made every good faith effort to provide equal opportunity with respect to all of its terms and conditions of employment and in their review of activities under the contract.

b. The contractor will accept as its operating policy the following statement:

"It is the policy of this Company to assure that applicants are employed, and that employees are treated during employment, without regard to their race, religion, sex, color, national origin, age or disability. Such action shall include: employment, upgrading, demotion, or transfer; recruitment or recruitment advertising; layoff or termination; rates of pay or other forms of compensation; and selection for training, including apprenticeship, pre-apprenticeship, and/or on-the-job training."

2. EEO Officer: The contractor will designate and make known to the contracting officers an EEO Officer who will have the responsibility for and must be capable of effectively administering and promoting an active EEO program and who must be assigned adequate authority and responsibility to do so.

3. Dissemination of Policy: All members of the contractor's staff who are authorized to hire, supervise, promote, and discharge employees, or who recommend such action, or who are substantially involved in such action, will be made fully cognizant of, and will implement, the contractor's EEO policy and contractual responsibilities to provide EEO in each grade and classification of employment. To ensure that the above agreement will be met, the following actions will be taken as a minimum:

a. Periodic meetings of supervisory and personnel office employees will be conducted before the start of work and then not less often than once every six months, at which time the contractor's EEO policy and its implementation will be reviewed and explained. The meetings will be conducted by the EEO Officer.

b. All new supervisory or personnel office employees will be given a thorough indoctrination by the EEO Officer, covering all major aspects of the contractor's EEO obligations within thirty days following their reporting for duty with the contractor.

c. All personnel who are engaged in direct recruitment for the project will be instructed by the EEO Officer in the contractor's procedures for locating and hiring minorities and women.

d. Notices and posters setting forth the contractor's EEO policy will be placed in areas readily accessible to employees, applicants for employment and potential employees.

e. The contractor's EEO policy and the procedures to implement such policy will be brought to the attention of employees by means of meetings, employee handbooks, or other appropriate means.

4. Recruitment: When advertising for employees, the contractor will include in all advertisements for employees the notation: "An Equal Opportunity Employer." All such advertisements will be placed in publications having a large circulation among minorities and women in the area from which the project work force would normally be derived.

a. The contractor will, unless precluded by a valid bargaining agreement, conduct systematic and direct recruitment through public and private employee referral sources likely to yield qualified minorities and women. To meet this requirement, the contractor will identify sources of potential minority group employees, and establish with such identified sources procedures whereby minority and women applicants may be referred to the contractor for employment consideration.

b. In the event the contractor has a valid bargaining agreement providing for exclusive hiring hall referrals, the contractor is expected to observe the provisions of that agreement to the extent that the system meets the contractor's compliance with EEO contract provisions. Where implementation of such an agreement has the effect of discriminating against minorities or women, or obligates the contractor to do the same, such implementation violates Federal nondiscrimination provisions.

c. The contractor will encourage its present employees to refer minorities and women as applicants for employment. Information and procedures with regard to referring such applicants will be discussed with employees.

5. Personnel Actions: Wages, working conditions, and employee benefits shall be established and administered, and personnel actions of every type, including hiring, upgrading, promotion, transfer, demotion, layoff, and termination, shall be taken without regard to race, color, religion, sex, national origin, age or disability. The following procedures shall be followed:

a. The contractor will conduct periodic inspections of project sites to insure that working conditions and employee facilities do not indicate discriminatory treatment of project site personnel.

b. The contractor will periodically evaluate the spread of wages paid within each classification to determine any evidence of discriminatory wage practices.

c. The contractor will periodically review selected personnel actions in depth to determine whether there is evidence of discrimination. Where evidence is found, the contractor will promptly take corrective action. If the review indicates that the discrimination may extend beyond the actions reviewed, such corrective action shall include all affected persons.

d. The contractor will promptly investigate all complaints of alleged discrimination made to the contractor in connection with its obligations under this contract, will attempt to resolve such complaints, and will take appropriate corrective action within a reasonable time. If the investigation indicates that the discrimination may affect persons other than the complainant, such corrective action shall include such other persons. Upon completion of each investigation, the contractor will inform every complainant of all of their avenues of appeal.

6. Training and Promotion:

a. The contractor will assist in locating, qualifying, and increasing the skills of minorities and women who are applicants for employment or current employees. Such efforts should be aimed at developing full journey level status employees in the type of trade or job classification involved.

b. Consistent with the contractor's work force requirements and as permissible under Federal and State regulations, the contractor shall make full use of training programs, i.e., apprenticeship, and on-the-job training programs for the geographical area of contract performance. In the event a special provision for training is provided under this contract, this subparagraph will be superseded as indicated in the special provision. The contracting agency may reserve training positions for persons who receive welfare assistance in accordance with 23 U.S.C. 140(a).

c. The contractor will advise employees and applicants for employment of available training programs and entrance requirements for each.

d. The contractor will periodically review the training and promotion potential of employees who are minorities and women and will encourage eligible employees to apply for such training and promotion.

7. Unions: If the contractor relies in whole or in part upon unions as a source of employees, the contractor will use good faith efforts to obtain the cooperation of such unions to increase opportunities for minorities and women. Actions by the contractor, either directly or through a contractor's association acting as agent, will include the procedures set forth below:

a. The contractor will use good faith efforts to develop, in cooperation with the unions, joint training programs aimed toward qualifying more minorities and women for membership in the unions and increasing the skills of minorities and women so that they may qualify for higher paying employment.

b. The contractor will use good faith efforts to incorporate an EEO clause into each union agreement to the end that such union will be contractually bound to refer applicants without regard to their race, color, religion, sex, national origin, age or disability.

c. The contractor is to obtain information as to the referral practices and policies of the labor union except that to the extent such information is within the exclusive possession of the labor union and such labor union refuses to furnish such information to the contractor, the contractor shall so certify to the contracting agency and shall set forth what efforts have been made to obtain such information.

d. In the event the union is unable to provide the contractor with a reasonable flow of referrals within the time limit set forth in the collective bargaining agreement, the contractor will, through independent recruitment efforts, fill the employment vacancies without regard to race, color, religion, sex, national origin, age or disability; making full efforts to obtain qualified and/or qualifiable minorities and women. The failure of a union to provide sufficient referrals (even though it is obligated to provide exclusive referrals under the terms of a collective bargaining agreement) does not relieve the contractor from the requirements of this paragraph. In the event the union referral practice prevents the contractor from meeting the obligations pursuant to Executive Order 11246, as amended, and these special provisions, such contractor shall immediately notify the contracting agency.

8. Reasonable Accommodation for Applicants / Employees with Disabilities: The contractor must be familiar with the requirements for and comply with the Americans with Disabilities Act and all rules and regulations established there under. Employers must provide reasonable accommodation in all employment activities unless to do so would cause an undue hardship.

9. Selection of Subcontractors, Procurement of Materials and Leasing of Equipment: The contractor shall not discriminate on the grounds of race, color, religion, sex, national origin, age or disability in the selection and retention of subcontractors, including procurement of materials and leases of equipment. The contractor shall take all necessary and reasonable steps to ensure nondiscrimination in the administration of this contract.

- a. The contractor shall notify all potential subcontractors and suppliers and lessors of their EEO obligations under this contract.
- b. The contractor will use good faith efforts to ensure subcontractor compliance with their EEO obligations.

10. Assurance Required by 49 CFR 26.13(b):

- a. The requirements of 49 CFR Part 26 and the State DOT's U.S. DOT-approved DBE program are incorporated by reference.
- b. The contractor or subcontractor shall not discriminate on the basis of race, color, national origin, or sex in the performance of this contract. The contractor shall carry out applicable requirements of 49 CFR Part 26 in the award and administration of DOT-assisted contracts. Failure by the contractor to carry out these requirements is a material breach of this contract, which may result in the termination of this contract or such other remedy as the contracting agency deems appropriate.

11. Records and Reports: The contractor shall keep such records as necessary to document compliance with the EEO requirements. Such records shall be retained for a period of three years following the date of the final payment to the contractor for all contract work and shall be available at reasonable times and places for inspection by authorized representatives of the contracting agency and the FHWA.

- a. The records kept by the contractor shall document the following:
 - (1) The number and work hours of minority and non-minority group members and women employed in each work classification on the project;
 - (2) The progress and efforts being made in cooperation with unions, when applicable, to increase employment opportunities for minorities and women; and
 - (3) The progress and efforts being made in locating, hiring, training, qualifying, and upgrading minorities and women;
- b. The contractors and subcontractors will submit an annual report to the contracting agency each July for the duration of the project, indicating the number of minority, women, and non-minority group employees currently engaged in each work classification required by the contract work. This information is to be reported on [Form FHWA-1391](#). The staffing data should represent the project work force on board in all or any part of the last payroll period preceding the end of July. If on-the-job training is being required by special provision, the contractor will be required to collect and report training data. The employment data should reflect the work force on board during all or any part of the last payroll period preceding the end of July.

III. NONSEGREGATED FACILITIES

This provision is applicable to all Federal-aid construction contracts and to all related construction subcontracts of \$10,000 or more.

The contractor must ensure that facilities provided for employees are provided in such a manner that segregation on the basis of race, color, religion, sex, or national origin cannot result. The contractor may neither require such segregated use by written or oral policies nor tolerate such use by employee custom. The contractor's obligation extends further to ensure that its employees are not assigned to perform their services at any location, under the contractor's control, where the facilities are segregated. The term "facilities" includes waiting rooms, work areas, restaurants and other eating areas, time clocks, restrooms, washrooms, locker rooms, and other storage or dressing areas, parking lots, drinking fountains, recreation or entertainment areas, transportation, and housing provided for employees. The contractor shall provide separate or single-user restrooms and necessary dressing or sleeping areas to assure privacy between sexes.

IV. DAVIS-BACON AND RELATED ACT PROVISIONS

This section is applicable to all Federal-aid construction projects exceeding \$2,000 and to all related subcontracts and lower-tier subcontracts (regardless of subcontract size). The requirements apply to all projects located within the right-of-way of a roadway that is functionally classified as Federal-aid highway. This excludes roadways functionally classified as local roads or rural minor collectors, which are exempt. Contracting agencies may elect to apply these requirements to other projects.

The following provisions are from the U.S. Department of Labor regulations in 29 CFR 5.5 "Contract provisions and related matters" with minor revisions to conform to the FHWA-1273 format and FHWA program requirements.

1. Minimum wages

a. All laborers and mechanics employed or working upon the site of the work, will be paid unconditionally and not less often than once a week, and without subsequent deduction or rebate on any account (except such payroll deductions as are permitted by regulations issued by the Secretary of Labor under the Copeland Act (29 CFR part 3)), the full amount of wages and bona fide fringe benefits (or cash equivalents thereof) due at time of payment computed at rates not less than those contained in the wage determination of the Secretary of Labor which is attached hereto and made a part hereof, regardless of any contractual relationship which may be alleged to exist between the contractor and such laborers and mechanics.

Contributions made or costs reasonably anticipated for bona fide fringe benefits under section 1(b)(2) of the Davis-Bacon Act on behalf of laborers or mechanics are considered wages paid to such laborers or mechanics, subject to the provisions of paragraph 1.d. of this section; also, regular contributions made or costs incurred for more than a weekly period (but not less often than quarterly) under plans, funds, or programs which cover the particular weekly period, are deemed to be constructively made or incurred during such weekly period. Such laborers and

mechanics shall be paid the appropriate wage rate and fringe benefits on the wage determination for the classification of work actually performed, without regard to skill, except as provided in 29 CFR 5.5(a)(4). Laborers or mechanics performing work in more than one classification may be compensated at the rate specified for each classification for the time actually worked therein: Provided, That the employer's payroll records accurately set forth the time spent in each classification in which work is performed. The wage determination (including any additional classification and wage rates conformed under paragraph 1.b. of this section) and the Davis-Bacon poster (WH-1321) shall be posted at all times by the contractor and its subcontractors at the site of the work in a prominent and accessible place where it can be easily seen by the workers.

b. (1) The contracting officer shall require that any class of laborers or mechanics, including helpers, which is not listed in the wage determination and which is to be employed under the contract shall be classified in conformance with the wage determination. The contracting officer shall approve an additional classification and wage rate and fringe benefits therefore only when the following criteria have been met:

(i) The work to be performed by the classification requested is not performed by a classification in the wage determination; and

(ii) The classification is utilized in the area by the construction industry; and

(iii) The proposed wage rate, including any bona fide fringe benefits, bears a reasonable relationship to the wage rates contained in the wage determination.

(2) If the contractor and the laborers and mechanics to be employed in the classification (if known), or their representatives, and the contracting officer agree on the classification and wage rate (including the amount designated for fringe benefits where appropriate), a report of the action taken shall be sent by the contracting officer to the Administrator of the Wage and Hour Division, Employment Standards Administration, U.S. Department of Labor, Washington, DC 20210. The Administrator, or an authorized representative, will approve, modify, or disapprove every additional classification action within 30 days of receipt and so advise the contracting officer or will notify the contracting officer within the 30-day period that additional time is necessary.

(3) In the event the contractor, the laborers or mechanics to be employed in the classification or their representatives, and the contracting officer do not agree on the proposed classification and wage rate (including the amount designated for fringe benefits, where appropriate), the contracting officer shall refer the questions, including the views of all interested parties and the recommendation of the contracting officer, to the Wage and Hour Administrator for determination. The Wage and Hour Administrator, or an authorized representative, will issue a determination within 30 days of receipt and so advise the contracting officer or will notify the contracting officer within the 30-day period that additional time is necessary.

(4) The wage rate (including fringe benefits where appropriate) determined pursuant to paragraphs 1.b.(2) or 1.b.(3) of this section, shall be paid to all workers performing work in the classification under this contract from the first day on which work is performed in the classification.

c. Whenever the minimum wage rate prescribed in the contract for a class of laborers or mechanics includes a fringe benefit which is not expressed as an hourly rate, the contractor shall either pay the benefit as stated in the wage determination or shall pay another bona fide fringe benefit or an hourly cash equivalent thereof.

d. If the contractor does not make payments to a trustee or other third person, the contractor may consider as part of the wages of any laborer or mechanic the amount of any costs reasonably anticipated in providing bona fide fringe benefits under a plan or program, Provided, That the Secretary of Labor has found, upon the written request of the contractor, that the applicable standards of the Davis-Bacon Act have been met. The Secretary of Labor may require the contractor to set aside in a separate account assets for the meeting of obligations under the plan or program.

2. Withholding

The contracting agency shall upon its own action or upon written request of an authorized representative of the Department of Labor, withhold or cause to be withheld from the contractor under this contract, or any other Federal contract with the same prime contractor, or any other federally-assisted contract subject to Davis-Bacon prevailing wage requirements, which is held by the same prime contractor, so much of the accrued payments or advances as may be considered necessary to pay laborers and mechanics, including apprentices, trainees, and helpers, employed by the contractor or any subcontractor the full amount of wages required by the contract. In the event of failure to pay any laborer or mechanic, including any apprentice, trainee, or helper, employed or working on the site of the work, all or part of the wages required by the contract, the contracting agency may, after written notice to the contractor, take such action as may be necessary to cause the suspension of any further payment, advance, or guarantee of funds until such violations have ceased.

3. Payrolls and basic records

a. Payrolls and basic records relating thereto shall be maintained by the contractor during the course of the work and preserved for a period of three years thereafter for all laborers and mechanics working at the site of the work. Such records shall contain the name, address, and social security number of each such worker, his or her correct classification, hourly rates of wages paid (including rates of contributions or costs anticipated for bona fide fringe benefits or cash equivalents thereof of the types described in section 1(b)(2)(B) of the Davis-Bacon Act), daily and weekly number of hours worked, deductions made and actual wages paid. Whenever the Secretary of Labor has found under 29 CFR 5.5(a)(1)(iv) that the wages of any laborer or mechanic include the amount of any costs reasonably anticipated in providing benefits under a plan or program described in section 1(b)(2)(B) of the Davis-Bacon Act, the contractor shall maintain records which show that the commitment to provide such benefits is enforceable, that the plan or program is financially responsible, and that the plan or program has been communicated in writing to the laborers or mechanics affected, and records which show the costs anticipated or the actual cost incurred in providing such benefits. Contractors employing apprentices or trainees under approved programs shall maintain written evidence of the registration of apprenticeship programs and certification of trainee programs, the registration of the apprentices and trainees, and the ratios and wage rates prescribed in the applicable programs.

b. (1) The contractor shall submit weekly for each week in which any contract work is performed a copy of all payrolls to the contracting agency. The payrolls submitted shall set out accurately and completely all of the information required to be maintained under 29 CFR 5.5(a)(3)(i), except that full social security numbers and home addresses shall not be included on weekly transmittals. Instead the payrolls shall only need to include an individually identifying number for each employee (e.g. , the last four digits of the employee's social security number). The required weekly payroll information may be submitted in any form desired. Optional Form WH-347 is available for this purpose from the Wage and Hour Division Web site at <http://www.dol.gov/esa/whd/forms/wh347instr.htm> or its successor site. The prime contractor is responsible for the submission of copies of payrolls by all subcontractors. Contractors and subcontractors shall maintain the full social security number and current address of each covered worker, and shall provide them upon request to the contracting agency for transmission to the State DOT, the FHWA or the Wage and Hour Division of the Department of Labor for purposes of an investigation or audit of compliance with prevailing wage requirements. It is not a violation of this section for a prime contractor to require a subcontractor to provide addresses and social security numbers to the prime contractor for its own records, without weekly submission to the contracting agency..

(2) Each payroll submitted shall be accompanied by a "Statement of Compliance," signed by the contractor or subcontractor or his or her agent who pays or supervises the payment of the persons employed under the contract and shall certify the following:

(i) That the payroll for the payroll period contains the information required to be provided under §5.5 (a)(3)(ii) of Regulations, 29 CFR part 5, the appropriate information is being maintained under §5.5 (a)(3)(i) of Regulations, 29 CFR part 5, and that such information is correct and complete;

(ii) That each laborer or mechanic (including each helper, apprentice, and trainee) employed on the contract during the payroll period has been paid the full weekly wages earned, without rebate, either directly or indirectly, and that no deductions have been made either directly or indirectly from the full wages earned, other than permissible deductions as set forth in Regulations, 29 CFR part 3;

(iii) That each laborer or mechanic has been paid not less than the applicable wage rates and fringe benefits or cash equivalents for the classification of work performed, as specified in the applicable wage determination incorporated into the contract.

(3) The weekly submission of a properly executed certification set forth on the reverse side of Optional Form WH-347 shall satisfy the requirement for submission of the "Statement of Compliance" required by paragraph 3.b.(2) of this section.

(4) The falsification of any of the above certifications may subject the contractor or subcontractor to civil or criminal prosecution under section 1001 of title 18 and section 231 of title 31 of the United States Code.

c. The contractor or subcontractor shall make the records required under paragraph 3.a. of this section available for inspection, copying, or transcription by authorized representatives of the contracting agency, the State DOT, the FHWA, or the Department of Labor, and shall permit such representatives to interview employees during working hours on the job. If the contractor or subcontractor fails to submit the required records or to make them available, the FHWA may,

after written notice to the contractor, the contracting agency or the State DOT, take such action as may be necessary to cause the suspension of any further payment, advance, or guarantee of funds. Furthermore, failure to submit the required records upon request or to make such records available may be grounds for debarment action pursuant to 29 CFR 5.12.

4. Apprentices and trainees

a. Apprentices (programs of the USDOL).

Apprentices will be permitted to work at less than the predetermined rate for the work they performed when they are employed pursuant to and individually registered in a bona fide apprenticeship program registered with the U.S. Department of Labor, Employment and Training Administration, Office of Apprenticeship Training, Employer and Labor Services, or with a State Apprenticeship Agency recognized by the Office, or if a person is employed in his or her first 90 days of probationary employment as an apprentice in such an apprenticeship program, who is not individually registered in the program, but who has been certified by the Office of Apprenticeship Training, Employer and Labor Services or a State Apprenticeship Agency (where appropriate) to be eligible for probationary employment as an apprentice.

The allowable ratio of apprentices to journeymen on the job site in any craft classification shall not be greater than the ratio permitted to the contractor as to the entire work force under the registered program. Any worker listed on a payroll at an apprentice wage rate, who is not registered or otherwise employed as stated above, shall be paid not less than the applicable wage rate on the wage determination for the classification of work actually performed. In addition, any apprentice performing work on the job site in excess of the ratio permitted under the registered program shall be paid not less than the applicable wage rate on the wage determination for the work actually performed. Where a contractor is performing construction on a project in a locality other than that in which its program is registered, the ratios and wage rates (expressed in percentages of the journeyman's hourly rate) specified in the contractor's or subcontractor's registered program shall be observed.

Every apprentice must be paid at not less than the rate specified in the registered program for the apprentice's level of progress, expressed as a percentage of the journeymen hourly rate specified in the applicable wage determination. Apprentices shall be paid fringe benefits in accordance with the provisions of the apprenticeship program. If the apprenticeship program does not specify fringe benefits, apprentices must be paid the full amount of fringe benefits listed on the wage determination for the applicable classification. If the Administrator determines that a different practice prevails for the applicable apprentice classification, fringes shall be paid in accordance with that determination.

In the event the Office of Apprenticeship Training, Employer and Labor Services, or a State Apprenticeship Agency recognized by the Office, withdraws approval of an apprenticeship program, the contractor will no longer be permitted to utilize apprentices at less than the applicable predetermined rate for the work performed until an acceptable program is approved.

b. Trainees (programs of the USDOL).

Except as provided in 29 CFR 5.16, trainees will not be permitted to work at less than the predetermined rate for the work performed unless they are employed pursuant to and

individually registered in a program which has received prior approval, evidenced by formal certification by the U.S. Department of Labor, Employment and Training Administration.

The ratio of trainees to journeymen on the job site shall not be greater than permitted under the plan approved by the Employment and Training Administration.

Every trainee must be paid at not less than the rate specified in the approved program for the trainee's level of progress, expressed as a percentage of the journeyman hourly rate specified in the applicable wage determination. Trainees shall be paid fringe benefits in accordance with the provisions of the trainee program. If the trainee program does not mention fringe benefits, trainees shall be paid the full amount of fringe benefits listed on the wage determination unless the Administrator of the Wage and Hour Division determines that there is an apprenticeship program associated with the corresponding journeyman wage rate on the wage determination which provides for less than full fringe benefits for apprentices. Any employee listed on the payroll at a trainee rate who is not registered and participating in a training plan approved by the Employment and Training Administration shall be paid not less than the applicable wage rate on the wage determination for the classification of work actually performed. In addition, any trainee performing work on the job site in excess of the ratio permitted under the registered program shall be paid not less than the applicable wage rate on the wage determination for the work actually performed.

In the event the Employment and Training Administration withdraws approval of a training program, the contractor will no longer be permitted to utilize trainees at less than the applicable predetermined rate for the work performed until an acceptable program is approved.

c. Equal employment opportunity. The utilization of apprentices, trainees and journeymen under this part shall be in conformity with the equal employment opportunity requirements of Executive Order 11246, as amended, and 29 CFR part 30.

d. Apprentices and Trainees (programs of the U.S. DOT).

Apprentices and trainees working under apprenticeship and skill training programs which have been certified by the Secretary of Transportation as promoting EEO in connection with Federal-aid highway construction programs are not subject to the requirements of paragraph 4 of this Section IV. The straight time hourly wage rates for apprentices and trainees under such programs will be established by the particular programs. The ratio of apprentices and trainees to journeymen shall not be greater than permitted by the terms of the particular program.

5. Compliance with Copeland Act requirements. The contractor shall comply with the requirements of 29 CFR part 3, which are incorporated by reference in this contract.

6. Subcontracts. The contractor or subcontractor shall insert Form FHWA-1273 in any subcontracts and also require the subcontractors to include Form FHWA-1273 in any lower tier subcontracts. The prime contractor shall be responsible for the compliance by any subcontractor or lower tier subcontractor with all the contract clauses in 29 CFR 5.5.

7. Contract termination: debarment. A breach of the contract clauses in 29 CFR 5.5 may be grounds for termination of the contract, and for debarment as a contractor and a subcontractor as provided in 29 CFR 5.12.

8. Compliance with Davis-Bacon and Related Act requirements. All rulings and interpretations of the Davis-Bacon and Related Acts contained in 29 CFR parts 1, 3, and 5 are herein incorporated by reference in this contract.

9. Disputes concerning labor standards. Disputes arising out of the labor standards provisions of this contract shall not be subject to the general disputes clause of this contract. Such disputes shall be resolved in accordance with the procedures of the Department of Labor set forth in 29 CFR parts 5, 6, and 7. Disputes within the meaning of this clause include disputes between the contractor (or any of its subcontractors) and the contracting agency, the U.S. Department of Labor, or the employees or their representatives.

10. Certification of eligibility.

a. By entering into this contract, the contractor certifies that neither it (nor he or she) nor any person or firm who has an interest in the contractor's firm is a person or firm ineligible to be awarded Government contracts by virtue of section 3(a) of the Davis-Bacon Act or 29 CFR 5.12(a)(1).

b. No part of this contract shall be subcontracted to any person or firm ineligible for award of a Government contract by virtue of section 3(a) of the Davis-Bacon Act or 29 CFR 5.12(a)(1).

c. The penalty for making false statements is prescribed in the U.S. Criminal Code, 18 U.S.C. 1001.

V. CONTRACT WORK HOURS AND SAFETY STANDARDS ACT

The following clauses apply to any Federal-aid construction contract in an amount in excess of \$100,000 and subject to the overtime provisions of the Contract Work Hours and Safety Standards Act. These clauses shall be inserted in addition to the clauses required by 29 CFR 5.5(a) or 29 CFR 4.6. As used in this paragraph, the terms laborers and mechanics include watchmen and guards.

1. Overtime requirements. No contractor or subcontractor contracting for any part of the contract work which may require or involve the employment of laborers or mechanics shall require or permit any such laborer or mechanic in any workweek in which he or she is employed on such work to work in excess of forty hours in such workweek unless such laborer or mechanic receives compensation at a rate not less than one and one-half times the basic rate of pay for all hours worked in excess of forty hours in such workweek.

2. Violation; liability for unpaid wages; liquidated damages. In the event of any violation of the clause set forth in paragraph (1.) of this section, the contractor and any subcontractor responsible therefor shall be liable for the unpaid wages. In addition, such contractor and subcontractor shall be liable to the United States (in the case of work done under contract for the District of Columbia or a territory, to such District or to such territory), for liquidated damages. Such liquidated damages shall be computed with respect to each individual laborer or mechanic, including watchmen and guards, employed in violation of the clause set forth in paragraph (1.) of this section, in the sum of \$10 for each calendar day on which such individual

was required or permitted to work in excess of the standard workweek of forty hours without payment of the overtime wages required by the clause set forth in paragraph (1.) of this section.

3. Withholding for unpaid wages and liquidated damages. The FHWA or the contacting agency shall upon its own action or upon written request of an authorized representative of the Department of Labor withhold or cause to be withheld, from any moneys payable on account of work performed by the contractor or subcontractor under any such contract or any other Federal contract with the same prime contractor, or any other federally-assisted contract subject to the Contract Work Hours and Safety Standards Act, which is held by the same prime contractor, such sums as may be determined to be necessary to satisfy any liabilities of such contractor or subcontractor for unpaid wages and liquidated damages as provided in the clause set forth in paragraph (2.) of this section.

4. Subcontracts. The contractor or subcontractor shall insert in any subcontracts the clauses set forth in paragraph (1.) through (4.) of this section and also a clause requiring the subcontractors to include these clauses in any lower tier subcontracts. The prime contractor shall be responsible for compliance by any subcontractor or lower tier subcontractor with the clauses set forth in paragraphs (1.) through (4.) of this section.

VI. SUBLETTING OR ASSIGNING THE CONTRACT

This provision is applicable to all Federal-aid construction contracts on the National Highway System.

1. The contractor shall perform with its own organization contract work amounting to not less than 30 percent (or a greater percentage if specified elsewhere in the contract) of the total original contract price, excluding any specialty items designated by the contracting agency. Specialty items may be performed by subcontract and the amount of any such specialty items performed may be deducted from the total original contract price before computing the amount of work required to be performed by the contractor's own organization (23 CFR 635.116).

a. The term "perform work with its own organization" refers to workers employed or leased by the prime contractor, and equipment owned or rented by the prime contractor, with or without operators. Such term does not include employees or equipment of a subcontractor or lower tier subcontractor, agents of the prime contractor, or any other assignees. The term may include payments for the costs of hiring leased employees from an employee leasing firm meeting all relevant Federal and State regulatory requirements. Leased employees may only be included in this term if the prime contractor meets all of the following conditions:

- (1) the prime contractor maintains control over the supervision of the day-to-day activities of the leased employees;
- (2) the prime contractor remains responsible for the quality of the work of the leased employees;
- (3) the prime contractor retains all power to accept or exclude individual employees from work on the project; and

(4) the prime contractor remains ultimately responsible for the payment of predetermined minimum wages, the submission of payrolls, statements of compliance and all other Federal regulatory requirements.

b. "Specialty Items" shall be construed to be limited to work that requires highly specialized knowledge, abilities, or equipment not ordinarily available in the type of contracting organizations qualified and expected to bid or propose on the contract as a whole and in general are to be limited to minor components of the overall contract.

2. The contract amount upon which the requirements set forth in paragraph (1) of Section VI is computed includes the cost of material and manufactured products which are to be purchased or produced by the contractor under the contract provisions.

3. The contractor shall furnish (a) a competent superintendent or supervisor who is employed by the firm, has full authority to direct performance of the work in accordance with the contract requirements, and is in charge of all construction operations (regardless of who performs the work) and (b) such other of its own organizational resources (supervision, management, and engineering services) as the contracting officer determines is necessary to assure the performance of the contract.

4. No portion of the contract shall be sublet, assigned or otherwise disposed of except with the written consent of the contracting officer, or authorized representative, and such consent when given shall not be construed to relieve the contractor of any responsibility for the fulfillment of the contract. Written consent will be given only after the contracting agency has assured that each subcontract is evidenced in writing and that it contains all pertinent provisions and requirements of the prime contract.

5. The 30% self-performance requirement of paragraph (1) is not applicable to design-build contracts; however, contracting agencies may establish their own self-performance requirements.

VII. SAFETY: ACCIDENT PREVENTION

This provision is applicable to all Federal-aid construction contracts and to all related subcontracts.

1. In the performance of this contract the contractor shall comply with all applicable Federal, State, and local laws governing safety, health, and sanitation (23 CFR 635). The contractor shall provide all safeguards, safety devices and protective equipment and take any other needed actions as it determines, or as the contracting officer may determine, to be reasonably necessary to protect the life and health of employees on the job and the safety of the public and to protect property in connection with the performance of the work covered by the contract.

2. It is a condition of this contract, and shall be made a condition of each subcontract, which the contractor enters into pursuant to this contract, that the contractor and any subcontractor shall not permit any employee, in performance of the contract, to work in surroundings or under conditions which are unsanitary, hazardous or dangerous to his/her health or safety, as determined under construction safety and health standards (29 CFR 1926) promulgated by the Secretary of Labor, in accordance with Section 107 of the Contract Work Hours and Safety Standards Act (40 U.S.C. 3704).

3. Pursuant to 29 CFR 1926.3, it is a condition of this contract that the Secretary of Labor or authorized representative thereof, shall have right of entry to any site of contract performance to inspect or investigate the matter of compliance with the construction safety and health standards and to carry out the duties of the Secretary under Section 107 of the Contract Work Hours and Safety Standards Act (40 U.S.C.3704).

VIII. FALSE STATEMENTS CONCERNING HIGHWAY PROJECTS

This provision is applicable to all Federal-aid construction contracts and to all related subcontracts.

In order to assure high quality and durable construction in conformity with approved plans and specifications and a high degree of reliability on statements and representations made by engineers, contractors, suppliers, and workers on Federal-aid highway projects, it is essential that all persons concerned with the project perform their functions as carefully, thoroughly, and honestly as possible. Willful falsification, distortion, or misrepresentation with respect to any facts related to the project is a violation of Federal law. To prevent any misunderstanding regarding the seriousness of these and similar acts, Form FHWA-1022 shall be posted on each Federal-aid highway project (23 CFR 635) in one or more places where it is readily available to all persons concerned with the project:

18 U.S.C. 1020 reads as follows:

"Whoever, being an officer, agent, or employee of the United States, or of any State or Territory, or whoever, whether a person, association, firm, or corporation, knowingly makes any false statement, false representation, or false report as to the character, quality, quantity, or cost of the material used or to be used, or the quantity or quality of the work performed or to be performed, or the cost thereof in connection with the submission of plans, maps, specifications, contracts, or costs of construction on any highway or related project submitted for approval to the Secretary of Transportation; or

Whoever knowingly makes any false statement, false representation, false report or false claim with respect to the character, quality, quantity, or cost of any work performed or to be performed, or materials furnished or to be furnished, in connection with the construction of any highway or related project approved by the Secretary of Transportation; or

Whoever knowingly makes any false statement or false representation as to material fact in any statement, certificate, or report submitted pursuant to provisions of the Federal-aid Roads Act approved July 1, 1916, (39 Stat. 355), as amended and supplemented;

Shall be fined under this title or imprisoned not more than 5 years or both."

IX. IMPLEMENTATION OF CLEAN AIR ACT AND FEDERAL WATER POLLUTION CONTROL ACT

This provision is applicable to all Federal-aid construction contracts and to all related subcontracts.

By submission of this bid/proposal or the execution of this contract, or subcontract, as appropriate, the bidder, proposer, Federal-aid construction contractor, or subcontractor, as appropriate, will be deemed to have stipulated as follows:

1. That any person who is or will be utilized in the performance of this contract is not prohibited from receiving an award due to a violation of Section 508 of the Clean Water Act or Section 306 of the Clean Air Act.
2. That the contractor agrees to include or cause to be included the requirements of paragraph (1) of this Section X in every subcontract, and further agrees to take such action as the contracting agency may direct as a means of enforcing such requirements.

X. CERTIFICATION REGARDING DEBARMENT, SUSPENSION, INELIGIBILITY AND VOLUNTARY EXCLUSION

This provision is applicable to all Federal-aid construction contracts, design-build contracts, subcontracts, lower-tier subcontracts, purchase orders, lease agreements, consultant contracts or any other covered transaction requiring FHWA approval or that is estimated to cost \$25,000 or more – as defined in 2 CFR Parts 180 and 1200.

1. Instructions for Certification – First Tier Participants:

a. By signing and submitting this proposal, the prospective first tier participant is providing the certification set out below.

b. The inability of a person to provide the certification set out below will not necessarily result in denial of participation in this covered transaction. The prospective first tier participant shall submit an explanation of why it cannot provide the certification set out below. The certification or explanation will be considered in connection with the department or agency's determination whether to enter into this transaction. However, failure of the prospective first tier participant to furnish a certification or an explanation shall disqualify such a person from participation in this transaction.

c. The certification in this clause is a material representation of fact upon which reliance was placed when the contracting agency determined to enter into this transaction. If it is later determined that the prospective participant knowingly rendered an erroneous certification, in addition to other remedies available to the Federal Government, the contracting agency may terminate this transaction for cause of default.

d. The prospective first tier participant shall provide immediate written notice to the contracting agency to whom this proposal is submitted if any time the prospective first tier participant learns that its certification was erroneous when submitted or has become erroneous by reason of changed circumstances.

e. The terms "covered transaction," "debarred," "suspended," "ineligible," "participant," "person," "principal," and "voluntarily excluded," as used in this clause, are defined in 2 CFR Parts 180 and 1200. "First Tier Covered Transactions" refers to any covered transaction between a grantee or subgrantee of Federal funds and a participant (such as the prime or

general contract). "Lower Tier Covered Transactions" refers to any covered transaction under a First Tier Covered Transaction (such as subcontracts). "First Tier Participant" refers to the participant who has entered into a covered transaction with a grantee or subgrantee of Federal funds (such as the prime or general contractor). "Lower Tier Participant" refers any participant who has entered into a covered transaction with a First Tier Participant or other Lower Tier Participants (such as subcontractors and suppliers).

f. The prospective first tier participant agrees by submitting this proposal that, should the proposed covered transaction be entered into, it shall not knowingly enter into any lower tier covered transaction with a person who is debarred, suspended, declared ineligible, or voluntarily excluded from participation in this covered transaction, unless authorized by the department or agency entering into this transaction.

g. The prospective first tier participant further agrees by submitting this proposal that it will include the clause titled "Certification Regarding Debarment, Suspension, Ineligibility and Voluntary Exclusion-Lower Tier Covered Transactions," provided by the department or contracting agency, entering into this covered transaction, without modification, in all lower tier covered transactions and in all solicitations for lower tier covered transactions exceeding the \$25,000 threshold.

h. A participant in a covered transaction may rely upon a certification of a prospective participant in a lower tier covered transaction that is not debarred, suspended, ineligible, or voluntarily excluded from the covered transaction, unless it knows that the certification is erroneous. A participant is responsible for ensuring that its principals are not suspended, debarred, or otherwise ineligible to participate in covered transactions. To verify the eligibility of its principals, as well as the eligibility of any lower tier prospective participants, each participant may, but is not required to, check the Excluded Parties List System website (<https://www.epls.gov/>), which is compiled by the General Services Administration.

i. Nothing contained in the foregoing shall be construed to require the establishment of a system of records in order to render in good faith the certification required by this clause. The knowledge and information of the prospective participant is not required to exceed that which is normally possessed by a prudent person in the ordinary course of business dealings.

j. Except for transactions authorized under paragraph (f) of these instructions, if a participant in a covered transaction knowingly enters into a lower tier covered transaction with a person who is suspended, debarred, ineligible, or voluntarily excluded from participation in this transaction, in addition to other remedies available to the Federal Government, the department or agency may terminate this transaction for cause or default.

* * * * *

2. Certification Regarding Debarment, Suspension, Ineligibility and Voluntary Exclusion – First Tier Participants:

a. The prospective first tier participant certifies to the best of its knowledge and belief, that it and its principals:

(1) Are not presently debarred, suspended, proposed for debarment, declared ineligible, or voluntarily excluded from participating in covered transactions by any Federal department or agency;

(2) Have not within a three-year period preceding this proposal been convicted of or had a civil judgment rendered against them for commission of fraud or a criminal offense in connection with obtaining, attempting to obtain, or performing a public (Federal, State or local) transaction or contract under a public transaction; violation of Federal or State antitrust statutes or commission of embezzlement, theft, forgery, bribery, falsification or destruction of records, making false statements, or receiving stolen property;

(3) Are not presently indicted for or otherwise criminally or civilly charged by a governmental entity (Federal, State or local) with commission of any of the offenses enumerated in paragraph (a)(2) of this certification; and

(4) Have not within a three-year period preceding this application/proposal had one or more public transactions (Federal, State or local) terminated for cause or default.

b. Where the prospective participant is unable to certify to any of the statements in this certification, such prospective participant shall attach an explanation to this proposal.

2. Instructions for Certification - Lower Tier Participants:

(Applicable to all subcontracts, purchase orders and other lower tier transactions requiring prior FHWA approval or estimated to cost \$25,000 or more - 2 CFR Parts 180 and 1200)

a. By signing and submitting this proposal, the prospective lower tier is providing the certification set out below.

b. The certification in this clause is a material representation of fact upon which reliance was placed when this transaction was entered into. If it is later determined that the prospective lower tier participant knowingly rendered an erroneous certification, in addition to other remedies available to the Federal Government, the department, or agency with which this transaction originated may pursue available remedies, including suspension and/or debarment.

c. The prospective lower tier participant shall provide immediate written notice to the person to which this proposal is submitted if at any time the prospective lower tier participant learns that its certification was erroneous by reason of changed circumstances.

d. The terms "covered transaction," "debarred," "suspended," "ineligible," "participant," "person," "principal," and "voluntarily excluded," as used in this clause, are defined in 2 CFR Parts 180 and 1200. You may contact the person to which this proposal is submitted for assistance in obtaining a copy of those regulations. "First Tier Covered Transactions" refers to any covered transaction between a grantee or subgrantee of Federal funds and a participant (such as the prime or general contract). "Lower Tier Covered Transactions" refers to any covered transaction under a First Tier Covered Transaction (such as subcontracts). "First Tier Participant" refers to the participant who has entered into a covered transaction with a grantee or subgrantee of Federal funds (such as the prime or general contractor). "Lower Tier Participant" refers any participant who has entered into a covered transaction with a First Tier Participant or other Lower Tier Participants (such as subcontractors and suppliers).

e. The prospective lower tier participant agrees by submitting this proposal that, should the proposed covered transaction be entered into, it shall not knowingly enter into any lower tier covered transaction with a person who is debarred, suspended, declared ineligible, or

voluntarily excluded from participation in this covered transaction, unless authorized by the department or agency with which this transaction originated.

f. The prospective lower tier participant further agrees by submitting this proposal that it will include this clause titled "Certification Regarding Debarment, Suspension, Ineligibility and Voluntary Exclusion-Lower Tier Covered Transaction," without modification, in all lower tier covered transactions and in all solicitations for lower tier covered transactions exceeding the \$25,000 threshold.

g. A participant in a covered transaction may rely upon a certification of a prospective participant in a lower tier covered transaction that is not debarred, suspended, ineligible, or voluntarily excluded from the covered transaction, unless it knows that the certification is erroneous. A participant is responsible for ensuring that its principals are not suspended, debarred, or otherwise ineligible to participate in covered transactions. To verify the eligibility of its principals, as well as the eligibility of any lower tier prospective participants, each participant may, but is not required to, check the Excluded Parties List System website (<https://www.epls.gov/>), which is compiled by the General Services Administration.

h. Nothing contained in the foregoing shall be construed to require establishment of a system of records in order to render in good faith the certification required by this clause. The knowledge and information of participant is not required to exceed that which is normally possessed by a prudent person in the ordinary course of business dealings.

i. Except for transactions authorized under paragraph e of these instructions, if a participant in a covered transaction knowingly enters into a lower tier covered transaction with a person who is suspended, debarred, ineligible, or voluntarily excluded from participation in this transaction, in addition to other remedies available to the Federal Government, the department or agency with which this transaction originated may pursue available remedies, including suspension and/or debarment.

* * * * *

**Certification Regarding Debarment, Suspension, Ineligibility and Voluntary Exclusion--
Lower Tier Participants:**

1. The prospective lower tier participant certifies, by submission of this proposal, that neither it nor its principals is presently debarred, suspended, proposed for debarment, declared ineligible, or voluntarily excluded from participating in covered transactions by any Federal department or agency.

2. Where the prospective lower tier participant is unable to certify to any of the statements in this certification, such prospective participant shall attach an explanation to this proposal.

* * * * *

XI. CERTIFICATION REGARDING USE OF CONTRACT FUNDS FOR LOBBYING

This provision is applicable to all Federal-aid construction contracts and to all related subcontracts which exceed \$100,000 (49 CFR 20).

1. The prospective participant certifies, by signing and submitting this bid or proposal, to the best of his or her knowledge and belief, that:

a. No Federal appropriated funds have been paid or will be paid, by or on behalf of the undersigned, to any person for influencing or attempting to influence an officer or employee of any Federal agency, a Member of Congress, an officer or employee of Congress, or an employee of a Member of Congress in connection with the awarding of any Federal contract, the making of any Federal grant, the making of any Federal loan, the entering into of any cooperative agreement, and the extension, continuation, renewal, amendment, or modification of any Federal contract, grant, loan, or cooperative agreement.

b. If any funds other than Federal appropriated funds have been paid or will be paid to any person for influencing or attempting to influence an officer or employee of any Federal agency, a Member of Congress, an officer or employee of Congress, or an employee of a Member of Congress in connection with this Federal contract, grant, loan, or cooperative agreement, the undersigned shall complete and submit Standard Form-LLL, "Disclosure Form to Report Lobbying," in accordance with its instructions.

2. This certification is a material representation of fact upon which reliance was placed when this transaction was made or entered into. Submission of this certification is a prerequisite for making or entering into this transaction imposed by 31 U.S.C. 1352. Any person who fails to file the required certification shall be subject to a civil penalty of not less than \$10,000 and not more than \$100,000 for each such failure.

3. The prospective participant also agrees by submitting its bid or proposal that the participant shall require that the language of this certification be included in all lower tier subcontracts, which exceed \$100,000 and that all such recipients shall certify and disclose accordingly.

ATTACHMENT A - EMPLOYMENT AND MATERIALS PREFERENCE FOR APPALACHIAN DEVELOPMENT HIGHWAY SYSTEM OR APPALACHIAN LOCAL ACCESS ROAD CONTRACTS

This provision is applicable to all Federal-aid projects funded under the Appalachian Regional Development Act of 1965.

1. During the performance of this contract, the contractor undertaking to do work which is, or reasonably may be, done as on-site work, shall give preference to qualified persons who regularly reside in the labor area as designated by the DOL wherein the contract work is situated, or the subregion, or the Appalachian counties of the State wherein the contract work is situated, except:

- a. To the extent that qualified persons regularly residing in the area are not available.
- b. For the reasonable needs of the contractor to employ supervisory or specially experienced personnel necessary to assure an efficient execution of the contract work.
- c. For the obligation of the contractor to offer employment to present or former employees as the result of a lawful collective bargaining contract, provided that the number of nonresident persons employed under this subparagraph (1c) shall not exceed 20 percent of the total number of employees employed by the contractor on the contract work, except as provided in subparagraph (4) below.

2. The contractor shall place a job order with the State Employment Service indicating (a) the classifications of the laborers, mechanics and other employees required to perform the contract work, (b) the number of employees required in each classification, (c) the date on which the participant estimates such employees will be required, and (d) any other pertinent information required by the State Employment Service to complete the job order form. The job order may be placed with the State Employment Service in writing or by telephone. If during the course of the contract work, the information submitted by the contractor in the original job order is substantially modified, the participant shall promptly notify the State Employment Service.

3. The contractor shall give full consideration to all qualified job applicants referred to him by the State Employment Service. The contractor is not required to grant employment to any job applicants who, in his opinion, are not qualified to perform the classification of work required.

4. If, within one week following the placing of a job order by the contractor with the State Employment Service, the State Employment Service is unable to refer any qualified job applicants to the contractor, or less than the number requested, the State Employment Service will forward a certificate to the contractor indicating the unavailability of applicants. Such certificate shall be made a part of the contractor's permanent project records. Upon receipt of this certificate, the contractor may employ persons who do not normally reside in the labor area to fill positions covered by the certificate, notwithstanding the provisions of subparagraph (1c) above.

5. The provisions of 23 CFR 633.207(e) allow the contracting agency to provide a contractual preference for the use of mineral resource materials native to the Appalachian region.

6. The contractor shall include the provisions of Sections 1 through 4 of this Attachment A in every subcontract for work which is, or reasonably may be, done as on-site work.

**AMENDMENT
REQUIRED CONTRACT PROVISIONS**
(Exclusive of Appalachian Contracts)

FEDERAL-AID CONSTRUCTION CONTRACTS

The Federal–Aid provisions are supplemented with the following:

XII. Cargo Preference Act

1. U.S. Department of Transportation Federal Highway Administration memorandum dated December 11, 2015 requires that all federal-aid highway programs awarded after February 15, 2016 must comply with the Cargo Preference Act and its regulation of 46 CFR 381.7 (a)-(b).

Amendment to Form FHWA 1273
Revised January 25, 2016

Chapter 34 *Local Bridge Program*

34.1 **General Discussion**

The primary objective of the Local Bridge Program (LBP) is to ensure public safety through inspection, rehabilitation, and replacement of bridges that meet the requirements for inclusion in the National Bridge Inventory (NBI) as defined by the National Bridge Inspection Standards (NBIS). The bridges that would be eligible for rehabilitation and or replacement using federal funds are described in [Section 34.41](#).

This chapter describes the national requirements for bridge inspection programs and for selecting bridge projects to be funded using federal funds.

34.2 **Bridge Condition Inspection Program**

A methodical Bridge Inspection Program is required for agencies that want to qualify for LBP funds.

The Federal Highway Administration (FHWA) has set the national standards for the proper safety inspection and evaluation of bridges in a document called the National Bridge Inspection Standards (NBIS). These standards are located in the Code of Federal Regulations, Title 23 Highways Part 650, Subpart C. The latest electronic version of the NBIS can be found online at www.fhwa.dot.gov/bridge/. Information and guidance on bridge condition inspection in Washington State is located in the [Washington State Bridge Inspection Manual](#) (WSBIM) M 36-64. Reference these documents for additional information on the following subjects. In the event of conflicting information or requirements between the [WSBIM](#) and [Sections 34.2](#) and [34.3](#) of this manual, the [WSBIM](#) will govern.

.21 Delegation of Bridge Program Manager Status – Each State Transportation Department is required to have an Inspection Organization responsible to inspect, or cause to be inspected, all highway bridges located on public roads that are fully or partially within the State’s boundaries, except for bridges owned by Federal agencies. The WSDOT Local Agency Bridge Engineer has been delegated as the Program Manager for county and city owned bridges. The NBIS contains provisions to allow further delegation of bridge program functions identified in §650.307(c)(2) to qualified Local Agency bridge program personnel. See [Appendix 34.54](#).

.22 Bridge Inspection Types and Frequencies – Each structure in the National Bridge Inventory (NBI) shall receive a routine inspection at intervals not to exceed 24 months except as provided in the NBIS.

Inspection frequency requirements are listed in Section §650.311 of the NBIS. These requirements are also outlined in the flowchart in [Appendix 34.52](#) and are detailed in the [WSBIM](#). The Local Programs Bridge Inventory Engineer will perform quarterly reviews of the Local Agency Bridge Inventory to ensure that bridge inspections are being performed on time. Local Agencies will be provided with lists of bridges and the projected inspection dates to cross check with their own inspection list to ensure concurrence and identify any omissions. Bridges shall be inspected in the calendar month that is the result of the current inspection month plus the assigned inspection frequency in months. This usually means the inspection will happen in the same calendar month for future inspection years. The inspection update should be entered into the inventory

within 30 days. This allows Local Programs to monitor inspection progress and provides a record of inspection date compliance. Once inspections are performed, Local Agencies have 90 days to finish the inspections report and have the data released to the NBI.

Local Agencies will be notified of bridge records that do not have current inspection dates because the field inspection has not been done or because the information has not been released to the NBI. This notification will be first in the form of email or other correspondence with the Local Programs Bridge Office. If corrections are not made within 30 days of notification, the second notification will be a formal letter of noncompliance from the Local Programs Engineering Service Manager with a corrective action plan. Finally, failure to carry out the corrective action plan will result in formal notification from the Director, Local Programs that federal funds may be restricted until compliance is met.

.23 Qualification of Bridge Inspection Personnel – Federal regulations specify the requirements for two positions within a Bridge Inspection organization:

- Bridge Program Manager – hereafter Program Manager
- Bridge Inspection Team Leader – hereafter Team Leader

The Program Manager is the individual charged with managing a specific bridge program and who has been delegated the duties of ensuring timely bridge inspection and reporting and that bridge records are current and valid. The Program Manager provides overall leadership and guidance to bridge program personnel.

Minimum Qualifications for Program Manager are:

- Registered Professional Engineer or 120 months of bridge inspection experience
- Successful completion of FHWA approved Comprehensive Bridge Inspection Training Course

The **Team Leader** is the individual in charge of an inspection team and is responsible for planning, preparing, and performing bridge inspections. The Team Leader is required to be onsite for all condition inspection activities on NBI bridges, and is responsible for inspection reporting and for accurate inventory coding. Qualified Team Leaders are certified by WSDOT and are issued an inspector identification number. Noncertified bridge inspectors are not allowed to submit bridge inspection data for NBI bridges to the inventory.

Minimum Qualifications for Team Leader are:

- Qualified Program Manager
- Or, 60 months of bridge inspection experience and successful completion of FHWA approved Comprehensive Bridge Inspection Training Course
- Or, Certified Level III or IV NICET bridge safety inspector and successful completion of FHWA approved Comprehensive Bridge Inspection Training Course
- Or, BS degree in engineering, and successfully passed EIT, and 24 months Bridge Inspection experience, and successful completion of FHWA approved Comprehensive Bridge Inspection Training Course
- Or, Associates degree in engineering, and 48 months bridge inspection experience, and successful completion of FHWA approved Comprehensive Bridge Inspection Training Course

Program Manager and Team Leader qualification requirements are listed in Section §650.309 of the NBIS and are outlined in the chart in [Appendix 34.51](#). The time requirements listed for qualification are measured by the actual time spent performing the designated activity or related tasks not by calendar years.

All applications for Program Manager delegation and Team Leader certification will be reviewed and approved by Local Programs. Program Manager delegation is issued to an individual within a specific agency that meets the qualifications, not to the agency (see [Appendix 34.54](#) to review the Bridge Program Manager Agreement). If a Bridge Program Manager leaves agency employment, and the agency desires delegation of another Program Manager, delegation to another qualified person within the agency is required (see [Section 34.21](#)). Certification of Bridge Program Manager status will be sent by hard copy letter. Bridge Inspector Team Leader certification will be acknowledged through an email response and by activation of Certified Bridge Inspector privileges in the inspection software provided by WSDOT. Any bridge certification will become part of the “Staff Qualification” file required for all bridge program personnel and which will be checked on an annual basis and during Quality Assurance (QA) reviews.

WSDOT maintains a list of qualified inspection service consultants which is available through Local Programs. Private consultants wanting to provide in-service bridge inspection services must have bridge inspectors that have been certified by WSDOT staff.

.24 Continued Certification of Bridge Inspection Personnel – Each Program Manager and Team Leader must participate in a 40 hour continuing education program to maintain certification. This program requires the following during a five-year period:

- 40 hours of bridge related training including WSDOT sponsored bridge training, bridge conferences, and other NHI Bridge Training courses.
- An approved Bridge Inspector Refresher Training course.
- Field evaluation performed by WSDOT Local Programs during QA reviews or by an agency’s Bridge Program Manager with the approval of the WSDOT Local Programs Bridge Engineer (see [Section 34.3](#)).

The expiration date of Program Managers and Team Leaders privileges are listed under Account settings in the inspection software that are updated by Local Programs after verification that the continuing education requirements have been met. Qualification reviews are performed annually and as well as the formal process during the file review during the QA process outlined under [Section 34.3](#).

Visit the Local Programs Bridge Services website at www.wsdot.wa.gov/LocalPrograms/Bridge/Training.htm.

.25 Bridge Inspection Records and File Requirements – Bridge owners are required to maintain a complete and current official bridge file for each structure included in the NBI. This file is to be maintained throughout the life of the bridge. [Chapter 2](#) of the [WSBIM](#) and [Appendix 34.55](#) list the requirements for each official bridge file and detailed guidance on what to include. In addition, the latest version of the *American Association of State Highway and Transportation Officials (AASHTO) Manual for Bridge Evaluation* (MBE), has been incorporated by reference in the NBIS. See NBIS Section §650.313(d).

Agencies must identify bridges requiring special attention and must keep these Master Lists with the official bridge files. Lists of bridges that require special inspections such as, Fracture Critical Member Inspections, Underwater Inspections, and Complex Bridge Inspections or are singled out for deficiencies such as Load Posting or having been determined Scour Critical should be included on Master Lists.

Additionally, each local agency is required to maintain a current file on each member of the Inspection staff detailing their experience and training.

.26 Bridge Load Ratings – All NBI bridges, including new structures, require load ratings which must be stamped and signed by the Professional Engineer charged with overall responsibility for the analysis. These ratings shall be performed in accordance with the guidelines within Chapter 6 of the AASHTO MBE and must be placed in the official bridge file as discussed in [Section 34.25](#). If the current load rating is suspect because of condition changes or added dead load, a new rating shall be performed and the bridge inventory updated within 90 days of the inspection. Bridges must be posted or restricted when the maximum load carrying capacity drops below the maximum unrestricted legal load. Additional load rating requirements are available in [Chapter 5](#) of the [WSBIM](#). Once it has been determined that an in-service bridge can no longer carry legal loads, load restriction signs shall be installed within 30 days including an update to the Local Agency Bridge Inventory with correct coding that reflects the diminished bridge capacity. The inventory update shall include a photo of the posting for confirmation purposes. Load ratings for new bridges are eligible for LBP funds and should be included in the contract for bridges funded under this program. Load Ratings shall be available for inclusion in the bridge inventory record no later than 90 days from the time the bridge is put in service.

.27 Bridge Scour Analysis – A scour evaluation is required for each bridge over water. [Chapter 5](#) of the [WSBIM](#) provides guidance on performing this evaluation. The scour analysis must also yield the federal scour code as detailed in [Chapter 2](#) of the [WSBIM](#) under the Washington State Bridge Inventory System (WSBIS) Item Number 1680. This evaluation becomes part of the official bridge file discussed in [Section 34.25](#).

Plans of action for monitoring as well as scour repair plans are required for all bridges determined to be “scour critical” or to have unknown foundations. A plan of action (POA) has these primary components:

1. Development and implementation of a monitoring program.
2. Instructions regarding the type and frequency of inspections to be made at the bridge.
3. A schedule for the timely design, and construction of scour countermeasures (e.g., riprap).

Each documented plan of action should address each of these components and explain why the preferred actions were chosen. (See [Chapter 5](#) of the [WSBIM](#) for more detailed information on what should be included in each POA).

.28 Critical Damage Bridge Repair Reports – A Critical Damage Bridge Repair Report must be completed whenever a bridge is identified as having significant structural damage causing emergency load restrictions, lane closure, bridge closure, or if a bridge has failed. See additional guidance for uses of Critical Damage Bridge Repair Reports in [Chapter 6](#) of the [WSBIM](#).

The WSDOT Local Programs Bridge Engineer must be notified by telephone or email within one working day of identification of a problem. This notification starts a series of reports that are ultimately forwarded to FHWA. This series of reports allows the local agency, Local Programs, and FHWA to track the status of critically damaged bridges until the damage is resolved by repair or replacement of the bridge. See [Chapter 6](#) of the [WSBIM](#) for contact information, timelines, forms and procedures.

34.3 Quality Assurance and Quality Control Reviews

Local Programs conducts Quality Assurance and Quality Control (QA/QC) reviews of local agency bridge programs statewide to:

- Verify that local agency bridge inspection programs maintain a high degree of accuracy and consistency.
- Identify future training needs.
- Ensure compliance with the NBIS.

Quality Assurance (QA) is defined per [23 CFR 650.305](#) as “the use of sampling and other measures to assure the adequacy of quality control procedures in order to verify or measure the quality level of the entire bridge inspection and load rating program.” A QA review must be done by someone outside the work group.

Quality Control (QC) is defined as “procedures that are intended to maintain the quality of a bridge inspection and load rating at or above a specified level.”

The Local Programs Bridge Inventory Engineer continually performs routine Quality Control reviews on the data contained in the Local Agency Bridge Inventory. Queries are run on all bridge inventory data for verification of data consistency and correct data field correlation. In addition, updated bridge inspection data prepared by the bridge owners receives an in-depth review and corrections are made before releasing new data to the bridge inventory. The remote aspect of the QC review process is extended to incorporate additional bridge file components as they become available electronically through the bridge inspection software. This process produces a more efficient and complete review of the Agency’s program during the actual field visits.

Quality Assurance reviews are a formal review that is conducted a minimum of once every five years. This formal review consists of both a bridge file review and the field review as detailed below. See [Appendix 34.57](#) for a copy of the checklist used by Local Programs for this review.

The detailed documented policies and procedures used by Local Programs for the QA/QC reviews are located in [Chapter 7](#) of the [WSBIM](#).

Local Agency Quality Control – Each agency that has been delegated Program Manager Responsibilities by WSDOT shall have written quality control procedures in place to ensure that data submitted to the Local Agency Bridge Inventory is accurate and complete. The agency’s quality control procedures must be on file and, at a minimum, comply with the QC requirements outlined in [Chapter 7](#) of the [WSBIM](#) and be approved by the WSDOT Local Programs Bridge Engineer.

34.4 Local Bridge Program Call for Projects

Counties and cities are invited to submit bridge projects to Local Programs in response to the Local Bridge Program Call for Projects. These bridge projects must meet the federal eligibility requirements in [Section 34.41](#).

The specific application requirements may vary from biennium to biennium and will be outlined in the actual Call for Projects.

.41 Local Bridge Program Eligibility – A bridge project must fulfill the following federal criteria to be eligible for funding:

1. The bridge must be more than 20 feet in length measured along the centerline.
2. It must be recorded in the Washington State Bridge Inventory System (WSBIS).
3. For replacement and rehabilitation, the bridge must be structurally deficient (SD) with sufficiency ratings as follow:
 - a. For Replacement: less than 40
 - b. For Rehabilitation: 80 or less
4. Seismic-Paint-Scour – Eligible activities may be funded for bridges regardless of sufficiency rating. However, bridges must be scour critical or have unknown foundations to be eligible for scour projects. Routine maintenance is not eligible for funding.
5. No replacement or rehabilitation projects can have been performed using funds in the past 10 years. There is no moratorium following Seismic-Paint-Scour projects, however, the intent of this funding is for the repair to last at least 10 years.
6. Bridges with structurally deficient decks (Deck Overall codes of 4 or less) are eligible for rehabilitation regardless of sufficiency rating. The 10-year moratorium will not disqualify the candidate. However, once the deck has been replaced or rehabilitated, the 10-year rule will apply.

The Federal Highway Administration (FHWA) has developed a formula that calculates sufficiency ratings and assigns SD or FO designations. This computation is performed by the WSBIS using inventory and inspection data submitted by state and local agency bridge inspectors. The sufficiency rating is based on four factors: structural adequacy and safety, serviceability and functional obsolescence, essentiality for public use, and special reductions. Ratings can range from 0 (worst) to 100 (best). Deteriorated bridges that are in poor condition are considered Structurally Deficient (SD) and bridges with geometric configurations that are below current standards for the route they serve are considered Functionally Obsolete (FO). A sufficiency rating generator is included as part of the Bridge Works Bridge Inspection software which is available for download at www.wsdot.wa.gov/localprograms/bridge/bridgeworks.htm.

.42 Bridge Replacement Design Standards – Bridges shall be designed in accordance with [Chapter 42](#) and the following criteria:

1. **Live Load** – Load and Resistance Factor Design (LRFD) HL 93.
2. **Vertical Clearances** – Clearance over roadways is a minimum 16.5 feet. Clearance over railroads is a minimum 23.5 feet.
3. **Design-Year ADT** – Will be determined per [Section 43.21](#).
4. **Bridge Length** – The length of the replacement bridge can be affected by one or both of the following factors:
 - a. The bottom of the superstructure will be 3 feet above the 100 year flood or as determined by field review.
 - b. The abutment and pier location(s) of a new bridge generally reduce the existing backwater elevation. The acceptable rise in the backwater elevation should meet state or local jurisdictional regulations as applicable.
5. **Bridge Type** – The bridge type selected will be the most economical type for the span length needed, based on sound engineering judgment and/or economics.
6. **Bridge Foundation Type** – The type and depth of the foundation elements will depend on the results of the geotechnical and hydraulic analyses and shall be considered scour safe (WB76-80 coded 8 or 9).

Both a load rating and a scour analysis for a new bridge shall be provided for the official bridge file. The scour analysis will consist of a summary of the hydraulic design as justification for the scour safe code.

.43 Bridge Rehabilitation Criteria – To qualify as a rehabilitation project, the total rehabilitation costs shall not exceed 70 percent of the replacement costs. Rehabilitation projects will be subject to the following requirements:

1. Structural deficiencies will be removed.
2. Structure will be brought up to current standards.
3. Completed bridge must load rate at or above an H-15 inventory rating.

.44 Seismic-Paint-Scour – Project eligibility and priority ranking is based on the Washington State Bridge Management System (BMS) element data. See [Chapter 4](#) of the [WSBIM](#) for BMS information.

.45 Eligible Bridge Costs – The following are eligible bridge costs:

1. **Bridge Construction** – All items typically detailed by bridge designers (concrete, rebar, piling, barriers, expansion dams, etc.).
2. **Bridge Aesthetics** – Limited to the treatment required in the approved NEPA documents. Typically, paints or pigmented sealers and fractured fin finishes on concrete structures will not be approved.
3. **Demolition** of existing structure(s).
4. **Detour** – All work items required to accommodate the construction of the new bridge.
5. **Traffic Control for the Work Zone** – Prorated by costs of bridge vs. approach work.

6. **Structural Excavation and Backfill for Bridge** – Includes abutments, wing walls, footings, cofferdams, etc.
7. **Riprap Protecting Bridge Structure Within the Right of Way** – Riprap placed within the right of way to protect the structure can be considered a bridge item.
8. **Approach Slab** – The approach slab is a reinforced concrete element that protects the bridge and abutments from impacts and can be considered a bridge item.
9. **Approach Guardrail Transition Section** – Approach guardrail systems are installed in accordance with Standard Plans and are considered a bridge item provided site conditions do not require unusually long transitions.
10. **Retaining Walls** (up to 20 feet maximum distance from the abutment) – Retaining walls are structural elements that serve the same functions as the standard bridge wing walls and are designed by bridge designers. Retaining walls beyond these limits would not be considered bridge items.
11. **Bridge Drainage** – Including components necessary to carry water from the structure.
12. **Environmental Mitigation** – Prorated for the bridge, demolition of existing structure, and/or detours.
13. **Mobilization** – Prorated by costs of bridge and approach work.

Approach costs will be limited to 15 percent of the above items.

.46 On-Site Field Review of Candidates – The on-site field review team verifies the condition of the bridge, review site information, and possibly requests updated or additional information. The field review is also an opportunity for the bridge owner to provide additional information related to up-front project scoping and analysis done prior to the call for projects.

- a. **Field Review Team** – The Field Review Team consists of the WSDOT Local Programs Bridge Engineer (Review Team leader), a local agency bridge owner representative, the Region Local Programs Engineer, and FHWA Division Bridge Engineer whenever possible. On non-CA agency bridges, the Field Review Team will also have a representative from the agency providing CA services for the non-CA agency. The Local Programs Bridge Engineer may add other representatives as deemed appropriate for specialized conditions.
- b. **Review Procedures**
 1. The Field Review Team conducts an on-site review of proposed bridge projects. The Field Review Team may use results of a previous review for a bridge submitted but not funded, provided the review was conducted within the past three years.
 2. The Bridge Inspection Report is reviewed at the site. The Field Review Team looks for inconsistencies between condition codes, load ratings, postings, ADT, and other factors. The WSDOT Local Programs Bridge Engineer calculates an independent sufficiency rating based on codes agreed to by the review team. The final sufficiency rating may change again based on information requested by the team but not available during the field review.

3. The items submitted with the application are reviewed at the site. The Field Review Team reviews the site in detail and recommends which of three funding program best fits the condition of the bridge.
 - a. Replacement projects.
 - b. Rehabilitation projects.
 - c. Seismic-Paint-Scour-Deck Repair.
4. A consensus is reached on the appropriate funding program and estimated scope of work for the project.
5. The project cost estimate submitted by the agency is discussed in detail and revised as appropriate.

.47 Bridge Selection – A local bridge advisory committee convenes after the on-site field reviews are completed with the local agencies. A suggested list of bridge projects are presented to the committee in order of sufficiency rating, results of the field review, review team recommendations, and other pertinent information. The committee reviews all of the projects and adds comments based on a statewide approach.

The Director, Local Programs approves the final list of bridge projects based upon funding levels, delivery schedules, bridge sufficiency and committee comments. Counties and cities will receive a funding notification letter informing them that their bridge project has been approved for funding. The letter will identify the anticipated federal funding level and asks the agency to submit their request for funds through their Region Local Programs Engineer. This letter will also identify the percentage for bridge approach cost participation and any other requirements specific to the project.

The committee is comprised of seven voting members and two alternates. The committee includes four county representatives, four city representatives, with the Local Programs Engineering Services Manager serving as Chair. Alternates initially serve one year as a non-voting member then for three more years as a voting member. Alternates for either city or county may participate in the event a voting member from their respective association is absent.

.48 Project Management and Funding – The level of funding available for the bridge program falls short of meeting all of the needs on the local roadway system. With this limited funding, it is critical that the initial scope, schedule, and budget for each project be as accurate as possible. Identification of changes to the scope, schedule or budget during project delivery need to be communicated to Local Programs, the quarterly project report is the vehicle for this communication.

Updates to the project scope schedule and budget are required for all bridge replacement and rehabilitation projects and all other projects that exceed \$2.0 million are required at 30 percent and 60 percent design.

34.5 Appendices

- 34.51 NBIS Regulation – Qualifications of Personnel
- 34.52 NBIS Regulation – Inspection Frequency
- 34.53 Bridge Inspector Experience and Training Record
- 34.54 Bridge Program Manager Agreement
- 34.55 Bridge Records
- 34.56 Individual Bridge Record
- 34.57 Local Agency Bridge Program Quality Assurance Checklist

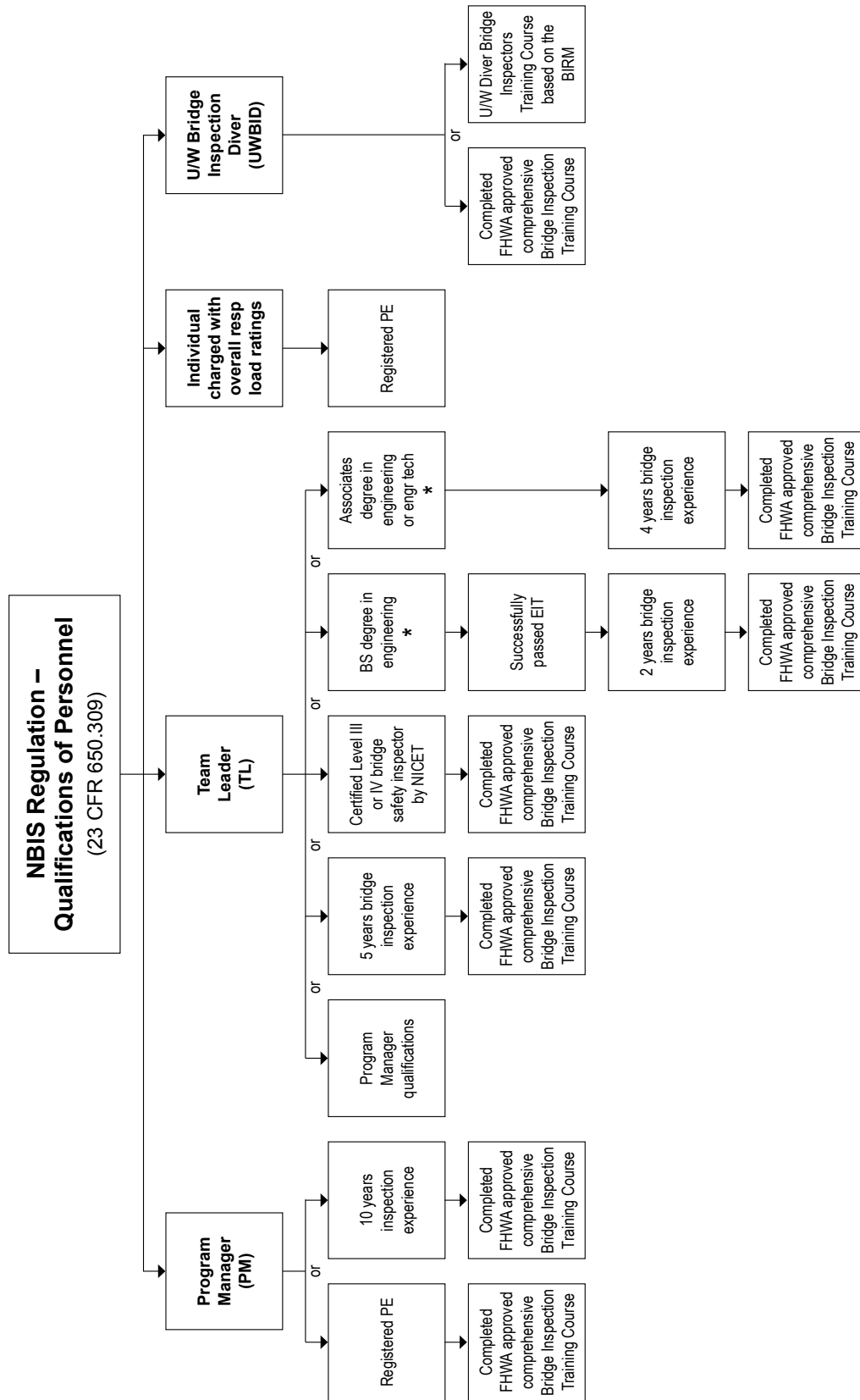

* An accredited Board for engineering and technology or determined substantially equivalent.

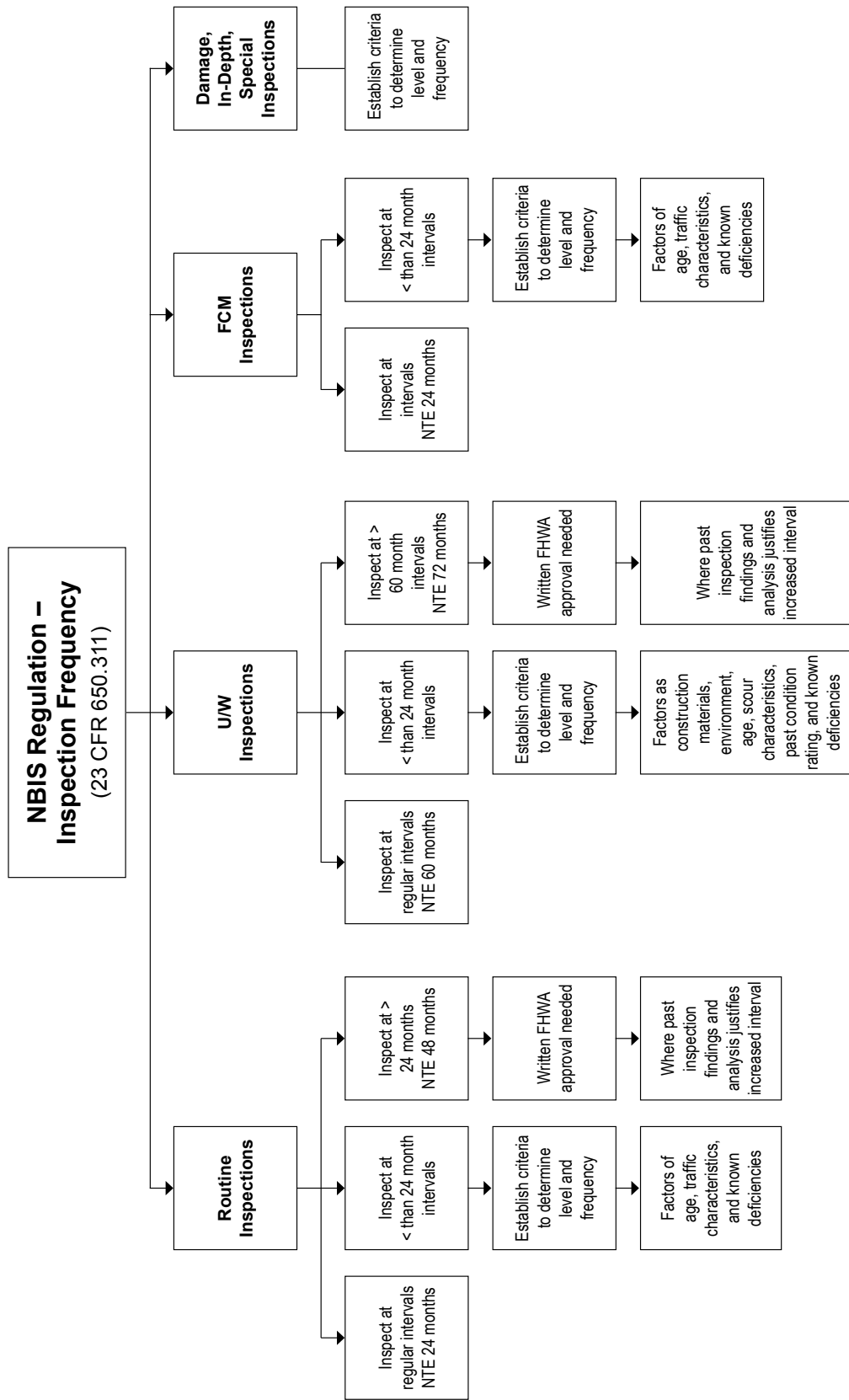

Key:
 NTE = Not to Exceed
 FCM = Fracture Critical Member
 UW = Under Water

Bridge Inspector Experience and Training Record



**Washington State
Department of Transportation**

**WSDOT Bridge/Tunnel Inspector
Experience and Training Record**

Applicant for Bridge/Tunnel Inspector Certification	Date
Organization	

Education			
Institution	Major	Years	Degree

Professional Registration		
State	Branch/Agency	Registration Number

Bridge/Tunnel Inspection Training			
Course	Hours	Sponsor	Dates

Special Technical Course			
Course	Hours	Sponsor	Dates

Bridge/Tunnel Inspection Experience		
Organization	Bridge Duties	Years

To the best of my knowledge, the above information is true and accurate.

Applicant's Signature	Date
-----------------------	------

Having reviewed the above information, I conclude that this individual meets the minimum qualifications for a bridge/tunnel inspection team leader as specified in the current National Bridge Inspection Standards and National Tunnel Inspection Standards.

Team Leader's Signature	Date
Team Leader's Name (Print)	Title

DOT Form 234-100
Revised 08/2012

Appendix 34.54 Bridge Program Manager Agreement



**Washington State
Department of Transportation**

Lynn Peterson
Secretary of Transportation

Transportation Building
310 Maple Park Avenue S.E.
P.O. Box 47300
Olympia, WA 98504-7300
360-705-7000
TTY: 1-800-833-6388
www.wsdot.wa.gov

Agency: [Click here to enter text.](#)

Agency No.: [Click here to enter text.](#)

In accordance with Title 23, Code of Federal Regulations, Part 650 - Bridges, Structures, and Hydraulics, Subpart C – The National Bridge Inspection Standards (NBIS) the Washington State Department of Transportation (WSDOT) in its role as the Washington State Bridge Inspection Organization is responsible to inspect, or to cause to be inspected, all highway bridges located on public roads that are fully or partially within the State's boundaries, except for bridges owned by Federal agencies. The NBIS contains provisions to allow delegation of bridge program functions identified in §650.307(c)(2).

The individual in charge of the bridge program as defined in the NBIS is the Bridge Program Manager. The overall Program Manager for Local Agency owned bridges in Washington State is the WSDOT Local Agency Bridge Engineer. The individual delegated Program Manager status within an agency and deemed in charge of the Agency Bridge Program for that agency is the Agency Bridge Program Manager. While delegation of Program Manager is allowed, such delegation does not relieve WSDOT of any of its responsibilities under the NBIS.

Agency Bridge Program Manager status is assigned to a specific qualified individual within a specific agency. Any change of employment of the Agency Bridge Program Manager requires re-delegation by the WSDOT Local Agency Bridge Engineer of Bridge Program Manager status to another qualified person within that specific agency.

A qualified person within a Local Agency who accepts Bridge Program Manager status agrees to:

- Adhere to the Washington State Bridge Inspection Manual M 36-64 and all policies and procedures promulgated by the Washington State Department of Transportation (WSDOT) which accomplish the policies and objectives set forth in NBIS.
- Provide overall leadership and be available to the inspection team leaders to provide guidance.
- Supervise or provide Bridge Program quality control to ensure that the requirements of the NBIS are met. This includes review of inspection reports and approval of the Team Leaders work, overseeing bridge inspection schedules, ensuring that all analysis, reporting, and inventory requirements are met, and critical deficiencies are addressed in a timely manner. Support staff may be Private Consultant or State Services.

The qualified person within a Local Agency who accepts Bridge Program Manager Status:

Bridge Program Manager (Name)

Bridge Inspector Cert. No.

Mayor or Chairman

Date

Washington State Department of Transportation

Approved By:

Local Programs
Engineering Services Manager

Date

Appendix 34.55 Bridge Records

A 34.55.1 General

The on-site inspection of each bridge is important for gathering information about the bridge's structural condition and adequacy. This information must be stored as a permanent bridge record. Such a record provides a useful and accurate history. It also contains information on previous repairs and provides others with ready access to information.

Each agency is responsible for maintaining a bridge file for each bridge within its jurisdiction. A detailed list of information that should be in the bridge file is listed and described in Chapter 2 of the *Washington State Bridge Inspection Manual* (WSBIM) M 36-64. Another reference for a detailed list of the information that should be included in the bridge file can be found in American Association of State Highway and Transportation Officials (AASHTO). The Manual for Bridge Evaluation, Second Edition, 2011. When inclusion of this information in the bridge file is not possible or impractical, reference to the location where it can be found will suffice.

In addition, agencies are required to maintain a record of other general information. This information may be requested during the quality assurance review of the bridge inspection program. The following general information should be on file:

- An experience and training record for each lead inspector.
- A master list of all bridges within the agency's jurisdiction. This list should identify bridges that have fracture critical members, require underwater inspection, and/or warrant special inspection because of their design features, location, or strategic importance.

A 34.55.2 Individual Bridge Records

A permanent record on each bridge must be maintained. This record provides a history of the bridge's condition, maintenance, and inventory data. This information must be kept current.

1. **Washington State Bridge Inventory System (WSBIS) Inventory Coding Form** – A copy of the completed WSBIS Inventory Coding Form must be in the bridge file as a ready source of the current bridge information. The procedures for establishing, maintaining, and updating the inventory information is described in detail in WSBIM [Chapter 2](#).
2. **Bridge Inspection Reports** – Copies of all on-site inspection reports must be kept in the individual bridge file and must be signed by the Team Leader responsible for the inspection. The reports provide specific details about the bridge's condition, how conditions have changed over time, and any previous repairs or maintenance performed. This information is reviewed prior to each bridge on-site visit to prepare the inspector for the conditions or problems they may encounter. Procedures for completing bridge inspection reports are covered in WSBIM [Chapter 3](#) and in the Federal Highway Administration (FHWA) *Bridge Inspector Reference Manual* (BIRM).

3. **Critical Damage Bridge Repair Report** – A copy of the Critical Damage Bridge Repair Report must be kept in the bridge file. This report provides evidence that formal recommendations to correct major bridge damage were made and acted upon in a timely manner, ensuring the safety of the public. See [WSBIM Chapter 6](#) for more information.
4. **Photographs** – Labeled and dated copies of elevation and deck photographs of the bridge must be kept in the bridge file. The label should include the structure ID, bridge name, bridge number, inspector's initials, and a description including orientation. Whenever the bridge's condition changes, new photographs should be taken and added to the file. An agency may also keep on file photographs of problems or deficiencies discovered at the bridge (e.g., section loss in a deteriorating piling or significant spalling on a bridge deck). These photographs can provide documentation of existing or developing problems that could lead to repairs. Deterioration requiring a repair should be documented with a photo. The photo is then referenced in the note describing the deterioration and in the repair note initiating the repair. Once the repair is complete, a follow up photo is taken as part of the repair verification procedure.
5. **Plans** – Most bridges will have detailed design plans used for the construction of the bridge and final drawings reflecting the as-built condition of the bridge. These plans should be kept in the bridge file or a note should be included with location of any plans that are too bulky to fit in the file itself. If these plans are not available, a detailed sketch of the bridge needs to be made showing bridge length, width, span length, clearances, and a typical section with bridge materials and dimensions.
6. **Load Rating and Scour Evaluations** – Information necessary for inclusion in the bridge file for load ratings and scour evaluations are detailed in [WSBIM Chapter 5](#).

A copy of the stamped, signed, and dated load rating must be kept in the bridge file. Include a note in the bridge file with location of any load rating that is too bulky to fit in the file itself. Load test data should be included for any field load tests.

Scour evaluations are to be performed for all structures over bodies of water and shall be included in the bridge file. The scour evaluation shall include the calculations and/or narrative to justify the code entered into – WSBIS Item Number 1680. If a bridge is determined to be scour critical, a scour Plan of Action shall also be developed for that structure.

All structures over water shall also be required to have channel cross-sections (soundings) taken at the upstream side of structure to monitor scour and channel migration at the site. Suggested frequencies for cross-sections can be found in Chapter 5 of the WSBIM.
7. **Correspondence** – All letters regarding the inspection, maintenance, or ownership of the bridge should be kept in the bridge file. This may include correspondence from FHWA, WSDOT, other agencies, and/or individuals.

8. **Inspection Procedures** – Each agency is required to develop and maintain procedures that address the special features of a bridge. Special features include fracture critical members, underwater elements, or any other feature requiring special inspection due to location, strategic importance, or special design features.

The members that require an underwater inspection shall be identified and the inspection procedures specified. Waters deeper than 4 feet will normally require a diver that is trained in bridge inspections. Wading types of inspections can usually be performed by regular bridge inspection teams as part of the structural inspection. Detailed procedures for conducting these inspections are in WSBIM [Chapter 3](#).

9. **Other Information** – All other information gathered about the bridge should be kept on file. This includes details about maintenance work performed, special reports or studies, heat straightening, damage, and paint reports.

A 34.55.3 Master List

The purpose of a master list is to assist in the management of non-routine inspections, bridges needing special inspection and/or inspection equipment. Each agency is required to maintain a master list of:

- Bridges with fracture critical members.
- Bridges requiring underwater diving inspections.
- Bridges with special features (e.g., segmental bridges).

It is recommended that each agency maintain a master list of:

- Bridges that are scour critical.
- Load posted bridges.
- Bridges requiring an Under Bridge Inspection Truck to inspect limited access members.
- Short span bridges.
- Bridges needing repairs.
- Bridges needing traffic control for routine inspections.
- Fatigue cracked bridges.
- Environmentally sensitive bridges.
- Bridges needing deck replacement.
- Bridges that are seismic vulnerable.
- Bridges needing painting.

This information can be used to plan, schedule, and monitor the special inspections. At a minimum, the following information must be included for each bridge:

- Bridge type and location.
- Type and frequency of inspection required.
- Location of particular members to be inspected.
- Inspection procedures to be used.
- Type of special equipment required.

- Previous inspection dates.
- Most recent inspection findings.
- Any follow-up action taken as a result of the most recent inspection findings.

Bridges are added to the master list when they are identified as needing an underwater, fracture critical, or special features inspections. As these inspections are performed, the master list is updated with the most current information. Bridges are kept on the master list throughout their service life, unless the bridge's category (e.g., fracture critical, special features) changes.

A 34.55.4 Bridge Construction Files

Bridge construction files should include the following:

- Construction Plans
- As-built Drawings
- Specifications
- Shop and Working Drawings
- Material Certification
- Material Test Data

A 34.55.5 Short Span Bridges

Short span bridges (see WSBIM [Chapter 3](#)) are bridges or multiple culverts having an opening of 20 feet or less. The short span bridges are generally not reported to the Federal Highway Administration. Washington State encourages the reporting of short span bridge information because of concerns about their condition and possible maintenance repairs required.

A 34.55.6 Inspector Qualifications

The NBIS outline the minimum training and experience required for the head of the bridge inspection organization or Program Manager and the lead bridge inspector or Team Leader. Each agency is required to maintain a record of qualifications for each of its bridge inspection personnel. The agency needs to include the names and qualifications of each individual performing bridge inspections.

The Bridge Inspector Experience and Training Record Form was developed for this purpose. The form is completed by the head of the bridge inspection organization who verifies that lead inspectors meet the qualifications. The completed form is sent to the WSDOT Local Agencies Bridge Engineer for review and the issuance of a bridge inspector identification number. This number is required on the inspection reports. A copy of the completed form is kept on file with the agency.

Each agency is responsible for keeping this information current. During the quality assurance review process, agencies may be asked to verify the qualifications of their inspectors.

Appendix 34.56 Individual Bridge Record

Initials	Date or N/A	
_____	_____	Load Rating (WSBM Chapter 5)
_____	_____	Stamped, signed, and dated by Professional Engineer
_____	_____	WB72-83 coded correctly per load rating
_____	_____	Bridge is posted if necessary
_____	_____	Bridge is included on master list of posted bridges
_____	_____	WB78-80 coded correctly
_____	_____	WB75-51 through WB77-55 correctly coded
_____	_____	Location if not in individual bridge file
_____	_____	General Correspondence
_____	_____	Inspection Procedures (WSBM Chapter 3)
_____	_____	Bridge is Fracture Critical
_____	_____	Bridge is on Fracture Critical Master List
_____	_____	Fracture Critical procedures
_____	_____	Bridge requires underwater inspection
_____	_____	Bridge is on Under Water Inspection Master list
_____	_____	Underwater Inspection procedures
_____	_____	Bridge is Complex
_____	_____	Bridge is Complex Bridge Master List
_____	_____	Complex Bridge Inspection Procedures
_____	_____	Maintenance Records
_____	_____	Maintenance recommendations on inspection report
_____	_____	Maintenance initiation (signed, dated)
_____	_____	Maintenance completed (signed, dated, description)
_____	_____	Other Information
_____	_____	Special reports

**Bridge Program Files (Chapter 34)
Washington State Bridge Inspection Manual (WSBIM) Chapter 2**

Individual Bridge Record

Bridge Name: _____

Bridge Number: _____ **Structure I.D.** _____

Initials	Date or N/A	
_____	_____	Current Washington State Bridge Inventory Coding Form (WSBIS)
_____	_____	_____ Inspection date is current
_____	_____	_____ Data is complete and correct (WSBIM Chapter 2)
_____	_____	Bridge Condition Inspection Report History
_____	_____	_____ Reports signed and dated by qualified Team Leader
_____	_____	_____ Team Leader qualification and training file up-to-date
_____	_____	_____ History complete according to inspection frequency
_____	_____	Critical Finding (WSBIM Chapter 6)
_____	_____	_____ Critical Damage Bridge Repair Report
_____	_____	_____ Follow-up information (Inspection/Design/Repair)
_____	_____	_____ Conclusion (Bridge reopened or permanently closed)
_____	_____	Photographs (deck and elevation of a minimum)
_____	_____	_____ Date, description, orientation, inspector's initials
_____	_____	_____ Location if not in individual bridge file
_____	_____	Bridge plans or detailed drawings
_____	_____	_____ Plans do not exist
_____	_____	_____ Location if not in individual bridge file
_____	_____	Scour Analysis (WSBIM Chapter 5)
_____	_____	_____ Bridge is not over water
_____	_____	_____ Analysis defines the WB78-80 Scour Code
_____	_____	If Scour Critical
_____	_____	_____ Action plan
_____	_____	_____ Bridge is included on Scour Critical Master List

**Local Agency Bridge Program
Quality Assurance Checklist**

Agency: Click here to enter text.

Date: Click here to enter text.

Program Manager:

Name: Click here to enter text.

Experience: Click here to enter text.

Refresher Training: Click here to enter text.

Team Leader(s):

Name: Click here to enter text.

Experience: Click here to enter text.

Refresher Training: Click here to enter text.

Name: Click here to enter text.

Experience: Click here to enter text.

Refresher Training: Click here to enter text.

Team Member(s):

Name: Click here to enter text.

Experience: Click here to enter text.

Training: Click here to enter text.

Name: Click here to enter text.

Experience: Click here to enter text.

Training: Click here to enter text.

Bridge Master List Information:

Number of Bridges in the Agencies Inventory: [Click here to enter text.](#)

Number of NBIS Bridges: [Click here to enter text.](#)

Number of NBI Bridges (on/under): [Click here to enter text.](#)

Number and Types of Specialty Inspections: [Click here to enter text.](#)

Number of Bridges Over Water: [Click here to enter text.](#)

Type of Inspection	No. Bridges	Notes
Fracture Critical		
Underwater		
Complex Bridge (Not F/C)		
Increased Frequency		
Special Access		
SD		
FO		
Valid Load Ratings		
Load Posted		
Scour Critical		
Unknown Foundation		
High Water POA's		

DOT 140-569
Revised 10/2015

Bridge Inspection Procedures: See attached Bridge File Checklist for each structure reviewed.

Is a Laptop Used in the Field? [Click here to enter text.](#)

Are Manuals Available in Field? [Click here to enter text.](#)

Bridge SID	1)	2)	3)	4)	5)	6)
Coding Accuracy						
WSBIS Accuracy						
Notes						
Sketches (in BW?)						
Procedures (in BW?)						
Photos (in BW?)						
Repairs/Maint.						
Load Posting/Codes/Photo						
LR Summary (In BW?)						
Scour Codes/Justification						
POA's (in BW?)						

Are Consultant inspectors used for any Bridge inspections? [Click here to enter text.](#)

Are 2-man inspection teams scheduled? [Click here to enter text.](#)

Is the Bridge Program Manager involved in the Quality Control of Bridge Inspections? [Click here to enter text.](#)

Inspection Equipment:

Equipment	Agency Owned/Rented	Availability
Ladder		
Manlift		
UBIT/Under Bridge Platform		
Boat		
Climbing Gear		
NDT		

DOT 140-569
Revised 10/2015

Inspection Finding Follow-up:

Does inspection team have ability to immediately close a bridge if necessary? [Click here to enter text.](#)

What is process for closing a bridge because of a Critical Finding? [Click here to enter text.](#)

Is the repair list tab up-to-date in Bridge Works? [Click here to enter text.](#)

Do notes referencing maintenance progress exist in inspection report? [Click here to enter text.](#)

How is maintenance funded? [Click here to enter text.](#)

How is maintenance scheduled/closed out? [Click here to enter text.](#)

How are required signs inventoried/ verified? [Click here to enter text.](#)

General Notes:

[Click here to enter text.](#)

DOT 140-569
Revised 10/2015

Chapter 41 General Project Types

41.1 General Discussion

This chapter identifies the design standards document, deviation approval authority, and design approval for a specific facility. The deviation process, Work Zone Safety and Mobility, and Intelligent Transportation Systems are also discussed.

This part of the manual is organized into six chapters relating to the design phase: General Design Information; City and County Design Standards for Non NHS facilities; Location and Design Approval; Plans, Specifications, and Estimates; State Advertising and Award Procedures; and Local Advertising and Award Procedures.

Compliance with Section 504 of the Rehabilitation Act of 1973 and the Americans with Disabilities Act of 1990 is required in the design, construction, operation and maintenance of transportation facilities (i.e., pedestrian facilities, park and ride lots). Where sidewalks are provided, public agencies shall provide pedestrian access features such as continuous, unobstructed sidewalks, and curb cuts with detectable warnings at highway and street crossings. See 28 CFR Part 36, Appendix A, for minimum federal requirements for curb ramps. The design standards and deviation and design approval authority are shown in the following table.

Facility	Design Standards	Deviation Approval	Design Approval
Interstate			
New/Reconstruction	WSDOT <i>Design Manual</i>	WSDOT/FHWA	WSDOT/FHWA
ITS Over \$1,000,000	WSDOT <i>Design Manual</i>	WSDOT HQ	WSDOT HQ
All Other	WSDOT <i>Design Manual</i>	WSDOT HQ	WSDOT Region
National Highway System (NHS)			
State Highways outside of incorporated cities, or on a limited access highway	WSDOT <i>Design Manual</i>	WSDOT HQ	WSDOT Region
State Highways within incorporated cities between back of curb to back of curb	WSDOT <i>Design Manual</i>	WSDOT HQ	WSDOT Region
State Highways within incorporated cities beyond curb line	*City and County Design Standards See Chapter 42	WSDOT Local Programs	City
City Streets (non-State highways)	*City and County Design Standards See Chapter 42	WSDOT Local Programs	City
County Roads	*City and County Design Standards See Chapter 42	WSDOT Local Programs	County

Facility	Design Standards	Deviation Approval	Design Approval
Non-National Highway Systems (Non-NHS)			
State Highways outside of incorporated cities, or on a limited access highway	WSDOT <i>Design Manual</i>	WSDOT HQ	WSDOT Region
State Highways within incorporated cities between back of curb to back of curb	WSDOT <i>Design Manual</i>	WSDOT HQ	WSDOT Region
State Highways within incorporated cities beyond curb line	*City and County Design Standards See Chapter 42	WSDOT Local Programs	City
City Streets (non-State Highways)	*City and County Design Standards See Chapter 42	WSDOT Local Programs	City
County Roads	*City and County Design Standards See Chapter 42	WSDOT Local Programs	County

*Bicycle facilities and multi-use facilities per [RCW 35.75.060](#) and [36.82.145](#) must follow the current AASHTO bicycle design standards and/or standards submitted by the local agency which have been approved by Local Programs for any facility allowing bicycle traffic.

Different standards apply to the design of new construction/reconstruction, 3-R (resurfacing, restoration, and rehabilitation), and 2-R (resurfacing and restoration). Each of these terms is defined in [Chapter 42](#). Local agencies must determine which standards apply before beginning design. See [Chapter 42](#) for design standards on non-NHS routes.

See [Section 43.4](#) for information on Value Engineering.

41.2 Work Zone Safety and Mobility

All projects on the Interstate system must comply with [23 Code of Federal Regulations \(CFR\), Part 630, Subpart J: Work Zone Safety and Mobility](#) and [Subpart K: Temporary Traffic Control Devices](#). It is recommended that any other federally funded project over \$10 million or any project that includes a detour also apply the rules. WSDOT *Design Manual* M 22-01 [Chapter 1010](#) has a list of requirements and key elements as well as checklist for developing a formal Transportation Management Plan (TMP). A TMP is a set of strategies for managing the corridor-wide work zone impacts of a project.

41.3 Intelligent Transportation Systems (ITS)

Intelligent Transportation Systems (ITS) have the potential to reduce crashes and increase the mobility of transportation facilities. They also have the potential to enhance productivity through the use of advanced communications technologies and their integration into vehicles and the transportation infrastructure. These systems involve a broad range of wireless and wire line communications-based information, electronics, or information processing technologies. Some of these technologies include cameras, variable message signs, ramp meters, road weather information systems, highway advisory radios, traffic management centers, and adaptive signal control technology (ASCT). ASCT is a traffic signal system that detects traffic conditions and adjusts signal timing remotely in response.

Systems engineering is a typical part of any ITS project development process. It is required on any federal aid project that has an ITS work element, per [23 CFR 940.11](#). Systems engineering is an interdisciplinary step-by-step process for complex projects, such as ITS projects to:

- assess a system's needs and its relationship to the regional architecture.
- plan a project that meets those needs and meets stakeholder needs and expectations.
- define other specific requirements for the project/system.
- develop and implement the project/system.
- define the operations and maintenance requirements for the system.
- plan for the refinement or replacement of the system.

Using systems engineering on ITS projects has been shown to increase the likelihood of a project's success. A successful project is one that meets the project scope and stakeholder/project sponsor expectations, completed on time and within budget, and efficient and cost effective to operate and maintain.

The level of systems engineering used for a project should be on a scale commensurate with the scope, cost, and risk of the project. Complete the Intelligent Transportation Systems (ITS) Systems Engineering Analysis Worksheet in [Appendix 41.53](#), or a document with the same information, for all federal aid projects that include ITS elements. Completing the worksheet will meet the minimum requirements in [23 CFR 940.11](#) for systems engineering, determine the project's risk, and determine if a more in-depth systems engineering analysis is required.

As shown in the worksheet, a more in-depth analysis requires that the following four documents be completed and used to implement the project. These documents are produced as the result of the steps in the systems engineering process, often referred to as the "V" diagram, shown in [Appendix 41.52](#).

1. **Concept of Operations** – This document defines the problem, the project's goals, stakeholder needs and expectations, constraints, and the way the ITS system is required to operate and be maintained.
2. **System Requirements** – This document contains specifications of what the system is required to do, how well it is required to do it, and under what conditions. These requirements are based on the goals, stakeholder needs and expectations, constraints, and operation and maintenance requirements documented in the Concept of Operations.
3. **System Verification Plan** – This document describes how the agency will verify that the system proposed meets the requirements in the System Requirements document. The agency will implement the System Verification Plan to ensure that all system requirements are verified before it accepts the system.

4. **System Validation Plan** – This document describes how the agency will assess the system’s performance against the goals, stakeholder needs and expectations, constraints, and operation and maintenance requirements documented in the Concept of Operations. The goal is for the agency to understand and review the strengths and weaknesses of the system and identify any new opportunities and needs if appropriate. The agency will implement the System Validation Plan after it accepts the system. This evaluation sets the stage for the next time the system/project is changed or expanded.

For more guidance on developing the four systems engineering plans listed above, see the plan templates in the FHWA - Systems Engineering Guidebook for Intelligent Transportation Systems, Version 3, November 2009. (www.fhwa.dot.gov/cadiv/segb/files/segbversion3.pdf)

Pertinent page numbers include:

- Concept of Operations Template: Page 254
- System Requirements Template: Page 257
- Verification Documents Plan Template: Page 269
- Validation Documents Plan Template: Page 278

High risk ASCT projects require the use of the USDOT Model Systems Engineering Documents for Adaptive Signal Control Technology (ASCT) Systems, FHWA-HOP-11-027, August 2012, or a later addition. Visit FHWA’s ASCT webpage (www.fhwa.dot.gov/innovation/everydaycounts/edc-1/asct.cfm) to obtain this document and learn more. The Illinois Center for Transportation’s Safety Benefits of Implementing Adaptive Signal Control Technology: Survey Results, 2013, provides additional information on ASCT.

For guidance on contracting for ITS projects, see [Appendix 41.54](#).

41.4 Deviations

.41 General – The Agency is authorized to design projects to the standards as indicated in the table shown in [Section 41.1](#). In the event all design standards cannot be incorporated into the design, the agency shall submit a deviation request for review and approval.

.42 Documentation – An agency shall document their reasons for the deviation. The deviation request shall include a description of the problem and its proposed solution and a vicinity map in sufficient detail to aid in evaluating the problem. The deviation request document is a stand alone engineering document. If references to other sources or documents are required, the document should use the appropriate quotes and excerpts as necessary.

An analysis of the engineering and financial aspects of the proposal as compared to the standard and options considered shall be provided. The analysis shall specifically address safety issues, including collision history and projections. It shall address applicable operational characteristics, including traffic speeds, traffic volumes, capacity and route continuity. It should include financial considerations such as high construction costs, unusual or extraordinary site conditions, or environmental requirements that may impact the decision. The analysis may include a Benefit/Cost comparison, and/or Life

Cycle Costing of alternatives considered. The analysis should also include any other information which may be helpful as a future reference.

The level of detail of the request should be based on the relative complexity and scope of the project and the deviation requested. Requests will be considered based on the merits presented. This analysis and deviation request shall be documented and completed prior to the agency's completion of PS&E documents.

.43 **Format** – [Appendix 41.51](#) is a Deviation Analysis Format sheet for use on locally owned facilities (deviations approved by WSDOT Local Programs). Refer to the WSDOT [Design Manual M 22-01](#) for format on all other deviations. The intent of the example is to present format only.

41.5 Appendices

- [41.51](#) Deviation Analysis Format
- [41.52](#) System Engineering Process "V" Diagram
- [41.53](#) Intelligent Transportation Systems (ITS) Systems Engineering Analysis Worksheet
- [41.54](#) ITS Project Contracting Guidance

Appendix 41.51 Deviation Analysis Format

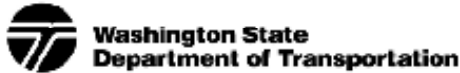

Deviation Analysis Format

Agency: [Click here to enter text.](#)

Project Title: [Click here to enter text.](#)

Project Number: [Click here to enter text.](#)

1. Posted Speed Limit: [Click here to enter text.](#)

2. Physical Comparison:

a. Standard Geometrics: [Click here to enter text.](#)

b. Deviation Geometrics: [Click here to enter text.](#)

c. Discussion: [Click here to enter text.](#)

3. Safety Issues:

a. Collision History: [Click here to enter text.](#)

b. Risk of future collisions: [Click here to enter text.](#)

c. Discussion: [Click here to enter text.](#)

4. Cost Comparison:

	Standard Cost	Deviation Cost	Discussion
Roadway	Click here to enter text.	Click here to enter text.	Click here to enter text.
Structure	Click here to enter text.	Click here to enter text.	Click here to enter text.
Other	Click here to enter text.	Click here to enter text.	Click here to enter text.

5. Reasons standard cannot be achieved at this time: [Click here to enter text.](#)

6. Certification: [Click here to enter text.](#)

I have examined this deviation request and believe it to be in the best public interest that it be granted.

Local Agency Engineer

Date

Appendix 41.52 Systems Engineering Process “V” Diagram

The systems engineering process contains a number of steps that are not included in a traditional project delivery process. The systems engineering process is often referred to as the “V” diagram, shown below. An ITS project begins on the left side of the “V” and progresses down the left side of the “V” and then up the right side. Then the project is evaluated by validating and verifying the elements on the right side of the “V” with the elements on the left side.

The Federal Highway Administration (FHWA) and WSDOT are in agreement that for project development and delivery, the most critical portions of the systems engineering process are the Concept of Operations, System Requirements, System Verification, and System Validation. As a result, the Intelligent Transportation Systems (ITS) Systems Engineering Analysis Worksheet in [Appendix 41.53](#) is focused on these core areas.

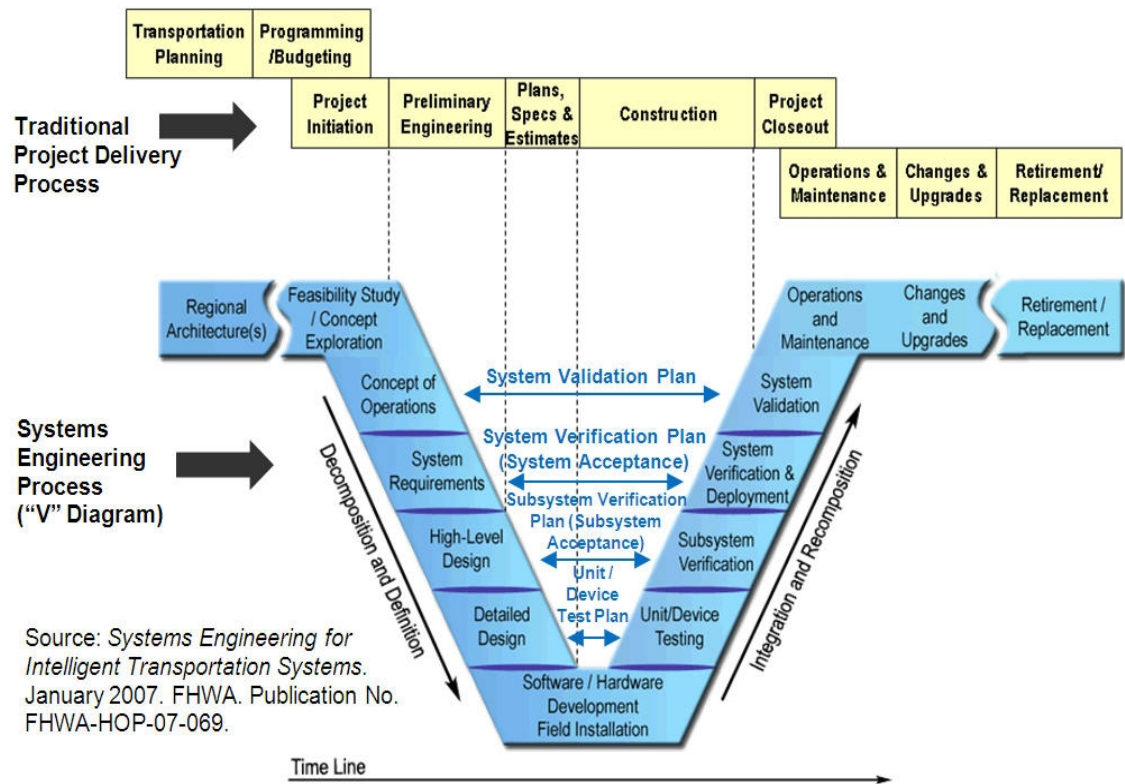

Source: *Systems Engineering for Intelligent Transportation Systems*. January 2007. FHWA. Publication No. FHWA-HOP-07-069.

Systems Engineering Process (“V” Diagram)



Washington State
Department of Transportation

Intelligent Transportation Systems (ITS) Systems Engineering Analysis Worksheet

This worksheet, or a document with the same information, must be completed for all federal aid projects that include Intelligent Transportation Systems (ITS) elements. This worksheet must be completed prior to submitting a construction authorization request and must be kept in the project file for the entire document retention period of the project. If Concept of Operations, System Requirements, Verification Plan, and Validation Plan documents are required for the project, as determined by this worksheet, these documents must be submitted to the WSDOT Local Programs Engineer for review, who in turn will send them to the FHWA ITS/Operations Engineer for review, prior to submitting a construction authorization request. The documents must be kept in the project file for the entire document retention period of the project.

1. Project Name: [Click here to enter text.](#)
2. Project Number (if known): [Click here to enter text.](#)
3. Total project cost (includes preliminary engineering/design, right of way, and construction phases):
[Click here to enter text.](#)
4. Amount of total project cost for ITS elements: [Click here to enter text.](#)
5. Select which of the following items, if any, apply to this project:
 - The project implements an existing adaptive signal control technology (ASCT) system for the first time. Or the project expands on an existing ASCT system involving jurisdictions the agency has not worked with previously. Please explain why you selected or did not select this item.
[Click here to enter text.](#)
 - The project includes new and unproven hardware and/or communications technology that is considered “cutting edge” or not in common use. This could include custom developed or unproven commercial-off-the-shelf (COTS) technology that has not been used by the agency previously. Please explain why you selected or did not select this item.
[Click here to enter text.](#)
 - The project will add new software that will be custom developed for this project or will make major modifications to existing custom developed software. Please explain why you selected or did not select this item.
[Click here to enter text.](#)
 - The project will add new interfaces to systems operated or maintained by other agencies. Please explain why you selected or did not select this item.
[Click here to enter text.](#)
 - The project will develop new system requirements or require revisions to existing system requirements that are not well understood within the agency and/or well documented at this time. These system requirements will be included in a request for proposal, or plans, specifications, and estimate bid document package. Therefore it will require significant stakeholder involvement and/or technical expertise to develop these items during the project delivery process. Please explain why you selected or did not select this item.

[Click here to enter text.](#)

- Multiple agencies will be responsible for one or more aspects of the project design, construction, deployment, and/or the ongoing operations and maintenance of the system. Please explain why you selected or did not select this item.

[Click here to enter text.](#)

6. If you selected any of the items in question 5, FHWA and WSDOT consider the project to be high risk. Use this table for additional requirements:

Total project cost for high risk ITS projects		
Adaptive signal control technology (ASCT) projects	Other types of ITS projects	
	Greater than or equal to \$1,000,000 ²	Less than \$1,000,000 ²
Additional systems engineering documents (Concept of Operations, System Requirements, Verification Plan, and Validation Plan) ¹ are required.	Additional systems engineering documents (Concept of Operations, System Requirements, Verification Plan, and Validation Plan) ¹ are required.	Additional systems engineering documents (Concept of Operations, System Requirements, Verification Plan, and Validation Plan) ¹ are recommended. This decision requires FHWA concurrence through the WSDOT Local Programs Engineer prior to submitting a construction authorization request.
Notes: 1. See definitions in Section 41.3. 2. Use the amount from question 4.		

7. What is the name of the regional ITS architecture and which portions of the architecture will be implemented? Is the project consistent with the architecture? Are revisions to the architecture required? Also, which user services, physical subsystem elements, information flows, and market/service packages will be completed, and how will these pieces be part of the architecture?

[Click here to enter text.](#)

8. Identify the participating agencies, their roles and responsibilities, and the concept of operations. For the elements and market/service packages to be implemented, define the high-level operations of the system. This includes where the system will be used, its performance parameters, its life cycle, and which agency will operate and maintain it. Discuss the established requirements or agreements on information sharing and traffic device control responsibilities. The regional ITS architecture operational concept is a good starting point for discussion.

If this is a high risk project and a more extensive Concept of Operations document is being prepared for this project (see question 6), this answer can be a simple reference to that document.

[Click here to enter text.](#)

9. Define the system requirements. Based on the concept of operations, define the “what” and not the “how” of the system. Define the detailed requirements for eventual detailed design. The applicable high-level functional requirements from the regional architecture are a good starting point for discussion. A review of the requirements by the project stakeholders is recommended.

If this is a high risk project and a more extensive System Requirements document is being prepared for this project (see question 6), this answer can be a simple reference to that document.

[Click here to enter text.](#)

10. Provide an analysis of alternative system configurations and technology options to meet requirements. This analysis should outline the strengths and weaknesses, technical feasibility, institutional compatibility, and life cycle costs of each alternative. The project stakeholders should have had input in choosing the preferred solution.

[Click here to enter text.](#)

11. Identify procurement/contracting options. Since there are different procurement methods for different types of projects, the decision regarding the best procurement option should consider the level of agency participation, compatibility with existing procurement methods, the role of the system integrator, and life cycle costs. Some options to consider include consultant design/low-bid contractor, systems manager, systems integrator, task order, and design/build.

If the ITS portions of the project significantly meet the definition of construction, construction by low-bid contract would be used. Non-construction ITS portions of the project, such as services for software development, systems integration, systems deployment, systems management, or design, will be either engineering or service contracts. In these cases, a qualifications-based selection (QBS) or best value procurement may be more appropriate. For guidance on procurement options for ASCT systems, refer to Pages 15-20 of USDOT's *Model Systems Engineering Documents for Adaptive Signal Control Technology (ASCT) Systems*, FHWA-HOP-11-027, August 2012.

[Click here to enter text.](#)

12. Identify the applicable ITS standards and testing procedures. Include documentation on which standards will be incorporated into the system design. Also include justification for any applicable standards not incorporated. The standards discussion in the regional architecture is a good starting point for discussion.

[Click here to enter text.](#)

13. Outline the procedures and resources necessary for operations and management of the system. In addition to the concept of operations, document any internal policies or procedures necessary to recognize and incorporate the new system into the current operations and decision-making processes. Also, resources necessary to support continued operations, including staffing and training must be recognized early and be provided for. Such resources must also be provided to support necessary maintenance and upkeep to ensure continued system viability.

[Click here to enter text.](#)

Appendix 41.54 FHWA Washington Division ITS Project Contracting Guidance September 2012

Purpose

The purpose of this document is to provide basic guidance related to the procurement and administration of Federal-Aid Intelligent Transportation System (ITS) contracts.

Scope

This document is intended to be used by the Federal Highway Administration (FHWA) Washington Division Office, Washington State Department of Transportation (WSDOT), and local agencies as a guide on the proper types of procurement methods for various types of ITS projects. This guidance is not all encompassing as ITS projects can vary significantly in scope. However, it should provide adequate information to address a majority of situations. Specific questions about an individual ITS project should be directed to the Washington Division Office.

Construction vs. Non-construction

ITS improvements may be incorporated as part of a traditional federal-aid construction contract, or the contracting agency may elect to procure ITS services under a separate contract (i.e., stand-alone ITS projects). When procured as a separate contract, the scope of an ITS contract will determine the applicability of Federal procurement requirements. Title 23 United States Code Section 101(a)(3) provides a broad definition for construction for Federal-Aid eligibility purposes. FHWA generally interprets the definition broadly resulting in many types projects being classified as construction. Very simply, a contract that incurs costs incidental to the construction or reconstruction of a highway, including improvements that directly facilitate and control traffic flow (e.g., traffic control systems) are by definition construction contracts. This includes rehabilitation of an existing physical ITS infrastructure. Construction contracts must follow the regulatory requirements of [23 CFR 635](#) or [23 CFR 636](#) in the case of Design Build.

Non-construction type ITS contracts will be either Engineering Contracts or Service Contracts. Engineering is defined as professional services of an engineering nature as defined by state law. If the ITS contract primarily involves engineering then qualifications-based selection (QBS) procedures in compliance with the Brooks Act, must be followed. Service contracts (non-construction, non-engineering in nature) are to be procured in accordance with the *Common Rule for Grants and Cooperative Agreements to States and Local Governments* found at 49 CFR 18.36.

Types of ITS Projects

Stand-alone ITS projects can generally be categorized into one of the following types of ITS projects: 1) planning/research, 2) preliminary engineering/project development, 3) software development/system integration, 4) system deployments, 5) traditional construction, and 6) operations and maintenance. All Federal-Aid ITS projects in [23 CFR 940](#), regardless of the type, are directed to follow a Systems Engineering process. Refer to WSDOT [Design Manual Chapter 1050](#) and WSDOT LAG Manual [Chapter 41](#).

The following table provides further information about each of these ITS project types.

ITS Project Type	Description	Examples
Planning/ Research	Generally, involves studies that research new concepts or develop plans or procedures at a broader agency- or region-wide level. These are generally are not construction and often done by agency personnel.	<ul style="list-style-type: none"> • Regional ITS Architecture development and maintenance • Regional Concept of Operation • Traffic incident management planning • Standards testing and specification development • Public outreach and communication
Preliminary Engineering/ Project Development	Generally, a project or phase of a larger project, that leads to some type of ITS deployment/ construction. Typically involve some type of service or engineering contact, or work done by agency personnel and are generally not considered construction.	<ul style="list-style-type: none"> • Scoping/field surveys • Project-level Concept of Operation • Environmental Review • Development of RFPs • Development of PS&Es • Evaluation of technology, networking, system architecture alternatives
Software Development/ System Integration	Generally, involves projects that develop new or upgraded ITS-related software or involve integrating ITS services and equipment. These are typically not construction and often fall under a service contract.	<ul style="list-style-type: none"> • Traffic Management Center (TMC) central software design, development, installation • Modifying existing central system software to communicate with new field equipment • Incorporation of device control software into central systems • Acceptance testing and configuration management
System Deployments	Generally, includes total system implementation involving design, equipment, computer systems, telecommunications, and integration. Contracts are often non-construction in nature depending on the amount and type of field work relative to the overall project. These types of projects will often be the least cut and dry in terms of the appropriate contracting method.	<ul style="list-style-type: none"> • Road-weather information systems (RWIS) • Adaptive Signal Control Systems
Traditional Construction	Typical construction projects involving considerable installation of equipment or work in the field. Design-Bid-Build (low bid) or Design-Build contracting appropriate for this type of work.	<ul style="list-style-type: none"> • Installation of variable message signs • Installation of poles, controller cabinets, foundations, guardrail, gantries • Installation of radio towers and civil infrastructure for wireless systems • Installation of tolling field equipment (e.g. tag readers, video cameras, etc.) • Installation of underground infrastructure (trenching, cable installation, etc.)
Operations/ Maintenance	On-going operations and/or maintenance of ITS services, software, and equipment. Typically a service contract (non-construction)	<ul style="list-style-type: none"> • Operating costs for traffic monitoring, management, control systems (e.g., rent, communications, labor, utilities) • Preventative maintenance

42.1 Introduction

The City Design Standards Committee and the County Design Standards Committee, in accordance with [RCW 35.78.030](#) and [43.32.020](#), meet on a regular basis to review and update the city and county design standards for all facilities (NHS and Non-NHS).

The Local Agency Engineer may approve use of the minimum AASHTO and related standards as contained in the references. Design deviations must have the approval of the Washington State Department of Transportation (WSDOT) Local Programs in accordance with [RCW 35.78.040](#) or [RCW 36.86.080](#) as appropriate. When AASHTO and/or related design standards as contained in the references are updated and published, agencies must incorporate the new design standards for all projects no later than two years after of the publication date.

All projects are subject to Americans with Disabilities Act (ADA) and Section 504 of the Rehabilitation Act requirements for accessibility. For guidance on ADA standards, please see *Design Manual* M 22-01 [Chapter 1510](#) and the Local Agency ADA Planning and Design Resource web page at www.wsdot.wa.gov/LocalPrograms/Traffic/ada.htm.

These standards apply to new construction and reconstruction projects, 3R and 2R projects, and low volume road and street projects on all routes which are classified as Principal Arterials, Minor Arterials, or Collectors. These standards are applicable to new or reconstructed bridges on rural minor collectors, local roads, and local streets.

Included in the standards are the Local Agency Design Matrices. The matrices are used to standardize design element requirements based on project type for all facilities. The Local Agency Design Matrices Checklists may serve as design documentation for decisions made.

In adopting these standards, the committees seek to encourage standardization of road design elements where necessary for consistency and to assure that motoring, bicycling, and pedestrian public safety needs are met. Considerations include safety, convenience, context sensitive solutions, proper drainage, and economical maintenance. The committees recognize that cities and counties must have the flexibility to carry out the general duty to provide streets, roads, and highways for the diverse and changing needs of the traveling public.

These standards cannot provide for all situations. They are intended to assist, but not to substitute for, competent work by design professionals. It is expected that land surveyors, engineers, and architects will bring to each project the best skills from their respective disciplines. These standards are also not intended to limit any innovative or creative effort, which could result in better quality, better cost savings, or both. An agency may adopt higher standards to fit local conditions. Special funding programs may also have varying standards.

The decision to use a particular road design element at a particular location should be made on the basis of an engineering analysis of the location. Thus, while this document provides design standards, it is not a substitute for engineering judgment.

Engineers should take into account all available information, including available funding, and use the professional judgment that comes from training and experience to make the final design determination. There shall be a record, of the matters considered during the design process that justify decisions made regarding the final project design. The project design must be approved by the approving authority as outlined on the agency's Certification Acceptance Agreement or the acting designated authority for a Non-Certification Acceptance agency. See [Chapter 43](#) and [Appendix 43.62](#).

42.2 Committee Membership

City Design Standards Committee RCW 35.78.020	County Design Standards Committee RCW 43.32.010	Other Participants
Jim Parvey, PE Senior Principal Engineer City of Tacoma jparvey@cityoftacoma.org	Seth Walker, PE Assistant County Engineer Columbia County seth_walker@co.columbia.wa.us	Alison Hellberg Association of Washington Cities alisonh@awcnet.org
Charles Hill, PE Senior Civil Engineer City of Puyallup chill@ci.puyallup.wa.us	Jeff Tincher, PE County Engineer Grant County jtincher@co.grant.wa.us	Randy Hart, PE County Road Administration Board randy@crab.wa.gov
Mike Johnson, PE Design Engineering and Construction Advisor City of Seattle mike.johnson@seattle.gov	Mitch Reister, PE County Engineer Spokane County mreister@spokanecounty.org	Chris Workman, PE Project Engineer Transportation Improvement Board chrisw@tib.wa.gov
Mike Taylor, PE City Engineer City of Spokane pmtaylor@spokanecity.org	Jon Brand, PE Assistant Director of Roads and Engineering Kitsap County jbrand@co.kitsap.wa.us	John Donahue WSDOT Design donahjo@wsdot.wa.gov
Martin Hoppe, PE, PTOE City of Lacey Transportation Manager pmhoppe@ci.lacey.wa.us	Bob McEwen, PE Program Engineer Snohomish County bob.mcewen@co.snohomish.wa.us	Megan Hall, PE Federal Highway Administration megan.hall@fhwa.dot.gov
Ravyn Whitewolf, PE, PMP, AVS Public Works Director City of Blaine rwhitewolf@cityofblaine.com	Ramiro Chavez, PE Public Works Director Thurston County chavezr@co.thurston.wa.us	Mike Horton Operations Mgr. for Transportation AECOM michael.horton@aecom.com

These design standards were developed with the approval and authorization of:

 Kyle McKeon, Committee Chair
 Engineering Services Manager
 Headquarters Local Programs
 Washington State Department of Transportation

42.3 Local Agency Design Matrices

The Local Agency Design Matrices were created as part of the Local Agency Standards to assist designers in determining the design level for the geometric and safety elements of a project. The Local Agency Design Matrix Checklist may serve as documentation for design decisions made.

.31 Using the Matrices – The column headings on each of the three design matrices are design elements. They are based principally on the 13 controlling design criteria recognized by FHWA: design speed, lane width, shoulder width, bridge width, structural capacity, horizontal alignment, vertical alignment, grade, stopping sight distance, cross slope, superelevation, vertical clearance, and horizontal clearance. Within the column headings, some of the controlling criteria have been combined (for example, design speed is part of horizontal and vertical alignment). The matrices are divided into three tables, one each for Roadways, Cross Roads, and Bridges. Within the three tables the project types are identical, design elements vary depending on which elements apply.

A blank cell within the design matrix signifies that the design element need not be addressed because it is beyond the scope of the project type.

Design levels of City and County Design Standards (D), AASHTO (A), and Agency Evaluate (AE), are used in the matrix. The design level codes are noted in the cells by D, A or AE or by a number corresponding to a footnote. For roads that have volumes less than 400 ADT, AASHTO Geometric Design of Very Low Volume Roads (ADT<400) may be used.

Optional Checklists have been provided for the designer to use with the matrix. A checklist is available for each type of project in [Appendix 42.101](#).

Matrix Cells: Each Matrix cell is either blank or has a coded design level.

.32 Design Levels – If the Design Level is D, use the Geometric Cross-Section for Two-Way Roads and Streets within the City and County Design Standards on page 12.

If the design level is A, the design standard is AASHTO (the most current edition of the AASHTO publication *A Policy on Geometric Design of Highway and Streets*, “Guidelines for Geometric Design of Very Low-Volume Local Roads (ADT< 400),” or as noted in the City and County Design Standards. When AASHTO and/or related design standards as contained in the references are updated and published, agencies must comply with the new design standards for all projects no later than two years after of the publication date.

When the Matrix cell has either a “D” or an “A” and the final design utilizes something less than Design Level A, a Design Deviation, approved by Headquarters Local Programs, is required.

A Blank Cell on a matrix line indicates that particular design element requires no evaluation or documentation. If the agency decides to improve or modify a blank cell design element, that element must meet Design Level A and the agency must justify in their design document files why the decision to upgrade the design element was made. Per FHWA guidelines, if an improvement in a “Blank Cell” area is made, it must meet all requirements of design level A. Or if, in the opinion of the agency’s design Engineer, Design Level A cannot be achieved, a Design Exception may be considered.

AE in a matrix cell indicates that an agency needs to determine if the existing design element is less than Design Level A. If the existing design element meets or exceeds Design Level A the agency notes that in the design documents and no further action is required. If the existing design element is less than Design Level A, the agency shall determine the impacts and cost effectiveness of upgrading the design element to Design Level A. The decision whether or not to upgrade, and its analysis and justification shall be in the agency design documentation files. If the agency upgrades, Design Level A applies. Or if, in the opinion of the agency's design Engineer, Design Level A cannot be achieved, a Design Exception may be utilized.

A Design Exception may be utilized if, in the opinion of the local agency's design Engineer, the existing design element is being improved but Design Level D or A cannot be achieved. For example, design standard requires a 6 foot wide shoulder for a project, the existing condition is a two foot wide shoulder but the best that can be reasonably achieved is a 4 foot wide shoulder. This is a Design Exception, improvement is being made but not to Design Level A.

42.4 Local Agency Design Matrix Definitions

.41 Design Elements – Design elements are the principal elements of design that are common to projects. The following elements are shown on the Design Matrix.

- Horizontal Alignment is the horizontal attributes of the roadway including horizontal curvature, superelevation, and stopping sight distance; all based on design speed.
- Vertical Alignment is the vertical attributes of the roadway including vertical curvature, profile grades, and stopping sight distance; all based on design speed.
- Lane Width is the distance between lane lines.
- Shoulder Width is the distance between the outside or inside edge line and the edge of in-slope, or face of barrier.
- Lane and Shoulder Taper (pavement transitions) are the rate and length of transition of changes in width of roadway surface.
- Pedestrian Facility is a facility designed to meet the needs of pedestrians in accordance with city, county, and ADA requirements concurrent with a local agency project
- Sidewalk Width is the width of a sidewalk from the face of curb to the back of sidewalk.
- Cross Slope, Lane is the rate of elevation change across a lane. This element includes the algebraic difference in cross slope between adjacent lanes.
- Cross Slope, Shoulder is the rate of elevation change across a shoulder.
- Superelevation is the rotation of the roadway cross section in such a manner as to overcome part of the centrifugal force that acts on a vehicle traversing a curve.
- Fill/Ditch Fore Slope is downward slope from edge of shoulder to bottom of ditch or catch.
- Clear Zone is the total roadside border area, starting at the edge of the traveled lane, available for use by errant vehicles. This area may consist of a shoulder, a recoverable slope, a nonrecoverable slope, and/or a clear run-out area.
- Safety Improvements are the safety items listed under the "Safety Improvements" section of these standards.

- Shared Use Bicycle and Pedestrian Facilities are walkways, paths, or trails for shared use by both pedestrian and bicycle traffic. Effective July 1, 2012, refer to the current AASHTO bicycle design standards and/or standards submitted by the local agency which have been approved by Local Programs for any facility allowing bicycle traffic.
- Turn Radii is the geometric design of the intersection to allow the design vehicle for each turning movement to complete the turn without encroachment.
- I/S (Intersection) Sight Distance is the distance that the driver of a vehicle on the crossroad can see along the through roadway, as compared to the distance required for safe operation.
- I/S Angle is the angle between any two intersecting legs at the point that the center lines intersect.
- Barriers Standard Run (Std Run) are guardrail and other barriers excluding terminals, transitions, attenuators, and bridge rails.
- Barriers Bridge Rail is barrier on a bridge excluding transitions.
- Bridge Vertical Clearance is the minimum height between the roadway including shoulder and an overhead obstruction.
- Bridge Structural Capacity is the load bearing ability of a structure.
- Terminals are crashworthy end treatment for longitudinal barriers that is designed to reduce the potential for spearing, vaulting, rolling, or excessive deceleration of impacting vehicles from either direction of travel. Impact attenuators are considered terminals and beam guardrail terminals include anchorage.
- Transitions are sections of barriers used to produce a gradual stiffening of a flexible or semi-rigid barrier as it connects to a more rigid barrier or fixed objects.

.42 Project Type Definitions

- New Construction involves the construction of a new roadway facility or structure where nothing of its type currently exists.
- Reconstruction projects may add additional travel lanes to an existing roadway or bridge and if 50 percent or more of the project length involves vertical or horizontal alignment changes, the project will be considered reconstruction.
- 3R projects focus primarily on the preservation and extending of the service life of existing facilities and on safety enhancements. Work may include: resurfacing, pavement structural and joint repair, lane and shoulder widening, alterations to vertical grades and horizontal curves, bridge repair, removal or protection of roadside obstacles, and improving bridges to meet current standards for structural loading and to accommodate the approach roadway width.
- 2R projects focus primarily on restoration of pavement structure, crown correction, ride quality basic safety, and spot safety. Widening shoulders for continuity with the existing roadway cross section is acceptable.
- Railroad is a project to reduce the accident frequency and severity at grade crossings. Project elements may include, signals, bells, signage, pavement markings gates or surfacing at the crossing. Railroad-highway grade separation projects are also in this category. If the project includes other roadway work, use 3R matrix line.
- Bridge New/Replacement is a new bridge or a replacement of an existing bridge.
- Bridge Widening is the widening of existing bridges.

- Bridge-Other are Project types that may include, scour mitigation, painting, seismic retrofit, deck repair, strengthening, rehabilitation, and electrical mechanical repairs.
- Paths and/or Trails is the construction of non-motorized facilities that are independent of a roadway alignment.
- Pedestrian Facilities are projects with a main focus of providing pedestrian facilities for public use.
- Other, Interpretive Centers, Etc. projects may include, bicycle facilities, structures, bus shelters, archeology and historic preservation, and buildings.
- Parking Facilities are projects that construct parking facilities. Project types may include Park and Ride facilities and on-street parking.

.43 Other Definitions

- Average Daily Traffic (ADT) – The general unit of measure for traffic defined as the total volume during a given time period (in whole days), greater than one day and less than one year, divided by the number of days in that time period.
- Design Hourly Volume (DHV) – The DHV is generally the 30th highest hourly volume (30 DHV) of the future year chosen for design. On the average rural road or arterial, DHV is about 15 percent of ADT. For urban areas, DHV is usually between 8 to 12 percent of the ADT.
- Low Volume Roads and Streets – For this document, a collector or lower classified road or street with an ADT of less than 400.
- Resurfacing – The addition of a layer or layers of paving material to provide additional structural integrity or improved serviceability and rideability.
- Restoration – Work performed on either pavement sections or bridge decks to render them suitable for an additional stage of construction. This may include supplementing the existing roadway by increasing surfacing and paving courses to provide structural capability and minor shoulder widening to provide roadway section continuity. Restoration will generally be performed within the existing right of way.
- Rehabilitation – Similar to “Restoration” except the work may include, but is not limited to, the following:
 - Reworking, strengthening, or removing and replacing the base and/or subgrade.
 - Recycling or reworking existing materials to improve their structural integrity.
 - Adding underdrains.
 - Replacing or restoring malfunctioning joints.
 - Substantial pavement under-sealing when essential for stabilization.
 - Pavement grinding to restore smoothness, providing adequate structural thickness remains.
 - Removing and replacing deteriorated materials.
 - Crack and joint sealing but only when the required shape factor is established by routing or sawing.
 - Improving or widening shoulders.Rehabilitation may require acquisitions of additional right of way.
- Traveled Lane – The portion of the roadway intended for the movement of vehicles, exclusive of shoulders and lanes for parking, turning, and storage for turning.

.044 Safety Improvements – When using AASHTO guidance for clear zone determinations, the designer should take into account all AASHTO guidance (i.e., AASHTO Roadside Design Guide) relating to clear zone and project circumstances. See references section of this chapter.

Mandatory Upgrades

1. Update all delineation and signing in accordance with the current MUTCD. (This does not include replacement of sign bridges or cantilever supports.)
2. Modify substandard guardrail transitions and terminals to current standards.

Agency Evaluate Need

3. Adjust existing features that are affected by resurfacing, such as guardrails, monuments, catch basins, and access covers. Adjustment may include asphalt tapers as appropriate.
4. Modification of drainage structures, which present a hazard in the clear zone, e.g., beveled end sections/safety bars for both parallel and cross-drains.
5. Remove, relocate, reduce severity of hazard by providing crashworthy features, protect, or delineate roadside obstacles inside the design clear zone.
6. Restore sight distance at public road intersections and the inside of curves through low cost measures if they are available such as removal or relocation of signs and other obstructions, and cutting of vegetative matter. The local agency Engineer will determine if the measures are low cost.

Project Type	Roadways															
	Horiz. Align.	Vert. Align.	Lane Width	Shldr Width	Lane & Shldr Taper	Pedestrian Facilities	Cross Slope Lane	Cross Slope Shldr	Fill/Ditch Slopes	Safety Improvements	Shared Bike/Ped Facilities	Turn Radii	I/S Sight Dist	I/S Angle	Guardrail & Barrier	
Design Elements ⇨																
New Construction	D	D	D	D	D	1	D	D	D	A	1	A	D	A	A	
Re-Construction	A	A	A	A	A	1	A	A	A	A	1	A	A	A	A	
3R	AE	AE	AE	AE	AE	1	AE	AE	AE	2	1	AE	AE	AE	1	
2R							AE	AE		2	1				1	
Railroad (if roadway work included, use 3R line)										AE	1		AE		1	
Bridge Rehabilitation, Paint, Seismic, Scour, etc.																
Trails	1	1	1	1			1	1	1	1	1	1		1		
Pedestrian Facility Improvement Projects						1					1					
Other, Interpretive Centers, etc.	1	1	1	1	1	1	1	1	1	A	1	1	1	1	1	
Parking Facilities	A	A	A	A	A	1	A	A	A	A	1	A	A	A	1	

- 1. When provided, must meet current applicable standards.
 - 2. Refer to Safety Improvements on page 7. Mandatory Upgrade items 1 and all others are AE.
- D Design Level D
A Design Level A
AE Agency Evaluate to Design Level A

Local Agency Design Matrix
Table 1.1

↓ Project Type	Cross Roads						
Design Elements ⇨	Horiz. Align	Vert. Align	Lane Width	Shldr Width	Fill/Ditch Slopes	Safety Improvements	Shared Bike/Ped Facilities
New Construction	AE	AE	AE	AE	AE	2	1
Re-Construction	AE	AE	AE	AE	AE	2	1
3R	AE	AE	AE	AE	AE	2	1
2R							1
Railroad (If roadway work included, use 3R line)							
Bridge Rehabilitation, Paint, Seismic, etc.							
Trails							
Pedestrian Facility Improvement Projects							
Other, Interpretive Centers, etc.	1	1	1	1	1	1	1
Parking Facilities	A	A	A	A	A	1	1

D Design Level D

A Design Level A

AE Agency Evaluate to Design Level A

1. When provided, must meet current standards.

2. Refer to Safety Improvements on page 7. Mandatory Upgrade items 1 and all others are AE.

Local Agency Design Matrix

Table 1.2

↓ Project Type	Bridges				
Design Elements ⇨	Lane Width	Shldr Width	Vertical Clearance	Structural Capacity	Bridge Rail
New Construction	D	D	D	D	D
Re-Construction	A	A	D	D	D
3R	AE	AE	AE	AE	1
2R			AE	AE	1
Railroad (If roadway work included, use 3R line)					1
Bridge Rehabilitation, Paint, Seismic, etc.					
Trails	1	1	1	1	1
Pedestrian Facility Improvement Projects					
Other, Interpretive Centers, etc.	1	1	1	1	1
Parking Facilities	A	A	AE	AE	1

Local Agency Design Matrix

Table 1.3

DEFINITION OF ROADWAY ELEMENTS

ROADWAY WITH MONOLITHIC CURB AND SIDEWALK

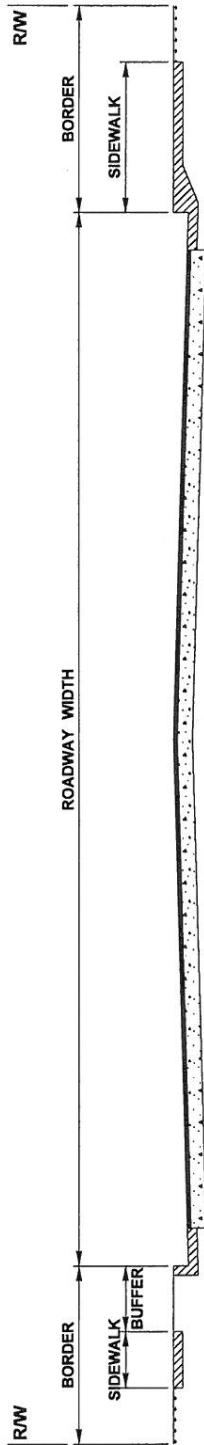

CURBED ROADWAY WITH SIDEWALK JOINT

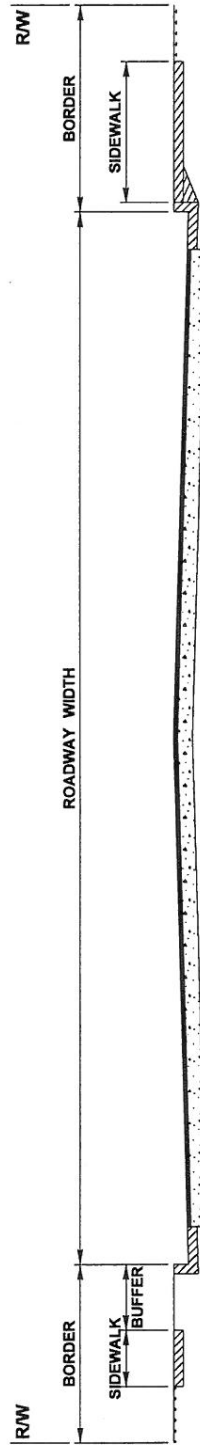

SHOULDERED ROADWAY

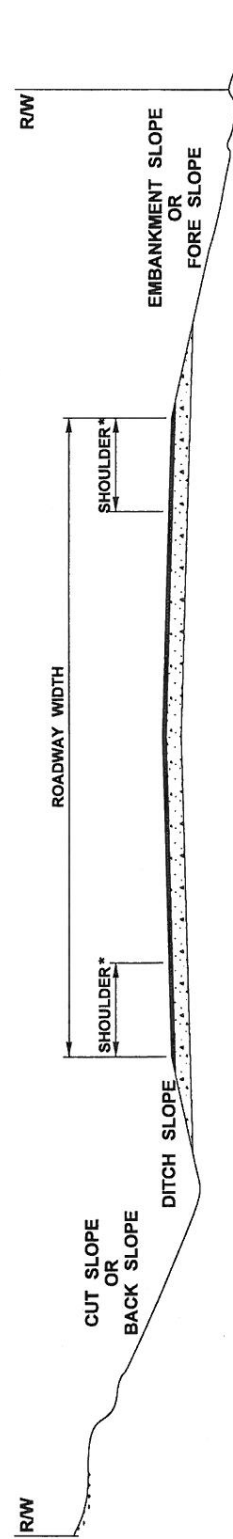

* DOES NOT INCLUDE WIDENING FOR GUARDRAIL OR OTHER SPECIAL PURPOSES

Cross Section

42.5 Design Level D Standards for Two Way Roads and Streets

Design Standards	Arterial							Collector				
	Principal			Minor				Collector				
	Curbed ⁽⁴⁾		Shouldered	Curbed ⁽⁴⁾		Shouldered		Curbed ⁽⁴⁾	Shouldered			
	DHV All	DHV Below 200	DHV 200 and Over	DHV All	DHV Below 100	DHV 100 to 200	DHV 201 and Over	DHV 400 and Over	ADT 400 to 750	ADT 751 to 1000	DHV 100 to 200	DHV 201 and Over
Right of Way	Not less than required for all design elements.											
Roadway Width ⁽¹⁾⁽²⁾⁽⁷⁾⁽⁹⁾	24ft	36ft	40ft	24ft	32ft	36ft	40ft	24ft	26ft	28ft	34ft	40ft
Lane width:												
1. Exterior ⁽²⁾⁽⁷⁾	12ft	12ft	12ft	12ft	12ft	12ft	12ft	12ft	10ft	10ft	11ft	12ft
2. Interior Thru ⁽²⁾	11ft	11ft	11ft	11ft	11ft	11ft	11ft	11ft	10ft	10ft	11ft	11ft
3. Two Way Left Turn ⁽²⁾	11ft	11ft	11ft	11ft	11ft	11ft	11ft	11ft	10ft	10ft	11ft	11ft
4. Exclusive Turn ⁽²⁾	11ft	11ft	11ft	11ft	11ft	11ft	11ft	11ft	10ft	10ft	11ft	11ft
5. Parking ⁽²⁾	10ft ⁽³⁾			10ft ⁽³⁾					(5)			
Shoulder Width ⁽⁶⁾⁽⁷⁾⁽⁹⁾⁽²⁾		6ft	8ft		4ft	6ft	8ft		3ft	4ft	6ft	8ft
Clear Zone/Side Slopes	AASHTO ⁽¹⁰⁾											
Ditch Slope (in slope)	Slopes steeper than 4:1 should only be used when achieving a 4:1 slope is impractical.											

- (1) For curbed, distance from face of curb to face of curb. For shouldered, distance from paved edge to paved edge of shoulder.
- (2) May be reduced to minimum allowed by AASHTO.
- (3) 8 feet may be acceptable when the lane is not likely to become a traffic lane in the foreseeable future.
- (4) Curbed section is appropriate for urban setting.
- (5) Industrial areas 8 feet to 10 feet. Residential areas 7 feet to 10 feet.
- (6) When guardrail is necessary, provide 2 feet of widening or longer posts to ensure lateral support.
- (7) For roads with traffic volumes of less than 400 ADT, the low volume road and street standards may be used.
- (8) Federal functional classification defined by WSDOT.
- (9) For guidance for one-way streets, see AASHTO, and the current uniform fire code.
- (10) When using AASHTO guidance for clear zone determinations, the designer should take into account all AASHTO materials relating to clear zone and project circumstances. See the reference section of this publication.

Note: Design Hourly Volume (DHV). The DHV is generally the 30th highest hourly volume (30 DHV) of the future year chosen for design. On the average rural road or arterial, DHV is about 15 percent of ADT. For urban areas, DHV is usually between 8 to 12 percent of the ADT or AADT.

<p>Detectable Warnings (Truncated Domes)</p>	<p>For dimensions, see the WSDOT Standard Plans, F40 series. For material contrast requirements, see proposed ADA guidance from the U.S. Access Board at www.access-board.gov/ada-aba.htm U.S. Access Board at www.access-board.gov/prowac/draft.htm</p>
<p>New Sidewalks (when provided)</p>	<ul style="list-style-type: none"> • Minimum Width – 60 inches continuous clear width exclusive of the curb or 48 inches clear width exclusive of the curb with 60 inch by 60 inch clear passing spaces at 200-foot maximum intervals. • Surface – Firm, stable, and slip resistant. • Crossslopes – 1:50 (2 percent) maximum. • Running Slope – When within street or highway right of way, must be consistent with the slope established by the roadway. If outside street or highway right of way, must be 5% max. unless designed as a ramp (see ADA guidance). • Buffer – Separation from vehicular ways by curbs or other barriers.

42.6 Roadway Geometrics

The AASHTO publication *A Policy on Geometric Design of Highways and Streets* (Green Book) is the design standard accepted by FHWA for project funding. The designer should read all text associated with the standards and should also consider related tables and text. Additionally, design references are provided in the References for New Construction and Reconstruction, 3R, and 2R Standards and in [Tables 1.1](#), [1.2](#), and [1.3](#) of this chapter.

.61 Bridge Standards

Design Elements	References
Bridge Width	The minimum bridge width for two-way structures is the greater of: (1) the design roadway width, or (2) the existing roadway width.
Loading	HL 93 (for federally funded projects), others may use HS 20-44.
Vehicular Railing	AASHTO Crash Tested Rail, or Approved NCHRP 350 Crash Tested Rail.
Pedestrian Railing	AASHTO, NCHRP 350.
Approach Railing	AASHTO Crash Tested Rail, or Approved NCHRP 350 Crash Tested Rail.
Vertical Clearance	16.5 feet minimum.

.62 Other Standards

Design Elements	References
Bicycle	AASHTO Guide for the Development of Bicycle Facilities (RCW 35.75.060 and 36.82.145) and/or standards submitted by the local agency which have been approved by Local Programs.
Signing	MUTCD, as modified by the Washington State Transportation Commission per RCW 47.36.030 .
Americans with Disabilities Act – 1990 ADA	Code of Federal Regulations 28 CFR Part 35 , Interim Final Rules U.S. Department of Justice. The Architectural and Transportation Barriers Compliance Board WSDOT/ Standard F40 Series Current International Building Code, and Washington State Amendments.
Sidewalks	AASHTO Guide for Planning, Design, and Operation of Pedestrian Facilities
Low Volume Roads	2001 AASHTO Geometric Design of Very Low Volume Local Roads (ADT < 400)

42.7 3R Projects

.71 General Discussion – Funding restrictions and other considerations do not always allow improvement of all existing roads and streets to the standards desirable for new construction. Therefore, when pavement condition deteriorates to the level of minimal standards, a cost-effective pavement improvement is needed.

A project becomes 3R when the proposed improvement consists of resurfacing, restoration, or rehabilitation to preserve and extend the service life of the roadway, or enhances the safety of the traveling, bicycling, and/or walking public.

3R projects primarily involve work on an existing roadway surface and/or subsurface. Their purpose includes extending the service life, providing additional pavement strength, restoring or improving the original cross-section, increasing skid resistance, decreasing noise, improving the ride of the roadway, and enhancing safety.

Many factors influence the scope of 3R projects, including:

- Roadside conditions.
- Funding constraints.
- Environmental concerns.
- Changing traffic and land use patterns.
- Deterioration rate of surfacing.
- Accidents or accident rates.

Normally, all 3R improvements are made within the existing right of way, although acquiring right of way and/or easements should be considered when and where practical.

Each 3R project should be considered in context with the entire route between logical termini and within the constraints imposed by limited funding and other considerations.

As a minimum, normally include the following for a 3R project:

- Guardrail end treatments upgraded to current standards.
- Appropriate transition and connection of approach rail to bridge rail.
- Beveled end sections for both parallel and cross-drain structures located in the clear zone.
- Relocating, protecting, or providing breakaway features for sign supports and luminaires.
- Protection for exposed bridge piers and all abutments.
- Modification of raised drop inlets that present a hazard in the clear zone.

It is desirable to provide a roadside clear of fixed objects and nontraversable obstacles. The priority for action relative to roadside obstacles is: (1) remove, (2) redesign, (3) relocate, (4) reduce severity by crashworthy features, (5) protect, or (6) delineate.

On all projects, which include structures with deficient safety features, consideration must be given to correcting the deficient features. When complete upgrading is not practical, a partial or selective upgrading and/or other improvements should be considered to mitigate the effects of the substandard elements.

42.8 2R Projects

.81 **General Discussion** – Funding restrictions do not always allow improvement of existing roadways to the standards desired. Therefore, when pavement condition reaches a minimal condition, cost effective pavement improvements are needed.

Resurfacing and restoration (2R) projects involve work to restore the existing roadway surface and appurtenances for safe and efficient highway operation. This type of project provides for resurfacing of the existing roadway to provide structural adequacy, to restore the roadway surface condition, and to consider making minor safety improvements.

Resurfacing of the roadway will normally be to the existing width. This should consider paving of previously unpaved shoulders. If short lengths of narrower lanes or shoulders exist within the project limits, widening should be considered to provide roadway section continuity within the project limits.

42.9 References

The designer must use the standards and rationales incorporated into the following manuals (see the following page for addresses to acquire reference materials).

AASHTO

- *A Policy on Geometric Design of Highways and Streets*, 2011 Edition
- *Guide for Design of Pavement Structures*
- *Highway Drainage Guidelines*
- *Guide for Roadway Lighting*
- *Roadside Design Guide*
- *Geometric Design of Very Low Volume Local Roads (ADT<400)*
- *AASHTO Guide for the Development of Bicycle Facilities*

Transportation Research Board (TRB)

- *Highway Capacity Manual*

Washington State Department of Transportation (WSDOT)

- *Standard Specifications for Road, Bridge, and Municipal Construction* M 41-10
- Supplement to *MUTCD (WAC 468-95)*
- *Bridge Design Manual* LRFD M 23-50
- *Hydraulics Manual* M 23-03
- *Standard Plans* M 21-01
- *Design Manual* M 22-01
- WSDOT's *Pavement Design Website*: www.wsdot.wa.gov/Business/MaterialsLab/Pavements/PavementDesign.htm

Institute of Transportation Engineers (ITE)

- *Traffic Engineering Handbook*

FHWA

- *Manual on Uniform Traffic Control Devices* (MUTCD)
- 49 CFR Part 27 and Designing Sidewalks and Trails for Access, Part II

ADA

- 28 CFR Part 35, 28 CFR Part 36, Appendix A, and the Access Board's Proposed Public Right of Way Guidelines
- Local Agency ADA Planning and Design Resource
www.wsdot.wa.gov/LocalPrograms/Traffic/ada.html

Roundabouts

- NCHRP Reports 572, 672, and 772
- WSDOT *Design Manual* M 22-01
Chapter 1300 Intersection Control Type
Chapter 1320 Roundabouts

Traffic Calming

- *A Guidebook for Residential Traffic Management*, Final Report, December 1994, WSDOT Local Programs Division, Washington State Technology Transfer Center.

.91 Websites and Addresses to Acquire Reference Materials

AASHTO

AASHTO Bookstore

https://bookstore.transportation.org/item_details.aspx?id=104

TRB

Transportation Research Board National Research Council

500 5th Street NW

Washington, DC 20418

www.trb.org/highways1/public/highways.aspx

WSDOT

Publications Services

PO Box 47304

Olympia, WA 98504-7304

360-705-7430

www.wsdot.wa.gov/publications/manuals

ITE

Institute of Transportation Engineers

1627 Eye Street NW, Suite 600

Washington, DC 20006

202-785-0060

202-785-0609 (fax)

<http://ite.org/>

MUTCD

<http://mutcd.fhwa.dot.gov/ser-pubs.htm>

ADA

Office of the General Counsel Architectural and Transportation Barriers
Compliance Board

1331 F Street NW, Suite 1000

Washington, DC 20004-1111

www.access-board.gov

National Association of City Transportation Officials (NACTO)

Urban Bikeway Design Guide

- <http://nacto.org/cities-for-cycling/design-guide>

Urban Street Design Guide

- <http://nacto.org/usdg>

42.10 Appendices

42.101 [Local Agency Design Matrix Checklists](#)

Appendix 42.101 Local Agency Design Matrix Checklists

Design Element	Design Level	Any work on Blank Cell Design Element? If "No" move down to next Design Element	If "Yes"	Meets Standard? If "Yes" move down to next Design Element	If "No"	Upgraded to Standard? If "Yes" move down to next Design Element	If "No"	Is a Deviation or Design Exception Required? If "No" Document to File	If "Yes"	HQ Local Programs Deviation Approval Date	Local Agency Design Exception Approval Date
Roadways											
Horizontal Alignment		<input type="checkbox"/> Yes <input type="checkbox"/> No	→	<input type="checkbox"/> Yes <input type="checkbox"/> No	→	<input type="checkbox"/> Yes <input type="checkbox"/> No	→	<input type="checkbox"/> Yes <input type="checkbox"/> No	→		
Vertical Alignment		<input type="checkbox"/> Yes <input type="checkbox"/> No	→	<input type="checkbox"/> Yes <input type="checkbox"/> No	→	<input type="checkbox"/> Yes <input type="checkbox"/> No	→	<input type="checkbox"/> Yes <input type="checkbox"/> No	→		
Lane Width		<input type="checkbox"/> Yes <input type="checkbox"/> No	→	<input type="checkbox"/> Yes <input type="checkbox"/> No	→	<input type="checkbox"/> Yes <input type="checkbox"/> No	→	<input type="checkbox"/> Yes <input type="checkbox"/> No	→		
Shoulder Width		<input type="checkbox"/> Yes <input type="checkbox"/> No	→	<input type="checkbox"/> Yes <input type="checkbox"/> No	→	<input type="checkbox"/> Yes <input type="checkbox"/> No	→	<input type="checkbox"/> Yes <input type="checkbox"/> No	→		
Lane & Shoulder Taper		<input type="checkbox"/> Yes <input type="checkbox"/> No	→	<input type="checkbox"/> Yes <input type="checkbox"/> No	→	<input type="checkbox"/> Yes <input type="checkbox"/> No	→	<input type="checkbox"/> Yes <input type="checkbox"/> No	→		
Ped. Facility		<input type="checkbox"/> Yes <input type="checkbox"/> No	→	<input type="checkbox"/> Yes <input type="checkbox"/> No	→	<input type="checkbox"/> Yes <input type="checkbox"/> No	→	<input type="checkbox"/> Yes	→		
Cross Slope Lane	AE	→	→	<input type="checkbox"/> Yes <input type="checkbox"/> No	→	<input type="checkbox"/> Yes <input type="checkbox"/> No	→	<input type="checkbox"/> Yes <input type="checkbox"/> No	→		
Cross Slope Shoulder	AE	→	→	<input type="checkbox"/> Yes <input type="checkbox"/> No	→	<input type="checkbox"/> Yes <input type="checkbox"/> No	→	<input type="checkbox"/> Yes <input type="checkbox"/> No	→		
Fill/Ditch Slopes		<input type="checkbox"/> Yes <input type="checkbox"/> No	→	<input type="checkbox"/> Yes <input type="checkbox"/> No	→	<input type="checkbox"/> Yes <input type="checkbox"/> No	→	<input type="checkbox"/> Yes <input type="checkbox"/> No	→		
Safety Improvements	2	→	→	<input type="checkbox"/> Yes <input type="checkbox"/> No	→	<input type="checkbox"/> Yes <input type="checkbox"/> No	→	<input type="checkbox"/> Yes	→		
Shared Bike/Ped	1	→	→	<input type="checkbox"/> Yes <input type="checkbox"/> No	→	<input type="checkbox"/> Yes <input type="checkbox"/> No	→	<input type="checkbox"/> Yes	→		N/A
Turn Radii		<input type="checkbox"/> Yes <input type="checkbox"/> No	→	<input type="checkbox"/> Yes <input type="checkbox"/> No	→	<input type="checkbox"/> Yes <input type="checkbox"/> No	→	<input type="checkbox"/> Yes <input type="checkbox"/> No	→		
Sight Distance		<input type="checkbox"/> Yes <input type="checkbox"/> No	→	<input type="checkbox"/> Yes <input type="checkbox"/> No	→	<input type="checkbox"/> Yes <input type="checkbox"/> No	→	<input type="checkbox"/> Yes <input type="checkbox"/> No	→		
I/S Angle		<input type="checkbox"/> Yes <input type="checkbox"/> No	→	<input type="checkbox"/> Yes <input type="checkbox"/> No	→	<input type="checkbox"/> Yes <input type="checkbox"/> No	→	<input type="checkbox"/> Yes <input type="checkbox"/> No	→		
Std Run	1	→	→	<input type="checkbox"/> Yes <input type="checkbox"/> No	→	<input type="checkbox"/> Yes <input type="checkbox"/> No	→	<input type="checkbox"/> Yes	→		N/A
Cross Roads											
Horizontal Alignment		<input type="checkbox"/> Yes <input type="checkbox"/> No	→	<input type="checkbox"/> Yes <input type="checkbox"/> No	→	<input type="checkbox"/> Yes <input type="checkbox"/> No	→	<input type="checkbox"/> Yes <input type="checkbox"/> No	→		
Vertical Alignment		<input type="checkbox"/> Yes <input type="checkbox"/> No	→	<input type="checkbox"/> Yes <input type="checkbox"/> No	→	<input type="checkbox"/> Yes <input type="checkbox"/> No	→	<input type="checkbox"/> Yes <input type="checkbox"/> No	→		
Lane Width		<input type="checkbox"/> Yes <input type="checkbox"/> No	→	<input type="checkbox"/> Yes <input type="checkbox"/> No	→	<input type="checkbox"/> Yes <input type="checkbox"/> No	→	<input type="checkbox"/> Yes <input type="checkbox"/> No	→		
Shoulder Width		<input type="checkbox"/> Yes <input type="checkbox"/> No	→	<input type="checkbox"/> Yes <input type="checkbox"/> No	→	<input type="checkbox"/> Yes <input type="checkbox"/> No	→	<input type="checkbox"/> Yes <input type="checkbox"/> No	→		
Fill/Ditch Slopes		<input type="checkbox"/> Yes <input type="checkbox"/> No	→	<input type="checkbox"/> Yes <input type="checkbox"/> No	→	<input type="checkbox"/> Yes <input type="checkbox"/> No	→	<input type="checkbox"/> Yes <input type="checkbox"/> No	→		
Safety Improvements		<input type="checkbox"/> Yes <input type="checkbox"/> No	→	<input type="checkbox"/> Yes <input type="checkbox"/> No	→	<input type="checkbox"/> Yes <input type="checkbox"/> No	→	<input type="checkbox"/> Yes	→		
Shared Bike/Ped Facility	1	→	→	<input type="checkbox"/> Yes <input type="checkbox"/> No	→	<input type="checkbox"/> Yes <input type="checkbox"/> No	→	<input type="checkbox"/> Yes	→		N/A
Bridges											
Lane Width		<input type="checkbox"/> Yes <input type="checkbox"/> No	→	<input type="checkbox"/> Yes <input type="checkbox"/> No	→	<input type="checkbox"/> Yes <input type="checkbox"/> No	→	<input type="checkbox"/> Yes <input type="checkbox"/> No	→		
Shoulder Width		<input type="checkbox"/> Yes <input type="checkbox"/> No	→	<input type="checkbox"/> Yes <input type="checkbox"/> No	→	<input type="checkbox"/> Yes <input type="checkbox"/> No	→	<input type="checkbox"/> Yes <input type="checkbox"/> No	→		
Vertical Clearance	AE	→	→	<input type="checkbox"/> Yes <input type="checkbox"/> No	→	<input type="checkbox"/> Yes <input type="checkbox"/> No	→	<input type="checkbox"/> Yes <input type="checkbox"/> No	→		
Structural Capacity	AE	→	→	<input type="checkbox"/> Yes <input type="checkbox"/> No	→	<input type="checkbox"/> Yes <input type="checkbox"/> No	→	<input type="checkbox"/> Yes <input type="checkbox"/> No	→		
Bridge Rail	1	→	→	<input type="checkbox"/> Yes <input type="checkbox"/> No	→	<input type="checkbox"/> Yes <input type="checkbox"/> No	→	<input type="checkbox"/> Yes	→		N/A
Design Levels											
<input type="checkbox"/> Blank Cell D Design Level D A Design Level A AE Agency Evaluate to Design Level A						(1) When provided, must meet current standards. (2) Items 1 and 2 under Safety Improvements Definitions are required and all others are AE.					

2R Project Checklist Page 1 of 1

Design Element	Design Level	Meets AASHTO? If "Yes" move down to next Design Element	If "No"	Upgraded to AASHTO? If "Yes" move down to next Design Element	If "No"	Is a Deviation or Design Exception Required? If "No" Document to File	If "Yes"	HQ Local Programs Deviation Approval Date	Local Agency Design Exception Approval Date
Roadways									
Horizontal Alignment	AE	<input type="checkbox"/> Yes <input type="checkbox"/> No	→	<input type="checkbox"/> Yes <input type="checkbox"/> No	→	<input type="checkbox"/> Yes <input type="checkbox"/> No	→		
Vertical Alignment	AE	<input type="checkbox"/> Yes <input type="checkbox"/> No	→	<input type="checkbox"/> Yes <input type="checkbox"/> No	→	<input type="checkbox"/> Yes <input type="checkbox"/> No	→		
Lane Width	AE	<input type="checkbox"/> Yes <input type="checkbox"/> No	→	<input type="checkbox"/> Yes <input type="checkbox"/> No	→	<input type="checkbox"/> Yes <input type="checkbox"/> No	→		
Shoulder Width	AE	<input type="checkbox"/> Yes <input type="checkbox"/> No	→	<input type="checkbox"/> Yes <input type="checkbox"/> No	→	<input type="checkbox"/> Yes <input type="checkbox"/> No	→		
Lane & Shoulder Taper	AE	<input type="checkbox"/> Yes <input type="checkbox"/> No	→	<input type="checkbox"/> Yes <input type="checkbox"/> No	→	<input type="checkbox"/> Yes <input type="checkbox"/> No	→		
Ped. Facility	1	<input type="checkbox"/> Yes <input type="checkbox"/> No	→	<input type="checkbox"/> Yes <input type="checkbox"/> No	→	<input type="checkbox"/> Yes	→		N/A
Cross Slope Lane	AE	<input type="checkbox"/> Yes <input type="checkbox"/> No	→	<input type="checkbox"/> Yes <input type="checkbox"/> No	→	<input type="checkbox"/> Yes <input type="checkbox"/> No	→		
Cross Slope Shoulder	AE	<input type="checkbox"/> Yes <input type="checkbox"/> No	→	<input type="checkbox"/> Yes <input type="checkbox"/> No	→	<input type="checkbox"/> Yes <input type="checkbox"/> No	→		
Fill/Ditch Slopes	AE	<input type="checkbox"/> Yes <input type="checkbox"/> No	→	<input type="checkbox"/> Yes <input type="checkbox"/> No	→	<input type="checkbox"/> Yes <input type="checkbox"/> No	→		
Safety Improvements	2	<input type="checkbox"/> Yes <input type="checkbox"/> No	→	<input type="checkbox"/> Yes <input type="checkbox"/> No	→	<input type="checkbox"/> Yes	→		N/A
Shared Bike/Ped.	1	<input type="checkbox"/> Yes <input type="checkbox"/> No	→	<input type="checkbox"/> Yes <input type="checkbox"/> No	→	<input type="checkbox"/> Yes	→		N/A
Turn Radii	AE	<input type="checkbox"/> Yes <input type="checkbox"/> No	→	<input type="checkbox"/> Yes <input type="checkbox"/> No	→	<input type="checkbox"/> Yes <input type="checkbox"/> No	→		
Sight Distance	AE	<input type="checkbox"/> Yes <input type="checkbox"/> No	→	<input type="checkbox"/> Yes <input type="checkbox"/> No	→	<input type="checkbox"/> Yes <input type="checkbox"/> No	→		
I/S Angle	AE	<input type="checkbox"/> Yes <input type="checkbox"/> No	→	<input type="checkbox"/> Yes <input type="checkbox"/> No	→	<input type="checkbox"/> Yes <input type="checkbox"/> No	→		
Std Run	1	<input type="checkbox"/> Yes <input type="checkbox"/> No	→	<input type="checkbox"/> Yes <input type="checkbox"/> No	→	<input type="checkbox"/> Yes	→		N/A
Cross Roads									
Horizontal Alignment	AE	<input type="checkbox"/> Yes <input type="checkbox"/> No	→	<input type="checkbox"/> Yes <input type="checkbox"/> No	→	<input type="checkbox"/> Yes <input type="checkbox"/> No	→		
Vertical Alignment	AE	<input type="checkbox"/> Yes <input type="checkbox"/> No	→	<input type="checkbox"/> Yes <input type="checkbox"/> No	→	<input type="checkbox"/> Yes <input type="checkbox"/> No	→		
Lane Width	AE	<input type="checkbox"/> Yes <input type="checkbox"/> No	→	<input type="checkbox"/> Yes <input type="checkbox"/> No	→	<input type="checkbox"/> Yes <input type="checkbox"/> No	→		
Shoulder Width	AE	<input type="checkbox"/> Yes <input type="checkbox"/> No	→	<input type="checkbox"/> Yes <input type="checkbox"/> No	→	<input type="checkbox"/> Yes <input type="checkbox"/> No	→		
Fill/Ditch Slopes	AE	<input type="checkbox"/> Yes <input type="checkbox"/> No	→	<input type="checkbox"/> Yes <input type="checkbox"/> No	→	<input type="checkbox"/> Yes <input type="checkbox"/> No	→		
Safety Improvements	2	<input type="checkbox"/> Yes <input type="checkbox"/> No	→	<input type="checkbox"/> Yes <input type="checkbox"/> No	→	<input type="checkbox"/> Yes	→		N/A
Shared Bike/Ped. Facility	1	<input type="checkbox"/> Yes <input type="checkbox"/> No	→	<input type="checkbox"/> Yes <input type="checkbox"/> No	→	<input type="checkbox"/> Yes	→		N/A
Bridges									
Lane Width	AE	<input type="checkbox"/> Yes <input type="checkbox"/> No	→	<input type="checkbox"/> Yes <input type="checkbox"/> No	→	<input type="checkbox"/> Yes <input type="checkbox"/> No	→		
Shoulder Width	AE	<input type="checkbox"/> Yes <input type="checkbox"/> No	→	<input type="checkbox"/> Yes <input type="checkbox"/> No	→	<input type="checkbox"/> Yes <input type="checkbox"/> No	→		
Vertical Clearance	AE	<input type="checkbox"/> Yes <input type="checkbox"/> No	→	<input type="checkbox"/> Yes <input type="checkbox"/> No	→	<input type="checkbox"/> Yes <input type="checkbox"/> No	→		
Structural Capacity	AE	<input type="checkbox"/> Yes <input type="checkbox"/> No	→	<input type="checkbox"/> Yes <input type="checkbox"/> No	→	<input type="checkbox"/> Yes <input type="checkbox"/> No	→		
Bridge Rail	1	<input type="checkbox"/> Yes <input type="checkbox"/> No	→	<input type="checkbox"/> Yes <input type="checkbox"/> No	→	<input type="checkbox"/> Yes	→		N/A
Design Levels* <input type="checkbox"/> Blank Cell D Design Level D A Design Level A AE Agency Evaluate to Design Level A See Matrix Definitions for requirements.				(1) When provided, must meet current standards. (2) Items 1 and 2 under Safety Improvements Definitions are required and all others are AE.					

3R Project Checklist
Page 1 of 1

Design Element	Design Level	Meets AASHTO? If "Yes" move down to next Design Element	If "NO"	Upgraded to AASHTO? If Yes" move down to next Design Element	If "NO"	Is a Deviation or Design Exception Required? If "NO" Document to File	If "Yes"	HQ Local Programs Deviation Approval Date	Local Agency Design Exception Approval Date
Roadways									
Horizontal Alignment	A	<input type="checkbox"/> Yes <input type="checkbox"/> No	→	<input type="checkbox"/> Yes <input type="checkbox"/> No	→	<input type="checkbox"/> Yes	→		N/A
Vertical Alignment	A	<input type="checkbox"/> Yes <input type="checkbox"/> No	→	<input type="checkbox"/> Yes <input type="checkbox"/> No	→	<input type="checkbox"/> Yes	→		N/A
Lane Width	A	<input type="checkbox"/> Yes <input type="checkbox"/> No	→	<input type="checkbox"/> Yes <input type="checkbox"/> No	→	<input type="checkbox"/> Yes	→		N/A
Shoulder Width	A	<input type="checkbox"/> Yes <input type="checkbox"/> No	→	<input type="checkbox"/> Yes <input type="checkbox"/> No	→	<input type="checkbox"/> Yes	→		N/A
Lane & Shoulder Taper	A	<input type="checkbox"/> Yes <input type="checkbox"/> No	→	<input type="checkbox"/> Yes <input type="checkbox"/> No	→	<input type="checkbox"/> Yes	→		N/A
Ped. Facilities	1	<input type="checkbox"/> Yes <input type="checkbox"/> No	→	<input type="checkbox"/> Yes <input type="checkbox"/> No	→	<input type="checkbox"/> Yes	→		N/A
Cross Slope Lane	A	<input type="checkbox"/> Yes <input type="checkbox"/> No	→	<input type="checkbox"/> Yes <input type="checkbox"/> No	→	<input type="checkbox"/> Yes	→		N/A
Cross Slope Shoulder	A	<input type="checkbox"/> Yes <input type="checkbox"/> No	→	<input type="checkbox"/> Yes <input type="checkbox"/> No	→	<input type="checkbox"/> Yes	→		N/A
Fill/Ditch Slopes	A	<input type="checkbox"/> Yes <input type="checkbox"/> No	→	<input type="checkbox"/> Yes <input type="checkbox"/> No	→	<input type="checkbox"/> Yes	→		N/A
Safety Improvements	A	<input type="checkbox"/> Yes <input type="checkbox"/> No	→	<input type="checkbox"/> Yes <input type="checkbox"/> No	→	<input type="checkbox"/> Yes	→		N/A
Bike & Ped	1	<input type="checkbox"/> Yes <input type="checkbox"/> No	→	<input type="checkbox"/> Yes <input type="checkbox"/> No	→	<input type="checkbox"/> Yes	→		N/A
Turn Radii	A	<input type="checkbox"/> Yes <input type="checkbox"/> No	→	<input type="checkbox"/> Yes <input type="checkbox"/> No	→	<input type="checkbox"/> Yes	→		N/A
Sight Distance	A	<input type="checkbox"/> Yes <input type="checkbox"/> No	→	<input type="checkbox"/> Yes <input type="checkbox"/> No	→	<input type="checkbox"/> Yes	→		N/A
I/S Angle	A	<input type="checkbox"/> Yes <input type="checkbox"/> No	→	<input type="checkbox"/> Yes <input type="checkbox"/> No	→	<input type="checkbox"/> Yes	→		N/A
Std Run	A	<input type="checkbox"/> Yes <input type="checkbox"/> No	→	<input type="checkbox"/> Yes <input type="checkbox"/> No	→	<input type="checkbox"/> Yes	→		N/A
Cross Roads									
Horizontal Alignment	AE	<input type="checkbox"/> Yes <input type="checkbox"/> No	→	<input type="checkbox"/> Yes <input type="checkbox"/> No	→	<input type="checkbox"/> Yes <input type="checkbox"/> No	→		
Vertical Alignment	AE	<input type="checkbox"/> Yes <input type="checkbox"/> No	→	<input type="checkbox"/> Yes <input type="checkbox"/> No	→	<input type="checkbox"/> Yes <input type="checkbox"/> No	→		
Lane Width	AE	<input type="checkbox"/> Yes <input type="checkbox"/> No	→	<input type="checkbox"/> Yes <input type="checkbox"/> No	→	<input type="checkbox"/> Yes <input type="checkbox"/> No	→		
Shoulder Width	AE	<input type="checkbox"/> Yes <input type="checkbox"/> No	→	<input type="checkbox"/> Yes <input type="checkbox"/> No	→	<input type="checkbox"/> Yes <input type="checkbox"/> No	→		
Fill/Ditch Slopes	AE	<input type="checkbox"/> Yes <input type="checkbox"/> No	→	<input type="checkbox"/> Yes <input type="checkbox"/> No	→	<input type="checkbox"/> Yes <input type="checkbox"/> No	→		
Safety Improvements	AE	<input type="checkbox"/> Yes <input type="checkbox"/> No	→	<input type="checkbox"/> Yes <input type="checkbox"/> No	→	<input type="checkbox"/> Yes <input type="checkbox"/> No	→		
Shared Bike/Ped. Facilities	1	<input type="checkbox"/> Yes <input type="checkbox"/> No	→	<input type="checkbox"/> Yes <input type="checkbox"/> No	→	<input type="checkbox"/> Yes	→		N/A
Bridges									
Lane Width	A	<input type="checkbox"/> Yes <input type="checkbox"/> No	→	<input type="checkbox"/> Yes <input type="checkbox"/> No	→	<input type="checkbox"/> Yes	→		N/A
Shoulder Width	A	<input type="checkbox"/> Yes <input type="checkbox"/> No	→	<input type="checkbox"/> Yes <input type="checkbox"/> No	→	<input type="checkbox"/> Yes	→		N/A
Vertical Clearance	D	<input type="checkbox"/> Yes <input type="checkbox"/> No	→	<input type="checkbox"/> Yes <input type="checkbox"/> No	→	<input type="checkbox"/> Yes	→		N/A
Structural Capacity	D	<input type="checkbox"/> Yes <input type="checkbox"/> No	→	<input type="checkbox"/> Yes <input type="checkbox"/> No	→	<input type="checkbox"/> Yes	→		N/A
Bridge Rail	D	<input type="checkbox"/> Yes <input type="checkbox"/> No	→	<input type="checkbox"/> Yes <input type="checkbox"/> No	→	<input type="checkbox"/> Yes	→		N/A
Design Levels* <input type="checkbox"/> Blank Cell D Design Level D A Design Level A AE Agency Evaluate to Design Level A					(1) When provided, must meet current standards. (2) Items 1 and 2 under Safety Improvements Definitions are required and all others are AE.				

Local Agency Guidelines Design Matrix Reconstruction Checklist
 Page 1 of 1

Design Element	Design Level	Meets AASHTO? If "Yes" move down to next Design Element	If "NO"	Is a Deviation or Design Exception Required? If "NO" Document to File	If "Yes"	HQ Local Programs Deviation Approval Date	Local Agency Design Exception Approval Date
Roadways							
Horizontal Alignment	D	<input type="checkbox"/> Yes <input type="checkbox"/> No	→	<input type="checkbox"/> Yes	→		N/A
Vertical Alignment	D	<input type="checkbox"/> Yes <input type="checkbox"/> No	→	<input type="checkbox"/> Yes	→		N/A
Lane Width	D	<input type="checkbox"/> Yes <input type="checkbox"/> No	→	<input type="checkbox"/> Yes	→		N/A
Shoulder Width	D	<input type="checkbox"/> Yes <input type="checkbox"/> No	→	<input type="checkbox"/> Yes	→		N/A
Lane & Shoulder Taper	D	<input type="checkbox"/> Yes <input type="checkbox"/> No	→	<input type="checkbox"/> Yes	→		N/A
Ped. Facilities	1	<input type="checkbox"/> Yes <input type="checkbox"/> No	→	<input type="checkbox"/> Yes	→		N/A
Cross Slope Lane	D	<input type="checkbox"/> Yes <input type="checkbox"/> No	→	<input type="checkbox"/> Yes	→		N/A
Cross Slope Shoulder	D	<input type="checkbox"/> Yes <input type="checkbox"/> No	→	<input type="checkbox"/> Yes	→		N/A
Fill/Ditch Slopes	D	<input type="checkbox"/> Yes <input type="checkbox"/> No	→	<input type="checkbox"/> Yes	→		N/A
Safety Improvements	A	<input type="checkbox"/> Yes <input type="checkbox"/> No	→	<input type="checkbox"/> Yes	→		N/A
Shared Bike/Ped. Facilities	1	<input type="checkbox"/> Yes <input type="checkbox"/> No	→	<input type="checkbox"/> Yes	→		N/A
Turn Radii	A	<input type="checkbox"/> Yes <input type="checkbox"/> No	→	<input type="checkbox"/> Yes	→		N/A
Sight Distance	D	<input type="checkbox"/> Yes <input type="checkbox"/> No	→	<input type="checkbox"/> Yes	→		N/A
I/S Angle	A	<input type="checkbox"/> Yes <input type="checkbox"/> No	→	<input type="checkbox"/> Yes	→		N/A
Std Run	A	<input type="checkbox"/> Yes <input type="checkbox"/> No	→	<input type="checkbox"/> Yes	→		N/A
Cross Roads							
Horizontal Alignment	AE	<input type="checkbox"/> Yes <input type="checkbox"/> No	→	<input type="checkbox"/> Yes <input type="checkbox"/> No	→		
Vertical Alignment	AE	<input type="checkbox"/> Yes <input type="checkbox"/> No	→	<input type="checkbox"/> Yes <input type="checkbox"/> No	→		
Lane Width	AE	<input type="checkbox"/> Yes <input type="checkbox"/> No	→	<input type="checkbox"/> Yes <input type="checkbox"/> No	→		
Shoulder Width	AE	<input type="checkbox"/> Yes <input type="checkbox"/> No	→	<input type="checkbox"/> Yes <input type="checkbox"/> No	→		
Fill/Ditch Slopes	AE	<input type="checkbox"/> Yes <input type="checkbox"/> No	→	<input type="checkbox"/> Yes <input type="checkbox"/> No	→		
Safety Improvements	AE	<input type="checkbox"/> Yes <input type="checkbox"/> No	→	<input type="checkbox"/> Yes <input type="checkbox"/> No	→		
Shared Bike/Ped. Facilities	1	<input type="checkbox"/> Yes <input type="checkbox"/> No	→	<input type="checkbox"/> Yes	→		N/A
Bridges							
Lane Width	D	<input type="checkbox"/> Yes <input type="checkbox"/> No	→	<input type="checkbox"/> Yes	→		N/A
Shoulder Width	D	<input type="checkbox"/> Yes <input type="checkbox"/> No	→	<input type="checkbox"/> Yes	→		N/A
Vertical Clearance	D	<input type="checkbox"/> Yes <input type="checkbox"/> No	→	<input type="checkbox"/> Yes	→		N/A
Structural Capacity	D	<input type="checkbox"/> Yes <input type="checkbox"/> No	→	<input type="checkbox"/> Yes	→		N/A
Bridge Rail	D	<input type="checkbox"/> Yes <input type="checkbox"/> No	→	<input type="checkbox"/> Yes	→		N/A

Design Levels*

Blank Cell

D Design Level D

A Design Level A

AE Agency Evaluate to Design Level A

See Matrix Definitions for requirements.

(1) When provided, must meet current standards.

(2) Items 1 and 2 under Safety Improvements Definitions are required and all others are AE.

Local Agency Guidelines Design Matrix New Construction Project Checklist

Page 1 of 1

Chapter 43 *Design Approval*

43.1 **General Discussion**

On all Federal Highway Administration (FHWA) funded transportation projects, local agencies must document design approval prior to preparation of plans, specifications, and estimates (PS&E).

A project design shall not be approved until the project's environmental documentation (NEPA) has been approved and its public hearing requirements have been met.

Value Engineering Studies (VEs) are required for all projects on the NHS receiving \$50 million or more and for all bridges on the NHS receiving \$40 million or more. Any project that approaches this cost limit on the preliminary estimate should also have a VE study performed in anticipation of cost increases from preliminary design to the final Plans, Specification and Estimate stage of a project. Refer to [Section 43.4](#) for more information on Value Engineering. A VE study is not required for a Design-Build project.

When there is a subsequent change to the project design or scope, an amended location-design approval is required.

43.2 **Requirements for Design Approval**

All items on the appropriate design matrix are required to be addressed (see [Chapter 42](#), Table 1.1, 1.2, and 1.3 and [Appendix 42.101](#) and [43.62](#). In addition, items listed below are also required to be addressed (some of these are included in the Project Prospectus).

.21 Traffic Data – Design-year ADT, the average daily traffic forecast during the design year should be included. The design year for new and reconstruction projects is 20 years from the projected start of construction. All other projects may be any point within 8 to 20 years from the projected start of construction.

.22 Pavement Design Criteria – Rationale for selection of the pavement type and depth of surfacing.

.23 Cost Estimate – An updated cost estimate should be prepared. Include VE study when applicable.

.24 Environmental Document (NEPA) – Documentation, including approval.

The project design must be approved by the approving authority as outlined on the agency's Certification Acceptance Agreement or the acting designated authority for a Non-Certification Acceptance agency. For an example, see [Appendix 43.62](#).

.25 Right of Way – Local agencies must ensure that the R/W plans were reviewed and approved and that they are consistent with the PS&E.

43.3 Bridge Design Approval

.31 Policy

1. The bridge site data should be prepared in conjunction with the Design. Extensive structural studies and the preparation of the bridge preliminary plans during the Design Report phase are not recommended. Expected changes to the roadway geometrics, project staging, construction costs, and other conceptual data will affect the structure and, therefore, impact the structural design effort.
2. Agencies that perform a Type, Size, and Location (TS&L) for bridge projects, as the first order of work after being selected, must receive approval from Local Programs. (The FHWA regulatory requirements for large or unusual bridges contained in the Federal Aid Policy Guide (FAPG) also apply to large or unusual structures, tunnels, or hydraulic facilities. The definitions and requirements for major or unusual bridges will be addressed below; for other cases, refer to the FAPG.)
3. For bridge projects on, over, or under state routes WSDOT concurrence with the design of the bridge is required.

.32 Definitions – A “major bridge” is a bridge estimated to cost more than \$40 million. This criterion applies to individual units of separated dual bridges. An “unusual bridge” is a bridge involving difficult or unusual foundation problems, new or complex designs with unusual structures or operational features, or a bridge for which the design standards or criteria might be questionable.

.33 Submittal of Data – Refer to [Section 34.5](#).

Local Programs approval of TS&L is required for major or unusual bridges before the local agency may approve the design and before the local agency may begin preparing the final PS&E.

43.4 Value Engineering

Value Engineering Studies (VEs) are required for all NHS projects \$50 million or more and for all bridges on NHS routes \$40 million or more. Any project that approaches this cost limit on the preliminary estimate should also have a VE study performed in anticipation of cost increases from preliminary design to the final Plans, Specifications and Estimate stage of a project.

.41 Definition – Value Engineering (VE) is the systematic application of recognized techniques by multidiscipline team(s). These techniques are:

- Identify a product’s function or service.
- Establish a function’s monetary value or worth.
- Provide alternate ways, using creative techniques, to reliably accomplish necessary functions in the most effective and efficient manner.

Reducing the scope of a project, compromising the performance of an element, or simply substituting cheaper materials is not VE. VE is not just “good engineering.” It simply answers the question, “What else will accomplish the purpose of the product, service, or process we are studying?” All costs are taken into account over the entire life of the project.

.42 Why VE is Needed – The costs of highway needs far exceed the funds available for improvements. As the cost of highway construction increases, more emphasis is being placed on the maintenance and rehabilitation of existing facilities to maximize these available funds.

VE is a tool that can counteract these growing problems by providing (1) cost reduction, (2) product or process improvement, and (3) alternative means and materials for highway construction and maintenance.

.43 VE Application (General) – VE may be applied at any point in highway development, operation, and maintenance. For maximum effectiveness, however, VE should be undertaken as early as possible (during the first 30 percent of design) when decisions on life-cycle costs are being made and valid project development recommendations can be implemented. When a complex, costly project is selected as a candidate for potential cost reductions, investigations should start as soon as a preliminary estimate is in hand.

VE should be employed when the ratio of potential savings to the cost of the VE study is significant. VE can also be used in evaluating standard details that are used repetitively on many projects. The cost of VE studies in preconstruction activities may be allocated to the preliminary engineering cost of the related project.

Local agencies are also encouraged to include a VE incentive clause in their construction specifications; such clauses encourage contractors to propose changes to the contract that fulfill a project's functional requirements at less cost.

When VE is not mandatory and the local agency staff is considering a VE, it is recommended that the local agency staff prepare a "VE Assessment Report" ([Appendix 43.61](#)). The report will address the project characteristics, cost per mile, potential savings of high cost items, and other considerations unique to the project. From this assessment, a recommendation can be developed as to whether a VE study is needed. Use the references listed in Section 43.45 when a mandatory VE study is performed.

.44 VE Study Team – The VE Study Team will be headed by a qualified facilitator. The duties and responsibilities of the facilitator will include, but are not limited to, the following:

1. Acts as chairperson at meetings of the VE Team.
2. Presents the findings and recommendations of the VE study to the local agency management and other interested agencies.
3. Provides the final VE Study Report to the local agency and WSDOT Local Programs.

The VE Team will be comprised of a minimum of five members including the facilitator. One team member should have a background in bridge design (if a bridge is part of the project) or construction. If environmental factors are part of the study process, then the team should also include a member who has expertise on environmental issues.

The VE Team will formally present their study results to local agency representatives, WSDOT Local Programs, and all other interested persons. Team findings and recommendations will then be documented in a formal report and should be provided to all interested parties soon as possible. Courtesy copies are sent to other appropriate agencies and individuals.

The local agency will evaluate the VE Team recommendations. Should their preferred alternative differ from the prospectus or if no project prospectus has been approved, the local agency submits a new or revised prospectus for their preferred alternative to the Region Local Programs Engineer. A summary of the VE study results shall be included in this transmittal as reference material. The project then proceeds as defined in this manual.

.45 Reference Materials

- *Value Engineering Guide for Cities and Counties*, Kempter-Rossmann International.
- *Operating Tip – Value Engineering*, NWT2 Center, October 1985.
- *Value Engineering Contract Provisions on Federal Aid Highway Construction Projects*, Report No. 7584217, FHWA, December 1984.
- *Pavement and Shoulder Maintenance Performance Guide*, Report No. TS-84-208, FHWA, August 1984 (Developed in conjunction with Arkansas, Colorado, Iowa, New Mexico, North Dakota, South Dakota, Utah, and Washington).
- *Value Engineering for Highways*, prepared for FHWA by Kempler-Rossmann International, revised October 1983.
- *Value Engineering Conference Summary Report*, Report No. TS-80-246, FHWA, August 7, 1980.
- *Value Engineering – A Systematic Approach*, Arthur E. Mudge, McGraw-Hill, New York, 1971.
- *Value Engineering in the Construction Industry*, Alphonse J. Dell'isola, Construction Publishing Co., Inc., New York, 1974.
- *Guidelines for Value Engineering (VE)*, subcommittee on New Highway Materials, AASHTO-AGC-ARTBA Joint Cooperative Committee. Reprinted by USDOT/FHWA February 1983.
- WSDOT [Design Manual](#) M 22-01 Value Engineering (VE) section.

43.5 Additional Data Required for Special Projects

.51 Traffic Signal Projects – The local agency shall provide warrants for signalization in accordance with Part 4c of the Manual on Uniform Traffic Control Devices (MUTCD). Designs for signalization at intersections with state routes require review by WSDOT. A signal permit is required for all traffic signals on state routes. An early application to the WSDOT Region Administrator is advisable.

.52 Projects Involving State Routes – Designs for all projects involving state routes shall be submitted to WSDOT for approval. All work at intersections with state routes requires submittal of an intersection plan to WSDOT for approval. Prints of existing intersection plans are available from WSDOT. Revisions should be shown on these prints.

43.6 Appendices

- [43.61](#) VE Assessment Report
- [43.62](#) Example of Design Approval Documentation

Appendix 43.61 VE Assessment Report



VE Assessment Report

Agency: [Click here to enter text.](#)

Date: [Click here to enter text.](#)

Project Title: [Click here to enter text.](#)

Project Number: [Click here to enter text.](#)

Reviewing Team: [Click here to enter text.](#)

Project Characteristics

Length: [Click here to enter text.](#) Cost: [Click here to enter text.](#) Cost/Unit Length: [Click here to enter text.](#)

Major structure Yes No

Extensive R/W Yes No

Complex project Yes No

Includes Items that appear too costly Yes No

Includes Critical or Expensive Materials Yes No

Includes items that have questionable, complex, or costly function Yes No

Includes items difficult to construct Yes No

Complicated or costly traffic control or detours Yes No

Horizontal Alignment: [Click here to enter text.](#)

Vertical Alignment: [Click here to enter text.](#)

Materials Source: [Click here to enter text.](#)

Design Concept: [Click here to enter text.](#)

Other Considerations: [Click here to enter text.](#)

Other Alternatives Considered: [Click here to enter text.](#)

Major High Cost Items and Potential Cost Saving Ideas	Cost	Potential Savings
1. Click here to enter text.	\$	\$
2. Click here to enter text.	\$	\$
3. Click here to enter text.	\$	\$

Conclusions and Recommendations: [Click here to enter text.](#)

Approving Authority Recommendations: [Click here to enter text.](#)

Appendix 43.62 Example of Design Approval Documentation

Design Approval Documentation

[Agency Name]

[Project Title]

All items on the appropriate design matrix have been followed. Items that have been reviewed and addressed include:

- Traffic Data
- Pavement Design Criteria
- NEPA
- Right of Way (check applicable situation)
 - No ROW Needed - PS&E is consistent with no ROW determination
 - ROW Needed – PS&E consistent with ROW Plan

A Cost Estimate has also been prepared.

The [title of the approving authority as outlined on the agency's Certification Acceptance Agreement] has reviewed and approved the Design Documentation.

Name
Title
Agency

Date

Chapter 44 *Plans, Specifications, and Estimates*

44.1 **General Discussion**

After a project's location and design have been approved, work begins on the final version of the plans, specifications, and cost estimates (PS&E). These documents are used to award and administer a construction contract. The PS&E must be approved as defined in [Chapter 13](#), *Becoming Certified to Administer FHWA Projects*, before the project can be advertised for construction.

PS&E approval is done by the local agency as identified in the Washington State Department of Transportation (WSDOT)/Local Agency Certification Acceptance (CA) Agreement. The approving authority identified on the CA Agreement must approve the plans and specifications and document that approval, and a professional engineer licensed in the state of Washington must seal and date the plans and specifications.

The local agency should use the Project Development Checklist ([Appendix 14.52](#)) to check for completeness of the contract plans prior to approving them.

The local agency must maintain a commitment file, when applicable. This must contain a summary of all commitments made during the development of the project. The file should be reviewed to ensure that the commitments that apply to the contractor are incorporated in the PS&E. This file must also include commitments the local agency is responsible for completing, such as annual reporting to resource agencies. It is the local agency's responsibility to ensure this file is updated to show when these commitments were completed. Commitments typically involve right of way, maintenance and/or environmental considerations.

A copy of the preliminary PS&E must be submitted to the Region Local Programs Office for concurrence prior to Advertisement. An Ad-ready copy shall also be furnished to the Region Local Programs Engineer prior to advertisement. If the local agency would like WSDOT to prepare the Record of Materials (ROM), an additional copy is also needed.

In addition, any local agency project with work on, over or below state routes or within limited access for the interstate system requires design and traffic documentation approval and PS&E concurrence from WSDOT prior to advertisement. A WSDOT general permit may also be required prior to Ad. The Region Local Programs Engineer can assist in coordinating these approvals.

On WSDOT ad-and-award projects, WSDOT will review and concur with the PS&E prior to printing contract plans and specifications. An estimate of the cost of this service can be obtained from the Region Local Programs Engineer. Refer to forms for a checklist.

44.2 PS&E Requirements

.21 Wage Rates – For information on state law requirements, contact the Municipal Research and Services Center for a listing of current laws. State and federal wage rates must be included for all Federal Highway Administration (FHWA) projects advertised by a local agency. The wage rates used will reflect the latest rates approved by the Washington State Department of Labor and Industries (L&I) and the U.S. Department of Labor. Refer to [CFR 29 part 30](#) and [RCW 39.12](#) and [RCW 49.28](#).

The Federal Davis-Bacon Act predetermined minimum wage must be paid to all covered workers on federal aid projects exceeding \$2,000 that are located on a route which is classified as a federal aid highway (Principal Arterial, Minor Arterial or Collector). The Davis-Bacon requirements do not apply to force account work performed by agency forces.

The applicability of Davis-Bacon is dependent on the relationship or linkage of the project to a federal aid highway. If the project is “linked” to a federal aid highway based on proximity or impact (i.e., without the federal aid highway the project would not exist), then Davis-Bacon requirements apply. Examples of such projects include the removal of outdoor advertising, a wetland to filter highway drainage, etc. Please contact your Region Local Programs Engineer to determine if Davis Bacon prevailing wage rates apply.

If the project is on a route classified as a rural minor collector or local access then the Davis-Bacon requirements do not apply.

Another Davis-Bacon issue is the acceptability of using volunteer labor on transportation projects. The US Department of Labor states in its Field Operations Handbook (Section 15): “There are no exceptions to Davis-Bacon coverage for volunteer labor unless an exception is specifically provided for in the particular Davis-Bacon Related Act under which the project funds are derived.” The Davis-Bacon Related Act for the Federal Aid Highway Program

(23 U.S.C. Section 113) is silent on this subject. Therefore, on projects subject to Davis-Bacon coverage, a contractor or subcontractor may not use volunteer labor. On the other hand, a state highway or local government agency may use volunteer labor under its direct control as a force account effort.

Local agencies may access the Wage Rate data file at www.wsdot.wa.gov/eesc/design/projectdev/adready/combinedwage.htm. If a local agency is not “on line,” wage rates can be requested through the Region Local Programs Engineer.

The effective date for state and federal rates is determined as follows:

- a. **State Wage Rates** – L&I will use the date that bids are due as the effective date for determining prevailing wages provided that the contract is awarded within 60 days after bids are due ([RCW 39.12](#)). If the contract is not awarded within 60 days after bids are due, L&I will determine the prevailing wage on the date the contract is awarded.

- b. **Federal Wage Rates** – This data is received from the USDOL in a document entitled “General Wage Determinations Issued Under the Davis-Bacon and Related Acts.” Modifications are issued weekly by the USDOL. The effective date for federal wage rates is the date of notice in the Federal Register or the date on which written notice is received by WSDOT, whichever occurs first. All modifications on projects to which the determination applies are effective if published before contract award.

The following are exceptions:

- The effective date for determining state prevailing wage rates shall be the date of bid opening. For contracts awarded more than six months after the bid opening date, the effective date for determining the wage rates shall be the award date.
- The effective date for determining federal prevailing wage rates shall be ten days prior to bid opening (or less if the engineer determines an addenda can be issued prior to bid opening). For contracts awarded more than 90 days after the bid opening date, the effective date for determining the wage rates shall be the award date.

Prior to bid opening, the local agency may contact the Region Local Programs Engineer to see if wage rates have changed or are pending.

To minimize the possibility of out-of-date state and federal wage rates at the time of bid opening, the wage rates should be requested from the Region Local Programs Engineer seven days before the advertising date.

.22 Other Requirements

- a. **Form FHWA-1273** – Each set of contract documents shall include Form FHWA-1273, Required Contract Provisions Federal-Aid Construction Contracts. Copies of FHWA-1273 are available from the Region Local Programs Engineer.
- b. **Affirmative Action** – See [Chapter 27](#), Equal Employment Opportunity and Training.
- c. **Disadvantaged Business Enterprises (DBE)** – In accordance with FHWA and WSDOT efforts to increase DBE participation in FHWA projects, WSDOT has developed a management-by-objective goal-setting process for DBE participation. For additional information, see [Chapter 26](#), Disadvantaged Business Enterprises.
- d. **“Buy-America” Requirements** – Steel and iron that is permanently incorporated into the project shall consist of American-made materials, as outlined in the required GSP.

The local agency must include a provision containing the “Buy-America” requirements in each contract. These general special provisions are included in the WSDOT Amendments and General Special Provisions publication.

Purchase of foreign steel and iron products by local agencies for installation on a federally funded project is not allowed without an approved public interest finding from Local Programs, to the limit allowed by the “Buy America” General Special Provision.

- e. **Traffic Control Plans** – Traffic Control Plans (TCP) must be included in the contract documents. TCPs shall be consistent with Part 6 of the MUTCD, low volume roads, Part 5. Detour Plans and agreements shall be included in the contract documents to demonstrate constructability. **K Plans used as a reference are NO LONGER ALLOWED. Agencies must develop contract specific traffic control plans for each contract.**

Construction projects that impact bicycle and/or pedestrian traffic must include accommodation for all impacted modes of travel in the contract Traffic Control Plans. Ensure these accommodations are in compliance with ADA standards.

- f. **A “TIED BID”** is a federal project and a non-federal project or two federal projects (otherwise separate contracts) that are advertised and bid together as a single contract. To bid the projects under a single contract, approval is required by Local Programs prior to being advertised.
- g. **Sole Source Justification** – Justification for the use of agency-supplied materials must be documented by the local agency. The materials must have been produced by agency forces or acquired through competitive bidding. Material purchased from a sole source may be used only when preapproved by Local Programs. To receive approval, submit a Public Interest Finding (PIF) for approval prior to use.
- h. **Warranty/Guarantee** – No warranty requirement shall be approved which may place an undue obligation on the contractor for items or conditions over which the contractor has no control. Warranties/guarantees shall not be included in federal aid projects or the bonds except as follows:

On NHS construction contracts a warranty can be included in the contract in accordance with the following: Warranty provisions shall be for a specific product or feature. Warranties for items of maintenance are not eligible for federal participation and will not be allowed. All warranty requirements and subsequent revisions shall be submitted to the WSDOT Region Local Programs Engineer and forwarded to Local Programs for advance approval.

On non-NHS construction contracts a warranty can be included in the contract in accordance with the following: Project warranty/maintenance provisions may be included in a project if a nonparticipating bid item and special provision is included in the contract. All other warranty requirements other than product or feature, and subsequent revisions, shall be submitted to Region Local Programs Engineer for advance approval.

- .23 **Local Ad and Award Projects** – See [Chapter 46](#).
- .24 **State Ad and Award Projects** – See [Chapter 45](#).

44.3 Documents Requiring Professional Stamps

The following documents require a PE stamp upon completion. The Professional Engineer with responsible charge of the project will assure that appropriate engineering reports and documents are stamped in accordance with [RCW 18.43.070](#). If a particular “Engineering Report or Document” is not listed, it is not necessarily exempt from the requirement.

The list includes:

- Design Documents
- Right of Way Plans
- Type, Size, and Location Report
- Plans, Specifications (with appropriate Division 1 approvals as outlined in [Section 44.5](#)), and Estimates, including all plan sheets.
- Special Provisions
- Temporary Erosion and Sediment Control Plan
- Plans for Falsework and Forms, normally the contractor’s responsibility
- Bridge Design Report
- Bridge Load Ratings
- As Built Plans
- Technical Change Orders
- Value Engineering Study Report
- Standards Deviation Request
- Emergency Contracts that contain the equivalent of PS&E documents

44.4 Contract Plans

For WSDOT ad-and-award projects, the plans should be prepared in accordance with the [Plans Preparation Manual](#) M 22-31. For local ad-and-award projects, there are no federal or state requirements for plan sheet size or guidelines for preparing contract plans.

44.5 Specifications

WSDOT publishes and distributes the Standard Specifications, and the Amendments and General Special Provisions. On federal aid projects, any revision to Division 1 of the Standard Specifications or approved Division 1 revision (Amendment or WSDOT or APWA General Special Provision) requires prior approval from Local Programs. In all cases, naming conventions will clearly identify the origin, General Special Provision, APWA Special Provision, Agency Provision, or Project Provisions.

.51 Standard Specifications – All FHWA funded projects, including local agency force projects, will be constructed in conformance with the current [Standard Specifications for Road, Bridge, and Municipal Construction](#) M 41-10, and such approved amendments that modify these specifications.

.52 Amendment to the Standard Specifications – These amendments are approved changes to the Standard Specifications.

.53 General Special Provisions – These are specifications that describe special project features in common usage.

.54 APWA General Special Provisions – These are specifications unique to local agency projects. See www.wsdot.gov/partners/apwa.

.55 Special Provisions – Since Special Provisions are specifications governing matters peculiar to an individual project, they are not covered in the *Standard Specifications*. Their use should be held to a minimum and applicable *Standard Specifications* should be used instead. Issues mandated in the state and federal laws shall not be changed.

Special Provisions are required:

- a. For the presentation of all features of a project not covered by the *Standard Specifications* and General Special Provisions.
- b. Where the *Standard Specifications* are being amended.
- c. For any deviation from the *Standard Specifications* with regard to materials, construction details, measurement, and payment.
- d. When noted in the WSDOT Standard Item Table.

The following paragraphs discuss some pertinent aspects of special provisions.

- All nonstandard pay items shall be covered in the Special Provisions.
- The local agency is encouraged to include a value engineering incentive clause in their construction specifications encouraging the contractor to propose changes in contract requirements that will accomplish the project's functional requirements at less cost on high cost and major projects.
- Traffic control must be in accordance with the MUTCD. A Special Provision shall be prepared outlining traffic control requirements and including any pay items.
- Neatline measurement of quantities is allowed by special provision. This specification may allow payment of the neatline measurement from the lines and grades as shown on the plans or as directed by the Engineer's stakes on the ground. This may apply to aggregates, base course, and surfacing. On asphalt quantities, the unit price could include the cost of coring to verify density and depths. Culvert and pipeline installation may be paid by the lineal foot-in place with bedding, backfill, and compaction as incidental to the unit price. In these instances, an item should be added for extra excavation or backfill if the profile varies or is subject to change during the contract. Shoring must be paid as a separate bid item.
- Direct reference to proprietary specifications of national, regional, or local trade associations should not be included in FHWA contract specifications; such proprietary specifications are subject to change without notice to, or acceptance by, the state or FHWA. If proprietary specifications must be used, the complete text, or such parts as are applicable, should be incorporated into special provisions for the project.

Proprietary Items – Sole Source

The use of trade names in specifications and on plans should be avoided. Instead, specifications should be formulated to assure full opportunity for competition among equivalent materials, equipment, and methods. Specifying patented or proprietary material, products or processes is allowed for federal aid projects only under one of the following conditions:

Specify at Least Three Brand Names

- At least three names of acceptable materials or products, if available, are listed together with a list of the required features and specifications that will be considered equal to the listed items.

Approved Public Interest Finding

- The agency is requiring a specific material or product and a written Public Interest Finding (PIF) document has been prepared and approved by Local Programs.

Approved Experimental Feature

- The material or product has been approved through FHWA as an experimental feature.

Specify Brand Names and Allow for Approved Equals

- Specify a brand name. The agency will provide the bidder with options by naming at least two additional products or manufacturers that are acceptable and allowing for “approved equals” followed by a performance specification. When this is done, no approval is required for usage; it is not considered a proprietary item.

A good specification for brand name specifying will read as follows:

The (type of product) furnished shall be (brand name, model), (brand name, model), or an approved equal having the following features (functions):

- a. (feature)
- b. (functions)
- c. (feature)

In order to find the two acceptable items, the agency has to be looking for certain features or functions. These features or functions need to be clearly identified in the Special Provision.

Public Interest Finding

An agency may require a specific material or product when there are other acceptable materials and products when such specific choice is approved as being in the public interest, such as traffic signal control equipment. The written (PIF) must:

Clearly show that the best interest of the public and the agency will be achieved. This is accomplished by describing any cost effectiveness and efficiency to be realized.

A benefit cost analysis should be completed to support the PIF. The supporting documentation and the decision of the agency must be maintained in the project file. See [Appendices 44.76](#) through [44.83](#) for detailed instructions and example.

Proprietary items must be approved by Local Programs.

A PIF is not required when:

A utility agreement is being established and the utility company supplies the material at no cost. This includes minor quantities of materials and supplies and proprietary products that are routinely used in a utility's operation, which are essential for the maintenance of the system. The material must still comply with the Buy America requirements.

44.6 Estimates

The engineer's estimate of a proposed project's cost shall include the estimated quantity and estimated unit price for each proposed work item. Bridge items shall be segregated from roadway items. A tabulation for each bridge showing its applicable items shall be submitted.

If materials salvaged from the project are to be used for roadway purposes, the value of such materials should not be included in the project cost.

The estimate shall separately list the costs of nonparticipating items, local agency force work, and local agency furnished materials.

The separate cost groups shall be summarized and totaled on the first sheet of the estimate.

The Region Local Programs Engineer may be contacted for assistance in preparing the estimate. An estimate example is shown in [Appendix 44.74](#).

44.7 Appendices

- [44.71](#) Local Agency Bid Proposal Package
- [44.72](#) City Letter of Financial Responsibility – Example
- [44.73](#) County Letter of Financial Responsibility – Example
- [44.74](#) Estimate and Grouping – Example
- [44.75](#) Local Agency Plans Preparation Checklist
- [44.76](#) Patented/Proprietary Items – PIF Instructions
- [44.77](#) Two-Week Advertisement – PIF Instructions
- [44.78](#) Mandatory Use of Borrow or Disposal Site – PIF Instructions
- [44.79](#) Agency Supplied Equipment – PIF Instructions
- [44.80](#) Agency Supplied Material – PIF Instructions
- [44.81](#) Local Agency Force Work – PIF Instructions
- [44.82](#) Tied Bids – PIF Instructions
- [44.83](#) Public Interest Finding – Example

44.8 Forms

FHWA-1273 Required Contract Provisions Federal-Aid Construction Contracts

Appendix 44.71 Local Agency Bid Proposal Package

Local Agency Bid Proposal Package – Data Entry

Local Agency Bid Proposal Package

Local Agency Proposal Package Data Entry

Local Agency Proposal Certification for Federal-Aid Contracts (DOT Form 272-040A)

Local Agency Proposal Bond (DOT Form 272-001A)

Local Agency Non-Collusion Declaration (DOT Form 272-036I)

Local Agency Disadvantaged Business Enterprise Utilization Certification (DOT Form 272-056)

Disadvantaged Business Enterprise Documentation Reminder

Local Agency Disadvantaged Business Enterprise (DBE) Written Confirmation Document (DOT Form 422-031)

Local Agency Ad and Award Contract Proposal - Signature Page (DOT Form 272-036J)

Local Agency Proposal - Signature Page (DOT Form 272-036K)

Local Agency Subcontractor's List (DOT Form 271-015A)

(This form (DOT 271-015A EF) must be included in the bid proposal package, if the bid on a prime contract is expected (per the Engineer's Estimate) to cost one million dollars or more.)

Local Agency Performance Bond (DOT Form 272-002A)

Local Agency Payment Bond (DOT Form 272-003A)

Local Agency Contract - Highway Construction (DOT Form 272-006A)

Local Agency Contract - Building Construction (DOT Form 272-008A)

Local Agency Contractor Prequal. Questionnaire and Affid. for Region Ad and Award Contracts (\$100,000 or Less) (DOT Form 272-063A)

[List View](#)

[Close](#)

1. Local Agencies must use DOT Form 272-056 and 422-031 on all projects that have an established DBE goal.
2. Local Agencies may delete DOT Form 272-063A.

Note: This package is available electronically at www.wsdot.wa.gov/forms. Follow the instructions to download the package. The Local Agency Bid Proposal Package is located behind the “agreement and Contract Forms” button.

Local Agency Bid Proposal Package - Data Entry

Enter the Appropriate Information for the Local Agency Proposal Package

Local Agency:

Local Agency Address:

City **State** **Zip Code**

Is this Bid Package for a Federal or State project?
 Federal State

Enter the Road or Bridge Name

Enter the Mileposts (include "MP") or Project Limits

Enter the Project Title

Enter Agency Job Number(s)

Enter the Federal Aid Number(s) and TA Number

Local Agency Bid Proposal Package - Data Entry

Enter the Federal Aid Number(s) and TA Number

Bid Open Time (24 hour clock)

Enter the Agency street address for the Bid Opening

Enter the Bid opening Location. Include the room number if applicable

City Zip Code

Enter the Agency mailing Post Office Bix or Street Address for mail in Bids

Address

City Zip Code

Enter the Fax Number for Bid Changes

Expedite / Bidx.com Option

This field shows the Bid Opening information that will print on the Cover Page exactly as displayed. Please verify and correct any incorrect information

"Sealed bids will be received by at , , Washington, until , or at " ,

Local Agency Bid Proposal Package – Data Entry
(Page 2 of 3)

Local Agency Bid Proposal Package - Data Entry

"Sealed bids will be received by at , , , Washington , until , or at " , , Washington until :00 AM on the date scheduled for opening bids.

Click on forms to include in this Bid Package	Enter Correct Page Letter
<input type="checkbox"/> Certification for Federal Aid Contracts (272-040A) Required for all Federal Aid jobs over \$100,000	_____
<input type="checkbox"/> Proposal Bond (272-001A) Use when bid bond is required	_____
<input type="checkbox"/> Non-Collusion Declaration (272-036I) Required for all Federal Aid jobs	_____
<input type="checkbox"/> DBE Documentation Reminder Page Required for Federal Aid jobs with DBE Condition of Award goals	_____
<input type="checkbox"/> DBE Utilization Certification (272-056) Required for Federal Aid jobs with DBE Condition of Award goals	_____
<input type="checkbox"/> DBE Written Confirmation Document (422-031) Required for Federal Aid jobs with DBE Condition of Award goals	_____
<input type="checkbox"/> Subcontractor's List (271-015A EF) Required for all jobs over \$1,000,000	_____
<input type="checkbox"/> Region Ad and Award Contract Proposal - Signature Page (272-036J) Used only for contracts \$50,000 or less when no bond is required	_____
<input type="checkbox"/> Proposal - Signature Page (272-036K) Required for all jobs over \$1,000,000	_____

Local Agency Certification for Federal-Aid Contracts

The prospective participant certifies by signing and submitting this bid or proposal, to the best of his or her knowledge and belief, that:

(1) No Federal appropriated funds have been paid or will be paid, by or on behalf of the undersigned, to any person for influencing or attempting to influence an officer or employee of any Federal agency, a Member of Congress, an officer or employee of Congress, or an employee of a Member of Congress in connection with the awarding of any Federal contract, the making of any Federal grant, the making of any Federal loan, the entering into of any cooperative agreement, and the extension, continuation, renewal, amendment, or modification of any Federal contract, grant, loan or cooperative agreement.

(2) If any funds other than Federal appropriated funds have been paid or will be paid to any person for influencing or attempting to influence an officer or employee of any Federal agency, a Member of Congress, an officer or employee of Congress, or an employee of a Member of Congress in connection with this Federal contract, grant, loan, or cooperative agreement, the undersigned shall complete and submit Standard Form-LLL, "Disclosure Form to Report Lobbying," in accordance with its instructions.

This certification is material representation of the fact upon which reliance was placed when this transaction was made or entered into. Submission of this certification is a prerequisite for making or entering into this transaction imposed by Section 1352, Title 31, U.S. Code. Any person who fails to file the required certification shall be subject to a civil penalty of not less than \$10,000 and not more than \$100,000 for each failure.

The prospective participant also agrees by submitting his or her bid or proposal that he or she shall require that the language of this certification be included in all lower tier subcontracts, which exceed \$100,000 and that all such subrecipients shall certify and disclose accordingly.

SR

DOT Form 272-040A
07/2011

Local Agency Proposal Certification for Federal-Aid Contracts (DOT Form 272-040A)

Local Agency Proposal Bond

KNOW ALL MEN BY THESE PRESENTS, That we,

of _____ as principal, and the

a corporation duly organized under the laws of the state of _____, and authorized to do business in the State of Washington, as surety, are held and firmly bound unto the State of Washington in the full and penal sum of five (5) percent of the total amount of the bid proposal of said principal for the work hereinafter described, for the payment of which, well and truly to be made, we bind our heirs, executors, administrators and assigns, and successors and assigns, firmly by these presents.

The condition of this bond is such, that whereas the principal herein is herewith submitting his or its sealed proposal for the following highway construction, to wit:

said bid and proposal, by reference thereto, being made a part hereof.

NOW, THEREFORE, If the said proposal bid by said principal be accepted, and the contract be awarded to said principal, and if said principal shall duly make and enter into and execute said contract and shall furnish bond as required by the _____ within a period of twenty (20) days from and after said award, exclusive of the day of such award, then this obligation shall be null and void, otherwise it shall remain and be in full force and effect.

IN TESTIMONY WHEREOF, The principal and surety have caused these presents to be signed and sealed this _____ day of _____, _____.

(Principal)

(Surety)

(Attorney-in-fact)

SR

DOT Form 272-001A
07/2011

Local Agency Proposal Bond (DOT Form 272-001A)

Failure to return this Declaration as part of the bid proposal package will make the bid nonresponsive and ineligible for award.

NON-COLLUSION DECLARATION

I, by signing the proposal, hereby declare, under penalty of perjury under the laws of the United States that the following statements are true and correct:

- 1. That the undersigned person(s), firm, association or corporation has (have) not, either directly or indirectly, entered into any agreement, participated in any collusion, or otherwise taken any action in restraint of free competitive bidding in connection with the project for which this proposal is submitted.**
- 2. That by signing the signature page of this proposal, I am deemed to have signed and to have agreed to the provisions of this declaration.**

NOTICE TO ALL BIDDERS

To report rigging activities call:

1-800-424-9071

The U.S. Department of Transportation (USDOT) operates the above toll-free "hotline" Monday through Friday, 8:00 a.m. to 5:00 p.m., eastern time. Anyone with knowledge of possible bid rigging, bidder collusion, or other fraudulent activities should use the "hotline" to report such activities.

The "hotline" is part of USDOT's continuing effort to identify and investigate highway construction contract fraud and abuse and is operated under the direction of the USDOT Inspector General. All information will be treated confidentially and caller anonymity will be respected.

SR

DOT Form 272-036I
07/2011

**Non-Collusion Declaration
(DOT Form 272-036I)**



Washington State
Department of Transportation

**Disadvantaged Business Enterprise (DBE)
Written Confirmation Document**

See Contract Provisions: *DBE Document Submittal Requirements*
Disadvantaged Business Enterprise Participation

THIS FORM SHALL ONLY BE SUBMITTED TO A DBE THAT IS LISTED ON THE CONTRACTOR'S
DISADVANTAGED BUSINESS ENTERPRISE UTILIZATION CERTIFICATION.

THE CONTRACTOR SHALL COMPLETE PART A PRIOR TO SENDING TO THE DBE.

PART A: To be completed by the bidder

The entries below shall be consistent with what is shown on the Bidder's Disadvantaged Business Enterprise
Utilization Certification. Failure to do so will result in Bid rejection.

Contract Title: _____

Bidder's Business Name: _____

DBE's Business Name: _____

Description of DBE's Work: _____

Dollar Amount to be Applied Towards DBE Goal: _____

Dollar Amount to be Subcontracted to DBE*: _____
*Optional Field

PART B: To be completed by the Disadvantaged Business Enterprise

As an authorized representative of the Disadvantaged Business Enterprise, I confirm that we have been
contacted by the Bidder with regard to the referenced project for the purpose of performing the Work described
above. If the Bidder is awarded the Contract, we will enter into an agreement with the Bidder to participate in
the project consistent with the information provided in Part A of this form.

Name (printed): _____

Signature: _____

Title: _____

Address: _____ Date: _____

DDT Form 422-031
Revised 02/20 18

**Local Agency Disadvantaged Business Enterprise (DBE)
Written Confirmation Document (DOT Form 422-031)**

Local Agency Signature Page

The undersigned hereby agrees to pay labor not less than the prevailing rates of wages in accordance with the requirements of the special provisions for this project.

Receipt is hereby acknowledged of addendum(s) No. (s) _____, _____ & _____

Signature of Authorized Official(s)

Proposal Must be Signed

Firm Name

Address

State of Washington Contractor's License No. _____

Federal ID No. _____

Note:

- (1) This proposal form is not transferable and any alteration of the firm's name entered hereon without prior permission from the _____ will be cause for considering the proposal irregular and subsequent rejection of the bid.
- (2) Please refer to section 1-02.6 of the standard specifications, re: "Preparation of Proposal," or "Article 4" of the Instruction to Bidders for building construction jobs.
- (3) Should it be necessary to modify this proposal either in writing or by electronic means, please make reference to the following proposal number on in your communication _____.
- (4) RCW 47.28.030 (2) applies: No bid deposit or performance bond shall be required but it shall be specified in the bidding proposal that each month the contractor may be required to submit paid invoices showing that disbursements have been made to laborers, materialmen, mechanics, and subcontractors due such persons from the previous progress payment. If such disbursements have not been made, the monthly progress payment shall be withheld pending receipt of the paid invoices.

SR

DOT Form 272-036J
07/2011

**Local Agency Signature Page
(DOT Form 272-036J)**

Local Agency Proposal - Signature Page

The bidder is hereby advised that by signature of this proposal he/she is deemed to have acknowledged all requirements and signed all certificates contained herein.

A proposal guaranty in an amount of five percent (5%) of the total bid, based upon the approximate estimate of quantities at the above prices and in the form as indicated below is attached hereto:

- Cash In the Amount of _____
- Cashier's Check _____ Dollars
- Certified Check (\$ _____) Payable to the Agency
- Proposal Bond In the Amount of 5% of the Bid

Receipt is hereby acknowledged of addendum(s) No.(s) _____, _____ & _____

Signature of Authorized Official(s)

Firm Name _____

Address _____

State of Washington Contractor's License No. _____

Federal ID No. _____

Note:

- (1) This proposal form is not transferable and any alteration of the firm's name entered hereon without prior permission from the _____ will be cause for considering the proposal irregular and subsequent rejection of the bid.
- (2) Please refer to section 1-02.6 of the standard specifications, re: "Preparation of Proposal," or "Article 4" of the Instruction to Bidders for building construction jobs.

SR

DOT Form 272-036K
07/2011

Local Agency Proposal - Signature Page (DOT Form 272-036K)

Local Agency Name
Local Agency Address

Local Agency Subcontractor List

Prepared in compliance with RCW 39.30.060 as amended

To Be Submitted with the Bid Proposal

Project Name _____

Failure to list subcontractors with whom the bidder, if awarded the contract, will directly subcontract for performance of the work of heating, ventilation and air conditioning, plumbing, as described in Chapter 18.106 RCW, and electrical, as described in Chapter 19.28 RCW or naming more than one subcontractor to perform the same work will result in your bid being non-responsive and therefore void.

Subcontractor(s) with whom the bidder will directly subcontract that are proposed to perform the work of heating, ventilation and air conditioning, plumbing, as described in Chapter 18.108 RCW, and electrical as described in Chapter 19.28 RCW must be listed below. The work to be performed is to be listed below the subcontractor(s) name.

To the extent the Project includes one or more categories of work referenced in RCW 39.30.060, and no subcontractor is listed below to perform such work, the bidder certifies that the work will either (i) be performed by the bidder itself, or (ii) be performed by a lower tier subcontractor who will not contract directly with the bidder.

Subcontractor Name _____
 Work to be Performed _____

Subcontractor Name _____
 Work to be Performed _____

Subcontractor Name _____
 Work to be Performed _____

Subcontractor Name _____
 Work to be Performed _____

Subcontractor Name _____
 Work to be Performed _____

* Bidder's are notified that is the opinion of the enforcement agency that PVC or metal conduit, junction boxes, etc, are considered electrical equipment and therefore considered part of electrical work, even if the installation is for future use and no wiring or electrical current is connected during the project.

SR

DOT Form 271-015A
 Revised 08/2012

Local Agency Subcontractors List (All Contracts Over \$1,000,000) (DOT Form 271-015A)

Local Agency Contract Bond - Highway Construction

KNOW ALL MEN BY THESE PRESENTS, That

of _____, as Principal, and
as Surety, are jointly and severally held and bound unto the _____, in the penal sum of

Dollars (\$ _____), the payment of which we jointly and severally bind ourselves,
our heirs, executors, administrators, and assigns, and successors and assigns, firmly by these presents.

The CONDITION of this bond is such that WHEREAS, on the
day of _____ A.D., _____, the said

Principal, herein, executed a certain contract with the _____, by the terms, conditions, and provisions of
which contract the said

Principal, herein, agree to furnish all material and do certain work, to wit: That

will undertake and complete the construction of _____

according to the maps, plans and specifications made a part of said contract, which contract as so
executed, is herunto attached, is now referred to and by reference is incorporated herein and made a
part hereof as fully for all purposes as if here set forth at length. This bond shall cover all approved
change orders as if they were in the original contract. Similarly, the bond shall cover payment of all
taxes incurred on said contract under title 50 and 51 Revised Code of Washington (RCW) and all taxes
imposed on the Principle under Title 82 RCW.

NOW, THEREFORE, if the Principal herein shall faithfully and truly observe and comply with the
terms, conditions, and provisions of said contract in all respects and shall well and truly and fully do and
perform all matters and things by them undertaken to be performed under said contract, upon the terms
proposed therein, and within the time prescribed therein, and until the same is accepted, and shall pay all
laborers, mechanics, subcontractors, and material men, and all persons who shall supply such contractor
or subcontractor with provisions and supplies for the carrying on of such work, and shall pay all taxes
pursuant to Title 50, and 51, and 82 RCW, and shall in all respects, faithfully perform said contract
according to law, then this obligation to be void, otherwise to remain in full force and effect.

SR

DOT Form 272-002A EF
07/2011

Local Agency Performance Bond
(DOT Form 272-002A)

Local Agency Payment Bond

PUBLIC WORKS PAYMENT BOND

to [City of _____ or _____ County], WA

Bond No. _____

The City of _____ or _____ County, Washington ([City or County]) has awarded to _____ (Principal), a contract for the construction of the project designated as _____ Project No. _____, in [location], Washington (Contract), and said Principal is required under the terms of that Contract to furnish a payment bond in accord with Title 39.08 Revised Code of Washington (RCW) and (where applicable) 60L28 RCW.

The Principal, and _____ (Surety), a corporation organized under the laws of the State of _____ and licensed to do business in the State of Washington as surety and named in the current list of "Surety Companies Acceptable in Federal Bonds" as published in the Federal Register by the Audit Staff Bureau of Accounts, U.S. Treasury Dept., are jointly and severally held and firmly bound to the [City or County], in the sum of _____ US Dollars (\$ _____) Total Contract Amount, subject to the provisions herein.

This statutory payment bond shall become null and void, if and when the Principal, its heirs, executors, administrators, successors, or assigns shall pay all persons in accordance with RCW 39.08, 39.12, and 60.28 including all workers, laborers, mechanics, subcontractors, and materialmen, and all person who shall supply such contractor or subcontractor with provisions and supplies for the carrying on of such work, and all taxes incurred on said Contract under Titles 50 and 51 RCW and all taxes imposed on the Principal under Title 62 RCW; and if such payment obligations have not been fulfilled, this bond shall remain in full force and effect.

The Surety for value received agrees that no change, extension of time, alteration or addition to the terms of the Contract, the specifications accompanying the Contract, or to the work to be performed under the Contract shall in any way affect its obligation on this bond, and waives notice of any changes, extension of time, alteration or addition to the terms of the Contract or the work performed. The Surety agrees that modifications and changes to the terms and conditions of the Contract that increase the total amount to be paid the Principal shall automatically increase the obligation of the Surety on this bond and notice to Surety is not required for such increased obligation.

This bond may be executed in two (2) original counterparts, and shall be signed by the parties' duly authorized officers. This bond will only be accepted if it is accompanied by a fully executed and original power of attorney for the office executing on behalf of the surety.

PRINCIPAL

SURETY

Principal Signature Date

Surety Signature Date

Printed Name Date

Printed Name Date

Title

Title

Name, address, and telephone of local office/agent of Surety Company is:

Approved as to form:

[City or County] Attorney, [City of _____ or _____ County] Date

DOT Form 272-003A
08/2012

Local Agency Payment Bond (DOT Form 272-003A)

Local Agency Contract

THIS AGREEMENT, made and entered into this day of , between the , and the under and by virtue of Title 47 RCW, as amended and

hereinafter called the Contractor.

WITNESSETH:

That in consideration of the terms and conditions contained herein and attached and made a part of this agreement, the parties hereto covenant and agree as follows:

I The Contractor shall do all work and furnish all tools, materials, and equipment for:

in accordance with and as described in the attached plans and specifications, and the standard specifications of the which are by this reference incorporated herein and made part hereof and, shall perform any changes in the work in accord with the Contract Documents.

The Contractor shall provide and bear the expense of all equipment, work and labor, of any sort whatsoever that may be required for the transfer of materials and for constructing and completing the work provided for in these Contract Documents except those items mentioned therein to be furnished by .

II hereby promises and agrees with the Contractor to employ, and does employ the Contractor to provide the materials and to do and cause to be done the above described work and to complete and finish the same in accord with the attached plans and specifications and the terms and conditions herein contained and hereby contracts to pay for the same according to the attached specifications and the schedule of unit or itemized prices at the time and in the manner and upon the conditions provided for in this contract.

SFR

DOT Form 272-006A
02/2011

III. The Contractor for himself/herself, and for his/her heirs, executors, administrators, successors, and assigns, does hereby agree to full performance of all covenants required of the Contractor in the contract.

IV. It is further provided that no liability shall attach to the State by reason of entering into this contract, except as provided herein.

IN WITNESS WHEREOF, the Contractor has executed this instrument, on the day and year first below written and has caused this instrument to be executed by and in the name of the day and year first above written.

Executed by the Contractor _____ , _____

(Contractor)

Local Agency: _____
Title: _____
By: _____
Date: _____ , _____

SFR

DOT Form 272-006A
07/2011

Local Agency Contract - Highway Construction (DOT Form 272-006A)
(Page 2 of 2)

III. The Contractor for himself/herself, and for his/her heirs, executors, administrators, successors, and assigns, does hereby agree to full performance of all covenants required of the Contractor in the contract.

IV. It is further provided that no liability shall attach to by reason of entering into this contract, except as provided herein.

IN WITNESS WHEREOF, the Contractor has executed this instrument, on the day and year first below written and has caused this instrument to be executed by and in the name of the day and year first above written.

Executed by the Contractor _____, _____.

(Contractor)

Local Agency: _____

Title: _____

By: _____

Date: _____, _____

SR

DOT Form 272-008A
07/2011

Local Agency Contract - Building Construction (DOT Form 272-008A)
(Page 1 of 2)

Local Agency Contract

THIS AGREEMENT, made and entered into this day of , ,
between the and

under and by virtue of Title 39 RCW, as amended and

hereinafter called the Contractor.

WITNESSETH:

That in consideration of the terms and conditions contained herein and attached and made a part of this agreement, the parties hereto covenant and agree as follows:

I. The Contractor shall do all work and furnish all tools, materials, and equipment for:

in accordance with and as described in the attached Contract Drawings and Project Manual, which are by this reference incorporated herein and made a part hereof, and as directed shall perform any changes in the work in accord with the Contract Documents.

The Contractor shall provide and bear the expense of all equipment, work and labor, of any sort whatsoever that may be required for the transfer of materials and for constructing and completing the work provided for in these Contract Documents except those items mentioned therein to be furnished by .

II. hereby promises and agrees with the Contractor to employ, and does employ the Contractor to provide the materials and to do and cause to be done the above described work and to complete and finish the same in accord with the attached Contract Drawings and Project Manual and the terms and conditions herein contained and hereby contracts to pay for the same according to the attached Schedule of Values and Contracts Sum at the time and in the manner and upon the conditions provided for in this contract.

SFR

DOT Form 272-008A
07/2011

**Local Agency Contractor Prequalification
Questionnaire and Affidavit for Region Ad
and Award Contracts (\$100,000 or Less)**

Date	Submitted By	Business License No.
Address (Street)		Telephone No.
City	State	Zip
Prequalification Requested For (Identify project by advertised name)		
What is the Value of Your Firm's Assets (Net Worth)? \$		
List Two Similar Projects Your Firm Has Completed in the Last Year. Give Owner's Name and Telephone Number.		
1.		
Owner:		Telephone No.:
2.		
Owner:		Telephone No.:
Were the projects listed above completed on time? <input type="checkbox"/> Yes <input type="checkbox"/> No		
Does your firm owe any monies on any projects which were completed within the last year? (If Yes, provide a separate statement.) <input type="checkbox"/> Yes <input type="checkbox"/> No		
Have you or your firm been convicted of any criminal act involving a contractor or contracts? (If Yes, provide a separate statement.) <input type="checkbox"/> Yes <input type="checkbox"/> No		
Affidavit		
State of		County of
The undersigned, being duly sworn, deposes and says that the foregoing is a true statement of facts concerning the firm (or individual herein named). As of the date indicated: that the answers to the foregoing interrogatories are true; that this statement is for the express purpose of inducing the to award the firm (or individual) a contract and that the depository, vendor, or other agency herein named is hereby authorized to supply or its agents with any information necessary to verify this statement.		
Name of Firm (Be Exact): _____		
_____		_____
<small>Authorized Signature</small>		<small>Authorized Signature</small>
_____		_____
<small>Authorized Signature</small>		<small>Authorized Signature</small>
Sworn to before me this _____ day of _____, 20_____		
_____		<small>Corporate Seal</small>
<small>(Notary Public)</small>		
<small>Notary Seal</small>		
Approved By _____		Date _____
<small>Region Administrator</small>		

SR

DOT Form 272-063A
07/2011

**Local Agency Contractor Prequalification Questionnaire and Affidavit for
Region Ad and Award Contracts (\$100,000 or Less) (DOT Form 272-063A)**

**Appendix 44.72 City Letter of Financial Responsibility
(for State Ad and Award Only) – Example**

Re:

(State Ad and Award)

Award of Project

Attn:

Assistant Secretary, Local Programs

Gentlemen:

The Mayor of the city of _____ gives permission to award the above noted project after advertisement and bid opening, where the bid to be awarded is not more than 10 percent above the current engineer's estimate.

Should the award bid exceed the current municipal agreement dated _____ the city agrees to assume the responsibility for arranging project financing in excess of the agreement after the contract is awarded.

Mayor

Date

Re:

(State Ad and Award)

Award of Project

Attn:

Assistant Secretary, Local Programs

Gentlemen:

The Board of County Commissioners of _____ County gives permission to award the above noted project after advertisement and bid opening, where the bid to be awarded is not more than 10 percent above the current engineer's estimate.

Should the award bid exceed the current municipal agreement dated _____ the county agrees to assume the responsibility for arranging project financing in excess of the agreement after the contract is awarded.

Chairman

Date

Appendix 44.74 Estimate and Grouping – Example

Metric

Preliminary Estimate Dated: January 13, 1994

Title: North Ridge Road

Highway: Laramie County Road

Type of Work: Grading, surfacing, paving with asphalt concrete, construct cement concrete driveways, erosion control, and pavement marking.

Project: STPUL-6969(007)

County: Laramie

Total Length: Length of Project

Estimate Cost Data:

Contract Total	391,507.50
Engineering 15%	58,726.13

Total Cost of Project:	<u>450,233.63</u>
-------------------------------	-------------------

Note: Include below the line items such as: value of materials furnished by agency, agency force work, signs and traffic control, royalties, etc.

Item No.	Description	Unit	Price	Unit Quantity	Amount
1	Mobilization	Lump Sum		Lump Sum	\$ 20,000.00
2	Clearing and Grubbing	Lump Sum		Lump Sum	1,400.00
3	Roadway Excavation Including Haul	m ³	\$ 2.00	780.0	1,560.00
4	Embankment Compaction	m ³	1.00	413.0	413.00
5	Adjust Manhole	Each	300.00	12.0	3,600.00
6	Adjust Catch Basin	Each	100.00	24.0	2,400.00
7	Gravel Base Class B	Tonne	3.00	28,870.0	86,610.00
8	Crushed Surfacing Top Course	Tonne	5.00	6,500.0	32,500.00
9	Asphalt for Tack Coat	Tonne	200.00	10.0	2,000.00
10	Cement Contract Driveway 14 Day	m ²	16.00	289.0	4,624.00
11	Asphalt Concrete Pavement Class B Excluding Paving Asphalt	Tonne	15.00	10,283.0	154,245.00
12	Topsoil Type B	m ³	6.00	410.0	2,460.00
13	Cement Concrete Curb & Gutter	Lin. m	3.50	13,073.0	45,755.50
14	Lane Marker Type 1	Hundred	200.00	19.5	3,900.00
15	Lane Marker Type 2	Hundred	400.00	2.1	840.00
16	One-Way Piloted Traffic Control	Estimate			6,000.00
17	Labor for Traffic Control	Hour	12.00	600.0	7,200.00
18	Reconstruct Wooden Fence	Lin. m	8.00	2,000.0	<u>16,000.00</u>
	Contract Total				<u><u>\$ 391,507.50</u></u>

Laramie County Road
North Ridge Road

**Total Preliminary Estimate
Groups 1 and 2**

1/13/94

Project STPUL-6969(007)

Group No. 1
Federal Participation

Description: Two 3.6 m lanes from Sta. 8+658.50 to Sta. 8+954.92
F.A. Funds 83.01% Urban. Sales Tax 0.00%

Title: Laramie County Road Length: 9 kilometers

Item No.	Description	Unit	Price	Unit Quantity	Amount
1	Mobilization	Lump Sum			\$15,000.00
2	Clearing and Grubbing	Lump Sum			1,000.00
3	Roadway Excavation Including Haul	m ³	\$ 2.00	590.0	1,180.00
4	Embankment Compaction	m ³	1.00	313.0	313.00
5	Adjust Manhole	Each	300.00	9.0	2,700.00
6	Adjust Catch Basin	Each	100.00	18.0	1,800.00
7	Gravel Base Class B	Tonne	3.00	21,660.0	64,980.00
8	Crushed Surfacing Top Course	Tonne	5.00	4,900.0	24,500.00
9	Asphalt for Tack Coat	Tonne	200.00	7.0	1,400.00
10	Cement Contract Driveway 14 Day	m ²	16.00	209.0	3,344.00
11	Asphalt Concrete Pavement Class B Excluding Paving Asphalt	Tonne	15.00	7,773.0	116,595.00
12	Topsoil Type B	m ³	6.00	410.0	2,460.00
13	Cement Concrete Curb & Gutter	Lin. m	3.50	10,409.0	36,431.50
14	Lane Marker Type 1	Hundred	200.00	14.8	2,960.00
15	Lane Marker Type 2	Hundred	400.00	1.6	640.00
16	One-Way Piloted Traffic Control	Estimate			5,000.00
17	Labor for Traffic Control	Hour	12.00	500.0	6,000.00
18	Reconstruct Wooden Fence	Lin. m	8.00	2,000.0	16,000.00
	Group Subtotal				\$ 302,303.50
	Engineering 15 Percent				45,345.53
	Group 1 F.A. Total				<u>\$ 347,649.03</u>

Laramie County Road
North Ridge Road

Group 1 Estimate

1/13/94

Project STPUL-6969(007)

Group No. 2
Local Funds Only

Description: Two 3.6 m lanes from Sta. 8+954.92 to Sta. 9+054.70
No. F.A. Funds and No Sales Tax

Title: Laramie County Road Length: 3 kilometers

Item No.	Description	Unit	Price	Unit Quantity	Amount
1	Mobilization	Lump Sum			\$ 5,000.00
2	Clearing and Grubbing	Lump Sum			400.00
3	Roadway Excavation Including Haul	m ³	\$ 2.00	190.0	380.00
4	Embankment Compaction	m ³	1.00	100.0	100.00
5	Adjust Manhole	Each	300.00	3.0	900.00
6	Adjust Catch Basin	Each	100.00	6.0	600.00
7	Gravel Base Class B	Tonne	3.00	7,210.0	21,630.00
8	Crushed Surfacing Top Course	Tonne	5.00	1,600.0	8,000.00
9	Asphalt for Tack Coat	Tonne	200.00	3.0	600.00
10	Cement Contract Driveway 14 Day	m ²	16.00	80.0	1,280.00
11	Asphalt Concrete Pavement Class B Excluding Paving Asphalt	Tonne	15.00	2,510.0	37,650.00
13	Cement Concrete Curb & Gutter	Lin. m	3.50	2,664.0	9,324.00
14	Lane Marker Type 1	Hundred	200.00	4.7	940.00
15	Lane Marker Type 2	Hundred	400.00	0.5	200.00
16	One-Way Piloted Traffic Control	Estimate			1,000.00
17	Labor for Traffic Control	Hour	12.00	100.0	1,200.00
	Group Subtotal				\$ 89,204.00
	Engineering 15 Percent				13,380.60
	Group 2 Local Funds Only Total				<u>\$ 102,584.60</u>

Laramie County Road
North Ridge Road

Group 2 Estimate

English

Preliminary Estimate Dated: January 13, 1994

Title: North Ridge Road

Highway: Laramie County Road

Type of Work: Grading, surfacing, paving with asphalt concrete, construct cement concrete driveways, erosion control, and pavement marking.

Project: STPUL-6969(007)

County: Laramie

Total Length: Length of Project

Estimate Cost Data:

Contract Total	391,507.50
Engineering 15%	58,726.13

Total Cost of Project:	<u>450,233.63</u>
-------------------------------	-------------------

Note: Include below the line items such as: value of materials furnished by agency, agency force work, signs and traffic control, royalties, etc.

Item No.	Description	Unit	Price	Unit Quantity	Amount
1	Mobilization	Lump Sum		Lump Sum	\$ 20,000.00
2	Clearing and Grubbing	Lump Sum		Lump Sum	1,400.00
3	Roadway Excavation Including Haul	Cu. Yd.	\$ 2.00	780.0	1,560.00
4	Embankment Compaction	Cu. Yd.	1.00	413.0	413.00
5	Adjust Manhole	Each	300.00	12.0	3,600.00
6	Adjust Catch Basin	Each	100.00	24.0	2,400.00
7	Gravel Base Class B	Ton	3.00	28,870.0	86,610.00
8	Crushed Surfacing Top Course	Ton	5.00	6,500.0	32,500.00
9	Asphalt for Tack Coat	Ton	200.00	10.0	2,000.00
10	Cement Contract Driveway 14 Day	Sq. Yd.	16.00	289.0	4,624.00
11	Asphalt Concrete Pavement Class B Excluding Paving Asphalt	Ton	15.00	10,283.0	154,245.00
12	Topsoil Type B	Cu. Yd.	6.00	410.0	2,460.00
13	Cement Concrete Curb & Gutter	Lin. Ft.	3.50	13,073.0	45,755.50
14	Lane Marker Type 1	Hundred	200.00	19.5	3,900.00
15	Lane Marker Type 2	Hundred	400.00	2.1	840.00
16	One-Way Piloted Traffic Control	Estimate			6,000.00
17	Labor for Traffic Control	Hour	12.00	600.0	7,200.00
18	Reconstruct Wooden Fence	Lin. Ft.	8.00	2,000.0	<u>16,000.00</u>
	Contract Total				<u><u>\$ 391,507.50</u></u>

Laramie County Road
North Ridge Road

**Total Preliminary Estimate
Groups 1 and 2**

1/13/94

Project STPUL-6969(007)

Group No. 1
Federal Participation

Description: Two 12 ft. lanes from Sta. 8+658.50 to Sta. 8+954.92
F.A. Funds 83.01% Urban. Sales Tax 0.00%

Title: Laramie County Road Length: 5.614 miles

Item No.	Description	Unit	Price	Unit Quantity	Amount
1	Mobilization	Lump Sum			\$15,000.00
2	Clearing and Grubbing	Lump Sum			1,000.00
3	Roadway Excavation Including Haul	Cu. Yd.	\$ 2.00	590.0	1,180.00
4	Embankment Compaction	Cu. Yd.	1.00	313.0	313.00
5	Adjust Manhole	Each	300.00	9.0	2,700.00
6	Adjust Catch Basin	Each	100.00	18.0	1,800.00
7	Gravel Base Class B	Ton	3.00	21,660.0	64,980.00
8	Crushed Surfacing Top Course	Ton	5.00	4,900.0	24,500.00
9	Asphalt for Tack Coat	Ton	200.00	7.0	1,400.00
10	Cement Contract Driveway 14 Day	Sq. Yd.	16.00	209.0	3,344.00
11	Asphalt Concrete Pavement Class B Excluding Paving Asphalt	Ton	15.00	7,773.0	116,595.00
12	Topsoil Type B	Cu Yd.	6.00	410.0	2,460.00
13	Cement Concrete Curb & Gutter	Lin. Ft.	3.50	10,409.0	36,431.50
14	Lane Marker Type 1	Hundred	200.00	14.8	2,960.00
15	Lane Marker Type 2	Hundred	400.00	1.6	640.00
16	One-Way Piloted Traffic Control	Estimate			5,000.00
17	Labor for Traffic Control	Hour	12.00	500.0	6,000.00
18	Reconstruct Wooden Fence	Lin. Ft.	8.00	2,000.0	16,000.00
	Group Subtotal				\$ 302,303.50
	Engineering 15 Percent				45,345.53
	Group 1 F.A. Total				<u>\$ 347,649.03</u>

Laramie County Road
North Ridge Road

Group 1 Estimate

1/13/94

Project STPUL-6969(007)

Group No. 2
Local Funds Only

Description: Two 12 ft. lanes from Sta. 8+954.92 to Sta. 9+054.70
No. F.A. Funds and No Sales Tax

Title: Laramie County Road Length: 1.900 miles

Item No.	Description	Unit	Price	Unit Quantity	Amount
1	Mobilization	Lump Sum			\$ 5,000.00
2	Clearing and Grubbing	Lump Sum			400.00
3	Roadway Excavation Including Haul	Cu. Yd.	\$ 2.00	190.0	380.00
4	Embankment Compaction	Cu. Yd.	1.00	100.0	100.00
5	Adjust Manhole	Each	300.00	3.0	900.00
6	Adjust Catch Basin	Each	100.00	6.0	600.00
7	Gravel Base Class B	Ton	3.00	7,210.0	21,630.00
8	Crushed Surfacing Top Course	Ton	5.00	1,600.0	8,000.00
9	Asphalt for Tack Coat	Ton	200.00	3.0	600.00
10	Cement Contract Driveway 14 Day	Sq. Yd.	16.00	80.0	1,280.00
11	Asphalt Concrete Pavement Class B Excluding Paving Asphalt	Ton	15.00	2,510.0	37,650.00
13	Cement Concrete Curb & Gutter	Lin. Ft.	3.50	2,664.0	9,324.00
14	Lane Marker Type 1	Hundred	200.00	4.7	940.00
15	Lane Marker Type 2	Hundred	400.00	0.5	200.00
16	One-Way Piloted Traffic Control	Estimate			1,000.00
17	Labor for Traffic Control	Hour	12.00	100.0	1,200.00
	Group Subtotal				\$ 89,204.00
	Engineering 15 Percent				13,380.60
	Group 2 Local Funds Only Total				<u>\$ 102,584.60</u>

Laramie County Road
North Ridge Road

Group 2 Estimate

Appendix 44.75

Local Agency Plans Preparation Checklist

Job Title				Project No.			
X Items Required On This Project				IN Initial When Complete			
Signing Plans and Sign Specifications				Traffic Control Plans (continued)			
Legend Or Reference Note On All Sheets				Bid Items Required For:			
Separate Set Of Plan Sheets For Construction Signing				N/A X IN			
Separate Plan Sheet Specification For Sign Removal/Relocation				N/A X IN			
Landscape				Change Mess Sign			
Contour Grading Plan				Chann. Devices			
Planting Detail				Const. Sign Class A			
Approval From District Landscape				Contr. Furn. Const. Sign			
Approval From Hq Landscape				Contr. Piolt. Traff. Control			
Wildflower Policy (Federal Aid Project)				Deline. Light			
Rest Areas				Emerg. Traff. Control			
N/A X IN				Rem. Temp. Pave. Mark			
Viewpoints				Reset. Conc. Barr.			
N/A X IN				Reset. Deline. Light			
Minor Structures (Ret. Wall)				Reset Temp. Imp. Atten.			
N/A X IN				Reset Temp. Inert. Barr			
Quantities tabulated				Sequent. Arrow Sign			
Building Plans, Schedules and Details				Traffic Control Plans			
N/A X IN				N/A X IN			
Any Building Being Constructed Will Require A Building Permit				Reasonable Quantities For Traffic Control Items - Send To Constr. Proj. Engr.'s For Approval			
Bridge Plan				Special Provisions			
N/A X IN				N/A X IN			
Match Of Wingwalls To Walls On District PS&E				Notice To All Planholders			
Items To Be Included On Plans				Table Of Contents - Computer Generated			
Gravel Backfill				Amendments And GSP's Arranged In Proper Order			
Drainage				Revisions To All Division 1 Specifications Approved			
Barrier				Appendix prepared (Good Reproducible Copy)			
Approach Slabs				Special Provisions For All Non-Standard Items			
Slope Protection				Standard Items Table Is A Guide To What Items Need Specials:			
Conduit Runs				Need A Special Provision For Each Item That Appears On The Summary Of Quantities That Is Not Covered In Standard Specifications			
Aesthetic Appearance Of Bridge Connection To Barrier Or Guardrail				Sales Tax Checked, Appropriate GSP Used			
Log Of Test Boring Prepared				Special Provision For Agree, Stipulation			
Profile, Alignment, And Station Match PS&E				Check Amendments And GSP's Against Up-to-date Index List			
Traffic Control Plans				Any Fed. Money In A Proj. Requires All Fed Provision Per GSP Index			
N/A X IN				Prevention Of Environmental Pollution And Preservation Of Public Natural Resources (HB 621)			
Project Specific Traffic Control Plans				Environmental Regulations - Verify Correct For Location			
Detour Plan If Needed - May Require Agreements Through Local Programs				Obtain Copy Of Any New Ordinance And Get It Added To GSP's			
Detour Sign Details				Archeological, Paleontological			
				Wildlife, Fisheries And Pollution Regulations			
				Additional Requirements Requested By F & W Etc., (From HPA, WPCP)			
				Expiration Date Of Permit And Work "Windows"			
				Trainees - Determined In Headquarters			
				MBE Goal - Determined In Headquarters			
				RR Provisions			
				Compare To Local Map To Find RR Lines			

DOT Form 272-070 EF
Revised 03/2011

Job Title				Project No.			
X Items Required On This Project				IN Initial When Complete			
Quantity Tabulations (continued)				Structure Notes (continued)			
	N/A	X	IN		N/A	X	IN
Traffic Arrow Type Indicated				Appropriate Special Provision Referred To In General Notes			
Agreement Items Denoted				Leave Several Station Lines Blank Between Ref. Sheet Nos.			
Plan Sheet Reference Number Filled In				Box Culvert Quantities			
Stations Agree With Plans							
Guardrail Placement Case							
Radius And G. R. Length For Non-Std. Bends				Drainage Plans and Profiles	N/A	X	IN
Design "F" Guardrail Terminal Approval By Bridge				Legend Or Reference Note On All Sheets			
Leave Every 5th Item Column And Station Line Blank				Need Profiles For Major Culverts And Sewer Systems			
Appropriate Special Provision Referred To In General Notes				Conformance With Hydraulics Report			
				Pipes Over 30" Dia. Need Design Review By Hydraulics			
Profiles	N/A	X	IN	Details Required For Work <u>Not</u> Covered By Standard Plans			
Mainline				Show Distance Between Structures (ie \bar{Q} C.B. to \bar{Q} C.B.)			
Ramps							
Frontage Roads				Utility Relocations	N/A	X	IN
Detours				Existing Utilities Must Be Shown In Plan			
Trails				Reloc. Costs - Reflect In Below-The-Line Costs			
Show Equations And Exceptions				Timing Of Work-Address In Provision			
Plan/profile Sheets, Stationing Must Be Identical				Details			
Coordinate With Roadway Sections And Plans							
Show Bridges ("Included" Or "Not Included")				Channelization and Paving Plan	N/A	X	IN
Show Quantities Per Design Manual (10 Station Totals)				Paving Plan And Road. Sect. Must Agree			
Round Off Quantities Per Design Manual				Legend Or Reference Note On All Sheets			
Correct Totals To Summary Of Quantities				Show Paving Plan For I/C And Intersections			
Show Unsuit. Exc. Limits And Excavation Slopes				Channelization Detail			
Superelevation Diagrams, Match Rates As Shown On Alignment Plan				Show Guide Posts Especially I/C And Intersections			
Datum Symbol And Bench Mark Location				Show Pave. Marking (Optional)			
Show Road Approach Arrow & Indicate Lt. & Rt.							
				Miscellaneous Details	N/A	X	IN
Structure Notes	N/A	X	IN	Required For Work Not Covered By Standard Plan			
Order And Nomenclature Of Item As Shown On Summary Of Quantities							
Round Off Quantities Per Design Manual				Illumination Plans, Schedules and Details	N/A	X	IN
Correct Totals (Sheet & Project)				Legend Or Reference Notes On All Sheets			
Transfer Project Totals To Summary Of Quantities				Conflicts With Existing Features, i.e., Utilities, Drainage, & Sidewalks			
Consistency Between Structure Notes, Plans Profiles, And Spec's				All Work Within R/W Or Construction Permit Area			
Agreement Items Noted							
Steel, Alum., And Conc. Pipe Alter. Provided				Signal Plans, Schedules and Details	N/A	X	IN
Alternate Treat. For Steel And Alum. Pipe				Legend Or Reference Note On All Sheets			
Maximum Height Of Cover Column On Structure Notes In Pencil, Or Separate Level In Cad Files				Conflicts With Existing Features			
Note Beveled End Sections				Traffic Signal Approval/Permit No.			
Leave Every 5th Item Column Blank				All Work Within R/W Or Construction Permit Areas			

DOT Form 272-070 EF
Revised 03/2011

Job Title				Project No.			
X Items Required On This Project				IN Initial When Complete			
Plans - General (continued)				Roadway Sections			
	N/A	X	IN		N/A	X	IN
Sheet Titles In Ink In Lower Right Title Block		<input checked="" type="checkbox"/>		Label Sections			
Local Agencies Seals & Signatures				Sta Limits For Each Sec-Entire Length Of Each Roadway Must Be Covered			
Consultant Signatures & Seals				Check For Overlap And Gaps In Stationing			
Consultant Written Consent To Revised Plan				Show Future On F.A. Projects For Future FA Funding			
All Plan Sheets In Proper Order		<input checked="" type="checkbox"/>		Conformance With Soils Report			
Connect. To Existing Streets, Driveways, Etc. (Field Rev.)				Conformance With Design Report			
No Combination Of Ink And Pencil On Same Sheet		<input checked="" type="checkbox"/>		Guardrail Widening Details			
Plan Symbols In Accord. Chapter 5 - Legend		<input checked="" type="checkbox"/>		Shoulder Dressing Details			
Min. Lettering Height 1/8" On Full Size Sheet		<input checked="" type="checkbox"/>		Slope Rounding Details			
				Broken Back Subgrade Shoulder Detail			
Vicinity Map				ACP planing detail			
	N/A	X	IN	Table For Variable Slopes			
Reasonable Scale To Show The Project		<input checked="" type="checkbox"/>		Legend All Sheets			
Project Limits By Milepost And Stationing		<input checked="" type="checkbox"/>		Reference Notes			
Construction Limits By Milepost And Stationing				Note Equations And Exception			
Equations And Exceptions				Lift thickness for ACP and surfacing (Compacted depth)			
Distance to towns (Rural Projects Only)				No "Min." Or "Max." For Surf. And Paving Depth Or Slopes			
Pit, Waste, And Stockpile Sites And Haul Roads							
Detour Routes				Alignment, R/W, Grading & Existing Features Plan			
Railroad Lines-IMPORTANT To Show Any In Area					N/A	X	IN
If Staged Project, Show Staging For Future FA Funding				Curve Data, Super Elevation Rates			
Show Bridge No.				Show Cut And Fill Catch Line			
				Monumentation - Protect Existing, Install New			
Summary of Quantities				Legend Or Reference Note On All Sheet			
	N/A	X	IN	Alignment Plan Must Show R/W Centerline (Including R/W Curve Data) And Const. Centerline With Ties If Different			
All Necessary Groups Per Design Manual		<input checked="" type="checkbox"/>		R/W And L/A Must Agree With Approved R/W & L/A Plan			
Separate Groups For Agreement Work				Show RR Alignment And RR R/W			
Review For Order, Nomenclature And Standard Number		<input checked="" type="checkbox"/>		Are Easements And/Or Permits Required			
Look For Unusual And Non-Stand Items - These Need Sp. Provs.		<input checked="" type="checkbox"/>		Show Site Prep. And Demolition Work			
Used Std, Tem No. For Std. Item		<input checked="" type="checkbox"/>		All Items To Be Removed Shown			
All Items Tabulated		<input checked="" type="checkbox"/>		Show Fencing			
Check Quantities From Plans		<input checked="" type="checkbox"/>		Show Guardrail (Or Paving Plan)			
Q.A. Items							
				Quantity Tabulations			
Roadway Sections				N/A X IN			
	N/A	X	IN	Same Order And Nomenclature As On Summary Of Quantities			
Mainline				Items Required On Q-tab Per Design Manual			
Ramps				Round Off Quantities Per Design Manual			
Frontage Roads				Correct Totals (Sheet And Project)			
City/County roads at intersections				Transfer Project Totals To Summary Of Quantities			
Road Approaches				Guide Post Color And Reflector Type Indicated			
Detours				T-2 Raised Pave. Mark. Color Indicated			
Trails							
Bridge Approach Slab							
Bridge							

DOT Form 272-070 EF
Revised 03/2011



Local Agency Plans Preparation Checklist

Rd/St. No./Name	Project No.	P.I.N.	Federal Aid No.	Local Agency
Job Title				Program
Design Engineer		Phone Number	Reviewer	Phone Number
X Items Required On This Project			IN Initial When Complete	
Permits & Approvals			N/A X IN	
Army Corp of Eng. (Sec. 10 Or Sec. 404)				
FAA Airport/Highway Clearance				
FERC Restricted Hydro-Electric Land				
USFWS Wetlands Report				
USFWS/NMFS Endangered/Threatened Species		X		
Soil Conservation Service Prim & Unique Farmlands				
Nat/I Forest Restriction				
Park Restriction (4 (f))				
OAHP Historic/Archaeological (Sec. 106)		X		
EPA Sole Source Aquifer				
Dept's Of Fish And Wildlife HPA				
DOE Water Quality Cert.				
DOE/Counties Flood Plains				
DOE Coastal Zone Management Act				
DOE Discharge of Pollutants into Surface Water (NPDES)				
DOE State Waste Disposal				
DOE Short Term Mod.				
DOE Water Right Approp.				
DOE Water Pollution Control Plan				
Counties/Cities DOE Shoreline Management Substantial Development				
Counties Cities DOE conditional use				
EIS Commitments				
NEPA (All Federal Aid Projects)				
SEPA		X		
Railroads			N/A X IN	
Railway Easement (Checked For Stipulations)				
Railway Construction Agreement				
Railroad Insurance				
Flagging Cost Estimate				
Cities			N/A X IN	
Approval Of City Streets As Detours (Agreement)				
City Participation In Cost (Agreement)				
City Streets Used As Haul Roads (Agreement)				
Construction Permits				
Turnback Agreement				
County			N/A X IN	
Approval Of County Roads As Detours (Agreement)				
County Participation In Cost (Agreement)				
County Roads Used As Haul Roads (Agreement)				
Construction Permits				
Turnback Agreement				
Compare Previous Approvals			N/A X IN	
Detours				
Approved Rec. Plan For Pit Site				
Approval For Tied Bids				
Approval <u>Not</u> To Use Bridge Approach Slab				
Hydraulics			N/A X IN	
Pipe Alternates				
Materials			N/A X IN	
Sufficient Quantity In Pit Site				
Spec. Conditions - Wet Soil, Unsuitable, Etc.				
Spec. Treat. For Exist. Pave.				
Ret. Wall Data Sheet For Rock Walls Over 5' And All Other Walls Over 10'				
pH And Soil Resistivity Values For Pipe Alternates				
Plans - General			N/A X IN	
Township, Range, Subdivision, North Arrow, Scale Bar Each Sheet			X	
State Boundary, County Line, Corporate Limit				
Reservation, Park Or Forest Boundary				
Project Limits Noted			X	
Construction Limits Noted				
Federal Aid Sections Noted				
Ultimate Const. Detailed (FA Jobs)				
Note "Bridges Included" Or "Bridges Not Included"				
Equations Noted				
Contract Rec. Plan Included				
Index To Plans (More Than 30 Sheets)				
Sheets Numbered (In Pencil Or Use Ref. No. For Large Projects)				X
Project Title Block Left Blank				X
Sheets Identified In Lower Left Corner				X

DOT Form 272-070 EF
Revised 03/2011

Job Title				Project No.			
X Items Required On This Project				IN Initial When Complete			
Special Provisions (continued)				Miscellaneous			
	N/A	X	IN		N/A	X	IN
Include RR GSP And Mention In Transmittal Letter				Justification For Proprietary Items (F.A. Proj.)			
Forest Practices Permit: Merchantable Timber 5,000 Or More Board Feet (One Logging Truckload) Use GSP				Justification For State Furnished Material Including Pit Site And Stockpile Material (F.A. Proj.)			
Traffic				Justification For Mandatory Use Of Disposal Site (F.A. Proj.)			
Work Period Specs				Justification For Local Agency Work (All Proj.)			
Lane Closure Hours With Appropriate Liquid. Damages				Justification for Non-Standard Items			
Construction Impact Specs.				Justification For No Pipe Alternates			
METRO Notification Paragraph				Data For Liquidated Damages From Traffic Data Office			
Time For Completion (Be Very Careful To Select Correct GSP For Intended Purpose)				Data For Incent./Disincent. From Traffic Data Office			
Signal Jobs With State Furnished Equipment Have A Unique Provision				Review In Field For Utility Agree. Needs			
Clearing And Grubbing Including Disposal Of Debris Per Design Manual Removal Of Structures And Obstructions Per GSP Instructions				Utility Agreements Work Included			
Anticipated Quantities Must Be Listed				Haul Road Agreement Checked			
Salvaged Items (Verify With Maint.)				Review Items In Clear Zone Inventory For Removal			
Disposal Of Material (State Waste Site May Require Haul Road Agreements)				Is Stur. Exc. Cl. B And Stru. Exc. Cl. B Incl. Haul Being Used Correctly			
Roadside Seeding Including Fertilizer Application				Use The Item "Anti-Stripping Additive" For Over 200 Tons Of ACP			
Correct Seeding Specification							
Provide For 2nd App. Of Fertilizer After Contract Comp. - Not All Jobs							
Pay Item Must Match Summ. Quant.							
Verify Ref. To Std. Spec. And Std. Plans							
Correct Seeding Specification							
Provide For 2nd. App. Of Fertilizer After Contract Comp. - Not All Jobs							
Pay Item must Match Summ. Quant.							
Verify Ref. To Std. Spec. And Std. Plan							
Estimate	N/A	X	IN				
Estimate Entered In BASS							
If Estimate Exceeds Budget Inform Prog. Man. & Proj. Dev. Calc. Of Lump Sum Items							
Compare Against Recent Bid History (Price Check)							
Group Description To Match Appendix 3-13							
Extra Construction State Forces Listed							
Extra Construction Agreement Listed							
Agreement Costs Included							
Below-The-Line Costs For R.R. Flagging (Amount Over \$5000)							
Pit Amortization							
Royalties							
Calc. For Paths and Trails							

DOT Form 272-070 EF
Revised 03/2011

Appendix 44.76 Patented/Proprietary Items – PIF Instructions

Project Information

State/Local Project Number – For WSDOT projects, this is the work order number or WIN. For local projects, this field is for local agency use/tracking.

Project Name – Provide the name of the project as it is listed in the State Transportation Improvement Plan (STIP).

Federal Aid Project Number – This number will be assigned by WSDOT. Contact the Region Local Programs staff to obtain this number.

NEPA Category – Check the appropriate box:

- Environmental Impact Statement (EIS). Refer to [Subsection 24.21](#) of the *Local Agency Guidelines*.
- Categorical Exclusion (CE), Documented Categorical Exclusion (DCE), and Programmatic Categorical Exclusion (Programmatic CE). Refer to [Subsection 24.22](#) of the *Local Agency Guidelines*.
- Environmental Assessment (EA). Refer to [Subsection 24.23](#) of the *Local Agency Guidelines*.

Region or Agency – Fill in with the WSDOT Region or Local Agency requesting the finding.

Amount – Fill in the total amount of the request.

Project of Division Interest – Is when FHWA retains the project oversight. If not certain, contact your Region Local Programs Engineer.

Public Interest Finding (PIF) Information

Select Type of PIF – Use the pull down menu to select the PIF that fits the project.

Regulatory Reference – This field is automatically filled in when you select the PIF.

Justification or Supporting Information

Goal Statement – What is being accomplished/what is the outcome for using a Patented/Proprietary item.

Description of Work – Provide a detailed description of why Patented/Proprietary items are needed.

Justification or Supporting Information

The use of trade names in specifications and on plans should be avoided. Instead, specifications should be formulated to assure full opportunity for competition among equivalent materials, equipment, and methods. Specifying patented or proprietary material, products or processes is allowed for federal aid projects only under one of the following conditions:

- At least three names of acceptable materials or products, are listed together with a list of the required features and specifications that will be considered equal to the listed items.
- The agency is requiring a specific material or product and a written Public Interest Finding (PIF) document has been prepared and approved by Local Programs.
- The material or product has been approved through FHWA as an experimental feature.

Cost Effectiveness Determination

- Attach a detailed estimate for the Patented/Proprietary items (see [Appendix 44.81](#)).
- Provide an explanation of cost effectiveness (see [Appendix 44.83](#)).

Schedule Issues – N/A

Buy America Compliance

- Steel and iron that is permanently incorporated into the project shall consist of American-made materials, as outlined in the required GSP.
- The local agency must include a provision containing the “Buy-America” requirements in each contract. These general special provisions are included in the WSDOT Amendments and General Special Provisions publication.
- Purchase of foreign steel and iron products by local agencies for installation on a federally funded project is not allowed without an approved Public Interest Finding from Local Programs.
- The agency must ensure the requested Patented/Proprietary Items meet the current “Buy America” requirements and must document the sources of steel and iron by having a “Certification of Materials Origin” on file.

Environmental – N/A

NEPA/SEPA Logical Termini & Independent Utility – N/A

Conclusion

- A brief summary of the overall benefits and cost effectiveness.
- Approval by WSDOT Local Programs is required.
- Approval is dependent on demonstration of overall cost effectiveness and public benefit. The determination is not solely dependent on cost savings.
- At least one signature from the local agency is required.

Appendix 44.77 Two-Week Advertisement – PIF Instructions

Project Information

State/Local Project Number – For WSDOT projects, this is the work order number or WIN. For local projects, this field is for local agency use/tracking.

Project Name – Provide the name of the project as it is listed in the State Transportation Improvement Plan (STIP).

Federal Aid Project Number – This number will be assigned by WSDOT. Contact the Region Local Programs staff to obtain this number.

NEPA Category – Check the appropriate box:

- Environmental Impact Statement (EIS). Refer to [Subsection 24.21](#) of the *Local Agency Guidelines*.
- Categorical Exclusion (CE), Documented Categorical Exclusion (DCE), and Programmatic Categorical Exclusion (Programmatic CE). Refer to [Subsection 24.22](#) of the *Local Agency Guidelines*.
- Environmental Assessment (EA). Refer to [Subsection 24.23](#) of the *Local Agency Guidelines*.

Region or Agency – Fill in with the WSDOT Region or Local Agency requesting the finding.

Amount – Fill in the total amount of the request.

Project of Division Interest – Is when FHWA retains the project oversight. If not certain, contact your Region Local Programs Engineer.

Public Interest Finding (PIF) Information

Select Type of PIF – Use the pull down menu to select the PIF that fits the project.

Regulatory Reference – This field is automatically filled in when you select the PIF.

Justification or Supporting Information

Goal Statement – Why is there a need for a two-week advertisement.

Description of Work – Provide a summary description of project.

Justification or Supporting Information

Cost Effectiveness Determination

- Attach a summary level estimate.
- Provide project schedules (documenting both three-week and two-week advertisement) showing the benefits of reducing the advertisement period.

Schedule Issues – Explain how the agency will deliver the project and describe the benefits to the public for reducing the advertisement period.

Buy America Compliance

- Steel and iron that is permanently incorporated into the project shall consist of American-made materials, as outlined in the required GSP.
- The local agency must include a provision containing the “Buy-America” requirements in each contract. These general special provisions are included in the WSDOT Amendments and General Special Provisions publication.
- Purchase of foreign steel and iron products by local agencies for installation on a federally funded project is not allowed without an approved Public Interest Finding from Local Programs.
- The agency must document the sources of steel and iron by having a “Certification of Materials Origin” on file.

Environmental – N/A

NEPA/SEPA Logical Termini & Independent Utility – N/A

Conclusion

- A brief summary of the overall benefits and cost effectiveness.
- Approval by WSDOT Local Programs is required.
- Approval is dependent on demonstration of overall cost effectiveness and public benefit. The determination is not solely dependent on cost savings.
- At least one signature from the local agency is required.

Appendix 44.78 Mandatory Use of Borrow or Disposal Site – PIF Instructions

Project Information

State/Local Project Number – For WSDOT projects, this is the work order number or WIN. For local projects, this field is for local agency use/tracking.

Project Name – Provide the name of the project as it is listed in the State Transportation Improvement Plan (STIP).

Federal Aid Project Number – This number will be assigned by WSDOT. Contact the Region Local Programs staff to obtain this number.

NEPA Category – Check the appropriate box:

- Environmental Impact Statement (EIS). Refer to [Subsection 24.21](#) of the *Local Agency Guidelines*.
- Categorical Exclusion (CE), Documented Categorical Exclusion (DCE), and Programmatic Categorical Exclusion (Programmatic CE). Refer to [Subsection 24.22](#) of the *Local Agency Guidelines*.
- Environmental Assessment (EA). Refer to [Subsection 24.23](#) of the *Local Agency Guidelines*.

Region or Agency – Fill in with the WSDOT Region or Local Agency requesting the finding.

Amount – Fill in the total amount of the request.

Project of Division Interest – Is when FHWA retains the project oversight. If not certain, contact your Region Local Programs Engineer.

Public Interest Finding (PIF) Information

Select Type of PIF – Use the pull down menu to select the PIF that fits the project.

Regulatory Reference – This field is automatically filled in when you select the PIF.

Justification or Supporting Information

Goal Statement – What is being accomplished/what is the outcome for using Mandatory Borrow or Disposal Site.

Description of Work – Provide a detailed description of work to be done.

Justification or Supporting Information

Cost Effectiveness Determination – Provide an explanation of cost effectiveness or benefits.

Schedule Issues – Explain how the agency will deliver the project and describe if there is a benefit to the public.

Buy America Compliance

- Steel and iron that is permanently incorporated into the project shall consist of American-made materials, as outlined in the required GSP.
- The local agency must include a provision containing the “Buy-America” requirements in each contract. These general special provisions are included in the WSDOT Amendments and General Special Provisions publication.
- Purchase of foreign steel and iron products by local agencies for installation on a federally funded project is not allowed without an approved Public Interest Finding form Local Programs.
- The agency must document the sources of steel and iron by having a “Certification of Materials Origin” on file.

Environmental – N/A

NEPA/SEPA Logical Termini & Independent Utility – N/A

Conclusion

- A brief summary of the overall benefits and cost effectiveness.
- Approval by WSDOT Local Programs is required.
- Approval is dependent on demonstration of overall cost effectiveness and public benefits. The determination is not solely dependent on cost savings.
- At least one signature from the local agency is required.

Appendix 44.79 Agency Supplied Equipment – PIF Instructions

Project Information

State/Local Project Number – For WSDOT projects, this is the work order number or WIN. For local projects, this field is for local agency use/tracking.

Project Name – Provide the name of the project as it is listed in the State Transportation Improvement Plan (STIP).

Federal Aid Project Number – This number will be assigned by WSDOT. Contact the Region Local Programs staff to obtain this number.

NEPA Category – Check the appropriate box:

- Environmental Impact Statement (EIS). Refer to [Subsection 24.21](#) of the *Local Agency Guidelines*.
- Categorical Exclusion (CE), Documented Categorical Exclusion (DCE), and Programmatic Categorical Exclusion (Programmatic CE). Refer to [Subsection 24.22](#) of the *Local Agency Guidelines*.
- Environmental Assessment (EA). Refer to [Subsection 24.23](#) of the *Local Agency Guidelines*.

Region or Agency – Fill in with the WSDOT Region or Local Agency requesting the finding.

Amount – N/A

Project of Division Interest – Is when FHWA retains the project oversight. If not certain, contact your Region Local Programs Engineer.

Public Interest Finding (PIF) Information

Select Type of PIF – Use the pull down menu to select the PIF that fits the project.

Regulatory Reference – This field is automatically filled in when you select the PIF.

Justification or Supporting Information

Goal Statement – What is being accomplished/what is the outcome for using agency supplied equipment.

Description of Work – Provide a detailed description of equipment being used.

Justification or Supporting Information

Cost Effectiveness Determination – Provide an explanation of cost effectiveness or benefits.

Schedule Issues – Explain how the agency will deliver the project and describe if there is a benefit to the public.

Buy America Compliance

- Steel and iron that is permanently incorporated into the project shall consist of American-made materials, as outlined in the required GSP.
- The local agency must include a provision containing the “Buy-America” requirements in each contract. These general special provisions are included in the WSDOT Amendments and General Special Provisions publication.
- Local Agency must identify the Agency Supplied Material meets the requirements of 23 CFR 635.410 (Buy America). In the event the Agency Supplied Material contains small amount of foreign steel or iron products, the agency shall document the amount of foreign materials and prepare a project specific special provision to information the bidders the cost of such foreign materials.
- The agency must document the sources of steel and iron by having a “Certification of Materials Origin” on file.

Environmental – N/A

NEPA/SEPA Logical Termini & Independent Utility – N/A

Conclusion

- A brief summary of the overall benefits and cost effectiveness.
- Approval by WSDOT Local Programs is required.
- Approval is dependent on demonstration of overall cost effectiveness and public benefits. The determination is not solely dependent on cost savings.
- At least one signature from the local agency is required.

Appendix 44.80 Agency Supplied Material – PIF Instructions

Project Information

State/Local Project Number – For WSDOT projects, this is the work order number or WIN. For local projects, this field is for local agency use/tracking.

Project Name – Provide the name of the project as it is listed in the State Transportation Improvement Plan (STIP).

Federal Aid Project Number – This number will be assigned by WSDOT. Contact the Region Local Programs staff to obtain this number.

NEPA Category – Check the appropriate box:

- Environmental Impact Statement (EIS). Refer to [Subsection 24.21](#) of the *Local Agency Guidelines*.
- Categorical Exclusion (CE), Documented Categorical Exclusion (DCE), and Programmatic Categorical Exclusion (Programmatic CE). Refer to [Subsection 24.22](#) of the *Local Agency Guidelines*.
- Environmental Assessment (EA). Refer to [Subsection 24.23](#) of the *Local Agency Guidelines*.

Region or Agency – Fill in with the WSDOT Region or Local Agency requesting the finding.

Amount – Fill in the total amount of the request.

Project of Division Interest – Is when FHWA retains the project oversight. If not certain, contact your Region Local Programs Engineer.

Public Interest Finding (PIF) Information

Select Type of PIF – Use the pull down menu to select the PIF that fits the project.

Regulatory Reference – This field is automatically filled in when you select the PIF.

Justification or Supporting Information

Goal Statement – What is being accomplished/what is the outcome for using agency supplied materials.

Description of Work – Provide a detailed description of why agency supplied materials are needed.

Justification or Supporting Information

Cost Effectiveness Determination

- Attach a detailed estimate for the material supplied (see [Appendix 44.81](#)).
- Provide an explanation of cost effectiveness or benefits.

Schedule Issues – Explain how the agency will deliver the project and describe if there is a benefits to the public.

Buy America Compliance

- Steel and iron that is permanently incorporated into the project shall consist of American-made materials, as outlined in the required GSP.
- The local agency must include a provision containing the “Buy-America” requirements in each contract. These general special provisions are included in the WSDOT Amendments and General Special Provisions publication.
- Purchase of foreign steel and iron products by local agencies for installation on a federally funded project is not allowed without an approved Public Interest Finding form Local Programs.
- The agency must document the sources of steel and iron by having a “Certification of Materials Origin” on file.

Environmental – N/A

NEPA/SEPA Logical Termini & Independent Utility – N/A

Conclusion

- A brief summary of the overall benefits and cost effectiveness.
- Approval by WSDOT

Local Programs is required.

- Approval is dependent on demonstration of overall cost effectiveness and public benefits. The determination is not solely dependent on cost savings.
- At least one signature from the local agency is required.
- Local Agency staff responsible for purchasing must comply with Washington State procurement procedures in accordance with [RCW 39.26](#) - Procurement of Good and Services.

Appendix 44.81 Local Agency Force Work– PIF Instructions

Project Information

State/Local Project Number – For WSDOT projects, this is the work order number or WIN. For local projects, this field is for local agency use/tracking.

Project Name – Provide the name of the project as it is listed in the State Transportation Improvement Plan (STIP).

Federal Aid Project Number – This number will be assigned by WSDOT. Contact the Region Local Programs staff to obtain this number.

NEPA Category – Check the appropriate box:

- Environmental Impact Statement (EIS). Refer to [Subsection 24.21](#) of the *Local Agency Guidelines*.
- Categorical Exclusion (CE), Documented Categorical Exclusion (DCE), and Programmatic Categorical Exclusion (Programmatic CE). Refer to [Subsection 24.22](#) of the *Local Agency Guidelines*.
- Environmental Assessment (EA). Refer to [Subsection 24.23](#) of the *Local Agency Guidelines*.

Region or Agency – Fill in with the WSDOT Region or Local Agency requesting the finding.

Amount – Fill in the total amount of the request.

Full Oversight – Is this an FHWA full oversight project? If not certain, contact your Local Programs Engineer.

Public Interest Finding (PIF) Information

Select Type of PIF – Use the pull down menu to select the PIF that fits the project.

Regulatory Reference – This field is automatically filled in when you select the PIF.

Justification or Supporting Information

Goal Statement – What is being accomplished/what is the outcome for the work being completed by local forces.

Description of Work – Provide a detailed description of work to be done by agency forces.

Justification or Supporting Information

Cost Effectiveness Determination

- Attach a detailed estimates of expected Contract Construction and Agency Force costs. Cost for Contract Construction should be based on unit price history. Agency Force cost estimates need to detail labor, equipment, materials, and agency overhead costs (see example).
- The local agency must comply with the appropriate design, construction, and material quality standards.
- The local agency must be able to obtain and document the same level of quality that is required for competitively bid contracts.
- Provide an explanation of cost effectiveness or benefits.

Schedule Issues – Explain how the agency will deliver the project and describe if there is a benefit to the public.

Buy America Compliance

- Steel and iron that is permanently incorporated into the project shall consist of American-made materials, as outlined in the required GSP.
- The local agency must include a provision containing the “Buy-America” requirements in each contract. These general special provisions are included in the WSDOT Amendments and General Special Provisions publication.
- Purchase of foreign steel and iron products by local agencies for installation on a federally funded project is not allowed without an approved Public Interest Finding Form Local Programs, to the limit allowed by the “Buy America” General Special Provision.
- The agency must document the sources of steel and iron by having a “Certification of Materials Origin” on file.

Environmental – N/A

NEPA/SEPA Logical Termini & Independent Utility – N/A

Conclusion

- A brief summary of the overall benefits and cost effectiveness.
- Approval by WSDOT Local Programs is required.
- Approval is dependent on demonstration of overall cost effectiveness and public benefit. The determination is not solely dependent on cost savings.
- At least one signature from the local agency is required.

ATTACHMENT "A"

Cost Effectiveness Determination • Continuation of Justification and Supporting Information

Agency Forces (PIF)

Agency:

Project Name:

Fed Aid Number:

Agency Force Cost

Material Cost			
	Unit Cost	Quantity	Amount
Signs and Posts	100	\$ 620.00	\$ 62,000.00

Labor - Operators wage rate:

Hourly Rate: \$ 30.00

Fringe Benefit (@ 54%): \$ 16.20

Total Labor Rate: \$46.19 per hour

	Labor Cost		Equipment Cost		Total Amount
	Unit cost	Hours	Unit Cost	Hours	
Mobilization (pickup)	\$ 46.19	150	\$ 37.50	150	\$ 12,553.50
ESC Lead	\$ 46.19	15	\$ 37.50	10	\$ 1,067.85
Traffic Control	\$ 46.19	300	\$ 37.50	300	\$ 25,107.00
Remove and disposal of existing signs	\$ 46.19	150	\$ 37.50	75	\$ 9,741.00
SPCC	\$ 46.19	10			\$ 461.90
Total Labor and Equipment costs					\$ 51,743.75

Materials: \$ 62,000.00

Labor: \$ 28,868.75

Equipment cost: \$ 20,062.5

Agency Admin/Overhead cost: \$19% of Labor: \$ 5,485.05

Total Agency Force Cost: \$ 116,416.30

ATTACHMENT "B"
Cost Effectiveness Determination • Continuation of Justification and Supporting Information

Agency Forces (PIF)

Agency:

Project Name:

Fed Aid Number:

Contract Construction Cost

Item	Measure	Unit	Unit Price	Amount
Mobilization	L.S.	1	\$ 20,000.00	\$ 20,000.00
ESC Lead	Day	15	\$ 110.00	\$ 1,650.00
Project Temporary Traffic Control	L.S.	1	\$ 40,000.00	\$ 40,000.00
Permanent Signing	Each	620	\$ 200.00	\$ 124,000.00
Removal & Disposal Existing Signs	L.S.	1	\$ 10,000.00	\$ 10,000.00
SPCC	L.S.	1	\$ 500.00	\$ 500.00
Total Contract Construction Cost:				\$ 196,150.00

Appendix 44.82 Tied Bids – PIF Instructions

Project Information

State/Local Project Number – For WSDOT projects, this is the work order number or WIN. For local projects, this field is for local agency use/tracking.

Project Name – Provide the name of the project as it is listed in the State Transportation Improvement Plan (STIP).

Federal Aid Project Number – This number will be assigned by WSDOT. Contact the Region Local Programs staff to obtain this number.

NEPA Category – Check the appropriate box:

- Environmental Impact Statement (EIS). Refer to [Subsection 24.21](#) of the *Local Agency Guidelines*.
- Categorical Exclusion (CE), Documented Categorical Exclusion (DCE), and Programmatic Categorical Exclusion (Programmatic CE). Refer to [Subsection 24.22](#) of the *Local Agency Guidelines*.
- Environmental Assessment (EA). Refer to [Subsection 24.23](#) of the *Local Agency Guidelines*.

Region or Agency – Fill in with the WSDOT Region or Local Agency requesting the finding.

Amount – Fill in the total amount of the request.

Full Oversight – Is this an FHWA full oversight project? If not certain, contact your Local Programs Engineer.

Public Interest Finding (PIF) Information

Select Type of PIF – Use the pull down menu to select the PIF that fits the project.

Regulatory Reference – This field is automatically filled in when you select the PIF.

Justification or Supporting Information

Goal Statement – What is being accomplished by a tied bid

Description of Work – Provide a detailed description of the work being performed under both contracts. This description should also include a purpose and need statement that explains why the project is being proposed.

Justification or Supporting Information

Cost Effectiveness Determination – Provide an explanation of cost effectiveness or benefits.

Schedule Issues – N/A

Buy America Compliance – N/A

Environmental – Provide documentation to show that the environmental process is complete for each project.

NEPA/SEPA Logical Termini & Independent Utility – Attach a Vicinity Map and/or other plan sheets to show that each project has Logical Termini and Independent Utility.

- Logical termini for project development are defined as (1) rational end points for a transportation improvement, and (2) rational end points for a review of the environmental impacts.
- Independent Utility – A project must be able to function on its own, without further construction of an adjoining segment.

Conclusion

- A brief summary of the overall benefits and cost effectiveness.
- Approval by WSDOT Local Programs is required.
- Approval is dependent on demonstration of overall cost effectiveness and public benefits. The determination is not solely dependent on cost savings.
- At least one signature from the local agency is required.

Appendix 44.83 Public Interest Finding – Example



**Washington State
Department of Transportation**

Public Interest Finding

(Please limit answers to the spaces provided, attached additional sheets as needed)

Project Information		
State/Local Project Number	Project Name	
Federal Aid Project Number	NEPA Category <input type="checkbox"/> CE <input type="checkbox"/> EA <input type="checkbox"/> EIS	NEPA Clearance Date
Region or Agency		
Amount	Full Oversight <input type="checkbox"/> Yes <input type="checkbox"/> No	
Public Interest Finding (PIF) Information		
Select Type of PIF: Select One	Regulatory Reference	
Justification or Supporting Information		
Goal Statement		
Description of Work		

DOT Form 140-050
Revised 12/2018

Cost Effectiveness Determination
Schedule Issues
Buy America Compliance
Environmental
NEPA/SEPA Logical Termini and Independent Utility
Conclusion

Approvals		
Name	Signature	Date
Name	Signature	Date
Name	Signature	Date
Name	Signature	Date

DOT Form 140-050
Revised 12/2018

REQUIRED CONTRACT PROVISIONS FEDERAL-AID CONSTRUCTION CONTRACTS
FHWA-1273 -- Revised May 1, 2012

- I. General
- II. Nondiscrimination
- III. Nonsegregated Facilities
- IV. Davis-Bacon and Related Act Provisions
- V. Contract Work Hours and Safety Standards Act Provisions
- VI. Subletting or Assigning the Contract
- VII. Safety: Accident Prevention
- VIII. False Statements Concerning Highway Projects
- IX. Implementation of Clean Air Act and Federal Water Pollution Control Act
- X. Compliance with Governmentwide Suspension and Debarment Requirements
- XI. Certification Regarding Use of Contract Funds for Lobbying

ATTACHMENTS

A. Employment and Materials Preference for Appalachian Development Highway System or Appalachian Local Access Road Contracts (included in Appalachian contracts only)

I. GENERAL

1. Form FHWA-1273 must be physically incorporated in each construction contract funded under Title 23 (excluding emergency contracts solely intended for debris removal). The contractor (or subcontractor) must insert this form in each subcontract and further require its inclusion in all lower tier subcontracts (excluding purchase orders, rental agreements and other agreements for supplies or services).

The applicable requirements of Form FHWA-1273 are incorporated by reference for work done under any purchase order, rental agreement or agreement for other services. The prime contractor shall be responsible for compliance by any subcontractor, lower-tier subcontractor or service provider.

Form FHWA-1273 must be included in all Federal-aid design-build contracts, in all subcontracts and in lower tier subcontracts (excluding subcontracts for design services, purchase orders, rental agreements and other agreements for supplies or services). The design-builder shall be responsible for compliance by any subcontractor, lower-tier subcontractor or service provider.

Contracting agencies may reference Form FHWA-1273 in bid proposal or request for proposal documents, however, the Form FHWA-1273 must be physically incorporated (not referenced) in all contracts, subcontracts and lower-tier subcontracts (excluding purchase orders, rental agreements and other agreements for supplies or services related to a construction contract).

2. Subject to the applicability criteria noted in the following sections, these contract provisions shall apply to all work performed on the contract by the contractor's own organization and with

the assistance of workers under the contractor's immediate superintendence and to all work performed on the contract by piecework, station work, or by subcontract.

3. A breach of any of the stipulations contained in these Required Contract Provisions may be sufficient grounds for withholding of progress payments, withholding of final payment, termination of the contract, suspension / debarment or any other action determined to be appropriate by the contracting agency and FHWA.

4. Selection of Labor: During the performance of this contract, the contractor shall not use convict labor for any purpose within the limits of a construction project on a Federal-aid highway unless it is labor performed by convicts who are on parole, supervised release, or probation. The term Federal-aid highway does not include roadways functionally classified as local roads or rural minor collectors.

II. NONDISCRIMINATION

The provisions of this section related to 23 CFR Part 230 are applicable to all Federal-aid construction contracts and to all related construction subcontracts of \$10,000 or more. The provisions of 23 CFR Part 230 are not applicable to material supply, engineering, or architectural service contracts.

In addition, the contractor and all subcontractors must comply with the following policies: Executive Order 11246, 41 CFR 60, 29 CFR 1625-1627, Title 23 USC Section 140, the Rehabilitation Act of 1973, as amended (29 USC 794), Title VI of the Civil Rights Act of 1964, as amended, and related regulations including 49 CFR Parts 21, 26 and 27; and 23 CFR Parts 200, 230, and 633.

The contractor and all subcontractors must comply with: the requirements of the Equal Opportunity Clause in 41 CFR 60-1.4(b) and, for all construction contracts exceeding \$10,000, the Standard Federal Equal Employment Opportunity Construction Contract Specifications in 41 CFR 60-4.3.

Note: The U.S. Department of Labor has exclusive authority to determine compliance with Executive Order 11246 and the policies of the Secretary of Labor including 41 CFR 60, and 29 CFR 1625-1627. The contracting agency and the FHWA have the authority and the responsibility to ensure compliance with Title 23 USC Section 140, the Rehabilitation Act of 1973, as amended (29 USC 794), and Title VI of the Civil Rights Act of 1964, as amended, and related regulations including 49 CFR Parts 21, 26 and 27; and 23 CFR Parts 200, 230, and 633.

The following provision is adopted from 23 CFR 230, Appendix A, with appropriate revisions to conform to the U.S. Department of Labor (US DOL) and FHWA requirements.

1. Equal Employment Opportunity: Equal employment opportunity (EEO) requirements not to discriminate and to take affirmative action to assure equal opportunity as set forth under laws, executive orders, rules, regulations (28 CFR 35, 29 CFR 1630, 29 CFR 1625-1627, 41 CFR 60 and 49 CFR 27) and orders of the Secretary of Labor as modified by the provisions prescribed herein, and imposed pursuant to 23 U.S.C. 140 shall constitute the EEO and specific affirmative action standards for the contractor's project activities under this contract. The provisions of the Americans with Disabilities Act of 1990 (42 U.S.C. 12101 et seq.) set forth under 28 CFR 35 and 29 CFR 1630 are incorporated by reference in this contract. In the execution of this

contract, the contractor agrees to comply with the following minimum specific requirement activities of EEO:

a. The contractor will work with the contracting agency and the Federal Government to ensure that it has made every good faith effort to provide equal opportunity with respect to all of its terms and conditions of employment and in their review of activities under the contract.

b. The contractor will accept as its operating policy the following statement:

"It is the policy of this Company to assure that applicants are employed, and that employees are treated during employment, without regard to their race, religion, sex, color, national origin, age or disability. Such action shall include: employment, upgrading, demotion, or transfer; recruitment or recruitment advertising; layoff or termination; rates of pay or other forms of compensation; and selection for training, including apprenticeship, pre-apprenticeship, and/or on-the-job training."

2. EEO Officer: The contractor will designate and make known to the contracting officers an EEO Officer who will have the responsibility for and must be capable of effectively administering and promoting an active EEO program and who must be assigned adequate authority and responsibility to do so.

3. Dissemination of Policy: All members of the contractor's staff who are authorized to hire, supervise, promote, and discharge employees, or who recommend such action, or who are substantially involved in such action, will be made fully cognizant of, and will implement, the contractor's EEO policy and contractual responsibilities to provide EEO in each grade and classification of employment. To ensure that the above agreement will be met, the following actions will be taken as a minimum:

a. Periodic meetings of supervisory and personnel office employees will be conducted before the start of work and then not less often than once every six months, at which time the contractor's EEO policy and its implementation will be reviewed and explained. The meetings will be conducted by the EEO Officer.

b. All new supervisory or personnel office employees will be given a thorough indoctrination by the EEO Officer, covering all major aspects of the contractor's EEO obligations within thirty days following their reporting for duty with the contractor.

c. All personnel who are engaged in direct recruitment for the project will be instructed by the EEO Officer in the contractor's procedures for locating and hiring minorities and women.

d. Notices and posters setting forth the contractor's EEO policy will be placed in areas readily accessible to employees, applicants for employment and potential employees.

e. The contractor's EEO policy and the procedures to implement such policy will be brought to the attention of employees by means of meetings, employee handbooks, or other appropriate means.

4. Recruitment: When advertising for employees, the contractor will include in all advertisements for employees the notation: "An Equal Opportunity Employer." All such advertisements will be placed in publications having a large circulation among minorities and women in the area from which the project work force would normally be derived.

a. The contractor will, unless precluded by a valid bargaining agreement, conduct systematic and direct recruitment through public and private employee referral sources likely to yield qualified minorities and women. To meet this requirement, the contractor will identify sources of potential minority group employees, and establish with such identified sources procedures whereby minority and women applicants may be referred to the contractor for employment consideration.

b. In the event the contractor has a valid bargaining agreement providing for exclusive hiring hall referrals, the contractor is expected to observe the provisions of that agreement to the extent that the system meets the contractor's compliance with EEO contract provisions. Where implementation of such an agreement has the effect of discriminating against minorities or women, or obligates the contractor to do the same, such implementation violates Federal nondiscrimination provisions.

c. The contractor will encourage its present employees to refer minorities and women as applicants for employment. Information and procedures with regard to referring such applicants will be discussed with employees.

5. Personnel Actions: Wages, working conditions, and employee benefits shall be established and administered, and personnel actions of every type, including hiring, upgrading, promotion, transfer, demotion, layoff, and termination, shall be taken without regard to race, color, religion, sex, national origin, age or disability. The following procedures shall be followed:

a. The contractor will conduct periodic inspections of project sites to insure that working conditions and employee facilities do not indicate discriminatory treatment of project site personnel.

b. The contractor will periodically evaluate the spread of wages paid within each classification to determine any evidence of discriminatory wage practices.

c. The contractor will periodically review selected personnel actions in depth to determine whether there is evidence of discrimination. Where evidence is found, the contractor will promptly take corrective action. If the review indicates that the discrimination may extend beyond the actions reviewed, such corrective action shall include all affected persons.

d. The contractor will promptly investigate all complaints of alleged discrimination made to the contractor in connection with its obligations under this contract, will attempt to resolve such complaints, and will take appropriate corrective action within a reasonable time. If the investigation indicates that the discrimination may affect persons other than the complainant, such corrective action shall include such other persons. Upon completion of each investigation, the contractor will inform every complainant of all of their avenues of appeal.

6. Training and Promotion:

a. The contractor will assist in locating, qualifying, and increasing the skills of minorities and women who are applicants for employment or current employees. Such efforts should be aimed at developing full journey level status employees in the type of trade or job classification involved.

b. Consistent with the contractor's work force requirements and as permissible under Federal and State regulations, the contractor shall make full use of training programs, i.e., apprenticeship, and on-the-job training programs for the geographical area of contract performance. In the event a special provision for training is provided under this contract, this subparagraph will be superseded as indicated in the special provision. The contracting agency may reserve training positions for persons who receive welfare assistance in accordance with 23 U.S.C. 140(a).

c. The contractor will advise employees and applicants for employment of available training programs and entrance requirements for each.

d. The contractor will periodically review the training and promotion potential of employees who are minorities and women and will encourage eligible employees to apply for such training and promotion.

7. Unions: If the contractor relies in whole or in part upon unions as a source of employees, the contractor will use good faith efforts to obtain the cooperation of such unions to increase opportunities for minorities and women. Actions by the contractor, either directly or through a contractor's association acting as agent, will include the procedures set forth below:

a. The contractor will use good faith efforts to develop, in cooperation with the unions, joint training programs aimed toward qualifying more minorities and women for membership in the unions and increasing the skills of minorities and women so that they may qualify for higher paying employment.

b. The contractor will use good faith efforts to incorporate an EEO clause into each union agreement to the end that such union will be contractually bound to refer applicants without regard to their race, color, religion, sex, national origin, age or disability.

c. The contractor is to obtain information as to the referral practices and policies of the labor union except that to the extent such information is within the exclusive possession of the labor union and such labor union refuses to furnish such information to the contractor, the contractor shall so certify to the contracting agency and shall set forth what efforts have been made to obtain such information.

d. In the event the union is unable to provide the contractor with a reasonable flow of referrals within the time limit set forth in the collective bargaining agreement, the contractor will, through independent recruitment efforts, fill the employment vacancies without regard to race, color, religion, sex, national origin, age or disability; making full efforts to obtain qualified and/or qualifiable minorities and women. The failure of a union to provide sufficient referrals (even though it is obligated to provide exclusive referrals under the terms of a collective bargaining agreement) does not relieve the contractor from the requirements of this paragraph. In the event the union referral practice prevents the contractor from meeting the obligations pursuant to Executive Order 11246, as amended, and these special provisions, such contractor shall immediately notify the contracting agency.

8. Reasonable Accommodation for Applicants / Employees with Disabilities: The contractor must be familiar with the requirements for and comply with the Americans with Disabilities Act and all rules and regulations established there under. Employers must provide reasonable accommodation in all employment activities unless to do so would cause an undue hardship.

9. Selection of Subcontractors, Procurement of Materials and Leasing of Equipment: The contractor shall not discriminate on the grounds of race, color, religion, sex, national origin, age or disability in the selection and retention of subcontractors, including procurement of materials and leases of equipment. The contractor shall take all necessary and reasonable steps to ensure nondiscrimination in the administration of this contract.

a. The contractor shall notify all potential subcontractors and suppliers and lessors of their EEO obligations under this contract.

b. The contractor will use good faith efforts to ensure subcontractor compliance with their EEO obligations.

10. Assurance Required by 49 CFR 26.13(b):

a. The requirements of 49 CFR Part 26 and the State DOT's U.S. DOT-approved DBE program are incorporated by reference.

b. The contractor or subcontractor shall not discriminate on the basis of race, color, national origin, or sex in the performance of this contract. The contractor shall carry out applicable requirements of 49 CFR Part 26 in the award and administration of DOT-assisted contracts. Failure by the contractor to carry out these requirements is a material breach of this contract, which may result in the termination of this contract or such other remedy as the contracting agency deems appropriate.

11. Records and Reports: The contractor shall keep such records as necessary to document compliance with the EEO requirements. Such records shall be retained for a period of three years following the date of the final payment to the contractor for all contract work and shall be available at reasonable times and places for inspection by authorized representatives of the contracting agency and the FHWA.

a. The records kept by the contractor shall document the following:

(1) The number and work hours of minority and non-minority group members and women employed in each work classification on the project;

(2) The progress and efforts being made in cooperation with unions, when applicable, to increase employment opportunities for minorities and women; and

(3) The progress and efforts being made in locating, hiring, training, qualifying, and upgrading minorities and women;

b. The contractors and subcontractors will submit an annual report to the contracting agency each July for the duration of the project, indicating the number of minority, women, and non-minority group employees currently engaged in each work classification required by the contract work. This information is to be reported on [Form FHWA-1391](#). The staffing data should represent the project work force on board in all or any part of the last payroll period preceding the end of July. If on-the-job training is being required by special provision, the contractor will be required to collect and report training data. The employment data should reflect the work force on board during all or any part of the last payroll period preceding the end of July.

III. NONSEGREGATED FACILITIES

This provision is applicable to all Federal-aid construction contracts and to all related construction subcontracts of \$10,000 or more.

The contractor must ensure that facilities provided for employees are provided in such a manner that segregation on the basis of race, color, religion, sex, or national origin cannot result. The contractor may neither require such segregated use by written or oral policies nor tolerate such use by employee custom. The contractor's obligation extends further to ensure that its employees are not assigned to perform their services at any location, under the contractor's control, where the facilities are segregated. The term "facilities" includes waiting rooms, work areas, restaurants and other eating areas, time clocks, restrooms, washrooms, locker rooms, and other storage or dressing areas, parking lots, drinking fountains, recreation or entertainment areas, transportation, and housing provided for employees. The contractor shall provide separate or single-user restrooms and necessary dressing or sleeping areas to assure privacy between sexes.

IV. DAVIS-BACON AND RELATED ACT PROVISIONS

This section is applicable to all Federal-aid construction projects exceeding \$2,000 and to all related subcontracts and lower-tier subcontracts (regardless of subcontract size). The requirements apply to all projects located within the right-of-way of a roadway that is functionally classified as Federal-aid highway. This excludes roadways functionally classified as local roads or rural minor collectors, which are exempt. Contracting agencies may elect to apply these requirements to other projects.

The following provisions are from the U.S. Department of Labor regulations in 29 CFR 5.5 "Contract provisions and related matters" with minor revisions to conform to the FHWA-1273 format and FHWA program requirements.

1. Minimum wages

a. All laborers and mechanics employed or working upon the site of the work, will be paid unconditionally and not less often than once a week, and without subsequent deduction or rebate on any account (except such payroll deductions as are permitted by regulations issued by the Secretary of Labor under the Copeland Act (29 CFR part 3)), the full amount of wages and bona fide fringe benefits (or cash equivalents thereof) due at time of payment computed at rates not less than those contained in the wage determination of the Secretary of Labor which is attached hereto and made a part hereof, regardless of any contractual relationship which may be alleged to exist between the contractor and such laborers and mechanics.

Contributions made or costs reasonably anticipated for bona fide fringe benefits under section 1(b)(2) of the Davis-Bacon Act on behalf of laborers or mechanics are considered wages paid to such laborers or mechanics, subject to the provisions of paragraph 1.d. of this section; also, regular contributions made or costs incurred for more than a weekly period (but not less often than quarterly) under plans, funds, or programs which cover the particular weekly period, are deemed to be constructively made or incurred during such weekly period. Such laborers and

mechanics shall be paid the appropriate wage rate and fringe benefits on the wage determination for the classification of work actually performed, without regard to skill, except as provided in 29 CFR 5.5(a)(4). Laborers or mechanics performing work in more than one classification may be compensated at the rate specified for each classification for the time actually worked therein: Provided, That the employer's payroll records accurately set forth the time spent in each classification in which work is performed. The wage determination (including any additional classification and wage rates conformed under paragraph 1.b. of this section) and the Davis-Bacon poster (WH-1321) shall be posted at all times by the contractor and its subcontractors at the site of the work in a prominent and accessible place where it can be easily seen by the workers.

b. (1) The contracting officer shall require that any class of laborers or mechanics, including helpers, which is not listed in the wage determination and which is to be employed under the contract shall be classified in conformance with the wage determination. The contracting officer shall approve an additional classification and wage rate and fringe benefits therefore only when the following criteria have been met:

(i) The work to be performed by the classification requested is not performed by a classification in the wage determination; and

(ii) The classification is utilized in the area by the construction industry; and

(iii) The proposed wage rate, including any bona fide fringe benefits, bears a reasonable relationship to the wage rates contained in the wage determination.

(2) If the contractor and the laborers and mechanics to be employed in the classification (if known), or their representatives, and the contracting officer agree on the classification and wage rate (including the amount designated for fringe benefits where appropriate), a report of the action taken shall be sent by the contracting officer to the Administrator of the Wage and Hour Division, Employment Standards Administration, U.S. Department of Labor, Washington, DC 20210. The Administrator, or an authorized representative, will approve, modify, or disapprove every additional classification action within 30 days of receipt and so advise the contracting officer or will notify the contracting officer within the 30-day period that additional time is necessary.

(3) In the event the contractor, the laborers or mechanics to be employed in the classification or their representatives, and the contracting officer do not agree on the proposed classification and wage rate (including the amount designated for fringe benefits, where appropriate), the contracting officer shall refer the questions, including the views of all interested parties and the recommendation of the contracting officer, to the Wage and Hour Administrator for determination. The Wage and Hour Administrator, or an authorized representative, will issue a determination within 30 days of receipt and so advise the contracting officer or will notify the contracting officer within the 30-day period that additional time is necessary.

(4) The wage rate (including fringe benefits where appropriate) determined pursuant to paragraphs 1.b.(2) or 1.b.(3) of this section, shall be paid to all workers performing work in the classification under this contract from the first day on which work is performed in the classification.

c. Whenever the minimum wage rate prescribed in the contract for a class of laborers or mechanics includes a fringe benefit which is not expressed as an hourly rate, the contractor shall either pay the benefit as stated in the wage determination or shall pay another bona fide fringe benefit or an hourly cash equivalent thereof.

d. If the contractor does not make payments to a trustee or other third person, the contractor may consider as part of the wages of any laborer or mechanic the amount of any costs reasonably anticipated in providing bona fide fringe benefits under a plan or program, Provided, That the Secretary of Labor has found, upon the written request of the contractor, that the applicable standards of the Davis-Bacon Act have been met. The Secretary of Labor may require the contractor to set aside in a separate account assets for the meeting of obligations under the plan or program.

2. Withholding

The contracting agency shall upon its own action or upon written request of an authorized representative of the Department of Labor, withhold or cause to be withheld from the contractor under this contract, or any other Federal contract with the same prime contractor, or any other federally-assisted contract subject to Davis-Bacon prevailing wage requirements, which is held by the same prime contractor, so much of the accrued payments or advances as may be considered necessary to pay laborers and mechanics, including apprentices, trainees, and helpers, employed by the contractor or any subcontractor the full amount of wages required by the contract. In the event of failure to pay any laborer or mechanic, including any apprentice, trainee, or helper, employed or working on the site of the work, all or part of the wages required by the contract, the contracting agency may, after written notice to the contractor, take such action as may be necessary to cause the suspension of any further payment, advance, or guarantee of funds until such violations have ceased.

3. Payrolls and basic records

a. Payrolls and basic records relating thereto shall be maintained by the contractor during the course of the work and preserved for a period of three years thereafter for all laborers and mechanics working at the site of the work. Such records shall contain the name, address, and social security number of each such worker, his or her correct classification, hourly rates of wages paid (including rates of contributions or costs anticipated for bona fide fringe benefits or cash equivalents thereof of the types described in section 1(b)(2)(B) of the Davis-Bacon Act), daily and weekly number of hours worked, deductions made and actual wages paid. Whenever the Secretary of Labor has found under 29 CFR 5.5(a)(1)(iv) that the wages of any laborer or mechanic include the amount of any costs reasonably anticipated in providing benefits under a plan or program described in section 1(b)(2)(B) of the Davis-Bacon Act, the contractor shall maintain records which show that the commitment to provide such benefits is enforceable, that the plan or program is financially responsible, and that the plan or program has been communicated in writing to the laborers or mechanics affected, and records which show the costs anticipated or the actual cost incurred in providing such benefits. Contractors employing apprentices or trainees under approved programs shall maintain written evidence of the registration of apprenticeship programs and certification of trainee programs, the registration of the apprentices and trainees, and the ratios and wage rates prescribed in the applicable programs.

b. (1) The contractor shall submit weekly for each week in which any contract work is performed a copy of all payrolls to the contracting agency. The payrolls submitted shall set out accurately and completely all of the information required to be maintained under 29 CFR 5.5(a)(3)(i), except that full social security numbers and home addresses shall not be included on weekly transmittals. Instead the payrolls shall only need to include an individually identifying number for each employee (e.g. , the last four digits of the employee's social security number). The required weekly payroll information may be submitted in any form desired. Optional Form WH-347 is available for this purpose from the Wage and Hour Division Web site at <http://www.dol.gov/esa/whd/forms/wh347instr.htm> or its successor site. The prime contractor is responsible for the submission of copies of payrolls by all subcontractors. Contractors and subcontractors shall maintain the full social security number and current address of each covered worker, and shall provide them upon request to the contracting agency for transmission to the State DOT, the FHWA or the Wage and Hour Division of the Department of Labor for purposes of an investigation or audit of compliance with prevailing wage requirements. It is not a violation of this section for a prime contractor to require a subcontractor to provide addresses and social security numbers to the prime contractor for its own records, without weekly submission to the contracting agency..

(2) Each payroll submitted shall be accompanied by a "Statement of Compliance," signed by the contractor or subcontractor or his or her agent who pays or supervises the payment of the persons employed under the contract and shall certify the following:

(i) That the payroll for the payroll period contains the information required to be provided under §5.5 (a)(3)(ii) of Regulations, 29 CFR part 5, the appropriate information is being maintained under §5.5 (a)(3)(i) of Regulations, 29 CFR part 5, and that such information is correct and complete;

(ii) That each laborer or mechanic (including each helper, apprentice, and trainee) employed on the contract during the payroll period has been paid the full weekly wages earned, without rebate, either directly or indirectly, and that no deductions have been made either directly or indirectly from the full wages earned, other than permissible deductions as set forth in Regulations, 29 CFR part 3;

(iii) That each laborer or mechanic has been paid not less than the applicable wage rates and fringe benefits or cash equivalents for the classification of work performed, as specified in the applicable wage determination incorporated into the contract.

(3) The weekly submission of a properly executed certification set forth on the reverse side of Optional Form WH-347 shall satisfy the requirement for submission of the "Statement of Compliance" required by paragraph 3.b.(2) of this section.

(4) The falsification of any of the above certifications may subject the contractor or subcontractor to civil or criminal prosecution under section 1001 of title 18 and section 231 of title 31 of the United States Code.

c. The contractor or subcontractor shall make the records required under paragraph 3.a. of this section available for inspection, copying, or transcription by authorized representatives of the contracting agency, the State DOT, the FHWA, or the Department of Labor, and shall permit such representatives to interview employees during working hours on the job. If the contractor or subcontractor fails to submit the required records or to make them available, the FHWA may,

after written notice to the contractor, the contracting agency or the State DOT, take such action as may be necessary to cause the suspension of any further payment, advance, or guarantee of funds. Furthermore, failure to submit the required records upon request or to make such records available may be grounds for debarment action pursuant to 29 CFR 5.12.

4. Apprentices and trainees

a. Apprentices (programs of the USDOL).

Apprentices will be permitted to work at less than the predetermined rate for the work they performed when they are employed pursuant to and individually registered in a bona fide apprenticeship program registered with the U.S. Department of Labor, Employment and Training Administration, Office of Apprenticeship Training, Employer and Labor Services, or with a State Apprenticeship Agency recognized by the Office, or if a person is employed in his or her first 90 days of probationary employment as an apprentice in such an apprenticeship program, who is not individually registered in the program, but who has been certified by the Office of Apprenticeship Training, Employer and Labor Services or a State Apprenticeship Agency (where appropriate) to be eligible for probationary employment as an apprentice.

The allowable ratio of apprentices to journeymen on the job site in any craft classification shall not be greater than the ratio permitted to the contractor as to the entire work force under the registered program. Any worker listed on a payroll at an apprentice wage rate, who is not registered or otherwise employed as stated above, shall be paid not less than the applicable wage rate on the wage determination for the classification of work actually performed. In addition, any apprentice performing work on the job site in excess of the ratio permitted under the registered program shall be paid not less than the applicable wage rate on the wage determination for the work actually performed. Where a contractor is performing construction on a project in a locality other than that in which its program is registered, the ratios and wage rates (expressed in percentages of the journeyman's hourly rate) specified in the contractor's or subcontractor's registered program shall be observed.

Every apprentice must be paid at not less than the rate specified in the registered program for the apprentice's level of progress, expressed as a percentage of the journeymen hourly rate specified in the applicable wage determination. Apprentices shall be paid fringe benefits in accordance with the provisions of the apprenticeship program. If the apprenticeship program does not specify fringe benefits, apprentices must be paid the full amount of fringe benefits listed on the wage determination for the applicable classification. If the Administrator determines that a different practice prevails for the applicable apprentice classification, fringes shall be paid in accordance with that determination.

In the event the Office of Apprenticeship Training, Employer and Labor Services, or a State Apprenticeship Agency recognized by the Office, withdraws approval of an apprenticeship program, the contractor will no longer be permitted to utilize apprentices at less than the applicable predetermined rate for the work performed until an acceptable program is approved.

b. Trainees (programs of the USDOL).

Except as provided in 29 CFR 5.16, trainees will not be permitted to work at less than the predetermined rate for the work performed unless they are employed pursuant to and

individually registered in a program which has received prior approval, evidenced by formal certification by the U.S. Department of Labor, Employment and Training Administration.

The ratio of trainees to journeymen on the job site shall not be greater than permitted under the plan approved by the Employment and Training Administration.

Every trainee must be paid at not less than the rate specified in the approved program for the trainee's level of progress, expressed as a percentage of the journeyman hourly rate specified in the applicable wage determination. Trainees shall be paid fringe benefits in accordance with the provisions of the trainee program. If the trainee program does not mention fringe benefits, trainees shall be paid the full amount of fringe benefits listed on the wage determination unless the Administrator of the Wage and Hour Division determines that there is an apprenticeship program associated with the corresponding journeyman wage rate on the wage determination which provides for less than full fringe benefits for apprentices. Any employee listed on the payroll at a trainee rate who is not registered and participating in a training plan approved by the Employment and Training Administration shall be paid not less than the applicable wage rate on the wage determination for the classification of work actually performed. In addition, any trainee performing work on the job site in excess of the ratio permitted under the registered program shall be paid not less than the applicable wage rate on the wage determination for the work actually performed.

In the event the Employment and Training Administration withdraws approval of a training program, the contractor will no longer be permitted to utilize trainees at less than the applicable predetermined rate for the work performed until an acceptable program is approved.

c. Equal employment opportunity. The utilization of apprentices, trainees and journeymen under this part shall be in conformity with the equal employment opportunity requirements of Executive Order 11246, as amended, and 29 CFR part 30.

d. Apprentices and Trainees (programs of the U.S. DOT).

Apprentices and trainees working under apprenticeship and skill training programs which have been certified by the Secretary of Transportation as promoting EEO in connection with Federal-aid highway construction programs are not subject to the requirements of paragraph 4 of this Section IV. The straight time hourly wage rates for apprentices and trainees under such programs will be established by the particular programs. The ratio of apprentices and trainees to journeymen shall not be greater than permitted by the terms of the particular program.

5. Compliance with Copeland Act requirements. The contractor shall comply with the requirements of 29 CFR part 3, which are incorporated by reference in this contract.

6. Subcontracts. The contractor or subcontractor shall insert Form FHWA-1273 in any subcontracts and also require the subcontractors to include Form FHWA-1273 in any lower tier subcontracts. The prime contractor shall be responsible for the compliance by any subcontractor or lower tier subcontractor with all the contract clauses in 29 CFR 5.5.

7. Contract termination: debarment. A breach of the contract clauses in 29 CFR 5.5 may be grounds for termination of the contract, and for debarment as a contractor and a subcontractor as provided in 29 CFR 5.12.

8. Compliance with Davis-Bacon and Related Act requirements. All rulings and interpretations of the Davis-Bacon and Related Acts contained in 29 CFR parts 1, 3, and 5 are herein incorporated by reference in this contract.

9. Disputes concerning labor standards. Disputes arising out of the labor standards provisions of this contract shall not be subject to the general disputes clause of this contract. Such disputes shall be resolved in accordance with the procedures of the Department of Labor set forth in 29 CFR parts 5, 6, and 7. Disputes within the meaning of this clause include disputes between the contractor (or any of its subcontractors) and the contracting agency, the U.S. Department of Labor, or the employees or their representatives.

10. Certification of eligibility.

a. By entering into this contract, the contractor certifies that neither it (nor he or she) nor any person or firm who has an interest in the contractor's firm is a person or firm ineligible to be awarded Government contracts by virtue of section 3(a) of the Davis-Bacon Act or 29 CFR 5.12(a)(1).

b. No part of this contract shall be subcontracted to any person or firm ineligible for award of a Government contract by virtue of section 3(a) of the Davis-Bacon Act or 29 CFR 5.12(a)(1).

c. The penalty for making false statements is prescribed in the U.S. Criminal Code, 18 U.S.C. 1001.

V. CONTRACT WORK HOURS AND SAFETY STANDARDS ACT

The following clauses apply to any Federal-aid construction contract in an amount in excess of \$100,000 and subject to the overtime provisions of the Contract Work Hours and Safety Standards Act. These clauses shall be inserted in addition to the clauses required by 29 CFR 5.5(a) or 29 CFR 4.6. As used in this paragraph, the terms laborers and mechanics include watchmen and guards.

1. Overtime requirements. No contractor or subcontractor contracting for any part of the contract work which may require or involve the employment of laborers or mechanics shall require or permit any such laborer or mechanic in any workweek in which he or she is employed on such work to work in excess of forty hours in such workweek unless such laborer or mechanic receives compensation at a rate not less than one and one-half times the basic rate of pay for all hours worked in excess of forty hours in such workweek.

2. Violation; liability for unpaid wages; liquidated damages. In the event of any violation of the clause set forth in paragraph (1.) of this section, the contractor and any subcontractor responsible therefor shall be liable for the unpaid wages. In addition, such contractor and subcontractor shall be liable to the United States (in the case of work done under contract for the District of Columbia or a territory, to such District or to such territory), for liquidated damages. Such liquidated damages shall be computed with respect to each individual laborer or mechanic, including watchmen and guards, employed in violation of the clause set forth in paragraph (1.) of this section, in the sum of \$10 for each calendar day on which such individual

was required or permitted to work in excess of the standard workweek of forty hours without payment of the overtime wages required by the clause set forth in paragraph (1.) of this section.

3. Withholding for unpaid wages and liquidated damages. The FHWA or the contracting agency shall upon its own action or upon written request of an authorized representative of the Department of Labor withhold or cause to be withheld, from any moneys payable on account of work performed by the contractor or subcontractor under any such contract or any other Federal contract with the same prime contractor, or any other federally-assisted contract subject to the Contract Work Hours and Safety Standards Act, which is held by the same prime contractor, such sums as may be determined to be necessary to satisfy any liabilities of such contractor or subcontractor for unpaid wages and liquidated damages as provided in the clause set forth in paragraph (2.) of this section.

4. Subcontracts. The contractor or subcontractor shall insert in any subcontracts the clauses set forth in paragraph (1.) through (4.) of this section and also a clause requiring the subcontractors to include these clauses in any lower tier subcontracts. The prime contractor shall be responsible for compliance by any subcontractor or lower tier subcontractor with the clauses set forth in paragraphs (1.) through (4.) of this section.

VI. SUBLETTING OR ASSIGNING THE CONTRACT

This provision is applicable to all Federal-aid construction contracts on the National Highway System.

1. The contractor shall perform with its own organization contract work amounting to not less than 30 percent (or a greater percentage if specified elsewhere in the contract) of the total original contract price, excluding any specialty items designated by the contracting agency. Specialty items may be performed by subcontract and the amount of any such specialty items performed may be deducted from the total original contract price before computing the amount of work required to be performed by the contractor's own organization (23 CFR 635.116).

a. The term "perform work with its own organization" refers to workers employed or leased by the prime contractor, and equipment owned or rented by the prime contractor, with or without operators. Such term does not include employees or equipment of a subcontractor or lower tier subcontractor, agents of the prime contractor, or any other assignees. The term may include payments for the costs of hiring leased employees from an employee leasing firm meeting all relevant Federal and State regulatory requirements. Leased employees may only be included in this term if the prime contractor meets all of the following conditions:

- (1) the prime contractor maintains control over the supervision of the day-to-day activities of the leased employees;
- (2) the prime contractor remains responsible for the quality of the work of the leased employees;
- (3) the prime contractor retains all power to accept or exclude individual employees from work on the project; and

(4) the prime contractor remains ultimately responsible for the payment of predetermined minimum wages, the submission of payrolls, statements of compliance and all other Federal regulatory requirements.

b. "Specialty Items" shall be construed to be limited to work that requires highly specialized knowledge, abilities, or equipment not ordinarily available in the type of contracting organizations qualified and expected to bid or propose on the contract as a whole and in general are to be limited to minor components of the overall contract.

2. The contract amount upon which the requirements set forth in paragraph (1) of Section VI is computed includes the cost of material and manufactured products which are to be purchased or produced by the contractor under the contract provisions.

3. The contractor shall furnish (a) a competent superintendent or supervisor who is employed by the firm, has full authority to direct performance of the work in accordance with the contract requirements, and is in charge of all construction operations (regardless of who performs the work) and (b) such other of its own organizational resources (supervision, management, and engineering services) as the contracting officer determines is necessary to assure the performance of the contract.

4. No portion of the contract shall be sublet, assigned or otherwise disposed of except with the written consent of the contracting officer, or authorized representative, and such consent when given shall not be construed to relieve the contractor of any responsibility for the fulfillment of the contract. Written consent will be given only after the contracting agency has assured that each subcontract is evidenced in writing and that it contains all pertinent provisions and requirements of the prime contract.

5. The 30% self-performance requirement of paragraph (1) is not applicable to design-build contracts; however, contracting agencies may establish their own self-performance requirements.

VII. SAFETY: ACCIDENT PREVENTION

This provision is applicable to all Federal-aid construction contracts and to all related subcontracts.

1. In the performance of this contract the contractor shall comply with all applicable Federal, State, and local laws governing safety, health, and sanitation (23 CFR 635). The contractor shall provide all safeguards, safety devices and protective equipment and take any other needed actions as it determines, or as the contracting officer may determine, to be reasonably necessary to protect the life and health of employees on the job and the safety of the public and to protect property in connection with the performance of the work covered by the contract.

2. It is a condition of this contract, and shall be made a condition of each subcontract, which the contractor enters into pursuant to this contract, that the contractor and any subcontractor shall not permit any employee, in performance of the contract, to work in surroundings or under conditions which are unsanitary, hazardous or dangerous to his/her health or safety, as determined under construction safety and health standards (29 CFR 1926) promulgated by the Secretary of Labor, in accordance with Section 107 of the Contract Work Hours and Safety Standards Act (40 U.S.C. 3704).

3. Pursuant to 29 CFR 1926.3, it is a condition of this contract that the Secretary of Labor or authorized representative thereof, shall have right of entry to any site of contract performance to inspect or investigate the matter of compliance with the construction safety and health standards and to carry out the duties of the Secretary under Section 107 of the Contract Work Hours and Safety Standards Act (40 U.S.C.3704).

VIII. FALSE STATEMENTS CONCERNING HIGHWAY PROJECTS

This provision is applicable to all Federal-aid construction contracts and to all related subcontracts.

In order to assure high quality and durable construction in conformity with approved plans and specifications and a high degree of reliability on statements and representations made by engineers, contractors, suppliers, and workers on Federal-aid highway projects, it is essential that all persons concerned with the project perform their functions as carefully, thoroughly, and honestly as possible. Willful falsification, distortion, or misrepresentation with respect to any facts related to the project is a violation of Federal law. To prevent any misunderstanding regarding the seriousness of these and similar acts, Form FHWA-1022 shall be posted on each Federal-aid highway project (23 CFR 635) in one or more places where it is readily available to all persons concerned with the project:

18 U.S.C. 1020 reads as follows:

"Whoever, being an officer, agent, or employee of the United States, or of any State or Territory, or whoever, whether a person, association, firm, or corporation, knowingly makes any false statement, false representation, or false report as to the character, quality, quantity, or cost of the material used or to be used, or the quantity or quality of the work performed or to be performed, or the cost thereof in connection with the submission of plans, maps, specifications, contracts, or costs of construction on any highway or related project submitted for approval to the Secretary of Transportation; or

Whoever knowingly makes any false statement, false representation, false report or false claim with respect to the character, quality, quantity, or cost of any work performed or to be performed, or materials furnished or to be furnished, in connection with the construction of any highway or related project approved by the Secretary of Transportation; or

Whoever knowingly makes any false statement or false representation as to material fact in any statement, certificate, or report submitted pursuant to provisions of the Federal-aid Roads Act approved July 1, 1916, (39 Stat. 355), as amended and supplemented;

Shall be fined under this title or imprisoned not more than 5 years or both."

IX. IMPLEMENTATION OF CLEAN AIR ACT AND FEDERAL WATER POLLUTION CONTROL ACT

This provision is applicable to all Federal-aid construction contracts and to all related subcontracts.

By submission of this bid/proposal or the execution of this contract, or subcontract, as appropriate, the bidder, proposer, Federal-aid construction contractor, or subcontractor, as appropriate, will be deemed to have stipulated as follows:

1. That any person who is or will be utilized in the performance of this contract is not prohibited from receiving an award due to a violation of Section 508 of the Clean Water Act or Section 306 of the Clean Air Act.
2. That the contractor agrees to include or cause to be included the requirements of paragraph (1) of this Section X in every subcontract, and further agrees to take such action as the contracting agency may direct as a means of enforcing such requirements.

X. CERTIFICATION REGARDING DEBARMENT, SUSPENSION, INELIGIBILITY AND VOLUNTARY EXCLUSION

This provision is applicable to all Federal-aid construction contracts, design-build contracts, subcontracts, lower-tier subcontracts, purchase orders, lease agreements, consultant contracts or any other covered transaction requiring FHWA approval or that is estimated to cost \$25,000 or more – as defined in 2 CFR Parts 180 and 1200.

1. Instructions for Certification – First Tier Participants:

- a. By signing and submitting this proposal, the prospective first tier participant is providing the certification set out below.
- b. The inability of a person to provide the certification set out below will not necessarily result in denial of participation in this covered transaction. The prospective first tier participant shall submit an explanation of why it cannot provide the certification set out below. The certification or explanation will be considered in connection with the department or agency's determination whether to enter into this transaction. However, failure of the prospective first tier participant to furnish a certification or an explanation shall disqualify such a person from participation in this transaction.
- c. The certification in this clause is a material representation of fact upon which reliance was placed when the contracting agency determined to enter into this transaction. If it is later determined that the prospective participant knowingly rendered an erroneous certification, in addition to other remedies available to the Federal Government, the contracting agency may terminate this transaction for cause of default.
- d. The prospective first tier participant shall provide immediate written notice to the contracting agency to whom this proposal is submitted if any time the prospective first tier participant learns that its certification was erroneous when submitted or has become erroneous by reason of changed circumstances.
- e. The terms "covered transaction," "debarred," "suspended," "ineligible," "participant," "person," "principal," and "voluntarily excluded," as used in this clause, are defined in 2 CFR Parts 180 and 1200. "First Tier Covered Transactions" refers to any covered transaction between a grantee or subgrantee of Federal funds and a participant (such as the prime or

general contract). "Lower Tier Covered Transactions" refers to any covered transaction under a First Tier Covered Transaction (such as subcontracts). "First Tier Participant" refers to the participant who has entered into a covered transaction with a grantee or subgrantee of Federal funds (such as the prime or general contractor). "Lower Tier Participant" refers any participant who has entered into a covered transaction with a First Tier Participant or other Lower Tier Participants (such as subcontractors and suppliers).

f. The prospective first tier participant agrees by submitting this proposal that, should the proposed covered transaction be entered into, it shall not knowingly enter into any lower tier covered transaction with a person who is debarred, suspended, declared ineligible, or voluntarily excluded from participation in this covered transaction, unless authorized by the department or agency entering into this transaction.

g. The prospective first tier participant further agrees by submitting this proposal that it will include the clause titled "Certification Regarding Debarment, Suspension, Ineligibility and Voluntary Exclusion-Lower Tier Covered Transactions," provided by the department or contracting agency, entering into this covered transaction, without modification, in all lower tier covered transactions and in all solicitations for lower tier covered transactions exceeding the \$25,000 threshold.

h. A participant in a covered transaction may rely upon a certification of a prospective participant in a lower tier covered transaction that is not debarred, suspended, ineligible, or voluntarily excluded from the covered transaction, unless it knows that the certification is erroneous. A participant is responsible for ensuring that its principals are not suspended, debarred, or otherwise ineligible to participate in covered transactions. To verify the eligibility of its principals, as well as the eligibility of any lower tier prospective participants, each participant may, but is not required to, check the Excluded Parties List System website (<https://www.epls.gov/>), which is compiled by the General Services Administration.

i. Nothing contained in the foregoing shall be construed to require the establishment of a system of records in order to render in good faith the certification required by this clause. The knowledge and information of the prospective participant is not required to exceed that which is normally possessed by a prudent person in the ordinary course of business dealings.

j. Except for transactions authorized under paragraph (f) of these instructions, if a participant in a covered transaction knowingly enters into a lower tier covered transaction with a person who is suspended, debarred, ineligible, or voluntarily excluded from participation in this transaction, in addition to other remedies available to the Federal Government, the department or agency may terminate this transaction for cause or default.

* * * * *

2. Certification Regarding Debarment, Suspension, Ineligibility and Voluntary Exclusion – First Tier Participants:

a. The prospective first tier participant certifies to the best of its knowledge and belief, that it and its principals:

(1) Are not presently debarred, suspended, proposed for debarment, declared ineligible, or voluntarily excluded from participating in covered transactions by any Federal department or agency;

(2) Have not within a three-year period preceding this proposal been convicted of or had a civil judgment rendered against them for commission of fraud or a criminal offense in connection with obtaining, attempting to obtain, or performing a public (Federal, State or local) transaction or contract under a public transaction; violation of Federal or State antitrust statutes or commission of embezzlement, theft, forgery, bribery, falsification or destruction of records, making false statements, or receiving stolen property;

(3) Are not presently indicted for or otherwise criminally or civilly charged by a governmental entity (Federal, State or local) with commission of any of the offenses enumerated in paragraph (a)(2) of this certification; and

(4) Have not within a three-year period preceding this application/proposal had one or more public transactions (Federal, State or local) terminated for cause or default.

b. Where the prospective participant is unable to certify to any of the statements in this certification, such prospective participant shall attach an explanation to this proposal.

2. Instructions for Certification - Lower Tier Participants:

(Applicable to all subcontracts, purchase orders and other lower tier transactions requiring prior FHWA approval or estimated to cost \$25,000 or more - 2 CFR Parts 180 and 1200)

a. By signing and submitting this proposal, the prospective lower tier is providing the certification set out below.

b. The certification in this clause is a material representation of fact upon which reliance was placed when this transaction was entered into. If it is later determined that the prospective lower tier participant knowingly rendered an erroneous certification, in addition to other remedies available to the Federal Government, the department, or agency with which this transaction originated may pursue available remedies, including suspension and/or debarment.

c. The prospective lower tier participant shall provide immediate written notice to the person to which this proposal is submitted if at any time the prospective lower tier participant learns that its certification was erroneous by reason of changed circumstances.

d. The terms "covered transaction," "debarred," "suspended," "ineligible," "participant," "person," "principal," and "voluntarily excluded," as used in this clause, are defined in 2 CFR Parts 180 and 1200. You may contact the person to which this proposal is submitted for assistance in obtaining a copy of those regulations. "First Tier Covered Transactions" refers to any covered transaction between a grantee or subgrantee of Federal funds and a participant (such as the prime or general contract). "Lower Tier Covered Transactions" refers to any covered transaction under a First Tier Covered Transaction (such as subcontracts). "First Tier Participant" refers to the participant who has entered into a covered transaction with a grantee or subgrantee of Federal funds (such as the prime or general contractor). "Lower Tier Participant" refers any participant who has entered into a covered transaction with a First Tier Participant or other Lower Tier Participants (such as subcontractors and suppliers).

e. The prospective lower tier participant agrees by submitting this proposal that, should the proposed covered transaction be entered into, it shall not knowingly enter into any lower tier covered transaction with a person who is debarred, suspended, declared ineligible, or

voluntarily excluded from participation in this covered transaction, unless authorized by the department or agency with which this transaction originated.

f. The prospective lower tier participant further agrees by submitting this proposal that it will include this clause titled "Certification Regarding Debarment, Suspension, Ineligibility and Voluntary Exclusion-Lower Tier Covered Transaction," without modification, in all lower tier covered transactions and in all solicitations for lower tier covered transactions exceeding the \$25,000 threshold.

g. A participant in a covered transaction may rely upon a certification of a prospective participant in a lower tier covered transaction that is not debarred, suspended, ineligible, or voluntarily excluded from the covered transaction, unless it knows that the certification is erroneous. A participant is responsible for ensuring that its principals are not suspended, debarred, or otherwise ineligible to participate in covered transactions. To verify the eligibility of its principals, as well as the eligibility of any lower tier prospective participants, each participant may, but is not required to, check the Excluded Parties List System website (<https://www.epls.gov/>), which is compiled by the General Services Administration.

h. Nothing contained in the foregoing shall be construed to require establishment of a system of records in order to render in good faith the certification required by this clause. The knowledge and information of participant is not required to exceed that which is normally possessed by a prudent person in the ordinary course of business dealings.

i. Except for transactions authorized under paragraph e of these instructions, if a participant in a covered transaction knowingly enters into a lower tier covered transaction with a person who is suspended, debarred, ineligible, or voluntarily excluded from participation in this transaction, in addition to other remedies available to the Federal Government, the department or agency with which this transaction originated may pursue available remedies, including suspension and/or debarment.

* * * * *

Certification Regarding Debarment, Suspension, Ineligibility and Voluntary Exclusion-- Lower Tier Participants:

1. The prospective lower tier participant certifies, by submission of this proposal, that neither it nor its principals is presently debarred, suspended, proposed for debarment, declared ineligible, or voluntarily excluded from participating in covered transactions by any Federal department or agency.

2. Where the prospective lower tier participant is unable to certify to any of the statements in this certification, such prospective participant shall attach an explanation to this proposal.

* * * * *

XI. CERTIFICATION REGARDING USE OF CONTRACT FUNDS FOR LOBBYING

This provision is applicable to all Federal-aid construction contracts and to all related subcontracts which exceed \$100,000 (49 CFR 20).

1. The prospective participant certifies, by signing and submitting this bid or proposal, to the best of his or her knowledge and belief, that:

a. No Federal appropriated funds have been paid or will be paid, by or on behalf of the undersigned, to any person for influencing or attempting to influence an officer or employee of any Federal agency, a Member of Congress, an officer or employee of Congress, or an employee of a Member of Congress in connection with the awarding of any Federal contract, the making of any Federal grant, the making of any Federal loan, the entering into of any cooperative agreement, and the extension, continuation, renewal, amendment, or modification of any Federal contract, grant, loan, or cooperative agreement.

b. If any funds other than Federal appropriated funds have been paid or will be paid to any person for influencing or attempting to influence an officer or employee of any Federal agency, a Member of Congress, an officer or employee of Congress, or an employee of a Member of Congress in connection with this Federal contract, grant, loan, or cooperative agreement, the undersigned shall complete and submit Standard Form-LLL, "Disclosure Form to Report Lobbying," in accordance with its instructions.

2. This certification is a material representation of fact upon which reliance was placed when this transaction was made or entered into. Submission of this certification is a prerequisite for making or entering into this transaction imposed by 31 U.S.C. 1352. Any person who fails to file the required certification shall be subject to a civil penalty of not less than \$10,000 and not more than \$100,000 for each such failure.

3. The prospective participant also agrees by submitting its bid or proposal that the participant shall require that the language of this certification be included in all lower tier subcontracts, which exceed \$100,000 and that all such recipients shall certify and disclose accordingly.

ATTACHMENT A - EMPLOYMENT AND MATERIALS PREFERENCE FOR APPALACHIAN DEVELOPMENT HIGHWAY SYSTEM OR APPALACHIAN LOCAL ACCESS ROAD CONTRACTS

This provision is applicable to all Federal-aid projects funded under the Appalachian Regional Development Act of 1965.

1. During the performance of this contract, the contractor undertaking to do work which is, or reasonably may be, done as on-site work, shall give preference to qualified persons who regularly reside in the labor area as designated by the DOL wherein the contract work is situated, or the subregion, or the Appalachian counties of the State wherein the contract work is situated, except:

a. To the extent that qualified persons regularly residing in the area are not available.

b. For the reasonable needs of the contractor to employ supervisory or specially experienced personnel necessary to assure an efficient execution of the contract work.

c. For the obligation of the contractor to offer employment to present or former employees as the result of a lawful collective bargaining contract, provided that the number of nonresident persons employed under this subparagraph (1c) shall not exceed 20 percent of the total number of employees employed by the contractor on the contract work, except as provided in subparagraph (4) below.

2. The contractor shall place a job order with the State Employment Service indicating (a) the classifications of the laborers, mechanics and other employees required to perform the contract work, (b) the number of employees required in each classification, (c) the date on which the participant estimates such employees will be required, and (d) any other pertinent information required by the State Employment Service to complete the job order form. The job order may be placed with the State Employment Service in writing or by telephone. If during the course of the contract work, the information submitted by the contractor in the original job order is substantially modified, the participant shall promptly notify the State Employment Service.

3. The contractor shall give full consideration to all qualified job applicants referred to him by the State Employment Service. The contractor is not required to grant employment to any job applicants who, in his opinion, are not qualified to perform the classification of work required.

4. If, within one week following the placing of a job order by the contractor with the State Employment Service, the State Employment Service is unable to refer any qualified job applicants to the contractor, or less than the number requested, the State Employment Service will forward a certificate to the contractor indicating the unavailability of applicants. Such certificate shall be made a part of the contractor's permanent project records. Upon receipt of this certificate, the contractor may employ persons who do not normally reside in the labor area to fill positions covered by the certificate, notwithstanding the provisions of subparagraph (1c) above.

5. The provisions of 23 CFR 633.207(e) allow the contracting agency to provide a contractual preference for the use of mineral resource materials native to the Appalachian region.

6. The contractor shall include the provisions of Sections 1 through 4 of this Attachment A in every subcontract for work which is, or reasonably may be, done as on-site work.

AMENDMENT
REQUIRED CONTRACT PROVISIONS
(Exclusive of Appalachian Contracts)

FEDERAL-AID CONSTRUCTION CONTRACTS

The Federal–Aid provisions are supplemented with the following:

XII. Cargo Preference Act

1. U.S. Department of Transportation Federal Highway Administration memorandum dated December 11, 2015 requires that all federal-aid highway programs awarded after February 15, 2016 must comply with the Cargo Preference Act and its regulation of 46 CFR 381.7 (a)-(b).

Chapter 45 State Advertising and Award Procedures

This chapter is used by local agencies wanting the Washington State Department of Transportation (WSDOT) to advertise and award their Federal Highway Administration (FHWA) construction contracts. For these agencies, [Chapter 51](#) will also apply.

45.1 General Discussion

The documents that the local agency must submit to WSDOT in order to have a project advertised and awarded by the state are listed in [Chapter 51](#), which describes the procedures for advertising and awarding a construction contract when WSDOT is the awarding authority.

WSDOT will administer the project either in accordance with the [Construction Manual M 41-01](#) or this manual.

45.2 Submittals

When WSDOT is to advertise and award a construction contract on an FHWA project, the local agency will prepare and submit the following documents to WSDOT. Additional details on the content and format of these documents are found in [Chapter 44](#) and in the [Construction Manual M 41-01](#).

.21 Contract Plans, Specifications, and Estimates (PS&E) – The originals and one copy of these shall be submitted to the Region Local Programs Engineer. Review of the PS&E and bridge plans by WSDOT must be scheduled well in advance of the advertising date of the project. WSDOT review time on complex projects varies between 12 to 18 weeks depending on the type of project. Contact the Region Local Programs Engineer to coordinate the submittal time of the PS&E and bridge plans and for an advance estimate of the time and cost for the reviews.

.22 Local Agency Letter of Financial Responsibility – See [Chapter 44](#) and [Appendix 44.72](#).

45.3 Procedures

.31 Advertising and Award – The following process will be used for reviewing contract documents, advertising for bids, evaluating bids, and awarding a construction contract.

1. The local agency prepares the PS&E package and submits it to the Region Local Programs Engineer.
2. WSDOT will review and concur with the PS&E.
3. A WSDOT Project Engineer is assigned to administer the project construction (see [Chapter 51](#)).
4. After WSDOT's review and concurrence, an advertising date is set. WSDOT sends out office copies of the PS&E to the local agency and other offices within WSDOT for their final review prior to advertising.

5. WSDOT advertises the project for at least three weeks.
6. On the date established in the bid advertisement, WSDOT opens and reads the bids received (see [Appendix 44.72](#)).
7. WSDOT tabulates and evaluates the bids. consults with the local agency prior to the project award.

If the lowest responsible bid does not exceed the engineer's contract estimate by more than 10 percent, the region awards the contract.

If the lowest responsible bid exceeds the engineer's estimate by more than 10 percent, WSDOT shall submit a copy of the bid, a tabulation of all bids, justification to accept or reject the bid, and any other related documents to the local agency for approval or disapproval.

8. If approval is made by the local agency, the region will award and execute the contract to the lowest responsible bidder.
9. The Local Agency Agreement must be supplemented if any overrun or underrun occurs beyond the authorized amount. See [Section 22.3](#).
10. WSDOT administers the project in accordance with department policy.
Note: Before award, the Local Agency Agreement must be supplemented when the contract amount is greater than the authorized amount.
11. WSDOT bills the agency in accordance with the terms of the Local Agency Agreement.

Chapter 46 *Local Advertising and Award Procedures*

This chapter is used by local agencies operating under Certification Acceptance ([Chapter 13](#)) and choosing to advertise and award construction contracts themselves. [Chapter 52](#) will also apply to these agencies.

Local agencies wanting to have the Washington State Department of Transportation (WSDOT) administer their construction contracts should refer to [Chapter 51](#).

46.1 General Discussion

Local agencies may let contracts for their projects provided that the following conditions are met:

.11 The local agency uses the advertising and award procedures outlined in this section to advertise for bids, select the responsible bidder with the lowest responsive bid, and award the contract.

.12 A Local Agency Agreement between the state and local agency is in effect setting forth the conditions under which the project will be constructed.

.13 The local agency is participating in the cost of the project or has other special interests in it.

.14 The local agency is certified for project administration in accordance with [Chapter 13](#).

No project can be advertised until the following items have been completed:

- PS&E has been approved.
- The environmental document has been approved.
- The project's right of way has been certified.
- Project Disadvantaged Business Enterprise (DBE) and Training goals have been established.
- Construction funds have been authorized by Local Programs.
- A contract number has been obtained from the Region Local Programs Engineer.
- FHWA has authorized the project in FMIS.
- The Region Local Programs Engineer has concurred with advertising the project.

46.2 Procedures

.21 Funding – A Local Agency Agreement and construction funds must be authorized by the Local Programs before a contract is advertised.

.22 Bidding Procedures – The local agency is prohibited from establishing any procedures or requirements for qualification or licensing of contractors, which prevents the submission of bids or prohibits consideration of bids submitted by any responsible contractor, whether resident or nonresident of the state, except as outlined.

The prequalification of prospective bidders is the responsibility of the local agency. WSDOT will not prequalify prospective bidders for local agency projects. A local agency may at its option use the WSDOT prequalification procedure specified in the *Standard Specifications* M 41-10. If another procedure is used, it must be approved by FHWA prior to use. When an agency does not prequalify prospective bidders, they shall afford ten days after notification for the low bidder to provide evidence of capability to perform the work.

When evaluating whether or not the Bidder is qualified to perform the work the following information should be considered:

- Experience
- Personnel
- Equipment
- Financial Resources
- Performance Record

Qualifications must, at a minimum, consist of bonding capability as required by state law and compliance with licensing requirements of state law. The local agency may include additional requirements.

When the DBE participation goal is included in the contract provisions, meeting the goal is part of the bidding requirements, as explained in [Chapter 26](#) and [Chapter 44](#).

For all FHWA projects, bidding opportunities, on a nondiscriminatory basis, shall be afforded to all qualified bidders regardless of state boundaries, race, sex, color, or national origin.

No bidder shall be disqualified or prevented from competitive bidding by restricting the purchase of a surety bond or insurance policy from any surety or insurer outside the state and authorized to do business with the state.

.23 Preparation of the Project Proposal – See WSDOT *Standard Specifications* Section 1.02.6.

.24 Advertising of the Project – Federal aid projects shall be advertised for a three-week period prior to opening of bids. The contract advertisement period shall be as follows: Projects shall be advertised in the local agency’s official legal publication at least twice, 20 calendar days prior to the last date upon which the bids will be received. The agency will award and execute the contract to the responsible bidder with the lowest responsive bid unless the agency decides that all bids are to be rejected. Local Programs must concur when rejecting all bids. An advertisement period less than three weeks may be approved in special cases when justified. Shortened advertisement periods shall be no less than two weeks and require approval from FHWA. Approval must be properly documented in the project file. Examples for requesting shorter advertising periods are as follows:

- Emergency correction of roadways or bridges.
- To meet the conditions of an environmental permit (fish windows).
- To meet the conditions of a Bureau of Reclamation Permit (Irrigation Canal).
- To complete project prior to a school district opening in the fall.

In addition, the justification for the two week ad request should include the following:

- Will the shorter ad period limit the competition?
- Will the shorter ad period increase the overall cost of the project?
- Does the project include a Disadvantaged Business Enterprise (DBE) goal and will it allow the subcontractors sufficient time to submit a bid to the proposal holders?

The project will be advertised in the official legal publication for the agency and, if necessary, other newspapers to provide the widest possible coverage commensurate with the size of the project. Affidavits of publication must be in the project file.

The local agency will comply with the standard USDOT Title VI Assurances by inclusion of the following language in the solicitations for bids:

“The (Local Agency) in accordance with Title VI of the Civil Rights Act of 1964, 78 Stat. 252, 42 USC 2000d to 2000d-4 and Title 49, Code of Federal Regulations, Department of Transportation, Subtitle A, Office of the Secretary, Part 21, Nondiscrimination in Federally-Assisted Programs of the Department of Transportation issued pursuant to such Act, hereby notifies all bidders that it will affirmatively ensure that in any contract entered into pursuant to this advertisement, disadvantaged business enterprises as defined at 49 CFR Part 26 will be afforded full opportunity to submit bids in response to this invitation and will not be discriminated against on the grounds of race, color, national origin, or sex in consideration for an award.”

Should an addendum be necessary during the advertising period to correct or add something to the bid or plan data, such addenda if **minor** shall be approved by the CA local agency prior to transmittal to all the plan holders. A **major** addendum, which constitutes a change that significantly affects the cost of the project to the FHWA or alters the termini, character, or scope of the work requires HQ Local Programs approval. Each bidder shall present with their bid written notice of their receipt of each addendum received.

.25 Bid Opening – All bids received in accordance with the terms of the advertisement shall be publicly opened and announced, either item by item or by total amount.

If any bid received is not read, the name of the bidder and the reason for not reading the bid shall be publicly announced at the bid opening.

Negotiation with contractors, during the period following the opening of bids and before the award of the contract is not permitted.

Adequate justification for rejecting any bids must be documented by the local agency.

.26 Evaluation of Bids for Award – The local agency shall verify that all required bid documents have been properly submitted and executed by all bidders. All bids are then reviewed for accuracy, unbalancing of bid items, etc., and tabulations checked and confirmed. Any corrections to the bid tabulations are made, if necessary, in accordance with *Standard Specifications* Section 1-02 and 1-03.

In order for a bid to be considered responsive, a bid deposit of at least 5 percent of the total bid proposal must accompany each bid. In accordance with *Standard Specifications* Section 1 02.7, the Proposal Bond shall not be conditioned in any way to modify the minimum 5 percent required.

When there is a specified DBE goal for the project, the successful bidder will be selected on the basis of having submitted: (1) the lowest responsive bid which has met the DBE goal; or (2) when the DBE participation is less than the specified goal, responsiveness will be determined on the basis of good faith efforts to attain the goal. All agencies that have projects with mandatory DBE goals must submit the bid tabs, the DBE Utilization Certification and the DBE Written Confirmation Document of the apparent low bidder to the Region Local Programs Engineer (LPE) to obtain concurrence to award before the contract is officially awarded to the apparent low bidder. Failure to gain LPE concurrence prior to award on every project with DBE goals and subsequent award of a contract to a nonresponsive bidder will jeopardize the project's federal funding. For more information on DBE program requirements, see [Chapter 26](#).

The local agency shall prepare a tabulation of bids showing the item details for at least the three lowest acceptable bids.

On projects where the lowest responsible bid exceeds the engineer's estimate, it is the local agency's decision whether or not to award the project. Reasons for justifying award:

- There was adequate competition for the project location and/or type of work.
- The project is essential to the public interest (safety, emergency repair, etc.).
- There was a significant error in the engineer's estimate.
- If advertising again would likely result in higher bids.

If the local agency determines that the lowest bidder is not qualified or deemed non-responsive, it shall document those findings prior to awarding the bid to the next lowest responsive bidder.

The Local Agency Agreement must be supplemented if any overrun or underrun occurs beyond the authorized amount. See [Section 22.3](#).

The original signed Supplemental Agreement form must be submitted to the Region Local Programs Engineer. This supplemental agreement form will be retained by WSDOT. It is the responsibility of the local agency to submit an additional supplemental agreement form or copy if they need an executed supplemental agreement for their files.

.27 Award of Contract – After bids have been tabulated and evaluated in accordance with the procedures described above, the construction contract may be awarded to the responsible bidder with the lowest responsive bid. Projects with DBE goals must have concurrence of the Region Local Programs Engineer prior to award. Failure to obtain LPE approval will jeopardize the project's federal funding. Prior to award, agencies must verify contractor status with the System for Award Management (SAM) at www.sam.gov/portal/public/sam to determine if a contractor and or a supplier has been excluded from bidding on a federal aid contract. The results of that search will be documented to the project file. SAM is the electronic version of the Lists of Parties Excluded from Federal Procurement and Nonprocurement Programs (Lists), which identifies those parties that have been suspended, debarred, or otherwise excluded from bidding on federal procurement and nonprocurement contracts. Construction contracts awarded to firms listed on the Excluded Parties Listing will not be eligible for federal aid reimbursement.

After award by the local agency, the contractor must be advised of the award in writing. For an example of an award letter with a Voluntary DBE goal, see [Appendix 46.43](#). For an example of an award letter for a contract that has a mandatory DBE goal, see [Appendix 46.44](#). The information contained in the body of these examples must be included in the local agency letter.

.28 Execution of Contract – Local agencies shall not execute a contract with any contractor who is not registered or licensed in accordance with state laws.

The local agency prepares the necessary documents and forwards them for execution by the successful bidder and the proper officials of the local agency.

An example of a standard contract agreement is in [Appendix 44.73](#). The Region Local Programs Engineers can furnish these standard forms upon request.

46.3 Submittal of Award Data

The local agency must submit the following information to the Region Local Programs Engineer within **30 days** of award:

- Tabulation of bids.
- Engineer's estimate.
- Award letter to the contractor.
- Names and addresses of all firms that submit a quote to the successful low bidder.
- DBE Utilization Certification, DOT Form 272-056 (if applicable).
- DBE Written Confirmation Document, DOT Form 422-031 (if applicable).
- Diversity Management & Compliance System (DMCS) contact information as follows,

Agency	Contractor
Name:	Name:
Title:	Title:
Phone:	Phone:
Email:	Email:

Failure to submit the above listed information, before construction begins, will result in a delay of reimbursement for the billed cost, until the information is received.

46.4 Appendices

- [46.41](#) Advertisement – Example
- [46.42](#) Local Agency Funds – Award Letter Example
- [46.43](#) Voluntary Goal – Award Letter Example
- [46.44](#) Mandatory Goal – Award Letter Example
- [46.45](#) Contract Bond – Example
- [46.46](#) Vacant

Invitation to Bid

Sealed bids will be received by the (Local Agency), at the reception desk located in Room _____ of the _____, Washington until _____ a.m. on _____ and will then and there be opened and publicly read for the construction of the improvement(s).

All bid proposals shall be accompanied by a bid proposal deposit in cash, certified check, cashier's check, or surety bond in an amount equal to five percent (5%) of the amount of such bid proposal. Should the successful bidder fail to enter into such contract and furnish satisfactory performance bond within the time stated in the specifications, the bid proposal deposit shall be forfeited to the (Local Agency).

The right is reserved to reject any and all bids and to waive informalities in the bidding.

Maps, plans, and specifications may be obtained from this office upon payment of the amount of \$ _____.

Informational copies of maps, plans and specifications are on file for inspection in the Office of the Local Agency Engineer, (Local Agency), Washington.

The following is applicable to federal aid projects.

The (Local Agency) in accordance with Title VI of the Civil Rights Act of 1964, 78 Stat. 252, 42 U.S.C. 2000d to 2000d-4 and Title 49, Code of Federal Regulations, Department of Transportation, Subtitle A, Office of the Secretary, Part 21, Nondiscrimination in Federally Assisted Programs of the Department of Transportation issued pursuant to such Act, hereby notifies all bidders that it will affirmatively ensure that in any contract entered into pursuant to this advertisement, disadvantaged business enterprises as defined at 49 CFR Part 26 will be afforded full opportunity to submit bids in response to this invitation and will not be discriminated against on the grounds of race, color, national origin, or sex in consideration for an award.

The improvement for which bids will be received is described below:

*This bolded paragraph cannot be reworded for FHWA funded projects.

Appendix 46.42 Local Agency Funds – Award Letter Example

Date

Principle, Title
Company Name
Address
City, State, Zip

Contract Number:
Project Title:

Dear:

This will advise that the contract for the above referenced project has been awarded to your firm at the bid price of \$_____.

The contract will be forwarded at a later date. The contract must be signed and returned in accordance with the mailing instructions furnished with the contract documents. Please return within 20 calendar days after the date of award.

Sincerely,

Local Agency

cc: Region Local Programs Engineer

Appendix 46.43 Voluntary Goal – Award Letter Example

Date

Principle, Title
Company Name
Address
City, State, Zip

Contract Number
Project Title
Federal Aid Number

Dear:

This letter is to advise you that the contract for the above referenced project has been awarded to your firm at your bid price of \$_____.

As a part of entering this contract, the contractor agrees to take all necessary and responsible steps in accordance with 49 CFR Part 26 to ensure that Disadvantaged Business Enterprises (DBE) have an opportunity to participate in the performance of this contract.

The award of this contract was made with the understanding that (Company Name), will provide the following items prior to submitting the signed contract for execution:

1. A list of all firms who submitted a bid or quote in an attempt to participate in this contract whether they were successful or not. Include the following information:
 - Correct business name and mailing address.

Send this information to (Local Agency name and address). Failure to provide this information prior to execution will result in forfeiture of the bidder's proposal security.

The Contractor shall submit a Small Business Enterprise (SBE) Participation Plan prior to commencing contract work. Although the goal is voluntary, the outreach efforts to provide SBE maximum practicable opportunities are not.

The contract will be forwarded to you under separate cover. The contract must be signed and returned in accordance with the mailing instructions furnished with the contract documents. Please return these documents within 20 calendar days after the date of award.

Sincerely,

Local Agency

cc: Region Local Programs Engineer

Mandatory Goal – Award Letter Example

Date

Principle, Title
Company Name
Address
City, State, Zip

Contract Number
Project Title
Federal Aid Number

Dear:

This letter is to advise you that the contract for the above referenced project has been awarded to your firm at your bid price of \$ _____.

As a part of entering this contract, the contractor agrees to take all necessary and responsible steps in accordance with 49 CFR Part 26 to ensure that Disadvantaged Business Enterprises (DBE) have an opportunity to participate in the performance of this contract. The award of this contract was made with the understanding that the firms listed on the DBE Utilization Certification will be performing the dollar value of work as indicated.

Prior to submitting the signed contract for execution, (Company Name) will provide the following items:

1. Breakout information for all successful DBEs as shown on the DBE Utilization Certification:
 - Correct business name, federal employer identification number (if available), and mailing address.
 - List of all bid items assigned to each DBE firm, including unit prices and extensions, indicating any anticipated sharing of resources (e.g., equipment, employees).
 - Indicate partial items – specify the distinct elements of work to be performed by the DBE firms and provide a complete description of these partial items.

Note: Total amounts shown for each DBE shall not be less than the amount shown on the Utilization Certification.

2. A list of all firms who submitted a bid or quote in an attempt to participate in this contract whether they were successful or not. Include the following information:
 - Correct business name and mailing address.

Send these two items to (Local Agency name and address). Failure to provide this information prior to execution will result in forfeiture of the bidder's proposal security.

The contract will be forwarded to you under separate cover. The contract must be signed and returned in accordance with the mailing instructions furnished with the contract documents. Please return these documents within 20 calendar days after the date of award.

Sincerely,

Local Agency

cc: Region Local Programs Engineer

Appendix 46.45 Contract Bond – Example

CONTRACT BOND

KNOW ALL MEN BY THESE PRESENTS, That

of _____, as Principal, and _____

as Surety, are jointly and severally held and bound unto the _____
city/county

in the penal sum of Dollars (\$ _____), for the payment of which we jointly and severally bind ourselves, our heirs, executors, administrators, and assigns, and successors and assigns, firmly by these presents.

THE CONDITION of this bond is such that whereas, on the _____

day of _____ A.D., 19 _____, the said _____

Principal, herein, executed a certain contract with the _____
city/county

by the items, conditions and provisions of which contract the said _____,

Principal, herein, agree to furnish all material and do certain work, to wit: That _____

_____ will undertake and complete the construction of

according to the maps, plans and specifications made a part of said contract, which contract as so executed, is hereunto attached, is now referred to and by reference is incorporated herein and made a part hereof as fully for all purposes as if here set forth at length. The bond shall cover all approved change orders as if they were in the original contract.

NOW, THEREFORE, if the Principal herein shall faithfully and truly observe and comply with the terms, conditions and provisions of said contract in all respects and shall well and truly and fully do and perform all matters and things by undertaken to be performed under said contract, upon the terms proposed therein, and within the time prescribed therein, and until the same is accepted, and shall pay all laborers, mechanic, subcontractors and material men, and all persons who shall supply such contractor or subcontractor with provisions and supplies for the carrying on of such work, and shall in all respects faithfully perform said contract according to law, then this obligation to be void, otherwise to remain in full force and effect.

WITNESS our hands this _____ day of _____, 19 _____

PRINCIPAL

ATTORNEY-IN-FACT, SURETY

NAME AND ADDRESS LOCAL OFFICE OF AGENT

APPROVED:

_____ CITY/COUNTY

By: _____ APPROVING AUTHORITY

Date: _____, 19 _____

SURETY BOND NUMBER

CONTRACT NUMBER

Appendix 46.46 Vacant

This chapter is by those local agencies for whom the Washington State Department of Transportation (WSDOT) advertises and awards projects.

51.1 General Discussion

WSDOT is responsible for the proper expenditure of Federal Highway Administration (FHWA) funds on local agency projects and will administer all construction activities to ensure compliance with applicable rules and that all documentation is in order.

WSDOT will assign a contract number after the PS&E has been approved and construction funds have been authorized. No FHWA reimbursement for construction can be made until a contract number has been assigned. Reimbursement will follow the method indicated in [Chapter 22](#).

Non-NHS projects will be administered in accordance with [Chapter 52](#). NHS projects administered by WSDOT will be in accordance with the CA procedures. The Regional Administrator will select one of the following for administration of the project.

1. Assign a WSDOT Project Engineer and WSDOT staff.
2. Assign a WSDOT Project Engineer and a mix of WSDOT staff and local agency staff.
3. Assign a WSDOT Project Engineer and local agency staff.
4. Assign a WSDOT Project Engineer and a WSDOT-selected consultant's engineering staff (when available WSDOT and/or local agency staff will be used to supplement the consultant's staff).

The local agency will appoint a project coordinator to be the contact person for the Project Engineer.

51.2 Preconstruction Conference

As soon as practicable after a contract is awarded, the Project Engineer should arrange a conference with the contractor and shall notify the local agency project coordinator and Region Local Programs Engineer of the time and place.

Minutes of the conference should be taken and copies transmitted to the local agency, the contractor, and all other agencies and firms that were invited to the conference.

51.3 Changes and Extra Work

The Project Engineer will prepare the change order in accordance with departmental policy and the Interlocal Agreement.

If a change order or the accumulation of change orders will result in the final cost of the project exceeding the amount authorized in the Local Agency Agreement, the local agency must submit a supplement to the Local Agency Agreement in accordance with [Chapter 22](#) prior to the contractor starting the change order work. The local agency should contact the Region Local Programs Engineer for assistance in preparing the supplement and to determine if FHWA funds are available for the overrun.

Chapter 52 *Local Administered Projects*

This chapter is used for NHS and non-NHS routes by Local Agencies operating under Certification Acceptance (CA) and choosing to administer construction contracts themselves. In the sequence of project development, this follows [Chapter 46](#).

Local Agencies whose construction contracts are administered by the Washington State Department of Transportation (WSDOT) should refer to [Chapter 51](#).

Title 23 USC and 23 CFR provisions apply to all NHS Federal aid projects regardless of federal funding source or approval authority. State standards may be used on non-NHS projects, except for federal requirements pertaining to contracts (bid proposal content including Davis Bacon and DBE) and procurement procedures (competitive bidding and Brooks Act).

52.1 General Discussion

WSDOT is responsible for the proper expenditure of FHWA funds on Local Agency projects. Local Programs will consult and work with Local Agencies as needed and will perform systematic project management reviews to ensure that proper procedures are followed.

Except for this chapter, construction shall be administered and materials inspected, in accordance with the [Construction Manual](#) M 41-01. For exceptions to the [Construction Manual](#), see [Appendix 52.107](#). In case of conflicting guidelines, this chapter governs the [Construction Manual](#). Agencies may choose to use their own forms provided the same information is included on the agency forms as is shown on the WSDOT forms used for the same purposes. For an understanding of WSDOT documentation requirements, use [Chapter 10](#) of the [Construction Manual](#) as a guide.

All FHWA projects are subject to Disadvantaged Business Enterprise (DBE), on the Job Training (OJT) and Equal Employment Opportunity (EEO) compliance reviews by WSDOT.

The [Standard Specifications for Road, Bridge, and Municipal Construction](#) M 41-10 and APWA GSP 1-01.3 define the major elements for construction contracts.

52.2 Preconstruction Conference

After a contract is awarded, the Local Agency should arrange a conference with the contractor. The Local Agency Engineer shall notify the Region Local Programs Engineer of the time and place of the conference.

On large, complex projects, a preconstruction conference should be held before each construction phase. It may be desirable to hold separate conferences for some specialized construction items such as paving, roadside planting, or electrical work. The preconstruction conference may include a partnering session, if appropriate. For a conference agenda example, refer to [Appendix 52.101](#).

The meeting should be documented and copies of the minutes transmitted to the Region Local Programs Engineer and each agency, organization, and firm that has involvement or interest in the project (see [Appendix 52.102](#)).

52.3 Quality Control

The quality of materials and workmanship on a project must conform to the contract specifications so that the public funds expended will have purchased a safe, economical, and fully functional transportation facility.

.31 General – The source for each type of material must be approved by the Local Agency prior to use. There are two submittal processes allowed by [Standard Specifications](#) Section 1-06.1 for material approval in Washington State, the Qualified Product List, and the Request for Approval of Materials (RAM). Contractors are encouraged to use one of these tools to request material approval or, if an agency has their own process established, to follow that.

The Qualified Product List (QPL) is compiled by the WSDOT Materials Laboratory (Mats Lab) Documentation Section and can be accessed at www.wsdot.wa.gov/Business/MaterialsLab/QPL.htm.

The Request for Approval of Material (DOT Form 350-071) is a form distributed by WSDOT. Contractors may use this form to submit requests for approval for materials not found in the QPL. Some agencies have a similar form that is also acceptable.

Local Agencies requesting a Record of Materials (ROM) from WSDOT's Mats Lab should submit their request as soon as possible to avoid delaying the contractor. The average processing time is approximately four to eight weeks.

Reimbursement of FHWA funds may be denied for work done contrary to, or in disregard of, the contract documents.

Local Agencies making improvements to National Highway System (NHS) routes with federal funding must comply with the FHWA approved qualified tester program. If a Local Agency is not certified to perform the tests, they can contact a qualified testing laboratory or their Region Local Programs Engineer to make arrangements for WSDOT to perform the testing on the project.

.32 Qualified Tester Requirements – For local agencies the guidelines below apply:

1. **Construction Projects on Non-NHS Highway System** – There is no requirement for qualified testers on the non-NHS highway system. Construction projects that have FHWA funds must follow the requirements contained in this manual.
2. **Construction Projects on the NHS Highway System With No FHWA Funds** – There is no requirement for qualified testers on the NHS highway system that do not have FHWA funds in the construction phase.
3. **Construction Projects on the NHS Highway System With FHWA Funds** – Qualified Testers are required for construction projects that on the NHS highway system that have FHWA funds in the construction phase.

Agencies have several options for meeting the qualified tester requirements:

- Contract with WSDOT to perform the required tests (based on available workforce).
- Local agencies may pursue tester qualification through WSDOT for agency personnel (based on available workforce).
- Agencies may use any AMRL R-18 laboratories qualified to test as defined by AASHTO test methods appropriate to the material. Employees of AMRL R-18 laboratories are considered qualified via the laboratory certification process. WAQTC testers may also work on NHS projects.
- Agencies may also use laboratories that are accredited by the Laboratory Accreditation Bureau, L-A-B for Construction Materials Testing or accredited by the Construction Materials Engineering Council's (CMEC's) ISO 17025 program. These laboratories are considered to meet the quality assurance requirements in 23 CFR 637.209(a) (2), (3), and (4).

.33 Quality Assurance Program for Qualified Testers – For work on an NHS Highway System local agencies must develop a quality assurance program which will assure that the materials and workmanship incorporated into each federal-aid highway construction project is in conformity with the requirements of the approved plans and specifications, including approved changes. The program must meet the criteria in FHWA regulation for *Quality Assurance Procedures for Construction* (23 CFR 637).

The Quality Assurance Program includes the following:

- Qualified Tester Program
- Equipment Calibration/Standardization/Check and Maintenance Program
- Qualified Laboratory Program
- Independent Assurances (IA) Program

There are three ways an agency can meet the IA on-site evaluation requirements. They are as follows:

- Contract with WSDOT's Region Materials Lab (based on available workforce)
- Contract with a qualified local agency
- Contract with a qualified testing firm.

HMA Testing – Qualification is required for the following test methods:

- **AASHTO T 168** – Sampling Bituminous Paving Mixtures
- **AASHTO T 308/ASTM D 6307** – Asphalt Content of Hot Mix Asphalt (HMA) by the Ignition Method (may substitute other AASHTO or ASTM extraction methods). Use of Ignition Method must include furnace correction factor for each mix tested.
- **AASHTO T 209/ASTM D 2041** – Rice Density
- **AASHTO T 27/T 11** – Sieve Analysis of Fine and Coarse Aggregates
- **AASHTO T 255** – Total Evaporable Moisture Content of Aggregate by Drying
- **WAQTC TM 6** – Moisture Content of HMA

HMA Density Testing – Qualification is required in the following test method:

- **WAQTC TM 8** – In place Density of Bituminous Mixes Using the Nuclear Moisture-Density Gauge

Concrete testing can be performed by testers qualified by AMRL R-18 qualification in the following test methods:

- **AASHTO T 23** – Making and Curing Concrete Test Specimens in the Field
- **AASHTO T 119** – Standard Test Method for Slump of Hydraulic-Cement Concrete
- **AASHTO T 152** – Air Content of Freshly Mixed Concrete by the Pressure Method
- **AASHTO T 141/ASTM C 172** – Sampling Freshly Mixed Concrete
- **AASHTO T 309** – Temperature of Freshly Mixed Portland Cement Concrete

Laboratories must meet the AASHTO Standards for Moist Cabinets, Moist Rooms, and Water Storage Tanks and be qualified to Cure, Cap, and perform compression testing of test specimens.

Testers with current ACI grade 1 Concrete Testing Certification can also perform concrete field testing on NHS projects with federal funding.

Aggregate testing can be performed by laboratories qualified by AMRL R-18 in the following test methods:

- **AASHTO T 2** – Sampling of Aggregates
- **AASHTO T 27/T 11** – Sieve Analysis of Fine and Coarse Aggregates
- **AASHTO T 176** – Determination of the Plastic Fines in Graded Aggregate by Use of the Sand Equivalent Test
- **AASHTO T 248** – Reducing Field Samples of Aggregates to Testing Size
- **AASHTO T 255** – Total Moisture Content of Aggregate by Drying
- **AASHTO TP 61** – Determining the Percentage of Fracture in Coarse Aggregate

Laboratories offering Embankment and Base Density field-testing must be qualified to perform the following test methods:

- **AASHTO T 272** – Family of Curves – One-Point Method
- **AASHTO T 310** – In-Place Density and Moisture Content of Soil and Soil Aggregate by Nuclear Method
- **AASHTO T 99** or other approved test method of determining – Moisture Density Relations of Soils

The following is a breakdown of materials and how they will be accepted.

List of Materials to Test

1. Structural Concrete
 - Slump
 - Air
 - Temp
 - Compression Testing
 - Aggregate

2. Asphalt in the roadway
Density
Hot Mix
Aggregate
3. Surfacing under roadway and bridge approaches
Density
Gradation and SE
4. Base material under roadway, embankments, bridge approaches
Density
Gradation and SE
5. Structural Grout
Compression Testing
6. High Strength Nuts Bolts and Washers*
Manufacturer's Certificate of Compliance
Certificate of Material Origin

List of Materials to Certify

1. Steel
Manufacturer's Certificate of Compliance
Certificate of Material Origin*
2. Iron
Certificate of Material Origin*
3. Liquid Asphalt Products
Manufacturer's Certificate of Compliance
4. Construction Geosynthetics
Manufacturer's Certificate of Compliance
5. Guardrail Items
Certificate of Material Origin for steel components*
6. Bridge Bearing Assemblies that are not welded
Manufacturer's Certificate of Compliance
Certificate of Material Origin**

List of Material to Accept With Visual Inspection or Catalog Cut**

(All items must meet FHWA Buy America Requirements)

1. Traffic marking – paints and thermoplastics
2. Electrical items and accessories
3. Fencing
4. Landscaping or irrigation items
5. Drainage Items
6. Rebar Tie Wire

*See [Standard Specifications](#) Section 9-06.5.

**Agencies must document the sources of steel and iron by having a "Certification of Materials Origin" on file including mounting hardware.

7. Backer Rod under RCS Expansion Joints
8. Rebar Chairs and Dobie Blocks
9. Temporary Items
10. Compost
11. Street furniture etc.
12. Monument Case and Cover Certificate of Material Origin is required

List of Materials That Require Fabrication Inspection

(All items must meet the FHWA Buy America Requirements)

1. Structural Steel Beams or Fabricated, Welded items
2. Structural Precast Concrete Items
3. Bridge Bearing Assemblies that are welded
4. Signs
5. Sign Bridges
6. Cantilever Sign Structures

52.4 Progress Payments

Progress payments must be based on measurements of work performed so that the contractor can be fairly compensated and so that public funds will not be expended on work that has not yet been done.

.41 General – Progress estimates should be prepared on a pre-selected date each month and payment made to the contractor. Measurement and payment for all acceptably completed bid items of work will be in accordance with [Standard Specifications](#) Section 1-09. Source documents used to support payments must be complete, standalone documents that fully support the payment being made. Documentation to support payment shall be in accordance with [Construction Manual Chapter 10](#). Agencies that have integrated computer programs for Inspector Daily Reports and payment source documents shall include all the information shown on the WSDOT forms used for those purposes. Progress estimates should be prepared promptly and may be forwarded to the contractor for review and signature.

.42 Statement of Intent to Pay Prevailing Wages – The contractor and subcontractors of every tier shall submit form

LI 700-29 to Washington State Department of Labor & Industries (L&I) for approval of the wage rates they intend to pay. Each statement must be accompanied by the filing fee established by L&I and required by [RCW 39.12.030](#) and [39.12.040](#).

Form LI 700-29 shall be on file with the Local Agency before any payment is made to the contractor. Subcontractors of every tier shall have an approved copy of this form on file with the Local Agency before any payment can be made for their work.

52.5 Changes and Extra Work

Prior to beginning work on a contract, a Local Agency should have a written policy for the approval of change orders to ensure that appropriate procedures are followed. Without a written change order policy delegating approval authority, the designated CA Agreement approval authority must approve all change orders. See item #2, i of the Certification Agreement ([Chapter 13](#)).

It is important to distinguish between actual changes to the contract work and normal overruns and under-runs that may occur. No change order work shall be done prior to approval being given by the appropriate authority, verbal or written. Verbal approval requires written documentation including a description of work that adequately describes the extent of the change. Verbal approval must be followed by a written change order. No contract payment shall be made prior to having the written change order approved by the appropriate authority.

Changes to a Condition of Award letter shall be handled in accordance with the GSP (Changes in the Quantity of Work). All change orders affecting the work of DBEs shall be submitted to the Region Local Programs Engineer for concurrence prior to executing the change order.

When changes in the work will alter the termini, character, and scope of an approved project, approval of Local Programs is required prior to the commencement of the physical work. For further information, refer to [Chapter 21](#). All change orders must be numbered in sequence.

Change order documentation is composed of two parts:

1. The approved change order signed by the agency and the contractor.
2. The backup documentation. The backup documentation shall include an explanation in sufficient detail so that everyone involved will understand the need for the change, and how the change will affect the overall contract. The explanation shall include a detailed justification of the cost and/or any adjustment to working days associated with the change. The detailed cost justification shall be documented independent of the contractor's proposal to substantiate the change.

.51 Administrative Settlement Costs – Administrative settlement costs are costs related to the defense and settlement of contract claims. These will include, but are not limited to salaries of contracting officers or their authorized representatives, attorneys, or members of arbitration boards, appeal boards, etc., that are allowable to the findings and determination of contract claims, but not including administrative or overhead costs.

FHWA funds may participate in administrative settlement costs, which are:

- Incurred after notice of claim.
- Properly supported.
- Directly allocable to a specific FHWA project.
- For employment of special counsel for review and defense of contract claims when recommended by the agency's legal counsel and approved in advance by WSDOT.

When a claim is submitted, the Region Local Programs Engineer should be contacted for advice on how to proceed.

52.6 Termination of Contract

Standard Specifications Section 1-08.10 contains procedures and criteria for termination of a contract. Prior to termination action against a contractor or reassignment of the performance to the surety, the Local Agency must obtain Local Programs concurrence.

52.7 Compliance With Federal Contract Provisions

FHWA requires that all subcontracts at any tier be in writing, per 23 CFR, Section 635.116(b). This includes both contracts between the prime contractor and their subcontractors, and contracts between subcontractors and their agents.

Each of these subcontracts must also physically contain the following documents. None of these documents can be included by reference only.

- The general special provision (GSP) entitled “Required Federal Aid Provisions.”
- Form FHWA 1273 “Required Contract Provisions, Federal Aid Construction Contracts.”
- The minimum wage rates for the contract as required by [RCW 39.12](#) and [Title 29](#) of the Code of Federal Regulations (CFR).

It is the responsibility of the Local Agency to ensure full compliance with the provisions above.

Implementation of the DBE and EEO programs are also federal contract requirements. For information, refer to [Chapters 26](#) and [27](#).

52.8 Physical Completion of Construction

The Local Agency will carry out the following requirements to terminate the construction contract and ready the project for acceptance by WSDOT and FHWA:

.81 Final Inspection – The Local Agency Project Engineer shall send a request for WSDOT inspection and acceptance to the Region Local Programs Engineer no later than within 15 days of substantial completion of work by the contractor. A copy of the completion letter that is sent to the contractor should accompany the request.

.82 Notice of Physical Completion – Within ten calendar days after physical completion of the work by the contractor, the Local Agency Project Engineer shall notify the contractor by letter that the construction is physically complete, and that the project is subject to audit and acceptance by WSDOT. The agency shall diligently pursue closure of the contract.

.83 Final Reports – A construction project is considered complete when the items listed below have been completed. All certifications and reports shall be retained for at least three years after final acceptance of the project.

1. **Final Estimate (Approving Authority File)** – When the contractor has a claim pending against the Local Agency and wants to receive a final estimate, a claim must be submitted in writing, detailing the specific items and amounts. When a claim is submitted, immediately contact the Region Local Programs Engineer so that FHWA can be informed of the claim’s details at an early stage. See *Standard Specifications* Section 1-09.12(2).

2. **Comparison of Preliminary and Final Quantities (Approving Authority File)** – This is a listing of items that show the preliminary and final quantities.
3. **Certified Final Bill for Utility Agreement, if applicable, to Region Local Programs Engineer.**
4. **Final Records (Approving Authority File)** – The Local Agency Project Engineer must document the work performed on the contract. Documentation consists of field books, inspector's record of field tests, Project Engineer's and inspector's diaries, all invoices, weigh bills, truck measurements, quantity tickets, receiving reports, field office ledgers, mass diagrams, cross-sections, computer listings, and work profiles. Photographs or video tapes before, during, and after construction could be useful, especially if care is taken to show any unusual conditions, equipment, or procedures.

Final records shall be retained by the Local Agency for at least three years following acceptance of the project by Local Programs. The Local Agency will receive the administrative review letter showing the starting and ending date of the three-year retention period from the Director, Local Programs Division (OMB Circular A-133).

5. **Record of Material Samples and Tests**
6. **Materials Certification (Appendix 52.104)** – The intent of the materials certification is to assure that the quality of all materials incorporated into the project are in conformance with the plans and specifications, and thus ensure a service life equivalent to the design life.
 - a. This materials certification shall be completed in accordance with [Construction Manual](#) Section 9-1.5 or [Section 52.3](#) of this manual and is submitted along with the completion letter to the Region Local Programs Engineer.
7. **Affidavit of Wages Paid** – Upon completion of a contract, the prime contractor and every subcontractor or agent shall submit Form LI-700-7, Affidavit of Wages Paid, to L&I for certification of the wage rates paid on the project. Each affidavit must be accompanied by the filing fee established by L&I.

An L&I certified copy of Form LI-700-7 from the prime contractor, and every subcontractor or agent, must be on file with the Local Agency before the bond will be released.
8. **Release for the Protection of Property Owner and General Contractor.** Form LI-263-83, is no longer furnished by L&I. The new process requires the agency to use the Labor and Industries website at <https://fortress.wa.gov/lni/crpsi/> to verify that the prime contractor and all subs on the project have paid the required industrial insurance and medical-aid premiums. The UBI number for each contractor and sub is required to access the verification. The printed verification statements must be on file with the Local Agency before the retained percentage can be released.

9. For all federal aid projects and select state funded projects, the prime contractor shall enter the amounts paid to all firms involved with the contract (Zero payments shall be marked accordingly). The prime contractor shall enter the payments amount received from the agency each month into the WSDOT Diversity Management and Compliance System – DMCS (<https://wsdot.diversitycompliance.com>). The local agency shall each month confirm the entries in the WSDOT Diversity Compliance System. Payment information shall be entered monthly and include the actual date of the payment. See [Chapter 26](#).

.84 **Project Acceptance** – The approving authority’s approval of the final estimate will be considered as the Local Agency’s acceptance of the project.

52.9 Projects within Interstate Rights of Way

All construction, materials, and quality control requirements contained in the current editions of the *Standard Specifications* and *Construction Manual* must be incorporated into the contract. (See [Section 14.3](#) for complete guidance on work within the Interstate Rights of Way.)

52.10 Appendices

- [52.101](#) Preconstruction Conference Agenda – Example
- [52.102](#) Preconstruction Conference Minutes – Example
- [52.103](#) Letter Requesting WSDOT Project, Inspection, and Acceptance – Example
- [52.104](#) Materials Certification – Example
- [52.105](#) Weekly Statement of Working Days
- [52.106](#) Change Order
- [52.107](#) Exceptions to the WSDOT *Construction Manual* M 41-01

52.11 Forms

See [Construction Manual Chapter 11](#)
FHWA Form WH-347

Appendix 52.101 Preconstruction Conference Agenda – Example

1. Order of work (Progress Schedule)
2. Utilities and Railroads
 - a. Project Engineer prepare list of affected services and representatives to be contacted.
 - b. Underground services should be located.
 - c. Notification time required by organizations.
 - d. Insurance required, if any.
3. Subcontractors and Agents
 - a. Request for approval must be submitted along with a Statement of Intent to Pay Prevailing Wage and Subcontractor or Agent Certification.
 - b. Nature of work to be performed by each.
 - c. Subcontractor's route correspondence via prime contractor.
 - d. Prime contractor must have a representative with authority on the job at all times (designated by letter).
 - e. DBE subcontract work – indepth discussion including conditions of award if any.
4. Records and Reports
 - a. Description of required forms and initial supply should be handed out or mailed to prime contractor.
 - b. All reports must be handled through prime contractor's office.
 - c. Record of Materials should be provided and Requests for Approval of Materials Sources (RAM) should be submitted as soon as possible.
 - d. Falsework plans, if required.
 - e. Certified payrolls must be submitted on time and wage rate interviews will be conducted. Per the FHWA 1273, employee full social security numbers and home addresses shall not be included on weekly payrolls.
 - f. EEO and trainee requirements – indepth discussion.
 - g. DBE requirements when the contract contains UDBE goals – indepth discussion.
 - DBE – Onsite reviews must be conducted on all DBE and UDBE firms that works on the project.

- h. Required job site posters (provided to Prime Contractor).
 - i. Davis-Bacon statement regarding the USDOL, WSDOT and local agency's role in investigations for labor compliance.
 - j. ADA requirements.
 5. Traffic Control And Safety
 - a. [Manual on Uniform Traffic Control Devices](#) will control signing.
 - b. Review and discussion of Traffic Control Plan (TCP) including pedestrian and bicycle accommodations.
 - c. Safety control on structures.
 - d. Flagman should use standard paddle and vest and must be certified with flagman card.
 - e. Speed regulation of construction equipment.
 - f. Contractor and project engineer designate by name the individual responsible for construction traffic control.
 - g. Safety and health requirements.
 - h. Request police to report all construction zone accidents to the contracting authority.
 - i. Gross legal load limits shall be adhered to.
 - j. The local agency will monitor the requirements of [RCW 46.61.655](#) as amended by Substitute House Bill No. 2455 and cooperate with law enforcement agencies in the enforcement as provided in [Standard Specifications](#) Section 1-07.1. Substitute House Bill No. 2455 deals with covered loads or 6 inches of freeboard.
 6. Environmental Considerations
 - a. Commitment files.
 - b. Standard Specifications/Special Provisions.
 - c. Contractor responsibility to obtain permits.
 - d. Department of Ecology requires registration of rock crushers in accordance with [WAC 173-400](#).
 - e. Temporary Erosion and Sediment Control Plan (TESCP).
 - f. Spill Prevention, Control, and Containment Plan (SPCCP).
 7. Dismiss Disinterested Parties (list those leaving)
 8. Reopen with General Construction Discussion
 - a. Contractor explains how he plans to pursue the work.
 - b. Review of anticipated construction problems.
 - c. Conflict resolution – need for partnering.

Appendix 52.102 Preconstruction Conference Minutes – Example

To: (Contractor)

Agency:
Project Title:
F.A.:
Contract Number:

Date:

Attention: (Contractor's Representative)

1. Time:
Location of meeting:
2. Persons attending and organizations represented:
3. Description of work:
4. Discussion items:

Prepared by:

cc: Region Local Programs Engineer

Each agency, organization, and firm who has involvement or interest in the project.

Appendix 52.103 Letter Requesting WSDOT Project Inspection and Acceptance – Example

Date

Region Local Programs Engineer
Department of Transportation

Contract Number
Contract Name
Federal Aid Number

Dear Sir:

For your information, I am sending you a copy of the contract completion letter that was sent to the -contractor. I request inspection and acceptance of the project by WSDOT.

Sincerely,

(Director of Public Works)
(County Engineer)
(City Engineer)
(Local Agency Engineer)

Appendix 52.104 Materials Certification – Example



Materials Certification

Project: _____

Contract Number: _____

Checklist for Project Certification

- | | Yes | No | N/A | |
|----|--------------------------|--------------------------|--------------------------|--|
| 1. | <input type="checkbox"/> | <input type="checkbox"/> | <input type="checkbox"/> | Request for approval of material sources was submitted for all items listed on the record of materials and as required by Chapter 9-4 of the Construction Manual or alternative procedures authorized by LAG Appendix 52.107. |
| 2. | <input type="checkbox"/> | <input type="checkbox"/> | <input type="checkbox"/> | All preliminary samples requested by or for approval of source were submitted and approved or an alternate approval material or product was used. |
| 3. | <input type="checkbox"/> | <input type="checkbox"/> | <input type="checkbox"/> | All samples and documentation including manufacturer's certificate of compliance, shop drawings, mill test certificates, etc., as required by the record of materials were submitted and subsequently approved. |
| 4. | <input type="checkbox"/> | <input type="checkbox"/> | <input type="checkbox"/> | If job quantities differed from those listed on the record of materials, acceptance samples were taken at the frequency listed in Chapter 9-5.7 of the Construction Manual or alternative procedures authorized by LAG Appendix 52.107. |
| 5. | <input type="checkbox"/> | <input type="checkbox"/> | <input type="checkbox"/> | All items requiring inspection at the point of fabrication were so inspected and were accepted at the jobsite by the presence of an approved stamp, sticker, tag, or mark. |
| 6. | <input type="checkbox"/> | <input type="checkbox"/> | <input type="checkbox"/> | The results of the tests on acceptance samples indicate that the materials incorporated in the construction work, and the construction operations controlled by sampling and testing, were in conformity with the approved plans and specifications. Exceptions to the plans and specifications are explained on the back hereof (or on attached sheet). |
| 7. | <input type="checkbox"/> | <input type="checkbox"/> | <input type="checkbox"/> | Items added by change order and not listed on the record of materials were accepted in accordance with procedures listed in Chapter 9 of the Construction Manual or alternative procedures authorized by LAG Appendix 52.107. |

Note: Any "No" answers on this checklist must be fully explained and documented. Attach test reports representing nonspecification material as well as an explanation of the circumstances leading to acceptance of said material. All seven items must be completed before the project can be certified.

Certified Signature: _____
Approving Authority

_____ Date

Appendix 52.105 Weekly Statement of Working Days

**WASHINGTON STATE
DEPARTMENT OF TRANSPORTATION
WEEKLY STATEMENT OF WORKING DAYS**

Page 1 of 1

CONTRACT NO:
CONTRACTOR:

FEDERAL AID NO:

CONTRACT TITLE:
STATEMENT NO:

STATEMENT DATE:

This statement shows the number of working days charged to your contract for the week ending:

DATE	WEATHER	PHASE 00		PHASE		REASON
		WORK	UNWORK	WORK	UNWORK	
Sun		0.00	0.00	0.00	0.00	
Mon		0.00	0.00	0.00	0.00	
Tues		0.00	0.00	0.00	0.00	
Wed		0.00	0.00	0.00	0.00	
Thurs		0.00	0.00	0.00	0.00	
Fri		0.00	0.00	0.00	0.00	
Sat		0.00	0.00	0.00	0.00	
Days This Week:		0.00	0.00	0.00	0.00	
Days Work Suspended:			0.00		0.00	
Days Previously Reported:		.00	0.00	0.00	0.00	
Total Days To Date:		.00	0.00	0.00	0.00	

CURRENT STATUS:

Days Specified In Contract:	.00	0.00
Approved Extension of Time:	.00	0.00
Total Authorized Time of Contract:	.00	0.00
Less Workable Days Charged:	.00	0.00
Working Days Remaining:	.00	0.00

SUMMARY OF WEEKS ACTIVITIES:

PROJECT ENGINEER: _____

NOTE: The contractor will be allowed 10 days from the date of this report in which to protest in writing the correctness of this statement, otherwise it shall be deemed to have been accepted as correct.

DOT FORM 422-022 (Revised 12/91)

Appendix 52.106 Change Order



**Washington State
Department of Transportation**

Change Order

Contract Number	Contract Title	Federal Aid Number
Change Order Number	Change Description	Date
Prime Contractor / Design-Builder		

Ordered by Engineer under the terms of Section 1-04.4 of the Standard Specifications

Change proposed by Contractor / Design-Builder

Change Description

Verbal Approval Given By	Verbal Approval Date	Working Days +/-
--------------------------	----------------------	------------------

Original Contract Amount	Current Contract Amount	Est. Net Change This C.O.	Est. Contract Amount
--------------------------	-------------------------	---------------------------	----------------------

Approval Recommended	Approved	Approved
Project Engineer	_____	Approving Authority per C.A. Agreement
Date	_____	Date
Approval Recommended	_____	Other Approval As Required
By Prime Contractor	_____	Signature
Date	_____	Date
	_____	Representing

Contract Number	Contract Title	Change Order Number
Change Description Cont.		

Checklist

Change Order

Question	Yes	No	N/A
1. Does the change order alter the termini, character, or scope of the work?	<input type="checkbox"/>	<input type="checkbox"/>	<input type="checkbox"/>
If yes, you must have H & LP approval to be eligible for federal funds.	<input type="checkbox"/>	<input type="checkbox"/>	<input type="checkbox"/>
If yes, you must submit a revised Page 1 of the prospectus.	<input type="checkbox"/>	<input type="checkbox"/>	<input type="checkbox"/>
2. Is the Change Order over \$7,500.00 and outside the scope of work?	<input type="checkbox"/>	<input type="checkbox"/>	<input type="checkbox"/>
If yes, the change cannot be a change order and must be an independent work.	<input type="checkbox"/>	<input type="checkbox"/>	<input type="checkbox"/>
3. Does the Change Order detail all items involved with the change?	<input type="checkbox"/>	<input type="checkbox"/>	<input type="checkbox"/>
4. Does the Change Order include an adjustment in working days?	<input type="checkbox"/>	<input type="checkbox"/>	<input type="checkbox"/>
If yes, the time extension must be stated in the Change Order.	<input type="checkbox"/>	<input type="checkbox"/>	<input type="checkbox"/>
If yes, an independent engineer's estimate of time must be included to document the extension.	<input type="checkbox"/>	<input type="checkbox"/>	<input type="checkbox"/>
If no, that must be stated in the Change Order.	<input type="checkbox"/>	<input type="checkbox"/>	<input type="checkbox"/>
5. Does the Change Order alter the DBE Condition of Award?	<input type="checkbox"/>	<input type="checkbox"/>	<input type="checkbox"/>
If yes, you must obtain concurrence from Local Programs.	<input type="checkbox"/>	<input type="checkbox"/>	<input type="checkbox"/>
If yes, you must obtain the DBE's signature on the Change Order.	<input type="checkbox"/>	<input type="checkbox"/>	<input type="checkbox"/>
6. Does the Change Order involve a material substitution?	<input type="checkbox"/>	<input type="checkbox"/>	<input type="checkbox"/>
If yes, you must determine if a material credit is appropriate.	<input type="checkbox"/>	<input type="checkbox"/>	<input type="checkbox"/>
7. If Change Order work started prior to its execution, prior verbal approval by the Approving Authority must be granted and documented.	<input type="checkbox"/>	<input type="checkbox"/>	<input type="checkbox"/>
8. Has the Change Order been signed by the contractor?	<input type="checkbox"/>	<input type="checkbox"/>	<input type="checkbox"/>
9. Has the Change Order been executed by the Approving Authority?	<input type="checkbox"/>	<input type="checkbox"/>	<input type="checkbox"/>
If you are a "non CA Agency", you must have the acting CA Authority's approval.	<input type="checkbox"/>	<input type="checkbox"/>	<input type="checkbox"/>
10. Has an independent engineer's estimate justifying the costs and time extensions been completed and documented?	<input type="checkbox"/>	<input type="checkbox"/>	<input type="checkbox"/>
11. Has a detailed memo outlining the chronology of events, basis of need, costs and working days been prepared and placed in the file accompanying the Change Order?	<input type="checkbox"/>	<input type="checkbox"/>	<input type="checkbox"/>

Appendix 52.107 Exceptions to the WSDOT Construction Manual M 41-01

The following exceptions to the [Construction Manual](#) M 41-01 may be used by the local agency.

- The local agency may develop their own Record of Materials (ROM), and approve manufacturers not listed on the approved WSDOT manufacturers list. The ROM is a listing of the construction items, generated by either the State Materials Laboratory or the Local Agency that has been identified from the plans and specifications for each project. The ROM identifies the types and quantities of materials, the standard acceptance methods and the number of acceptance and verification samples required for all material that will be used on the project. The ROM should always be maintained. If material quantities are increased or decreased during the construction of the project the ROM must reflect these changes. This may either increase or decrease the amount of acceptance tests needed. The ROM needs to reference the standard specification or contract provision where the material requirement is defined. The ROM also lists the acceptance requirements for materials requiring other actions, such as fabrication inspection, manufacturer's certificate of compliance, shop drawing or catalog cuts.
- Asphalt plant inspectors and scalepersons are not required at established commercial sources. This exception does not allow the agency to eliminate acceptance sampling of the materials.
- The following items may be accepted with an approved catalogue cut and documented by visual inspection and a manufacturer's material certification (provided manufacturer's certification is based on actual testing and meet the FHWA Buy America Requirements):
 - Electrical items and accessories
 - Paving fabrics or construction geosynthetics
 - Fencing of any kind
 - Landscaping or irrigation items
 - Glare screens
 - Traffic buttons or pavement markings
 - Guardrail items (Certificate of Material Origin is required)
 - Drainage items (Certificate of Material Origin is required)
 - Emulsified Asphalt for HMA Tack Coat and BST (Suppliers Bill of Lading acts as Manufacturer's Certificate of Compliance)
 - Re Bar Tie Wire
 - Backer Rod under RCS Expansion Joint
 - Rebar Chairs and Dobie Blocks
 - Temporary Items

- Sandbags, Rope, and Wood Stakes
- Compost, topsoil
- Monument Case and Cover (Certificate of Material Origin is required)
- PG Binder (Suppliers Bill of Lading acts as Manufacturer's Certificate of Compliance)
- Sign Inspection (Manufacturer's Certificate of Compliance is required)
- Pigmented Sealer
- A Certificate of Material Origin is required for all steel and iron items on federally funded projects.
- Local agencies are not required to have Scaleman's Daily Reports as long as:
 - The printed ticket contains **all** of the same information that is on the Scaleman's Daily Report Form 422-027.
 - You must have an AM and PM tare weight for each truck. The tare weights must be shown on the printed ticket.
 - **Local agencies are still required to collect scale certifications at 6-month intervals per *Standard Specification 1-09.2(2)*.**
- Local agencies may test their own signal cabinets.
- Local agencies may lower the density testing requirements to 90 percent of the rice density for non structural overlay pavement designs with a thickness of 1.25 to 2 inches (30 to 50 mm). This should be limited to areas or projects with documented foundation problems and on overlay of existing pavements.
- Local agencies are not required to follow the qualified testing program outlined in the [Construction Manual](#) M 41-01 if the agencies projects are not on the NHS, or are on the NHS and the project does not contain federal funding AND the acceptance sampling frequencies and test methods are done in accordance with [Chapter 9](#) of the [Construction Manual](#) M 41-01 and the exceptions listed above.

In addition to mandatory acceptance sampling, a local agency may choose to do independent assurance sampling. If a local agency elects to do independent assurance sampling, the procedures listed shall be followed.

- Assurance sampling and testing will be done independent of acceptance testing, not utilizing the same testing equipment or performed by the same personnel. Assurance samples of aggregate may be taken by the field inspector and split two ways. One split will be tested by the inspector in the field as an acceptance sample and the other split will be an assurance sample for immediate testing and comparison with field results.
- Assurance sample testing does not reflect on the acceptability of the material involved. Acceptance under the contract is determined by the acceptance testing process. Assurance testing is performed to obtain an independent verification of proper testing procedure and equipment.

Comparison of Assurance and Acceptance Test Results – Assurance sample results will be compared with the acceptance test results of the companion samples.

Reports of the comparison of results will be placed in the project file. The degree of conformance will be determined according to the deviation ranges noted below. Gradation test results will be compared only on specification screens.

Test	Normal Range of Deviation	Maximum Range of Deviation
Sand Equivalent	±8 points	±15 points
Fracture	±5 percent	±10 percent
Asphalt Content (HMA and ATB)	±0.3 percent	±0.6 percent
Sieve Analysis – All Items: No. 4 (4.75 mm) sieve and larger	±5 percent	±8 percent
No. 6 (3.35 mm) sieve to No. 80 (0.180 mm) sieve	±3 percent	±6 percent
No. 100 (0.150 mm) and No. 200 (0.075 mm) sieve	±2 percent	±4 percent

In the table above, “Normal Range” indicates an acceptable range of variation between test results and no action is required. Test results which fall in this category will be so indicated by the wording “normal deviation” on the assurance test reports. Test results falling outside of the “Normal Range” but within the “Maximum Range,” will be indicated by the wording “questionable deviation” on the assurance test reports. For deviations falling into this category, the Project Engineer or a representative shall review the original test report form, advise the responsible test operator of the deviation, and review the test procedure at the next opportunity.

Test results exceeding the maximum range will be indicated by the wording “excessive deviation.” For deviations falling in the excessive category, the Project Engineer or a representative will notify the appropriate personnel for corrective action.

Corrective action will include review of sampling procedures, sample splitting procedures, testing procedures, and testing equipment. Actions and results of these investigations will be documented to the project file by a notation. These may include comments or findings by the Lab and testing personnel.

Independent Assurance Sampling Frequency Guide

Item	Test	Assurance Sample
Gravel Borrow	Grading & SE	1 – 20,000 Ton
Select Borrow	Grading & SE	1 – 20,000 Ton
Sand Drainage Blanket	Grading	1 – 20,000 Ton
Gravel Base	Grading, SE & Dust Ratio	1 – 20,000 Ton
CSTC	Grading, SE & Fracture	1 – 10,000 Ton
CSBC Grading	SE & Fracture	1 – 10,000 Ton
Maintenance Rock	Grading, SE & Fracture	1 – 10,000 Ton
Ballast Grading	SE & Dust Ratio	1 – 10,000 Ton
Shoulder Ballast	Grading & Fracture	1 – 10,000 Ton
Backfill for Sand Drains	Grading	1 – 10,000 Ton
Crushed Coverstone	Grading, SE & Fracture	1 – 5,000 Ton
Crushed Screening		
5/8 – 1/4	Grading & Fracture	1 – 5,000 Ton
1/2 – 1/4	Grading & Fracture	1 – 5,000 Ton
1/4 – 0	Grading & Fracture	1 – 5,000 Ton
Gravel Backfill for Foundations	Grading, SE & Dust Ratio	1 – 5,000 Ton
Walls	Grading, SE & Dust Ratio	1 – 5,000 Ton
Pipe Bedding	Grading, SE & Dust Ratio	1 – 5,000 Ton
Drains	Grading	1 – 5,000 Ton
PCC Paving		
Coarse Aggregate	Grading	1 – 10,000 Ton
Fine Aggregate	Grading	1 – 5,000 Ton
Completed Mix		
Consistency	Slump	1 – 25,000 SY
Air Content	Air	1 – 25,000 SY
Yield	Cement Factor	1 – 25,000 SY
Test Beam	Flexural Strength	1 – 25,000 SY
PCC Structures		
Coarse Aggregate	Grading	1 – 5,000 Ton
Fine Aggregate	Grading	1 – 2,500 Ton
Consistency	Slump	1 – 1,000 CY
Air Content	Air	1 – 1,000 CY
Cylinders (28-day)	Compressive Strength	1 – 1,000 CY
Yield	Cement Factor	1 – 1,000 CY
Cement	Chemical and Physical Certification (Verification Sample)	1 – 1,000 Ton
Asphalt Materials		Verification
Paving Asphalt (AR, AC, PBA)		1 qt. every 3rd shipment
Liquid Asphalt (Cutback, Emulsion)		1 qt. every other shipment
Emulsion for ACP Tack Coat		None required

Chapter 53 *Project Closure*

53.1 **General Discussion**

After substantial completion of the work, the agency shall diligently pursue contract completion. In cases where the contractor is not diligently pursuing completion, the agency shall impose liquidating damages penalties, completion of remaining work with local forces or unilateral closure and claims against the contractor.

After the construction phase of a FHWA transportation project, done either by competitive bidding or by local agency forces, specific procedures are carried out to terminate the project's finances and review project performance. These procedures are necessary in order to settle any outstanding contract obligations, and to ensure that funds were expended properly.

This chapter lists requirements for closing the project accounts at WSDOT and FHWA and discusses project management reviews and project audits.

53.2 **Closure**

After the construction contract is complete, a 60-day project closure period begins. This closure period is initiated upon receipt of either a completion letter from the local agency or a final inspection of the project from the Region Local Programs Office. During this period, the local agency must complete the requirements described below.

No further payment will be made after the date indicated on the 60-day closure letter without the approval of Local Programs.

The local agency may request, however, that the 60-day closure period be extended. In this case, the local agency shall submit a written request to Local Programs justifying an extended closure period.

All Local Agency Agreements are required to have a Project Agreement End Date (2 CFR 200.309). Any costs incurred after the Project Agreement End Date are NOT eligible for federal reimbursement. All eligible costs incurred prior to the Project Agreement End Date must be properly submitted for reimbursement within 60 days after the Project Agreement End Date or they become ineligible for federal reimbursement.

.21 WSDOT Project Review – The Region Local Programs Engineer will conduct the final field inspection. It is suggested that the Region Local Programs Engineer be invited to the final project inspection with the contractor. If the final inspection reveals items that must be corrected or resolved before the project can be closed, these will be noted in the final inspection report. The Region Local Programs Engineer will work with the local agency to make the necessary corrections or to accomplish resolutions. If there is an unresolvable item indicating that a portion of project work is ineligible for FHWA reimbursement, WSDOT will issue a letter of notification outlining the ineligible work items and related costs.

.22 Final Billing – Within 60 calendar days of the completion date, the local agency shall submit a final bill (Appendix 23.71) clearly marked “Final Billing” and a Final Project Summary (Appendix 23.75) to WSDOT Headquarters Local Programs.

This final billing should include the following statement, “The total eligible costs to date have only been reimbursed by Federal agreement xxxx(xxx) and not by any other grant or funding source” and this statement should be endorsed by the signature designee. Additionally, properly completed DBE documentation must be received by HQ Local Programs prior to any final release of federal or State funds resulting from the Final Voucher process.

.23 Project Closure – Once the project has been reviewed and closed by FHWA, Local Programs provides the agency with an Administrative Review letter. The letter includes a final accounting and settlement of the total project costs, which may result in a payment or billing to the agency as appropriate; and provides information on records retainage.

53.3 Project Reviews

In order to be reasonably certain that local agencies are administering FHWA funds in accordance with the Local Agency Guidelines, WSDOT will perform procedural reviews on selected local agency ad-and-award projects.

These reviews will be:

- Project Management Reviews (PMR) performed by Local Programs (see Appendix 53.51 for review questions for PMR's and Documentation Reviews).
- Documentation Reviews performed by the Region Local Programs Engineer.

The agency may lose CA status, have its delegation of authority reduced to a project or phase of a project, or be placed on probationary CA. This may be the result of:

- A PMR or Documentation Review.
- An audit by the State Auditor.
- Final project inspection.
- The qualifications and experience of the agency staff are altered.

.31 PMR Preparation – Local Programs, through the Region Local Programs Engineer, will schedule a PMR with the agency and will request that the local agency managers participate. The local agency should have all pertinent documentation ready for the scheduled review. Typical procedural review questions are listed in Appendix 53.51. Typical documents to be examined during this review are also listed in Appendix 53.51. All deficiencies will be identified for the agency at the time of the PMR. Copies of documentation not available at the time of review shall be submitted through the Region Local Programs Engineer within 30 calendar days. After the 30-day period, the final PMR letter will be sent to the agency.

.32 PMR Deficiencies – If no major deficiencies are found in the local agency’s project management methods, the local agency will be informed in writing of the review team’s findings and recommendations.

If major deficiencies exist, the local agency will be asked to take corrective action within 60 days. If the deficiencies include ineligible work, WSDOT will issue a citation letter.

If deficiencies exist in the agency’s procedures, management practices, or systems, or if specific project errors are found, WSDOT’s administrative response might be one or more of the following:

- No action against the agency.
- Joint conference with the Local Agency, Region Local Programs Engineer, and the Director, Local Programs or the director’s designee.
- Limit or withhold the agency’s future Certification Acceptance authority ([Chapter 13](#)) to the extent deemed necessary:
 1. Allow Certification on a project-by-project basis.
 2. Direct WSDOT to assign a Project Engineer to each project for supervision, inspection, and administration.
 3. Contract the supervision, inspection, and administration to a consulting firm.
 4. Delay project authorization until adequate supervision, inspection, and administration is available from the local agency, WSDOT, or consultants.
- Establish a repayment plan when violations to procedures make certain expenditures ineligible for federal reimbursement. Per Section VII of the Local Agency agreement, withholding of funds from the local agency’s gasoline tax distribution may be necessary if a satisfactory repayment plan is not established within 45 days.

53.4 Financial and Compliance Audit

.41 Single Audit – The local agency is responsible for ensuring that a federal single audit is performed in accordance with 2 CFR Part 200.501 – Audit Requirements. WSDOT is also responsible for ensuring that FHWA funds are properly expended. The State Auditor will therefore audit each local agency.

.42 Project Audit – A project audit by WSDOT Local Programs is triggered by deficiencies found during:

1. A routine audit by the State Auditor, either on an FHWA project or on any other project where federal funds are involved.
2. A documentation review.
3. A project management review.

.43 Project Records – Project records shall be maintained in accordance with the terms of the Local Agency Agreement and shall be made available to the audit personnel upon request. It is helpful if field notes and other documentation are available in sufficient detail to facilitate the audit review.

.44 Audit Report – The state auditor notifies Local Programs upon completion of a formal audit report. If findings on a particular audit arise, Local Programs contacts the agency to confirm the findings and coordinate resolution. Audit findings must be resolved within six months of the date that the audit report is issued. Upon resolution, Local Programs issues a Management Review letter to the agency and provides copies to the FHWA. Audits will normally include the following categories:

- Interagency Agreements
- Land Development or Land Acquisition Projects
- Tier Contracting Procedures
- Fund Management – Transactions
- Accounting Methods – Cash or Accrual
- DBE-EEO Practices
- Use of Grant Acquired Equipment

53.5 Appendices

- 53.51 Local Agency Project Management Review Checklist (DOT Form 272-024 and DOT Form 272-026)
- 53.52 Final Inspection of Federal Aid Project
- 53.53 Vacant
- 53.54 Certified Payroll Example

Local Agency Project Management Review Checklist



Local Agency Project Management Review Checklist

Agency _____	Date _____
Project Title _____	
Federal Aid Project Number _____	Contract Number _____
Reviewers _____	
Prime Contractor _____	
Table of Organization and CA Agreement Review (Approving Authority)	
Design Approval _____	
PS&E Approval _____	
Contract Award _____	
Contract Administration _____	
Preliminary Engineering	
Design approved by _____ PS&E approved by _____	
Commitment File	<input type="checkbox"/> Yes <input type="checkbox"/> No
NEPA approval	Date _____
Were wage rates included in the contract	<input type="checkbox"/> Yes <input type="checkbox"/> No
Was a Value Engineering Study completed	<input type="checkbox"/> Yes <input type="checkbox"/> No
Public Interest Findings (PIF)	
Patented/Proprietary items <input type="checkbox"/> Yes <input type="checkbox"/> No	If yes, approved by: _____
Mandatory use of borrow or disposal site <input type="checkbox"/> Yes <input type="checkbox"/> No	If yes, approved by: _____
Agency supplied material <input type="checkbox"/> Yes <input type="checkbox"/> No	If yes, approved by: _____
Agency supplied equipment <input type="checkbox"/> Yes <input type="checkbox"/> No	If yes, approved by: _____
Local Agency Force work <input type="checkbox"/> Yes <input type="checkbox"/> No	If yes, approved by: _____
Two-week advertisement <input type="checkbox"/> Yes <input type="checkbox"/> No	If yes, approved by: _____
Tied bids <input type="checkbox"/> Yes <input type="checkbox"/> No	If yes, approved by: _____
Right of Way	
25 Right of Way acquired <input type="checkbox"/> Yes <input type="checkbox"/> No	
Project Right of Way certification	Date _____
Consultant Agreements	
31 Agreement renewed prior to expiration date <input type="checkbox"/> Yes <input type="checkbox"/> No	
Feetype _____	
Advertisements on file <input type="checkbox"/> Yes <input type="checkbox"/> No	
Did advertisement include Title VI language <input type="checkbox"/> Yes <input type="checkbox"/> No	
Selection process on file <input type="checkbox"/> Yes <input type="checkbox"/> No	

Consultant Agreements

Agency	Date
Project Title	
Federal Aid Project Number	
Consultant	

Agreements	Execution	Comp. Date
Original Agreement		
Supplement #		
Supplement #		
Supplement #		
Supplement #		
Supplement #		
Supplement #		
Supplement #		
Supplement #		
Supplement #		
Supplement #		
Supplement #		
Supplement #		
Supplement #		
Supplement #		
Supplement #		
Supplement #		
Supplement #		
Supplement #		
Supplement #		
Supplement #		

Advertising and Award

46.21 FHWA construction authorization Date _____

46.24 Advertising Dates _____ to _____

46.24 Three week advertising period Yes No

46.25 Affidavits of publication in file Yes No

Did publication include Title VI language Yes No

46.25 Bid opening Date _____

Were bid analysis conducted prior to award on unbalanced Bid Items Yes No

If yes, is justification on file Yes No

46.27 Award \$ _____ Date _____

46.26 Award to lowest bidder Yes No

If not, explain: _____

26 DBE Compliance and SBE Compliance

26.2 DBE goal set % _____ Yes No

26.2 DBE condition of award amount \$ _____

26.2 Is there concurrence to award from WSDOT/FHWA prior to a ward (projects containing DBE goal and full oversight projects only) Yes No

52.5 Did change orders affect DBE's Yes No

If so, explain: _____

26.2 DBE goal changes approved by WSDOT LP Yes No

26.2 Were quarterly report of amounts credited as DBE participation sent to region local programs engineer Yes No

Complaints regarding DBE's or from DBE Yes No

If yes, were the complaints submitted to WSDOT Yes No

Were complaints received from subcontractors for prime's failure to pay promptly or return retainage Yes No

Did Prime Contractor submit a Small Business Enterprise Plan Yes No N/A

Training

Training goal set: Hours _____ Yes No

Training plan approved by agency Yes No

Non-union training plan approved by FHWA Yes No

Training goal met: Hours _____ Yes No

Comments: _____

Were trainee interviews conducted Yes No

Comments: _____

Training start date _____ Training end date _____

Were good faith efforts provided when minority/female were not submitted Yes No

If yes, is there documentation in the file Yes No

Contract Administration

52.101 First working day _____ Number of working days _____

Number of working days complete _____

Were liquidated damages assessed Yes No

Preconstruction conference minutes review Yes No

Preconstruction Meeting held Yes No

Preconstruction Meeting minutes/documentation Yes No

Do the minutes reflect discussion regarding DBE & EEO requirements Yes No

Were there changes

Scope Yes No

Project Limits Yes No

Cost Yes No

If yes, is the NEPA still valid Yes No

If yes, is the design still in compliance with ADA requirements Yes No

52.51 Were any claims settled by administrative settlement Yes No

If yes, were claims submitted to local programs engineer Yes No

Comments _____

52.1 Project diaries and inspector's daily reports signed and reviewed Yes No

44.22e TCP in contract Yes No

Adopted by contractor Yes No

44.22e Detour included in contract Yes No

44.22e If yes, agreements included in contract Yes No

27.32 PR-1391 on file and PR1392 sent to region local programs Yes No

Comments _____

Contract Completion

52.83 End of project materials certification from project engineer to approving authority Date _____

Local Agency Project Prime & Subcontractor Information

Agency Name	Federal ID Number	Contact	Date							
Project Title										
Prime	Name	Amount	Date of Request to Sublet 421-012	DBE	Fed. Aid Certification 420-004	Statement of Intent to Pay Prev. Wages F700-029-000	Wage Rate Interview 424-003	DBE Review 272-051	Affidavit of Wages Paid F700-007-000	Payroll
1										
2										
3										
4										
5										
6										
7										
8										
9										
10										
11										
12										
13										
14										
15										
Total Amount Sublet \$										
% of Contract Sublet = (Maximum 70%)										
Payroll: Certified by the contractor <input type="checkbox"/> Yes <input type="checkbox"/> No										Checked and initiated by the agency <input type="checkbox"/> Yes <input type="checkbox"/> No
How often were payrolls reviewed _____										
Notes										

**Local Agency Project
Construction Contract Administration (Change Orders)**

Federal ID Number		Project Title		
CO #	Verbal App. Date	Written App. Date	Major Items Involved	Agency Justified Independently

W/D +/-

Cost Change +/-

Page 6 of 13

WSDOT Form 272-024
Revised 07/2015

Electrical

Agency		Date	
Project Title		Federal Aid Project Number	
Reviewed By			
Bid Item		Material	
CMO	<input type="checkbox"/> Yes <input type="checkbox"/> No	Plan Quantity	_____
Lump Sum Breakdown	<input type="checkbox"/> Yes <input type="checkbox"/> No	Paid Quantity	_____
Field Note Record Date	Quantity on Field Note Record	Field Note Record Verified	
Comments			
Acceptable <input type="checkbox"/>		Deficiency as Needed <input type="checkbox"/>	

Metal

Agency		Date	
Project Title		Federal Aid Project Number	
Reviewed By			
Bid Item		Material	
Visual Inspection	<input type="checkbox"/> Yes <input type="checkbox"/> No <input type="checkbox"/> N/A	Plan Quantity	_____
Lag Exception Noted	<input type="checkbox"/> Yes <input type="checkbox"/> No	Paid Quantity	_____
ROM Maintained	<input type="checkbox"/> Yes <input type="checkbox"/> No	RAM#	_____
Certificate of Material Origin	<input type="checkbox"/> Yes <input type="checkbox"/> No	Codes	_____
Qualified Products List	<input type="checkbox"/> Yes <input type="checkbox"/> No <input type="checkbox"/> N/A		
Shop Drawing	<input type="checkbox"/> Yes <input type="checkbox"/> No <input type="checkbox"/> N/A		
Mfg. Certificate	<input type="checkbox"/> Yes <input type="checkbox"/> No <input type="checkbox"/> N/A		
Test Report	<input type="checkbox"/> Yes <input type="checkbox"/> No <input type="checkbox"/> N/A		
Approved for Shipment	<input type="checkbox"/> Yes <input type="checkbox"/> No <input type="checkbox"/> N/A		
Bill of Lading	<input type="checkbox"/> Yes <input type="checkbox"/> No <input type="checkbox"/> N/A		
Fabrication Approved	<input type="checkbox"/> Yes <input type="checkbox"/> No <input type="checkbox"/> N/A		
Approved Source	<input type="checkbox"/> Yes <input type="checkbox"/> No <input type="checkbox"/> N/A		
Sign Acceptance Report	<input type="checkbox"/> Yes <input type="checkbox"/> No <input type="checkbox"/> N/A		
Field Note Record Date	Quantity on Field Note Record	Field Note Record Verified	
Comments			
Acceptable <input type="checkbox"/>		Deficiency as Needed <input type="checkbox"/>	

Aggregate Item

Agency			Date		
Project Title			Federal Aid Project Number		
Reviewed By					
Bid Item			Material		
Small Quantity	<input type="checkbox"/> Yes	<input type="checkbox"/> No	<input type="checkbox"/> N/A	Plan Quantity	_____
Certified Ticket	<input type="checkbox"/> Yes	<input type="checkbox"/> No	<input type="checkbox"/> N/A	Paid Quantity	_____
Lag Exception Noted	<input type="checkbox"/> Yes	<input type="checkbox"/> No	<input type="checkbox"/> N/A	RAM#	_____
ROM Maintained	<input type="checkbox"/> Yes	<input type="checkbox"/> No	<input type="checkbox"/> N/A	Codes	_____
Visual Inspection	<input type="checkbox"/> Yes	<input type="checkbox"/> No	<input type="checkbox"/> N/A	Approved Source-Pit #	_____
Scale Certification	<input type="checkbox"/> Yes	<input type="checkbox"/> No	<input type="checkbox"/> N/A		
Maximum Density Curve	<input type="checkbox"/> Yes	<input type="checkbox"/> No	<input type="checkbox"/> N/A		
Scaleman's Daily Report	<input type="checkbox"/> Yes	<input type="checkbox"/> No	<input type="checkbox"/> N/A		
Preliminary Sample	<input type="checkbox"/> Yes	<input type="checkbox"/> No	<input type="checkbox"/> N/A		
Acceptance Test	<input type="checkbox"/> Yes	<input type="checkbox"/> No	<input type="checkbox"/> N/A		
Compaction Test	<input type="checkbox"/> Yes	<input type="checkbox"/> No	<input type="checkbox"/> N/A		
Field Note Record Date		Quantity on Field Note Record		Field Note Record Verified	
Is this project on a NHS Rate?			<input type="checkbox"/> Yes	<input type="checkbox"/> No	
If so, is the tester certification on file?			<input type="checkbox"/> Yes	<input type="checkbox"/> No	
Comments					
Acceptable <input type="checkbox"/>		Deficiency as Needed <input type="checkbox"/>			

Asphalt

Agency		Date	
Project Title		Federal Aid Project Number	
Reviewed By			
Bid Item		Material	
Lag Exception Noted	<input type="checkbox"/> Yes <input type="checkbox"/> No <input type="checkbox"/> N/A	Plan Quantity	_____
ROM Maintained	<input type="checkbox"/> Yes <input type="checkbox"/> No <input type="checkbox"/> N/A	Paid Quantity	_____
Scale Certification	<input type="checkbox"/> Yes <input type="checkbox"/> No <input type="checkbox"/> N/A	RAM#	_____
Visual Inspection	<input type="checkbox"/> Yes <input type="checkbox"/> No <input type="checkbox"/> N/A	Codes	_____
Saleman's Daily Report	<input type="checkbox"/> Yes <input type="checkbox"/> No <input type="checkbox"/> N/A	Approved Source-Pit #/Agg	_____
Prelim. Sample-Agg.	<input type="checkbox"/> Yes <input type="checkbox"/> No <input type="checkbox"/> N/A		
Acceptance Test-Agg.	<input type="checkbox"/> Yes <input type="checkbox"/> No <input type="checkbox"/> N/A		
Verified Mix Design Number			
Qualified Products List	<input type="checkbox"/> Yes <input type="checkbox"/> No <input type="checkbox"/> N/A		
Compaction Test	<input type="checkbox"/> Yes <input type="checkbox"/> No <input type="checkbox"/> N/A		
Bill of Landing-Emulsified Asphalt	<input type="checkbox"/> Yes <input type="checkbox"/> No <input type="checkbox"/> N/A		
Bill of Landing-Asphalt Binder	<input type="checkbox"/> Yes <input type="checkbox"/> No <input type="checkbox"/> N/A		
Certified Ticket	<input type="checkbox"/> Yes <input type="checkbox"/> No <input type="checkbox"/> N/A		
Small Quantity	<input type="checkbox"/> Yes <input type="checkbox"/> No <input type="checkbox"/> N/A		
Field Note Record Date	Quantity on Field Note Record	Field Note Record Verified	
Is this project on a NHS Rate?	<input type="checkbox"/> Yes <input type="checkbox"/> No		
If so, is the tester certification on file?	<input type="checkbox"/> Yes <input type="checkbox"/> No		
Comments			
Acceptable	<input type="checkbox"/>	Deficiency as Needed	<input type="checkbox"/>

Concrete

Agency		Date
Project Title		Federal Aid Project Number
Reviewed By		
Bid Item		Material
Lag Exception Noted	<input type="checkbox"/> Yes <input type="checkbox"/> No	Plan Quantity _____
ROM Maintained	<input type="checkbox"/> Yes <input type="checkbox"/> No	Paid Quantity _____
Conc. Pipe Acc. Report	<input type="checkbox"/> Yes <input type="checkbox"/> No <input type="checkbox"/> N/A	RAM# _____
Small Quantity	<input type="checkbox"/> Yes <input type="checkbox"/> No	Codes _____
Certified Ticket	<input type="checkbox"/> Yes <input type="checkbox"/> No	Mix Design # _____
WSDOT Inspected	<input type="checkbox"/> Yes <input type="checkbox"/> No <input type="checkbox"/> N/A	Mill Test Report-Bulk PC _____
Acceptance Test-Agg.	<input type="checkbox"/> Yes <input type="checkbox"/> No	Approved Source-Pit #/Agg. _____
Prelim. Sample-Agg.	<input type="checkbox"/> Yes <input type="checkbox"/> No <input type="checkbox"/> N/A	
Cylinder	<input type="checkbox"/> Yes <input type="checkbox"/> No <input type="checkbox"/> N/A	
Plant Certificate	<input type="checkbox"/> Yes <input type="checkbox"/> No	
Qualified Products List	<input type="checkbox"/> Yes <input type="checkbox"/> No <input type="checkbox"/> N/A	
Cert. of Material Origin	<input type="checkbox"/> Yes <input type="checkbox"/> No <input type="checkbox"/> N/A	
Visual Inspection	<input type="checkbox"/> Yes <input type="checkbox"/> No	
Field Note Record Date	Quantity on Field Note Record	Field Note Record Verified
Is this project on a NHS Rate? <input type="checkbox"/> Yes <input type="checkbox"/> No If so, is the tester certification on file? <input type="checkbox"/> Yes <input type="checkbox"/> No		
Comments		
Acceptable <input type="checkbox"/> Deficiency as Needed <input type="checkbox"/>		

Mobilization

Agency _____	Date _____
Project Title _____	Federal Aid Project Number _____

Standard Specification 1-09.7

Contract Bid Amount _____	Mobilization Bid Amount _____
5% of Contract Bid Amount _____	50% of Mobilization Bid Amount _____
10% of Contract Bid Amount _____	
Mobilization Paid on Estimate No. _____	
Contract Items Paid That Estimate _____	Mobilization Paid That Estimate _____
Contract Items Paid To Date _____	
Mobilization Paid on Estimate No. _____	
Contract Items Paid That Estimate _____	Mobilization Paid That Estimate _____
Contract Items Paid To Date _____	
Mobilization Paid on Estimate No. _____	
Contract Items Paid That Estimate _____	Mobilization Paid That Estimate _____
Contract Items Paid To Date _____	
Mobilization Paid After Substantial Completion _____	

Notes:

1. When 5 percent of the total original contract amount is earned from other contract items, excluding amounts paid for materials on hand, 50 percent of the amount bid for mobilization, or 5 percent of the total original contract amount, whichever is the least, will be paid.
2. When 10 percent of the total original contract amount is earned from other contract items, excluding amounts paid for materials on hand, 100 percent of the amount bid for mobilization, or 10 percent of the total original contract amount, whichever is the least, will be paid.
3. When the substantial completion date has been established for the project, payment of any amount bid for mobilization in excess of 10 percent of the total original contract amount.

Acceptable Corrections Needed

Appendix 53.52 *Final Inspection of Federal Aid Project*



Final Inspection of Federal Aid Project *Constructed Under 23 U.S.C. 117*

Project Title		
Federal Aid Number	Contract Number	Agency
Date of Inspection	Inspection Made By	

Compliance					
Marking and signing in conformance with MUTCD?	<input type="checkbox"/> Yes	<input type="checkbox"/> No	NEPA requirements met?	<input type="checkbox"/> Yes	<input type="checkbox"/> No
Clear Zone requirements met?	<input type="checkbox"/> Yes	<input type="checkbox"/> No	ADA requirements met?	<input type="checkbox"/> Yes	<input type="checkbox"/> No

Comments:

Notable Items (i.e., labor disputes, changed conditions, environmental, shutdowns, etc.):

This project has been completed in substantial conformance with the project prospectus and contract plans.

Signature of Local Programs Engineer	Date
--------------------------------------	------

DOT Form 140-500
Revised 01/2017

Appendix 53.53 Vacant



PAYROLL

(For Contractor's Optional Use; See Instructions at www.dol.gov/whd/forms/wh347instr.htm)
Persons are not required to respond to the collection of information unless it displays a currently valid OMB control number.

U.S. Department of Labor
 Wage and Hour Division

OMB No.: 1235-0008
 Expires: 02/28/2018

NAME OF CONTRACTOR OR SUBCONTRACTOR PROJECT AND LOCATION PROJECT OR CONTRACT NO.

PAYROLL NO.

(1) NAME AND INDIVIDUAL IDENTIFYING NUMBER (i.e., LAST FOUR DIGITS OF SOCIAL SECURITY NUMBER OF WORKER)	(2) EMPLOYER'S IDENTIFICATION NUMBER (EIN)	(3) WORK CLASSIFICATION	(4) DAY AND DATE		(5) TOTAL HOURS	(6) RATE OF PAY	(7) GROSS AMOUNT EARNED	(8) DEDUCTIONS				(9) NET WAGES PAID FOR WEEK
			HOURS	DATE				FICA	WITH- HOLDING TAX	OTHER	TOTAL DEDUCTIONS	

While completion of Form WH-347 is optional, it is mandatory for covered contractors and subcontractors performing work on Federally financed or assisted construction contracts to respond to the information collection contained in 29 C.F.R. §§ 3.1, 5.5(a), The Contract Act (40 U.S.C. § 3145) contractors and subcontractors performing work on Federally financed or assisted construction contracts to "furnish weekly a statement with respect to the wages paid each employee during the preceding week." U.S. Department of Labor (DOL) regulations at 29 C.F.R. § 5.5(a)(3)(ii) require contractors to submit weekly a copy of all payrolls to the Federal agency contracting for or financing the construction project, accompanied by a signed "Statement of Compliance" indicating that the payrolls are correct and complete and that each laborer or mechanic has been paid not less than the proper Davis-Bacon prevailing wage rate for the work performed. DOL and federal contracting agencies receiving this information review the information to determine that employees have received legally required wages and fringe benefits.

Public Burden Statement
 We estimate that it will take an average of 55 minutes to complete this collection, including time for reviewing instructions, searching existing data sources, gathering and maintaining the data needed, and completing and reviewing the collection of information. If you have any comments regarding these estimates or any other aspect of this collection, including suggestions for reducing this burden, send them to the Administrator, Wage and Hour Division, U.S. Department of Labor, Room S3502, 200 Constitution Avenue, N.W., Washington, D.C. 20210

(over)

(b) WHERE FRINGE BENEFITS ARE PAID IN CASH

— Each laborer or mechanic listed in the above referenced payroll has been paid, as indicated on the payroll, an amount not less than the sum of the applicable basic hourly wage rate plus the amount of the required fringe benefits as listed in the contract, except as noted in section 4(c) below.

(c) EXCEPTIONS

EXCEPTION (CRAFT)	EXPLANATION

REMARKS:

NAME AND TITLE	SIGNATURE

THE WILLFUL FALSIFICATION OF ANY OF THE ABOVE STATEMENTS MAY SUBJECT THE CONTRACTOR OR SUBCONTRACTOR TO CIVIL OR CRIMINAL PROSECUTION. SEE SECTION 1001 OF TITLE 18 AND SECTION 231 OF TITLE 31 OF THE UNITED STATES CODE.

Date _____
 I, _____ (Name of Signatory Party) _____ (Title)
 do hereby state:

(1) That I pay or supervise the payment of the persons employed by _____ (Contractor or Subcontractor) _____ on the _____ (Building or Work) _____; that during the payroll period commencing on the _____ day of _____, and ending the _____ day of _____ all persons employed on said project have been paid the full weekly wages earned, that no rebates have been or will be made either directly or indirectly to or on behalf of said _____ (Contractor or Subcontractor) _____ from the full weekly wages earned by any person and that no deductions have been made either directly or indirectly from the full wages earned by any person, other than permissible deductions as defined in Regulations, Part 3 (29 C.F.R. Subtitle A), issued by the Secretary of Labor under the Copeland Act, as amended (48 Stat. 948, 63 Stat. 108, 72 Stat. 967, 76 Stat. 357; 40 U.S.C. § 3145), and described below.

(2) That any payrolls otherwise under this contract required to be submitted for the above period are correct and complete; that the wage rates for laborers or mechanics contained therein are not less than the applicable wage rates contained in any wage determination incorporated into the contract; that the classifications set forth therein for each laborer or mechanic conform with the work he performed.

(3) That any apprentices employed in the above period are duly registered in a bona fide apprenticeship program registered with a State apprenticeship agency recognized by the Bureau of Apprenticeship and Training, United States Department of Labor, or if no such recognized agency exists in a State, are registered with the Bureau of Apprenticeship and Training, United States Department of Labor.

(4) That: (a) WHERE FRINGE BENEFITS ARE PAID TO APPROVED PLANS, FUNDS, OR PROGRAMS — in addition to the basic hourly wage rates paid to each laborer or mechanic listed in the above referenced payroll, payments of fringe benefits as listed in the contract have been or will be made to appropriate programs for the benefit of such employees, except as noted in section 4(c) below.

Chapter 61 *Local Agency Force Projects*

61.1 **General Discussion**

Congress determined that competitive bidding is the preferred method of performing projects. Local agencies using their own forces to construct Federal Highway Administration (FHWA) projects must demonstrate that this is the most cost-effective method. Federal regulations clearly indicate that, in the absence of an emergency situation, circumstances are unlikely to justify the use of agency force construction. Therefore, the consideration of any noncompetitive construction contracting method requires a cost effectiveness determination as well as an evaluation demonstrating that it is in the best interest of the public to complete the project by means other than competitive bidding. It is deemed cost effective to do minor adjustments of railroad and utility facilities with agency, utility, or railroad forces (major work still to be accomplished by competitive bidding). Only local agencies operating under CA may administer an FHWA project using agency forces. It is the responsibility of the agency to ensure that the agency-force work is within its day labor statutory limits for construction costs (refer to [RCW 36.77](#) and [35.77](#)).

Projects may be designed and constructed by one local agency on behalf of another when approved by the Washington State Department of Transportation (WSDOT).

This chapter addresses the differences between Local Ad and Award, local administered projects by contract and bidders, [Chapters 46](#) and [52](#), and construction performed by the Local Agency forces.

The development of a project for construction by local agency forces follows the same procedures as for a competitive bid contract as defined in [Chapters 43](#) and [44](#) through the right of way acquisition process ([Chapter 25](#)).

61.2 **PS&E Requirements**

The requirements of [Chapter 44](#), will apply to the design and development of these projects.

61.3 **PS&E Approval**

The PS&E must be approved as described in [Chapter 44](#).

61.4 **Approval for Use of Agency Forces**

Prior to requesting funding authorization the agency must obtain approval from WSDOT for use of agency or railroad forces for construction. The request must clearly identify that the agency is requesting approval for construction activities that will be completed with agency or railroad forces. The cost-effectiveness determination/public interest finding must be provided as an attachment.

The Public Interest Finding must demonstrate value to the public and include the following:

- Short Project Summary/Description.
- Cost Estimate Comparing Agency Force to Contracted Construction.
- Sources of Materials – Competitive Bid Procurement Contract (new or existing must meet Buy America Requirements).
- Schedule Implications if Appropriate.
- Justification of why it is in the Best Public Interest including Public Benefit.
- Determination of cost effectiveness.
- Backup materials – detailed cost estimate both for agency and contract, consider all costs (contract development and administration).

61.5 Fund Authorization

A supplement to the Local Agency Agreement ([Chapter 22](#)) must be submitted to the Region Local Programs Engineer requesting authorization of construction funds. Any work started prior to authorization will be ineligible for federal reimbursement.

61.6 Contract Number

Construction work by local forces shall not start until a Local Programs contract number has been obtained from the Region Local Programs Engineer.

61.7 Construction Administration

.61 General Discussion – FHWA and the Washington State Department of Transportation (WSDOT) are responsible for the proper expenditure of FHWA funds on local agency projects. In this capacity, Region Local Programs Personnel will consult and work with local agencies as needed and will perform systematic project management reviews to ensure that proper procedures are followed.

General guidelines for construction will be administered in accordance with [Chapter 52](#). Materials will be inspected in accordance with the [Construction Manual M 41-01](#) and [Chapter 52](#). (In case of conflicting guidelines, [Chapter 52](#) governs over the [Construction Manual](#).)

.62 Preconstruction Conference – Refer to [Chapter 52](#).

.63 Quality Control. The quality of materials and workmanship on the project must conform to the project specifications so that the public funds expended will have purchased a safe, economical, and fully functional transportation facility. Refer to [Chapter 52](#).

.64 Progress Billing – Progress billing must be based on all work performed. Costs of the labor, equipment, and material must be documented, as described in [Chapter 23](#).

.65 Changes and Extra Work – An agency should have a written policy for the approval of change orders to ensure that approval, either verbal or written, is given and documented prior to beginning work.

Whenever a change in the project work is required, the Local Agency shall prepare a change order and submit it to the approving authority for approval. This procedure is described in [Chapter 52](#).

.66 Completion of Construction – The local agency will carry out the following requirements to ready the project for acceptance by WSDOT:

- **Final Inspection** – Within 15 calendar days after completion of the work by agency forces, the Local Agency Project Engineer shall notify the Region Local Programs Engineer that the contract work is complete and request a final inspection and acceptance. Refer to [Chapter 52](#).
- **Final Reports** – A construction project is complete when the items listed below are submitted by the Local Agency to the Region Local Programs Engineer or the approving authority.
 1. **Final Billing** (approving authority file).
 2. **Comparison of Preliminary and Final Costs** (approving authority file) – A listing showing the preliminary and final costs of the labor, equipment, and material.
 3. **Final Records** (approving authority file) – The Local Agency Project Engineer must document the work performed on the project. Documentation consists of any field books, inspector’s record of field tests, project engineer’s and inspector’s diaries, all invoices, weigh bills, truck measurements, quantity tickets, receiving reports, field office ledgers, mass diagrams, cross-sections, computer listings, work profiles, approved time slips, etc., when they are a basis of payment for work performed or material furnished. Photographs or video before, during, and after construction could be useful, especially if care is taken to show any unusual conditions, equipment, or procedures.

Final records shall be retained as specified in [Chapter 53](#).
 4. **Record of Material Samples and Tests** – Records of samples and tests will be retained by the local agency for at least three years following acceptance of the project by the Director, Local Programs.
 5. **Materials Certification** ([Chapter 52](#)) – The intent of the material certification is to assure that the quality of all materials incorporated into the project is in conformance with the plans and specifications and thus ensures a service life equivalent to the design life.

This material certification shall be completed in accordance with Sections 9-1.5C and 9-5.4 of the [Construction Manual](#), and the sample in [Chapter 52](#).

This certification shall be retained by the local agency as specified in [Chapter 53](#).

61.8 Project By One Agency for Another Agency

WSDOT approval is required whenever one local agency uses its forces to perform construction work for another agency. The request for approval shall include the following information:

- Kinds of work to be performed.
- Two cost estimates or other types of justifications; one for contracted work, and one for work by agency forces.
- Reason(s) why the work to be performed by agency forces is considered cost-effective.

The cost estimate for the competitive bidding work may be based on unit prices, including any related engineering and administrative costs necessary to prepare, monitor, and close the project. The unit prices shall be based on competitive bidding on comparable construction work in the same general locality.

The requesting agency shall submit the request to the Region Local Programs Engineer.

The Project Development Checklist should be used to guide these projects.

61.9 Appendices

[61.91](#) Local Agency Force Preconstruction Conference – Example

Appendix 61.91 Local Agency Force Preconstruction Conference – Example

1. Order of Work
2. Utilities and Railroads
 - a. Local Agency project engineer prepare list of affected services and representative to be contacted.
 - b. Underground service should be located.
 - c. Notification time required by organizations.
 - d. Insurance required, if any.
3. Traffic Control and Safety
 - a. Uniform Traffic Control Devices Manual will control signing.
 - b. Review and discussion of traffic control plan (TCP).
 - c. Safety control on structures.
 - d. Flagman should use standard paddle and vest and must be certified with flagman card.
 - e. Speed regulation of construction equipment.
 - f. Local Agency project engineer designate by name the individual responsible for construction traffic control.
 - g. Safety and health requirements.
 - h. Request police to report all construction zone accidents to the Local Agency engineer.
4. Environmental Considerations
 - a. Commitment files.
 - b. Standard Specifications/Special Provisions.
5. General Construction Discussion
 - a. Local Agency engineer explains how he plans to pursue the work.
 - b. Review of anticipated construction problems.

List of Forms

	Form Number
Project Initiation	
Local Agency Federal Aid Project Prospectus	140-101
Local Agency Damage Inspection Report – FHWA Emergency Relief	300-001
Special Transportation Planning Study Agreement	224-080
Request Preliminary Engineering Funds	
Local Agency Agreement (Federal)	140-039
Local Agency Agreement Supplement (Federal)	140-041
Local Agency Agreement (State)	140-087
Local Agency Agreement Supplement (State)	140-087A
Progress Billing	
Federal Aid Request for Payment	Appendix 23.71
Final Project Summary	Appendix 23.75
Consultant Selection Process	
Independent Estimate for Consultant Services	140-012
Supplemental Agreement	140-063
Environmental	
Local Agency Environmental Classification Summary	140-100
Plans, Specifications, and Estimates	
Local Agency Railway Agreement	140-044
Required Contract Provisions, Federal Aid Construction Contracts	FHWA-1273
Local Ad and Award	
Award of Contract	
Contract Bond	FHWA-45
DBE Utilization Certification	272-056
Construction Administration	
Change Order – Local Agency	140-005
Change Order – Minor Change	421-005
Local Agency Quarterly Report of Amounts Credited as DBE Participation	422-103
Weekly Statement of Working Days Example Sheet	Appendix 52.105
Project Completion	
Final Inspection of Federal Aid Project	140-500
Local Agency Project Management Review Checklist	272-024
Final DBE Utilization Plan Report	272-055

The following forms are provided in Chapter 11 of the *Construction Manual M 41-01*.

Form Number	Rev. Date	Form Name
272-050	9-07	Apprentice/Trainee Approval Request
350-092	1-16	Asphalt Concrete Pavement Compaction Control Report
350-073	5-11	Asphalt Concrete Test Section Report
350-126	8-97	Asphalt Plant Inspection
540-020	8-15	Backflow Prevention Assembly Test Report
140-043	10-06	Certification Acceptance Qualification Agreement
420-004	3-08	Certification for Federal-Aid Projects
350-109	7-12	Certification of Materials Origin
540-509	8-15	Commercial Pesticide Application Record
350-009	7-02	Concrete Cylinder Transmittal
350-115	2-10	Contract Materials Checklist
421-040A & B	10-04/3-08	Contractor's Daily Report of Traffic Control – Traffic Control Log
350-112	8-14	Correlation Nuclear Gauge to Core Density
351-015	11-97	Daily Compaction Test Report
422-008	6-16	Daily Report of Force Account Worked
422-644	12-95	Daily Report of BST Operations
300-001	6-16	Detailed Damage Inspection Report FHWA Emergency Relief
424-003	12-96	Employee Interview Report
421-014	1-97	Examination Sheet for Contract Items
750-001	10-97	Fall Protection Plan
272-060	12-04	Federal-Aid Highway Construction Annual Project Training Report
FHWA-1391	9-15	Federal-Aid Highway Construction Contractors' Annual EEO Report
272-061	8-03	Federal-Aid Highway Construction Cumulative Training Report
FHWA-1392	9-15	Federal-Aid Highway Construction Summary of Employment Data
350-130	3-08	Field Acceptance Report for Qualified Products
350-074	3-10	Field Density Test Report (Nuclear Gauge)
422-635	3-08	Field Note Record
422-637	3-08	Field Note Record for Drainage
422-636	9-96	Field Note Record (Sketch Grid)
134-146	10-07	Final Contract Voucher Certificate
422-009	2-96	Final Record Notes
422-009B	2-96	Final Record Notes
230-036B	3-07	Follow-Up Documentation Review
422-010	7-10	Force Account Equipment Rate Request
350-564	1-96	Gradation Chart 0.45 Power
230-036A	1-16	Initial Documentation Review (Procedures)
422-100	6-03	Inspection of Federal Aid Project
422-004	3-08	Inspector's Daily Report
422-004A	7-08	Inspector's Daily Report
422-004B	2-96	Inspector's Daily Report
422-020	4-11	Inspector's Record of Field Test

Form Number	Rev. Date	Form Name
422-103	8-16	Local Agency Monthly Report of Amounts Credited as DBE Participation
272-051	5-15	DBE On-Site Review for Architect & Engineering/Professional Services Firms
272-052	5-15	DBE On-Site Review for Construction Subcontractors / Dealers / Manufactures
450-001	1-96	Manufacturer's Certificate of Compliance for Ready Mixed Concrete
820-010	6-99	Monthly Employment Utilization Report
421-007	5-06	Order to Resume Work
421-006	10-11	Order to Suspend Work
450-005	3-02	Post-Tensioning Record
350-026	5-02	Preliminary Sample Transmittal
421-010	5-15	Prime Contractor Performance Report
350-040	5-14	Proposed Mix Design
420-012	1-96	Recommended Changes to Specifications and Construction Manual
421-009	6-12	Release Retained Percentage (Except Landscaping)
350-042	6-16	HMA Mix Design Submittal
422-007	3-08	Report of Protested Work
350-071	12-12	Request for Approval of Material
421-012	4-16	Request to Sublet Work
350-056	1-09	Sample Transmittal
422-027	10-11	Scaleman's Daily Report
FHWA-47	7-98	Statement of Materials and Labor Used by Contractors on Highway Construction Involving Federal Funds
272-049	3-12	Training Program
410-025	3-02	Project Engineer Transmittal Checklist
350-572	6-04	Manufacturer's Certificate of Compliance Checklist

Abbreviations and Glossary

Abbreviations

AASHTO – American Association of State Highway and Transportation Officials

ACHP – Advisory Council on Historic Preservation

ACP – Asphalt Concrete Pavement

ADA – Americans with Disabilities Act

ADT – Average Daily Traffic

AG – Agricultural

AG – Attorney General

AGC – Associated General Contractors

AMRL – AASHTO Materials Reference Laboratory

ANSI – American National Standards Institute

APBP – Association of Pedestrian and Bicycle Professionals

APE – Area of Potential Effects

APWA – American Public Works Association

ATB – Asphalt Treated Base

BA – Biological Assessment

BE – Biological Evaluation

BIC – Bridge Inspection Committee

BFRC – Benton-Franklin Regional Council

BMP – Best Management Practices

BMS – Bridge Management System

BO – Biological Opinion

BRAC – Bridge Replacement Advisory Committee

BRR – Bridge Replacement and Rehabilitation, a federal aid funding program administered by FHWA and WSDOT

CA – Certification Acceptance

CAAA – Clean Air Act Amendments of 1990

CAO – Critical Area Ordinance

CAPP – County Arterial Preservation Program

CCIS – Construction Contracts Information System
CCRL – Cement and Concrete Reference Laboratory
CE – Construction Engineering
CE (NEPA) – Categorical Exclusions
CE (SEPA) – Categorical Exemptions
CEQ – Federal Council on Environmental Quality
CFDA – Catalog of Federal Domestic Assistance
CFR – Code of Federal Regulations
CM/AQ – Congestion Mitigation and Air Quality Program
CMS – Congestion Management System
COA – Condition of Award
COE – U.S. Army Corps of Engineers
COG – Council of Governments
CRAB – County Road Administration Board
CRS – Cultural Resource Survey
C3R – Close, Repair, Rehabilitate, or Replace
CTR – Commute Trip Reduction
CUF – Commercially Useful Function (DBE)
CZMP – Coastal Zone Management Program
CZMA – Coastal Zone Management Act

DAF – Damage Assessment Forms
DB – Disadvantaged Business
DBE – Disadvantaged Business Enterprise
DCE – Documented Categorical Exclusion
DCD/DEM – Department of Community Development/Division of Emergency Management
DEIS – Draft Environmental Impact Statement
DFO – Disaster Field Offices
DHV – Design Hourly Volume
DIR – Damage Inspection Report
DNR – Department of Natural Resources

DNS – Declaration of Nonsignificance (SEPA Document)
DOC – Federal Department of Commerce
DOE – Washington State Department of Ecology
DOI – Federal Department of the Interior
DOT – Federal Department of Transportation (same as USDOT)
DPS – Distinct Population Segment
DRM – Disaster Recovery Manager
DSR – Damage Survey Reports
DS&S – Decent, Safe, and Sanitary (housing)
DT – Diagnostic Team
DV – Determination of Value

EA – Environmental Assessment; Economic Area
ECR – External Civil Rights
ECS – Environmental Classification Summary
EEO – Equal Employment Opportunity
EFH – Essential Fish Habitat
EIS – Environmental Impact Statement
EMD – Emergency Management Division
EO – Executive Order
EPA – Federal Environmental Protection Agency
EPM – *Environmental Procedures Manual*
EQA – Environmental Quality Administrator
ER – Emergency Relief
ERFO – Emergency Relief for Federally-Owned Lands
ESA – Endangered Species Act
ESU – Evolutionarily Significant Unit

FA – Federal Aid
FAA – Federal Aviation Administration
FAPG – Federal Aid Policy Guide
FBD – Ferry Boat Discretionary

FCR – Final Cost Report
FEIS – Final Environmental Impact Statement
FEMA – Federal Emergency Management Agency
FERC – Federal Energy Regulatory Commission
FFRF – Federal Forest Reserve Fund
FHWA – Federal Highway Administration
FLH – Federal Lands Highway
FMIS – Federal Management Information System
FMSIB – Freight Mobility Strategic Investment Board
FMV – Fair Market Value
FONSI – Finding of No Significant Impact
FTA – Federal Transit Administration
FWCA – Fish and Wildlife Coordination Act
FWPCA – Federal Water Pollution Control Act
F&WS – Federal Fish and Wildlife Service (also USFWS)

GAR – Governor’s Authorized Representative
GMA – Growth Management Act
GSP – General Special Provisions

HBRRP – Highway Bridge Replacement and Rehabilitation Program
HHS, HES – High Hazard Safety and Hazard Elimination & Safety Programs
HOV – High-occupancy Vehicle
HPA – Hydraulic Project Approval
HPR – Highway Planning and Research Projects
HQ – Headquarters
HRM – *Highway Runoff Manual*
HUD – Federal Department of Housing and Urban Development
H&LP – Highways and Local Programs

IC – Interstate Completion
IDT – Interdisciplinary Team
IM – Instructional Memorandum (FHWA document)

IM – Interstate Maintenance

IMS – Intermodal Management System

ISTEA – Intermodal Surface Transportation Efficiency Act of 1991

ITE – Institute of Transportation Engineers

KP – Kilometer Post

LA – Local Agency

LAG – *Local Agency Guidelines*

LF – Load Factor

LPA – Local Public Agency

LPE – Local Programs Engineer

LRFD – Load and Resistance Factor Design

LRP – Long-Range Plan

LTAA – Likely To Adversely Affect

LTAP – Local Technical Assistance Program

L&I – Washington State Department of Labor and Industries

MOA – Memorandum of Agreement

MP – Milepost

MPO – Metropolitan Planning Organization

MSA – Metropolitan Statistical Area

MSD – Material Sources Data

MUTCD – *Manual on Uniform Traffic Control Devices*

NAAQS – National Ambient Air Quality Standards

NACHP – National Advisory Council for Historic Preservation

NBI – National Bridge Inventory

NBIS – National Bridge Inspection Standards

NCHRP – National Cooperative Highway Research Program

NEPA – National Environmental Policy Act; see also SEPA

NHPA – National Historic Preservation Act

NHS – National Highway System

NICET – National Certification in Engineering Technologies

NLTAA – Not Likely To Adversely Affect

NMFS – National Marine Fisheries Service

NOAA – National Oceanic & Atmospheric Administration

NPDES – National Pollutant Discharge Elimination System

NPS – National Park Service of the Federal Department of the Interior

NR – New/reconstruction

NWPMA – Northwest Pavement Management Association

NWP – Nationwide Permit (U.S. Army Corps of Engineers)

OA – Obligation Authority

OAHP – Office of Archaeological and Historic Preservation

OEO – WSDOT’s Office of Equal Opportunity

OFCCP – Office of Federal Contract Compliance Programs
(U.S. Department of Labor)

OFM – Washington State Office of Fiscal Management

OJT – On-the-Job Training

OMB – Federal Office of Management and Budget

OMWBE – Washington State Office of Minority and Women’s Business Enterprise

OST – Office of the Secretary of Transportation

PCAA – Washington State Planning and Community Affairs Agency

PCC – Portland Cement Concrete

PDA – Preliminary Damage Assessment

PDEIS – Preliminary Draft Environmental Impact Statement

PE – Preliminary Engineering; also Professional Engineer

PFE – Project Funding Estimate

PL – Public Law

PM – Project Manage

PM-10 – Particulate Matter - 10 Microes

PMR – Project Management Review

PMS – Pavement Management System

P&PSC – Planning and Programming

PPM – Policy and Procedure Memorandum

PR – Preliminary Report

PSRC – Puget Sound Regional Council

PS&E – Plans, Specifications, and Estimate

PTMS – Public Transportation Management System

RCW – Revised Code of Washington

RFP – Request for Proposal

RFQQ – Request for Quotation and Qualification

RLPE – Region Local Programs Engineer

ROD – Record of Decision

RRP, RRS – Railway-Highway Grade Crossing

RTPO – Regional Transportation Planning Organization

R&D – Research and Development

R/R – Railroad, Railway

R/W – Right of Way

SCS – Soil Conservation Service (U.S. Department of Agriculture)

SDWA – Safe Drinking Water Act

SEIS – Supplemental Environmental Impact Statement

SEPA – State of Washington Environmental Policy Act

SHPO – (Washington) State Historical Preservation Officer

SIP – State Implementation Plan

SMS – Safety Management System

SMSA – Standard Metropolitan Statistical Area

SOV – Single Occupancy Vehicle

SRTC – Spokane Regional Transportation Council

SSP – Stormwater Site Plan

STIP – Statewide Transportation Improvement Program

STP – Surface Transportation Program

STRAHNET – Strategic Highway Network

SWIBS – State of Washington Inventory of Bridges and Structures

SWRTC – Southwest Washington Regional Transportation Council

SWW – Southwest Washington

TCP – Traffic Control Plan

TCM – Transportation Control Measures

TCP – Traditional Tribal Property

TDM – Transportation Demand Management

TEA-21 – Transportation Equity Act for the 21st Century

TESC – Temporary Erosion and Sedimentation Control

TESC – The Evergreen State College

THPO – Tribal Historic Preservation Officer

TIB – Transportation Improvement Board

TIP – Transportation Improvement Program

TMA – Transportation Management Areas

TMS – Traffic Monitoring System

TRB – Transportation Research Board

TRICO – Tricounty

TRPC – Thurston Regional Planning Council

TSM – Transportation System Management

TSME – Transportation Systems Management Element

TS&L – Type, Size, and Location Stage of Design

TTP – Traditional Tribal Property

T2 – Technology Transfer

UBIT – Under Bridge Inspection Truck

USC – United States Code

USDA/USDOA – United States Department of Agriculture

USDOL – United States Department of Labor

USDOT – United States Department of Transportation (same as DOT)

USFS – United States Forest Service

USFWS – United States Fish and Wildlife Service (also F&WS)

UZA – Urbanized Area

VE – Value Engineering

WAC – Washington Administrative Code
WBE – Women’s Business Enterprise
WCOG – Whatcom Council of Governments
WDFW – Washington State Department of Fish and Wildlife
WOAP – Work Order Accounting Plan
WRIA – Water Resource Inventory Area
WS – Working Stress
WSBIS – Washington State Bridge Inspection System
WSDES – Washington State Department of Emergency Services
WSDOT – Washington State Department of Transportation
WSEO – State of Washington Energy Office
WST2 – Washington State Technology Transfer
WUTC – Washington Utilities and Transportation Commission
YVCOG – Yakima Valley Council of Governments
2-R – Resurfacing and Restoration
3-R – Resurfacing, Restoration, and Rehabilitation

Glossary of Terms

ADA – The Americans with Disabilities Act of 1990 which mandates sweeping changes in building codes, transportation, and hiring practices to prevent discrimination against persons with disabilities, not just in projects involving federal dollars, but all new public places, conveyances, and employers.

Ad and Award – Advertising and award of a construction contract. Includes all aspects of contract administration.

Administrative Settlement – A negotiated settlement of a right of way acquisition case in which the acquiring agency has administratively approved payment in excess of fair market value as shown on the agency’s approved determination of value (DV).

Agency Administrator – A local agency official empowered by position or delegated the authority to administer transportation projects.

Agency-Force Work – Construction work done by an agency’s employees, or by one public agency for another.

Annual Average Daily Traffic (AADT) – The estimate of typical daily traffic on a road segment for all days of the week, Sunday through Saturday, over the period of one year.

Annual Element – The first year of a local agency’s six-year Street or Road Program which is reviewed each year by the Areawide Clearinghouse to ensure intergovernmental coordination of transportation programs.

Annual Seasonal Factors – The set of 12 factors, one for each month of the year, that is used to adjust coverage counts to estimates of AADT. Annual seasonal factors make use of the full year’s data collected by continuous counters.

Approval Authority – The position title designated in the Certification Acceptance Qualification Agreement as responsible for approving a document or stage of a federal aid transportation project.

APWA Amendments – A supplement to the WSDOT/APWA Standard Specifications.

Areawide Clearinghouse – A regional planning agency that reviews the transportation programs of constituent agencies to ensure areawide coordination.

Automatic Traffic Recorder – A device that records the continuous passage of vehicles across all lanes of a given section of roadway by hours of the day, days of the week, or months of the year.

CA – Certification Acceptance, the process of approving local agencies to administer their federal aid transportation projects.

CAAA – The Clean Air Act Amendments of 1990 identify “mobile sources” (vehicles) as primary sources of pollution and call for stringent new requirements in metropolitan areas and states where attainment of National Ambient Air Quality Standards (NAAQS) is or could be a problem.

CE (NEPA) – Categorical exclusions, actions that do not individually or cumulatively have a significant effect on the environment.

CE (SEPA) – Categorical exemptions, actions that do not individually or cumulatively have a significant effect on the environment. CEQ – Federal Council on Environmental Quality.

CFR – The codified administrative regulations of the federal government.

CM/AQ – The Congestion Mitigation and Air Quality Program is a \$6 billion funding program contained in Title I of ISTEA. Funds are provided for projects and activities which reduce congestion and improve air quality.

CMS – Congestion Management Systems require large metropolitan areas (200,000 population or more) and states to develop management plans which make new and existing transportation facilities more effective through the use of travel demand management and operational management strategies.

COG – Council of Governments is a voluntary consortium of local government representatives, from contiguous communities, meeting on a regular basis and formed to cooperate on common planning and to solve common development problems of their area.

C3R – Close, repair, rehabilitate, or replace options to improving existing public bridges.

CTR – The Commute Trip Reduction which requires major employers in the eight most populated counties in the state to take measures to reduce the number of single occupant vehicle (SOV) trips and the number of vehicle miles traveled (VMT) by their employees.

City/County, Local Agency, or Agency – Any municipal corporation within the state of Washington.

Class I Projects – Those projects likely to have a significant impact and requiring an EIS.

Class II Projects – Those projects with no significant impact and excluded from environmental documentation requirements.

Class III Projects – Those projects in which the significance of impacts is not established. Such projects require an EA to evaluate the extent of the project impacts.

Coastal Zone Management – Applicants for federal permits or licenses must certify that their project will comply with the State Coastal Zone Management Program (Shoreline Management Act–[RCW 90.58](#)–applies to projects within 61 m (200 feet) of a shoreline).

Coast Guard Permit – A permit issued by the Coast Guard for all structures in navigable waterways (Rivers and Harbors Act (33 USC9)).

Commitment File – A file containing a summary of local agency commitments made to other agencies or groups during project development which will be incorporated into the design and construction of a project.

Community – A major subdivision of a municipality, composed of neighborhoods, considered as a unit for planning purposes.

Completion Letter – A letter from the local agency Engineer notifying the construction contractor that a project is complete. A letter from the local agency notifying the Region Local Programs Engineer that the project is complete subject to inspection, audit, and acceptance by the state. The letter is required on competitive bid contracts and local agency force projects.

Construction – Those activities that are involved in the building of a new road facility or improvement of an existing facility to a higher geometric or structural standard or serve to increase the capacity or efficiency of an existing facility.

Consultant – An individual, public or private organization or institution of higher learning having expertise in professional disciplines applicable to transportation programs.

Consultant Service – Utilization of professional expertise external to an agency, on a contract basis, to perform a specific study, project, or task. Does not include personal-service contracts for routine, continuing, and necessary tasks.

Continuous Counter – An automatic traffic recorder that operates continuously for all hours of a year.

Corridor Hearing – See location hearing.

Coverage Count – A traffic count taken as part of the requirement for system-level estimates of traffic. The count is typically short-term, and may be volume, classification, or weigh-in-motion.

DBE – Disadvantaged business enterprise, a small business concern: (a) which is at least 51 percent owned by one or more socially and economically disadvantaged individuals, or, in the case of any publicly-owned business, at least 51 percent of the stock of which is owned by one or more socially and economically disadvantaged individuals; and (b) whose management and daily business operations are controlled by one or more of the socially and economically disadvantaged individuals who own it.

Declaration of Nonsignificance (SEPA Document) – The written decision by the agency administrator that a proposal will not have a significant environmental impact and no EIS is required ([WAC 197-11-340](#)).

Declaration of Significance (SEPA Document) – The written decision by the agency administrator that a proposal could have significant adverse impact and, therefore, requires an EIS ([WAC 197-11-340](#)).

DEIS – Draft Environmental Impact Statement, a document identifying a course of action, alternative actions, analysis of the environmental impacts of alternates considered, and proposed mitigation of impacts. The DEIS is circulated to other agencies and the public for review and comment.

Design Hearing – A public hearing to examine the design features of a proposed transportation facility.

Design Report – A formal documentation of design considerations and conclusions reached in the development of a project. The design report is prepared to record the evaluations of the various disciplines which result in design recommendations. This report is then reviewed and, upon concurrence, results in approval of the design. For most projects, the Project Prospectus serves as the design report.

Determination of Value – The agency’s approved fair market value of a right of way acquisition.

Deviation or Design Deviation – Departure from applicable design standards.

Discipline Report – A report documenting findings concerning impacts of a project relative to an individual area of expertise (e.g., botany, acoustics, sociology). The report evaluates the impacts of the proposal and, where appropriate, includes recommendations concerning the course of action considered most desirable to fulfill the requirements of environmental laws and regulations addressed by the discipline.

DNS – Declaration of Nonsignificance (SEPA Document), the written decision by the agency administrator that a proposal will not have a significant environmental impact and no EIS is required ([WAC 197-11-340](#)).

Draft Environmental Impact Statement (DEIS) – A document identifying a course of action, alternative actions, analysis of the environmental impacts of alternates considered, and proposed mitigation of impacts. The DEIS is circulated to other agencies and the public for review and comment.

EA – Environmental Assessment, a document prepared for federally funded, permitted, or licensed projects, that are not categorical exclusions (CE) but do not appear to be of sufficient magnitude to require an EIS. The EA provides sufficient analysis and documentation to determine if a Finding of No Significant Impact (FONSI) can be adopted or if an EIS must be prepared.

EEO – Equal Employment Opportunity. A general term referring to all contract provisions relative to EEO.

EIS – Environmental Impact Statement, a detailed written statement of project environmental effects required by state and/or federal law. This term refers to either a Draft or Final Environmental Impact Statement, or both, depending on context.

Environmental Checklist (SEPA Document) – A local agency document used to determine whether an action will significantly impact the environment. The checklist form contained in [WAC 197-11-960](#) is used for all actions not categorically exempt or not clearly requiring an EIS.

Environmental Document – A term used for any document that identifies the social, economic, and environmental effects of a proposed action.

ER – Emergency Relief, a federal aid funding program administered by FHWA and WSDOT.

ESU – Evolutionarily Significant Unit. A designation the National Marine Fisheries (NMFS) uses for certain, genetically unique, local salmonid populations or “runs.” These designations are treated as individual species under the act.

Fair Offer – An offer to acquire real property for just compensation, which is the approved appraisal of the property’s fair market value.

Federal Aid Requirement Checklist – A list of requirements for acquiring right of way on federal aid projects.

Federal Aid Project Prospectus – Page 1 is used for the FHWA federal aid programing purposes. Pages 2 and 3 give the state and FHWA additional information about the proposed project.

FEIS – Final Environmental Impact Statement, a document containing an evaluation of the course of action that an agency intends to follow. It contains the same information required for the DEIS, with appropriate revisions reflecting comments received from circulation of the DEIS and from public meetings.

Final Estimate – An estimate of the total cost of a project prepared after completion of the construction contract and used as the basis for final payment to the contractor.

Financial Responsibility Letter – A letter from the local agency approving authority advising the Local Programs Engineer that a construction contract may be awarded and that the agency will arrange for project funding above the amount in the current Local Agency Agreement.

Flood Hazard – Construction affecting a flood-control zone, through flooding, erosion, or deposition of materials.

Flood Control Zone – A zone subject to flooding, as defined on maps available from the Region Local Programs Engineer. **FONSI** – Finding of No Significant Impact, a federal lead-agency document presenting the reasons why a proposal will not significantly affect the environment and an EIS will not be prepared. The FONSI includes the EA and references any other related environmental documents.

Force-Account Work – Construction work not covered in the contract documents and of a type not amenable to definition by a change order. Force-account reimbursement is used when it is difficult to provide adequate measurement or to estimate the cost of certain items of work. The contractor is reimbursed for the cost of the work plus profit using established weighted wage rates, equipment-rental rates, and the invoice cost of materials.

Foreslopes – The roadway fill slope or ditch in slope.

Functional Classification – The roadway classifications referred to in this manual are the federal functional classifications shown on the official functional class maps prepared by WSDOT Planning and Programming. Examples: principal arterial, minor arterial, collector arterial.

Functional Classification – The grouping of streets and highways into classes, or systems, according to the character of service they are intended to provide. The recognition that individual roads do not serve travel independently and most travel involves movement through a network of roads is basic to functional classification.

Functional System – Highways of a similar type as determined by functional classification.

FTA – Federal Transit Administration (formerly the Urban Mass Transit Administration, UMTA).

FWS – Is an abbreviated acronym for USFWS (the United States Fish and Wildlife Service).

GSP – General Special Provisions, construction contract specifications supplementing the Standard Specifications.

Hearing Summary – Summary of comments received from the hearings and those received from the evaluation of the DEIS.

Highway Traffic Data – Estimates of the amounts of person or vehicular travel, vehicle usage, or vehicle characteristics associated with a system of highways or with a particular location on a highway. These types of data include estimates of the number of vehicles traversing a section of highway or system of highways during a prescribed time period (traffic volume), the portion of such vehicles that may be of a particular type (vehicle classification), the weights of such vehicles including weight of each axle and associated distances between axles on a vehicle (vehicle weight), or the average number of persons being transported in a vehicle (vehicle occupancy).

HHS, HES – Hazard Elimination, a federal aid funding program administered by FHWA and WSDOT.

HOV – High-occupancy vehicle, e.g. bus, van, carpool.

HPA – Hydraulic Power Approval permit is issued by the Washington Department of Fish and Wildlife. The Hydraulic Code ([RCW 75.20.100-160](#)) requires that any person, organization, or government agency wishing to conduct any construction activity in or near state waters must do so under the terms of a permit (the Hydraulic Project Approval – HPA, to be exact) issued by the Washington State Department of Fish and Wildlife. State waters include all marine waters and fresh waters of the state.

IDT – Interdisciplinary Team, a team composed of appropriate disciplines that identifies and evaluates social, economic, and environmental impacts of proposed projects.

Improvement – Betterment in traffic service without major changes in the existing facility. This includes widening, signals, illumination, curbs, gutters, drainage, sidewalks, and other items which add value to the existing facility.

ISTEA – Intermodal Surface Transportation Efficiency Act of 1991.

Lead Agency – A federal, state, or local agency taking primary responsibility for preparing an environmental document.

Liquidated Damages – Amounts of money to be assessed against a contractor for late completion. These amounts must be related to the actual damages suffered by the owner because of the late completion.

Local Agency Agreement – An agreement to allocate federal funds to a transportation project. Negotiated between a local agency and WSDOT.

Local Agency, City/County, or Agency – Any municipal corporation within the state of Washington.

Local Match – That portion of a project's cost paid for with local agency funds.

Location Hearing – A public hearing to examine the location of a proposed transportation facility, also called corridor or route hearing.

LRP – Long-Range Plan is a 20-year forecast plan, now required at both the metropolitan and state levels, which must consider a wide range of social, environmental, energy, and economic factors in determining overall regional goals and how transportation can best meet these goals.

Maintenance – Those activities that ensure that the right of way and each type of roadway, roadway structure and facility remain, as nearly as practical in its original, as constructed condition or its subsequently improved condition, and the operation of roadway facilities and services to provide satisfactory and safe motor vehicle transportation.

Matching Funds – See local match.

MPO – Metropolitan Planning Organization is the agency designated by the Governor (or governors in multistate areas) to administer the federally required transportation planning in a metropolitan area. An MPO must be in place in every urbanized area over 50,000 population. The MPO is responsible for the long-range plans and the transportation improvement program. The official name for an MPO may also be Council of Governments, Planning Association, Planning Authority, Regional or Area Planning Council, Regional or Area Planning Commission.

MUTCD – *Manual on Uniform Traffic Control Devices for Streets and Highways*, USDOT and FHWA.

MSA and CMSA – Metropolitan Statistical Area is the census classifications for areas having a population over 50,000. The MSA may contain several urbanized areas, but contains one or more central city or cities. When the commuting patterns of two MSAs have caused them to merge, the result is a Consolidated Metropolitan Statistical Area (CMSA).

NAAQS – National Ambient Air Quality Standards were set by the Environmental Protection Agency to define air pollution. EPA established **NAAQS** measures for six pollutants: carbon monoxide, ozone, particulate matter, lead, sulfur dioxide, and nitrous oxide.

Neighborhood – A secondary subdivision of a municipality, a portion of a community, considered as a unit for planning purposes.

New Construction – The building of a new roadway or structure on substantially new alignment, or the upgrading of an existing roadway or structure by the addition of one or more lanes. If 50 percent or more of the project length involves vertical or horizontal alignment changes, the project is new construction. The following types of projects are not classed as new construction, and the 3-R standards apply:

- Modernization of an existing street or road by resurfacing, widening lanes, adding shoulders, or adding turn lanes at intersections.
- Temporary replacement of a street or roadway, immediately after the occurrence of a natural disaster or catastrophic failure, to restore the facility for the health, welfare, and safety of the public.

Nonparticipating Items – Items of project work that are not a part of the federal aid funding.

Notice of Intent – A federal notice, printed in the Federal Register, advising that an EIS will be prepared and considered for a proposal.

Obligation Authority – Under ISTEA, it is vested with WSDOT except for STP funded projects within TMA boundaries.

Opportunity for Hearing – Soliciting public interest in holding a hearing by publishing notice.

PL – Public law, the designation for a law passed by the U.S. Congress before codification into the USC.

P&PSC – Planning and Programming. WSDOT's branch responsible for coordinating with local agencies on planning issues.

PONTIS – A bridge management system created cooperatively by FHWA, the state of California, and six "technical advisory" states. Meets ISTEA requirements.

Prequalifying Prospective Bidders – A process by which a contracting agency in advance of considering, opening, or accepting bids, or in advance of issuing bid proposals, establishes limitations on amounts and types of work contractors are permitted to bid on and to have underway at one time.

Preservation – Those specialized maintenance activities that serve to extend the originally estimated useful life of each type of roadway, roadway structure and facility but do not increase its capacity or efficiency.

Progress Billing – A request from a local agency or contractor to WSDOT for state/federal reimbursement for work completed on a federal aid transportation project during a defined time period.

Progress Estimate – An estimate of the total amount of work completed by a contractor as of the estimate date listed by work item.

Progress Payment – A payment by a public agency to a consultant or construction contractor for work completed on a federal aid transportation project during a defined time period.

Project – An undertaking to construct.

Project Application Checklist

Project Engineer – The person designated by a local agency to oversee development of a project.

Project Management Review (PMR) – A review of an agency's project administration conducted by the WSDOT Local Programs Operations personnel.

Project Prospectus – A document prepared by a local agency and submitted to WSDOT describing a proposed transportation project. Used to support authorization of federal funds.

Proprietary Specifications – Those referring to specific products by trade name and model.

Prospectus Submittal Checklist – A checklist to help agencies assemble a complete Project Prospectus Package to submit for funding authorization.

Proximity Damages – An element of severance damages caused by the proximity of the remainder of a land parcel to the improvement being constructed, such as a highway. It may also arise from proximity to an objectionable site or improvement, or from all causes such as dirt, noise, or vibration.

Public Involvement Plan – A required, integral part of an environmental study plan which outlines procedures for presenting information to the public, obtaining public comment, and considering public opinion.

Quad County (Quad-Co) – A Regional Transportation Planning Organization that includes Adams, Grant, Kittitas, and Lincoln Counties.

Qualifying Low Bidders – A process by which a contracting agency proceeds, after bid opening, to consider the qualifications of the apparent low bidder to perform the work.

Record of Decision – A document prepared by the federal lead agency, after an EIS has been completed, outlining the final decision on a proposal. It identifies the decision, alternatives considered, and measures to minimize harm; and it outlines a monitoring or enforcement program.

Regional Administrator – The Engineer in charge of each of the six transportation regions in the state.

Regional Representative – A designee of the Regional Administrator responsible for WSDOT monitoring of a federally-assisted local agency project.

Region Local Programs Engineer – The region’s designated representative for local agency and WSDOT liaison.

Rehabilitation – Similar to “Restoration” except the work may include reworking or strengthening the base or subbase, recycling or reworking existing materials to improve their structural integrity, adding underdrains, improving or widening shoulders. Rehabilitation may include acquisition of additional right of way.

Relocation Plan – A plan for relocating persons and personal property displaced by public projects.

Remainder – The portion of a land parcel not acquired for public right of way.

Repair – Replacement or rebuilding of a facility which is worn out, destroyed, or damaged. Repair includes overlays 18-mm (0.75-inch) thick or thicker. Crushed surfacing placed to 18-mm (0.75-inch) thick or thicker and covering more than 10 percent of the original surface area may be considered repair.

Restoration – Work performed on pavement or bridge decks to render them suitable for resurfacing. This may include supplementing the existing roadway by increasing surfacing and paving courses to provide structural capability, and widening up to a total of 3 meters (10 feet). Restoration will generally be performed within the existing right of way.

Resurfacing – The addition of a layer or layers of paving material to provide additional structural integrity, improved serviceability, and rideability.

Right of Way Certification – A letter from a local agency to the Local Programs Engineer certifying that right of way has been acquired in accordance with federal regulations.

Right of Way Project Analysis – Required on all federal aid projects as part of the R/W Certification.

Roadway Width – The portion of a street or road, between curbs or including shoulders, intended for vehicular use. This definition is for use in Design Standards only.

ROD – Record of Decision, a document prepared by the federal lead agency, after an EIS has been completed, outlining the final decision on a proposal. It identifies the decision, alternatives considered, and measures to minimize harm; and it outlines a monitoring or enforcement program.

Route Hearing – See location hearing.

RRP, RRS – Railway-Highway Grade Crossing, a federal aid funding program administered by FHWA and WSDOT.

Rural Area – Any land area outside the boundaries of the federally-designated urban areas as shown on the official urban area maps on file at WSDOT.

Scoping – A process for identifying issues and alternatives for an EIS.

Section 4(F) Evaluation – A document presenting the consideration, consultations, mitigative measures, and alternatives studied for the use of properties identified in Section 4(F) of the U.S. Department of Transportation Act as amended (49 USC 1653H).

Section 4(F) Lands – Generally, public parks, recreation areas, wildlife refuges, and historic sites.

See Effects – Social, economic, and environmental effects.

SEPA Checklist – See “environmental checklist.”

Severance Damages – The reduction of the market value of a remaining area because of a partial acquisition of property or property rights (damage to the remainder). See also proximity damages.

Shoreline Management – See Coastal Zone Management.

Six-Year Road or Street Program – See TIP.

Small Business Concern – A small business as defined according to Section 3 of the Small Business Act and other relevant regulations.

Small Purchase Procedures – Procedures to utilize external personal service or equipment rental for routine, continuing, and necessary tasks.

Socially and Economically Disadvantaged Individuals – Black Americans, Hispanic Americans, Native Americans, Asian-Pacific Americans, Asian-Indian Americans, and any other minorities or individuals found to be disadvantaged by the Small Business Administration pursuant to Section 8(a) of the Small Business Act. These individuals must be U.S. citizens or lawfully admitted permanent residents.

Special Provisions – A portion of the construction contract specifications separate from the General Provisions and covering conditions unique to a specific project.

Standard Specifications – Sets of typical construction contract specifications.

Stipulated Settlement – Final settlement of a right of way acquisition case through the acquiring agency's attorney that is stipulated (agreed to) by the property owner and any other interested parties prior to trial, and evidenced by a stipulated Judgment and Decree of Appropriation being filed in the superior court having jurisdiction.

Study Plan – An outline of the study process for the development of a project requiring an environmental impact statement.

Surety – A bonding company, for example.

Surfaced Width – The portion of a street or road for use by moving vehicles, between curbs or shoulders, including turning lanes where such lanes are appropriate, but excluding parking lanes and/or shoulders.

TCM – Transportation Control Measures are implemented to enable nonattainment areas meet their emissions goals. They can include Transportation Demand Management measures, parking policies and pricing, or other system improvements which reduce congestion.

TDM – Transportation Demand Management measures try to reduce the proportion of SOV commuters. TDM measures can include portion of non-SOV modes of transportation, car and vanpool formation assistance, transit subsidies, and a variety of other measures.

TEA-21 – Transportation Equity Act for the 21st Century.

Tied Bids – The practice of letting a single construction contract for two or more projects. Usually done to take advantage of economies of scale, such as more favorable unit prices for larger quantities of material. Requires Local Programs approval prior to advertising.

TIP – Transportation Improvement Program is a three-year transportation investment strategy, required at the metropolitan level, and a two-year program at the state level, which addresses the goals of the long-range plans and lists priority projects and activities for the region. (At the state level, the TIP is also known as a STIP, not to be confused with a SIP.)

TMA – Transportation Management Areas. Any area over 200,000 population is automatically a Transportation Management Area, which subjects it to additional planning requirements but also entitles it to earmarked funds for large, urbanized areas under the Surface Transportation Program. There are three TMAs: PSRC, SWRTC, and SRTC.

Traffic Data Collection Session – The collection of highway traffic data for a defined period of time at a specific highway location.

Traffic Monitoring Guide (TMG) – The FHWA’s statement of good traffic monitoring practices. The TMG describes the number and duration of traffic data collection sessions and the adjustments that need to be made to the collected data in order to develop location or system level estimates of the average traffic volume. The TMG also describes vehicle classification and truck weight data collection programs.

Tri-County (Tri-Co) – A Regional Transportation Planning Organization that includes Ferry, Stevens, and Pend Orielle Counties.

True Cost Estimate – The most refined estimate of all acquisition costs of all parcels within a project.

TRS – Is a designation meaning Township, Range, and Section.

TS&L – The type, size, and location stage of design development of bridges. A specific report (TS&L Report) which must be prepared on major or unusual bridges.

Urbanized Area – An area with a population over 50,000 within boundaries established by the U.S. Census Bureau or by responsible state and local officials in cooperation with each other. There are nine in Washington: Seattle-Everett, Tacoma, Yakima, Spokane, Vancouver, Tri-Cities, Bellingham, Olympia-Lacey-Tumwater, and Kelso-Longview.

Urban Area – Any land area within the boundaries of the federally-designated urban areas (population over 5,000) as shown on the official urban-area maps on file at WSDOT.

UZA – Urbanized Area is a census classification for areas having a population of 5,000 or more which meet certain population density requirements.

Walkway – A continuous way designated for pedestrians and separated from through lanes for motor vehicles by a curb, space, pavement marking, or other barrier.

Wetlands – Lands covered by shallow water or lands where the water table is at or near the surface; includes marshes, swamps, bogs, natural ponds, wet meadows and river overflow.

Withholding Resolution – A resolution passed by the local agency legislative body authorizing WSDOT to withhold a portion of the agency’s fuel-tax allotment to pay for a transportation project being administered by the state.

WOAP – Work Order Accounting Plan.

4.61 Percent Program – “1/2¢ Gas Tax,” “Arterial Fund.”

6.92 Percent Program – “Gas Tax,” “Road” or “Street Fund” (formerly 6-7/8¢ Program).