

2019 Ramp & Roadway

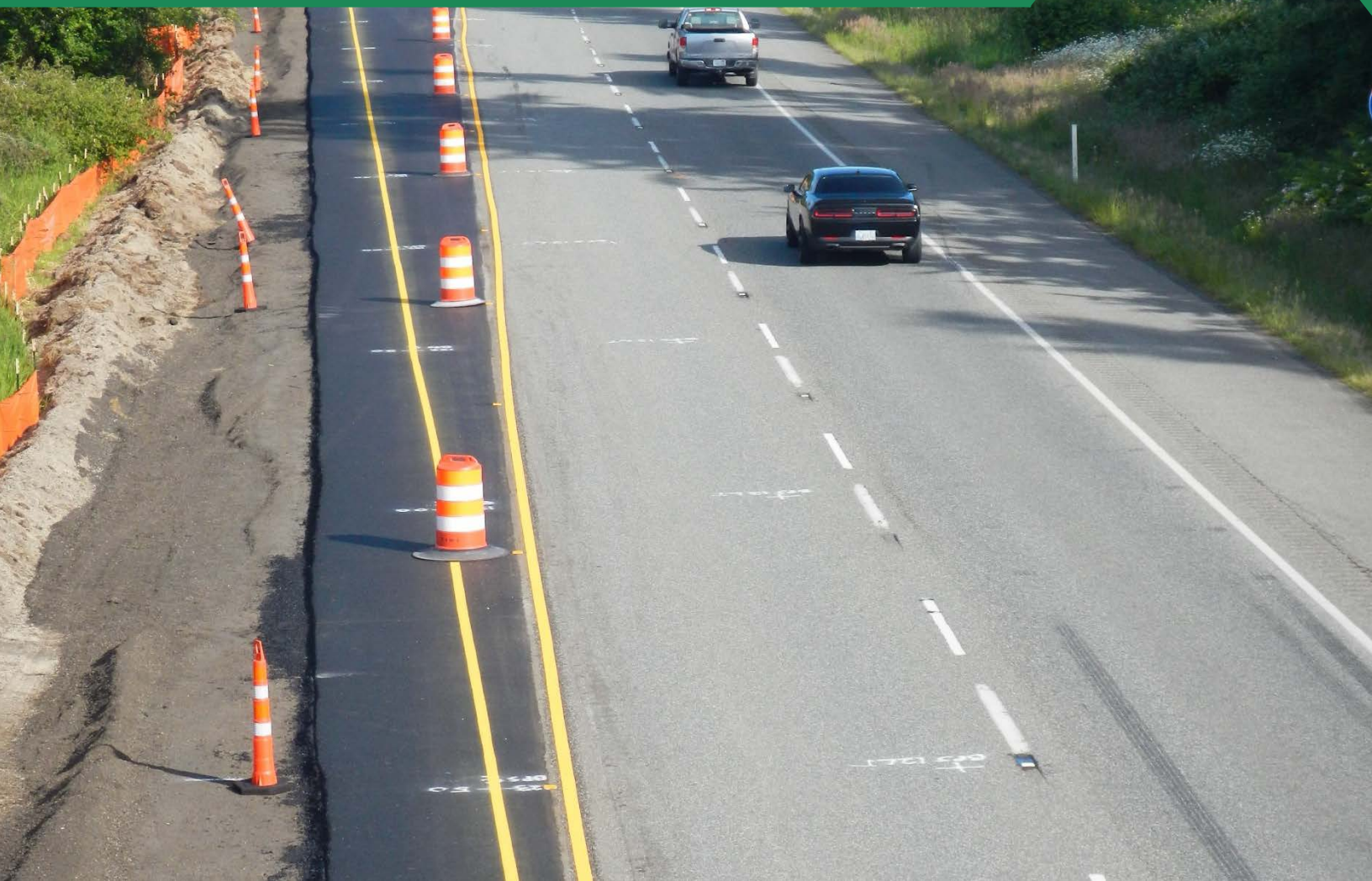

Washington State Department of

Transportation

**Northwest Region- Whatcom County
Data Station Reference Guide**

Table of Contents

Legend.....

I-5.....

SR 9.....

SR 539.....

SR 543.....

2

3

13

16

17

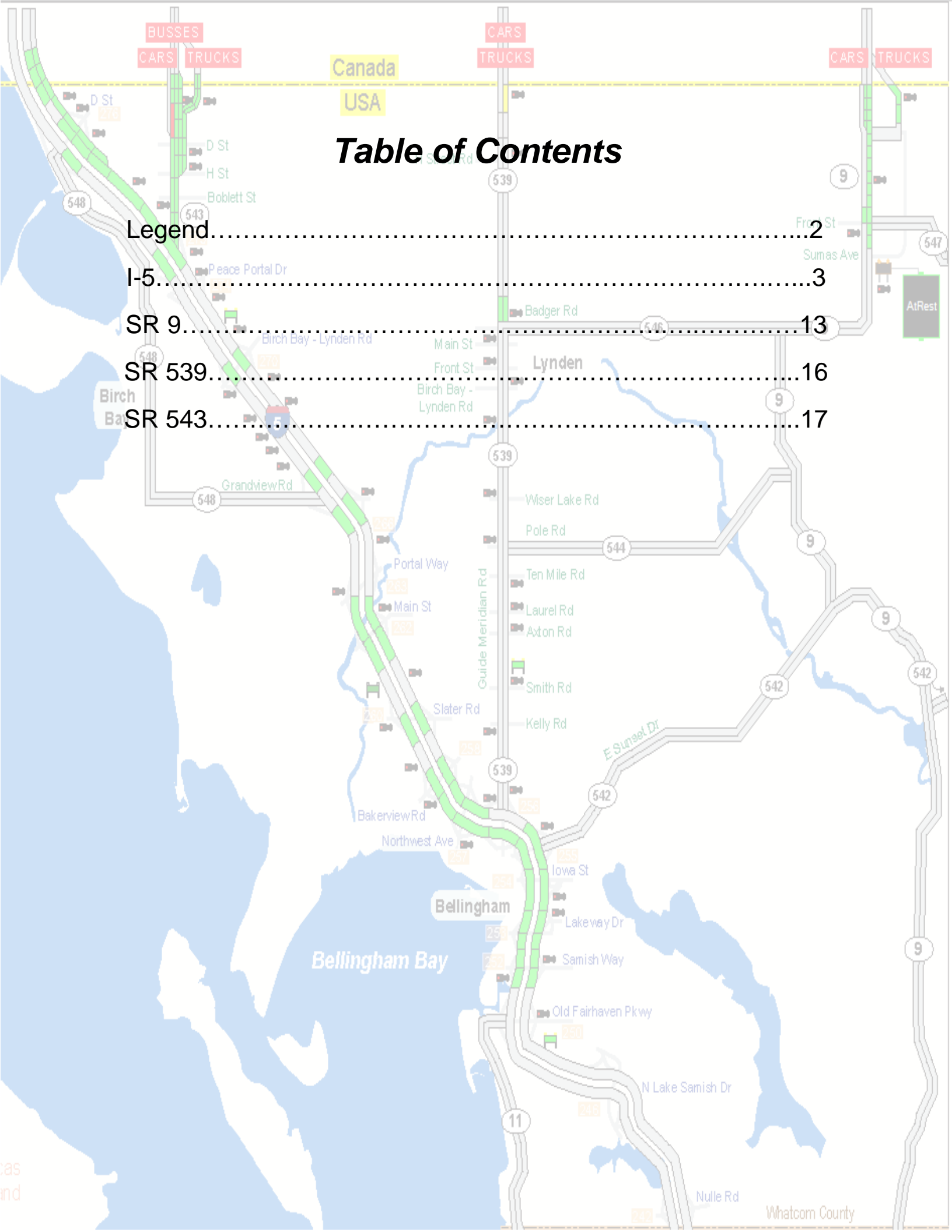

LEGEND

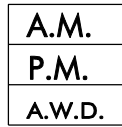

ramp volume

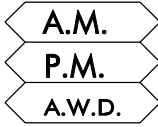

high-occupancy vehicle (HOV) lane volume



mainline volume
(does not include HOV lane volume)

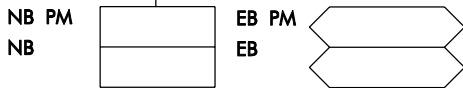
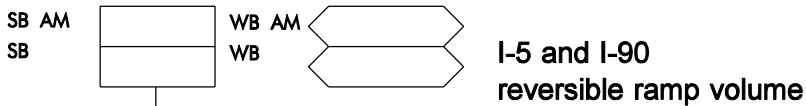
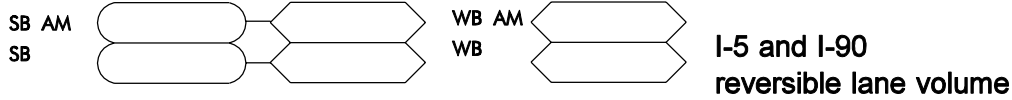

HOV facility



beginning or end of HOV facility



metered ramp shoulder



peak hour occurred outside of normal peak hour
(6 to 9:45 AM or 2:30 to 6:45 PM; See Appendix)

S

speed data available at this location

T

data obtained from tube counters

A.M.

am peak hour volume

P.M.

pm peak hour volume

CONSTR

data not available due to construction

A.W.D.

average weekday volume

N.A.

data not available

EXIT 252
SAMISH WAY

EXIT 253
LAKEWAY DR

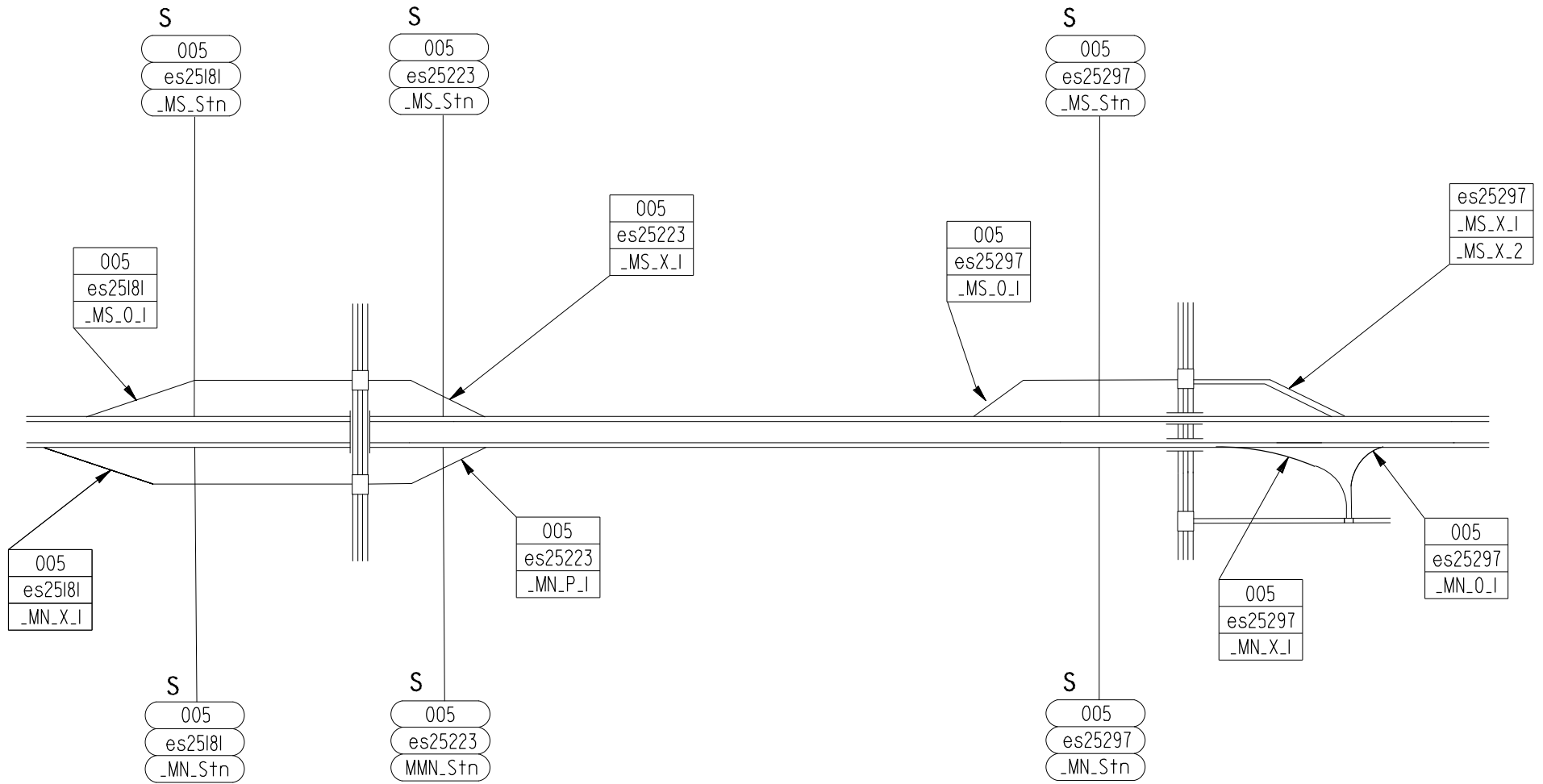

EXIT 254
OHIO ST IOWA ST

EXIT 255
SR 542
SUNSET DR

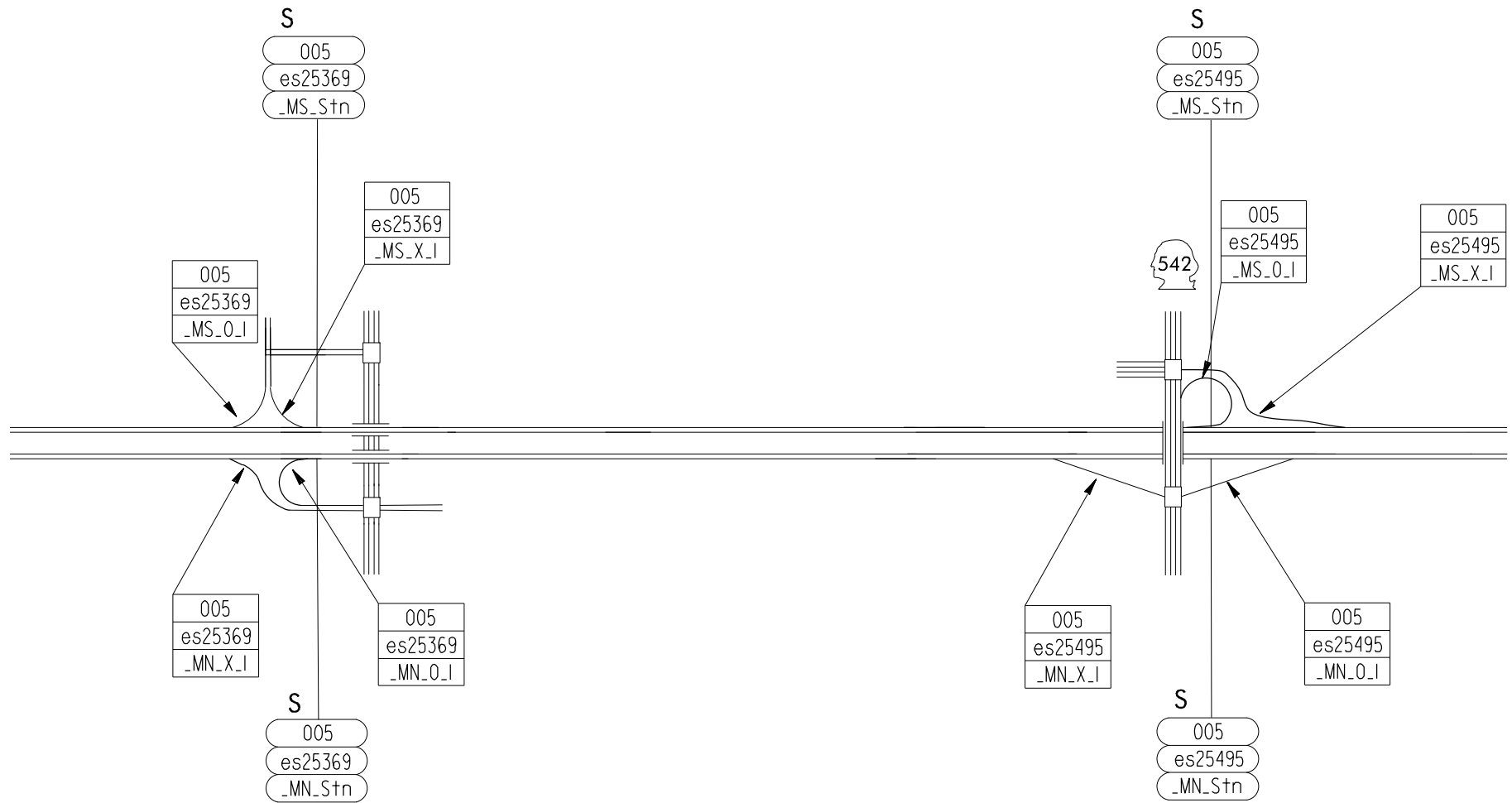

EXIT 256A/B
SR 539
MERIDIAN ST

EXIT 257
NORTHWEST AVE

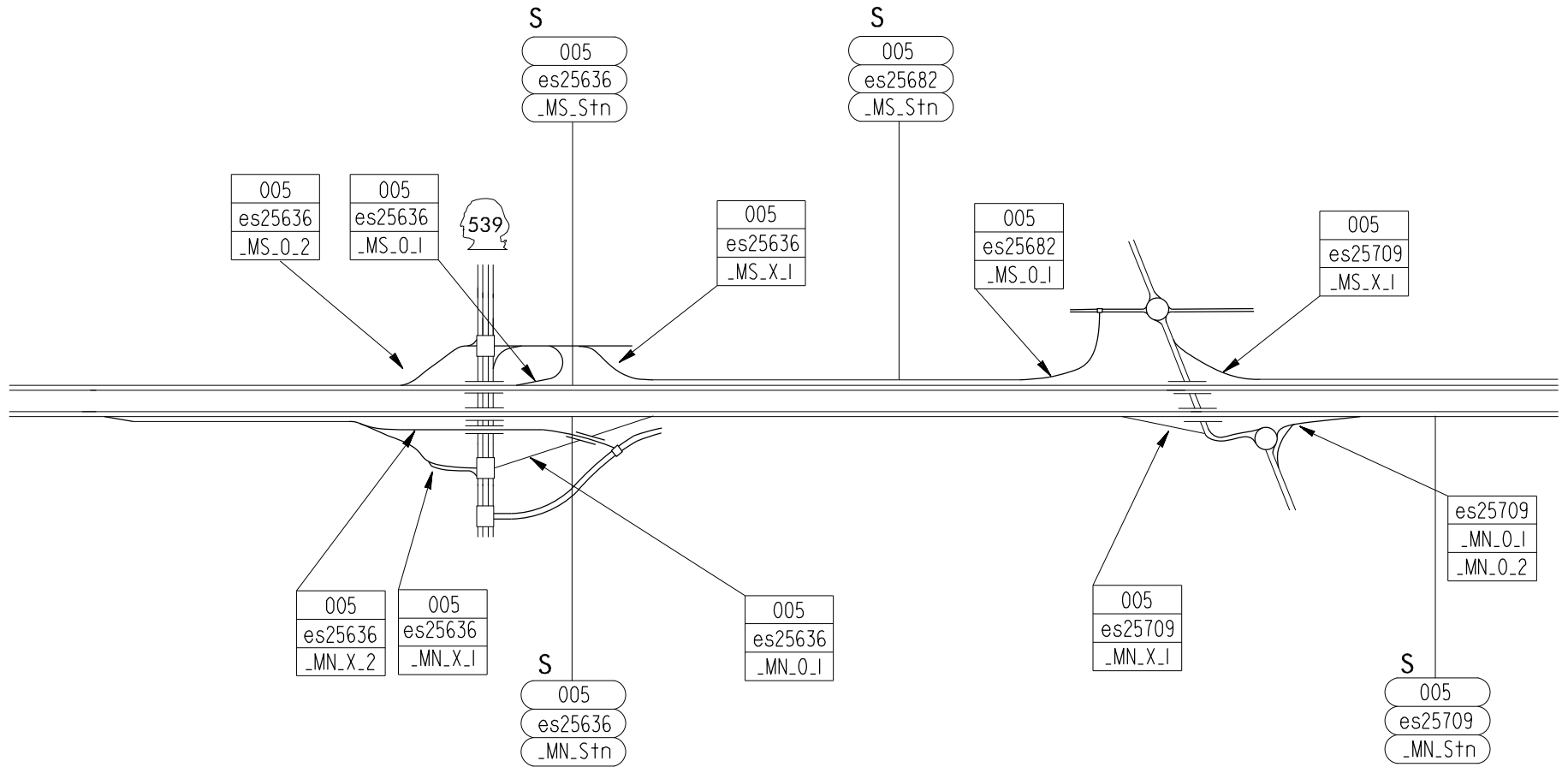

Washington State
Department of Transportation



3
OF
10

EXIT 258
BAKERVIE RD

BELLINGHAM AIRPORT

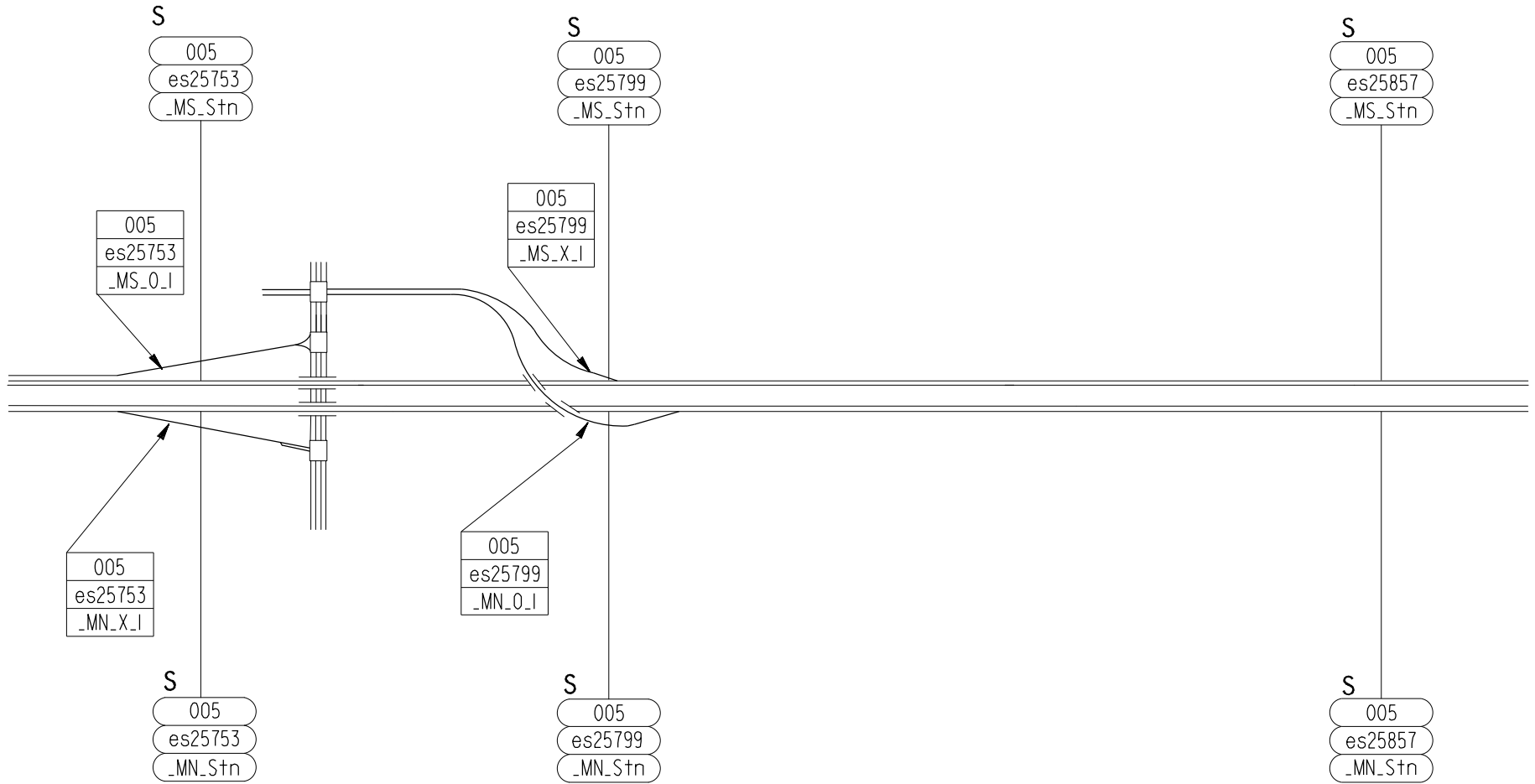

EXIT 260
SLATER RD

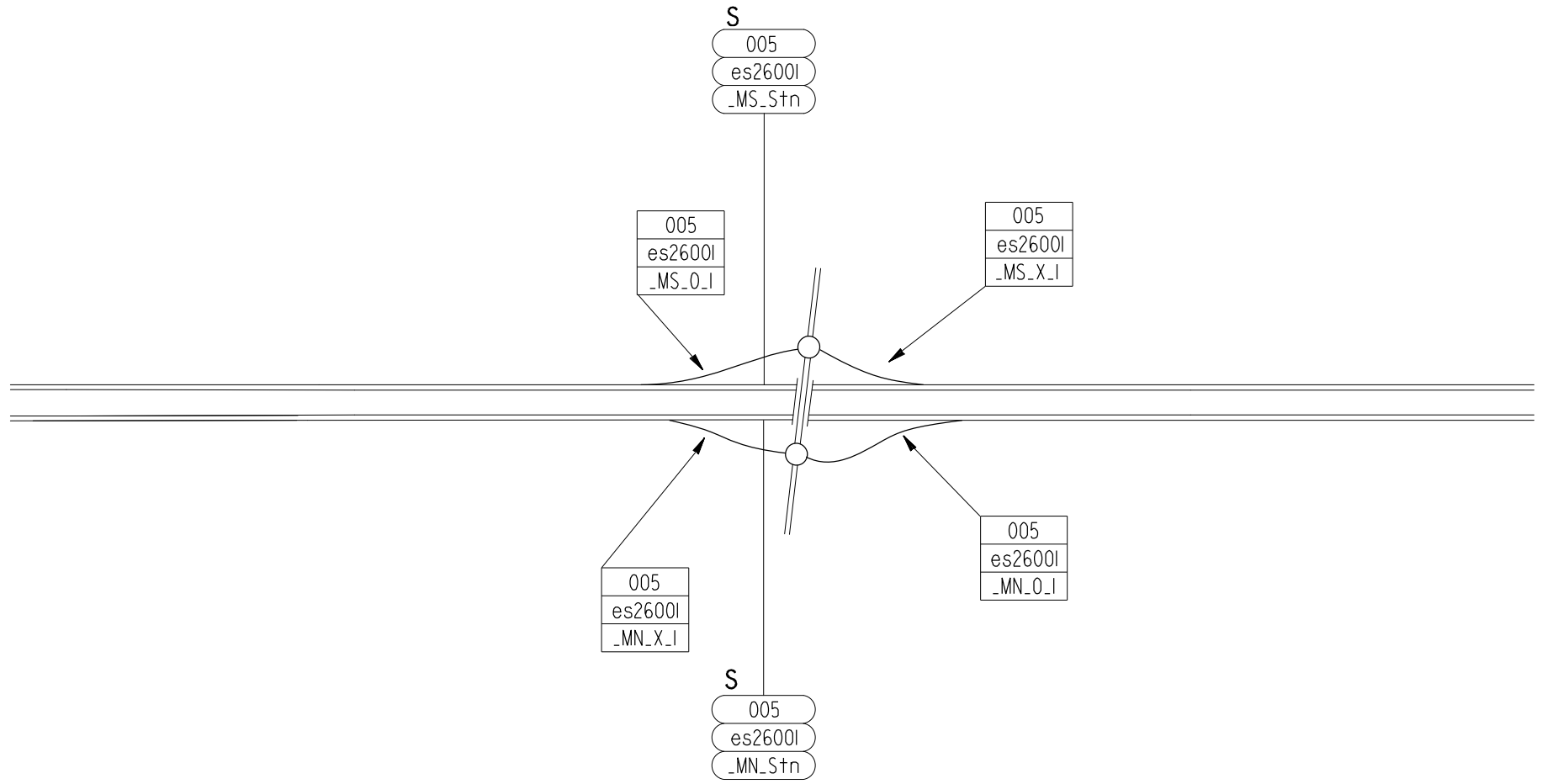

EXIT 262
MAIN ST

EXIT 263
PORTAL WAY

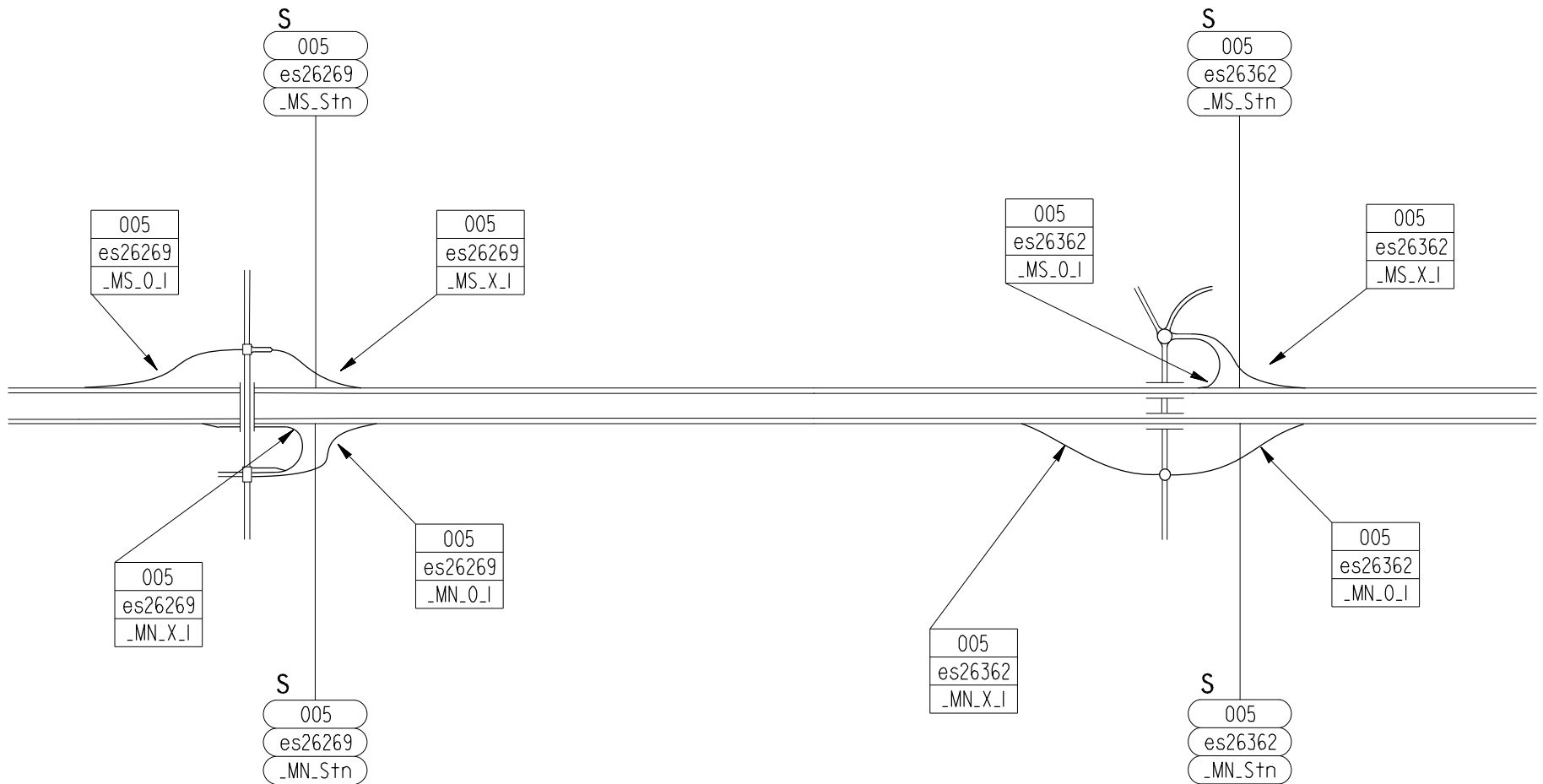

EXIT 266
SR 548
GRANDVIEW RD

NORTHBOUND CUSTER REST AREA

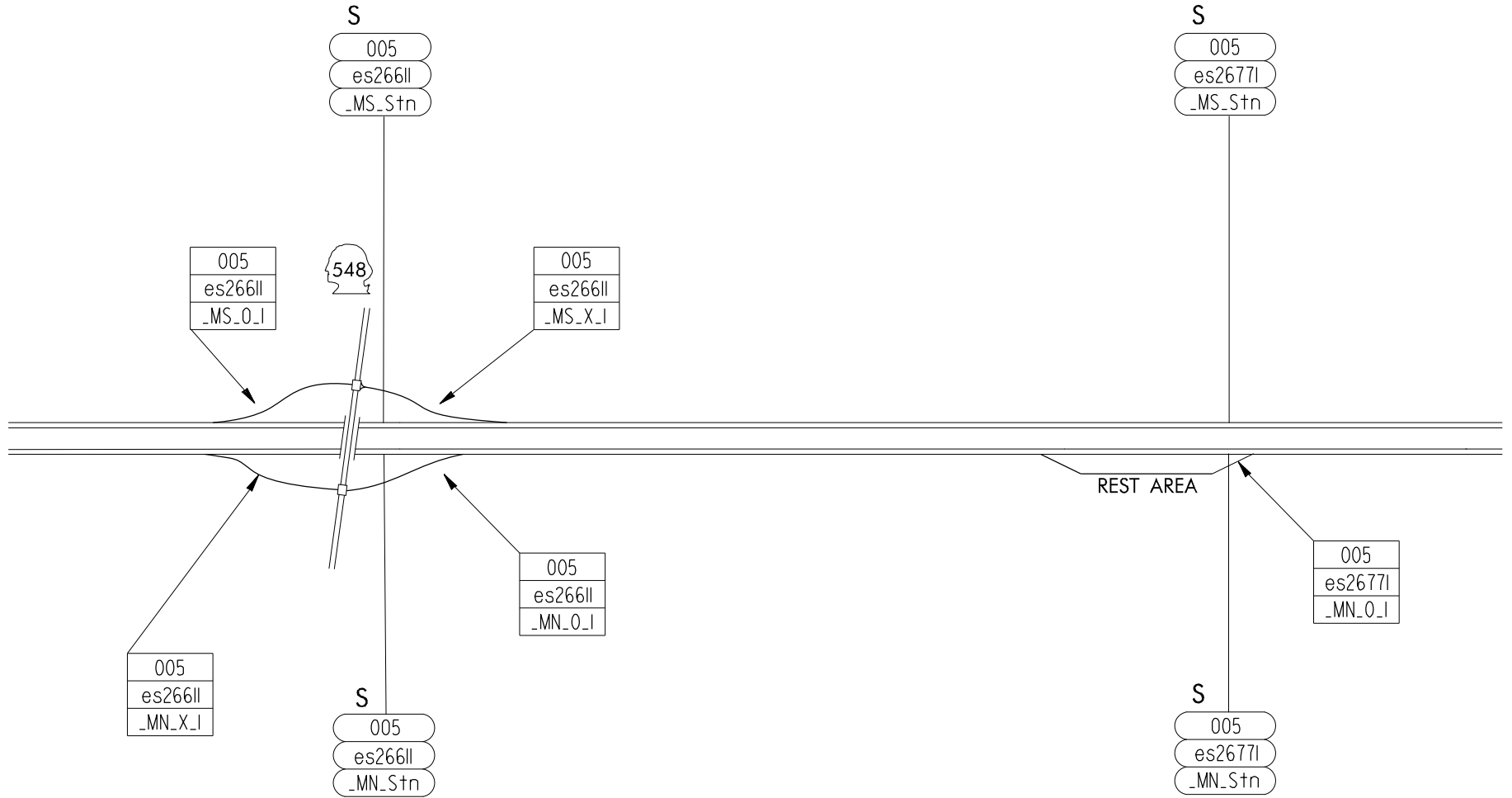

SOUTHBOUND CUSTER REST AREA

EXIT 270
BIRCH BAY LYNDEN RD

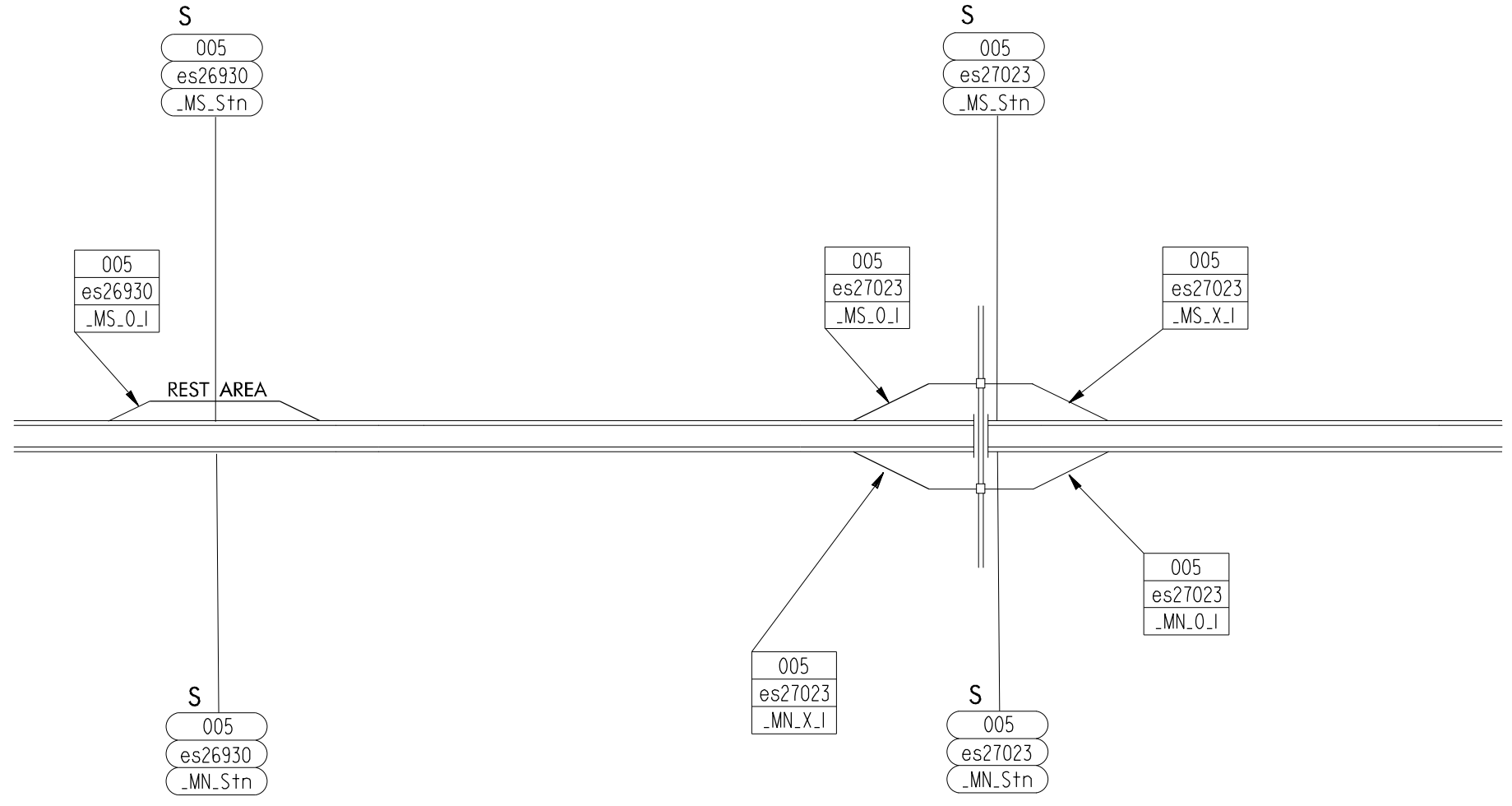

EXIT 274
PEACE PORTAL DR

EXIT 275
SR 543

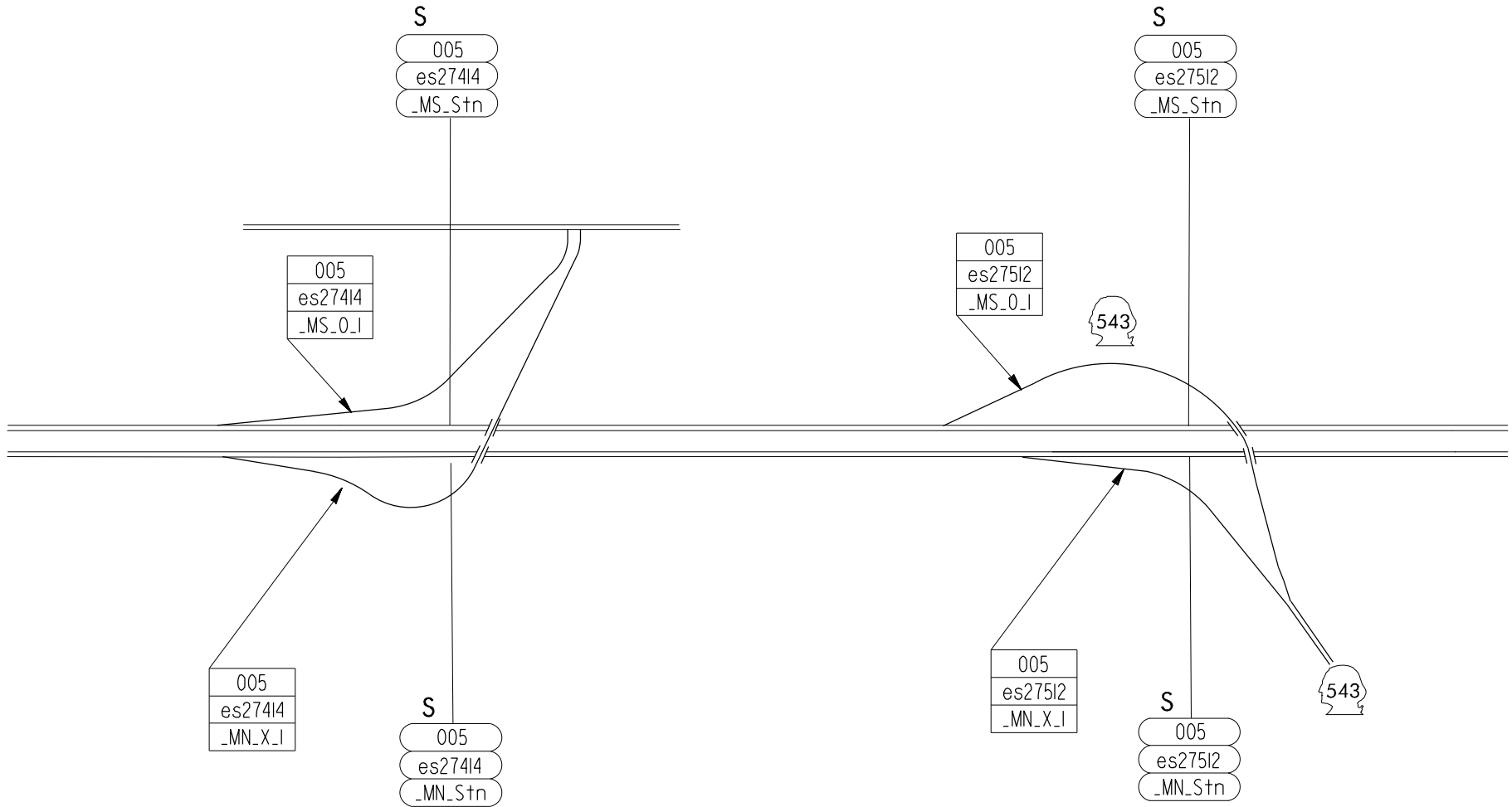

EXIT 276

D ST

US/CANADIAN BORDER

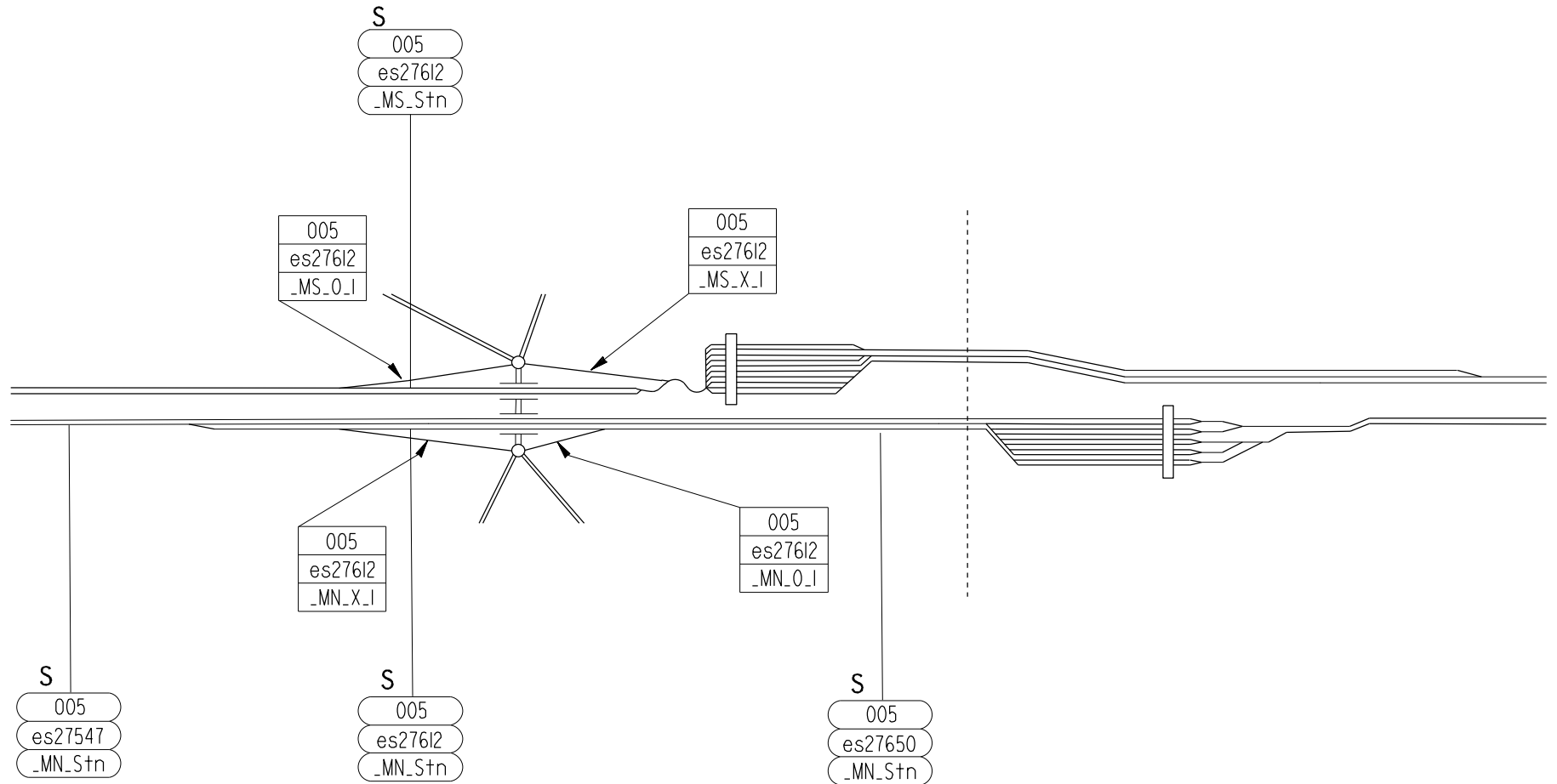

SUMAS AVE

FRONT ST

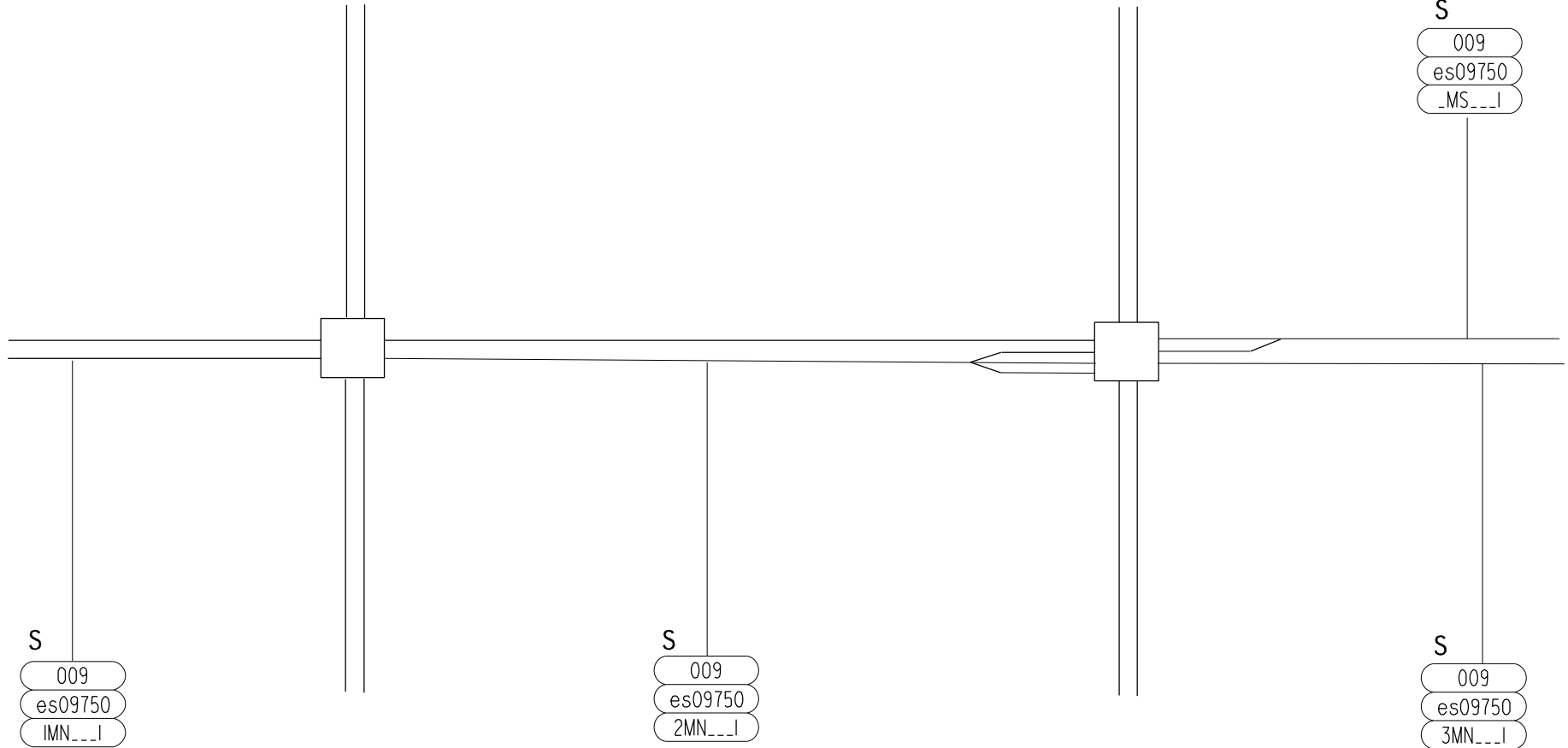

Washington State
Department of Transportation



1
OF
3



VANCOUVER ST

COLUMBIA ST

3RD ST

2ND ST

1ST ST

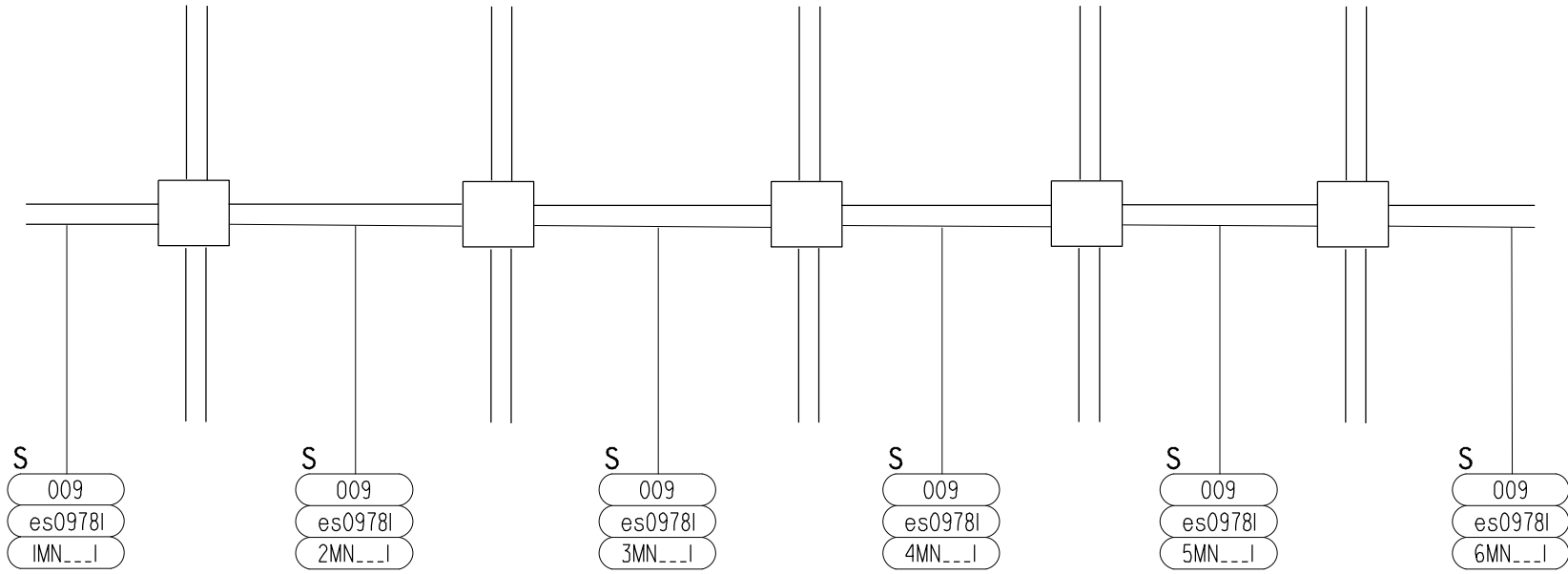

Washington State
Department of Transportation



2
OF
3



GARFIELD AVE

CLEVELAND ST

HARRISON ST

US/CANADIAN BORDER

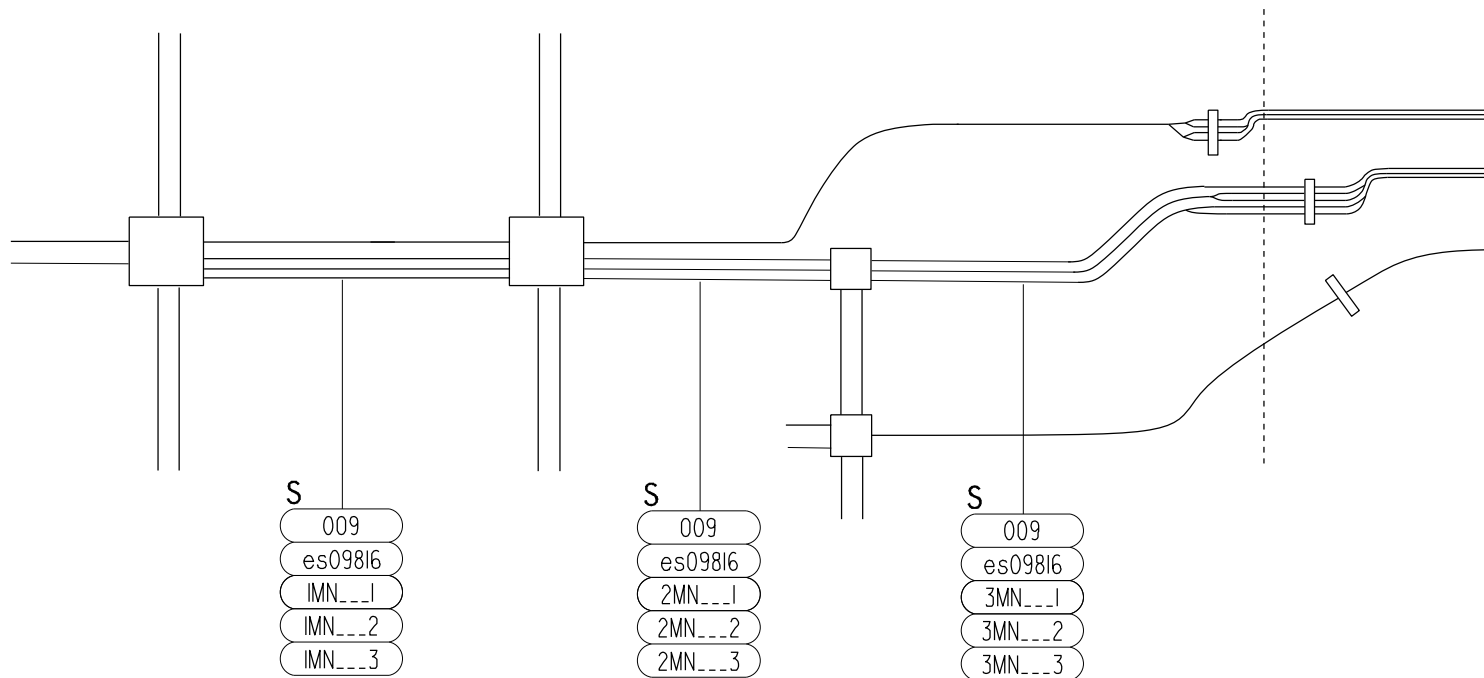

Washington State
Department of Transportation



3
OF
3



BADGER RD

E PRAIRIE RD

H St

US/CANADIAN BORDER

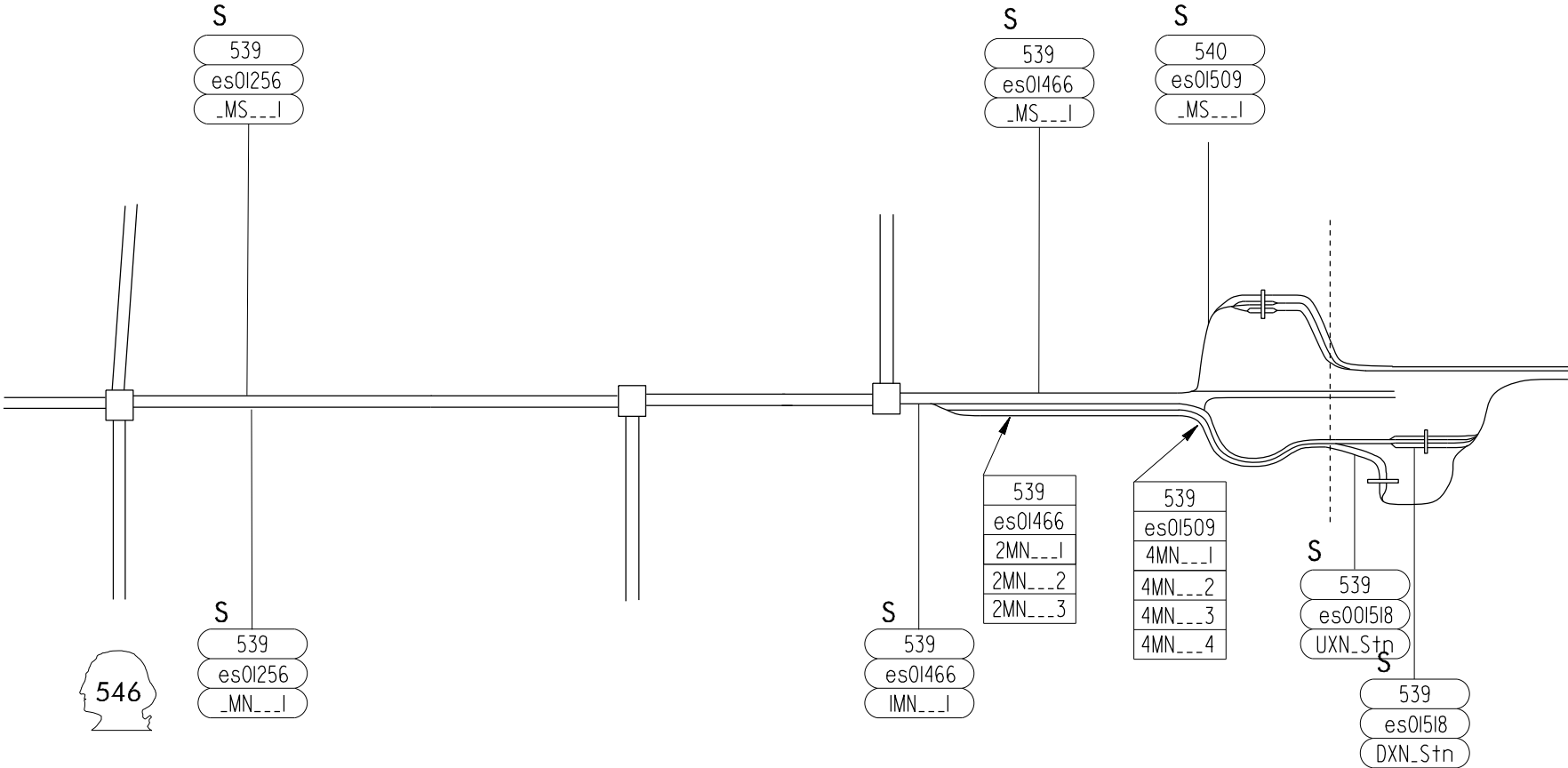

Washington State Department of Transportation



1 OF 1

BOBLETT ST

H ST

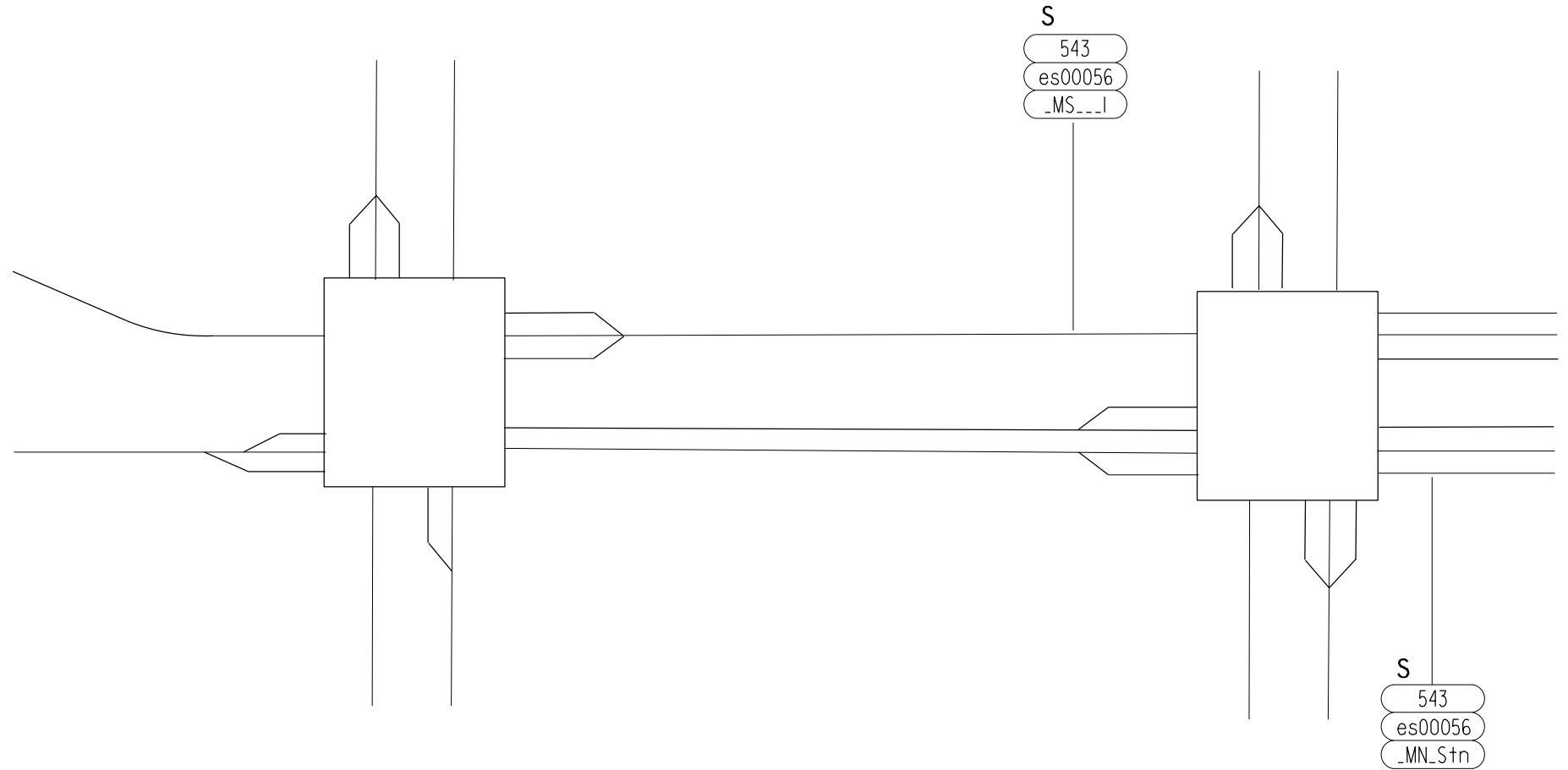

Washington State
Department of Transportation



1
OF
2



US/CANADIAN BORDER

D ST

