

DRAWN BY: FERN LIDDELL

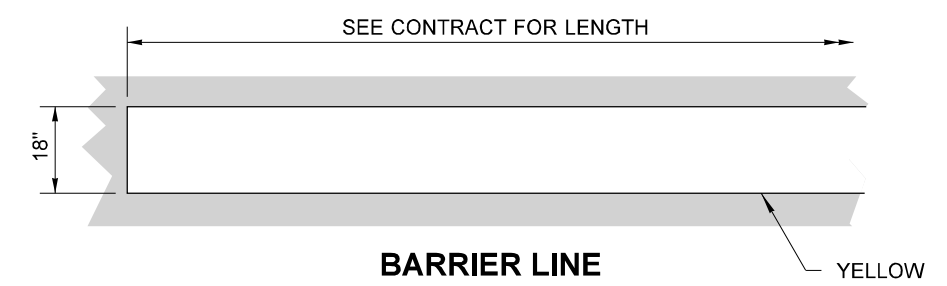

NOTES

1. Dotted Extension Line shall be the same color as the line it is extending.
2. Edge Line shall be white on the right edge of traveled way, and yellow on the left edge of traveled way (on one-way roadways). Solid Lane Line shall be white.
3. The distance between the lines of the Double Centerline shall be 12" everywhere, except 4" for left-turn channelization and narrow roadways with lane widths of 10 feet or less. Local Agencies (on non-state routes) may specify a 4" distance for all locations.
The distance between the lines of the Double Lane Line shall be 4".

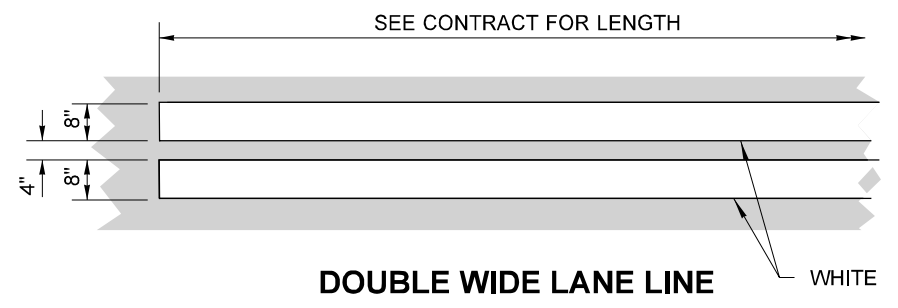
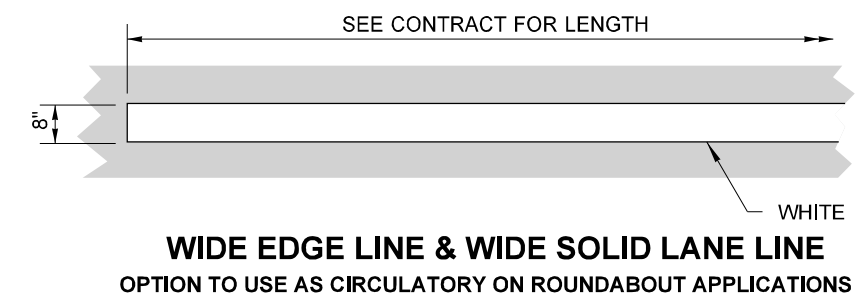
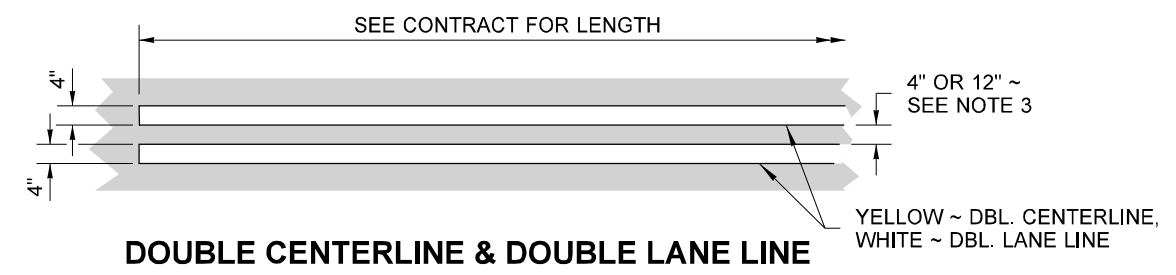
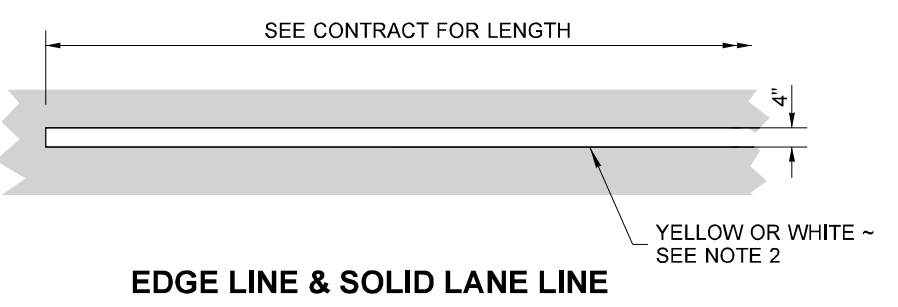
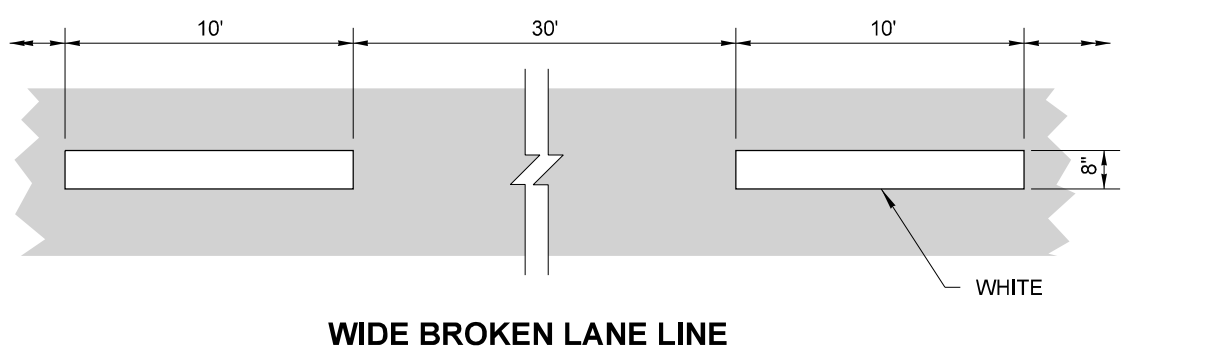
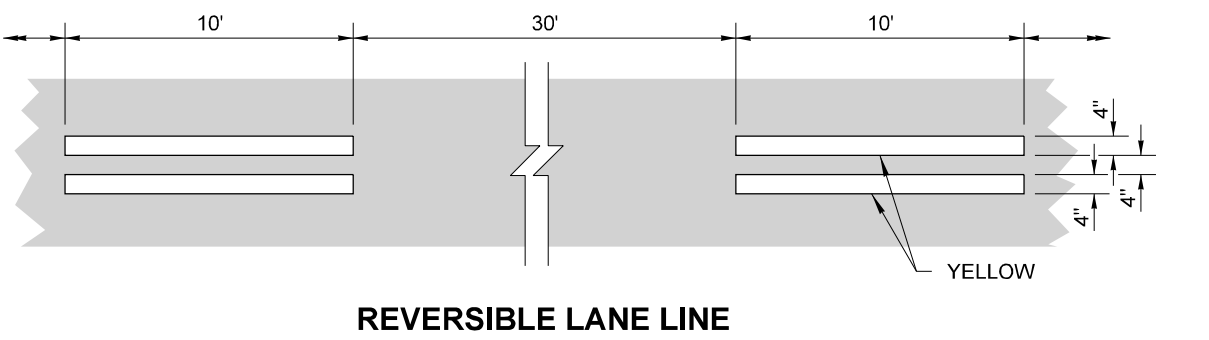
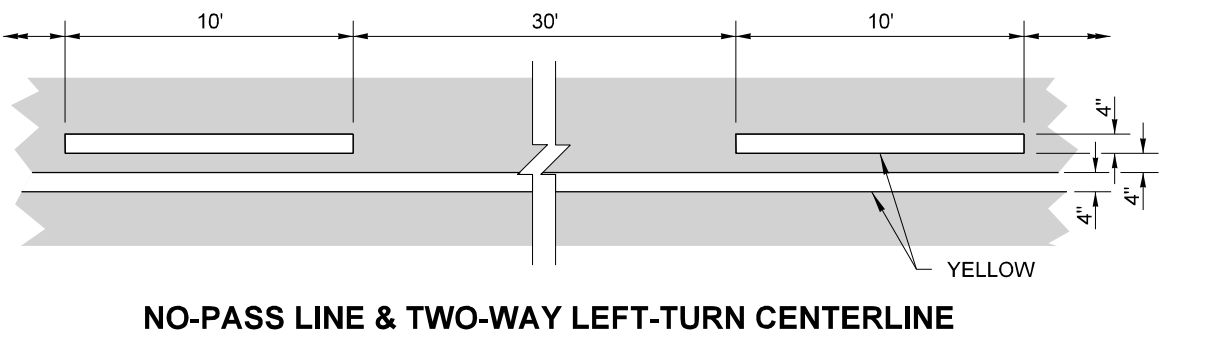
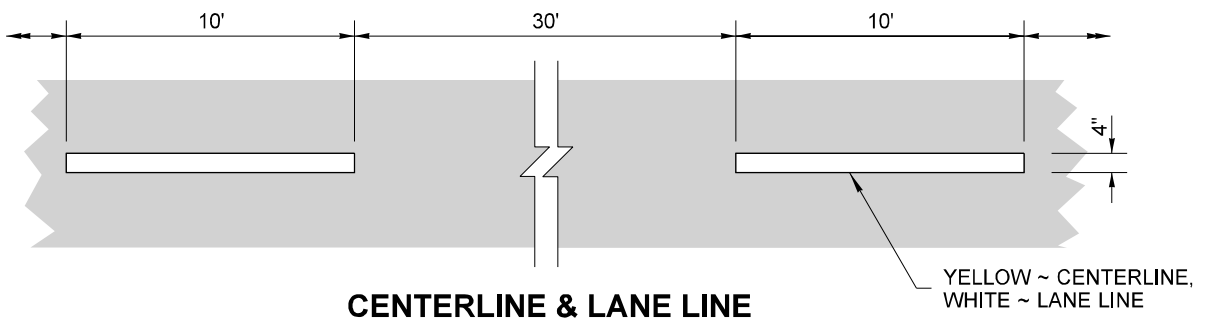

Aug 1, 2022

LONGITUDINAL MARKING PATTERNS
STANDARD PLAN M-20.10-04
SHEET 1 OF 4 SHEETS

APPROVED FOR PUBLICATION
 Mark Gaines (Aug 2, 2022 10:17 PDT)
 STATE DESIGN ENGINEER
 Washington State Department of Transportation
 Aug 2, 2022

DRAWN BY: FERN LIDDELL

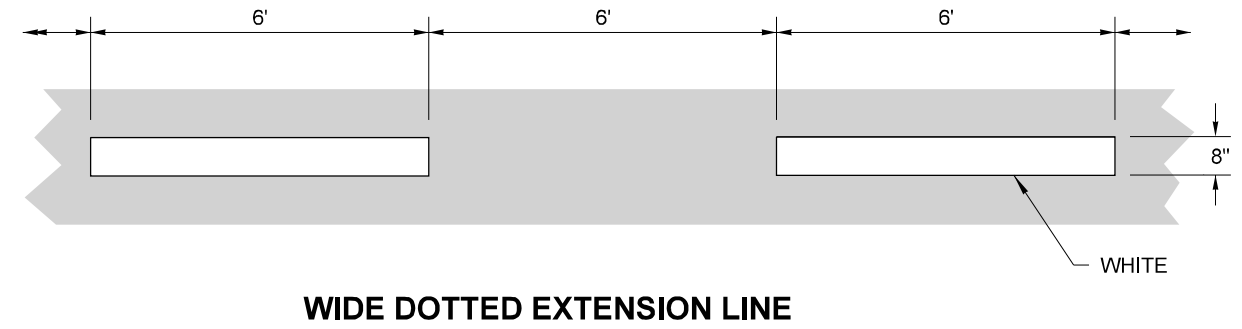
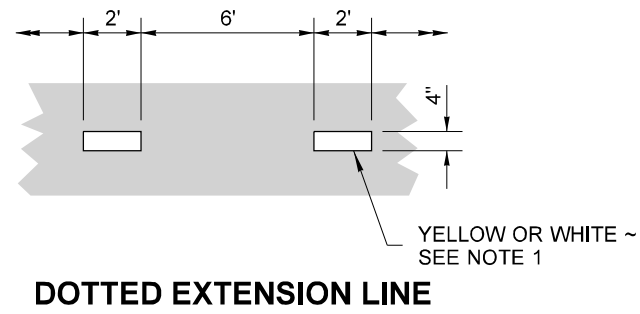
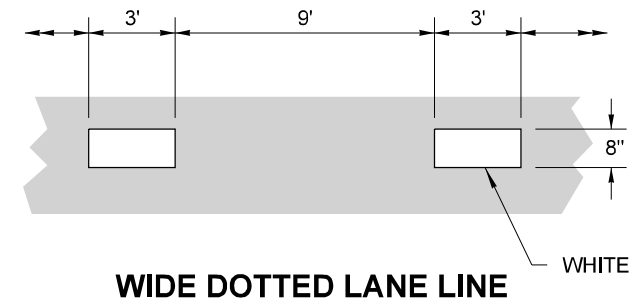
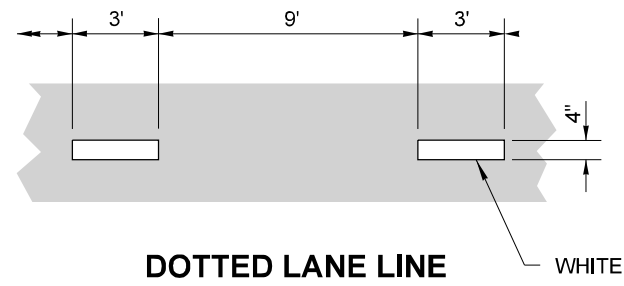

ROUNDAOBT SPECIFIC LINES

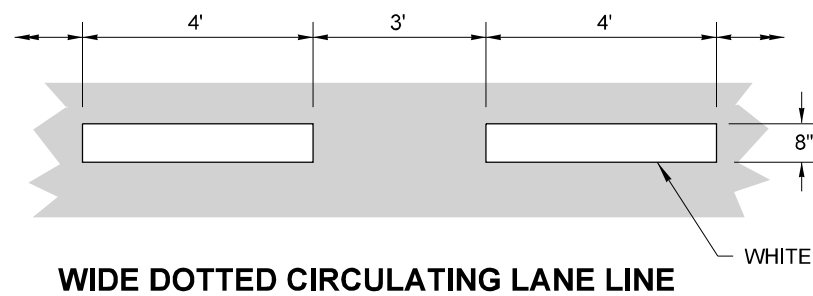
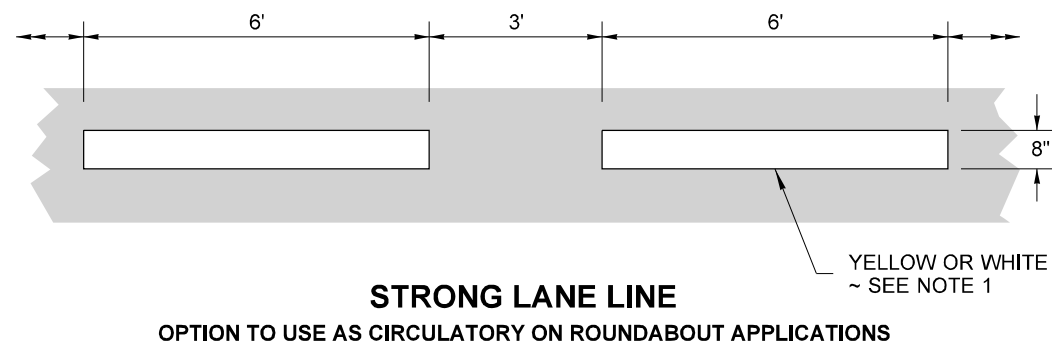
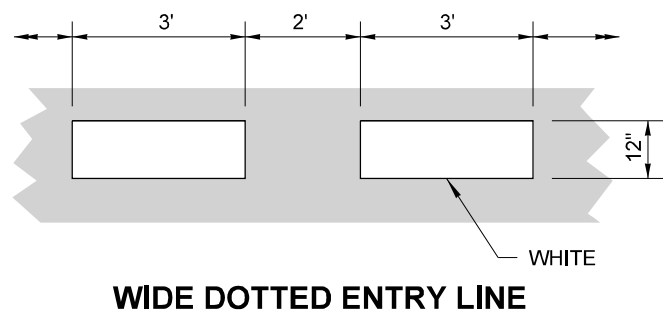

Aug 1, 2022

LONGITUDINAL MARKING PATTERNS
STANDARD PLAN M-20.10-04

SHEET 2 OF 4 SHEETS

APPROVED FOR PUBLICATION

Mark Gaines
 Mark Gaines (Aug 2, 2022 10:17 PDT)

Aug 2, 2022

STATE DESIGN ENGINEER



Washington State Department of Transportation

DRAWN BY: FERN LIDDELL

DIRECTION OF TRAFFIC
(TYPICAL)

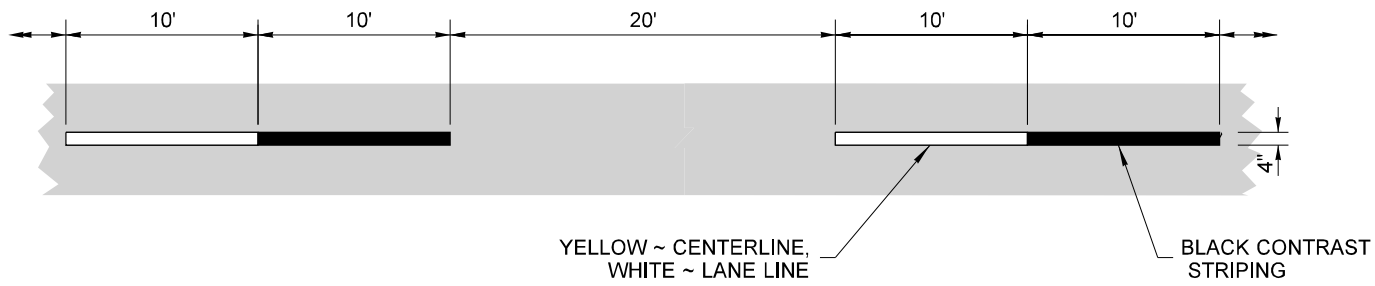

CENTERLINE & LANE LINE

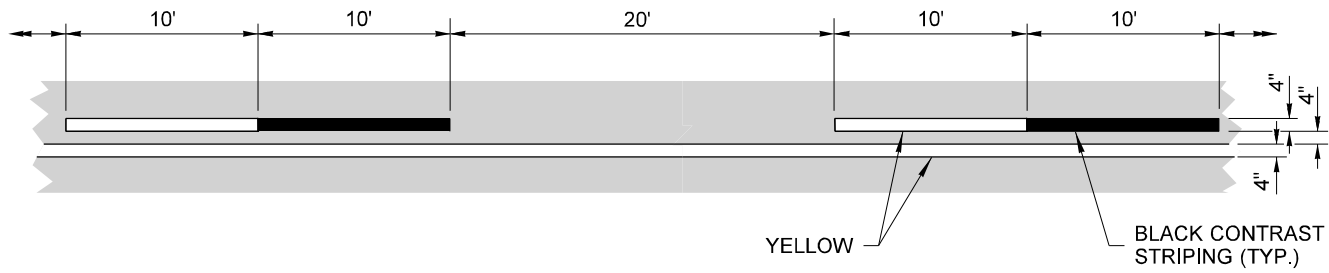

NO-PASS LINE & TWO-WAY LEFT-TURN CENTERLINE

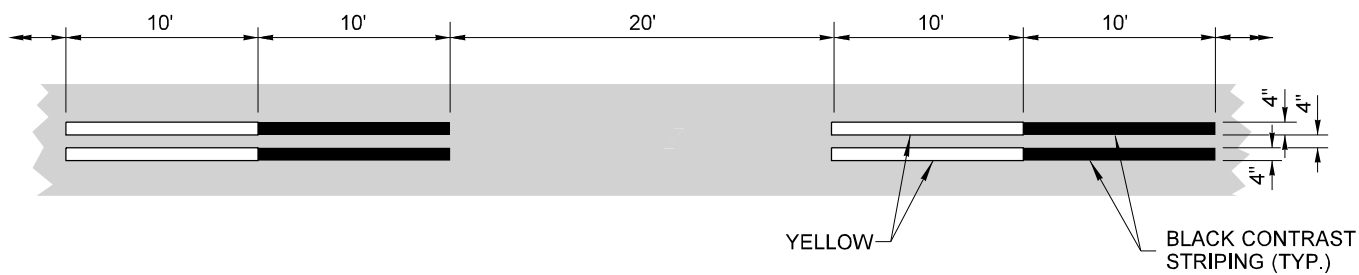

REVERSIBLE LANE LINE

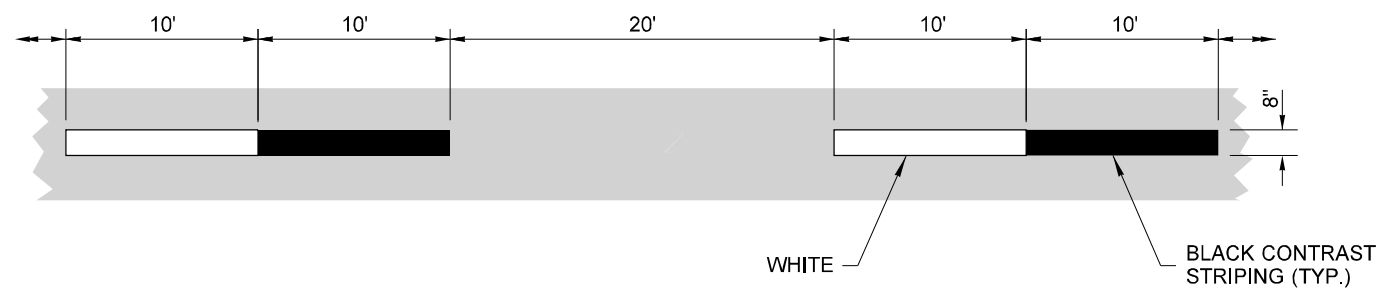

WIDE BROKEN LANE LINE

NOTE

- 1. Dotted Extension Line shall be the same color as the line it is extending.

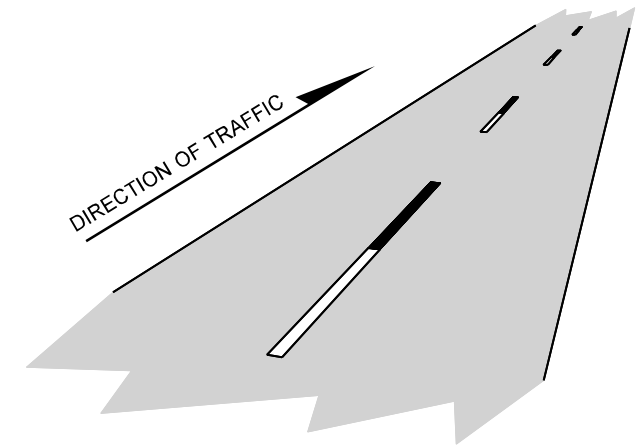

ISOMETRIC VIEW



Aug 1, 2022

LONGITUDINAL MARKING PATTERNS
STANDARD PLAN M-20.10-04

SHEET 3 OF 4 SHEETS

APPROVED FOR PUBLICATION
Mark Gaines
 Mark Gaines (Aug 2, 2022 10:17 PDT)
 STATE DESIGN ENGINEER
 Aug 2, 2022
 Washington State Department of Transportation

DRAWN BY: FERN LIDDELL

DIRECTION OF TRAFFIC
(TYPICAL) →

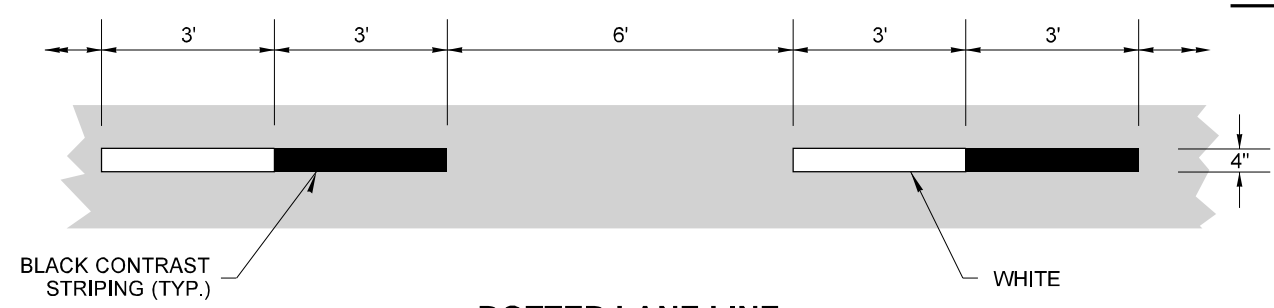

DOTTED LANE LINE

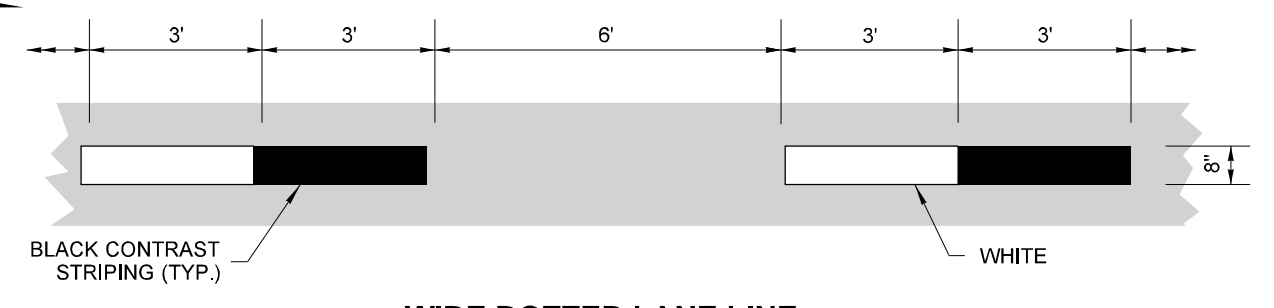

WIDE DOTTED LANE LINE

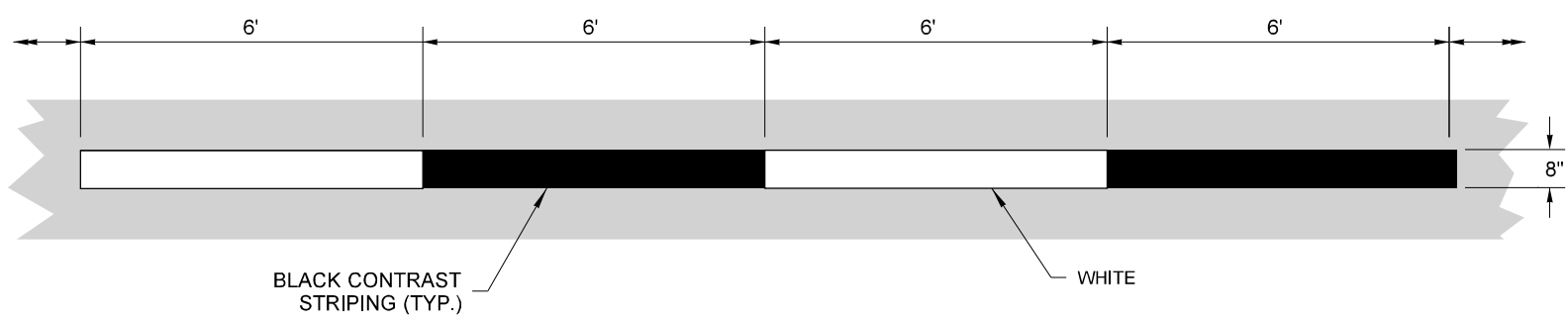

WIDE DOTTED EXTENSION LINE

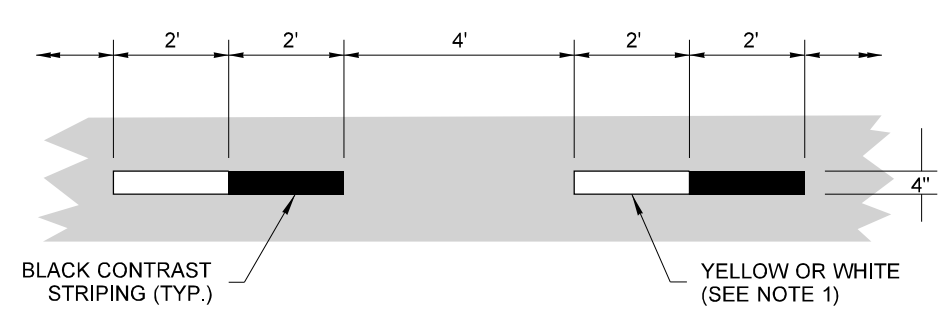

DOTTED EXTENSION LINE

ROUNDBABOUT SPECIFIC LINES

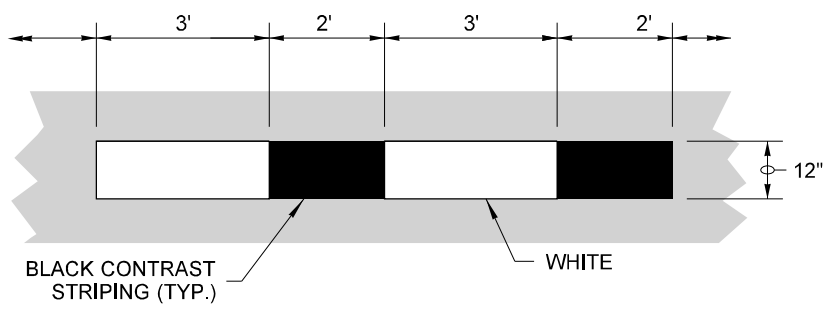

WIDE DOTTED ENTRY LINE

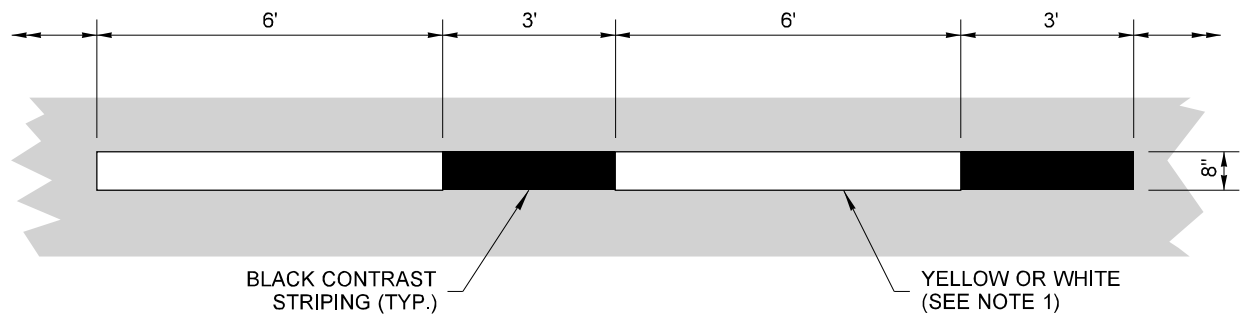

STRONG LANE LINE

OPTION TO USE AS CIRCULATORY ON ROUNDABOUT APPLICATIONS

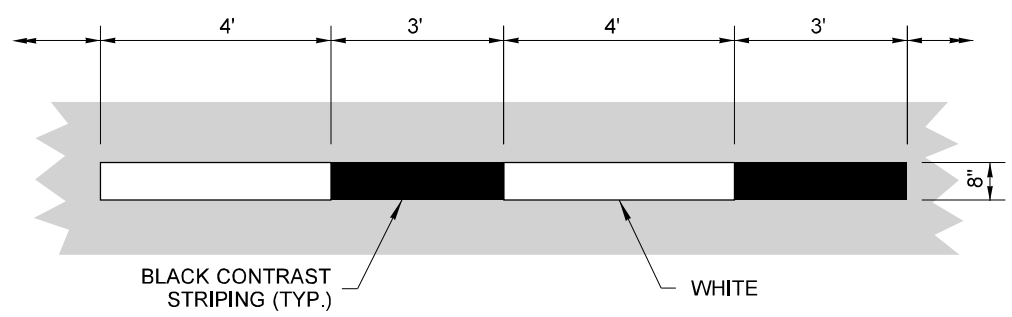

WIDE DOTTED CIRCULATING LANE LINE



Aug 1, 2022

LONGITUDINAL MARKING PATTERNS
STANDARD PLAN M-20.10-04

SHEET 4 OF 4 SHEETS

APPROVED FOR PUBLICATION
 Mark Gaines (Aug 2, 2022 10:17 PDT)
 STATE DESIGN ENGINEER
 Washington State Department of Transportation

Aug 2, 2022