Hydroacoustic Measurements During Pile Driving at the Hood Canal Bridge, September Through November 2004



T. J. Carlson
D. L. Woodruff
G. E. Johnson
N. P. Kohn

G. R. Ploskey
M. A. Weiland
J. A. Southard
S. L. Southard

Battelle Marine Sciences Laboratory
Sequim, Washington

November 2005

Prepared for the
Washington State Department of Transportation

Battelle Memorial Institute
Pacific Northwest Division

LEGAL NOTICE

This report was prepared by Battelle Memorial Institute (Battelle) as an account of sponsored research activities. Neither Client nor Battelle nor any person acting on behalf of either:

MAKES ANY WARRANTY OR REPRESENTATION, EXPRESS OR IMPLIED, with respect to the accuracy, completeness, or usefulness of the information contained in this report, or that the use of any information, apparatus, process, or composition disclosed in this report may not infringe privately owned rights; or

Assumes any liabilities with respect to the use of, or for damages resulting from the use of, any information, apparatus, process, or composition disclosed in this report.

Reference herein to any specific commercial product, process, or service by trade name, trademark, manufacturer, or otherwise, does not necessarily constitute or imply its endorsement, recommendation, or favoring by Battelle. The views and opinions of authors expressed herein do not necessarily state or reflect those of Battelle.



This document was printed on recycled paper.
(9/2003)

**Hydroacoustic Measurements During
Pile Driving at the Hood Canal Bridge,
September Through November 2004**

T. J. Carlson
D. L. Woodruff
G. E. Johnson
N. P. Kohn

G. R. Ploskey
M. A. Weiland
J. A. Southard
S. L. Southard

Battelle Marine Sciences Laboratory
Sequim, Washington

November 2005

Prepared for the
Washington State Department of Transportation

Battelle Memorial Institute
Pacific Northwest Division
Richland, Washington 99352

Executive Summary

This report provides data describing underwater sound-pressure levels during pile driving operations at the Hood Canal Bridge throughout the fall of 2004. The data characterize sound generated by single pile-driving hammer impacts, multiple successive hammer impacts, and a complete pile driving event under a variety of water depth, pile type, and sound mitigation conditions. To mitigate sound, the construction contractor was required to deploy a bubble curtain: a dense column of very fine bubbles used to decrease the sound energy and modify the sound spectrum by repeated reflection between the bubbles and the pile. A subset of plumb and batter piles was monitored without the bubble curtain in place to compare the sound signals from piles driven with or without sound mitigation. The hydroacoustic data acquisition system consisted of three hydrophones connected to a digital spectrum analyzer with a sampling rate of 48,000 samples per second. The hydrophones were placed along a floating line at three distances from the pile being monitored, at approximately mid-water column depth. At each deployment, hydrophone function was tested and calibrated prior to data collection. Data acquisition was initiated before the pile-driving event and was terminated after pile driving ceased to ensure that all of the pile-driving hammer impact events were recorded and available for analysis.

Peak and root mean square (RMS) sound pressure varied between piles and was also quite variable over the duration of driving individual piles. Sound pressure varied from peak positive pressure of 15,525 Pa to peak negative pressure of -24,491 Pa. The median peak positive and peak negative values for all plumb pile impacts were 5,952 Pa and -6,580 Pa. There was a distinct decrease in sound-pressure levels with increased distance of hydrophones from the pile due to shallow-water sound propagation factors, including attenuation and geometric spreading. Observed sound pressures were, in general, lower for batter piles than for plumb piles. Sound-pressure data were evaluated relative to the threshold values set for the protection of marine life by the National Oceanic and Atmospheric Administration Fisheries and the U. S. Fish and Wildlife Service for Hood Canal Bridge and related Washington State Department of Transportation pile-driving projects. The threshold value for peak pressure is 180 dB/ μ Pa, which is equal to 1,000 Pa. This peak-pressure threshold was exceeded for more than 95% of all impacts to plumb piles at all distances, including 50 m to 60 m from the piling. Although the observed sound pressures were lower at batter piles, the peak-pressure threshold was exceeded for more than 90% of impacts for batter piles except at the farthest distance from the piling, where the threshold was exceeded for more than 60% of impacts. The RMS pressure threshold is 31.6 Pa, which was exceeded in more than 95% of all batter and plumb pile hammer impacts. The peak and RMS pressure thresholds were exceeded most of the time for both plumb and batter piles driven with or without a bubble curtain.

There were no clear or obvious patterns in the sound-level data that would distinguish sound production from pile driving with or without a bubble curtain in place. The construction schedule and nature of the bubble curtain device did not allow comparison of conditions with and without the bubble curtain when monitoring an individual pile, which would have allowed for control of some variables. Designing a study to adequately evaluate mitigation effectiveness is challenging at best, because pile driving is a dynamic process, and sound production is a function of many factors, including substrate type, water depth, type of pile, and type of mitigation device (if employed). Although the study as conducted was effective for evaluating sound levels relative to marine life protection thresholds, the monitoring was not designed to evaluate the performance of mitigation devices in any comprehensive manner.

Acknowledgements

This work could not have been accomplished without habitat biologist Carl Ward and Hood Canal Bridge environmental compliance manager Tom Cushman of the Washington State Department of Transportation. Logistics coordination with the construction contractors was provided by Max Brown of Kiewit General Construction. The authors also gratefully acknowledge Gary Dennis, Brian Gruendell, and Greg Williams for their assistance with vessel operation and hydrophone field deployments; Nathan Evans for graphics support; Chris May for document review; and Blythe Barbo for document editing and production assistance.

Glossary

cfm	cubic feet per minute
DAT	digital audio tape
GPS	global positioning system
NOAA	National Oceanic and Atmospheric Administration
Pa	Pascal sound-pressure levels
psi	pounds per square inch
RMS	root mean square
SAS	Statistical Analysis Systems
scfm	standard cubic feet per minute
USFWS	United States Fish and Wildlife Service
WSDOT	Washington State Department of Transportation

Contents

Executive Summary	iii
Acknowledgements.....	iv
Glossary	v
1.0 Introduction.....	1
2.0 Methods.....	5
2.1 Hydroacoustic Data Collection	5
2.1.1 Pile-Driving Hammer.....	5
2.1.2 Sound Measuring Equipment.....	6
2.1.3 Hydrophone Array.....	6
2.1.4 Collection Protocol.....	6
2.2 Hydroacoustic Data Analysis	8
3.0 Results.....	9
3.1 Hydrophone In-Field Operation Validation	9
3.2 Characteristics of Underwater Sound Impulses Generated by Pile Driving.....	15
3.2.1 Sound Pressure – Single Impacts	15
3.2.2 Sound Pressure – Successive Hammer Impacts	17
3.2.3 Sound Pressure – Complete Pile-Driving Event	18
3.2.4 Impulsive Sound Energy Characteristics.....	22
3.3 Comparison of Measured and Threshold Sound Pressures	26
3.4 Assessment of Bubble Curtain Effectiveness.....	26
4.0 Discussion	30
5.0 Conclusions and Recommendations.....	32
6.0 References	33

Appendixes

Appendix A. Plots of Sound-Pressure Levels Over Time for Each Pile-Driving Event	A.1
Appendix B. Tabulated Distribution Statistics of Impulse Sound Metrics for Each Pile-Driving Event.....	B.1
Appendix C. Plots Showing Root Mean Square Pressure, Peak Positive Pressure, and Peak Negative Pressure at Each Sampled Impact for Each Pile	C.1
Appendix D. Distribution of Root Mean Square Pressure, Peak Positive Pressure, and Peak Negative Pressure for Each Pile-Driving Event	D.1
Appendix E. Plots of Spectral Density (Sound Energy) at Each Hydrophone for Each Pile	E.1
Appendix F: Bubble Curtain Design and Specification Information	F.1

Figures

Figure 1.	Aerial View of Hood Canal Bridge Showing Eastern Bridge Terminus where Hydroacoustic Data Collection Occurred	2
Figure 2.	Photograph of Hood Canal Bridge Study Site Showing Temporary Work Trestle Below Eastern Approach of Main Bridge Span at Low Tide	3
Figure 3.	Plumb and Batter Piles Supporting Temporary Work Trestle at the Eastern Approach of the Hood Canal Bridge	3
Figure 4.	Impact Pile-Driving Hammer Used to Drive Monitored Piles	5
Figure 5.	Diagram of Hydroacoustic Monitoring System.....	6
Figure 6.	Schematic Plan View of Hydrophone Array	7
Figure 7.	Hydrophone Array Deployment: 1) hydrophones and floats in vessel ready to deploy along floating backbone line; 2) floating backbone line extending parallel to shore from piling; 3) deployed hydrophone float connected to data acquisition system; and 4) shipboard data acquisition system.....	7
Figure 8.	Locations of Plumb and Batter Piles Monitored With or Without Sound Mitigation (Bubble Curtain) During Hydroacoustic Monitoring Study, Eastern Approach of the Hood Canal Bridge	11
Figure 9.	Sound-Pressure Levels Measured for a Single Impact of Plumb Pile 235 Driven in 4.5 ft of Water with the Bubble Curtain in Place (bottom, H1; middle, H2; top, H3).....	16
Figure 10.	Sound-Pressure Levels Measured for a Single Impact of Batter Pile 178 Driven in 37 ft of Water without Bubble Curtain in Place (bottom, H1; middle, H2; top, H3).....	16
Figure 11.	Sound-Pressure Levels Measured over Successive Impacts for Plumb Pile 235 Driven in 4.5 ft of Water with the Bubble Curtain in Place (bottom, H1; middle, H2; top, H3).....	17
Figure 12.	Sound-Pressure Levels Measured over Successive Impacts of Batter Pile 178 Driven in 37 ft of Water Without Bubble Curtain in Place (bottom, H1; middle, H2; top, H3).....	18
Figure 13.	Sound-Pressure Levels (Pa) Measured for Plumb Pile 235 Driven in 4.5 ft of Water with the Bubble Curtain in Place. H1 (bottom plot), H2 (middle plot), and H3 (top plot) were approximately 64.7, 89.1, and 154.8 ft from the pile, respectively.	21
Figure 14.	Sound-Pressure Levels (Pa) measured for batter pile 178 driven in 37 ft of water with no bubble curtain. H1 (bottom plot), H2 (middle plot), and H3 (top plot).	21
Figure 15.	Example of Plots of Spectral Density Indices (Pa ² /Hz) versus Frequency (Hz) at Each Hydrophone (H1, H2, H3 from left to right) for First 20 Impacts on Plumb Piles 172, 171, and 238	23
Figure 16.	Power Spectral Density Indices (Figure 16a: H1 top plot, H2 middle plot, H3 bottom plot) and Cumulative Sound Exposure Over Time (Figure 16b)	

	for a Single Pile-Driving Impact Measured at Plumb Pile 255, Driven in 33 ft of Water with Bubble Curtain.	24
Figure 17.	Power Spectral Density Indices (Figure 17a: H1 top plot, H2 middle plot, H3 bottom plot) and Cumulative Sound Exposure Over Time (Figure 17b) for a Single Pile-Driving Impact Measured at Plumb Pile 50N, Driven in 40 ft of Water Without Bubble Curtain.	25
Figure 18.	Power Spectral Density Indices (Figure 18a: H1 top plot, H2 middle plot, H3 bottom plot) and Cumulative Sound Exposure Over Time (Figure 18b) for a Single Pile-Driving Impact Measured at Plumb Pile 238, Driven in 7 ft of Water with Bubble Curtain.....	27
Figure 19.	Power Spectral Density Indices (Figure 19a: H1 top plot, H2 middle plot, H3 bottom plot) and Cumulative Sound Exposure Over Time (Figure 19b) for a Single Pile-Driving Impact Measured at Plumb Pile 240, Driven in 9 ft of Water Without Bubble Curtain.....	28

Tables

Table 1.	Piles Monitored at Hood Canal Bridge in Fall 2004.....	10
Table 2.	Results of System Performance Measurements Compared with Expected Values.....	12
Table 3.	Cumulative Distribution Statistics for Background Peak Sound Pressure.....	13
Table 4.	Cumulative Distribution Statistics for Background Root Mean Square Sound Pressure.....	14
Table 5.	Summary Statistics for Peak Positive Pressure and RMS Pressure for Each Monitored Pile-driving event.....	19
Table 6.	Percentage of Impacts at each Hydrophone that Exceeded Threshold Values for Protection of Marine Life.....	29
Table 7.	Summary Statistics for Transmission Loss Rates Between Hydrophones 1 and 3.....	30

1.0 Introduction

Battelle Pacific Northwest Division conducted hydroacoustic measurement of sound-pressure levels during the driving of steel piles used to construct a temporary work trestle at the eastern approach of the Hood Canal Bridge near Port Gamble, Kitsap County, Washington (Figure 1, Figure 2). This work was conducted as part of the bridge project to address the potential effects of underwater sounds and sound energy on fish and diving birds in a nearshore marine environment. The goal of the hydroacoustic study was to assist WSDOT in meeting resource agency conditions for Hood Canal Bridge construction activities by providing data describing the underwater sound-pressure levels that occurred during pile driving at the site. The Hood Canal Bridge construction site offered an opportunity to conduct a hydroacoustic study during pile driving where differing pile types, water depths, substrate types, tides, and current conditions could all affect underwater sound.

Steel piles were driven with a diesel impact hammer, which, as opposed to wood or concrete piles driven by other means such as a vibratory hammer, required hydroacoustic monitoring unless a bubble curtain were used to mitigate sound (Biological Opinion FWS Reference 1-2-02-F-1484; NOAA Reference 2002-00546). Although the construction contractor deployed a bubble curtain for most piles driven, WSDOT requested that Battelle collect data on underwater sound-pressure levels from a subset of piles with and without the bubble curtain in place, to capture any differences in sound pressures from this type of sound-mitigation device. Both plumb and batter piles used for the temporary work trestle were of steel pipe with a wall thickness of 0.5 in.; the 24-in. diameter plumb piles were driven vertically into the substrate, whereas the 16-in. diameter batter piles were driven into the substrate at an angle (Figure 3).

The bubble curtains employed for sound mitigation were generated by pumping air under pressure to one or more diffusers in a ring around the pile, with the goal of completely surrounding the pile with a dense curtain of small bubbles. Bubble curtains are intended to confine a portion of the sound energy generated by the impact of a pile-driving hammer on a pile between the pile and the bubble curtain. Sound energy confined in this manner should decrease and become spectrally modified as it is repeatedly reflected between the bubbles and the pile. Bubble curtain designs employed by the WSDOT contractor at the Hood Canal Bridge site are discussed in more detail in Section 3, Results, Section 4, Discussion, and Appendix F.

As noted above, the goal of the hydroacoustic study was to characterize the underwater sound environment for a range of conditions: various water depths, different pile types, and with and without sound mitigation. The planned specific objectives of the hydroacoustic study were as follows:

- In consultation with WSDOT and the pile driving contractor, select piles to monitor in advance; randomly select approximately one pile in three to monitor in the absence of a bubble curtain.
- Acquire a complete digital tape recording of all pile-driving impact events for the monitored piles and post-process acquired data to estimate 1) the peak pressure for each impact event and 2) the root-mean-squared (RMS) underwater sound-pressure level of each impact event.
- Report the observed peak pressure and RMS sound-pressure levels in the form of plots for each monitored pile. In addition, report aggregated peak pressure and pressure levels for monitored piles with and without bubble curtains for each set of piles and for all monitored piles.



Figure 1. Aerial View of Hood Canal Bridge Showing Eastern Bridge Terminus where Hydroacoustic Data Collection Occurred



Figure 2. Photograph of Hood Canal Bridge Study Site Showing Temporary Work Trestle Below Eastern Approach of Main Bridge Span at Low Tide



Figure 3. Plumb (vertical, 24-in. diameter) and Batter (angled, 16-in. diameter) Piles Supporting Temporary Work Trestle at the Eastern Approach of the Hood Canal Bridge

Additional data analysis objectives were added later to address agency concerns regarding threshold levels for protection of marine life, as follows. First, the characteristics of the sound impulses produced by impact pile driving were described in detail, including a) a schedule of the piles at which sound levels were measured, b) characterization of sound generated by single impacts, c) characterization of sound generated by 7 to 10 successive impacts, d) characterization of sound generated by a total pile-driving event, and e) frequency distribution. Secondly, the hydroacoustic data were analyzed to determine the percentage of pile-driving impact sound impulses that exceeded NOAA Fisheries threshold levels for protection of marine species. These threshold levels are expressed as peak positive sound-pressure levels and RMS sound-pressure levels. The units for both peak positive and RMS sound pressure are decibels re 1 microPascal, or dB// μ Pa, which can be converted to common pressure units of Pascals (Pa) by the equation $\text{dB} = 20 * \log_{10}(\text{Pa} * 1.0 E+6)$. Protective threshold levels provided by NOAA Fisheries for WSDOT pile-driving projects were 150 dB_{RMS}// μ Pa (31.6 Pa) for fewer than 50% of pile-driving hammer impacts, and 180 dB_{PEAK}// μ Pa (1000 Pa) for all hammer impacts.

This report covers hydroacoustic measurements collected during pile driving at the eastern approach of the Hood Canal Bridge on September 2-3, October 27-28, and November 10-12, 2004. As the project progressed, it became clear that the sample design of pilings selected in advance could not be implemented as planned because of significant logistical challenges, including but not limited to the contractor's changing work schedule, weather, and pile-driving equipment failures. Rather, the piles where hydroacoustic data were collected were "piles of opportunity" selected according to the contractor's schedule, the type and location of the pile being driven, and weather and tide conditions. After the first round of data collection in September, the contractor was required by WSDOT to modify their sound-mitigation device and deployment because the bubble curtain was not being operated according to specifications. The concerns the contractor was asked to address were to ensure that: 1) the pile sleeve/bubble curtain was in contact with the substrate; 2) the top of the pile sleeve was above the water surface; 3) sufficient spacers were installed to keep the pile centered in the sleeve; and 4) the air supply system delivered 320 standard cubic feet per minute (scfm) at 100 pounds per square inch (psi). Several of these issues were easy for the contractor to address and implement, such as the addition of spacers and keeping the top of the pile sleeve above the water surface. Others were difficult to implement (consistent air supply at appropriate pressure) and/or observe (pile sleeve in contact with substrate). The hydroacoustic study resumed in late October, and ultimately, the total number of pilings monitored was greater than the original 15 planned. A total of 5 piles were monitored in September (3 with the bubble curtain and 2 without), and a total of 16 piles were monitored in October and November (13 with the bubble curtain and 3 without). A complete digital recording was obtained for all pile-driving impact events at each monitored piling, as planned, and the data were post-processed to provide a complete characterization of sound-pressure and sound-energy levels for each pile-driving event, also as planned.

Hydroacoustic data collection equipment, field deployment procedures, data processing, and data analysis methods are provided in Section 2 of this report. Results of hydroacoustic data collection, presented as sound-impulse characterization of a single pile-driving impact through a series of impacts to an entire pile-driving event, are presented in Section 3, along with an analysis of the data relative to marine life protection thresholds and bubble-curtain performance. Section 4 provides a discussion of sound-impulse characteristics as they relate to marine life exposure under the monitoring conditions and a summary evaluation of the hydroacoustic study design. Finally, conclusions and recommendations are provided in Section 5 and references in Section 6. Hydroacoustic data are presented in graphic and tabular form in Appendices A through E. Information on bubble-curtain design and specifications is provided in Appendix F.

2.0 Methods

2.1 Hydroacoustic Data Collection

2.1.1 Pile-Driving Hammer

Underwater sound pressures generated by pile driving are influenced by the pile type, substrate, depth of penetration, and wetted length of the pile. The depth of penetration into the substrate is determined by the pile-driving hammer; therefore, it is important to note the type, weight, and energy input of the hammer that was used during hydroacoustic data acquisition. The pile-driving hammer used on this project was an American Pile Driving Equipment, Inc. (APE) Model D46-32 diesel hammer (Figure 4). The hammer weighed 23,860 lbs with a ram weight of 10,143 lbs. The speed of delivery varies from 37 to 53 blows per minute but was generally 37 to 38 blows per minute for this project. The maximum energy range setting of 4 (107,172 ft-lbs) was used for all plumb piles that were monitored, with the exception of pile 252, for which the impact setting was 3 (88,952 ft-lbs). An impact setting of 2 (70,733 ft-lbs) was used on all batter piles that were monitored.



Figure 4. Impact Pile-Driving Hammer Used to Drive Monitored Piles

2.1.2 Sound Measuring Equipment

Underwater sound pressures were measured with a hydroacoustic data collection system (Figure 5). The system included three Bruel & Kjaer model 8104 hydrophones connected through Dytran Instruments, Inc., Model M4705AM 1mV/pC in-line charge amplifiers to a Dactron Focus II 4-channel digital spectrum analyzer. Data collection and anti-aliasing filtering were controlled by Dactron RT Pro Focus software. The data were written to a laptop computer. Signals from the hydrophones were saved to a Sony PC216Ax 16-channel digital audio tape (DAT) recorder. The digitizing sampling rates of the Focus II spectrum analyzer and the Sony DAT recorder were 48,000 and 24,000 samples per second, respectively.

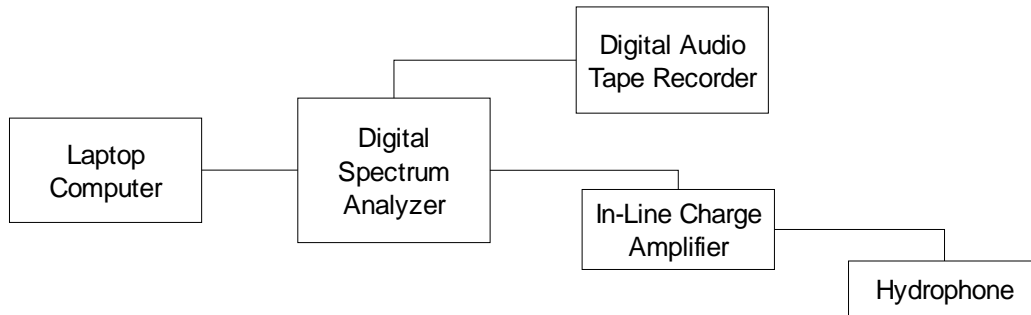

Figure 5. Diagram of Hydroacoustic Monitoring System

2.1.3 Hydrophone Array

Three hydrophones were deployed along a floating line, called the backbone, extending parallel to shore from the proximity of the pile being driven (Figure 6 and 7). The backbone was tied off at or near the pile being driven. The first hydrophone (H1) was placed approximately 33 ft (10 m) from the tie-off point. The second hydrophone (H2) was deployed along the backbone 33 ft (10 m) from H1, and the third hydrophone (H3) was deployed 131 ft (40 m) from H2. The backbone line was then pulled taut with a boat. Thus, H1, H2, and H3 were nominally located 33, 66, and 197 ft (10, 20, and 60 m) from the pile being monitored, respectively. These distances were not exact due to shifting currents and the logistics of hydrophone placement. Global positioning system (GPS) positions of the three hydrophones were recorded prior to each pile being driven to estimate the actual distance from the pile for each hydrophone; however, these data were not used because of movement in hydrophone location during the monitoring events. The hydrophone cables were connected to the data collection system aboard the Battelle research vessel, *R/V Strait Science*.

2.1.4 Collection Protocol

Prior to data collection, the function of the hydrophones were tested by comparing measurements made in the field at the time of deployment using a Bruel & Kjaer type 4229 pistonphone hydrophone calibrator with the factory hydrophone calibration receiving response provided by the manufacturer. During each day of field work prior to hydrophone deployment, each hydrophone was inserted into the pistonphone and the through-system performance of the data acquisition system for each hydrophone assessed. A calibration file was collected for each hydrophone, then processed and analyzed. Through-system time and frequency domain measurements were compared with pistonphone performance specifications and factory calibration. This testing also evaluated the performance of the digital spectrum analyzer and DAT recorder. Following field calibration checks, background underwater sound-pressure measurements were

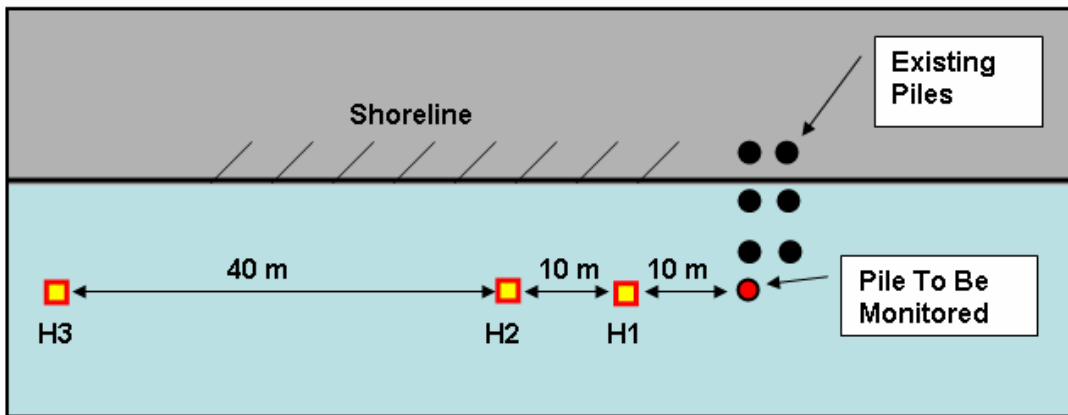

Figure 6. Schematic Plan View of Hydrophone Array

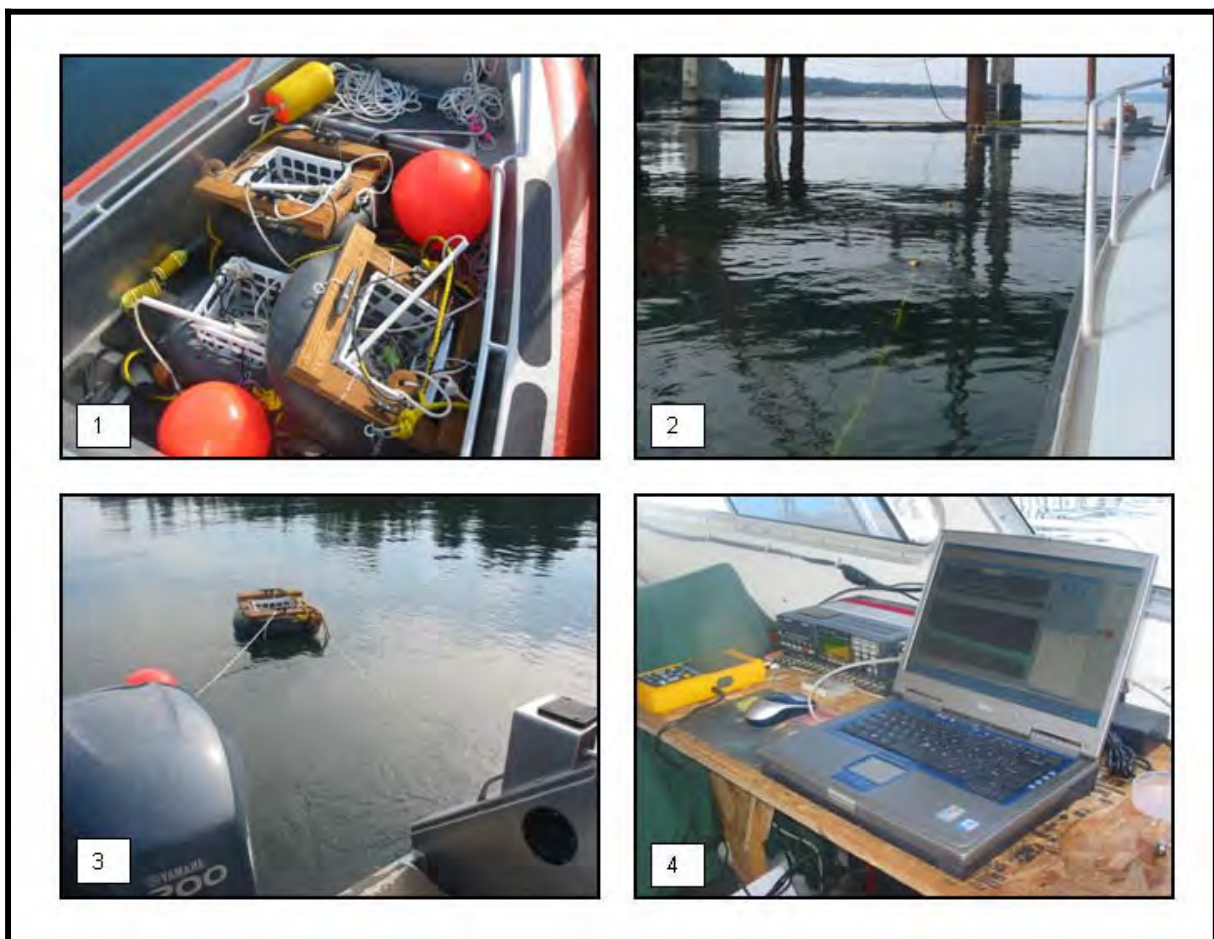

Figure 7. Hydrophone Array Deployment: 1) hydrophones and floats in vessel ready to deploy along floating backbone line; 2) floating backbone line extending parallel to shore from piling; 3) deployed hydrophone float connected to data acquisition system; and 4) shipboard data acquisition system

made prior to piles being driven to document ambient background noise, providing a baseline reference for analysis of pile-driving impulse sound observations. Data acquisition was initiated approximately 2 minutes prior to the start of a pile-driving event and terminated after pile driving had ceased. This procedure ensured that all of the impact events for each pile were recorded and available for analysis.

2.2 Hydroacoustic Data Analysis

Sound pressure impulse signal data were analyzed for all monitored piles. Because of the large amount of data and number of impacts to be analyzed, processing was automated using custom Statistical Analysis Systems (SAS) programs. The beginning of an impact signal for automated processing purposes was identified by the absolute change in pressure of 500 Pa (500 mV) over the time of 12 samples (4.2 E-5 sec). This initial point and the following 0.8 sec was included as part of an impact event. For the purpose of data analysis, event duration was standardized at 0.8 sec. This duration was shorter than the shortest time between impact events, but longer than the typical time for attenuation of the reverberation from the impact. This criterion permitted automated detection and extraction of impact events from acquired data.

Selection of an impulse analysis interval of 0.8 sec was the product of an examination of the effect of the length of impulse analysis interval on computations sensitive to analysis interval. Longer and shorter impulse analysis intervals were analyzed to determine the effect of impulse length on results of various calculations. We examined the effects of duration extremes by evaluating the effects of impulse analysis intervals of 0.3 sec and 1.5 sec on impulse duration and energy equivalent estimates. After processing a number of impacts chosen at random from a number of different piles, we found a maximum of 8% variability in impulse duration and 0.6% in energy equivalent (sum of pressure squared over 95% of the analysis interval). We also determined that an analysis interval of 0.8 sec was optimum to permit automated analysis of impact impulses for all pile-driving events observed during the study. The influence of background noise on impulse metrics requiring integration over the impulse was minimized by first integrating the squared pressure impulse signal over the full 0.8-sec standardized impulse duration period, then subtracting the last portion of the 0.8-sec impulse interval containing 5% of the summed squared impulse signal.

The number of hammer impacts and time required to drive a pile varied between piles (Appendix A). All of the impacts required to drive a pile were recorded and were available for analysis. For processing, analysis, and reporting each pile, the total time series of impact events was broken into three segments, each with equal numbers of samples. Peak positive and negative pressures and RMS pressure for each impact observed during driving of individual piles were determined. Summary statistics were computed for each pile segment. The number and percentage of impacts exceeding fish exposure criteria (180 dB_{PEAK}//1 μPa or 1000 Pa_{PEAK} and 150 dB_{RMS}//1 μPa or 31.6 Pa_{RMS}) were summarized for each pile. In addition, spectral analysis was conducted to obtain spectral density (Pa²/Hz) for each pile driven. The RMS pressure in Pascals and decibels for each impulse was computed as follows:

$$Pa_{rms} = \sqrt{\sum_{n=1}^k (Pa_k)^2 / k} \text{ and}$$

$$dB_{rms} = 20 * \log_{10} (Pa_{rms} * 1.0E + 6)$$

The duration of the impact was defined as the time between the initiation of the impact sound impulse and the time containing 95% of the impulse energy. Summary statistics were generated for each monitored pile. Statistics included the 5th, 10th, 25th, 75th, 90th, and 95th percentiles of the cumulative distribution of

impulse metrics, and minimum, maximum, median, mean, and standard deviations for peak and RMS pressure for each of the three analysis segments for each pile. The distributions were not tested for normality; there is no reason to suspect the distributions to be normal because the characteristics for each pile are dependent upon pile characteristics, substrate characteristics (which vary with depth), bubble curtain operation and effectiveness, and hammer operation.

3.0 Results

The hydroacoustic measurement results are presented and discussed in four sections. First, hydrophone calibration and background noise results are reported in Section 3.1 *Hydrophone In-Field Operation Validation*, followed by data that more completely describe the impact sound impulses in Section 3.2 *Characteristics of Underwater Sound Impulses Generated by Pile Driving*. Resulting observations of peak and RMS pressure are compared with marine protection threshold levels in Section 3.3 *Comparison of Measured and Threshold Sound Pressures*, and finally, observations about the sound attenuation performance of the bubble curtain and containment devices are presented in Section 3.4 *Assessment of Bubble Curtain Effectiveness*. All sound-pressure measurements presented in this report are given in Pa.

A total of 21 piles (14 plumb and 7 batter) were monitored in September, October, and November 2004 at the eastern end of the Hood Canal Bridge (Table 1, Figure 8). As described in Section 1, both plumb and batter piles were of steel pipe with a wall thickness of 0.5 in.; plumb piles were 24-in. diameter and were driven vertically into the substrate, whereas the 16-in. diameter batter piles were driven into the substrate at an angle (Figure 3). Of the monitored piles, three plumb and two batter piles were driven without a bubble curtain. Due to the tides, wave action, and constraints on safe placement of the hydrophones, it was not possible to consistently deploy the hydrophones precisely 10 m, 20 m, and 60 m from monitored piles.

3.1 Hydrophone In-Field Operation Validation

Tests of the sound monitoring electronics for through-system performance with the hydrophone calibrator (pistonphone) consistently showed that the system was operating within acceptable tolerance of factory-determined receiving sensitivity for the system's hydrophones and also that there was no distortion of the pistonphone signal by other portions of the monitoring system (Table 2). The peak frequency for pistonphone field calibration checks was 251.2 Hz. Peak sound-pressure levels varied from the expected peak amplitude by a maximum of 10.664 Pa (0.489 dB), which is within the margin of error for the pistonphone (± 0.6 dB).

Background noise was low within the measured frequency band (Tables 3 and 4). Median background peak sound pressure was between 0.81 Pa and 7.54 Pa (118.2 and 137.5 dB_{PEAK} re 1 μ Pa) (Table 3) and median RMS levels were between 0.59 Pa and 5.33 Pa (115.4 and 134.5 dB_{RMS} re 1 μ Pa) (Table 4). Most of the ambient background noise was below 10 Hz. These background levels were realistic for this environment in the absence of environmental factors, such as storm events with higher wind and rain, or anthropogenic noise, such as that generated by boat traffic. Background noise levels were several orders of magnitude below sound-pressure levels observed in pile-driving impact sound. Because background levels were insignificant relative to the amplitude of the signal from pile-driving impacts, low-level background noise was not removed from the data during impact sound signal data processing.

Table 1. Piles Monitored at Hood Canal Bridge in Fall 2004

Date	Start Time	End Time	Pile Type	Pile ID	Water Depth (ft)	Bubble Curtain Type ^a	Bubble Curtain Air Pressure
09/02/04	1442	1447	Plumb	52N	40	Type II Confined	120 cfm @ 90 psi
09/02/04	1540	1554	Plumb	50N	40	None	Not applicable
09/03/04	1021	1129	Plumb	121N	42	Type II Confined	95 cfm @25 psi
09/03/04	1145	1155	Plumb	118N	39	Type II Confined	320 cfm @ 40 psi
09/03/04	1234	1242	Plumb	120N	39	None	Not applicable
10/27/04	1028	1036	Plumb	235	4.5	Type II Confined	320 cfm @ 120 psi
10/27/04	1117	1127	Plumb	237	4	Type II Confined	330 cfm @ 115 psi
10/27/04	1305	1315	Plumb	238	7	Type II Confined	330 cfm @ 115 psi
10/27/04	1344	1354	Plumb	240	9	None	Not applicable
10/27/04	1637	1645	Plumb	172	20	Type II Confined	200-400 cfm@150 psi
10/28/04	0924	0939	Plumb	171 ^b	18	Type II Confined	100-400cfm@150 psi
10/28/04	1100	1106	Batter	167	7	Type I Unconfined	> 400 cfm @ 110 psi
10/28/04	1309	1336	Plumb	171 ^b	18	Type II Confined	200-400 cfm@140 psi
11/10/04	1005	1013	Plumb	255	33	Type II Confined	200-250 cfm@110 psi
11/10/04	1102	1109	Plumb	252	31	Type II Confined	200-260 cfm@110 psi
11/10/04	1149	1211	Plumb	249	32	Type II Confined	220-280 cfm@110 psi
11/10/04	1414	1417	Batter	177	37	Type I Unconfined	400 cfm@110 psi
11/10/04	1454	1500	Batter	174	29	Type I Unconfined	400 cfm@110 psi
11/10/04	1604	1607	Batter	178	37	None	Not applicable
11/12/04	0939	0942	Batter	182	41	Type I Unconfined	320 cfm@ 10 psi
11/12/04	1027	1031	Batter	181	33	Type I Unconfined	320 cfm @10 psi
11/12/04	1108	1116	Batter	244	20	None	Not applicable

a. See Appendix F: plumb piles were driven with bubbles confined in sleeve; sleeve was not used on batter piles driven at an angle.

b. Pile 171 needed bubble curtain sleeve extension added to complete driving, hence separation in time events.

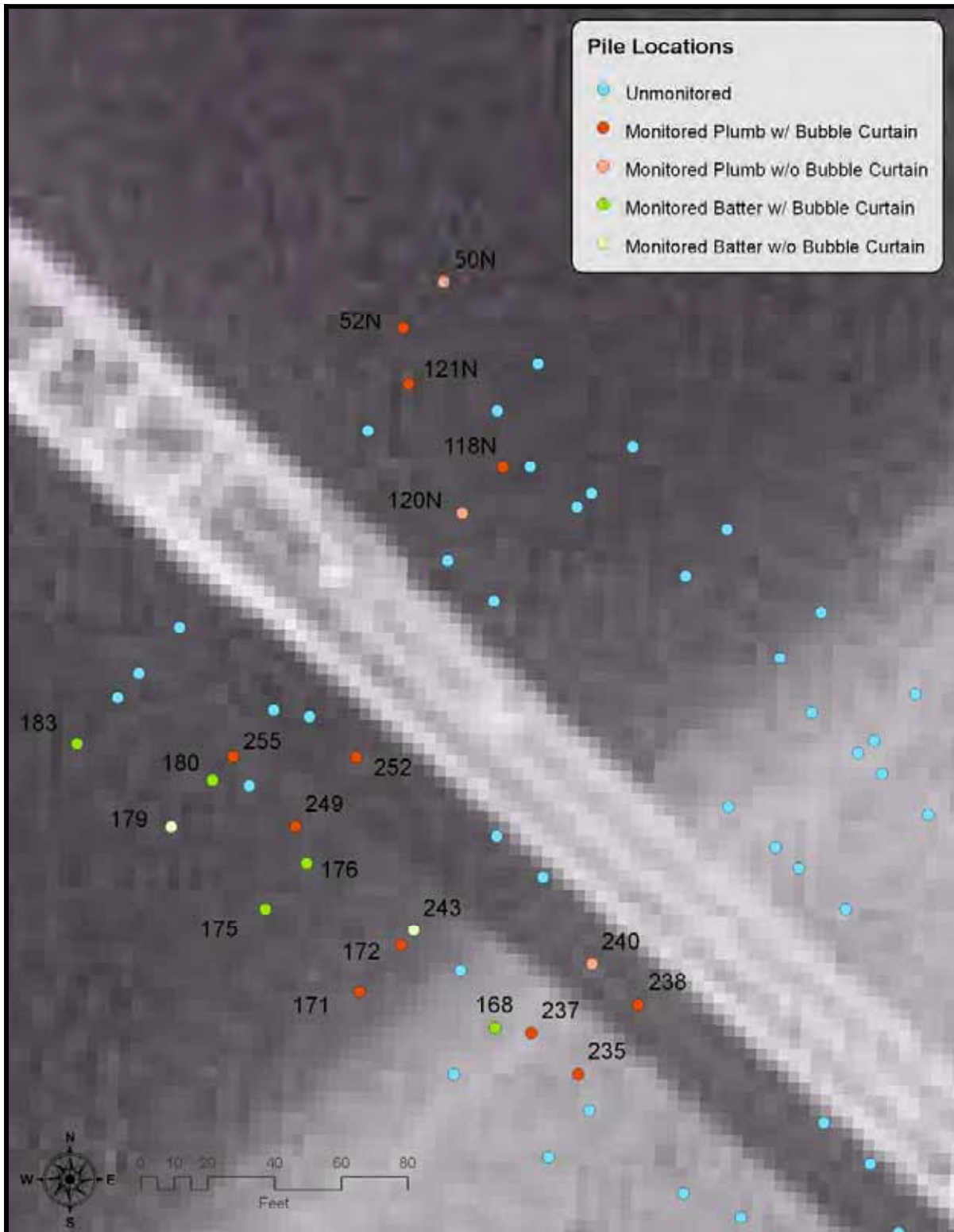

Figure 8. Locations of Plumb and Batter Piles Monitored With or Without Sound Mitigation (Bubble Curtain) During Hydroacoustic Monitoring Study, Eastern Approach of the Hood Canal Bridge

Table 2. Results of System Performance Measurements Compared with Expected Values

Date	Start Hour	Hydrophone Channel	Frequency (Hz)		Sound Pressure Level (Pa)		Root Mean Square Sound Pressure (Pa)	
			Peak	Expected	Peak	Expected Peak	RMS	Expected RMS
09/2/2004	9.970	1	251.2	251.2	184.064	184.296	130.153	130.317
09/2/2004	10.026	2	251.2	251.2	184.669	184.296	130.581	130.317
09/2/2004	10.082	3	251.2	251.2	185.024	184.296	130.832	130.317
09/3/2004	8.230	1	251.2	251.2	188.538	184.296	133.317	130.317
09/3/2004	8.301	2	251.2	251.2	186.515	184.296	131.886	130.317
09/3/2004	8.346	3	251.2	251.2	184.209	184.296	130.255	130.317
10/27/2004	9.658	1	251.2	251.2	183.669	184.296	129.873	130.317
10/27/2004	9.695	2	251.2	251.2	184.967	184.296	130.791	130.317
10/27/2004	9.743	3	251.2	251.2	179.430	184.296	126.876	130.317
10/28/2004	8.823	1	251.2	251.2	193.796	184.296	137.035	130.317
10/28/2004	8.863	2	251.2	251.2	182.326	184.296	128.924	130.317
10/28/2004	8.890	3	251.2	251.2	184.587	184.296	130.522	130.317
11/10/2004	8.665	1	251.2	251.2	187.500	184.296	132.582	130.317
11/10/2004	8.753	2	251.2	251.2	186.514	184.296	131.886	130.317
11/10/2004	8.829	3	251.2	251.2	194.960	184.296	137.857	130.317
11/12/2004	9.038	1	251.2	251.2	189.238	184.296	133.812	130.317
11/12/2004	9.089	2	251.2	251.2	182.344	184.296	128.937	130.317
11/12/2004	9.125	3	251.2	251.2	189.012	184.296	133.652	130.317

Table 3. Cumulative Distribution Statistics for Background Peak Sound Pressure

Date	Start Hour	Hydrophone Channel	Background Peak Sound Pressure (Pa)										
			Minimum	Percentile			Median (50th)	Average	Std Error	Percentile			Maximum
				5th	10th	25th				75th	90th	95th	
9/2/2004	14.143	1	0.01	0.31	0.47	0.83	1.55	2.56	0.04	3.19	5.87	7.77	77.36
9/2/2004	14.143	2	0.03	0.34	0.53	0.87	1.55	2.60	0.06	3.09	5.89	7.66	56.74
9/2/2004	14.143	3	0.02	0.26	0.35	0.58	0.99	1.49	0.03	1.64	3.08	4.62	44.22
9/3/2004	10.050	1	0.02	0.24	0.35	0.56	0.87	1.03	0.01	1.29	1.82	2.33	10.20
9/3/2004	10.050	2	0.02	0.31	0.41	0.64	1.02	2.20	0.10	1.52	2.39	10.11	40.84
9/3/2004	10.050	3	0.01	0.24	0.34	0.54	0.83	0.98	0.01	1.21	1.68	2.10	14.00
10/27/2004	10.355	1	0.03	0.26	0.38	0.63	1.02	1.57	0.03	1.69	3.23	4.90	24.11
10/27/2004	10.355	2	0.02	0.32	0.45	0.70	1.11	1.58	0.03	1.81	3.27	4.33	157.04
10/27/2004	10.355	3	0.02	0.24	0.35	0.55	0.87	1.12	0.02	1.32	1.96	2.50	32.54
10/28/2004	9.416	1	0.01	0.27	0.37	0.58	0.90	1.09	0.01	1.33	1.93	2.51	28.51
10/28/2004	9.416	2	0.01	0.30	0.41	0.67	1.08	1.38	0.02	1.68	2.48	3.12	122.31
10/28/2004	9.416	3	0.01	0.24	0.32	0.52	0.83	1.02	0.01	1.24	1.79	2.30	18.61
11/10/2004	10.793	1	0.01	0.69	1.06	2.31	7.54	15.02	0.21	17.13	35.09	58.02	249.74
11/10/2004	10.793	2	0.02	0.53	0.76	1.45	5.46	13.70	0.21	19.02	37.63	53.53	141.94
11/10/2004	10.793	3	0.05	0.45	0.64	1.08	2.12	5.72	0.16	7.47	16.83	21.98	68.38
11/10/2004	11.809	1	0.01	0.25	0.37	0.61	1.00	1.27	0.02	1.56	2.23	3.00	21.51
11/10/2004	11.809	2	0.04	0.28	0.41	0.64	0.99	1.24	0.03	1.43	2.04	2.60	32.60
11/10/2004	11.809	3	0.05	0.23	0.32	0.52	0.81	1.35	0.11	1.19	1.65	2.08	64.54
11/10/2004	14.113	1	0.01	0.37	0.55	1.00	1.95	4.42	0.07	5.04	11.64	16.96	88.85
11/10/2004	14.113	2	0.01	0.38	0.54	0.90	1.58	3.10	0.04	3.27	7.79	12.23	37.86
11/10/2004	14.113	3	0.05	0.31	0.44	0.73	1.24	3.85	0.12	2.95	11.64	19.29	54.82
11/10/2004	14.721	1	0.01	0.33	0.47	0.79	1.31	1.59	0.01	2.02	2.95	3.83	14.97
11/10/2004	14.721	2	0.03	0.34	0.50	0.87	1.42	1.80	0.02	2.23	3.35	4.38	18.79
11/10/2004	14.721	3	0.03	0.35	0.52	0.84	1.38	1.75	0.03	2.10	3.10	4.21	32.62
11/10/2004	16.067	1	0.03	0.27	0.38	0.62	1.09	8.59	0.47	3.64	22.52	45.99	387.61
11/10/2004	16.067	2	0.00	0.28	0.38	0.62	0.97	1.23	0.01	1.43	2.08	2.82	21.24
11/10/2004	16.067	3	0.02	0.24	0.34	0.56	0.86	1.31	0.06	1.29	1.90	2.66	32.76
11/12/2004	9.451	1	0.02	0.52	0.77	1.37	2.35	2.70	0.01	3.49	4.92	6.36	26.39
11/12/2004	9.451	2	0.03	0.68	1.05	2.18	4.06	4.42	0.02	5.99	7.92	9.50	33.35
11/12/2004	9.451	3	0.01	0.36	0.51	0.89	1.54	1.82	0.01	2.39	3.30	4.10	13.63
11/12/2004	10.398	1	0.01	0.25	0.36	0.58	0.91	1.15	0.01	1.41	2.19	2.94	8.88
11/12/2004	10.398	2	0.01	0.27	0.38	0.62	0.98	1.12	0.01	1.42	1.97	2.41	14.90
11/12/2004	10.398	3	0.02	0.23	0.32	0.52	0.81	0.95	0.01	1.17	1.62	2.00	14.66
11/12/2004	10.978	1	0.04	0.63	0.94	1.67	2.78	3.10	0.02	4.07	5.52	6.58	24.27
11/12/2004	10.978	2	0.01	0.46	0.69	1.20	2.00	2.20	0.01	2.90	3.84	4.59	21.87
11/12/2004	10.978	3	0.02	0.32	0.47	0.82	1.36	1.65	0.02	1.99	2.78	3.83	24.02

Table 4. Cumulative Distribution Statistics for Background Root Mean Square Sound Pressure

Date	Start Hour	Hydrophone Channel	Background RMS Sound Pressure (Pa)										
			Minimum	Percentile			Median	Average	Std Error	Percentile			Maximum
				5th	10th	25th	(50th)			75th	90th	95th	
9/2/2004	14.143	1	0.01	0.22	0.33	0.59	1.09	1.81	0.03	2.26	4.15	5.49	54.70
9/2/2004	14.143	2	0.02	0.24	0.37	0.61	1.10	1.84	0.04	2.18	4.17	5.42	40.12
9/2/2004	14.143	3	0.01	0.18	0.25	0.41	0.70	1.05	0.02	1.16	2.18	3.27	31.27
9/3/2004	10.050	1	0.01	0.17	0.25	0.40	0.62	0.73	0.00	0.91	1.28	1.65	7.21
9/3/2004	10.050	2	0.01	0.22	0.29	0.46	0.72	1.56	0.07	1.07	1.69	7.15	28.88
9/3/2004	10.050	3	0.00	0.17	0.24	0.38	0.59	0.69	0.01	0.86	1.19	1.48	9.90
10/27/2004	10.355	1	0.02	0.18	0.27	0.45	0.72	1.11	0.02	1.19	2.28	3.47	17.05
10/27/2004	10.355	2	0.02	0.23	0.32	0.50	0.79	1.12	0.02	1.28	2.31	3.06	111.04
10/27/2004	10.355	3	0.01	0.17	0.25	0.39	0.61	0.79	0.02	0.93	1.39	1.77	23.01
10/28/2004	9.416	1	0.00	0.19	0.26	0.41	0.64	0.77	0.00	0.94	1.37	1.78	20.16
10/28/2004	9.416	2	0.01	0.21	0.29	0.47	0.76	0.98	0.01	1.19	1.75	2.21	88.49
10/28/2004	9.416	3	0.01	0.17	0.23	0.37	0.59	0.72	0.00	0.87	1.26	1.62	13.16
11/10/2004	10.793	1	0.01	0.49	0.75	1.63	5.33	10.62	0.15	12.11	24.82	41.03	176.59
11/10/2004	10.793	2	0.02	0.37	0.54	1.02	3.86	9.69	0.15	13.45	26.61	37.85	100.37
11/10/2004	10.793	3	0.04	0.32	0.45	0.76	1.50	4.04	0.11	5.28	11.90	15.54	48.36
11/10/2004	11.809	1	0.01	0.18	0.26	0.43	0.70	0.90	0.01	1.10	1.57	2.12	15.21
11/10/2004	11.809	2	0.03	0.20	0.29	0.45	0.70	0.88	0.02	1.01	1.44	1.84	23.06
11/10/2004	11.809	3	0.03	0.16	0.23	0.37	0.57	0.96	0.08	0.84	1.16	1.47	45.64
11/10/2004	14.113	1	0.00	0.26	0.39	0.71	1.38	3.12	0.05	3.56	8.23	11.99	62.83
11/10/2004	14.113	2	0.01	0.27	0.38	0.64	1.11	2.19	0.03	2.31	5.51	8.65	26.77
11/10/2004	14.113	3	0.03	0.22	0.31	0.52	0.88	2.72	0.09	2.09	8.23	13.64	38.76
11/10/2004	14.721	1	0.01	0.23	0.33	0.56	0.93	1.13	0.01	1.43	2.08	2.71	10.58
11/10/2004	14.721	2	0.02	0.24	0.36	0.60	1.00	1.28	0.01	1.57	2.37	3.10	13.28
11/10/2004	14.721	3	0.02	0.25	0.37	0.59	0.98	1.24	0.02	1.49	2.19	2.97	23.06
11/10/2004	16.067	1	0.02	0.19	0.27	0.44	0.77	6.07	0.33	2.57	15.92	32.52	274.08
11/10/2004	16.067	2	0.00	0.20	0.27	0.44	0.68	0.87	0.01	1.01	1.47	1.99	15.02
11/10/2004	16.067	3	0.02	0.17	0.24	0.39	0.61	0.93	0.04	0.91	1.35	1.88	23.17
11/12/2004	9.451	1	0.01	0.36	0.54	0.97	1.66	1.91	0.01	2.47	3.48	4.50	18.66
11/12/2004	9.451	2	0.02	0.08	0.75	1.54	2.87	3.12	0.02	4.24	5.60	6.72	23.58
11/12/2004	9.451	3	0.01	0.26	0.36	0.63	1.09	1.28	0.01	1.69	2.33	2.90	9.64
11/12/2004	10.398	1	0.00	0.18	0.25	0.41	0.65	0.81	0.01	1.00	1.55	2.08	6.28
11/12/2004	10.398	2	0.01	0.19	0.27	0.44	0.69	0.79	0.01	1.01	1.39	1.70	10.53
11/12/2004	10.398	3	0.01	0.16	0.23	0.37	0.57	0.67	0.01	0.83	1.15	1.41	10.37
11/12/2004	10.978	1	0.03	0.45	0.67	1.18	1.96	2.19	0.02	2.88	3.90	4.66	17.16
11/12/2004	10.978	2	0.01	0.32	0.49	0.85	1.41	1.56	0.01	2.05	2.72	3.25	15.47
11/12/2004	10.978	3	0.01	0.23	0.34	0.58	0.96	1.17	0.02	1.40	1.96	2.71	16.99

3.2 Characteristics of Underwater Sound Impulses Generated by Pile Driving

The characteristics of underwater sound-impact impulses are described by examining the sound-pressure data for a single impact (hammer blow, <1-sec duration), a succession of impacts (approximately 10-sec duration), and all of the impacts for a typical pile-driving event (minutes) in Sections 3.2.1 through 3.2.3, respectively. Plumb and batter piles are considered separately. In addition to sound-pressure levels, exposure levels (cumulative pressure over time) and sound energy (spectral density or frequency content over the range of frequencies) are characteristics of underwater sound that are important to consider when looking at potential effects on marine life, especially fish. Exposure and energy metrics are presented in Section 3.2.4.

As described in Section 2, the amount of time and the number of hammer impacts required to drive a pile varied between piles (Appendix A, Appendix B). All of the impacts required to drive a pile were recorded and were available for analysis. For processing, analysis, and reporting each pile, the total time series of impact events was broken into three segments, each with an equal number of samples (one third of the total number of impacts). Peak positive and negative pressures and RMS pressure for each impact observed during driving of individual piles were determined. Summary statistics computed for each pile segment are tabulated in Appendix B. Appendix C provides a graphical representation of each pile-driving event, shown as peak positive, peak negative, and RMS pressure at each impact in each of the three segments in a time series at each hydrophone. The statistical distribution of each of these measurements is shown graphically in Appendix D.

3.2.1 Sound Pressure – Single Impacts

Plumb Piles: The duration of sound impulses ranged from 0.011 sec to 0.791 sec with a median duration of 0.0389 sec for all plumb piles. Observed impulse durations were longest at the hydrophone located the greatest distance from the pile. Figure 9 shows an example of the sound-pressure levels for the three hydrophones used to collect data at plumb pile 235, which was driven with a bubble curtain in place. The increase in impulse duration with distance from the pile is the result of summation of the sound signal from the impact that arrives by the shortest direct path and those that take a slightly longer path to the hydrophone after being reflected off the surface and bottom. Additional sound may enter the water column to mix with that in the water after propagating away from the pile in ocean bottom substrate. These various versions of the sum of the impact signal upon arrival at the hydrophone are caused by alterations to the direct path signal, which commonly include increases in duration and amplitude and phase modulation of the pressure signal. The impact impulses observed at the three hydrophones also show the effects of attenuation, which is frequency-dependent, i.e., higher frequencies attenuate more rapidly than lower frequencies, and spread with distance as the impact sound impulse propagates away from the pile.

Batter Piles: Durations of single impulses from impacts on batter piles ranged from 0.018 sec to 0.758 sec, with a median duration of 0.0581 sec. For the same reason stated above for plumb piles, impact-impulse durations were almost always longest at the hydrophone the greatest distance from the pile (top plot, Figure 10).

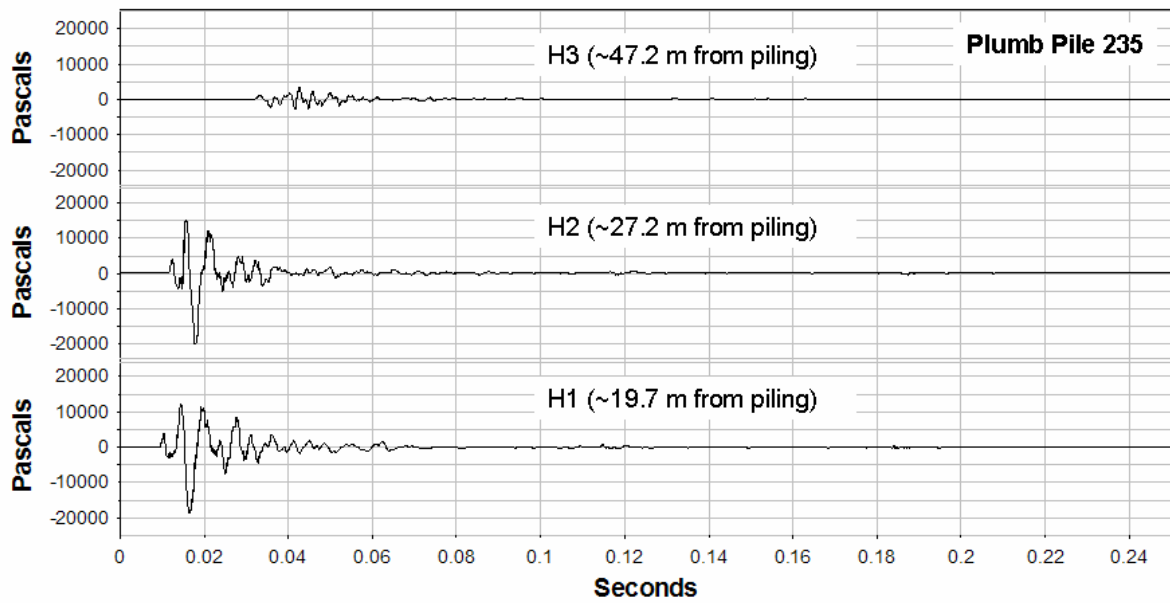

Figure 9. Sound-Pressure Levels Measured for a Single Impact of Plumb Pile 235 Driven in 4.5 ft of Water with the Bubble Curtain in Place (bottom, H1; middle, H2; top, H3)

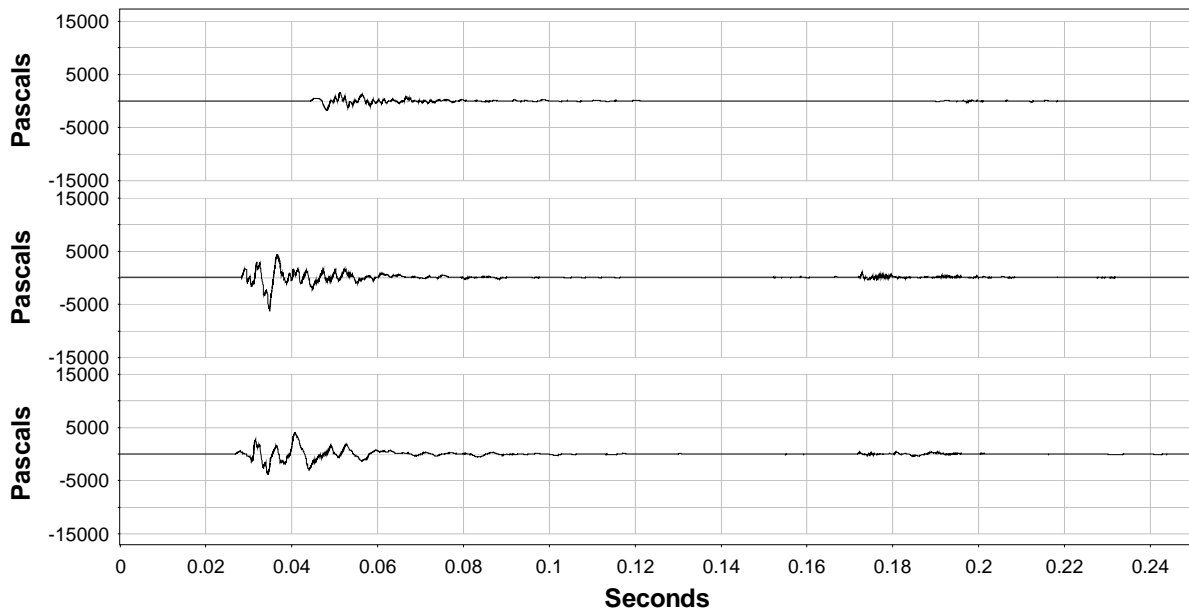

Figure 10. Sound-Pressure Levels Measured for a Single Impact of Batter Pile 178 Driven in 37 ft of Water without Bubble Curtain in Place (bottom, H1; middle, H2; top, H3)

3.2.2 Sound Pressure – Successive Hammer Impacts

The time between hammer impacts and the duration of each impact sound event in conjunction with other factors (e.g., behavior of fish in the vicinity of the pile, water current velocities) determine the amount of time during driving of a pile that fish are exposed to pile-impact sound.

Plumb Piles. The time between impacts varied slightly between piles and increased the deeper a pile was driven into the substrate. The time between impacts for plumb piles averaged 1.4 sec, about 7 impacts every 10 sec (Figure 11). Time between impacts increased from about 1.25 sec at the beginning of the pile-driving event to 1.5 sec at the end.

Batter Piles: Similar to plumb piles, time between impacts varied slightly between batter piles and increased the deeper a pile was driven into the substrate. The time between impacts for batter piles averaged 1.2 sec, about 8 impacts every 10 sec (Figure 12). The time between strikes varied from about 1.0 sec at the beginning of the pile-driving event to 1.4 sec at the end.

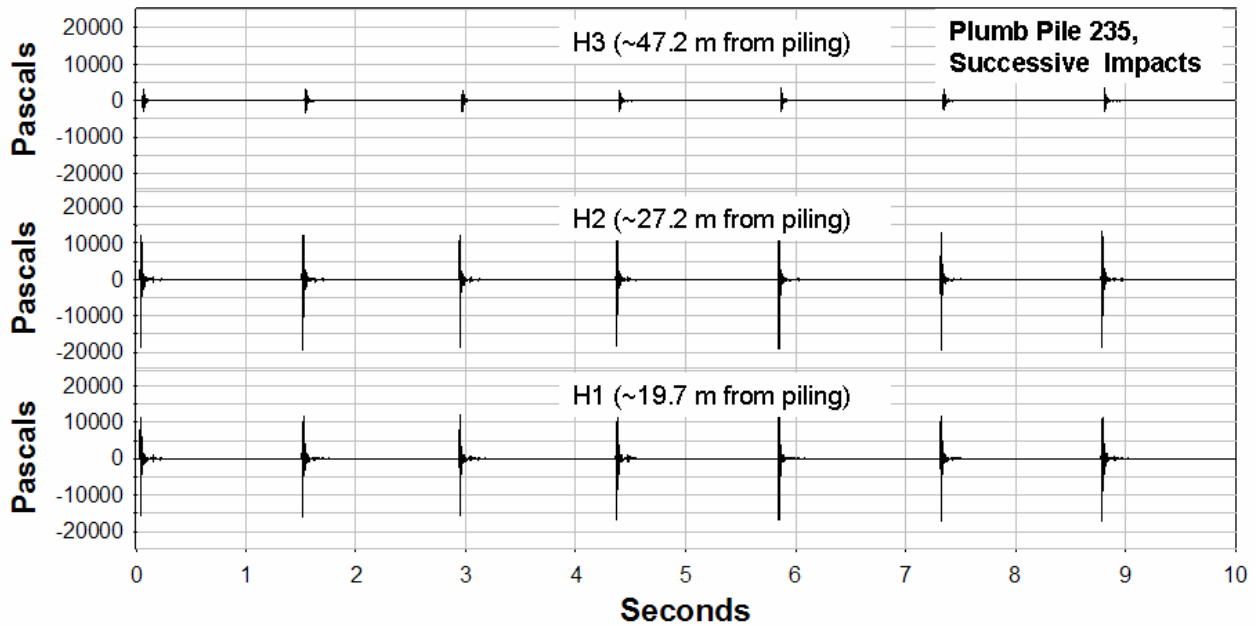

Figure 11. Sound-Pressure Levels Measured over Successive Impacts for Plumb Pile 235 Driven in 4.5 ft of Water with the Bubble Curtain in Place (bottom, H1; middle, H2; top, H3)

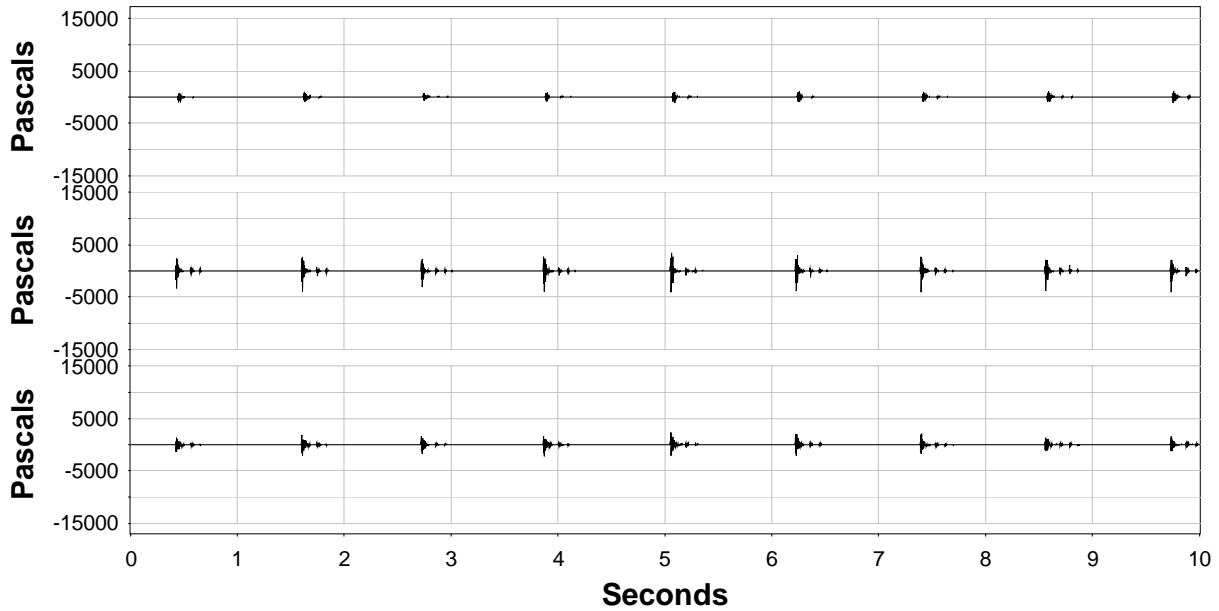

Figure 12. Sound-Pressure Levels Measured over Successive Impacts of Batter Pile 178 Driven in 37 ft of Water Without Bubble Curtain in Place (bottom, H1; middle, H2; top, H3)

3.2.3 Sound Pressure – Complete Pile-Driving Event

For each complete pile-driving event, the number of impacts and summary statistics (minimum, maximum, and mean) for peak positive pressure and RMS pressure are provided for each hydrophone (H1, H2, H3) in Table 5. Sequences of sound-pressure observations for typical plumb and batter pile-driving events are presented in Figure 13 and 14, respectively. Similar graphs of the sequence of sound-pressure levels over time at each hydrophone for all monitored pile-driving events are provided in Appendix A. More detailed distribution statistics for all sound measurements are tabulated in Appendix B. Peak positive, peak negative, and RMS sound pressures are shown graphically for each impact series (by hydrophone) in Appendix C; the statistical distributions for peak positive, peak negative, and RMS sound pressures are shown graphically in Appendix D.

Plumb Piles: Peak and RMS sound pressure varied between piles and was also quite variable over the driving duration for individual piles (Table 5). Sound pressure varied from peak positive pressure of 15,525 Pa to peak negative pressure of -24,491 Pa (Appendix B, Tables B.2 and B.3). The median peak positive and peak negative values for all plumb pile impacts were 5,952 Pa and -6,580 Pa. The precise reasons for observed variation in sound-pressure levels for individual piles cannot be determined; however, the variation is most likely due to a combination of factors, including operation of the hammer, composition of substrate, and the dynamic response of the pile to hammer blows.

There was a distinct decrease in sound-pressure levels with increased distance of the hydrophones from the pile due to shallow-water sound propagation factors, including attenuation and geometric spreading; however, there were a few instances in which pressure levels were higher at longer range. The time sequence of sound-pressure levels for all piles is provided in Appendix A.

Table 5. Summary Statistics for Peak Positive Pressure and RMS Pressure for Each Monitored Pile-driving event

Pile ID	Pile Type	Bubble Curtain	Water Depth (ft)	Hydro-phone Number	Hydro-phone Depth (ft)	Number of Impacts	Peak Positive Pressure (Pa)			RMS Pressure (Pa)		
							Minimum	Maximum	Average	Minimum	Maximum	Average
121N	Plumb	Type II Confined	42	H1	20	296	2192	11763	7736	62	3728	1937
121N	Plumb	Type II Confined	42	H2	20	296	1296	12547	5023	36	2521	1406
121N	Plumb	Type II Confined	42	H3	20	294	561	5869	3026	23	1222	702
52N	Plumb	Type II Confined	40	H1	20	107	1935	10531	7910	350	2992	2211
52N	Plumb	Type II Confined	40	H2	20	107	3391	14782	9401	804	4498	2772
52N	Plumb	Type II Confined	40	H3	20	107	714	7923	4665	204	1481	1168
118N	Plumb	Type II Confined	39	H1	20	203	606	12508	8539	48	2963	1984
118N	Plumb	Type II Confined	39	H2	20	202	1940	7722	5186	358	1639	1114
118N	Plumb	Type II Confined	39	H3	20	200	930	2986	2331	53	591	438
255	Plumb	Type II Confined	33	H1	10	234	1869	8011	6134	461	3109	2137
255	Plumb	Type II Confined	33	H2	10	234	1594	7532	5296	387	2585	1783
255	Plumb	Type II Confined	33	H3	10	234	463	14039	2456	108	4002	458
249	Plumb	Type II Confined	32	H1	10	506	1569	15214	7482	329	3274	1952
249	Plumb	Type II Confined	32	H2	10	506	1441	14297	5954	189	3065	1896
249	Plumb	Type II Confined	32	H3	10	505	316	3421	2007	53	791	428
252	Plumb	Type II Confined	31	H1	10	256	1145	10900	7209	171	4506	2972
252	Plumb	Type II Confined	31	H2	10	256	1629	7415	4898	125	2990	1866
252	Plumb	Type II Confined	31	H3	10	253	521	3495	1924	34	748	304
172	Plumb	Type II Confined	20	H1	23 ^a	194	650	14258	10234	40	7169	4542
172	Plumb	Type II Confined	20	H2	23 ^a	194	952	15135	11469	97	10746	5436
172	Plumb	Type II Confined	20	H3	13 ^a	188	688	3775	2906	58	1123	854
171	Plumb	Type II Confined	18	H1	6,7 ^b	405	1191	12435	8673	266	4775	2589
171	Plumb	Type II Confined	18	H2	6,10 ^b	405	1028	13742	9160	224	5586	3162
171	Plumb	Type II Confined	18	H3	7,6 ^b	397	593	3750	2818	143	1958	1037
238	Plumb	Type II Confined	7	H1	15 ^a	218	995	9712	5156	112	3852	2006
238	Plumb	Type II Confined	7	H2	15 ^a	216	639	9395	5711	45	3634	2122
238	Plumb	Type II Confined	7	H3	7 ^a	204	442	4279	3088	54	1566	998
235	Plumb	Type II Confined	4.5	H1	9.0 ^a	257	1996	8681	5882	420	4136	2163
235	Plumb	Type II Confined	4.5	H2	8.6 ^a	257	2057	8812	5161	293	3125	1936
235	Plumb	Type II Confined	4.5	H3	8.3 ^a	257	895	5258	4229	87	2076	1349
237	Plumb	Type II Confined	5	H1	14 ^a	368	1336	10087	6938	261	3173	2144
237	Plumb	Type II Confined	5	H2	10 ^a	368	756	9814	6269	102	2988	1923
237	Plumb	Type II Confined	5	H3	9 ^a	366	594	4905	3606	60	2194	1277

Table 5. (contd)

Pile ID	Pile Type	Bubble Curtain	Water Depth (ft)	Hydrophone Number	Hydrophone Depth (ft)	Number of Impacts	Peak Positive Pressure (Pa)			RMS Pressure (Pa)		
							Minimum	Maximum	Average	Minimum	Maximum	Average
50N	Plumb	None	40	H1	20	334	276	14456	11227		2745	2038
50N	Plumb	None	40	H2	20	334	1071	14335	11422	50	2682	2109
50N	Plumb	None	40	H3	20	335	598	14376	10684	60	3968	2710
120N	Plumb	None	39	H1	20	152	1941	15525	11578	439	4528	3380
120N	Plumb	None	39	H2	20	152	1149	12446	8369	230	3133	2419
120N	Plumb	None	39	H3	20	151	1016	6684	5064	299	1952	1578
240	Plumb	None	9	H1	15 ^a	297	1314	15147	8502	133	4399	2811
240	Plumb	None	9	H2	15 ^a	298	177	14528	7157	34	4308	2510
240	Plumb	None	9	H3	7 ^a	296	611	7216	5300	37	2206	1585
182	Batter	Type I Unconfined	41	H1	15	46	1038	9349	6206	132	2295	1485
182	Batter	Type I Unconfined	41	H2	15	46	869	6405	4543	116	2563	1613
182	Batter	Type I Unconfined	41	H3	15	46	503	3455	2328	105	946	629
177	Batter	Type I Unconfined	37	H1	10	28	396	4204	2363	26	1318	502
177	Batter	Type I Unconfined	37	H2	10	26	638	7361	2161	52	1289	510
177	Batter	Type I Unconfined	37	H3	10	21	500	2045	1152	57	457	168
181	Batter	Type I Unconfined	33	H1	15	49	595	5323	3250	25	1938	946
181	Batter	Type I Unconfined	33	H2	15	47	899	4199	2542	124	1206	643
181	Batter	Type I Unconfined	33	H3	15	45	570	2226	1376	17	469	260
174	Batter	Type I Unconfined	29	H1	10	54	513	6005	2583	27	1394	605
174	Batter	Type I Unconfined	29	H2	10	53	1006	5730	3351	179	1890	902
174	Batter	Type I Unconfined	29	H3	10	50	553	2299	1309	47	726	194
167	Batter	Type I Unconfined	7	H1	7b	102	946	10375	4758	91	3630	1411
167	Batter	Type I Unconfined	7	H2	10 ^a	99	751	6803	2117	95	1978	520
167	Batter	Type I Unconfined	7	H3	6 ^a	66	559	2723	1083	31	949	309
178	Batter	None	37	H1	10	53	330	8491	5563	40	2081	1136
178	Batter	None	37	H2	10	52	483	9625	6609	28	3505	2217
178	Batter	None	37	H3	10	50	464	3268	2160	60	761	493
244	Batter	None	20	H1	10	54	185	10809	4077	26	2759	1089
244	Batter	None	20	H2	10	51	592	7221	3792	41	2102	935
244	Batter	None	20	H3	10	49	973	5788	2293	147	1284	568

a. Hydrophones located offshore of pile in deeper water but still parallel to shore.
b. Pile 171 hydrophones deployed at slightly different depths before and after bubble curtain sleeve extension.

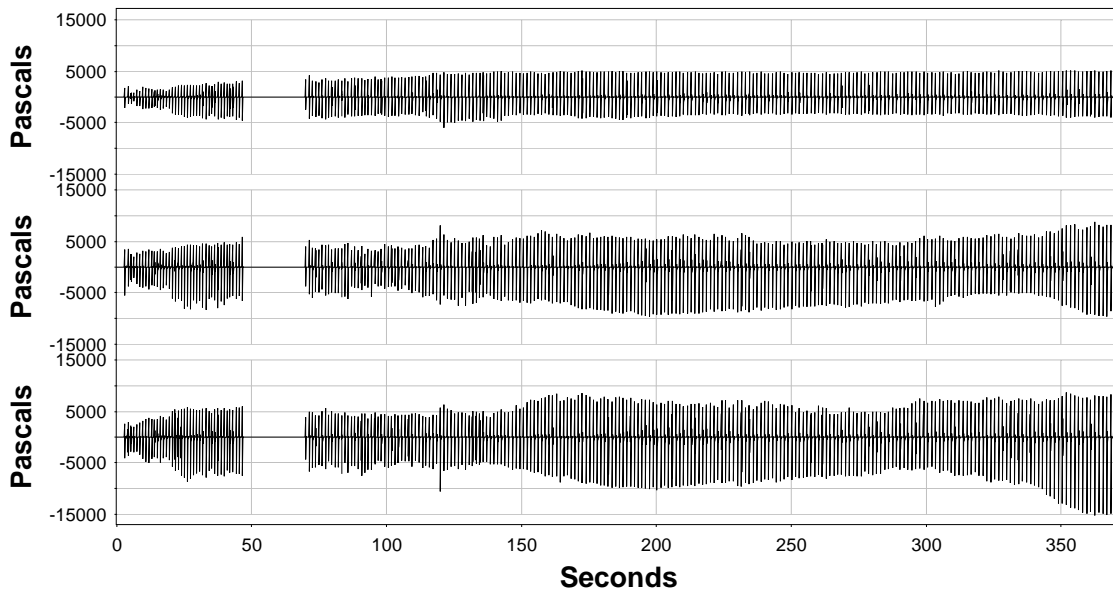

Figure 13. Sound-Pressure Levels (Pa) Measured for Plumb Pile 235 Driven in 4.5 ft of Water with the Bubble Curtain in Place. H1 (bottom plot), H2 (middle plot), and H3 (top plot) were approximately 64.7, 89.1, and 154.8 ft from the pile, respectively.

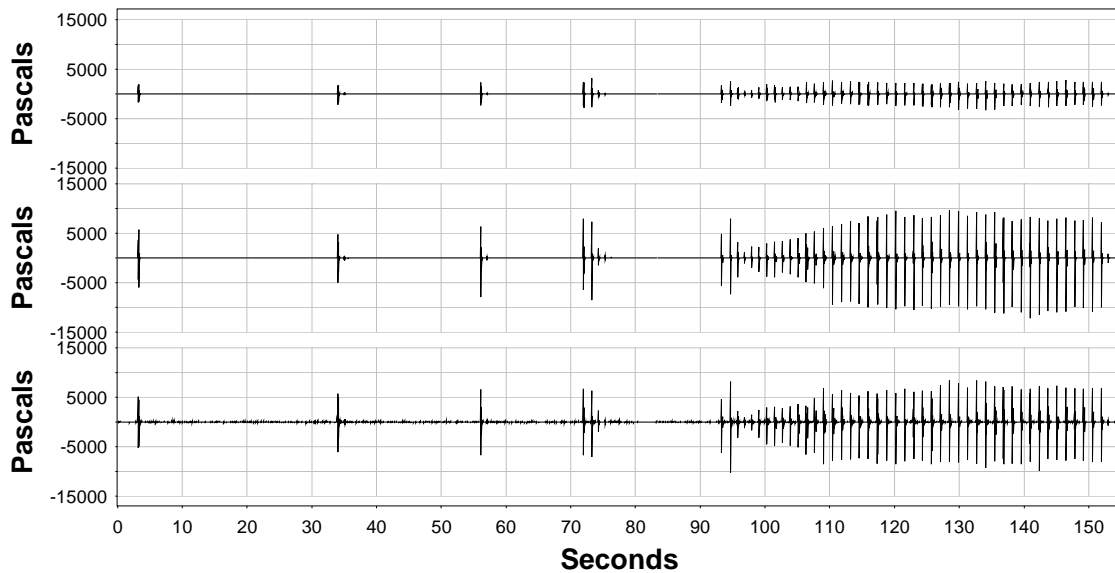

Figure 14. Sound-Pressure Levels (Pa) measured for batter pile 178 driven in 37 ft of water with no bubble curtain. H1 (bottom plot), H2 (middle plot), and H3 (top plot).

Batter Piles: Observed sound pressures were, in general, lower for batter piles than for plumb piles (Table 5). There are probably many factors that resulted in batter piles showing lower sound-pressure values, including lower hammer setting, more oblique entry into bottom substrate, and shallower penetration of substrate. Sound pressure varied from peak positive pressures of 10,809 Pa to peak negative pressures of -15,405 Pa. The median peak positive and peak negative values for all plumb pile impacts was 2,571 Pa and -2,685 Pa. The time sequence of sound-pressure levels for all piles is provided in Appendix A.

3.2.4 Impulsive Sound Energy Characteristics

The frequency content of an impulsive sound signal contains information critical to understanding potential impacts to fish and other animals. In general, fish hearing sensitivity peaks at lower frequencies, whereas higher frequencies are required for the rapid pressure rise time (time from zero or minimum signal to maximum signal) typical of impact sounds that can cause barotrauma (Hastings and Popper 2005). As sound mitigation devices, bubble curtains are intended to act on impulsive sound by 1) reducing the total energy (spectral density) in the impulse and 2) reducing the rise time by attenuating higher frequencies more than lower frequencies. The impact sound impulses for all piles were analyzed to determine their frequency content as follows.

Spectral densities (energy index per unit of frequency) for sound impulses were calculated using the procedure “Proc Spectra” in SAS. The spectral densities were calculated using the sum of the first 20 impact sound impulses for each pile, which permitted better frequency resolution of the spectral density of impact impulses. Plots of spectral densities computed for all piles and hydrophones are provided in Appendix E. Figure 15 shows plots of spectral density computed for each hydrophone at three plumb piles (172, 171, and 238), driven with a bubble curtain deployed. The spectral density data in the figures clearly show the high variability in the spectral characteristics of sound impulses among piles and monitoring locations. In general, sound levels are low with little energy at higher frequencies by the time the sound propagates to the most distant hydrophone (H3), located at approximately 60 m from the pile being monitored. The difference between the farthest hydrophone (H3) and the nearer hydrophones (H1, H2) shows that higher frequencies attenuated more rapidly with distance from the pile than did lower frequencies, which is as expected (Urick 1983). However, on occasion, the complexity of the sound field generated by pile driving becomes apparent when impact signals with higher energy are observed at longer-range hydrophones. This is illustrated by pile 172 in Figure 15, where the impact sound observed at hydrophone H2, located at approximately 20 m from the monitored pile, has a higher energy level than that at hydrophone H1, located at about 10 m from the monitored pile.

For this study, we do not have enough information to estimate sound energy, but were able to compute an index of sound energy (Pa^2/Hz over frequency range) and use it as a surrogate for spectral density in our presentation and discussion of results. We use a similar approach to express cumulative sound exposure (Pa^2 over time, an index of total energy). Indices for cumulative energy and spectral density for a single pile impact are shown in Figure 16 and 17 (compared with the first 20 impacts as shown in Figure 15). This is a means of comparing the energy intensity and rise time for single pile-driving impacts under a range of conditions; it is also a way to express the acoustic single impact “dose” received by a potential target organism, such as a fish. It should be noted, however, that in this study, the total energy that is needed to estimate acoustic dose cannot be estimated from the available data because acoustic particle velocities were not measured and free-field assumptions cannot be substantiated. Figure 16 shows plots of sound energy for plumb pile 255, driven in deeper water (33 ft) with a bubble curtain in place, whereas Figure 17 shows plots of sound energy for plumb pile 50N, driven in deeper water (40 ft) without a bubble curtain in place.

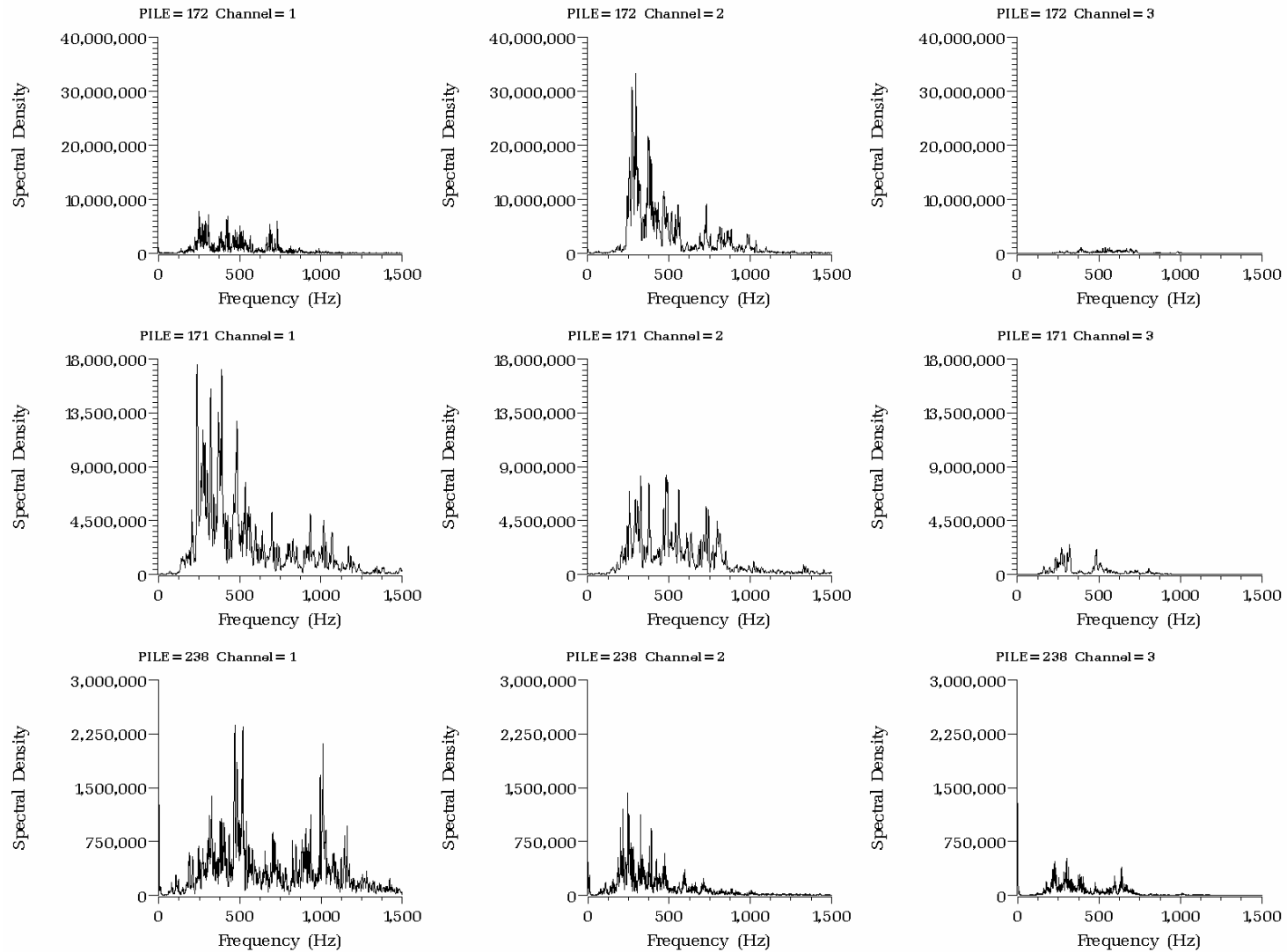

Figure 15. Example of Plots of Spectral Density Indices (Pa²/Hz) versus Frequency (Hz) at Each Hydrophone (H1, H2, H3 from left to right) for First 20 Impacts on Plumb Piles 172, 171, and 238

Figure 16a

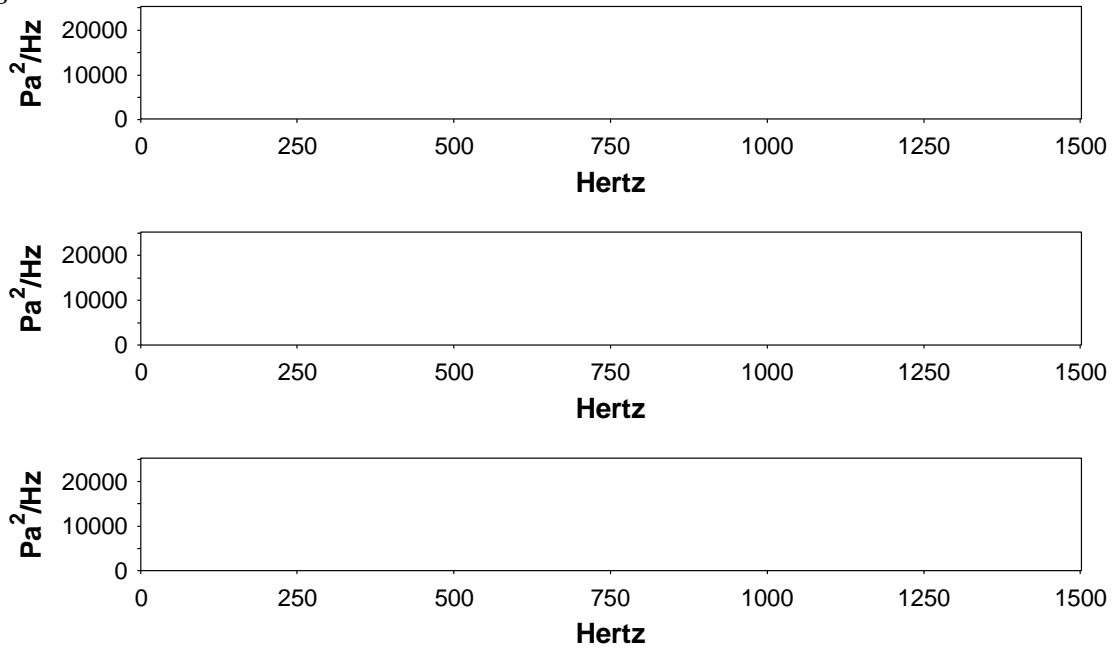

Figure 16b

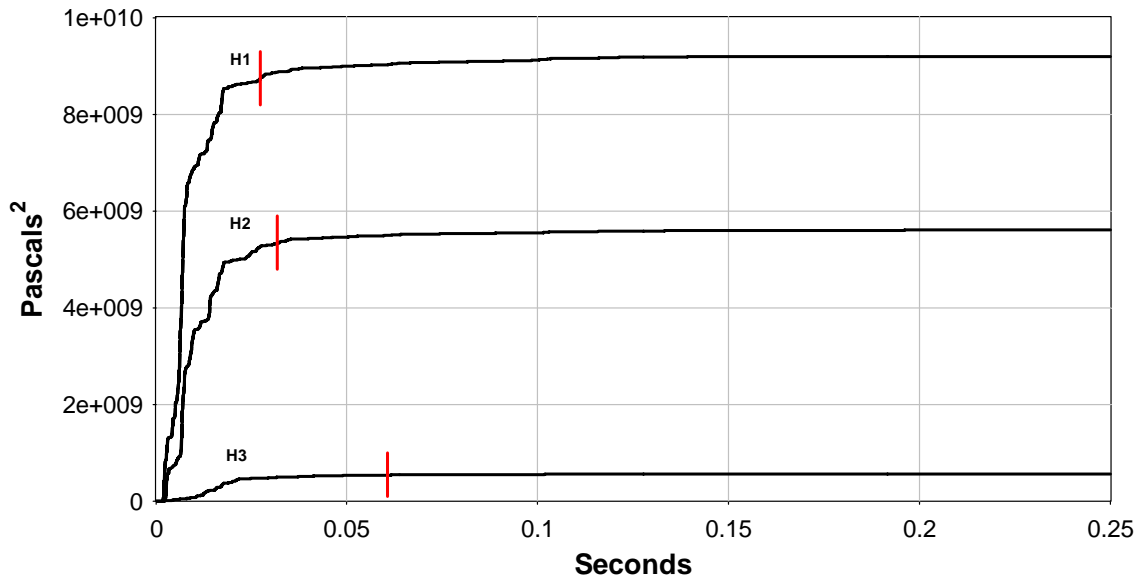

Figure 16. Power Spectral Density Indices (Figure 16a: H1 top plot, H2 middle plot, H3 bottom plot) and Cumulative Sound Exposure Over Time (Figure 16b) for a Single Pile-Driving Impact Measured at Plumb Pile 255, Driven in 33 ft of Water with Bubble Curtain. On the cumulative sound plot, the vertical lines represent the point in time when the summed squared sound pressures of the waveform total 95% of the sound energy.

Figure 17a

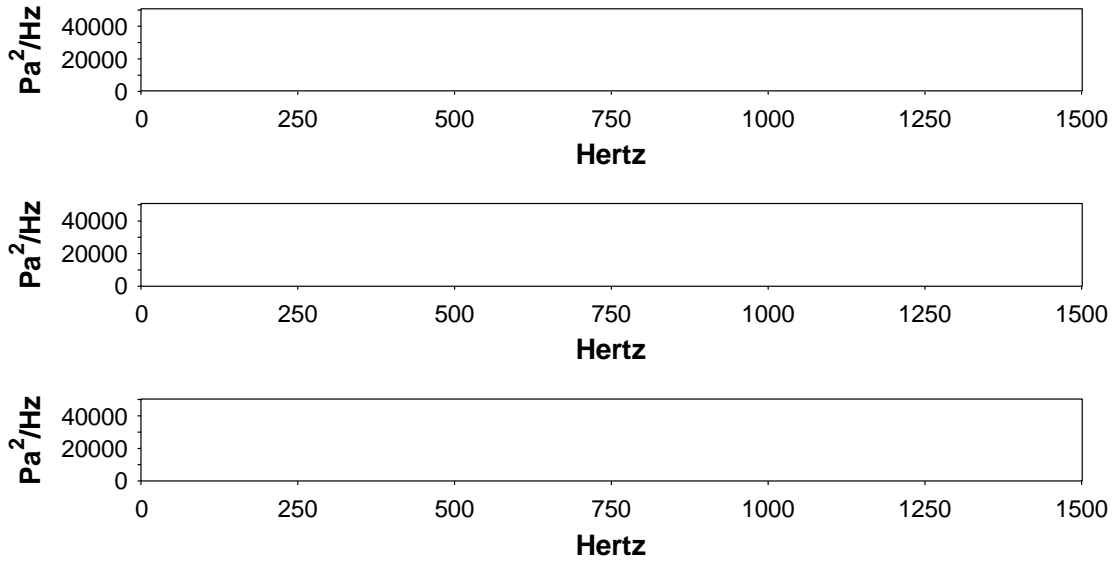

Figure 17b

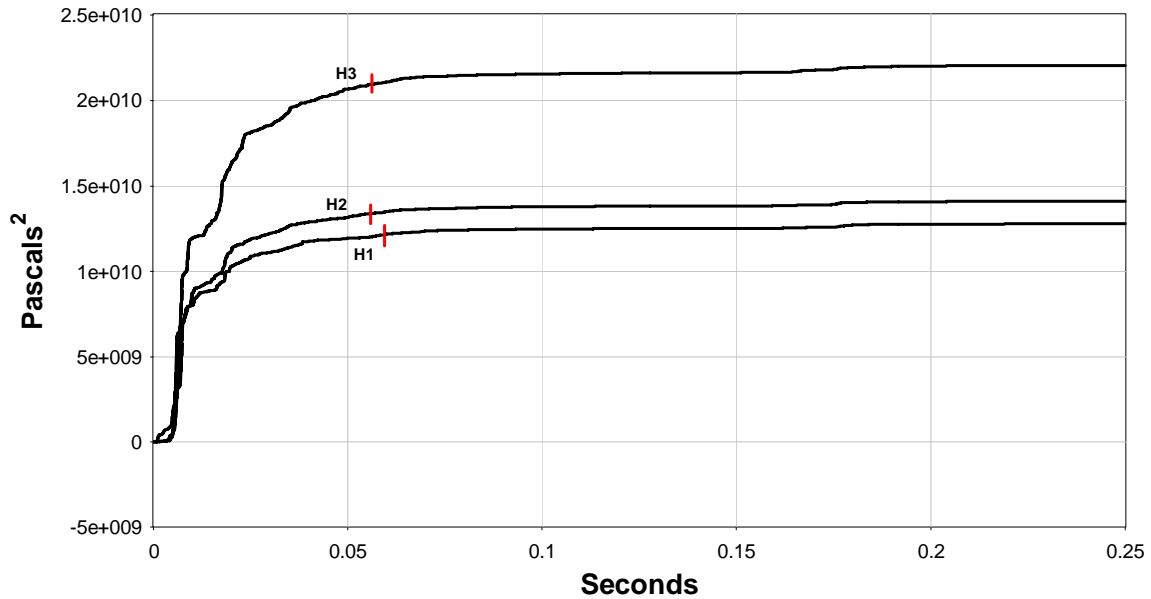

Figure 17. Power Spectral Density Indices (Figure 17a: H1 top plot, H2 middle plot, H3 bottom plot) and Cumulative Sound Exposure Over Time (Figure 17b) for a Single Pile-Driving Impact Measured at Plumb Pile 50N, Driven in 40 ft of Water Without Bubble Curtain. On the cumulative sound plot, the vertical lines represent the point in time when the summed squared sound pressures of the waveform total 95% of the sound energy.

Overall, the rise time and energy at the hydrophones were higher for the plumb pile driven without a bubble curtain than the pile driven with a bubble curtain in deeper water. However, because of lack of experimental control, it was not possible to determine whether the lower energy and longer rise times for the pile driven with a bubble curtain was because the bubble curtain was effective, or whether the observed differences were due to other factors.

Similarly, Figure 18 and 19 show cumulative sound exposure and spectral density indices for two plumb piles driven in shallower water: pile 238, driven in 7 ft of water with the bubble curtain in place, and pile 240, driven in 9 ft of water without a bubble curtain. In the case of these two piles, the differences between energy and rise time are mixed depending on distance from the pile. For the hydrophone closest to the pile (H1), the most energy and highest rise time were observed for the pile driven without a bubble curtain. However, the opposite was observed for the H2 hydrophones located approximately 20 m from the piles, and there was little difference in either rise time or energy for the H3 hydrophone located approximately 60 m from the monitored piles. Similar results are shown in the spectral density plots for these piles. As is the case for the piles driven in deeper water, it is not possible to conclude from these data whether the confined bubble curtain was effective.

3.3 Comparison of Measured and Threshold Sound Pressures

Sound-pressure levels, both peak and RMS, consistently exceeded the threshold levels set for protection of marine life, which for this pile-driving project are 180 dB/ μ Pa (1000 Pa_{PEAK}) and 150 dB/ μ Pa (31.6 Pa_{RMS}), respectively (Table 6). Appendix C contains figures for each monitored pile that show the peak negative and positive pressures and RMS pressure for each impact at each of the three hydrophones in the array. The data acquisition period for each pile was divided into 3 equal sample segments based on the total number of impacts per pile-driving event. There is a great deal of variability in peak sound pressures during the driving of any given pile for each of the hydrophones and among hydrophones in the array. This variability with time for each pile is readily apparent by visual inspection of the impact impulse peak data shown in the figures of Appendix A. The few peak and RMS pressure observations that did not exceed criteria were found near the beginning of a pile-driving event, probably when the pile was being driven through more loosely aggregated sediment and when the imbedded pile length was short. The distribution statistics for each pile are given in Appendix B; plots of distributions of peak and RMS pressure observations are provided in Appendix D.

3.4 Assessment of Bubble Curtain Effectiveness

The frequency content of an impulsive sound-signal contains information critical to understanding potential impacts to fish and other animals. In general, fish hearing sensitivity peaks at lower frequencies, whereas sounds that cause barotrauma are typically higher frequencies and associated rapid pressure rise times (Hastings and Popper 2005). An effective bubble curtain can mitigate the impact of these sounds on fish and other animals in two important ways: 1) by reducing the energy in the impulse, and 2) by reducing rise times by attenuating higher frequencies more than lower frequencies.

Neither the scope of work nor the design of this study permitted a comprehensive assessment of the effectiveness of the bubble curtain and containment device deployed by the pile-driving contractor. Assessment of bubble curtain effectiveness would require curtain on/curtain off cycles for individual piles, and controls for other variables that could affect the characteristics of sound impulses. In addition, because of the effects of attenuation, spreading, and other factors on a propagating sound impulse, comparisons of sound impulses during curtain on/curtain off need to be made using the same hydrophones at known locations relative to the pile. Information regarding the original bubble curtain specifications for this project is found in Appendix F.

Figure 18a

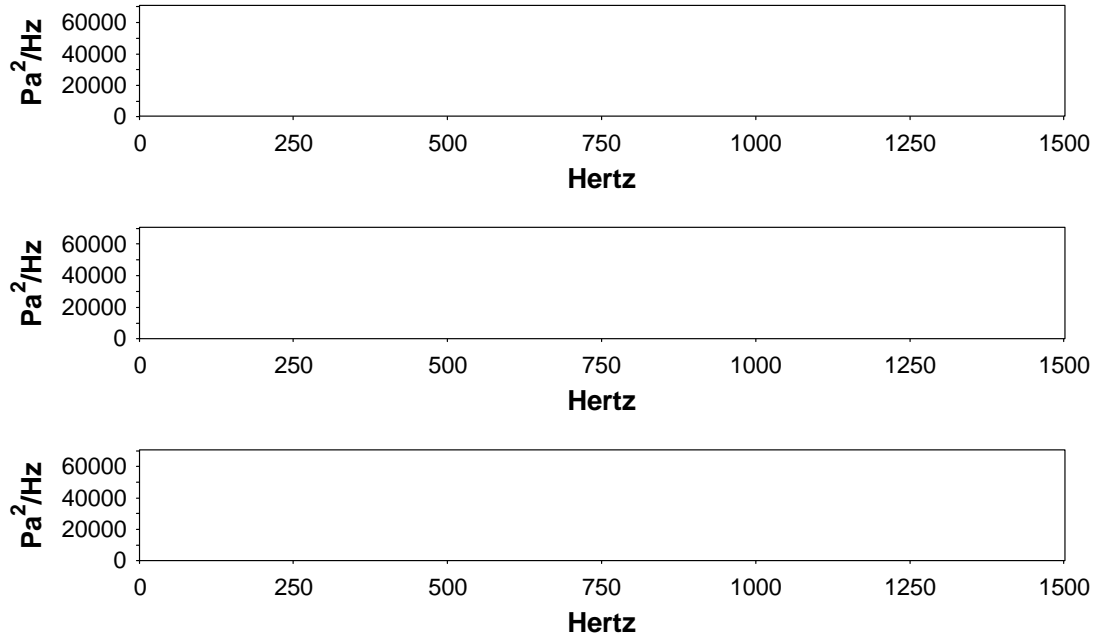

Figure 18b

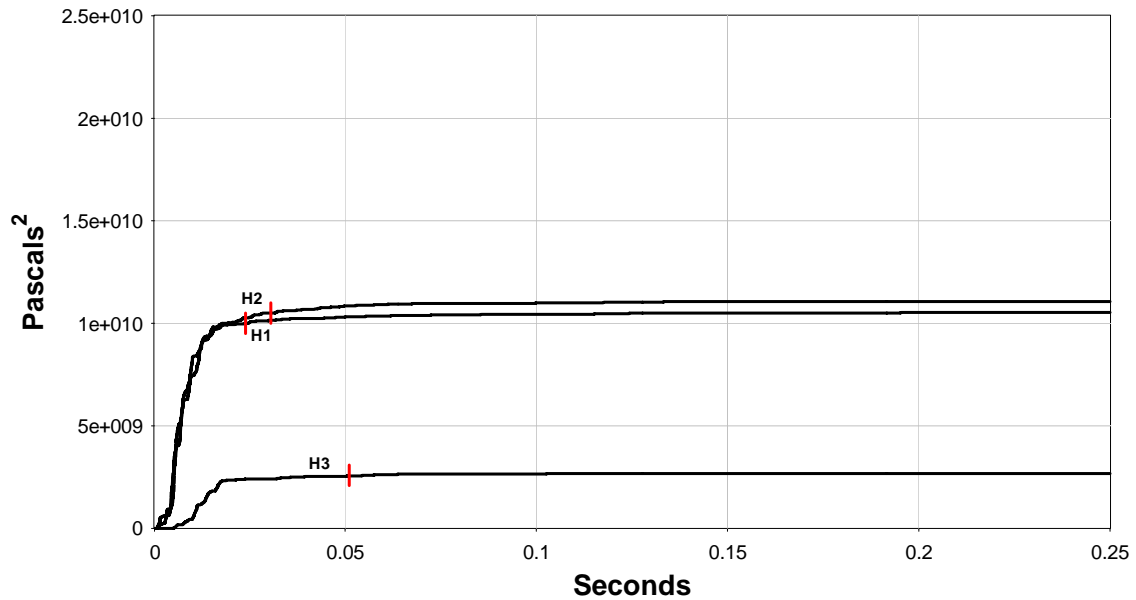

Figure 18. Power Spectral Density Indices (Figure 18a: H1 top plot, H2 middle plot, H3 bottom plot) and Cumulative Sound Exposure Over Time (Figure 18b) for a Single Pile-Driving Impact Measured at Plumb Pile 238, Driven in 7 ft of Water with Bubble Curtain. On the cumulative sound plot, the vertical lines represent the point in time when the summed squared sound pressures of the waveform total 95% of the sound energy.

Figure 19a

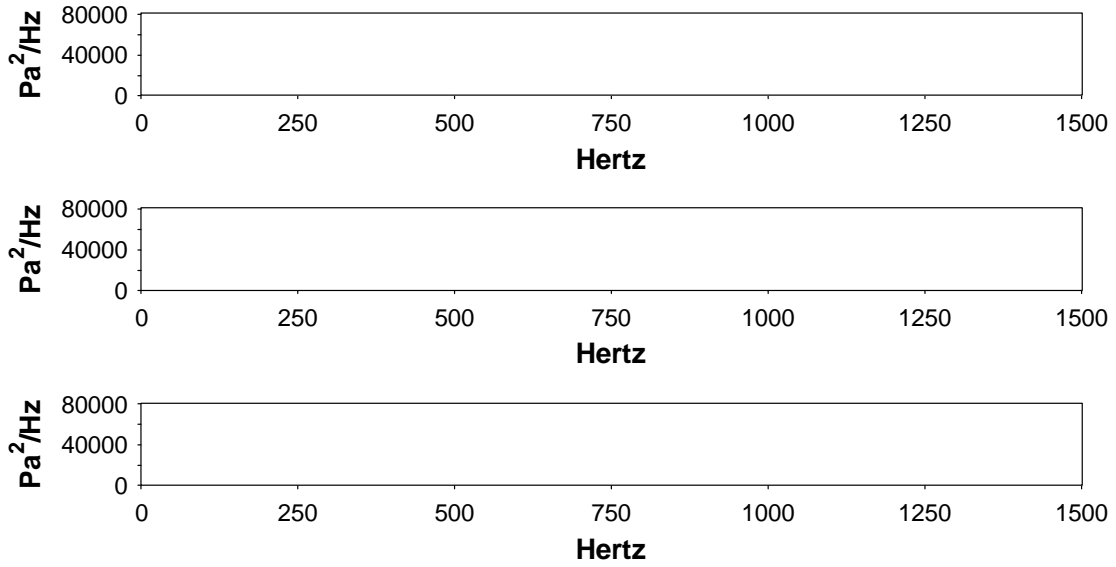

Figure 19b

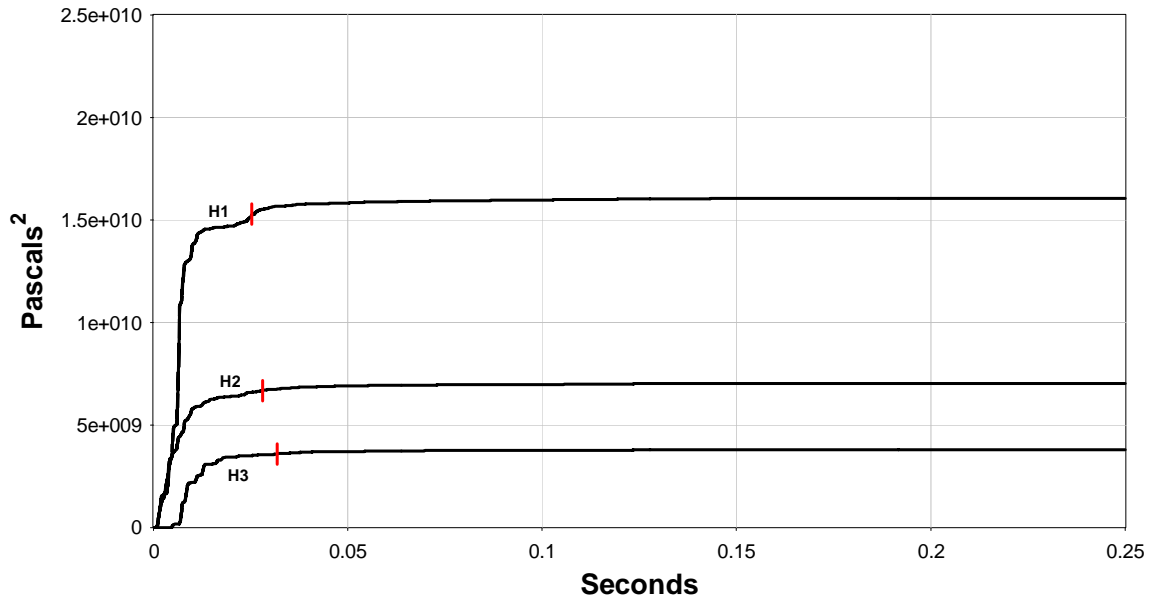

Figure 19. Power Spectral Density Indices (Figure 19a: H1 top plot, H2 middle plot, H3 bottom plot) and Cumulative Sound Exposure Over Time (Figure 19b) for a Single Pile-Driving Impact Measured at Plumb Pile 240, Driven in 9 ft of Water Without Bubble Curtain. On the cumulative sound plot, the vertical lines represent the point in time when the summed squared sound pressures of the waveform total 95% of the sound energy.

Table 6. Percentage of Impacts at each Hydrophone that Exceeded Threshold Values for Protection of Marine Life

Pile ID	Pile Type	Bubble Curtain	Hydrophone H1			Hydrophone H2			Hydrophone H3		
			Number of Impacts	Threshold >1000 Pa _{PEAK} (%)	Threshold >31.6 Pa _{RMS} (%)	Number of Impacts	Threshold >1000 Pa _{PEAK} (%)	Threshold >31.6 Pa _{RMS} (%)	Number of Impacts	Threshold >1000 Pa _{PEAK} (%)	Threshold >31.6 Pa _{RMS} (%)
121N	Plumb	Type II Confined	317	100	100	299	100	100	294	99.7	99.7
52N	Plumb	Type II Confined	107	100	100	107	100	100	107	100	100
118N	Plumb	Type II Confined	203	99.5	100	202	100	100	200	100	100
255	Plumb	Type II Confined	134	100	100	234	100	100	234	100	100
249	Plumb	Type II Confined	506	100	100	506	100	100	505	98.4	100
252	Plumb	Type II Confined	256	100	100	256	100	100	253	98.7	100
172	Plumb	Type II Confined	194	99.0	100	194	100	100	188	98.4	100
171	Plumb	Type II Confined	405	100	100	405	100	100	397	98.2	100
238	Plumb	Type II Confined	218	99.5	100	216	98.6	100	204	98	100
235	Plumb	Type II Confined	257	100	100	257	100	100	257	99.6	100
237	Plumb	Type II Confined	368	100	100	368	100	100	366	97.8	100
50N	Plumb	None	334	99.7	99.7	334	100	100	335	99.7	100
120N	Plumb	None	152	100	100	152	100	100	151	100	100
240	Plumb	None	297	100	100	298	99.3	100	296	99.3	100
182	Batter	Type I Unconfined	46	100	100	46	100	100	46	93.5	100
177	Batter	Type I Unconfined	28	92.9	96.4	26	96.2	100	21	61.9	100
174	Batter	Type I Unconfined	54	96.3	98.1	53	100	100	50	86	100
181	Batter	Type I Unconfined	46	98.0	98.0	47	97.9	100	45	82.2	97.8
167	Batter	Type I Unconfined	102	99.0	100	99	99.0	100	66	68.2	98.5
178	Batter	None	53	96.2	100	52	98.1	98.1	50	96	100
244	Batter	None	54	92.6	98.1	51	98.0	100	49	98	100

4.0 Discussion

Impulsive sound levels generated by pile driving during construction of a work trestle at the eastern approach of the Hood Canal Bridge were measured in September, October, and November 2004. As designed, the hydroacoustic data acquisition accomplished the objectives of measuring sound-pressure levels under a variety of pile type, water depth, and sound mitigation conditions. Variability within and between pile sound-impulse data sets for pressure metrics was a key feature of the data collected during this research effort.

The propagation of sound in shallow water is complex and does not usually follow that expected for free-field conditions. In free-field conditions, simplifying plane wave assumptions could be made and pressure would be expected to decrease primarily as a result of geometric spreading (for low frequencies, not considering scattering) as $20 \log_{10} m$ (the square of distance from the sound source), where “m” is the range from the sound source in meters. Therefore, the peak pressures observed at H3 would be expected to be $15.6 \text{ dB}_{\text{PEAK}}//1 \text{ } \mu\text{Pa}$, or six times lower than those observed at H1. In the range of water depths and other monitoring conditions for the Hood Canal Bridge east approach site, the actual observed peak pressures at H3 were only two to three times lower than H1 at most pilings (Table 5). Sound attenuation in shallow water was found to be log-linear rather than geometric by Nedwell (2003) at $0.15 \text{ dB}_{\text{PEAK}}//\mu\text{Pa}$ per m. Hood Canal Bridge study data were fit to a log-linear model of transmission loss by log-transforming peak positive pressure in Pa to $\text{dB}_{\text{PEAK}}//\mu\text{Pa}$ and assuming a distance of 50 m between H1 and H3. Summary statistics for plumb and batter piles, both individually and combined, are provided in Table 7. These data show that the loss rates were not significantly different for the two types of piles. The average rate of transmission loss from H1 to H3 of $0.145 \text{ dB}_{\text{PEAK}}//\mu\text{Pa}$ per m for all piles was comparable with Nedwell’s (2003) estimate, which is notable because all Hood Canal measurements were conducted within 100 m of the source whereas Nedwell’s transmission loss rate was developed from fewer samples (9) collected approximately 60 m to 230 m from the source.

Table 7. Summary Statistics for Transmission Loss Rates Between Hydrophones 1 and 3

Summary Statistic	H1-H3 Transmission Loss ($\text{dB}_{\text{PEAK}}//\mu\text{Pa}$ per m)		
	Plumb Piles	Batter Piles	All Piles
Mean	0.132	0.171	0.145
95% Confidence Interval of Mean	0.027	0.031	0.021
Median	0.138	0.167	0.151
Standard Deviation	0.088	0.072	0.085
Standard Error	0.014	0.016	0.011
Maximum	0.277	0.401	0.401
Minimum	-0.131	0.048	-0.131
Number of Samples	42	21	63

Piles were generally driven with a bubble curtain in place as required by WSDOT to mitigate sound pressure. Our data indicated that the bubble curtain sound-mitigation device as deployed during the hydroacoustic study period was not effective at reducing RMS and peak positive sound pressures below the threshold values currently prescribed by resource agencies for protection of marine life. Both RMS peak positive protective thresholds were exceeded most of the time at all hydrophone locations for all piles. In general, lower levels of sound were observed in some cases for piles driven with a bubble curtain in place. However, many factors (e.g., substrate composition, hammer operation, bubble curtain

operational experience) influence the high variability observed in sound production both over the course of driving an individual pile and between piles, such that it was not possible to quantify the effectiveness of the bubble curtain as a single factor. There were additional difficulties with the monitoring related to the Contractors activities. For example, the study design and approach assumed that the bubble curtain would be deployed and operated per specifications, yet September 2004 observations of sound generated by pile driving with the bubble curtain in place found that the device was ineffective, because it was determined that the device was not meeting design specifications during that time. Although the device was later modified, it was still difficult to assess by field observations alone whether all aspects of the mitigation device were deployed and operated correctly. It was difficult to observe whether the bubble curtain confinement sleeve was in contact with the substrate, whereas it was relatively simple to observe whether the sleeve extended above the water surface. In addition, measurements of sound are, at best, an indirect means to assess the state of deployment and function of a mitigation device.

Another important consideration relative to evaluation of impulsive sound energy and potential effects on fish, birds, or other marine life, is that sound-pressure measurements alone do not completely characterize the sound field generated by pile driving. At short ranges from a sound source, much of the energy in the field is carried in particle displacement, whereas at longer ranges from the source, almost all of the sound energy is in the form of pressure. Therefore, measurements of acoustic particle velocity would be needed in addition to pressure to fully describe the sound field at the ranges relevant to pile driving and the potential effects on biota. Complete description of the sound field is necessary because the inner ear of many species of fish and, in particular, protected salmonid species, responds primarily to particle motion, not pressure. Therefore, although pressure is important for evaluation of potential barotrauma injury, particle velocity is also required to fully assess the potential for hearing system impact.

The quantitative evaluation of the performance of a sound mitigation device and identification of design and operation alternatives that might improve effectiveness require a substantially different study design than that for monitoring for compliance with threshold levels. The dynamics of typical pile driving make the design of studies to quantitatively and systematically evaluate sound mitigation measures very difficult. Yet improvements to the design and function of sound mitigation devices, both in terms of sound mitigation and integration into pile-driving construction activities, will not be possible without both measures of acoustic performance and observations that quantitatively document the performance of the device. The primary study design difficulty in evaluating the effectiveness of sound mitigation measures used in pile driving is that mitigation device on/off designs do not seem well suited to pile driving. Pile-driving conditions are continually changing: the various depths of penetration of the pile, the differences in substrate with depth, and changes in hammer operations or other aspects of the pile-driving process during the course of driving a pile. The prospect for bias is evident: if “mitigation on” periods are early during pile driving and “mitigation off” later during pile driving, then the effectiveness of mitigation could likely be overestimated or vice-versa. Most important is that the primary challenge for the evaluation of sound mitigation device effectiveness is not in the design of a study that would meet statistical criteria, but in the implementation of a design in which the experimental requirements could impose time-consuming and costly constraints on normal construction activities. A benefit of studies designed to assess mitigation device effectiveness is that adequate data to satisfy compliance monitoring objectives would be available in a mitigation device evaluation data set.

5.0 Conclusions

The underwater sound pressure levels observed during this study lead to the following conclusions:

- The duration of an impact event or impulse was less than 1 sec; the median for plumb and batter piles was 0.0389 sec and 0.0581 sec, respectively.
- During pile driving, there were 7 to 8 impulses per second. The range of the number of impulses per pile driven was 107 to 505 for plumb piles and 21 to 102 for batter piles.
- The peak positive pressure values for all plumb pile impacts ranged from 177 Pa to 15,525 Pa, averaging 6,376 Pa; RMS pressure values for all plumb pile impacts ranged from 23 Pa to 10,746 Pa, averaging 1,957 Pa. The peak positive pressure values for all batter pile impacts ranged from 185 Pa to 10,809 Pa, averaging 3,125 Pa; RMS pressure values for all batter pile impacts ranged from 17 Pa to 3,630 Pa, averaging 816 Pa.
- There was a general decrease in sound-pressure levels with increased distance of monitoring hydrophones from the pile being driven.
- The sound pressure and spectral density (energy index per unit of frequency) data for sound impulses were highly variable among piles and monitoring locations. Many factors contribute to variability, including but not limited to pile type, wetted length of pile, substrate surface characteristics, changes in substrate with depth, pile-driving hammer settings and operation, and bubble curtain operation.
- Sound-pressure levels, both peak and RMS, consistently exceeded the threshold levels set for protection of marine life, which for this pile-driving project were 180 dB/ μ Pa (1000 Pa_{PEAK}) and 150 dB/ μ Pa (31.6 Pa_{RMS}), respectively.

The following suggestions are based on the study conclusions:

- Data collected as part of this program may be useful in a separate study to better understand the biological “effect zone” for the sound generated by pile driving.
- During future hydroacoustic studies, measurement of acoustic particle velocity in addition to pressure would more fully describe the sound field at the ranges relevant to pile driving and potential effects on biota.
- Future monitoring efforts should consider assessing the effectiveness of pile driving sound mitigation devices such as bubble curtains using an experiment specifically designed to address that mitigation device.

6.0 References

Nedwell, J., A. Turnpenny, J. Langworthy, and B. Edwards. 2003. *Measurements of underwater noise during piling at the Red Funnel Terminal, Southampton, and observations of its effect on caged fish.* Report prepared for Red Funnel by Subacoustech Ltd. Subacoustech Ltd. report reference: 558 R 0207.

Urick, R.J. 1983. *Principles of Underwater Sound.* McGraw-Hill. New York, New York.

APPENDIX A

Plots of Sound-Pressure Levels Over Time for Each Pile-Driving Event

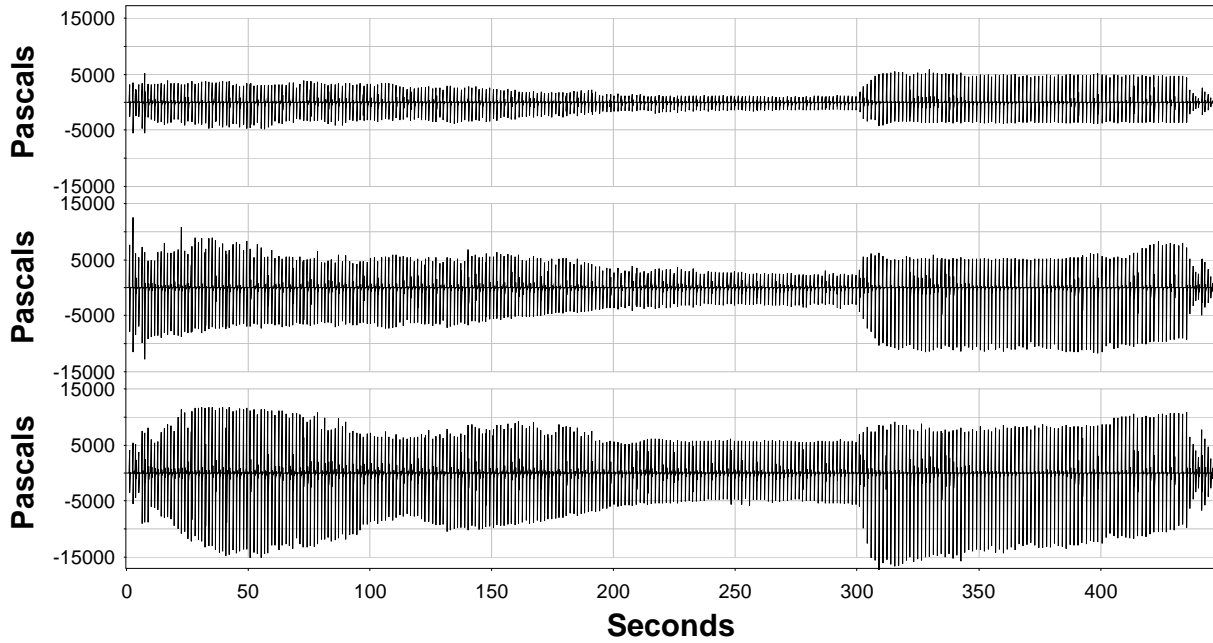

Figure A.1. Sound-Pressure Levels Measured by Hydrophones H1 (bottom), H2 (middle), and H3 (top) at Plumb Pile 121N Driven in 42 ft of Water with Bubble Curtain in Place

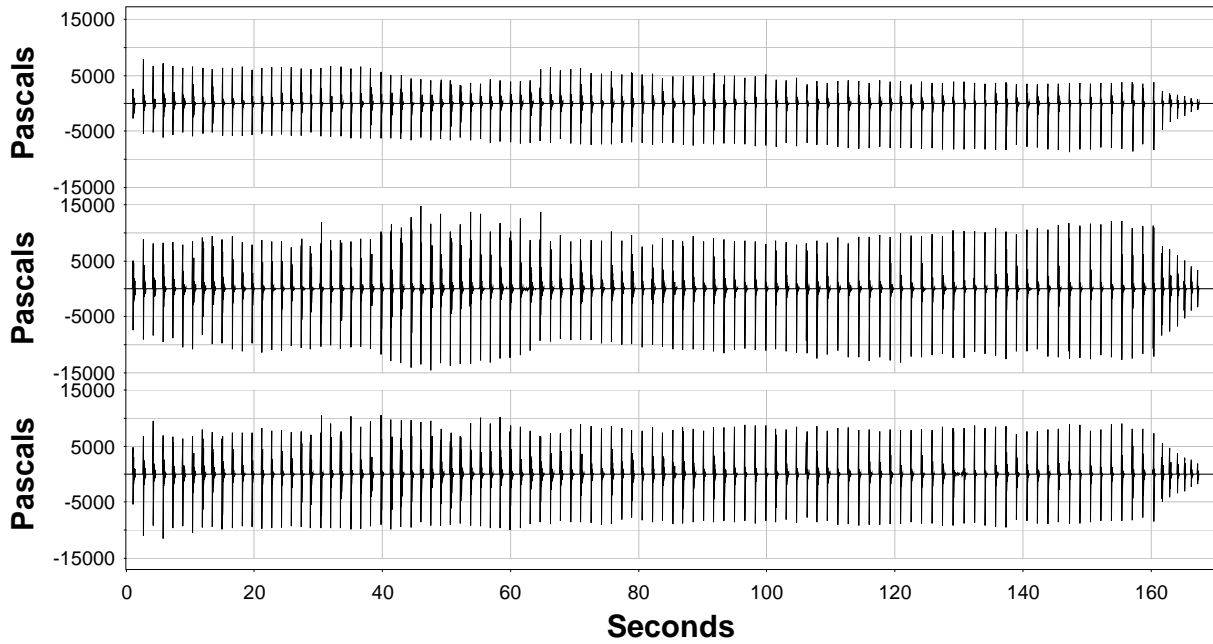

Figure A.2. Sound-Pressure Levels Measured by Hydrophones H1 (bottom), H2 (middle), and H3 (top) at Plumb Pile 52N Driven in 40 ft of Water with Bubble Curtain in Place

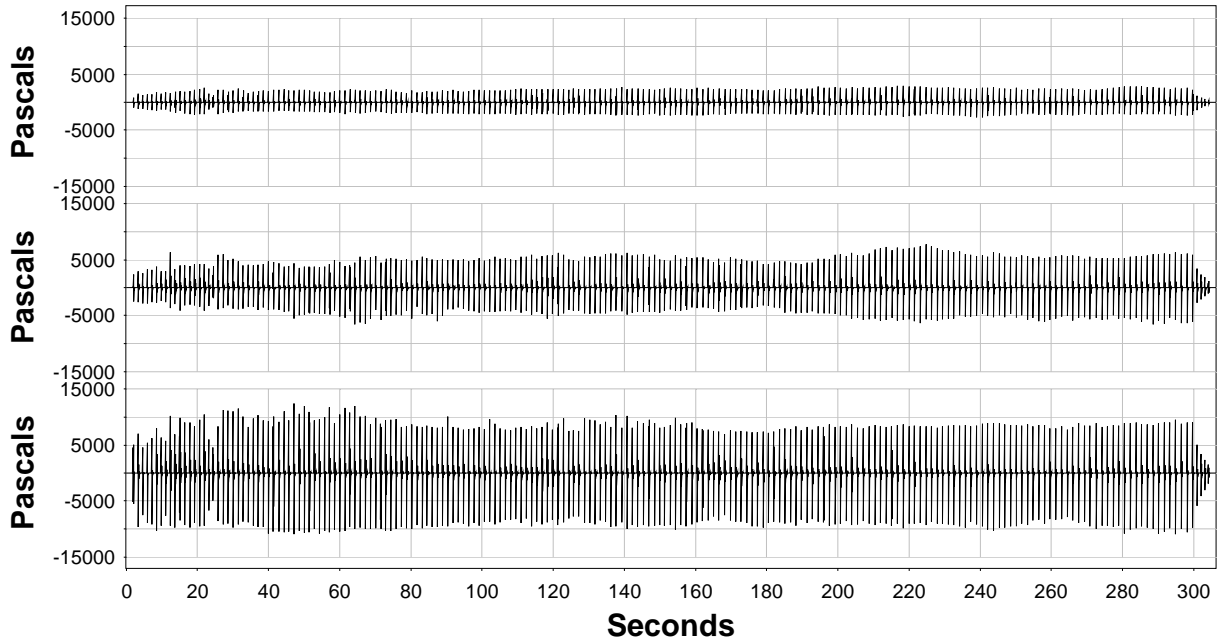

Figure A.3. Sound-Pressure Levels (Pa) Measured for Plumb Pile 118N Driven in 39 ft of Water with the Bubble Curtain in Place.

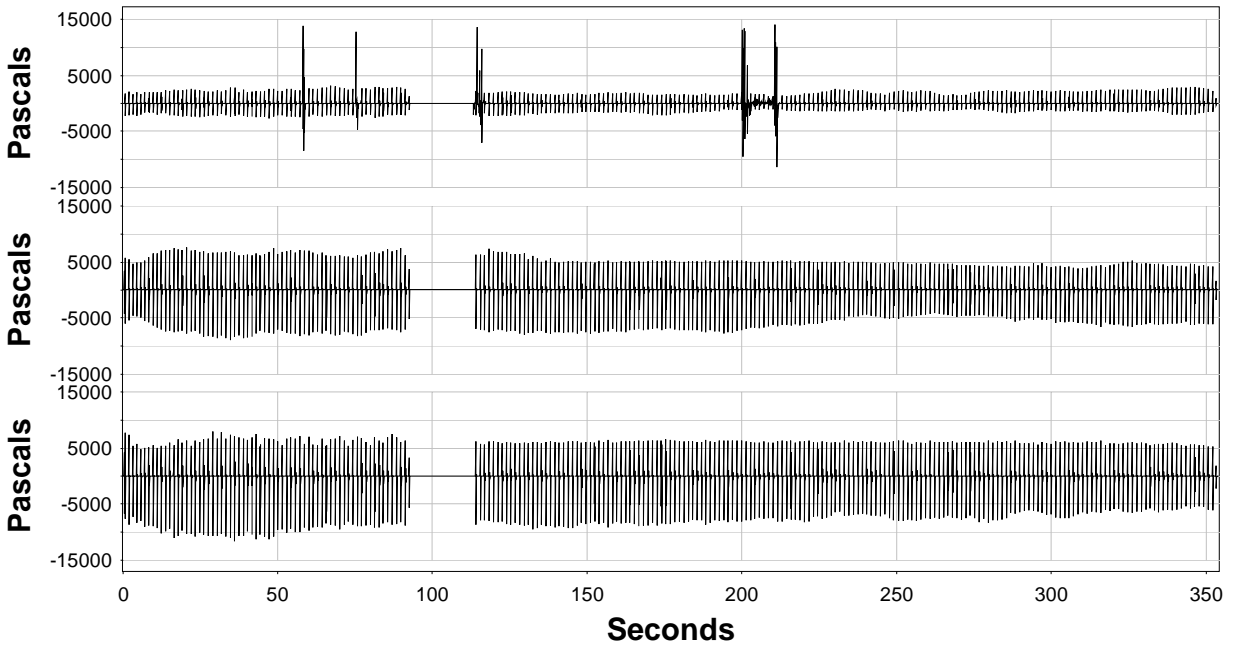

Figure A.4. Sound-Pressure Levels (Pa) Measured for Plumb Pile 255 Driven in 33 ft of Water with the Bubble Curtain in Place.

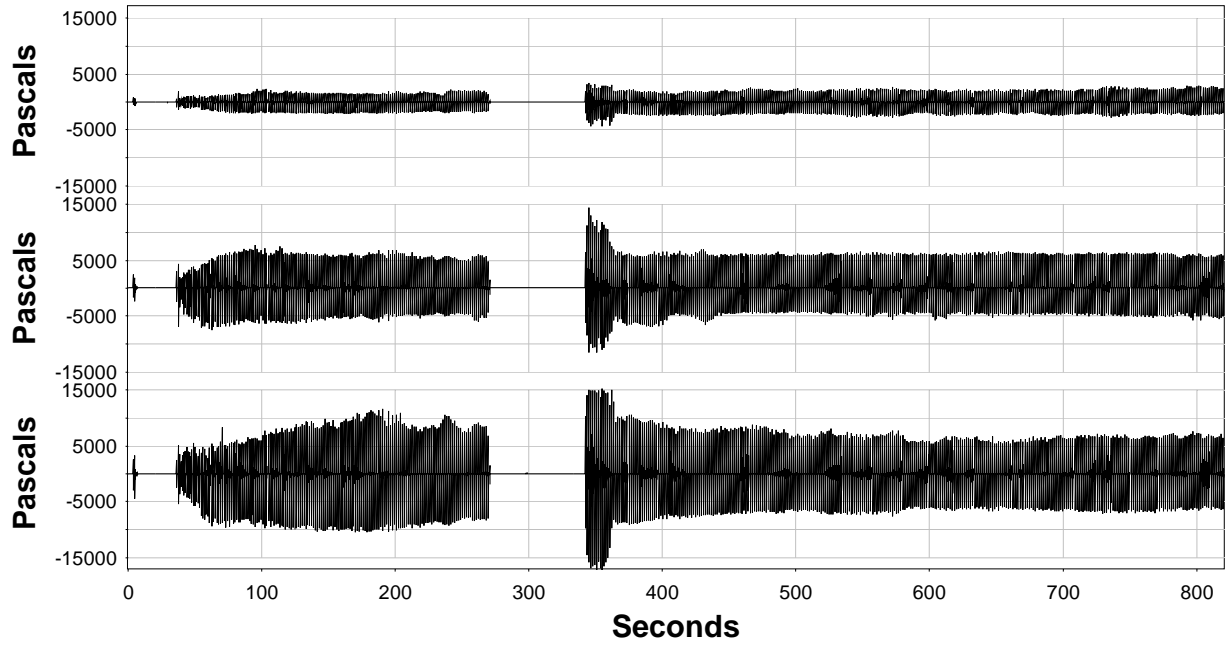

Figure A.5. Sound-Pressure Levels (Pa) Measured for Plumb Pile 249 Driven in 32 ft of Water with the Bubble Curtain in Place.

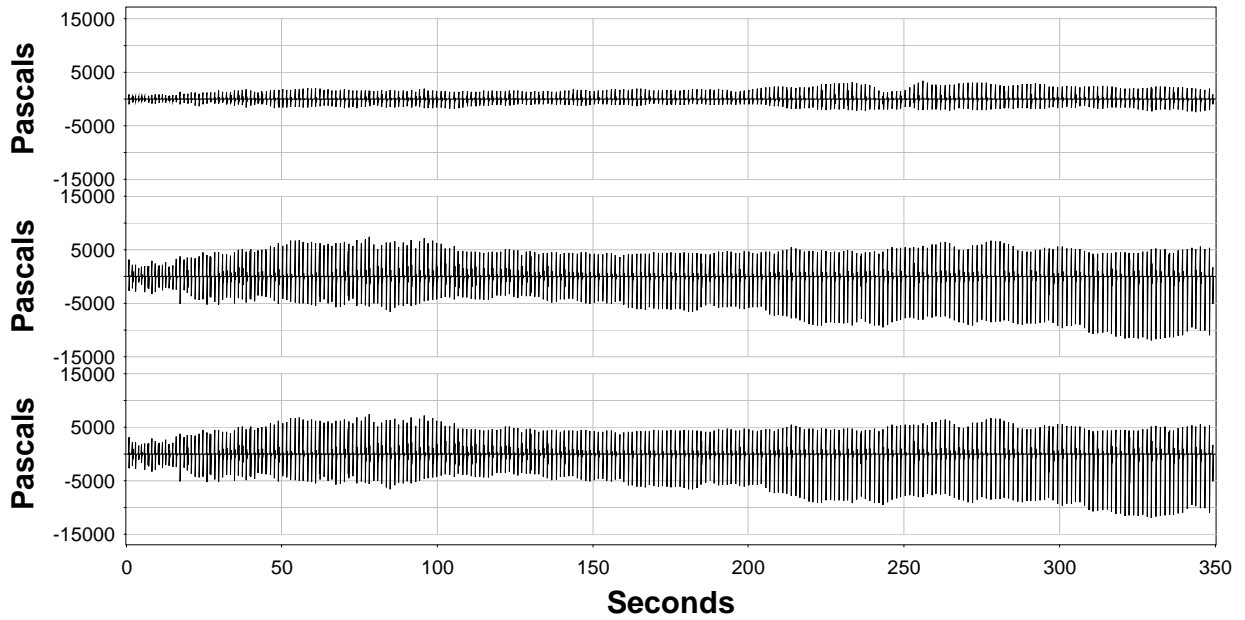

Figure A.6. Sound-Pressure Levels (Pa) Measured for Plumb Pile 252 Driven in 31 ft of Water with the Bubble Curtain in Place.

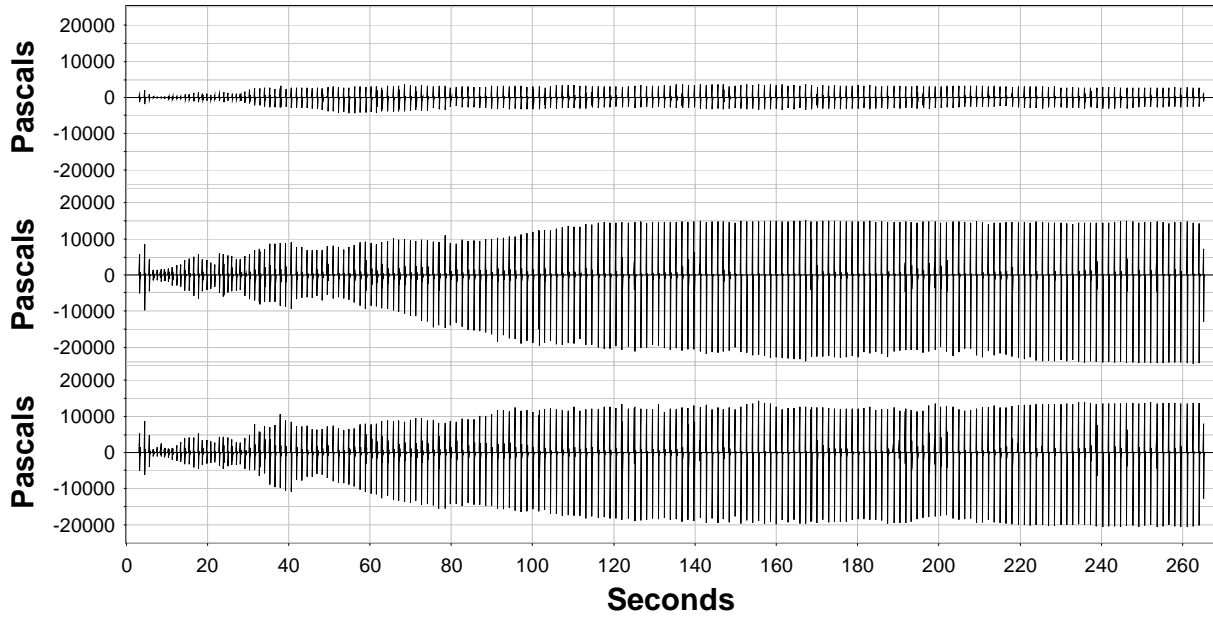

Figure A.7. Sound-Pressure Levels (Pa) Measured for Plumb Pile 172 Driven in 20 ft of Water with the Bubble Curtain in Place.

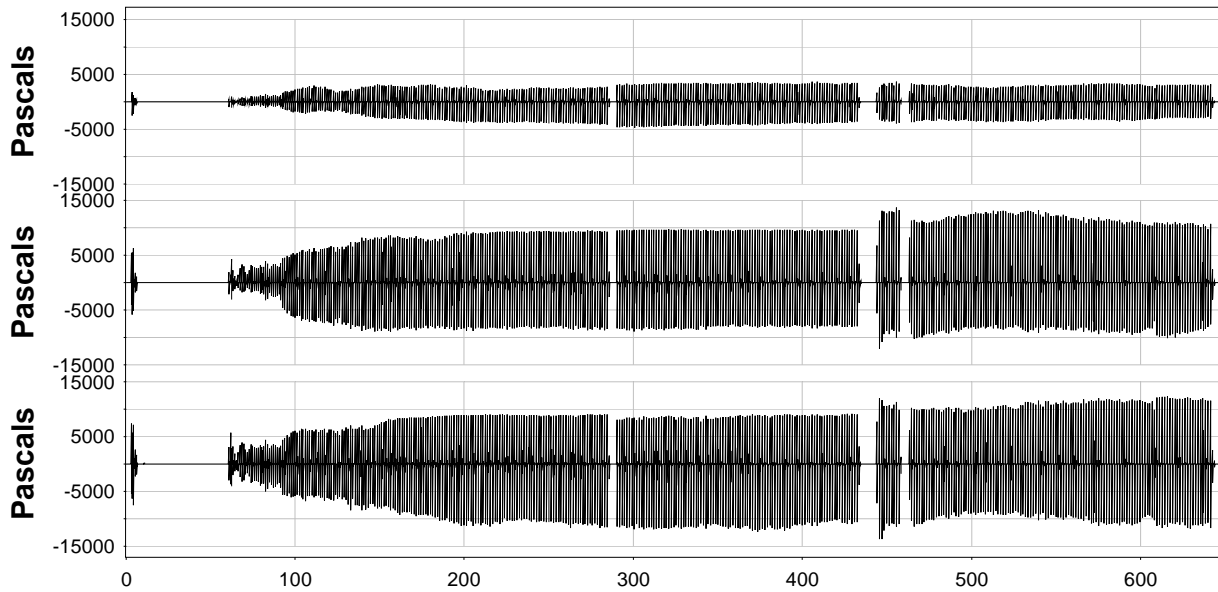

Figure A.8. Sound-Pressure Levels (Pa) Measured for Plumb Pile 171 Driven in 18 ft of Water with the Bubble Curtain in Place.

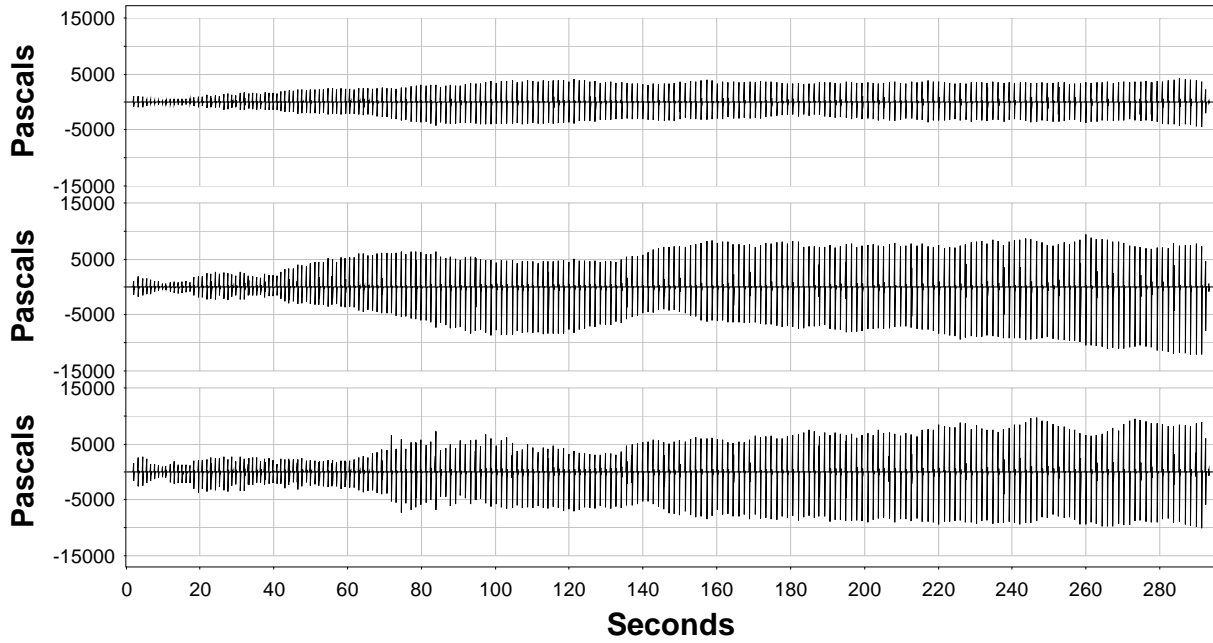

Figure A.9. Sound-Pressure Levels (Pa) Measured for Plumb Pile 238 Driven in 7 ft of Water with the Bubble Curtain in Place.

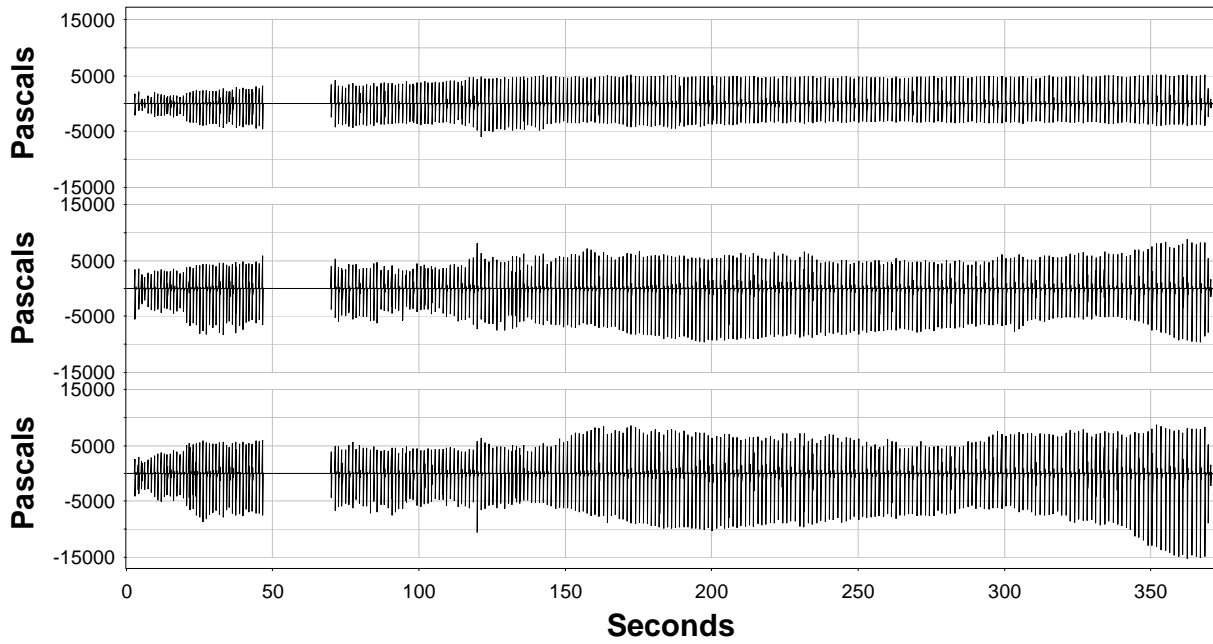

Figure A.10. Sound-Pressure Levels (Pa) Measured for Plumb Pile 235 Driven in 4.5 ft of Water with the Bubble Curtain in Place.

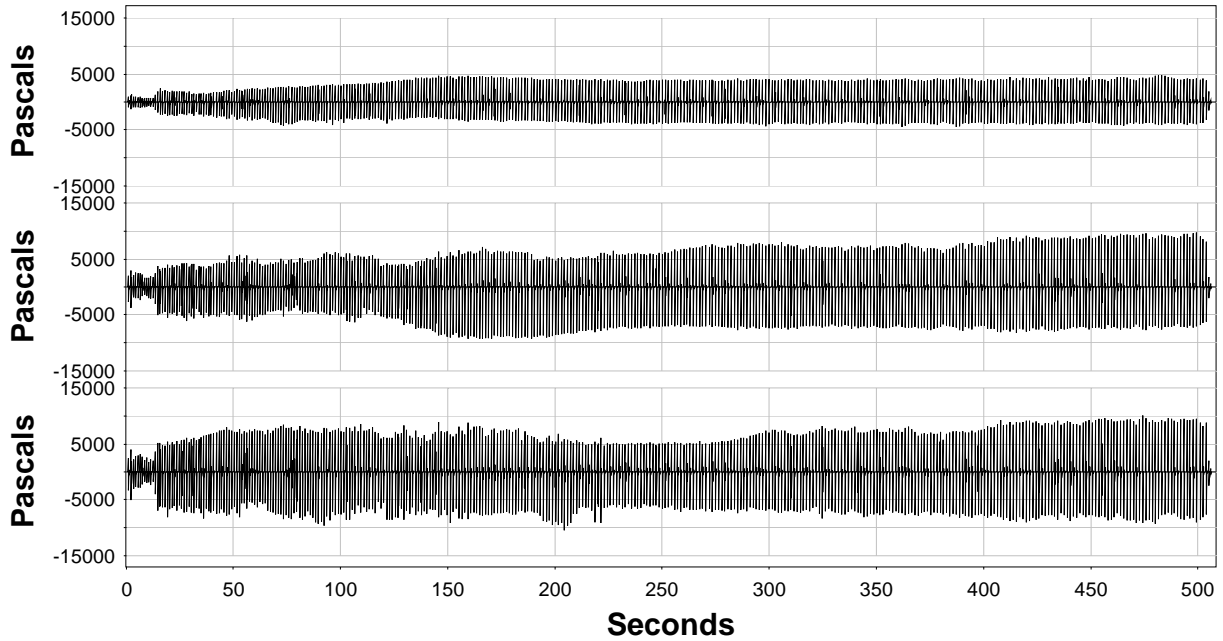

Figure A.11. Sound-Pressure Levels (Pa) Measured for Plumb Pile 237 Driven in 4 ft of Water with the Bubble Curtain in Place.

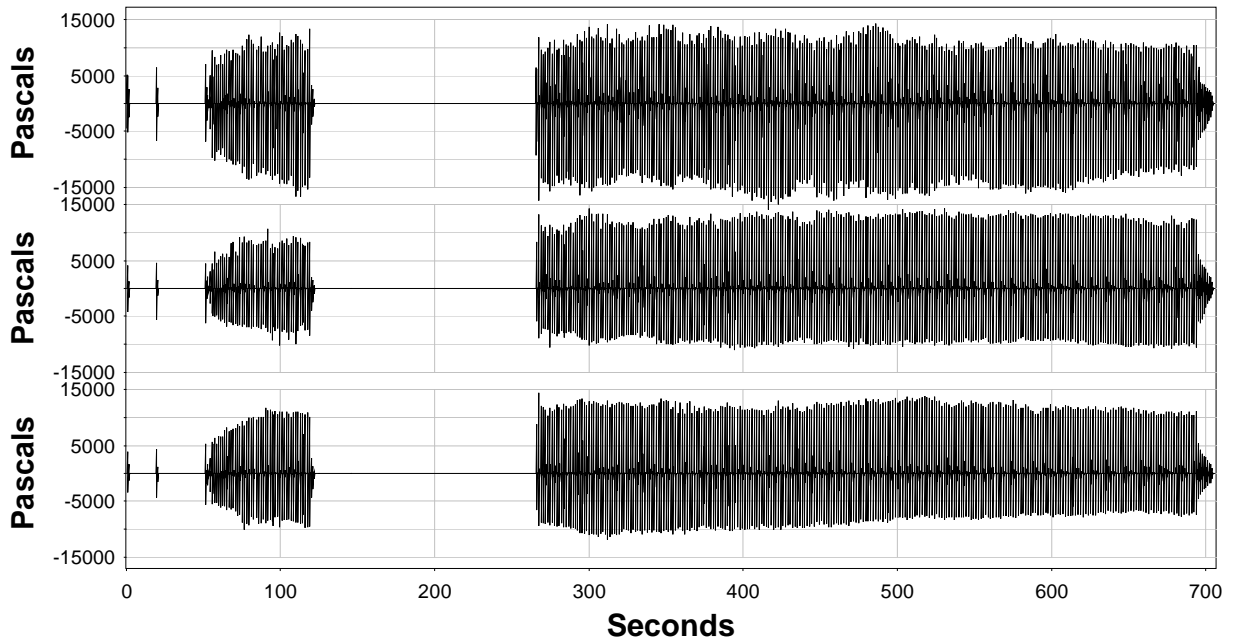

Figure A.12. Sound-Pressure Levels (Pa) Measured for Plumb Pile 50N Driven in 40 ft of Water with No Bubble Curtain.

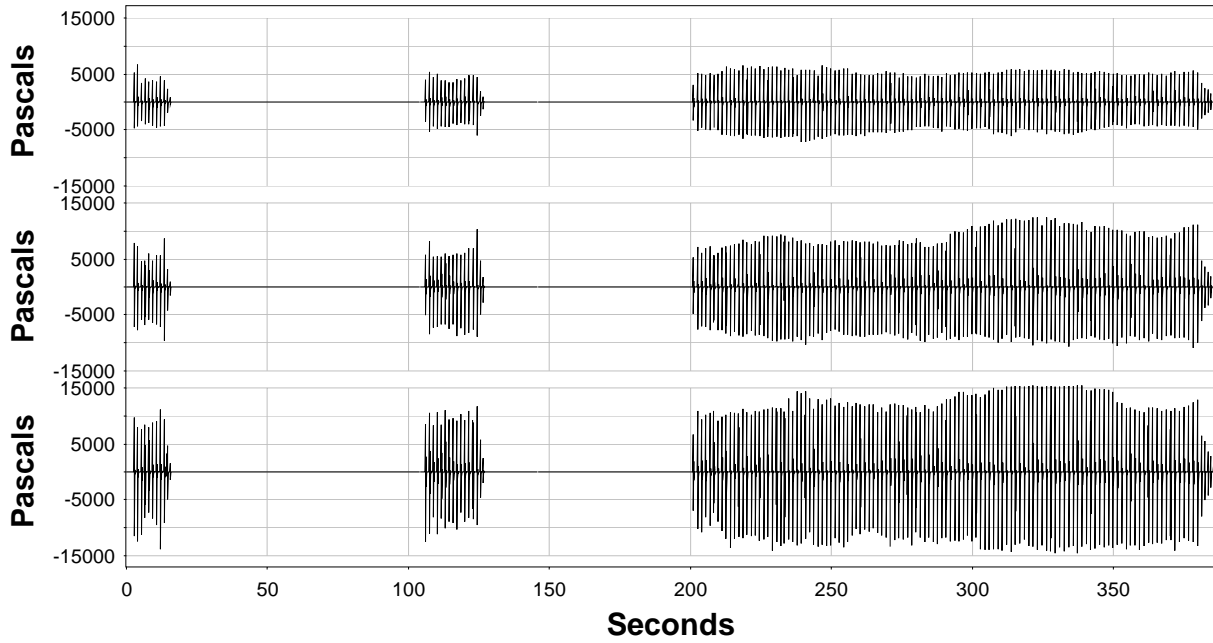

Figure A.13. Sound-Pressure Levels (Pa) Measured for Plumb Pile 120N Driven in 39 ft of Water with No Bubble Curtain.

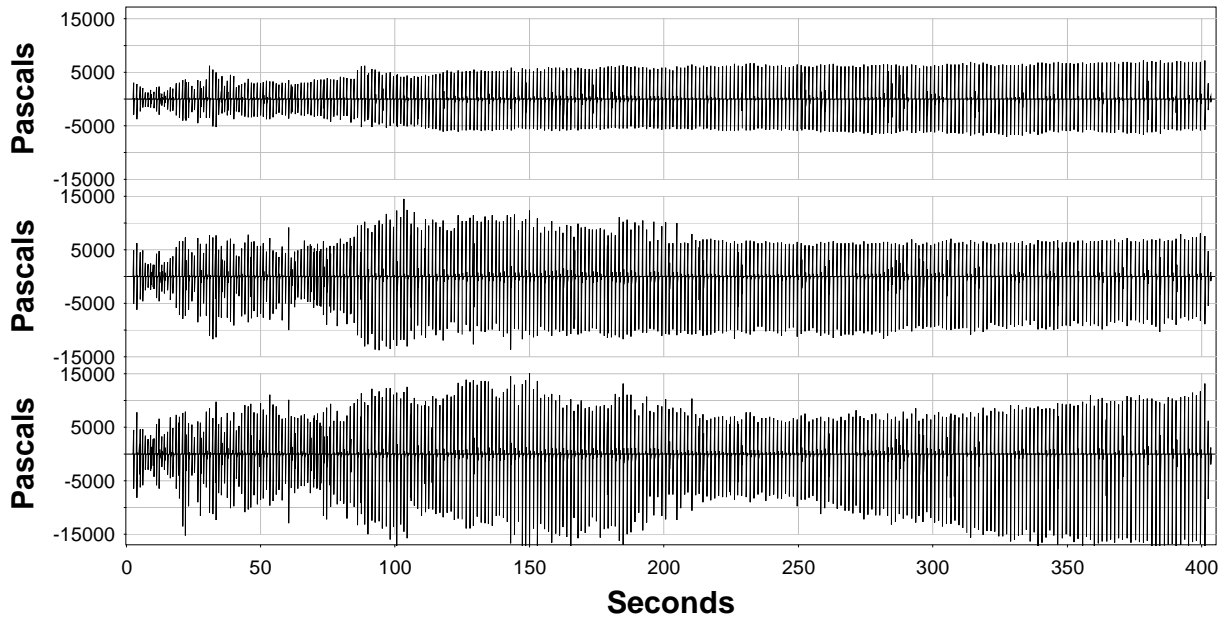

Figure A.14. Sound-Pressure Levels (Pa) Measured for Plumb Pile 240 Driven in 9 ft of Water with No Bubble Curtain.

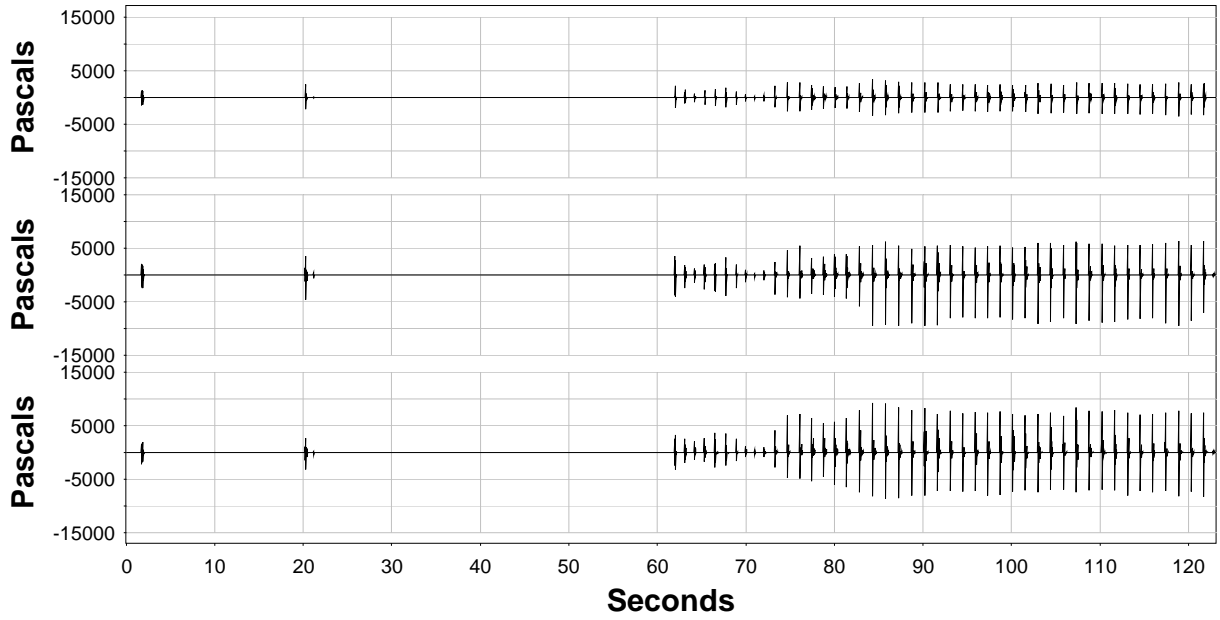

Figure A.15. Sound-Pressure Levels (Pa) Measured for Batter Pile 182 Driven in 41 ft of Water with the Bubble Curtain in Place.

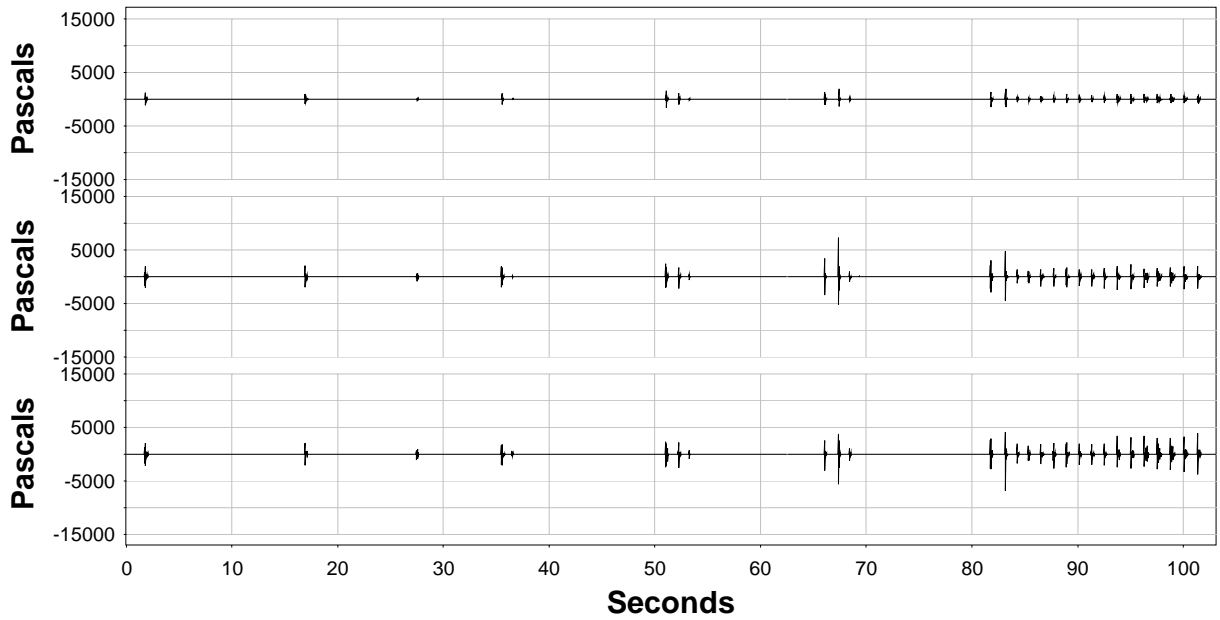

Figure A.16. Sound-Pressure Levels (Pa) Measured for Batter Pile 177 Driven in 37 ft of Water with the Bubble Curtain in Place.

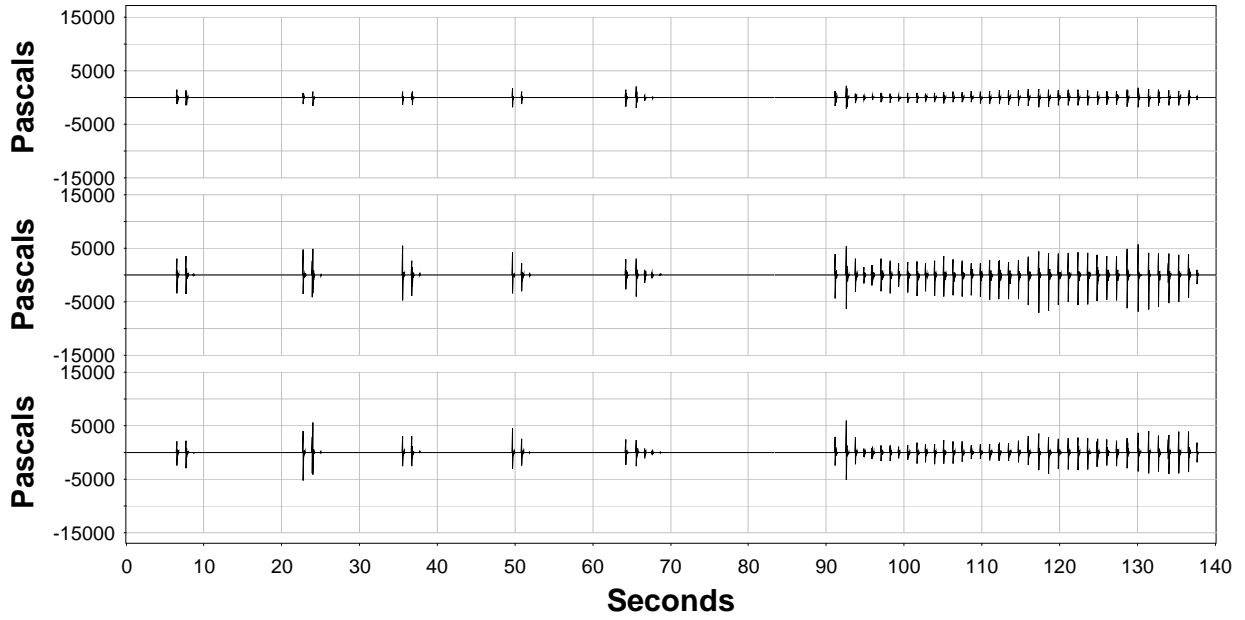

Figure A.17. Sound-Pressure Levels (Pa) Measured for Batter Pile 174 Driven in 29 ft of Water with the Bubble Curtain in Place.

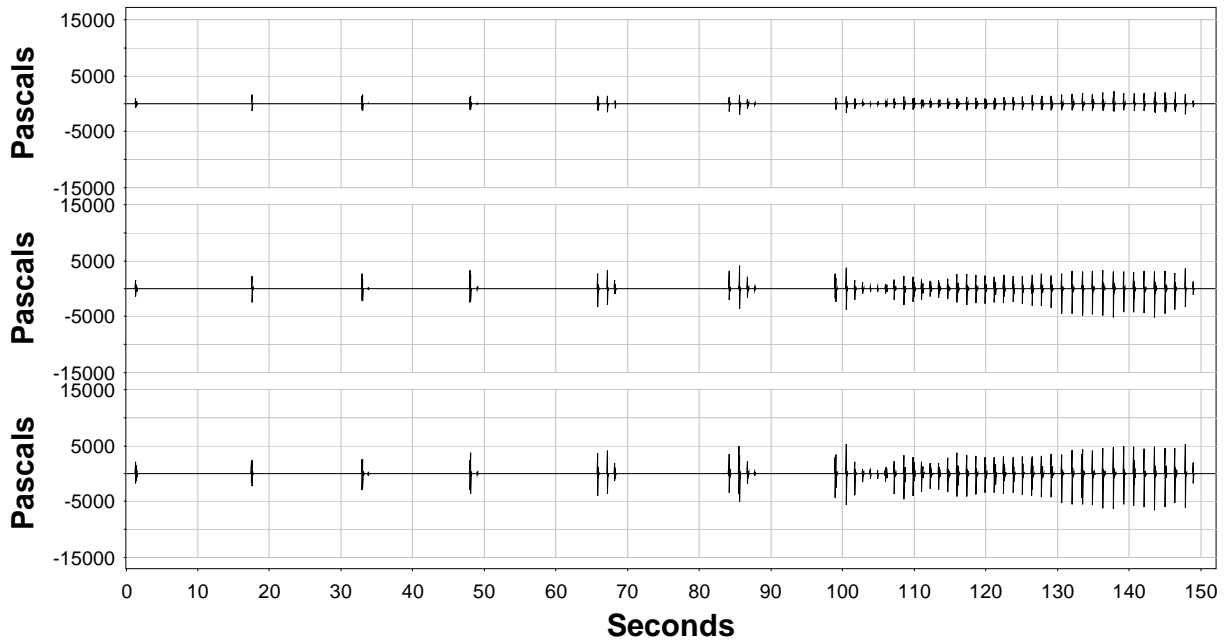

Figure A.18. Sound-Pressure Levels (Pa) Measured for Batter Pile 181 Driven in 7 ft of Water with the Bubble Curtain in Place.

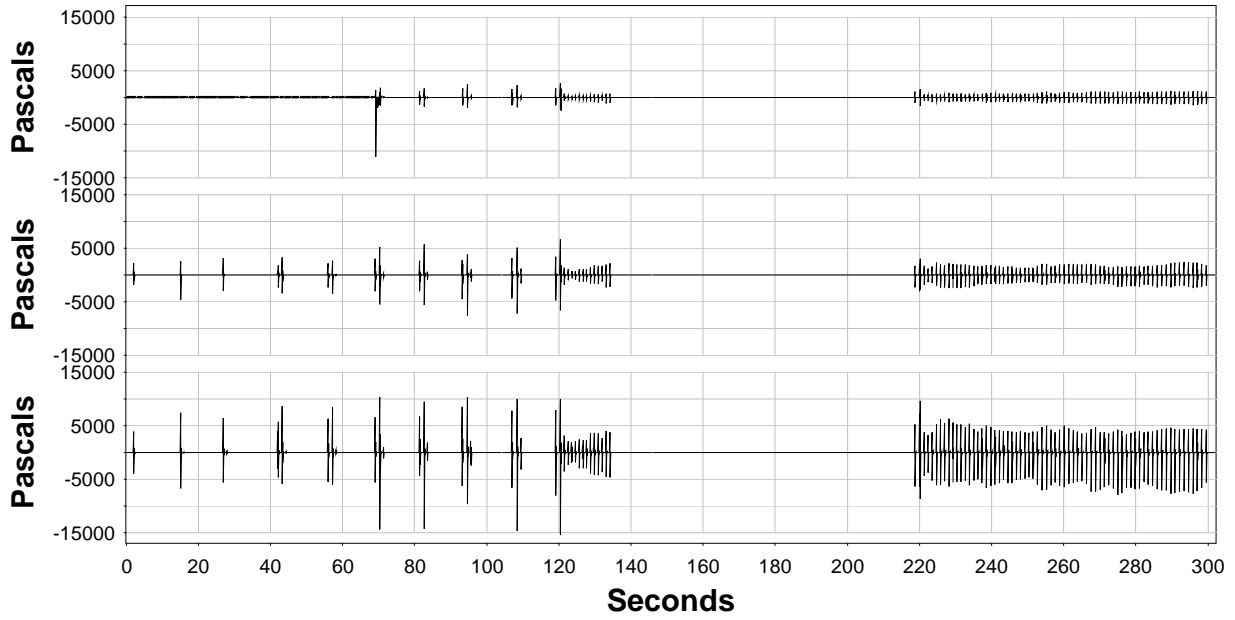

Figure A.19. Sound-Pressure Levels (Pa) Measured for Batter Pile 167 Driven in 7 ft of Water with the Bubble Curtain in Place.

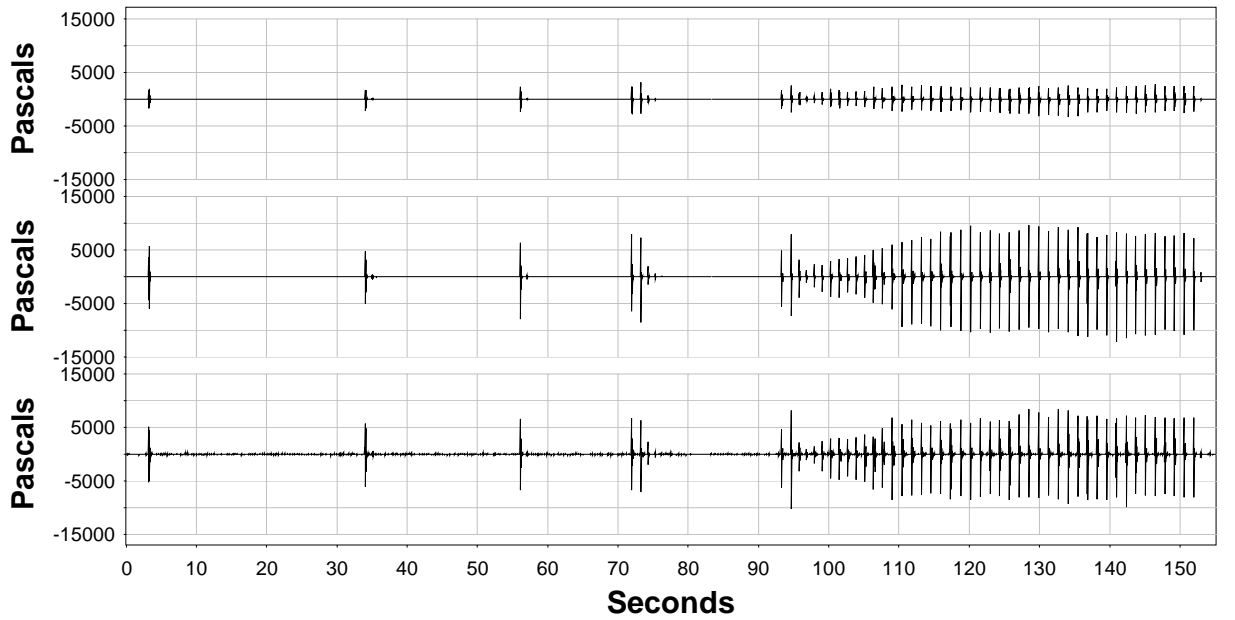

Figure A.20. Sound-Pressure Levels (Pa) Measured for Batter Pile 178 Driven in 37 ft of Water with No Bubble Curtain.

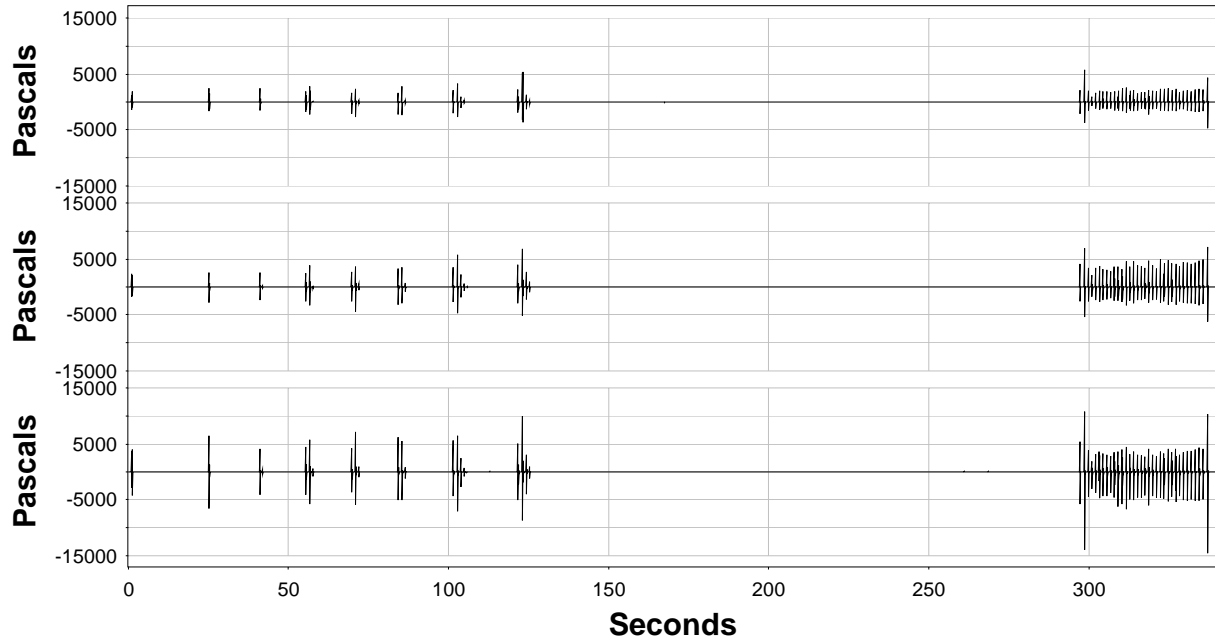

Figure A.21. Sound-Pressure Levels (Pa) Measured for Batter Pile 244 Driven in 7 ft of Water with No Bubble Curtain.

APPENDIX B

Tabulated Distribution Statistics of Impulse Sound Metrics for Each Pile-Driving Event

Table B.1. Distribution Statistics for Root Mean Square (RMS) Sound Pressure Level During the 95th Percentile Pulse Duration of Each Strike in a Series on the Indicated Pile

Pile ID	Impact Time Series		Hydrophone	Number of Impacts	Root Mean Square Sound Pressure (Pa) During 95 th Percentile Pulse Duration										
					Minimum	5th	10th	25th	50th (Median)	Average	st dev	75th	90th	95th	Maximum
121N	1st	3rd	H1	98	791	1234	1618	1834	2287	2337	642	2875	3178	3404	3728
121N	1st	3rd	H2	98	1263	1436	1521	1607	1749	1812	273	1989	2252	2356	2521
121N	1st	3rd	H3	97	526	658	683	778	893	906	164	1065	1106	1131	1222
121N	2nd	3rd	H1	99	774	904	1023	1139	1227	1321	301	1546	1815	1881	2065
121N	2nd	3rd	H2	99	570	653	673	703	755	875	243	964	1294	1379	1571
121N	2nd	3rd	H3	98	245	268	276	293	323	401	139	521	629	682	760
121N	Last	3rd	H1	99	62	1011	1212	2134	2233	2154	533	2500	2665	2754	2959
121N	Last	3rd	H2	99	36	705	765	1528	1630	1532	364	1734	1845	1911	2016
121N	Last	3rd	H3	99	23	287	297	783	874	800	232	947	1005	1022	1081
52N	1st	3rd	H1	35	808	1438	1755	2012	2189	2117	326	2295	2402	2465	2610
52N	1st	3rd	H2	35	1082	1383	1791	1863	2046	2063	338	2289	2521	2569	2769
52N	1st	3rd	H3	35	442	793	959	1054	1194	1151	188	1285	1328	1348	1368
52N	2nd	3rd	H1	36	1887	2020	2105	2164	2362	2343	211	2486	2666	2717	2741
52N	2nd	3rd	H2	36	1974	2123	2212	2489	2769	2912	538	3500	3591	3657	3771
52N	2nd	3rd	H3	36	1026	1045	1112	1173	1220	1227	100	1277	1373	1396	1481
52N	Last	3rd	H1	36	350	490	772	2214	2378	2173	649	2534	2622	2766	2992
52N	Last	3rd	H2	36	804	941	1851	3248	3568	3340	857	3821	4093	4297	4498
52N	Last	3rd	H3	36	204	243	392	1195	1274	1127	340	1291	1328	1360	1419
118N	1st	3rd	H1	67	678	1499	1813	2158	2349	2288	385	2510	2668	2794	2963
118N	1st	3rd	H2	67	359	602	640	861	1060	997	236	1167	1240	1271	1350
118N	1st	3rd	H3	66	53	263	302	329	360	357	63	382	420	450	525
118N	2nd	3rd	H1	68	1394	1496	1526	1675	1770	1806	205	1924	2098	2147	2298
118N	2nd	3rd	H2	67	983	1000	1019	1055	1118	1119	78	1166	1233	1250	1309
118N	2nd	3rd	H3	67	360	373	383	406	441	447	53	483	513	547	579
118N	Last	3rd	H1	68	48	1224	1589	1731	1901	1858	396	2114	2207	2242	2757
118N	Last	3rd	H2	68	358	1130	1144	1195	1246	1227	171	1298	1344	1369	1639
118N	Last	3rd	H3	67	266	455	463	489	515	511	46	542	556	577	591

B.1

Table B.1. (continued)

Pile ID	Impact Time Series		Hydrophone	Number of Impacts	Root Mean Square Sound Pressure (Pa) During 95 th Percentile Pulse Duration										
					Minimum	5 th	10 th	25 th	50 th (Median)	Average	st dev	75 th	90 th	95 th	Maximum
255	1 st	3 rd	H1	77	1737	1932	2108	2403	2619	2577	311	2824	2939	2998	3109
255	1 st	3 rd	H2	77	1572	1679	1903	2171	2287	2231	218	2382	2434	2466	2585
255	1 st	3 rd	H3	77	108	213	263	407	551	612	574	603	710	1840	4002
255	2 nd	3 rd	H1	78	1643	1752	1771	2022	2355	2279	299	2529	2604	2618	2657
255	2 nd	3 rd	H2	78	1284	1298	1349	1572	1836	1783	279	2007	2116	2153	2337
255	2 nd	3 rd	H3	78	118	145	160	258	339	424	501	399	502	1010	3487
255	Last	3 rd	H1	79	461	1339	1374	1457	1573	1556	183	1672	1736	1793	1825
255	Last	3 rd	H2	79	387	1156	1164	1204	1315	1334	186	1476	1567	1638	1702
255	Last	3 rd	H3	79	122	151	167	228	323	337	132	446	534	582	604
249	1 st	3 rd	H1	168	451	1027	1253	1895	2080	1971	445	2251	2381	2442	2709
249	1 st	3 rd	H2	168	327	1012	1365	1676	1953	1936	516	2297	2591	2743	3065
249	1 st	3 rd	H3	168	53	107	146	170	241	284	142	403	504	545	630
249	2 nd	3 rd	H1	168	329	1664	1709	1807	1910	2000	378	2095	2394	3019	3274
249	2 nd	3 rd	H2	168	189	1607	1633	1710	1834	1871	276	2039	2235	2320	2575
249	2 nd	3 rd	H3	168	175	211	229	387	579	518	172	653	705	721	785
249	Last	3 rd	H1	170	662	1574	1597	1677	1830	1886	273	2078	2286	2339	2602
249	Last	3 rd	H2	170	489	1672	1732	1813	1897	1881	167	1963	2060	2101	2223
249	Last	3 rd	H3	169	86	196	206	302	540	481	178	625	679	699	791
252	1 st	3 rd	H1	85	171	832	888	1305	1766	1662	487	2017	2211	2297	2448
252	1 st	3 rd	H2	85	125	671	780	1204	1507	1370	343	1621	1669	1726	1905
252	1 st	3 rd	H3	84	34	76	87	122	177	209	109	287	356	426	496
252	2 nd	3 rd	H1	85	1909	1986	2050	2564	3106	3119	751	3696	4282	4321	4454
252	2 nd	3 rd	H2	85	1161	1223	1255	1384	1505	1607	339	1763	2184	2444	2541
252	2 nd	3 rd	H3	84	108	120	126	157	224	258	130	322	462	546	608
252	Last	3 rd	H1	86	1959	3927	3948	4063	4175	4136	275	4236	4317	4378	4506
252	Last	3 rd	H2	86	1159	2362	2426	2523	2597	2621	236	2759	2910	2930	2990
252	Last	3 rd	H3	85	157	199	234	350	433	446	150	560	655	711	748
172	1 st	3 rd	H1	64	40	102	405	702	1441	1488	947	2136	2906	3164	3570
172	1 st	3 rd	H2	64	97	227	831	1247	2301	2056	1000	2779	3351	3548	3685
172	1 st	3 rd	H3	62	58	119	153	382	809	670	339	943	1053	1071	1107

Table B.1. (continued)

Pile ID	Impact Time Series		Hydrophone	Number of Impacts	Root Mean Square Sound Pressure (Pa) During 95 th Percentile Pulse Duration										
					Minimum	5th	10th	25th	50th (Median)	Average	st dev	75th	90th	95th	Maximum
172	2 nd	3 rd	H1	65	3608	3916	4234	5130	6280	5816	930	6465	6688	6722	6870
172	2 nd	3 rd	H2	65	3844	4046	4555	6265	6767	6367	991	6947	7129	7240	7323
172	2 nd	3 rd	H3	63	867	887	894	937	992	985	60	1037	1048	1052	1123
172	Last	3 rd	H1	65	4118	5762	5915	6093	6341	6321	449	6533	6900	7018	7169
172	Last	3 rd	H2	65	4489	6453	6473	6665	8002	7884	1375	9129	9695	9972	10746
172	Last	3 rd	H3	63	413	821	840	850	888	907	100	955	1044	1084	1102
171	1st	3rd	H1	134	266	656	827	1382	2041	1967	807	2764	2939	2991	3105
171	1st	3rd	H2	134	224	558	645	1480	2404	2327	1110	3360	3446	3501	3813
171	1st	3rd	H3	132	143	197	261	658	964	823	324	1062	1170	1229	1287
171	2nd	3rd	H1	135	383	1903	2043	2167	2719	2612	504	3031	3134	3210	3554
171	2nd	3rd	H2	135	395	3044	3161	3347	3574	3546	403	3799	3957	4000	4168
171	2nd	3rd	H3	132	832	911	939	964	1005	1015	82	1059	1105	1127	1486
171	Last	3rd	H1	136	304	2589	2692	2951	3155	3189	578	3427	3820	4144	4775
171	Last	3rd	H2	136	257	2836	3160	3380	3553	3613	642	3910	4242	4617	5586
171	Last	3rd	H3	133	192	884	920	1020	1361	1272	294	1499	1598	1636	1958
238	1st	3rd	H1	72	112	184	322	573	719	794	444	877	1628	1954	2037
238	1st	3rd	H2	71	45	124	153	331	610	913	751	1331	2172	2434	2502
238	1st	3rd	H3	67	54	84	116	232	587	626	460	1032	1391	1410	1458
238	2nd	3rd	H1	73	966	1216	1278	1609	1910	1960	487	2474	2581	2661	2764
238	2nd	3rd	H2	72	1824	1871	2064	2383	2540	2511	296	2749	2865	2888	2999
238	2nd	3rd	H3	68	925	1051	1089	1185	1251	1284	149	1430	1484	1496	1566
238	Last	3rd	H1	73	2524	2747	2854	3007	3295	3265	322	3514	3701	3728	3852
238	Last	3rd	H2	73	2396	2538	2623	2743	2921	2943	270	3076	3309	3515	3634
238	Last	3rd	H3	69	788	994	1002	1031	1064	1085	95	1114	1244	1293	1443
235	1st	3rd	H1	85	420	932	1151	1563	1795	1715	411	2011	2164	2249	2563
235	1st	3rd	H2	85	293	861	1030	1243	1487	1447	373	1684	1785	1888	2441
235	1st	3rd	H3	85	87	410	493	883	1170	1204	500	1681	1740	1823	2076
235	2nd	3rd	H1	86	1386	1831	1959	2281	2658	2639	493	3030	3228	3370	3687
235	2nd	3rd	H2	86	1727	2121	2195	2331	2523	2547	287	2787	2909	2993	3125
235	2nd	3rd	H3	86	1106	1238	1305	1410	1568	1554	186	1703	1785	1825	1892

Table B.1. (continued)

Pile ID	Impact Time Series		Hydrophone	Number of Impacts	Root Mean Square Sound Pressure (Pa) During 95 th Percentile Pulse Duration										
					Minimum	5th	10th	25th	50th (Median)	Average	st dev	75th	90th	95th	Maximum
235	Last	3rd	H1	86	1326	1537	1638	1723	1830	2135	710	2148	3649	3722	4136
235	Last	3rd	H2	86	1276	1422	1478	1563	1700	1813	364	1905	2496	2604	2904
235	Last	3rd	H3	86	717	1186	1210	1243	1296	1290	89	1352	1375	1383	1435
237	1st	3rd	H1	122	261	655	922	2048	2372	2226	653	2667	2874	2952	3173
237	1st	3rd	H2	122	102	574	931	1418	1542	1504	428	1725	1985	2022	2621
237	1st	3rd	H3	121	60	110	226	556	1043	862	391	1166	1248	1329	1458
237	2nd	3rd	H1	123	1419	1474	1526	1712	1959	1911	271	2071	2201	2284	2697
237	2nd	3rd	H2	123	1564	1722	1812	1923	2079	2153	330	2276	2668	2847	2988
237	2nd	3rd	H3	122	1015	1140	1159	1216	1267	1304	141	1368	1502	1552	1785
237	Last	3rd	H1	123	578	2028	2055	2116	2341	2295	246	2472	2563	2594	2674
237	Last	3rd	H2	123	610	1900	1916	1981	2131	2113	210	2261	2333	2387	2467
237	Last	3rd	H3	123	413	1385	1421	1501	1624	1664	253	1818	2045	2091	2194
50N	1st	3rd	H1	111	244	776	1390	2050	2187	2083	506	2384	2553	2635	2745
50N	1st	3rd	H2	111	215	920	1291	1788	2187	2022	513	2358	2492	2587	2682
50N	1st	3rd	H3	111	60	1031	2089	2628	3018	2875	758	3411	3619	3743	3968
50N	2nd	3rd	H1	111	1848	1974	2008	2042	2103	2137	129	2234	2336	2354	2459
50N	2nd	3rd	H2	111	1958	2113	2142	2255	2341	2332	136	2423	2486	2529	2677
50N	2nd	3rd	H3	112	2101	2301	2395	2588	2769	2742	242	2917	3028	3118	3317
50N	Last	3rd	H1	112	28	468	1759	1825	2056	1895	468	2130	2195	2222	2277
50N	Last	3rd	H2	112	50	525	1790	1885	2128	1972	485	2227	2294	2325	2355
50N	Last	3rd	H3	112	103	767	2290	2495	2625	2514	589	2835	2946	2980	3080
120N	1st	3rd	H1	50	574	1304	1528	1845	2576	2520	750	3279	3466	3591	3616
120N	1st	3rd	H2	50	500	916	1145	1504	1941	1953	627	2566	2763	2953	3011
120N	1st	3rd	H3	50	299	703	858	1046	1347	1342	394	1707	1848	1909	1952
120N	2nd	3rd	H1	51	3140	3266	3437	3589	3728	3723	251	3864	4040	4177	4290
120N	2nd	3rd	H2	51	2334	2401	2440	2496	2638	2640	176	2772	2912	2945	2998
120N	2nd	3rd	H3	50	1434	1500	1525	1591	1695	1707	136	1812	1895	1936	1939
120N	Last	3rd	H1	51	439	1376	3822	3930	4104	3897	870	4349	4424	4448	4528
120N	Last	3rd	H2	51	230	784	2339	2681	2847	2663	636	2937	3047	3079	3133
120N	Last	3rd	H3	51	423	730	1624	1706	1766	1684	302	1812	1844	1866	1927

Table B.1. (continued)

Pile ID	Impact Time Series		Hydrophone	Number of Impacts	Root Mean Square Sound Pressure (Pa) During 95 th Percentile Pulse Duration										
					Minimum	5th	10th	25th	50th (Median)	Average	st dev	75th	90th	95th	Maximum
240	1st	3rd	H1	98	133	801	1159	1842	2309	2330	880	2904	3648	3800	4022
240	1st	3rd	H2	99	52	659	944	1553	1894	2049	877	2496	3471	3555	3680
240	1st	3rd	H3	98	37	435	621	1020	1229	1233	429	1459	1832	1896	1947
240	2nd	3rd	H1	99	2268	2359	2394	2477	2889	2953	492	3337	3696	3884	4009
240	2nd	3rd	H2	99	2204	2297	2493	2703	3347	3242	572	3719	3954	4165	4308
240	2nd	3rd	H3	99	1513	1616	1658	1725	1805	1851	167	1971	2096	2165	2206
240	Last	3rd	H1	100	2138	2515	2562	2750	3056	3150	484	3603	3815	3931	4399
240	Last	3rd	H2	100	34	1955	2027	2137	2251	2238	298	2374	2482	2566	2829
240	Last	3rd	H3	99	694	1550	1573	1617	1676	1672	129	1733	1808	1824	1883
182	1st	3rd	H1	15	132	132	194	406	600	659	369	921	1260	1358	1358
182	1st	3rd	H2	15	116	116	185	419	776	762	409	1085	1338	1399	1399
182	1st	3rd	H3	15	105	105	109	233	467	458	261	685	790	946	946
182	2nd	3rd	H1	15	956	956	1160	1524	1876	1727	346	1954	2068	2129	2129
182	2nd	3rd	H2	15	898	898	1260	1469	1969	1797	378	2072	2084	2121	2121
182	2nd	3rd	H3	15	393	393	470	615	728	702	158	805	919	938	938
182	Last	3rd	H1	16	1829	1829	1873	2005	2072	2070	120	2140	2238	2295	2295
182	Last	3rd	H2	16	1983	1983	2028	2215	2284	2281	147	2371	2477	2563	2563
182	Last	3rd	H3	16	615	615	670	677	740	726	51	761	784	802	802
177	1st	3rd	H1	9	26	26	26	43	534	405	291	594	776	776	776
177	1st	3rd	H2	8	52	52	52	521	629	666	348	908	1161	1161	1161
177	1st	3rd	H3	6	116	116	116	118	185	184	64	240	256	256	256
177	2nd	3rd	H1	9	172	172	172	295	476	612	438	915	1318	1318	1318
177	2nd	3rd	H2	9	184	184	184	270	311	524	389	638	1289	1289	1289
177	2nd	3rd	H3	7	57	57	57	63	143	208	162	376	457	457	457
177	Last	3rd	H1	10	315	315	316	332	340	489	251	648	922	988	988
177	Last	3rd	H2	9	219	219	219	236	347	341	117	397	591	591	591
177	Last	3rd	H3	8	57	57	57	80	107	111	39	143	173	173	173
174	1st	3rd	H1	17	27	27	110	543	636	678	346	758	1102	1394	1394
174	1st	3rd	H2	17	181	181	528	707	924	905	350	1013	1177	1890	1890
174	1st	3rd	H3	16	93	93	95	188	303	295	159	368	442	726	726

Table B.1. (continued)

Pile ID	Impact Time Series		Hydrophone	Number of Impacts	Root Mean Square Sound Pressure (Pa) During 95 th Percentile Pulse Duration										
					Minimum	5th	10th	25th	50th (Median)	Average	st dev	75th	90th	95th	Maximum
174	2nd	3rd	H1	18	153	153	173	264	302	306	103	335	411	619	619
174	2nd	3rd	H2	18	179	179	298	411	477	521	204	601	814	1010	1010
174	2nd	3rd	H3	17	47	47	50	77	94	104	47	127	158	238	238
174	Last	3rd	H1	19	345	345	353	609	847	830	293	1076	1202	1252	1252
174	Last	3rd	H2	18	219	219	605	1168	1378	1279	372	1475	1659	1753	1753
174	Last	3rd	H3	17	97	97	100	130	165	184	69	240	288	293	293
181	1 st	3 rd	H1	16	25	25	124	367	803	746	447	1055	1300	1612	1612
181	1 st	3 rd	H2	15	124	124	175	264	637	587	308	859	1030	1063	1063
181	1 st	3 rd	H3	14	17	17	103	155	314	275	143	403	418	444	444
181	2 nd	3 rd	H1	16	186	186	380	457	561	599	209	791	858	939	939
181	2 nd	3 rd	H2	16	265	265	279	333	383	418	112	500	583	608	608
181	2 nd	3 rd	H3	15	109	109	116	128	180	163	35	196	198	198	198
181	Last	3 rd	H1	17	551	551	982	1264	1671	1494	396	1754	1889	1938	1938
181	Last	3 rd	H2	16	204	204	671	815	992	924	250	1062	1202	1206	1206
181	Last	3 rd	H3	16	207	207	209	264	354	341	89	418	433	469	469
167	1 st	3 rd	H1	33	91	273	314	394	869	1230	1057	1765	3061	3504	3630
167	1 st	3 rd	H2	32	95	113	117	196	394	654	583	1042	1586	1876	1978
167	1 st	3 rd	H3	21	31	65	141	255	324	367	218	450	595	735	949
167	2 nd	3 rd	H1	34	656	798	857	969	1096	1230	466	1267	2016	2171	2956
167	2 nd	3 rd	H2	33	174	199	224	256	346	410	203	481	696	823	1045
167	2 nd	3 rd	H3	22	81	132	167	242	282	268	72	321	326	343	369
167	Last	3 rd	H1	35	1077	1124	1202	1445	1866	1773	392	2098	2205	2473	2474
167	Last	3 rd	H2	34	250	286	345	382	481	496	136	628	676	714	718
167	Last	3 rd	H3	23	138	213	229	265	311	292	52	332	343	345	348
178	1 st	3 rd	H1	17	40	40	52	267	428	750	660	1446	1749	1887	1887
178	1 st	3 rd	H2	17	28	28	215	567	1019	1058	622	1447	2041	2151	2151
178	1 st	3 rd	H3	16	60	60	63	177	307	361	239	568	703	761	761
178	2 nd	3 rd	H1	18	420	420	432	770	1337	1226	561	1756	1909	2052	2052
178	2 nd	3 rd	H2	17	742	742	1070	2234	2803	2379	777	2887	3086	3274	3274
178	2 nd	3 rd	H3	17	280	280	313	423	631	561	137	657	692	699	699

Table B.1. (continued)

Pile ID	Impact Time Series		Hydrophone	Number of Impacts	Root Mean Square Sound Pressure (Pa) During 95 th Percentile Pulse Duration										
					Minimum	5th	10th	25th	50th (Median)	Average	st dev	75th	90th	95th	Maximum
178	Last	3 rd	H1	18	965	965	988	1015	1427	1432	381	1787	1991	2081	2081
178	Last	3 rd	H2	18	2709	2709	2897	3069	3277	3214	227	3383	3468	3505	3505
178	Last	3 rd	H3	17	399	399	401	465	597	558	101	632	664	705	705
244	1st	3rd	H1	17	26	26	33	598	1200	1016	656	1292	1984	1986	1986
244	1st	3rd	H2	16	41	41	459	732	846	946	499	1106	1857	2102	2102
244	1st	3rd	H3	16	272	272	288	466	628	630	262	712	1039	1257	1257
244	2nd	3rd	H1	18	107	107	318	567	925	1017	679	1143	2458	2759	2759
244	2nd	3rd	H2	17	86	86	276	672	832	806	426	925	1170	2078	2078
244	2nd	3rd	H3	16	147	147	249	417	454	492	251	524	721	1284	1284
244	Last	3rd	H1	19	734	734	939	1042	1213	1234	355	1295	1454	2518	2518
244	Last	3rd	H2	18	363	363	702	964	1071	1054	333	1155	1269	2012	2012
244	Last	3rd	H3	17	438	438	446	519	567	583	114	620	665	948	948

Table B.2. Distribution Statistics for Peak Positive Sound Pressure Level During the 95th Percentile Pulse Duration of Each Strike in a Series on the Indicated Pile

Pile ID	Impact Time Series		Hydrophone	Number of Impacts	Peak Positive Sound Pressure (Pa) During 95 th Percentile Pulse Duration										
					Minimum	5th	10th	25th	50th (Median)	Average	st dev	75th	90th	95th	Maximum
121N	1st	3rd	H1	98	3819	5412	6144	6646	7998	8608	2254	11083	11582	11701	11763
121N	1st	3rd	H2	98	4236	4521	4680	4997	5525	6067	1466	6762	8072	8874	12547
121N	1st	3rd	H3	97	2275	2450	2616	2962	3253	3232	438	3475	3735	3833	5167
121N	2nd	3rd	H1	99	5184	5405	5556	5688	5867	6531	1169	7649	8550	8689	9353
121N	2nd	3rd	H2	99	2184	2358	2424	2628	3137	3721	1280	5006	5634	5966	6813
121N	2nd	3rd	H3	98	936	1005	1053	1130	1235	1524	513	1845	2365	2596	2900
121N	Last	3rd	H1	99	2192	4770	5778	7486	8248	8070	1683	8687	10277	10633	10923
121N	Last	3rd	H2	99	1296	2331	2899	5117	5276	5282	1353	5662	7152	7767	8383
121N	Last	3rd	H3	99	561	1093	1297	4607	4843	4323	1344	5043	5242	5377	5869
52N	1st	3rd	H1	35	4836	6417	6806	7056	7673	8044	1284	9284	9706	10353	10531
52N	1st	3rd	H2	35	5071	7379	7747	8264	8727	9379	2005	10276	12863	13790	14782
52N	1st	3rd	H3	35	2596	3332	4132	5064	6331	5812	1209	6573	6761	7204	7923
52N	2nd	3rd	H1	36	6802	7295	7396	7812	8306	8284	681	8610	8904	10066	10247
52N	2nd	3rd	H2	36	7541	7858	8005	8485	8652	9208	1469	9530	11720	13339	13749
52N	2nd	3rd	H3	36	3501	3573	3863	4154	4868	4868	799	5362	6107	6323	6512
52N	Last	3rd	H1	36	1935	2638	3798	7677	7999	7402	1840	8347	8858	9001	9043
52N	Last	3rd	H2	36	3391	3988	5984	9328	10160	9615	2146	11012	11628	12078	12109
52N	Last	3rd	H3	36	714	742	1347	3522	3658	3315	988	3819	3995	4113	4144
118N	1st	3rd	H1	67	4605	5381	6201	8277	9357	9093	1812	10289	11241	11767	12508
118N	1st	3rd	H2	67	2399	3021	3276	3858	4335	4418	834	5035	5382	5647	6414
118N	1st	3rd	H3	66	930	1454	1585	1862	2073	2014	307	2214	2325	2402	2631
118N	2nd	3rd	H1	68	7014	7311	7425	7728	8131	8296	782	8823	9568	9714	10296
118N	2nd	3rd	H2	67	4233	4328	4520	4817	5208	5246	522	5649	5958	6101	6229
118N	2nd	3rd	H3	67	1932	2150	2162	2326	2412	2398	154	2479	2569	2597	2888
118N	Last	3rd	H1	68	606	5098	8014	8326	8508	8227	1440	8762	8978	9041	9540
118N	Last	3rd	H2	68	1940	5127	5310	5530	5787	5893	969	6354	7121	7299	7722
118N	Last	3rd	H3	67	1243	2283	2349	2458	2616	2580	249	2739	2837	2881	2986

Table B.2. (continued)

Pile ID	Impact Time Series		Hydrophone	Number of Impacts	Peak Positive Sound Pressure (Pa) During 95 th Percentile Pulse Duration										
					Minimum	5 th	10 th	25 th	50 th (Median)	Average	st dev	75 th	90 th	95 th	Maximum
255	1 st	3 rd	H1	77	3342	5096	5421	5716	6313	6300	784	6825	7145	7535	8011
255	1 st	3 rd	H2	77	3704	4880	5709	6114	6538	6426	670	6855	7103	7360	7532
255	1 st	3 rd	H3	77	463	1733	1945	2155	2407	2890	2343	2721	2924	9743	13854
255	2 nd	3 rd	H1	78	5838	5953	5987	6062	6212	6190	153	6306	6348	6453	6592
255	2 nd	3 rd	H2	78	4733	4798	4853	4942	5032	5082	286	5129	5241	5588	6439
255	2 nd	3 rd	H3	78	1349	1473	1528	1619	1747	2209	2115	1905	2474	2689	14039
255	Last	3 rd	H1	79	1869	5386	5565	5843	6024	5920	522	6136	6283	6322	6388
255	Last	3 rd	H2	79	1594	3900	4004	4186	4369	4380	433	4643	4822	4883	5177
255	Last	3 rd	H3	79	1443	1476	1728	2150	2291	2268	352	2470	2764	2899	2995
249	1 st	3 rd	H1	168	2247	3498	4316	5875	8226	7639	2199	9097	10309	10857	11546
249	1 st	3 rd	H2	168	1645	2985	3731	5305	5780	5522	1109	6126	6577	6744	7627
249	1 st	3 rd	H3	168	316	831	1050	1447	1603	1585	373	1836	2038	2116	2346
249	2 nd	3 rd	H1	168	1569	6484	6700	7051	7893	8380	2198	8695	10556	14501	15214
249	2 nd	3 rd	H2	168	1441	5602	5678	5826	5964	6362	1522	6180	6763	10536	14297
249	2 nd	3 rd	H3	168	1388	1601	1826	1921	2088	2142	345	2323	2510	2871	3421
249	Last	3 rd	H1	170	2825	5613	5700	6063	6497	6428	570	6779	7088	7224	7668
249	Last	3 rd	H2	170	2383	5491	5706	5851	6024	5977	359	6137	6287	6333	6465
249	Last	3 rd	H3	169	1069	1883	1947	2109	2269	2293	285	2490	2680	2805	3024
252	1 st	3 rd	H1	85	1145	2608	2858	4034	5254	4989	1346	5993	6612	6731	7036
252	1 st	3 rd	H2	85	1629	2106	2297	3981	5325	5021	1526	6253	6686	6891	7415
252	1 st	3 rd	H3	84	521	775	874	1313	1565	1484	370	1725	1854	2002	2162
252	2 nd	3 rd	H1	85	5593	5911	5974	6621	6966	7144	929	7309	8742	8923	9115
252	2 nd	3 rd	H2	85	3746	4148	4226	4368	4502	4541	289	4698	4896	5095	5583
252	2 nd	3 rd	H3	84	1418	1423	1479	1579	1746	1825	337	1906	2291	2381	2863
252	Last	3 rd	H1	86	5838	8714	8858	9095	9483	9493	680	9850	10355	10558	10900
252	Last	3 rd	H2	86	1705	4342	4394	4628	5108	5132	736	5509	6053	6452	6779
252	Last	3 rd	H3	85	1264	1545	1865	2220	2428	2462	457	2829	3038	3057	3495
172	1 st	3 rd	H1	64	650	1221	2861	4073	6565	5985	2509	7913	8938	9137	10630
172	1 st	3 rd	H2	64	952	1701	3299	4511	6904	6535	2495	8815	9456	9836	10209
172	1 st	3 rd	H3	62	688	975	1051	1314	2727	2322	898	3069	3297	3385	3622

Table B.2. (continued)

Pile ID	Impact Time Series		Hydrophone	Number of Impacts	Peak Positive Sound Pressure (Pa) During 95 th Percentile Pulse Duration										
					Minimum	5th	10th	25th	50th (Median)	Average	st dev	75th	90th	95th	Maximum
172	2 nd	3 rd	H1	65	8224	8782	9391	11694	12058	11879	1309	12573	13314	13607	14258
172	2 nd	3 rd	H2	65	8797	9451	9731	12001	14552	13326	2034	14782	14955	15030	15135
172	2 nd	3 rd	H3	63	2802	3006	3048	3155	3360	3351	239	3536	3683	3708	3775
172	Last	3rd	H1	65	8079	11588	11715	12220	13042	12839	965	13574	13812	13833	13970
172	Last	3rd	H2	65	7313	14250	14407	14539	14682	14545	932	14772	14874	15028	15045
172	Last	3rd	H3	63	1311	2725	2751	2830	3091	3044	320	3275	3341	3416	3588
171	1st	3rd	H1	134	1191	2918	3162	5625	6626	6627	2186	8720	8965	9005	9047
171	1st	3rd	H2	134	1037	2265	2883	5142	7438	6549	2359	8378	9108	9280	9464
171	1st	3rd	H3	132	593	960	1087	1979	2420	2273	683	2768	3034	3166	3226
171	2nd	3rd	H1	135	1616	8179	8292	8560	8820	8688	676	8943	9037	9105	9179
171	2nd	3rd	H2	135	2070	9276	9332	9431	9558	9482	659	9666	9700	9721	9762
171	2nd	3rd	H3	132	2336	2489	2558	2790	3339	3179	372	3439	3507	3535	3750
171	Last	3rd	H1	136	1411	9137	9790	10109	11084	10704	1561	11575	11926	12092	12435
171	Last	3rd	H2	136	1028	9663	10469	10922	11519	11448	1728	12503	12963	13086	13742
171	Last	3rd	H3	133	887	2563	2685	2893	3076	3001	374	3195	3337	3375	3703
238	1st	3rd	H1	72	995	1242	1362	1972	2264	2544	1153	2649	4112	5306	6641
238	1st	3rd	H2	71	639	868	1063	1840	2691	3379	1903	5312	6049	6305	6425
238	1st	3rd	H3	67	442	855	1045	1546	2298	2103	731	2570	3029	3139	3480
238	2nd	3rd	H1	73	3073	3257	3362	4240	5300	5150	1124	5987	6506	6758	7587
238	2nd	3rd	H2	72	4294	4484	4575	4781	5470	6079	1411	7564	7966	8178	8333
238	2nd	3rd	H3	68	3104	3198	3294	3394	3578	3598	233	3788	3893	3948	4116
238	Last	3rd	H1	73	6010	6416	6566	6929	7664	7774	946	8518	9042	9241	9712
238	Last	3rd	H2	73	4576	7010	7101	7278	7596	7675	640	8096	8491	8596	9395
238	Last	3rd	H3	69	2276	3286	3327	3456	3541	3563	256	3654	3867	4064	4279
235	1st	3rd	H1	85	1996	2850	3498	4091	4539	4569	901	5293	5656	5782	6426
235	1st	3rd	H2	85	2057	2691	3100	3437	3993	4025	893	4401	4875	5573	8077
235	1st	3rd	H3	85	895	1388	1506	2304	3163	3011	1003	3795	4244	4540	4858
235	2nd	3rd	H1	86	3932	4747	4843	5836	6761	6561	1105	7310	7847	8207	8562
235	2nd	3rd	H2	86	4073	4624	4785	5311	5759	5679	599	6023	6421	6568	7164
235	2nd	3rd	H3	86	4384	4574	4653	4724	4825	4827	155	4949	5022	5051	5146

Table B.2. (continued)

Pile ID	Impact Time Series		Hydrophone	Number of Impacts	Peak Positive Sound Pressure (Pa) During 95 th Percentile Pulse Duration										
					Minimum	5th	10th	25th	50th (Median)	Average	st dev	75th	90th	95th	Maximum
235	Last	3rd	H1	86	4451	4702	4821	5559	6925	6516	1172	7344	7917	8116	8681
235	Last	3rd	H2	86	4235	4373	4592	4833	5592	5779	1164	6289	7938	8217	8812
235	Last	3rd	H3	86	2727	4540	4635	4723	4880	4850	291	5000	5090	5165	5258
237	1st	3rd	H1	122	1336	2578	3188	5839	7116	6434	1674	7512	7938	8094	9005
237	1st	3rd	H2	122	756	2058	2492	3803	4328	4295	1125	5075	5648	5965	6363
237	1st	3rd	H3	121	594	782	1453	1889	2609	2602	1009	3243	4028	4408	4680
237	2nd	3rd	H1	123	4716	4932	5017	5167	5900	6154	1038	7051	7535	7808	8853
237	2nd	3rd	H2	123	4739	5022	5210	5846	6297	6391	862	7169	7544	7684	7992
237	2nd	3rd	H3	122	3627	3808	3835	3911	4060	4097	240	4198	4490	4580	4771
237	Last	3rd	H1	123	2031	6838	7060	7351	8460	8226	1094	9087	9431	9514	10087
237	Last	3rd	H2	123	1770	6715	6957	7232	8511	8120	1107	8955	9302	9491	9814
237	Last	3rd	H3	123	1898	3831	3881	3969	4113	4118	296	4262	4408	4509	4905
50N	1st	3rd	H1	111	1128	3930	6601	9923	11409	10498	2816	12333	12840	13157	14456
50N	1st	3rd	H2	111	1530	4116	5540	8020	10016	9445	2895	11650	12755	13240	14335
50N	1st	3rd	H3	111	598	5044	7099	9510	10840	10328	2516	11842	12823	13553	14216
50N	2nd	3rd	H1	111	10497	10802	11210	11492	12217	12218	821	12906	13276	13503	13905
50N	2nd	3rd	H2	111	10549	11409	11702	12275	12848	12785	773	13403	13628	13848	14186
50N	2nd	3rd	H3	112	9576	9971	10415	10860	11822	11828	1118	12589	13356	13798	14376
50N	Last	3rd	H1	112	276	3119	10464	11054	11591	10964	2530	12112	12546	12752	13171
50N	Last	3rd	H2	112	1071	3950	11236	12311	12925	12037	2650	13220	13388	13502	14329
50N	Last	3rd	H3	112	970	3509	9029	9761	10361	9895	2172	10885	11464	11707	12506
120N	1st	3rd	H1	50	2457	5745	7099	8606	10046	9544	1965	10941	11305	11528	13457
120N	1st	3rd	H2	50	1862	4252	4706	5597	6380	6605	1655	7783	8887	9162	10361
120N	1st	3rd	H3	50	1016	2377	3477	3901	4845	4786	1249	5877	6409	6491	6684
120N	2nd	3rd	H1	51	10738	10771	10907	11609	12161	12480	1176	13356	14306	14491	15051
120N	2nd	3rd	H2	51	7208	7273	7473	7707	8128	8527	1181	9164	10373	10987	11888
120N	2nd	3rd	H3	50	4387	4510	4583	4869	5254	5275	522	5700	6016	6095	6623
120N	Last	3rd	H1	51	1941	3699	10708	11406	14569	12709	3402	15304	15401	15447	15525
120N	Last	3rd	H2	51	1149	2767	8657	9491	10719	9976	2631	11478	12119	12418	12446
120N	Last	3rd	H3	51	1532	2481	4714	4994	5304	5132	888	5678	5777	5884	5925

Table B.2. (continued)

Pile ID	Impact Time Series		Hydrophone	Number of Impacts	Peak Positive Sound Pressure (Pa) During 95 th Percentile Pulse Duration										
					Minimum	5th	10th	25th	50th (Median)	Average	st dev	75th	90th	95th	Maximum
240	1st	3rd	H1	98	1314	2932	4082	6171	7506	7585	2531	9396	11096	11784	12628
240	1st	3rd	H2	99	784	2262	3489	4772	6181	6525	2723	7809	10510	11691	14528
240	1st	3rd	H3	98	611	1393	2159	2898	3530	3517	1156	4301	4992	5583	6296
240	2nd	3rd	H1	99	6009	6196	6453	7192	9115	9450	2459	11101	13440	13810	15147
240	2nd	3rd	H2	99	5728	5984	6235	6570	8703	8487	1862	10267	10970	11473	12276
240	2nd	3rd	H3	99	4748	5149	5269	5465	5898	5829	428	6137	6351	6537	6727
240	Last	3rd	H1	100	6160	6326	6541	7028	8407	8472	1579	9747	10608	10978	13170
240	Last	3rd	H2	100	177	5932	6051	6226	6478	6460	776	6774	6983	7287	8050
240	Last	3rd	H3	99	3029	6090	6150	6348	6559	6554	480	6845	7032	7103	7216
182	1st	3rd	H1	15	1038	1038	1300	2104	2759	3511	1958	4185	6927	7227	7227
182	1st	3rd	H2	15	869	869	1014	1880	2289	2667	1319	3608	4654	5504	5504
182	1st	3rd	H3	15	503	503	628	1126	1629	1735	767	2352	2815	2910	2910
182	2nd	3rd	H1	15	5532	5532	5717	7271	7671	7617	1073	8287	9187	9349	9349
182	2nd	3rd	H2	15	3479	3479	3889	4972	5448	5149	764	5523	5647	6224	6224
182	2nd	3rd	H3	15	2040	2040	2146	2383	2507	2634	397	2888	3165	3455	3455
182	Last	3rd	H1	16	6903	6903	6959	7246	7484	7490	387	7756	7941	8402	8402
182	Last	3rd	H2	16	5148	5148	5303	5612	5821	5812	347	6020	6341	6405	6405
182	Last	3rd	H3	16	2385	2385	2395	2466	2632	2616	162	2737	2829	2896	2896
177	1st	3rd	H1	9	396	396	396	976	2070	1699	800	2192	2595	2595	2595
177	1st	3rd	H2	8	638	638	638	1865	2043	2712	2030	2939	7361	7361	7361
177	1st	3rd	H3	6	976	976	976	1102	1225	1274	258	1431	1683	1683	1683
177	2nd	3rd	H1	9	1105	1105	1105	1908	2123	2442	1030	2920	4204	4204	4204
177	2nd	3rd	H2	9	1058	1058	1058	1406	1440	1969	1211	1748	4795	4795	4795
177	2nd	3rd	H3	7	500	500	500	765	1007	1221	600	1965	2045	2045	2045
177	Last	3rd	H1	10	1901	1901	1950	2012	3177	2948	714	3430	3686	3906	3906
177	Last	3rd	H2	9	1377	1377	1377	1636	1718	1801	303	1998	2333	2333	2333
177	Last	3rd	H3	8	826	826	826	858	997	960	99	1039	1071	1071	1071
174	1st	3rd	H1	17	513	513	773	2354	2966	3063	1443	3660	5615	6005	6005
174	1st	3rd	H2	17	1053	1053	2209	2778	3149	3485	1245	4367	5457	5566	5566
174	1st	3rd	H3	16	808	808	951	1123	1364	1436	430	1632	2110	2299	2299

B.12

Table B.2. (continued)

Pile ID	Impact Time Series		Hydrophone	Number of Impacts	Peak Positive Sound Pressure (Pa) During 95 th Percentile Pulse Duration										
					Minimum	5th	10th	25th	50th (Median)	Average	st dev	75th	90th	95th	Maximum
174	2nd	3rd	H1	18	847	847	1152	1368	1655	1688	481	1929	2409	2816	2816
174	2nd	3rd	H2	18	1466	1466	1913	2236	2675	2578	477	2874	3048	3527	3527
174	2nd	3rd	H3	17	553	553	576	853	1071	1027	278	1221	1431	1456	1456
174	Last	3rd	H1	19	1939	1939	2193	2598	2873	2999	619	3584	3931	4034	4034
174	Last	3rd	H2	18	1006	1006	3465	3830	4090	3989	905	4227	4921	5730	5730
174	Last	3rd	H3	17	1175	1175	1237	1395	1470	1464	182	1523	1657	1904	1904
181	1st	3rd	H1	16	595	595	716	2018	2535	2800	1427	3768	4955	5322	5322
181	1st	3rd	H2	15	899	899	1178	1618	2724	2491	977	3277	3771	4199	4199
181	1st	3rd	H3	14	570	570	578	908	1322	1203	384	1473	1650	1683	1683
181	2nd	3rd	H1	16	1235	1235	1897	2204	2966	2750	664	3164	3340	3771	3771
181	2nd	3rd	H2	16	1450	1450	1526	1774	2272	2166	407	2566	2582	2649	2649
181	2nd	3rd	H3	15	651	651	744	951	1055	1068	217	1244	1359	1371	1371
181	Last	3rd	H1	17	2006	2006	3110	3604	4472	4201	852	4773	4948	5323	5323
181	Last	3rd	H2	16	1305	1305	2441	2817	3125	2970	525	3213	3350	3677	3677
181	Last	3rd	H3	16	1433	1433	1462	1708	1875	1857	247	2048	2175	2226	2226
167	1st	3rd	H1	33	946	1824	2089	2519	4125	5367	3051	7951	10045	10357	10375
167	1st	3rd	H2	32	751	1105	1120	1515	2209	2577	1475	3192	5111	5721	6803
167	1st	3rd	H3	21	559	615	727	787	1248	1343	659	1705	2417	2473	2723
167	2nd	3rd	H1	34	3361	3665	3822	3987	4390	4723	1155	5316	5653	6429	9603
167	2nd	3rd	H2	33	1273	1343	1408	1634	1791	1820	354	2023	2156	2384	3082
167	2nd	3rd	H3	22	628	695	710	746	822	818	89	894	923	925	957
167	Last	3rd	H1	35	3485	3601	3667	3879	4251	4184	378	4471	4597	4778	5031
167	Last	3rd	H2	34	1483	1549	1589	1703	1968	1955	286	2164	2364	2436	2437
167	Last	3rd	H3	23	886	952	1035	1058	1078	1088	74	1148	1161	1195	1216
178	1st	3rd	H1	17	330	330	632	2281	3016	3717	2408	5799	6705	8252	8252
178	1st	3rd	H2	17	483	483	1232	2375	3440	4129	2295	5748	7905	8005	8005
178	1st	3rd	H3	16	464	464	811	1414	1731	1778	681	2193	2626	3268	3268
178	2nd	3rd	H1	18	3184	3184	3308	5442	6047	5716	1203	6463	6835	7419	7419
178	2nd	3rd	H2	17	4056	4056	5084	6537	8086	7396	1531	8421	8779	9596	9596
178	2nd	3rd	H3	17	2028	2028	2140	2286	2300	2329	173	2350	2568	2765	2765

Table B.2. (continued)

Pile ID	Impact Time Series		Hydrophone	Number of Impacts	Peak Positive Sound Pressure (Pa) During 95 th Percentile Pulse Duration										
					Minimum	5th	10th	25th	50th (Median)	Average	st dev	75th	90th	95th	Maximum
178	Last	3rd	H1	18	6590	6590	6743	6835	7033	7256	596	7327	8488	8491	8491
178	Last	3rd	H2	18	7176	7176	7531	7669	8186	8303	731	8827	9399	9625	9625
178	Last	3rd	H3	17	1995	1995	1997	2235	2458	2372	234	2532	2618	2798	2798
244	1st	3rd	H1	17	185	185	369	2457	4494	4127	2349	5827	6512	7215	7215
244	1st	3rd	H2	16	592	592	2241	2574	3055	3336	1448	3800	5768	6892	6892
244	1st	3rd	H3	16	1042	1042	1323	1834	2207	2394	1009	2706	3318	5480	5480
244	2nd	3rd	H1	18	1005	1005	1986	3115	3618	4167	2462	4085	10047	10809	10809
244	2nd	3rd	H2	17	1005	1005	2122	3218	3628	3600	1216	3870	4647	6906	6906
244	2nd	3rd	H3	16	973	973	1572	1810	2001	2186	1028	2135	2606	5788	5788
244	Last	3rd	H1	19	2732	2732	2824	3106	3658	3938	1640	4113	4344	10389	10389
244	Last	3rd	H2	18	3322	3322	3466	3928	4354	4439	848	4793	4931	7221	7221
244	Last	3rd	H3	17	1802	1802	1803	2013	2212	2298	566	2380	2500	4333	4333

Table B.3. Distribution Statistics for Peak Negative Sound Pressure Level During the 95th Percentile Pulse Duration of Each Strike in a Series on the Indicated Pile

Pile ID	Impact Time Series		Hydrophone	Number of Impacts	Peak Negative Sound Pressure (Pa) During 95 th Percentile Pulse Duration										
					Minimum	5th	10th	25th	50th (Median)	Average	st dev	75th	90th	95th	Maximum
121N	1st	3rd	H1	98	-15174	-14411	-14156	-13049	-10844	-10602	2811	-8600	-7562	-5548	-3463
121N	1st	3rd	H2	98	-12761	-8913	-8579	-7367	-6839	-7147	1091	-6493	-6279	-6139	-5573
121N	1st	3rd	H3	97	-5602	-4760	-4494	-3946	-3528	-3619	614	-3246	-2991	-2741	-2118
121N	2nd	3rd	H1	99	-10260	-9689	-9362	-8112	-5626	-6494	1755	-5029	-4837	-4762	-4619
121N	2nd	3rd	H2	99	-6676	-5978	-5528	-4631	-3590	-3958	991	-3151	-2997	-2945	-2837
121N	2nd	3rd	H3	98	-3522	-3322	-3043	-2491	-1694	-1994	636	-1466	-1403	-1379	-1358
121N	Last	3rd	H1	99	-17692	-16184	-15614	-14338	-12853	-11859	3615	-10567	-5521	-4233	-1146
121N	Last	3rd	H2	99	-11744	-11484	-11438	-11062	-10519	-9305	2892	-9318	-3334	-2692	-461
121N	Last	3rd	H3	99	-4311	-3898	-3787	-3720	-3639	-3307	831	-3502	-1435	-1397	-363
52N	1st	3rd	H1	35	-11553	-11049	-9937	-9706	-9525	-9452	886	-9175	-9042	-8569	-5476
52N	1st	3rd	H2	35	-14565	-14087	-13556	-12877	-10684	-11022	1788	-9911	-8796	-8294	-7408
52N	1st	3rd	H3	35	-6643	-6598	-6564	-6248	-5903	-5834	681	-5597	-5245	-5202	-2727
52N	2nd	3rd	H1	36	-9991	-9658	-9599	-8958	-8620	-8701	497	-8346	-8163	-7834	-7809
52N	2nd	3rd	H2	36	-13142	-12855	-12497	-11414	-10904	-10807	1101	-9938	-9211	-9142	-8937
52N	2nd	3rd	H3	36	-7805	-7755	-7662	-7437	-7213	-7216	329	-7049	-6879	-6367	-6325
52N	Last	3rd	H1	36	-9503	-9398	-9148	-8947	-8765	-7850	2151	-8298	-3405	-2249	-1800
52N	Last	3rd	H2	36	-13207	-12964	-12712	-12362	-12088	-11072	2526	-11238	-6703	-3976	-3277
52N	Last	3rd	H3	36	-8765	-8603	-8397	-8257	-8046	-7193	2134	-7795	-2772	-1552	-1275
118N	1st	3rd	H1	67	-10979	-10653	-10557	-10308	-9673	-9520	1081	-9168	-8613	-7522	-4933
118N	1st	3rd	H2	67	-6620	-6046	-5529	-4864	-4070	-4161	1041	-3452	-2710	-2575	-1945
118N	1st	3rd	H3	66	-2276	-2179	-2108	-1981	-1793	-1781	281	-1648	-1354	-1280	-917
118N	2nd	3rd	H1	68	-10120	-9687	-9523	-9343	-8898	-8923	537	-8611	-8269	-7821	-7586
118N	2nd	3rd	H2	67	-5552	-4846	-4698	-4532	-4281	-4247	432	-4059	-3623	-3585	-3198
118N	2nd	3rd	H3	67	-2443	-2385	-2342	-2287	-2168	-2189	116	-2092	-2034	-2027	-1999
118N	Last	3rd	H1	68	-10935	-10641	-10107	-9739	-9279	-9011	1629	-8928	-8220	-5893	-310
118N	Last	3rd	H2	68	-6555	-6376	-6119	-5787	-5554	-5414	831	-5214	-4739	-4628	-1629
118N	Last	3rd	H3	67	-2728	-2583	-2492	-2351	-2280	-2281	179	-2194	-2109	-2060	-1416

Table B.3. (continued)

Pile ID	Impact Time Series		Hydrophone	Number of Impacts	Peak Negative Sound Pressure (Pa) During 95 th Percentile Pulse Duration										
					Minimum	5th	10th	25th	50th (Median)	Average	st dev	75th	90th	95th	Maximum
255	1st	3rd	H1	77	-11589	-11037	-10787	-10342	-9171	-9337	1110	-8642	-8070	-7860	-5669
255	1st	3rd	H2	77	-9050	-8639	-8443	-7979	-7551	-7473	879	-7229	-6173	-5273	-4735
255	1st	3rd	H3	77	-8460	-2738	-2452	-2376	-2233	-2377	966	-2097	-1941	-1699	-1172
255	2nd	3rd	H1	78	-9441	-9211	-8954	-8636	-8178	-8135	680	-7768	-7102	-6770	-6340
255	2nd	3rd	H2	78	-8105	-7859	-7780	-7587	-7241	-6980	828	-6454	-5490	-4939	-4547
255	2nd	3rd	H3	78	-11331	-5892	-2131	-1813	-1601	-1937	1595	-1411	-1173	-1089	-1018
255	Last	3rd	H1	79	-8340	-8014	-7874	-7544	-6791	-6803	920	-6164	-5814	-5547	-2275
255	Last	3rd	H2	79	-6693	-6465	-6355	-6158	-5418	-5454	800	-4779	-4557	-4414	-1943
255	Last	3rd	H3	79	-2079	-2026	-1796	-1571	-1438	-1467	242	-1296	-1194	-1122	-1039
249	1st	3rd	H1	168	-10456	-10218	-10099	-9678	-9075	-8650	1691	-8277	-5750	-4291	-2410
249	1st	3rd	H2	168	-7602	-6937	-6518	-6089	-5513	-5520	904	-4992	-4707	-4564	-1814
249	1st	3rd	H3	168	-2176	-2106	-2083	-2008	-1907	-1803	340	-1744	-1234	-1011	-471
249	2nd	3rd	H1	168	-18118	-15809	-8984	-8027	-7223	-7980	2512	-6840	-6582	-6473	-1877
249	2nd	3rd	H2	168	-11556	-9569	-6911	-5893	-4778	-5457	1600	-4510	-4403	-4372	-1380
249	2nd	3rd	H3	168	-4372	-3335	-2795	-2469	-2300	-2407	424	-2185	-2096	-2047	-1634
249	Last	3rd	H1	170	-7138	-6890	-6768	-6620	-6363	-6371	389	-6167	-5976	-5913	-3094
249	Last	3rd	H2	170	-5925	-5652	-5400	-5158	-4884	-4924	392	-4684	-4557	-4458	-2379
249	Last	3rd	H3	169	-2857	-2541	-2465	-2336	-2208	-2203	226	-2044	-1931	-1896	-993
252	1st	3rd	H1	85	-8506	-8197	-7935	-7644	-7138	-6586	1506	-5936	-3951	-3778	-1456
252	1st	3rd	H2	85	-8506	-8197	-7935	-7644	-7138	-6586	1506	-5936	-3951	-3778	-1456
252	1st	3rd	H3	85	-6679	-5653	-5565	-5138	-4434	-4341	1096	-3855	-2590	-2202	-1189
252	1st	3rd	H1	84	-1918	-1761	-1702	-1606	-1380	-1299	370	-968	-768	-665	-439
252	2nd	3rd	H2	85	-13999	-13930	-13641	-13122	-11491	-11321	1837	-9780	-8753	-8572	-8125
252	2nd	3rd	H3	85	-13999	-13930	-13641	-13122	-11491	-11321	1837	-9780	-8753	-8572	-8125
252	2nd	3rd	H1	85	-9226	-8701	-7857	-6240	-5666	-5651	1472	-4445	-3848	-3631	-3388
252	2nd	3rd	H2	84	-2126	-1941	-1813	-1269	-1137	-1224	295	-1048	-968	-956	-910
252	Last	3rd	H3	86	-16306	-15402	-14940	-14543	-14006	-13933	1135	-13565	-12932	-12553	-6341
252	Last	3rd	H1	86	-16306	-15402	-14940	-14543	-14006	-13933	1135	-13565	-12932	-12553	-6341
252	Last	3rd	H2	86	-12003	-11576	-11442	-10498	-8919	-9311	1363	-8408	-7826	-7540	-5133
252	Last	3rd	H3	85	-2545	-2323	-2249	-2109	-1928	-1925	251	-1759	-1591	-1503	-1335

Table B.3. (continued)

Pile ID	Impact Time Series		Hydrophone	Number of Impacts	Peak Negative Sound Pressure (Pa) During 95 th Percentile Pulse Duration										
					Minimum	5th	10th	25th	50th (Median)	Average	st dev	75th	90th	95th	Maximum
172	1st	3rd	H1	64	-14674	-13896	-13475	-10079	-6109	-6897	4022	-3551	-2732	-1134	-389
172	1st	3rd	H2	64	-14398	-11442	-10076	-8545	-6469	-6628	2849	-4489	-3299	-1829	-1303
172	1st	3rd	H3	62	-4420	-4283	-4074	-3749	-2764	-2543	1247	-1219	-895	-850	-768
172	2nd	3rd	H1	65	-19866	-19647	-19568	-18921	-18176	-17615	1696	-16288	-14878	-14391	-13912
172	2nd	3rd	H2	65	-23776	-23089	-22807	-21280	-19968	-19593	2577	-18463	-15371	-14325	-13232
172	2nd	3rd	H3	63	-3577	-3386	-3381	-3235	-3054	-3061	230	-2896	-2770	-2663	-2591
172	Last	3rd	H1	65	-20559	-20510	-20487	-20179	-19769	-19401	1210	-18663	-18318	-17676	-12787
172	Last	3rd	H2	65	-24491	-24352	-24305	-24068	-22742	-22630	1788	-21410	-20797	-20382	-13101
172	Last	3rd	H3	63	-3339	-3195	-3130	-3064	-2924	-2863	303	-2682	-2561	-2537	-1212
171	1st	3rd	H1	134	-11435	-11063	-10840	-9659	-7553	-7283	2786	-5690	-3252	-2306	-1054
171	1st	3rd	H2	134	-8946	-8800	-8611	-8358	-7919	-6556	2566	-5593	-1879	-1502	-1015
171	1st	3rd	H3	132	-3912	-3811	-3739	-3442	-2748	-2482	1066	-1688	-811	-682	-576
171	2nd	3rd	H1	135	-12359	-11960	-11857	-11656	-11274	-11144	914	-10747	-10402	-10159	-2740
171	2nd	3rd	H2	135	-8918	-8693	-8591	-8422	-8164	-8155	550	-7984	-7855	-7768	-2662
171	2nd	3rd	H3	132	-4779	-4612	-4522	-4375	-4085	-4114	293	-3869	-3764	-3735	-3534
171	Last	3rd	H1	136	-13748	-11644	-11315	-10930	-10114	-10003	1486	-9300	-8878	-8602	-1864
171	Last	3rd	H2	136	-12105	-9994	-9663	-9206	-8740	-8666	1162	-8282	-8030	-7629	-1448
171	Last	3rd	H3	133	-4010	-3685	-3620	-3519	-3390	-3299	382	-3186	-2940	-2887	-1152
238	1st	3rd	H1	72	-7316	-5948	-5347	-3410	-2585	-2938	1340	-2063	-1903	-1118	-743
238	1st	3rd	H2	71	-6378	-5835	-5147	-3632	-2282	-2738	1542	-1556	-1067	-826	-440
238	1st	3rd	H3	67	-4323	-3881	-3834	-2951	-2087	-2171	1027	-1380	-843	-803	-659
238	2nd	3rd	H1	73	-8751	-8470	-8213	-7789	-6587	-6757	1103	-6103	-5282	-4751	-4279
238	2nd	3rd	H2	72	-8715	-8557	-8386	-7845	-6970	-6830	1283	-6179	-4685	-4218	-4008
238	2nd	3rd	H3	68	-4016	-3989	-3946	-3791	-3186	-3236	522	-2901	-2476	-2324	-2227
238	Last	3rd	H1	73	-10125	-9754	-9521	-9200	-8920	-8857	607	-8541	-8235	-8017	-5892
238	Last	3rd	H2	73	-12138	-11939	-11462	-10618	-9146	-9225	1528	-7857	-7440	-7098	-6822
238	Last	3rd	H3	69	-4462	-4157	-4002	-3536	-3329	-3375	384	-3189	-3032	-2862	-2090
235	1st	3rd	H1	85	-10611	-7864	-7489	-6849	-5924	-5874	1383	-4848	-4173	-3737	-2816
235	1st	3rd	H2	85	-8412	-7931	-7122	-6250	-5286	-5258	1387	-4026	-3715	-3570	-2169
235	1st	3rd	H3	85	-6022	-4885	-4402	-3978	-3688	-3518	907	-3371	-2115	-1765	-891

Table B.3. (continued)

Pile ID	Impact Time Series		Hydrophone	Number of Impacts	Peak Negative Sound Pressure (Pa) During 95 th Percentile Pulse Duration										
					Minimum	5th	10th	25th	50th (Median)	Average	st dev	75th	90th	95th	Maximum
235	2nd	3rd	H1	86	-10311	-9913	-9827	-9503	-8804	-8189	1596	-6818	-5492	-5338	-4824
235	2nd	3rd	H2	86	-9608	-9320	-9160	-8792	-8240	-7879	1152	-6898	-6311	-5906	-4898
235	2nd	3rd	H3	86	-4909	-4677	-4494	-4060	-3658	-3797	444	-3457	-3300	-3239	-3171
235	Last	3rd	H1	86	-15210	-14872	-14237	-9208	-7748	-8802	2708	-7219	-6278	-6059	-5816
235	Last	3rd	H2	86	-9610	-9249	-8392	-7705	-7015	-6873	1228	-5701	-5194	-5126	-5000
235	Last	3rd	H3	86	-4062	-3951	-3816	-3550	-3430	-3457	250	-3306	-3219	-3198	-2351
237	1st	3rd	H1	122	-9687	-8626	-8465	-7729	-7109	-6715	1721	-6270	-3378	-2724	-1371
237	1st	3rd	H2	122	-8752	-7511	-6580	-5582	-4956	-4910	1451	-4428	-2753	-2025	-1181
237	1st	3rd	H3	121	-4223	-3847	-3660	-3258	-2953	-2785	799	-2438	-1419	-986	-620
237	2nd	3rd	H1	123	-10467	-9182	-8679	-7438	-6985	-7169	907	-6562	-6286	-5992	-5778
237	2nd	3rd	H2	123	-9340	-9207	-9044	-8747	-7482	-7856	819	-7149	-7032	-6964	-6711
237	2nd	3rd	H3	122	-4347	-4047	-3976	-3895	-3751	-3686	280	-3449	-3257	-3189	-3040
237	Last	3rd	H1	123	-9261	-8943	-8733	-8334	-7856	-7890	757	-7465	-7266	-7036	-2514
237	Last	3rd	H2	123	-8255	-7878	-7745	-7567	-7292	-7283	592	-7129	-6931	-6723	-1989
237	Last	3rd	H3	123	-4487	-4185	-4130	-3984	-3898	-3890	269	-3812	-3729	-3637	-1593
50N	1st	3rd	H1	111	-11820	-10992	-10860	-10372	-9400	-8820	2159	-8250	-5793	-4349	-1080
50N	1st	3rd	H2	111	-10625	-10008	-9623	-8895	-7961	-7705	1764	-6809	-5718	-4222	-1109
50N	1st	3rd	H3	111	-17315	-15673	-14872	-14407	-13342	-12473	3145	-11609	-8679	-4668	-559
50N	2nd	3rd	H1	111	-10902	-10297	-10145	-9802	-9364	-9184	833	-8574	-7927	-7762	-7325
50N	2nd	3rd	H2	111	-11063	-10558	-10409	-10123	-9690	-9756	460	-9448	-9190	-8998	-8854
50N	2nd	3rd	H3	112	-18958	-17216	-16957	-16256	-15398	-15332	1319	-14264	-13575	-13095	-12652
50N	Last	3rd	H1	112	-8388	-8130	-8026	-7765	-7405	-7066	1416	-7029	-6669	-2824	-679
50N	Last	3rd	H2	112	-10836	-10444	-10249	-10053	-9681	-9245	1780	-9295	-8971	-4678	-890
50N	Last	3rd	H3	112	-16052	-15456	-15311	-14732	-13588	-12895	2942	-12199	-11171	-4850	-1035
120N	1st	3rd	H1	50	-14121	-13604	-12500	-11661	-10182	-9879	2463	-8370	-7133	-4997	-2081
120N	1st	3rd	H2	50	-9762	-9631	-8930	-8586	-7588	-7332	1539	-6667	-5038	-4291	-2834
120N	1st	3rd	H3	50	-6633	-6343	-6192	-5904	-4537	-4680	1229	-4048	-3433	-2069	-1324
120N	2nd	3rd	H1	51	-14008	-13823	-13420	-13047	-12325	-12265	980	-11750	-10850	-10354	-10173
120N	2nd	3rd	H2	51	-10365	-9775	-9562	-9334	-8942	-8890	554	-8500	-8205	-8043	-7667
120N	2nd	3rd	H3	50	-7206	-6928	-6564	-6120	-5413	-5529	771	-4854	-4531	-4432	-4350

Table B.3. (continued)

Pile ID	Impact Time Series		Hydrophone	Number of Impacts	Peak Negative Sound Pressure (Pa) During 95 th Percentile Pulse Duration										
					Minimum	5th	10th	25th	50th (Median)	Average	st dev	75th	90th	95th	Maximum
120N	Last	3rd	H1	51	-14557	-14297	-14134	-13801	-13145	-12434	2832	-12682	-11907	-4218	-1789
120N	Last	3rd	H2	51	-10878	-10614	-10126	-9811	-9329	-8882	1997	-8982	-8405	-3356	-1294
120N	Last	3rd	H3	51	-6122	-5828	-5757	-5382	-4774	-4665	945	-4255	-4084	-2379	-1453
240	1st	3rd	H1	98	-17439	-14978	-13526	-11222	-8744	-8773	3471	-6313	-4314	-2967	-1235
240	1st	3rd	H2	99	-13774	-13064	-11906	-9875	-7279	-7413	3241	-4848	-3188	-2280	-775
240	1st	3rd	H3	98	-5677	-5349	-5243	-4361	-3380	-3519	1125	-2856	-2209	-1661	-311
240	2nd	3rd	H1	99	-18330	-17388	-15762	-13939	-11860	-11604	3132	-8296	-7739	-7568	-7208
240	2nd	3rd	H2	99	-13709	-11686	-11304	-10894	-10333	-10456	780	-9961	-9637	-9259	-8507
240	2nd	3rd	H3	99	-6116	-6036	-5957	-5849	-5711	-5699	207	-5563	-5409	-5345	-5111
240	Last	3rd	H1	100	-19667	-17475	-17016	-16294	-15010	-14169	2640	-12049	-10304	-9467	-7891
240	Last	3rd	H2	100	-11571	-11005	-10824	-10067	-9454	-9361	1335	-8850	-8156	-7811	-577
240	Last	3rd	H3	99	-7050	-6804	-6749	-6463	-6256	-6211	518	-6010	-5799	-5684	-2172
182	1st	3rd	H1	15	-5427	-5427	-4950	-3251	-2520	-2724	1423	-1656	-941	-891	-891
182	1st	3rd	H2	15	-4651	-4651	-4495	-4072	-3271	-3070	1161	-2445	-1420	-1033	-1033
182	1st	3rd	H3	15	-2586	-2586	-2567	-2191	-1689	-1677	600	-1213	-802	-778	-778
182	2nd	3rd	H1	15	-8693	-8693	-8622	-8092	-7504	-7420	1071	-7176	-6054	-4557	-4557
182	2nd	3rd	H2	15	-9563	-9563	-9557	-9363	-8110	-7642	2095	-5886	-4010	-3711	-3711
182	2nd	3rd	H3	15	-3461	-3461	-3363	-2890	-2680	-2692	417	-2499	-2074	-2018	-2018
182	Last	3rd	H1	16	-8301	-8301	-8241	-7464	-7287	-7389	434	-7053	-6978	-6931	-6931
182	Last	3rd	H2	16	-9557	-9557	-9174	-8998	-8596	-8557	591	-8160	-8072	-7092	-7092
182	Last	3rd	H3	16	-3543	-3543	-3308	-3181	-3074	-3071	231	-2964	-2773	-2555	-2555
177	1st	3rd	H1	9	-3116	-3116	-3116	-2478	-2167	-1880	926	-1209	-455	-455	-455
177	1st	3rd	H2	8	-5290	-5290	-5290	-2864	-2099	-2527	1316	-2031	-936	-936	-936
177	1st	3rd	H3	6	-1618	-1618	-1618	-1120	-1051	-1127	251	-1000	-922	-922	-922
177	2nd	3rd	H1	9	-6845	-6845	-6845	-2873	-2447	-2969	1980	-1707	-1247	-1247	-1247
177	2nd	3rd	H2	9	-4607	-4607	-4607	-1996	-1828	-2074	1109	-1301	-1002	-1002	-1002
177	2nd	3rd	H3	7	-1549	-1549	-1549	-1490	-779	-998	446	-596	-530	-530	-530
177	Last	3rd	H1	10	-3862	-3862	-3626	-2971	-2617	-2697	602	-2097	-2050	-2035	-2035
177	Last	3rd	H2	9	-2436	-2436	-2436	-2340	-2245	-2179	222	-1938	-1869	-1869	-1869
177	Last	3rd	H3	8	-899	-899	-899	-846	-772	-774	95	-714	-625	-625	-625

B.19

Table B.3. (continued)

Pile ID	Impact Time Series		Hydrophone	Number of Impacts	Peak Negative Sound Pressure (Pa) During 95 th Percentile Pulse Duration										
					Minimum	5th	10th	25th	50th (Median)	Average	st dev	75th	90th	95th	Maximum
174	1st	3rd	H1	17	-5290	-5290	-5158	-3096	-2560	-2830	1213	-2464	-1101	-382	-382
174	1st	3rd	H2	17	-6418	-6418	-4839	-4092	-3499	-3638	1053	-3229	-2654	-1483	-1483
174	1st	3rd	H3	16	-2127	-2127	-2057	-1782	-1452	-1542	315	-1300	-1205	-1049	-1049
174	2nd	3rd	H1	18	-2227	-2227	-2199	-2097	-1684	-1619	446	-1286	-855	-762	-762
174	2nd	3rd	H2	18	-4694	-4694	-4600	-4092	-3915	-3613	912	-3103	-2000	-1594	-1594
174	2nd	3rd	H3	17	-1646	-1646	-1418	-1158	-974	-1038	265	-899	-757	-590	-590
174	Last	3rd	H1	19	-4108	-4108	-4068	-3747	-3186	-3161	691	-2615	-1912	-1841	-1841
174	Last	3rd	H2	18	-7148	-7148	-6836	-6306	-5571	-5438	1214	-4943	-4262	-1815	-1815
174	Last	3rd	H3	17	-1899	-1899	-1834	-1704	-1459	-1415	321	-1159	-959	-928	-928
181	1st	3rd	H1	16	-5630	-5630	-5135	-3964	-3231	-2988	1475	-1731	-1041	-824	-824
181	1st	3rd	H2	15	-3843	-3843	-3635	-2927	-2253	-2247	925	-1474	-965	-953	-953
181	1st	3rd	H3	14	-1991	-1991	-1723	-1463	-1179	-1220	402	-974	-800	-417	-417
181	2nd	3rd	H1	16	-4628	-4628	-4146	-3967	-3550	-3505	716	-3350	-2756	-1474	-1474
181	2nd	3rd	H2	16	-3127	-3127	-3014	-2746	-2521	-2443	458	-2083	-1746	-1519	-1519
181	2nd	3rd	H3	15	-1263	-1263	-1204	-1164	-1047	-1043	138	-935	-819	-818	-818
181	Last	3rd	H1	17	-6580	-6580	-6374	-6023	-5606	-5324	1159	-5313	-4052	-1848	-1848
181	Last	3rd	H2	16	-5179	-5179	-5155	-4710	-4451	-4086	1101	-3609	-3054	-677	-677
181	Last	3rd	H3	16	-1917	-1917	-1656	-1475	-1326	-1384	194	-1269	-1207	-1151	-1151
167	1st	3rd	H1	33	-15405	-14637	-14306	-6304	-4404	-5626	3908	-2997	-2064	-1625	-824
167	1st	3rd	H2	32	-7628	-7219	-5659	-4499	-2356	-3054	1904	-1647	-1244	-989	-912
167	1st	3rd	H3	21	-11165	-2540	-1995	-1633	-1455	-1779	2211	-925	-810	-784	-298
167	2nd	3rd	H1	34	-8643	-7071	-6633	-6121	-5673	-5700	883	-5164	-4735	-4463	-3835
167	2nd	3rd	H2	33	-3069	-2538	-2456	-2301	-1795	-1907	419	-1569	-1434	-1426	-1416
167	2nd	3rd	H3	22	-1182	-1150	-1139	-1097	-974	-882	254	-667	-480	-477	-372
167	Last	3rd	H1	35	-7960	-7730	-7591	-7293	-6768	-6687	725	-5965	-5629	-5499	-5444
167	Last	3rd	H2	34	-2548	-2362	-2309	-2188	-2051	-1988	269	-1711	-1597	-1569	-1566
167	Last	3rd	H3	23	-1460	-1377	-1342	-1293	-1187	-1050	302	-710	-629	-626	-523
178	1st	3rd	H1	17	-10270	-10270	-7064	-6257	-4576	-4385	2712	-1997	-503	-488	-488
178	1st	3rd	H2	17	-8584	-8584	-8009	-6042	-3916	-4312	2413	-2832	-1210	-504	-504
178	1st	3rd	H3	16	-2843	-2843	-2729	-2324	-1599	-1702	679	-1192	-788	-673	-673

Table B.3. (continued)

Pile ID	Impact Time Series		Hydrophone	Number of Impacts	Peak Negative Sound Pressure (Pa) During 95 th Percentile Pulse Duration										
					Minimum	5th	10th	25th	50th (Median)	Average	st dev	75th	90th	95th	Maximum
178	2nd	3rd	H1	18	-8573	-8573	-8560	-8105	-7729	-7451	1098	-7351	-5159	-4747	-4747
178	2nd	3rd	H2	17	-10527	-10527	-10441	-10014	-9463	-8625	2147	-8796	-4914	-3961	-3961
178	2nd	3rd	H3	17	-2773	-2773	-2698	-2507	-2326	-2323	281	-2151	-1913	-1764	-1764
178	Last	3rd	H1	18	-9884	-9884	-9306	-8454	-8096	-8216	612	-7835	-7495	-7455	-7455
178	Last	3rd	H2	18	-12239	-12239	-11517	-11022	-10571	-10579	713	-9959	-9764	-9554	-9554
178	Last	3rd	H3	17	-3314	-3314	-3201	-2940	-2524	-2659	351	-2443	-2241	-2237	-2237
244	1st	3rd	H1	17	-7040	-7040	-6597	-5139	-4297	-3967	2069	-2739	-817	-797	-797
244	1st	3rd	H2	16	-5235	-5235	-4701	-3274	-2825	-2917	1145	-2321	-1775	-648	-648
244	1st	3rd	H3	16	-3725	-3725	-2798	-2337	-2106	-2089	646	-1640	-1319	-1091	-1091
244	2nd	3rd	H1	18	-13941	-13941	-8696	-5801	-4700	-5326	2663	-3994	-3147	-1182	-1182
244	2nd	3rd	H2	17	-5475	-5475	-3345	-2693	-2523	-2593	895	-2340	-1825	-971	-971
244	2nd	3rd	H3	16	-3850	-3850	-1938	-1645	-1526	-1587	665	-1265	-1198	-724	-724
244	Last	3rd	H1	19	-14557	-14557	-6048	-5223	-4980	-5422	2257	-4585	-4394	-4290	-4290
244	Last	3rd	H2	18	-6250	-6250	-3340	-3143	-2905	-3008	880	-2586	-2291	-2170	-2170
244	Last	3rd	H3	17	-4693	-4693	-2334	-1739	-1597	-1788	792	-1398	-1327	-1239	-1239

Table B.4. Distribution Statistics for the 95th Percentile Sound Durations (Seconds) of Strikes Within a Series on the Indicated Pile

Pile ID	Impact Time Series		Hydrophone	Number of Impacts	95 th Percentile Sound Duration of Strikes Within a Series (seconds)										
					Minimum	5th	10th	25th	50th (Median)	Average	st dev	75th	90th	95th	Maximum
121N	1st	3rd	H1	98	0.0312	0.0338	0.0375	0.0460	0.0546	0.0553	0.0151	0.0615	0.0718	0.0866	0.1348
121N	1st	3rd	H2	98	0.0336	0.0351	0.0385	0.0474	0.0517	0.0507	0.0080	0.0559	0.0600	0.0611	0.0737
121N	1st	3rd	H3	97	0.0401	0.0441	0.0467	0.0504	0.0595	0.0594	0.0121	0.0652	0.0747	0.0825	0.1104
121N	2nd	3rd	H1	99	0.0540	0.0556	0.0590	0.0669	0.0741	0.0796	0.0218	0.0858	0.1015	0.1312	0.1606
121N	2nd	3rd	H2	99	0.0549	0.0595	0.0619	0.0735	0.0861	0.0845	0.0178	0.0942	0.1002	0.1171	0.1592
121N	2nd	3rd	H3	98	0.0645	0.0684	0.0734	0.0886	0.1212	0.1157	0.0286	0.1409	0.1529	0.1554	0.1642
121N	Last	3rd	H1	99	0.0492	0.0511	0.0544	0.0574	0.0603	0.0650	0.0345	0.0633	0.0714	0.0812	0.3936
121N	Last	3rd	H2	99	0.0485	0.0502	0.0542	0.0572	0.0591	0.0661	0.0466	0.0617	0.0734	0.0910	0.5132
121N	Last	3rd	H3	99	0.0518	0.0525	0.0539	0.0587	0.0617	0.0747	0.0493	0.0743	0.1060	0.1307	0.5121
52N	1st	3rd	H1	35	0.0492	0.0497	0.0513	0.0549	0.0576	0.0656	0.0201	0.0735	0.0849	0.1187	0.1466
52N	1st	3rd	H2	35	0.0548	0.0548	0.0620	0.0631	0.0726	0.0762	0.0197	0.0806	0.0930	0.1264	0.1487
52N	1st	3rd	H3	35	0.0497	0.0499	0.0524	0.0555	0.0606	0.0682	0.0212	0.0749	0.0854	0.1282	0.1509
52N	2nd	3rd	H1	36	0.0410	0.0425	0.0454	0.0488	0.0564	0.0554	0.0083	0.0606	0.0617	0.0701	0.0820
52N	2nd	3rd	H2	36	0.0329	0.0353	0.0367	0.0404	0.0553	0.0520	0.0122	0.0598	0.0631	0.0715	0.0862
52N	2nd	3rd	H3	36	0.0467	0.0527	0.0546	0.0601	0.0617	0.0633	0.0071	0.0680	0.0725	0.0726	0.0848
52N	Last	3rd	H1	36	0.0406	0.0441	0.0464	0.0507	0.0559	0.0573	0.0121	0.0592	0.0709	0.0929	0.0985
52N	Last	3rd	H2	36	0.0295	0.0309	0.0326	0.0371	0.0429	0.0434	0.0084	0.0475	0.0540	0.0627	0.0662
52N	Last	3rd	H3	36	0.0519	0.0586	0.0593	0.0606	0.0627	0.0680	0.0141	0.0684	0.1016	0.1037	0.1114
118N	1st	3rd	H1	67	0.0355	0.0376	0.0418	0.0455	0.0479	0.0506	0.0138	0.0538	0.0587	0.0606	0.1491
118N	1st	3rd	H2	67	0.0611	0.0646	0.0685	0.0757	0.0773	0.0836	0.0186	0.0827	0.1176	0.1244	0.1612
118N	1st	3rd	H3	66	0.0640	0.0840	0.1094	0.1273	0.1475	0.1417	0.0401	0.1528	0.1581	0.1618	0.3981
118N	2nd	3rd	H1	68	0.0491	0.0576	0.0590	0.0641	0.0655	0.0683	0.0088	0.0710	0.0836	0.0867	0.0972
118N	2nd	3rd	H2	67	0.0698	0.0744	0.0757	0.0793	0.0807	0.0807	0.0040	0.0825	0.0865	0.0879	0.0923
118N	2nd	3rd	H3	67	0.0866	0.0924	0.0990	0.1134	0.1334	0.1319	0.0226	0.1508	0.1573	0.1606	0.1757
118N	Last	3rd	H1	68	0.0374	0.0604	0.0610	0.0626	0.0651	0.0783	0.0792	0.0720	0.0865	0.0890	0.7152
118N	Last	3rd	H2	68	0.0507	0.0710	0.0728	0.0767	0.0819	0.0810	0.0076	0.0853	0.0881	0.0885	0.1093
118N	Last	3rd	H3	67	0.0687	0.0899	0.0948	0.0996	0.1058	0.1092	0.0146	0.1191	0.1298	0.1309	0.1499

Table B.4. (continued)

Pile ID	Impact Time Series		Hydrophone	Number of Impacts	95 th Percentile Sound Duration of Strikes Within a Series (seconds)										
					Minimum	5 th	10 th	25 th	50 th (Median)	Average	st dev	75 th	90 th	95 th	Maximum
255	1 st	3 rd	H1	77	0.0248	0.0261	0.0269	0.0272	0.0293	0.0316	0.0058	0.0354	0.0385	0.0427	0.0522
255	1 st	3 rd	H2	77	0.0252	0.0269	0.0270	0.0277	0.0304	0.0314	0.0045	0.0334	0.0356	0.0383	0.0544
255	1 st	3 rd	H3	77	0.0391	0.0448	0.0514	0.0553	0.0710	0.1436	0.1471	0.1827	0.3599	0.4526	0.7628
255	2 nd	3 rd	H1	78	0.0259	0.0264	0.0268	0.0278	0.0303	0.0320	0.0056	0.0348	0.0417	0.0432	0.0474
255	2 nd	3 rd	H2	78	0.0272	0.0299	0.0300	0.0303	0.0318	0.0347	0.0061	0.0374	0.0455	0.0474	0.0524
255	2 nd	3 rd	H3	78	0.0481	0.0542	0.0557	0.0771	0.1029	0.2206	0.2204	0.3299	0.6556	0.7243	0.7908
255	Last	3 rd	H1	79	0.0375	0.0396	0.0411	0.0445	0.0454	0.0472	0.0060	0.0497	0.0551	0.0559	0.0780
255	Last	3 rd	H2	79	0.0301	0.0317	0.0330	0.0376	0.0464	0.0451	0.0086	0.0506	0.0554	0.0562	0.0795
255	Last	3 rd	H3	79	0.0529	0.0547	0.0557	0.0691	0.1021	0.1744	0.1541	0.2106	0.4405	0.5396	0.6623
249	1 st	3 rd	H1	168	0.0227	0.0306	0.0327	0.0347	0.0375	0.0412	0.0185	0.0406	0.0456	0.0624	0.1962
249	1 st	3 rd	H2	168	0.0210	0.0232	0.0241	0.0268	0.0305	0.0318	0.0143	0.0331	0.0370	0.0420	0.1938
249	1 st	3 rd	H3	168	0.0391	0.0479	0.0520	0.0772	0.2159	0.2935	0.2251	0.4897	0.6157	0.6730	0.7803
249	2 nd	3 rd	H1	168	0.0216	0.0320	0.0336	0.0390	0.0412	0.0412	0.0077	0.0434	0.0454	0.0483	0.1050
249	2 nd	3 rd	H2	168	0.0252	0.0275	0.0282	0.0303	0.0329	0.0358	0.0154	0.0375	0.0435	0.0473	0.2048
249	2 nd	3 rd	H3	168	0.0432	0.0443	0.0450	0.0492	0.0627	0.1395	0.1511	0.1432	0.3993	0.4933	0.6845
249	Last	3 rd	H1	170	0.0242	0.0285	0.0293	0.0325	0.0404	0.0396	0.0086	0.0452	0.0494	0.0518	0.0949
249	Last	3 rd	H2	170	0.0270	0.0277	0.0283	0.0296	0.0307	0.0316	0.0068	0.0321	0.0336	0.0364	0.1120
249	Last	3 rd	H3	169	0.0442	0.0466	0.0475	0.0530	0.0730	0.1710	0.1813	0.2236	0.4915	0.5925	0.7538
252	1 st	3 rd	H1	85	0.0309	0.0341	0.0367	0.0395	0.0419	0.0482	0.0229	0.0479	0.0634	0.0684	0.2167
252	1 st	3 rd	H2	85	0.0309	0.0341	0.0367	0.0395	0.0419	0.0482	0.0229	0.0479	0.0634	0.0684	0.2167
252	1 st	3 rd	H3	84	0.0277	0.0335	0.0339	0.0370	0.0406	0.0446	0.0236	0.0450	0.0511	0.0625	0.2373
252	2 nd	3 rd	H1	85	0.0475	0.0529	0.0652	0.1222	0.2590	0.3203	0.2249	0.5291	0.6492	0.6775	0.7563
252	2 nd	3 rd	H2	85	0.0188	0.0204	0.0206	0.0212	0.0240	0.0272	0.0075	0.0307	0.0405	0.0427	0.0462
252	2 nd	3 rd	H3	84	0.0188	0.0204	0.0206	0.0212	0.0240	0.0272	0.0075	0.0307	0.0405	0.0427	0.0462
252	Last	3 rd	H1	86	0.0249	0.0253	0.0278	0.0317	0.0357	0.0360	0.0062	0.0395	0.0447	0.0486	0.0525
252	Last	3 rd	H2	86	0.0471	0.0520	0.0582	0.1004	0.1584	0.2469	0.1953	0.3887	0.5817	0.6294	0.7225
252	Last	3 rd	H3	85	0.0229	0.0234	0.0240	0.0256	0.0270	0.0267	0.0018	0.0281	0.0286	0.0293	0.0306
172	1 st	3 rd	H1	64	0.0229	0.0234	0.0240	0.0256	0.0270	0.0267	0.0018	0.0281	0.0286	0.0293	0.0306
172	1 st	3 rd	H2	64	0.0254	0.0262	0.0264	0.0276	0.0294	0.0293	0.0019	0.0313	0.0318	0.0320	0.0329
172	1 st	3 rd	H3	62	0.0411	0.0443	0.0495	0.0649	0.1039	0.1505	0.1286	0.1652	0.3410	0.4650	0.6369

Table B.4. (continued)

Pile ID	Impact Time Series		Hydrophone	Number of Impacts	95 th Percentile Sound Duration of Strikes Within a Series (seconds)										
					Minimum	5th	10th	25th	50th (Median)	Average	st dev	75th	90th	95th	Maximum
172	2 nd	3 rd	H1	65	0.0221	0.0291	0.0317	0.0385	0.0545	0.0900	0.1222	0.0934	0.1188	0.2139	0.7473
172	2 nd	3 rd	H2	65	0.0199	0.0229	0.0239	0.0275	0.0329	0.0462	0.0433	0.0407	0.0685	0.1604	0.2566
172	2 nd	3 rd	H3	63	0.0257	0.0266	0.0275	0.0314	0.0427	0.0667	0.0915	0.0622	0.1144	0.1328	0.6474
172	Last	3 rd	H1	65	0.0215	0.0226	0.0227	0.0230	0.0235	0.0244	0.0019	0.0262	0.0264	0.0270	0.0318
172	Last	3 rd	H2	65	0.0170	0.0174	0.0175	0.0182	0.0192	0.0198	0.0021	0.0211	0.0226	0.0232	0.0276
172	Last	3 rd	H3	63	0.0333	0.0360	0.0362	0.0364	0.0373	0.0385	0.0031	0.0404	0.0439	0.0441	0.0484
171	1st	3rd	H1	134	0.0187	0.0223	0.0227	0.0241	0.0247	0.0248	0.0015	0.0262	0.0266	0.0268	0.0268
171	1st	3rd	H2	134	0.0110	0.0122	0.0131	0.0135	0.0175	0.0170	0.0035	0.0205	0.0213	0.0214	0.0225
171	1st	3rd	H3	132	0.0330	0.0336	0.0339	0.0392	0.0437	0.0418	0.0039	0.0443	0.0447	0.0460	0.0463
171	2nd	3rd	H1	135	0.0227	0.0248	0.0266	0.0275	0.0347	0.0363	0.0119	0.0415	0.0470	0.0553	0.0978
171	2nd	3rd	H2	135	0.0168	0.0187	0.0193	0.0202	0.0242	0.0288	0.0129	0.0306	0.0457	0.0497	0.0926
171	2nd	3rd	H3	132	0.0245	0.0256	0.0261	0.0315	0.0347	0.0370	0.0103	0.0379	0.0504	0.0583	0.0766
171	Last	3rd	H1	136	0.0199	0.0224	0.0239	0.0244	0.0280	0.0354	0.0151	0.0465	0.0503	0.0587	0.1274
171	Last	3rd	H2	136	0.0144	0.0146	0.0148	0.0161	0.0190	0.0195	0.0075	0.0214	0.0240	0.0254	0.0950
171	Last	3rd	H3	133	0.0165	0.0283	0.0292	0.0320	0.0344	0.0339	0.0039	0.0361	0.0380	0.0401	0.0478
238	1st	3rd	H1	72	0.0174	0.0182	0.0207	0.0234	0.0248	0.0252	0.0054	0.0261	0.0298	0.0313	0.0706
238	1st	3rd	H2	71	0.0116	0.0134	0.0144	0.0149	0.0180	0.0178	0.0053	0.0190	0.0198	0.0231	0.0696
238	1st	3rd	H3	67	0.0128	0.0157	0.0158	0.0164	0.0196	0.0243	0.0097	0.0332	0.0354	0.0368	0.0708
238	2nd	3rd	H1	73	0.0215	0.0241	0.0261	0.0433	0.0488	0.0748	0.0866	0.0604	0.1035	0.2473	0.5456
238	2nd	3rd	H2	72	0.0176	0.0181	0.0184	0.0253	0.0584	0.1045	0.1259	0.1096	0.2460	0.4104	0.5751
238	2nd	3rd	H3	68	0.0178	0.0199	0.0213	0.0273	0.0413	0.1355	0.1796	0.1673	0.4447	0.6247	0.7209
238	Last	3rd	H1	73	0.0196	0.0198	0.0201	0.0224	0.0252	0.0271	0.0070	0.0298	0.0385	0.0405	0.0532
238	Last	3rd	H2	73	0.0145	0.0146	0.0151	0.0163	0.0194	0.0208	0.0047	0.0256	0.0270	0.0274	0.0295
238	Last	3rd	H3	69	0.0178	0.0184	0.0191	0.0202	0.0304	0.0284	0.0077	0.0334	0.0360	0.0398	0.0522
235	1st	3rd	H1	85	0.0129	0.0177	0.0195	0.0198	0.0218	0.0213	0.0020	0.0227	0.0236	0.0241	0.0251
235	1st	3rd	H2	85	0.0187	0.0272	0.0274	0.0279	0.0304	0.0296	0.0022	0.0315	0.0316	0.0317	0.0320
235	1st	3rd	H3	85	0.0347	0.0404	0.0433	0.0463	0.0483	0.0475	0.0034	0.0500	0.0505	0.0522	0.0533
235	2nd	3rd	H1	86	0.0220	0.0252	0.0260	0.0279	0.0331	0.0373	0.0272	0.0362	0.0472	0.0581	0.2609
235	2nd	3rd	H2	86	0.0240	0.0268	0.0300	0.0315	0.0360	0.0439	0.0367	0.0419	0.0501	0.0578	0.2539
235	2nd	3rd	H3	86	0.0201	0.0208	0.0217	0.0221	0.0286	0.0487	0.0879	0.0392	0.0578	0.0587	0.5646

Table B.4. (continued)

Pile ID	Impact Time Series		Hydrophone	Number of Impacts	95 th Percentile Sound Duration of Strikes Within a Series (seconds)										
					Minimum	5th	10th	25th	50th (Median)	Average	st dev	75th	90th	95th	Maximum
235	Last	3rd	H1	86	0.0205	0.0234	0.0247	0.0259	0.0283	0.0288	0.0042	0.0306	0.0332	0.0371	0.0482
235	Last	3rd	H2	86	0.0230	0.0233	0.0242	0.0251	0.0271	0.0273	0.0026	0.0294	0.0304	0.0314	0.0353
235	Last	3rd	H3	86	0.0225	0.0244	0.0260	0.0265	0.0280	0.0287	0.0033	0.0302	0.0338	0.0342	0.0412
237	1st	3rd	H1	122	0.0157	0.0248	0.0250	0.0371	0.0410	0.0385	0.0076	0.0419	0.0468	0.0480	0.0595
237	1st	3rd	H2	122	0.0234	0.0300	0.0310	0.0350	0.0392	0.0392	0.0068	0.0422	0.0471	0.0479	0.0652
237	1st	3rd	H3	121	0.0302	0.0303	0.0305	0.0332	0.0384	0.0368	0.0040	0.0397	0.0415	0.0426	0.0444
237	2nd	3rd	H1	123	0.0211	0.0225	0.0229	0.0240	0.0295	0.0329	0.0165	0.0337	0.0426	0.0607	0.1454
237	2nd	3rd	H2	123	0.0240	0.0270	0.0277	0.0295	0.0351	0.0434	0.0451	0.0390	0.0450	0.0685	0.4138
237	2nd	3rd	H3	122	0.0267	0.0282	0.0286	0.0325	0.0410	0.0839	0.1267	0.0569	0.1720	0.4485	0.6471
237	Last	3rd	H1	123	0.0262	0.0283	0.0293	0.0312	0.0373	0.0368	0.0054	0.0396	0.0439	0.0462	0.0496
237	Last	3rd	H2	123	0.0197	0.0210	0.0223	0.0252	0.0287	0.0296	0.0055	0.0338	0.0367	0.0393	0.0438
237	Last	3rd	H3	123	0.0283	0.0314	0.0328	0.0379	0.0397	0.0394	0.0043	0.0420	0.0445	0.0452	0.0499
50N	1st	3rd	H1	111	0.0348	0.0386	0.0396	0.0423	0.0459	0.0478	0.0107	0.0499	0.0539	0.0606	0.1269
50N	1st	3rd	H2	111	0.0365	0.0412	0.0435	0.0453	0.0484	0.0511	0.0117	0.0528	0.0575	0.0699	0.1144
50N	1st	3rd	H3	111	0.0352	0.0365	0.0377	0.0397	0.0447	0.0495	0.0236	0.0514	0.0577	0.0609	0.2434
50N	2nd	3rd	H1	111	0.0400	0.0431	0.0452	0.0468	0.0507	0.0502	0.0043	0.0525	0.0561	0.0574	0.0630
50N	2nd	3rd	H2	111	0.0391	0.0423	0.0438	0.0452	0.0470	0.0476	0.0042	0.0492	0.0519	0.0544	0.0674
50N	2nd	3rd	H3	112	0.0426	0.0457	0.0465	0.0497	0.0526	0.0548	0.0072	0.0592	0.0659	0.0680	0.0792
50N	Last	3rd	H1	112	0.0405	0.0416	0.0428	0.0441	0.0469	0.0606	0.0565	0.0612	0.0650	0.1128	0.6118
50N	Last	3rd	H2	112	0.0414	0.0427	0.0435	0.0453	0.0483	0.0612	0.0481	0.0639	0.0665	0.1139	0.5084
50N	Last	3rd	H3	112	0.0454	0.0481	0.0500	0.0527	0.0601	0.0645	0.0234	0.0674	0.0685	0.1143	0.2439
120N	1st	3rd	H1	50	0.0349	0.0355	0.0364	0.0380	0.0441	0.0516	0.0173	0.0608	0.0719	0.0760	0.1198
120N	1st	3rd	H2	50	0.0330	0.0362	0.0367	0.0391	0.0475	0.0543	0.0191	0.0655	0.0782	0.0945	0.1226
120N	1st	3rd	H3	50	0.0318	0.0334	0.0336	0.0345	0.0404	0.0454	0.0146	0.0518	0.0604	0.0660	0.1187
120N	2nd	3rd	H1	51	0.0353	0.0356	0.0359	0.0363	0.0367	0.0387	0.0032	0.0407	0.0416	0.0467	0.0472
120N	2nd	3rd	H2	51	0.0360	0.0370	0.0380	0.0405	0.0426	0.0435	0.0040	0.0472	0.0484	0.0499	0.0506
120N	2nd	3rd	H3	50	0.0335	0.0340	0.0341	0.0345	0.0373	0.0377	0.0033	0.0399	0.0432	0.0440	0.0445
120N	Last	3rd	H1	51	0.0318	0.0349	0.0354	0.0358	0.0361	0.0372	0.0079	0.0363	0.0364	0.0415	0.0914
120N	Last	3rd	H2	51	0.0361	0.0369	0.0378	0.0392	0.0407	0.0470	0.0270	0.0430	0.0476	0.0760	0.2014
120N	Last	3rd	H3	51	0.0335	0.0340	0.0343	0.0347	0.0352	0.0361	0.0029	0.0364	0.0386	0.0442	0.0488

Table B.4. (continued)

Pile ID	Impact Time Series		Hydrophone	Number of Impacts	95 th Percentile Sound Duration of Strikes Within a Series (seconds)										
					Minimum	5th	10th	25th	50th (Median)	Average	st dev	75th	90th	95th	Maximum
240	1st	3rd	H1	98	0.0230	0.0253	0.0262	0.0284	0.0327	0.0375	0.0167	0.0403	0.0534	0.0604	0.1375
240	1st	3rd	H2	99	0.0230	0.0237	0.0248	0.0264	0.0338	0.0393	0.0318	0.0397	0.0516	0.0619	0.3257
240	1st	3rd	H3	98	0.0240	0.0252	0.0258	0.0271	0.0316	0.0419	0.0728	0.0372	0.0561	0.0612	0.7479
240	2nd	3rd	H1	99	0.0238	0.0245	0.0249	0.0255	0.0278	0.0276	0.0020	0.0293	0.0299	0.0302	0.0332
240	2nd	3rd	H2	99	0.0201	0.0205	0.0207	0.0212	0.0229	0.0238	0.0030	0.0262	0.0281	0.0285	0.0323
240	2nd	3rd	H3	99	0.0221	0.0226	0.0230	0.0244	0.0273	0.0266	0.0024	0.0287	0.0291	0.0295	0.0309
240	Last	3rd	H1	100	0.0235	0.0249	0.0252	0.0261	0.0276	0.0283	0.0026	0.0308	0.0321	0.0327	0.0343
240	Last	3rd	H2	100	0.0259	0.0270	0.0277	0.0293	0.0316	0.0378	0.0695	0.0325	0.0331	0.0341	0.7250
240	Last	3rd	H3	99	0.0260	0.0266	0.0270	0.0280	0.0299	0.0298	0.0021	0.0313	0.0324	0.0337	0.0352
182	1st	3rd	H1	15	0.0426	0.0426	0.0469	0.0577	0.0800	0.0862	0.0441	0.1014	0.1474	0.2076	0.2076
182	1st	3rd	H2	15	0.0395	0.0395	0.0403	0.0410	0.0518	0.0706	0.0424	0.0786	0.1425	0.1841	0.1841
182	1st	3rd	H3	15	0.0300	0.0300	0.0373	0.0416	0.0503	0.0744	0.0437	0.1150	0.1207	0.1811	0.1811
182	2nd	3rd	H1	15	0.0355	0.0355	0.0366	0.0420	0.0462	0.0456	0.0068	0.0489	0.0558	0.0614	0.0614
182	2nd	3rd	H2	15	0.0312	0.0312	0.0312	0.0332	0.0362	0.0375	0.0069	0.0395	0.0421	0.0590	0.0590
182	2nd	3rd	H3	15	0.0314	0.0314	0.0358	0.0427	0.0470	0.0611	0.0365	0.0562	0.1165	0.1644	0.1644
182	Last	3rd	H1	16	0.0365	0.0365	0.0396	0.0423	0.0425	0.0424	0.0021	0.0429	0.0449	0.0458	0.0458
182	Last	3rd	H2	16	0.0292	0.0292	0.0300	0.0310	0.0320	0.0324	0.0021	0.0334	0.0354	0.0369	0.0369
182	Last	3rd	H3	16	0.0461	0.0461	0.0503	0.0516	0.0521	0.0539	0.0047	0.0564	0.0588	0.0669	0.0669
177	1st	3rd	H1	9	0.0514	0.0514	0.0514	0.0667	0.0730	0.2633	0.2837	0.5541	0.7395	0.7395	0.7395
177	1st	3rd	H2	8	0.0352	0.0352	0.0352	0.0453	0.0546	0.0710	0.0565	0.0620	0.2089	0.2089	0.2089
177	1st	3rd	H3	6	0.0820	0.0820	0.0820	0.1394	0.1661	0.2158	0.1247	0.3477	0.3933	0.3933	0.3933
177	2nd	3rd	H1	9	0.0445	0.0445	0.0445	0.0532	0.0881	0.0899	0.0416	0.1184	0.1513	0.1513	0.1513
177	2nd	3rd	H2	9	0.0343	0.0343	0.0343	0.0416	0.0929	0.0757	0.0364	0.1057	0.1188	0.1188	0.1188
177	2nd	3rd	H3	7	0.0556	0.0556	0.0556	0.0643	0.1296	0.1867	0.1302	0.3597	0.3623	0.3623	0.3623
177	Last	3rd	H1	10	0.0350	0.0350	0.0394	0.0788	0.1218	0.1323	0.0725	0.2235	0.2270	0.2301	0.2301
177	Last	3rd	H2	9	0.0495	0.0495	0.0495	0.0752	0.1116	0.1385	0.0771	0.2326	0.2399	0.2399	0.2399
177	Last	3rd	H3	8	0.1319	0.1319	0.1319	0.1739	0.2827	0.3019	0.1467	0.4330	0.5046	0.5046	0.5046
174	1st	3rd	H1	17	0.0484	0.0484	0.0499	0.0607	0.0716	0.1357	0.1742	0.1321	0.3375	0.7540	0.7540
174	1st	3rd	H2	17	0.0311	0.0311	0.0432	0.0498	0.0508	0.0640	0.0337	0.0662	0.0927	0.1792	0.1792
174	1st	3rd	H3	16	0.0377	0.0377	0.0572	0.0613	0.1037	0.2052	0.2034	0.2998	0.5615	0.6599	0.6599

Table B.4. (continued)

Pile ID	Impact Time Series		Hydrophone	Number of Impacts	95 th Percentile Sound Duration of Strikes Within a Series (seconds)										
					Minimum	5th	10th	25th	50th (Median)	Average	st dev	75th	90th	95th	Maximum
174	2nd	3rd	H1	18	0.0645	0.0645	0.1331	0.1435	0.1544	0.1622	0.0475	0.1674	0.2146	0.3041	0.3041
174	2nd	3rd	H2	18	0.0359	0.0359	0.0520	0.0764	0.1383	0.1173	0.0465	0.1451	0.1525	0.2155	0.2155
174	2nd	3rd	H3	17	0.1485	0.1485	0.1562	0.2481	0.4642	0.4623	0.2198	0.6901	0.7491	0.7527	0.7527
174	Last	3rd	H1	19	0.0432	0.0432	0.0462	0.0538	0.0592	0.0756	0.0354	0.0949	0.1361	0.1641	0.1641
174	Last	3rd	H2	18	0.0257	0.0257	0.0280	0.0305	0.0320	0.0437	0.0304	0.0373	0.1164	0.1340	0.1340
174	Last	3rd	H3	17	0.1473	0.1473	0.1479	0.1501	0.1652	0.2722	0.1737	0.4131	0.5887	0.6332	0.6332
181	1st	3rd	H1	16	0.0381	0.0381	0.0447	0.0508	0.0596	0.1063	0.1353	0.0823	0.1961	0.5882	0.5882
181	1st	3rd	H2	15	0.0403	0.0403	0.0438	0.0516	0.0570	0.0734	0.0436	0.0661	0.1534	0.1948	0.1948
181	1st	3rd	H3	14	0.0544	0.0544	0.0581	0.0650	0.0829	0.1208	0.1093	0.1442	0.1541	0.4803	0.4803
181	2nd	3rd	H1	16	0.0510	0.0510	0.0535	0.0669	0.1064	0.0998	0.0373	0.1246	0.1328	0.1825	0.1825
181	2nd	3rd	H2	16	0.0596	0.0596	0.0614	0.0690	0.1163	0.0994	0.0303	0.1266	0.1308	0.1314	0.1314
181	2nd	3rd	H3	15	0.1269	0.1269	0.1282	0.1296	0.1351	0.1549	0.0327	0.1935	0.2036	0.2126	0.2126
181	Last	3rd	H1	17	0.0301	0.0301	0.0305	0.0312	0.0314	0.0372	0.0079	0.0431	0.0491	0.0501	0.0501
181	Last	3rd	H2	16	0.0301	0.0301	0.0311	0.0341	0.0401	0.0439	0.0165	0.0501	0.0530	0.0987	0.0987
181	Last	3rd	H3	16	0.0617	0.0617	0.0625	0.0715	0.0837	0.0960	0.0314	0.1354	0.1390	0.1448	0.1448
167	1st	3rd	H1	33	0.0333	0.0344	0.0408	0.0563	0.1377	0.1165	0.0571	0.1507	0.1801	0.1980	0.2707
167	1st	3rd	H2	32	0.0341	0.0358	0.0404	0.0550	0.1825	0.1572	0.1021	0.2203	0.3039	0.3119	0.3375
167	1st	3rd	H3	21	0.0278	0.0350	0.0352	0.0384	0.0436	0.1430	0.2153	0.0830	0.5656	0.6351	0.7025
167	2nd	3rd	H1	34	0.0329	0.0335	0.0399	0.0752	0.0806	0.0771	0.0199	0.0856	0.1003	0.1072	0.1115
167	2nd	3rd	H2	33	0.0410	0.0412	0.0505	0.0745	0.1344	0.1288	0.0601	0.1771	0.2092	0.2116	0.2242
167	2nd	3rd	H3	22	0.0324	0.0341	0.0343	0.0360	0.0370	0.0465	0.0237	0.0475	0.0714	0.0792	0.1382
167	Last	3rd	H1	35	0.0228	0.0247	0.0262	0.0334	0.0385	0.0414	0.0129	0.0491	0.0585	0.0685	0.0723
167	Last	3rd	H2	34	0.0402	0.0417	0.0494	0.0567	0.0812	0.0847	0.0334	0.1075	0.1253	0.1543	0.1745
167	Last	3rd	H3	23	0.0304	0.0304	0.0326	0.0336	0.0376	0.0397	0.0127	0.0402	0.0425	0.0513	0.0941
178	1st	3rd	H1	17	0.0559	0.0559	0.0585	0.1303	0.1861	0.2683	0.2391	0.2563	0.7227	0.7436	0.7436
178	1st	3rd	H2	17	0.0294	0.0294	0.0317	0.0379	0.0464	0.0805	0.1125	0.0574	0.1428	0.5012	0.5012
178	1st	3rd	H3	16	0.0461	0.0461	0.0472	0.0551	0.1280	0.1708	0.1623	0.1852	0.4325	0.6394	0.6394
178	2nd	3rd	H1	18	0.0353	0.0353	0.0419	0.0510	0.0702	0.1111	0.0747	0.1686	0.2439	0.2483	0.2483
178	2nd	3rd	H2	17	0.0216	0.0216	0.0217	0.0252	0.0267	0.0319	0.0167	0.0293	0.0439	0.0925	0.0925
178	2nd	3rd	H3	17	0.0489	0.0489	0.0559	0.0565	0.0592	0.0779	0.0327	0.1020	0.1273	0.1603	0.1603

Table B.4. (continued)

Pile ID	Impact Time Series		Hydrophone	Number of Impacts	95 th Percentile Sound Duration of Strikes Within a Series (seconds)										
					Minimum	5th	10th	25th	50th (Median)	Average	st dev	75th	90th	95th	Maximum
178	Last	3rd	H1	18	0.0369	0.0369	0.0408	0.0460	0.0685	0.0907	0.0488	0.1499	0.1579	0.1580	0.1580
178	Last	3rd	H2	18	0.0181	0.0181	0.0185	0.0196	0.0222	0.0226	0.0034	0.0255	0.0266	0.0296	0.0296
178	Last	3rd	H3	17	0.0571	0.0571	0.0572	0.0586	0.0657	0.0772	0.0252	0.0906	0.1200	0.1357	0.1357
244	1st	3rd	H1	17	0.0421	0.0421	0.0477	0.0488	0.0607	0.1825	0.2300	0.1810	0.6242	0.7499	0.7499
244	1st	3rd	H2	16	0.0331	0.0331	0.0342	0.0429	0.0516	0.1032	0.1781	0.0678	0.1817	0.7580	0.7580
244	1st	3rd	H3	16	0.0354	0.0354	0.0365	0.0435	0.0549	0.0623	0.0336	0.0657	0.0782	0.1781	0.1781
244	2nd	3rd	H1	18	0.0321	0.0321	0.0332	0.0399	0.0413	0.0893	0.0868	0.1461	0.1629	0.3727	0.3727
244	2nd	3rd	H2	17	0.0329	0.0329	0.0330	0.0350	0.0395	0.0850	0.1325	0.0597	0.1541	0.5805	0.5805
244	2nd	3rd	H3	16	0.0309	0.0309	0.0326	0.0336	0.0403	0.0564	0.0390	0.0514	0.1289	0.1594	0.1594
244	Last	3rd	H1	19	0.0225	0.0225	0.0265	0.0298	0.0320	0.0335	0.0087	0.0350	0.0397	0.0657	0.0657
244	Last	3rd	H2	18	0.0216	0.0216	0.0251	0.0268	0.0291	0.0404	0.0375	0.0373	0.0481	0.1876	0.1876
244	Last	3rd	H3	17	0.0290	0.0290	0.0299	0.0305	0.0319	0.0334	0.0038	0.0383	0.0386	0.0401	0.0401

Table B.5. Distribution Statistics for the Average Sound Pressure Level Measured During the 95th Percentile Pulse Duration in Each Strike in a Series on the Indicated Pile

Pile ID	Impact Time Series		Hydrophone	Number of Impacts	Average Sound Pressure Level (Pa)										
					Minimum	5th	10th	25th	50th (Median)	Average	st dev	75th	90th	95th	Maximum
121N	1st	3rd	H1	98	491	829	1045	1248	1462	1574	463	1912	2198	2402	2707
121N	1st	3rd	H2	98	828	994	1072	1131	1233	1277	215	1381	1659	1720	1816
121N	1st	3rd	H3	97	315	429	456	533	624	636	132	754	795	835	893
121N	2nd	3rd	H1	99	437	561	636	757	818	865	205	1011	1173	1231	1370
121N	2nd	3rd	H2	99	329	409	443	473	522	590	173	656	891	968	1100
121N	2nd	3rd	H3	98	154	162	167	179	209	259	101	344	410	476	510
121N	Last	3rd	H1	99	32	634	782	1297	1399	1370	351	1603	1759	1809	1973
121N	Last	3rd	H2	99	17	482	522	983	1038	997	239	1132	1222	1267	1365
121N	Last	3rd	H3	99	15	180	186	495	563	522	159	629	673	689	742
52N	1st	3rd	H1	35	484	718	1080	1266	1399	1341	245	1503	1575	1639	1679
52N	1st	3rd	H2	35	663	667	959	1099	1224	1218	229	1390	1504	1566	1645
52N	1st	3rd	H3	35	272	405	571	650	793	747	150	852	890	904	935
52N	2nd	3rd	H1	36	1136	1266	1360	1392	1546	1556	190	1668	1833	1909	1962
52N	2nd	3rd	H2	36	1073	1268	1339	1491	1722	1877	458	2379	2476	2502	2682
52N	2nd	3rd	H3	36	641	648	703	744	791	790	77	826	902	912	984
52N	Last	3rd	H1	36	209	290	443	1433	1560	1434	449	1696	1782	1903	2072
52N	Last	3rd	H2	36	468	523	1140	2037	2328	2206	636	2593	2852	3027	3259
52N	Last	3rd	H3	36	128	151	229	780	840	742	233	866	878	896	969
118N	1st	3rd	H1	67	344	1063	1223	1324	1527	1507	263	1666	1767	1932	2053
118N	1st	3rd	H2	67	227	379	408	563	710	665	165	779	850	869	943
118N	1st	3rd	H3	66	30	162	174	187	203	208	47	222	250	290	390
118N	2nd	3rd	H1	68	818	880	904	1030	1127	1132	154	1216	1354	1407	1496
118N	2nd	3rd	H2	67	645	653	668	717	756	757	61	802	845	856	890
118N	2nd	3rd	H3	67	199	208	215	233	250	261	41	287	308	353	385
118N	Last	3rd	H1	68	33	737	908	1036	1140	1108	244	1240	1306	1352	1792
118N	Last	3rd	H2	68	214	694	710	742	772	762	111	803	833	848	1046
118N	Last	3rd	H3	67	155	238	247	267	284	287	34	307	334	337	366

Table B.5. (continued)

Pile ID	Impact Time Series		Hydrophone	Number of Impacts	Average Sound Pressure Level (Pa)										
					Minimum	5th	10th	25th	50th (Median)	Average	st dev	75th	90th	95th	Maximum
255	1st	3rd	H1	77	1280	1344	1430	1617	1839	1799	242	2003	2068	2146	2226
255	1st	3rd	H2	77	1196	1276	1340	1500	1565	1557	138	1669	1709	1741	1843
255	1st	3rd	H3	77	40	104	120	223	353	404	456	405	509	1172	3327
255	2nd	3rd	H1	78	1045	1105	1145	1336	1624	1559	254	1768	1815	1833	1859
255	2nd	3rd	H2	78	814	840	884	1071	1299	1242	229	1442	1497	1520	1662
255	2nd	3rd	H3	78	47	57	75	141	201	254	344	258	341	661	2875
255	Last	3rd	H1	79	256	797	829	903	975	963	129	1038	1097	1137	1170
255	Last	3rd	H2	79	217	715	730	754	823	858	147	985	1072	1114	1158
255	Last	3rd	H3	79	58	68	74	113	192	196	91	280	331	358	360
249	1st	3rd	H1	168	233	566	895	1229	1378	1324	317	1529	1647	1719	1957
249	1st	3rd	H2	168	169	682	913	1127	1384	1416	445	1721	2017	2207	2470
249	1st	3rd	H3	168	38	61	69	83	120	170	110	260	352	380	449
249	2nd	3rd	H1	168	179	1072	1100	1174	1233	1299	240	1359	1690	1847	1966
249	2nd	3rd	H2	168	91	1049	1092	1179	1273	1299	216	1444	1561	1652	1750
249	2nd	3rd	H3	168	79	91	108	199	377	323	137	435	471	492	550
249	Last	3rd	H1	170	349	967	1001	1084	1222	1285	260	1468	1683	1716	1964
249	Last	3rd	H2	170	249	1147	1208	1297	1367	1362	150	1436	1522	1560	1705
249	Last	3rd	H3	169	59	85	97	143	337	295	139	418	445	465	515
252	1st	3rd	H1	85	85	594	617	896	1215	1150	349	1381	1542	1666	1769
252	1st	3rd	H2	85	85	594	617	896	1215	1150	349	1381	1542	1666	1769
252	1st	3rd	H3	84	55	488	596	862	1034	973	243	1135	1222	1243	1492
252	2nd	3rd	H1	85	18	43	46	56	92	116	74	155	217	284	344
252	2nd	3rd	H2	85	1231	1306	1349	1716	2243	2195	601	2699	3097	3151	3287
252	2nd	3rd	H3	84	1231	1306	1349	1716	2243	2195	601	2699	3097	3151	3287
252	Last	3rd	H1	86	772	831	852	917	1043	1127	285	1249	1569	1836	1955
252	Last	3rd	H2	86	48	55	59	77	116	144	88	183	287	352	389
252	Last	3rd	H3	85	1377	2619	2726	2893	2951	2934	221	3047	3123	3145	3313
172	1st	3rd	H1	64	1377	2619	2726	2893	2951	2934	221	3047	3123	3145	3313
172	1st	3rd	H2	64	766	1736	1751	1827	1910	1907	175	2014	2086	2101	2177
172	1st	3rd	H3	62	61	90	105	183	236	258	117	343	441	468	514

B.30

Table B.5. (continued)

Pile ID	Impact Time Series		Hydrophone	Number of Impacts	Average Sound Pressure Level (Pa)										
					Minimum	5th	10th	25th	50th (Median)	Average	st dev	75th	90th	95th	Maximum
172	2nd	3rd	H1	65	29	60	217	402	910	958	656	1375	1856	2264	2513
172	2nd	3rd	H2	65	41	108	541	892	1654	1486	752	2096	2383	2499	2878
172	2nd	3rd	H3	63	24	67	87	279	572	469	244	656	741	768	800
172	Last	3rd	H1	65	2513	2829	3061	3616	4537	4233	722	4782	4895	4934	5059
172	Last	3rd	H2	65	2584	2862	3159	4589	4821	4538	740	5002	5128	5228	5265
172	Last	3rd	H3	63	611	621	625	695	734	722	55	762	783	789	849
171	1st	3rd	H1	134	2989	4085	4158	4240	4378	4390	273	4582	4648	4756	5010
171	1st	3rd	H2	134	3285	4348	4400	4550	5562	5687	1263	6964	7285	7633	8376
171	1st	3rd	H3	132	306	568	570	585	616	640	88	682	775	821	835
171	2nd	3rd	H1	135	170	433	574	896	1420	1354	559	1890	1996	2125	2344
171	2nd	3rd	H2	135	139	392	444	1054	1655	1698	858	2500	2638	2665	2920
171	2nd	3rd	H3	132	99	133	186	484	653	598	240	761	895	928	977
171	Last	3rd	H1	136	209	964	1102	1188	1682	1578	408	1936	1984	2073	2308
171	Last	3rd	H2	136	197	2051	2176	2391	2632	2609	395	2918	3084	3115	3281
171	Last	3rd	H3	133	479	561	586	611	638	651	74	679	720	741	1159
238	1st	3rd	H1	72	182	1665	1750	1987	2158	2192	456	2383	2759	3032	3635
238	1st	3rd	H2	71	148	1834	2144	2301	2454	2533	543	2779	3168	3407	4653
238	1st	3rd	H3	67	114	578	599	654	1054	974	311	1237	1327	1365	1648
238	2nd	3rd	H1	73	55	87	187	438	530	595	364	672	1277	1505	1630
238	2nd	3rd	H2	72	24	63	80	189	417	658	607	943	1733	1948	2027
238	2nd	3rd	H3	68	25	42	58	102	370	441	370	741	1060	1101	1163
238	Last	3rd	H1	73	556	772	821	1118	1441	1450	433	1863	1996	2077	2203
238	Last	3rd	H2	73	1189	1241	1467	1753	1888	1876	301	2090	2238	2340	2411
238	Last	3rd	H3	69	596	678	737	800	849	905	157	1077	1128	1136	1229
235	1st	3rd	H1	85	1833	1996	2078	2174	2406	2421	281	2656	2822	2841	2887
235	1st	3rd	H2	85	1719	1832	1890	1966	2049	2080	180	2156	2314	2485	2594
235	1st	3rd	H3	85	550	636	654	670	696	702	58	718	773	818	986
235	2nd	3rd	H1	86	207	716	867	1149	1301	1271	326	1470	1622	1710	2048
235	2nd	3rd	H2	86	134	574	756	946	1108	1080	310	1225	1357	1440	1950
235	2nd	3rd	H3	86	35	286	338	633	842	927	424	1340	1393	1441	1638

Table B.5. (continued)

Pile ID	Impact Time Series		Hydrophone	Number of Impacts	Average Sound Pressure Level (Pa)										
					Minimum	5th	10th	25th	50th (Median)	Average	st dev	75th	90th	95th	Maximum
235	Last	3rd	H1	86	915	1380	1455	1643	1957	1929	376	2185	2386	2538	2893
235	Last	3rd	H2	86	1190	1571	1627	1704	1846	1885	231	2042	2186	2260	2356
235	Last	3rd	H3	86	733	869	935	1018	1162	1139	160	1260	1349	1388	1449
237	1st	3rd	H1	122	831	1053	1112	1196	1247	1454	477	1436	2438	2521	2945
237	1st	3rd	H2	122	775	926	984	1082	1196	1246	261	1369	1634	1742	2071
237	1st	3rd	H3	121	432	817	836	873	916	918	86	971	1024	1035	1061
237	2nd	3rd	H1	123	159	486	707	1533	1781	1696	523	2086	2267	2333	2440
237	2nd	3rd	H2	123	53	409	689	1045	1138	1118	329	1307	1462	1564	1886
237	2nd	3rd	H3	122	27	55	102	373	733	608	299	833	910	1001	1112
237	Last	3rd	H1	123	959	1044	1077	1225	1380	1357	200	1463	1593	1678	2005
237	Last	3rd	H2	123	991	1128	1222	1275	1431	1487	305	1553	2017	2143	2294
237	Last	3rd	H3	123	684	750	778	811	855	893	129	932	1096	1143	1373
50N	1st	3rd	H1	111	351	1416	1439	1498	1608	1591	165	1684	1760	1786	1939
50N	1st	3rd	H2	111	422	1200	1212	1257	1343	1346	138	1439	1500	1543	1594
50N	1st	3rd	H3	111	235	960	978	1050	1182	1241	274	1367	1714	1739	1825
50N	2nd	3rd	H1	111	163	564	921	1256	1369	1345	341	1574	1695	1805	1960
50N	2nd	3rd	H2	111	136	480	945	1222	1419	1348	342	1552	1673	1749	1903
50N	2nd	3rd	H3	112	35	703	1490	1797	2105	2036	578	2492	2652	2739	2933
50N	Last	3rd	H1	112	1083	1164	1181	1207	1282	1306	115	1397	1471	1510	1585
50N	Last	3rd	H2	112	1156	1220	1277	1365	1456	1445	116	1530	1585	1628	1695
50N	Last	3rd	H3	112	1286	1381	1447	1608	1747	1739	194	1897	1953	2044	2200
120N	1st	3rd	H1	50	19	255	1043	1096	1268	1155	298	1319	1350	1373	1486
120N	1st	3rd	H2	50	30	281	1028	1091	1246	1143	289	1305	1329	1343	1403
120N	1st	3rd	H3	50	64	462	1362	1556	1635	1572	382	1788	1859	1943	2009
120N	2nd	3rd	H1	51	373	813	963	1294	1814	1785	597	2393	2525	2597	2668
120N	2nd	3rd	H2	51	294	519	729	972	1358	1370	506	1863	1998	2195	2237
120N	2nd	3rd	H3	50	190	484	580	734	1007	980	314	1281	1375	1409	1499
120N	Last	3rd	H1	51	2121	2221	2387	2524	2679	2651	224	2764	2916	2989	3171
120N	Last	3rd	H2	51	1555	1621	1661	1709	1844	1861	171	2000	2076	2155	2198
120N	Last	3rd	H3	51	1045	1091	1119	1183	1257	1266	111	1343	1439	1449	1459

Table B.5. (continued)

Pile ID	Impact Time Series		Hydrophone	Number of Impacts	Average Sound Pressure Level (Pa)										
					Minimum	5th	10th	25th	50th (Median)	Average	st dev	75th	90th	95th	Maximum
240	1st	3rd	H1	98	258	957	2877	2932	3019	2878	656	3196	3273	3280	3369
240	1st	3rd	H2	99	126	475	1515	1902	2061	1907	480	2122	2188	2251	2307
240	1st	3rd	H3	98	295	513	1259	1348	1393	1324	250	1423	1450	1472	1533
240	2nd	3rd	H1	99	77	584	799	1387	1754	1777	680	2216	2759	2924	3201
240	2nd	3rd	H2	99	30	449	696	1207	1510	1609	716	1984	2735	2864	3009
240	2nd	3rd	H3	99	21	310	457	786	944	946	338	1127	1407	1461	1528
240	Last	3rd	H1	100	1686	1761	1806	1865	2123	2197	368	2482	2771	2864	3016
240	Last	3rd	H2	100	1528	1629	1787	1982	2589	2488	539	2941	3150	3349	3546
240	Last	3rd	H3	99	1055	1101	1133	1185	1290	1334	181	1456	1611	1676	1708
182	1st	3rd	H1	15	1526	1770	1821	1888	2057	2129	288	2379	2529	2590	2995
182	1st	3rd	H2	15	29	1340	1395	1472	1556	1564	224	1680	1786	1859	2073
182	1st	3rd	H3	15	483	975	991	1036	1098	1093	101	1153	1211	1240	1296
182	2nd	3rd	H1	15	80	80	122	264	383	452	259	694	851	913	913
182	2nd	3rd	H2	15	67	67	117	259	542	561	320	842	1014	1024	1024
182	2nd	3rd	H3	15	59	59	59	136	345	327	205	506	576	725	725
182	Last	3rd	H1	16	577	577	735	954	1230	1129	250	1308	1359	1438	1438
182	Last	3rd	H2	16	579	579	893	1024	1353	1256	268	1469	1507	1508	1508
182	Last	3rd	H3	16	192	192	253	413	496	472	143	555	677	682	682
177	1st	3rd	H1	9	1237	1237	1277	1403	1437	1442	104	1497	1584	1666	1666
177	1st	3rd	H2	8	1368	1368	1405	1561	1620	1619	129	1677	1837	1858	1858
177	1st	3rd	H3	6	388	388	431	452	493	482	41	507	540	542	542
177	2nd	3rd	H1	9	17	17	17	27	384	286	213	439	575	575	575
177	2nd	3rd	H2	9	28	28	28	382	483	505	272	708	863	863	863
177	2nd	3rd	H3	7	56	56	56	62	108	110	49	151	174	174	174
177	Last	3rd	H1	10	92	92	92	151	274	420	355	685	971	971	971
177	Last	3rd	H2	9	100	100	100	138	168	360	323	456	985	985	985
177	Last	3rd	H3	8	30	30	30	36	81	136	121	269	327	327	327
174	1st	3rd	H1	17	123	123	127	136	174	269	198	334	626	661	661
174	1st	3rd	H2	17	96	96	96	105	173	184	91	214	385	385	385
174	1st	3rd	H3	16	31	31	31	40	59	60	23	75	98	98	98

Table B.5. (continued)

Pile ID	Impact Time Series		Hydrophone	Number of Impacts	Average Sound Pressure Level (Pa)										
					Minimum	5th	10th	25th	50th (Median)	Average	st dev	75th	90th	95th	Maximum
174	2nd	3rd	H1	18	16	16	61	347	445	464	253	557	784	951	951
174	2nd	3rd	H2	18	93	93	330	507	647	645	280	747	834	1446	1446
174	2nd	3rd	H3	17	41	41	43	92	200	195	135	256	319	557	557
174	Last	3rd	H1	19	97	97	100	152	167	173	66	183	227	402	402
174	Last	3rd	H2	18	83	83	131	180	215	273	164	323	495	731	731
174	Last	3rd	H3	17	29	29	31	39	51	52	21	60	73	115	115
181	1st	3rd	H1	16	192	192	203	370	592	548	228	735	805	905	905
181	1st	3rd	H2	15	117	117	271	827	946	876	298	1018	1213	1234	1234
181	1st	3rd	H3	14	46	46	48	66	84	93	33	119	140	142	142
181	2nd	3rd	H1	16	14	14	63	245	572	551	355	826	992	1237	1237
181	2nd	3rd	H2	16	71	71	101	178	457	428	243	648	766	773	773
181	2nd	3rd	H3	15	9	9	55	99	204	191	114	300	318	339	339
181	Last	3rd	H1	17	100	100	198	232	305	341	148	477	544	602	602
181	Last	3rd	H2	16	141	141	148	168	196	235	81	289	369	376	376
181	Last	3rd	H3	16	60	60	60	66	100	88	20	105	106	111	111
167	1st	3rd	H1	33	370	370	641	837	1185	1052	313	1281	1379	1409	1409
167	1st	3rd	H2	32	119	119	417	491	663	626	202	746	875	903	903
167	1st	3rd	H3	21	108	108	108	136	212	204	68	266	284	298	298
167	2nd	3rd	H1	34	58	157	189	224	463	849	823	1288	2261	2607	2695
167	2nd	3rd	H2	33	49	52	54	86	199	450	463	779	1180	1447	1452
167	2nd	3rd	H3	22	13	23	76	158	241	263	153	323	428	558	600
167	Last	3rd	H1	35	376	428	481	543	657	766	405	736	1464	1591	2295
167	Last	3rd	H2	34	85	97	103	125	169	251	179	290	504	653	817
167	Last	3rd	H3	23	42	85	106	185	217	198	61	236	252	268	291
178	1st	3rd	H1	17	618	651	715	937	1325	1263	383	1576	1706	1948	1964
178	1st	3rd	H2	17	125	141	182	206	292	311	122	427	473	548	548
178	1st	3rd	H3	16	76	138	166	190	215	206	40	236	241	242	249
178	2nd	3rd	H1	18	30	30	39	145	230	499	495	1024	1330	1407	1407
178	2nd	3rd	H2	17	13	13	129	353	688	772	491	1071	1581	1641	1641
178	2nd	3rd	H3	17	34	34	34	81	186	246	197	427	517	608	608

Table B.5. (continued)

Pile ID	Impact Time Series		Hydrophone	Number of Impacts	Average Sound Pressure Level (Pa)										
					Minimum	5th	10th	25th	50th (Median)	Average	st dev	75th	90th	95th	Maximum
178	Last	3rd	H1	18	200	200	212	364	768	730	414	1131	1258	1423	1423
178	Last	3rd	H2	18	377	377	728	1532	1842	1612	563	1955	2180	2327	2327
178	Last	3rd	H3	17	135	135	156	225	404	350	114	436	458	470	470
244	1st	3rd	H1	17	439	439	441	460	811	825	340	1149	1334	1420	1420
244	1st	3rd	H2	16	1853	1853	1898	2064	2287	2274	244	2492	2562	2598	2598
244	1st	3rd	H3	16	211	211	218	246	385	346	85	404	439	468	468
244	2nd	3rd	H1	18	14	14	22	369	840	742	504	948	1469	1542	1542
244	2nd	3rd	H2	17	34	34	324	537	598	713	401	860	1450	1639	1639
244	2nd	3rd	H3	16	168	168	182	351	480	473	212	553	816	949	949
244	Last	3rd	H1	19	49	49	153	250	625	678	540	800	1811	2057	2057
244	Last	3rd	H2	18	42	42	131	433	596	563	343	676	869	1573	1573
244	Last	3rd	H3	17	76	76	119	279	315	346	208	378	553	990	990

Table B.6. Distribution Statistics for the Sound Exposure Level Integrated Over the 95th Percentile Pulse Duration of Each Strike in a Series on the Indicated Pile

Pile ID	Impact Time Series		Hydrophone	Number of Impacts	Sound Exposure Level (Pa ²)										
					Minimum	5 th	10 th	25 th	50 th (Median)	Average	st dev	75 th	90 th	95 th	Maximum
121N	1 st	3 rd	H1	98	3.00E+09	7.51E+09	8.09E+09	9.70E+09	1.38E+10	1.38E+10	4.67E+09	1.83E+10	2.02E+10	2.05E+10	2.12E+10
121N	1 st	3 rd	H2	98	4.69E+09	5.64E+09	6.38E+09	6.87E+09	7.57E+09	7.84E+09	1.48E+09	8.85E+09	9.63E+09	9.86E+09	1.48E+10
121N	1 st	3 rd	H3	97	1.09E+09	1.56E+09	1.70E+09	1.84E+09	2.27E+09	2.27E+09	5.00E+08	2.72E+09	2.94E+09	3.11E+09	3.29E+09
121N	2 nd	3 rd	H1	99	4.23E+09	4.61E+09	4.81E+09	5.05E+09	5.55E+09	6.38E+09	1.79E+09	7.80E+09	9.46E+09	1.00E+10	1.13E+10
121N	2 nd	3 rd	H2	99	1.91E+09	2.06E+09	2.10E+09	2.21E+09	2.45E+09	3.03E+09	1.21E+09	3.34E+09	5.42E+09	5.81E+09	6.64E+09
121N	2 nd	3 rd	H3	98	4.49E+08	4.88E+08	5.09E+08	5.48E+08	6.55E+08	8.43E+08	3.69E+08	1.10E+09	1.47E+09	1.58E+09	1.85E+09
121N	Last	3 rd	H1	99	7.34E+07	3.40E+09	5.38E+09	1.32E+10	1.44E+10	1.39E+10	4.69E+09	1.70E+10	1.93E+10	2.03E+10	2.18E+10
121N	Last	3 rd	H2	99	3.21E+07	2.10E+09	2.48E+09	6.83E+09	7.48E+09	7.01E+09	2.25E+09	8.28E+09	8.94E+09	9.98E+09	1.02E+10
121N	Last	3 rd	H3	99	1.28E+07	4.79E+08	5.38E+08	2.09E+09	2.25E+09	2.07E+09	7.22E+08	2.45E+09	2.72E+09	2.87E+09	3.10E+09
52N	1 st	3 rd	H1	35	3.72E+09	1.22E+10	1.25E+10	1.29E+10	1.35E+10	1.34E+10	1.99E+09	1.42E+10	1.48E+10	1.62E+10	1.64E+10
52N	1 st	3 rd	H2	35	6.68E+09	1.13E+10	1.22E+10	1.31E+10	1.40E+10	1.51E+10	3.27E+09	1.81E+10	1.99E+10	2.10E+10	2.18E+10
52N	1 st	3 rd	H3	35	1.20E+09	3.46E+09	3.65E+09	3.91E+09	4.14E+09	4.11E+09	6.36E+08	4.42E+09	4.58E+09	4.87E+09	5.28E+09
52N	2 nd	3 rd	H1	36	1.28E+10	1.29E+10	1.30E+10	1.36E+10	1.43E+10	1.43E+10	9.34E+08	1.50E+10	1.56E+10	1.62E+10	1.63E+10
52N	2 nd	3 rd	H2	36	1.38E+10	1.55E+10	1.61E+10	1.80E+10	2.05E+10	2.01E+10	3.05E+09	2.25E+10	2.37E+10	2.41E+10	2.71E+10
52N	2 nd	3 rd	H3	36	3.67E+09	3.77E+09	4.11E+09	4.28E+09	4.52E+09	4.52E+09	3.50E+08	4.76E+09	4.99E+09	5.03E+09	5.21E+09
52N	Last	3 rd	H1	36	5.78E+08	1.07E+09	2.38E+09	1.38E+10	1.47E+10	1.31E+10	4.98E+09	1.56E+10	1.68E+10	1.74E+10	1.82E+10
52N	Last	3 rd	H2	36	1.95E+09	2.81E+09	6.41E+09	2.50E+10	2.68E+10	2.36E+10	8.21E+09	2.80E+10	2.87E+10	2.89E+10	3.05E+10
52N	Last	3 rd	H3	36	2.08E+08	3.15E+08	7.49E+08	4.58E+09	4.75E+09	4.16E+09	1.57E+09	5.00E+09	5.11E+09	5.20E+09	5.21E+09
118N	1 st	3 rd	H1	67	3.28E+09	6.44E+09	7.48E+09	1.19E+10	1.31E+10	1.24E+10	2.61E+09	1.40E+10	1.46E+10	1.48E+10	1.57E+10
118N	1 st	3 rd	H2	67	9.97E+08	1.73E+09	1.76E+09	2.91E+09	4.39E+09	3.90E+09	1.23E+09	4.95E+09	5.11E+09	5.27E+09	5.52E+09
118N	1 st	3 rd	H3	66	5.39E+07	4.39E+08	5.72E+08	7.21E+08	8.77E+08	8.42E+08	2.07E+08	1.01E+09	1.07E+09	1.10E+09	1.15E+09
118N	2 nd	3 rd	H1	68	7.76E+09	8.63E+09	8.92E+09	9.32E+09	1.04E+10	1.06E+10	1.44E+09	1.15E+10	1.24E+10	1.31E+10	1.47E+10
118N	2 nd	3 rd	H2	67	3.85E+09	4.11E+09	4.16E+09	4.45E+09	4.80E+09	4.84E+09	4.90E+08	5.15E+09	5.45E+09	5.69E+09	6.18E+09
118N	2 nd	3 rd	H3	67	9.46E+08	1.04E+09	1.09E+09	1.13E+09	1.22E+09	1.23E+09	1.26E+08	1.32E+09	1.40E+09	1.45E+09	1.49E+09
118N	Last	3 rd	H1	68	7.79E+07	4.59E+09	9.70E+09	1.05E+10	1.14E+10	1.14E+10	2.84E+09	1.34E+10	1.44E+10	1.46E+10	1.55E+10
118N	Last	3 rd	H2	68	6.73E+08	5.10E+09	5.25E+09	5.77E+09	6.07E+09	5.86E+09	1.06E+09	6.33E+09	6.59E+09	6.76E+09	7.01E+09
118N	Last	3 rd	H3	67	4.10E+08	1.21E+09	1.26E+09	1.33E+09	1.37E+09	1.35E+09	1.40E+08	1.42E+09	1.46E+09	1.47E+09	1.56E+09

Table B.6. (continued)

Pile ID	Impact Time Series		Hydrophone	Number of Impacts	Sound Exposure Level (Pa ²)										
					Minimum	5 th	10 th	25 th	50 th (Median)	Average	st dev	75 th	90 th	95 th	Maximum
255	1st	3rd	H1	77	3.79E+09	6.94E+09	8.05E+09	8.90E+09	1.02E+10	9.92E+09	1.62E+09	1.11E+10	1.17E+10	1.23E+10	1.26E+10
255	1st	3rd	H2	77	2.98E+09	5.41E+09	6.25E+09	7.03E+09	7.53E+09	7.43E+09	9.98E+08	8.08E+09	8.55E+09	8.68E+09	9.15E+09
255	1st	3rd	H3	77	2.52E+08	7.33E+08	7.76E+08	8.54E+08	9.49E+08	1.11E+10	4.86E+10	1.02E+09	1.13E+09	5.13E+10	3.33E+11
255	2nd	3rd	H1	78	5.70E+09	6.17E+09	6.28E+09	6.98E+09	7.92E+09	7.77E+09	9.83E+08	8.61E+09	8.95E+09	9.10E+09	9.83E+09
255	2nd	3rd	H2	78	3.60E+09	3.86E+09	4.02E+09	4.34E+09	4.98E+09	5.16E+09	9.42E+08	5.88E+09	6.65E+09	6.74E+09	7.10E+09
255	2nd	3rd	H3	78	4.00E+08	4.56E+08	4.77E+08	5.23E+08	5.79E+08	9.42E+09	4.33E+10	6.48E+08	7.87E+08	3.87E+10	2.83E+11
255	Last	3rd	H1	79	7.95E+08	4.58E+09	4.76E+09	5.00E+09	5.40E+09	5.43E+09	7.70E+08	5.97E+09	6.21E+09	6.45E+09	6.47E+09
255	Last	3rd	H2	79	5.70E+08	3.40E+09	3.44E+09	3.57E+09	3.73E+09	3.74E+09	4.42E+08	3.90E+09	4.14E+09	4.30E+09	4.50E+09
255	Last	3rd	H3	79	3.47E+08	3.74E+08	4.42E+08	5.10E+08	5.84E+08	6.14E+08	1.60E+08	6.84E+08	8.82E+08	9.72E+08	1.03E+09
249	1st	3rd	H1	168	8.79E+08	2.40E+09	3.57E+09	6.66E+09	7.69E+09	7.27E+09	2.14E+09	8.66E+09	9.60E+09	1.01E+10	1.16E+10
249	1st	3rd	H2	168	5.71E+08	1.79E+09	3.07E+09	4.27E+09	5.59E+09	5.47E+09	1.94E+09	6.94E+09	7.80E+09	8.27E+09	9.75E+09
249	1st	3rd	H3	168	1.06E+08	2.43E+08	3.27E+08	5.86E+08	6.55E+08	6.29E+08	1.68E+08	7.21E+08	8.14E+08	8.54E+08	9.50E+08
249	2nd	3rd	H1	168	4.64E+08	5.70E+09	5.89E+09	6.32E+09	6.98E+09	8.07E+09	3.72E+09	8.05E+09	9.78E+09	1.93E+10	2.33E+10
249	2nd	3rd	H2	168	3.52E+08	4.33E+09	4.44E+09	4.75E+09	5.22E+09	5.89E+09	2.08E+09	6.50E+09	7.47E+09	1.20E+10	1.43E+10
249	2nd	3rd	H3	168	5.83E+08	8.42E+08	8.84E+08	9.44E+08	1.01E+09	1.06E+09	2.25E+08	1.12E+09	1.26E+09	1.56E+09	2.14E+09
249	Last	3rd	H1	170	1.99E+09	5.62E+09	5.78E+09	6.06E+09	6.43E+09	6.51E+09	7.35E+08	6.91E+09	7.51E+09	7.76E+09	8.64E+09
249	Last	3rd	H2	170	1.28E+09	4.52E+09	4.61E+09	4.94E+09	5.26E+09	5.27E+09	5.67E+08	5.59E+09	5.97E+09	6.11E+09	6.66E+09
249	Last	3rd	H3	169	2.68E+08	8.18E+08	8.64E+08	9.33E+08	1.01E+09	1.02E+09	1.51E+08	1.10E+09	1.23E+09	1.30E+09	1.43E+09
252	1st	3rd	H1	85	3.05E+08	1.69E+09	2.34E+09	4.38E+09	6.39E+09	6.04E+09	2.35E+09	7.94E+09	8.83E+09	9.08E+09	9.47E+09
252	1st	3rd	H2	85	3.05E+08	1.69E+09	2.34E+09	4.38E+09	6.39E+09	6.04E+09	2.35E+09	7.94E+09	8.83E+09	9.08E+09	9.47E+09
252	1st	3rd	H3	84	1.77E+08	1.13E+09	1.58E+09	3.16E+09	4.21E+09	3.81E+09	1.31E+09	4.67E+09	5.21E+09	5.39E+09	5.70E+09
252	2nd	3rd	H1	85	4.30E+07	1.34E+08	1.52E+08	2.80E+08	4.30E+08	4.12E+08	1.63E+08	5.35E+08	6.13E+08	6.30E+08	7.38E+08
252	2nd	3rd	H2	85	6.82E+09	7.83E+09	8.19E+09	9.26E+09	1.19E+10	1.20E+10	3.33E+09	1.38E+10	1.78E+10	1.83E+10	1.99E+10
252	2nd	3rd	H3	84	6.82E+09	7.83E+09	8.19E+09	9.26E+09	1.19E+10	1.20E+10	3.33E+09	1.38E+10	1.78E+10	1.83E+10	1.99E+10
252	Last	3rd	H1	86	2.90E+09	3.22E+09	3.43E+09	3.61E+09	3.91E+09	4.36E+09	1.23E+09	4.77E+09	7.14E+09	7.26E+09	7.73E+09
252	Last	3rd	H2	86	2.80E+08	2.95E+08	3.32E+08	3.72E+08	4.29E+08	4.85E+08	1.87E+08	4.96E+08	7.57E+08	8.69E+08	1.11E+09
252	Last	3rd	H3	85	4.95E+09	1.97E+10	2.00E+10	2.09E+10	2.22E+10	2.19E+10	2.41E+09	2.32E+10	2.40E+10	2.44E+10	2.65E+10
172	1st	3rd	H1	64	4.95E+09	1.97E+10	2.00E+10	2.09E+10	2.22E+10	2.19E+10	2.41E+09	2.32E+10	2.40E+10	2.44E+10	2.65E+10
172	1st	3rd	H2	64	2.06E+09	7.25E+09	7.69E+09	8.44E+09	9.87E+09	9.72E+09	1.62E+09	1.09E+10	1.16E+10	1.20E+10	1.22E+10
172	1st	3rd	H3	62	6.91E+08	7.54E+08	8.01E+08	8.67E+08	9.72E+08	9.78E+08	1.50E+08	1.06E+09	1.19E+09	1.21E+09	1.49E+09

Table B.6. (continued)

File ID	Impact Time Series		Hydrophone	Number of Impacts	Sound Exposure Level (Pa ²)										
					Minimum	5 th	10 th	25 th	50 th (Median)	Average	st dev	75 th	90 th	95 th	Maximum
172	2nd	3rd	H1	65	4.84E+07	2.00E+08	7.70E+08	1.52E+09	5.36E+09	6.27E+09	5.25E+09	9.68E+09	1.50E+10	1.61E+10	1.94E+10
172	2nd	3rd	H2	65	7.66E+07	5.12E+08	1.48E+09	2.78E+09	7.32E+09	7.54E+09	5.10E+09	1.16E+10	1.52E+10	1.61E+10	1.81E+10
172	2nd	3rd	H3	63	7.90E+07	1.05E+08	1.39E+08	3.44E+08	1.07E+09	9.55E+08	5.87E+08	1.50E+09	1.66E+09	1.69E+09	1.80E+09
172	Last	3rd	H1	65	1.88E+10	1.98E+10	2.28E+10	3.23E+10	4.39E+10	3.98E+10	1.02E+10	4.82E+10	5.02E+10	5.09E+10	5.35E+10
172	Last	3rd	H2	65	1.79E+10	1.95E+10	2.24E+10	3.40E+10	4.17E+10	3.85E+10	9.30E+09	4.52E+10	4.77E+10	4.85E+10	5.08E+10
172	Last	3rd	H3	63	1.53E+09	1.58E+09	1.64E+09	1.68E+09	1.79E+09	1.78E+09	1.24E+08	1.88E+09	1.95E+09	1.95E+09	2.08E+09
171	1st	3rd	H1	134	1.52E+10	4.21E+10	4.34E+10	4.51E+10	4.72E+10	4.75E+10	5.47E+09	5.08E+10	5.33E+10	5.48E+10	5.58E+10
171	1st	3rd	H2	134	1.61E+10	3.88E+10	4.04E+10	4.33E+10	4.84E+10	4.87E+10	7.84E+09	5.54E+10	5.79E+10	5.87E+10	6.05E+10
171	1st	3rd	H3	132	3.54E+08	1.47E+09	1.50E+09	1.54E+09	1.64E+09	1.64E+09	2.10E+08	1.73E+09	1.85E+09	1.91E+09	1.95E+09
171	2nd	3rd	H1	135	3.31E+08	9.07E+08	1.39E+09	3.52E+09	7.13E+09	6.66E+09	3.68E+09	1.01E+10	1.09E+10	1.12E+10	1.21E+10
171	2nd	3rd	H2	135	2.22E+08	6.35E+08	8.49E+08	3.44E+09	7.24E+09	6.96E+09	4.19E+09	1.09E+10	1.14E+10	1.19E+10	1.29E+10
171	2nd	3rd	H3	132	6.68E+07	1.13E+08	1.57E+08	7.83E+08	1.45E+09	1.20E+09	6.22E+08	1.73E+09	1.85E+09	1.92E+09	2.10E+09
171	Last	3rd	H1	136	6.84E+08	9.30E+09	9.70E+09	1.00E+10	1.05E+10	1.04E+10	1.07E+09	1.10E+10	1.13E+10	1.16E+10	1.21E+10
171	Last	3rd	H2	136	7.10E+08	1.04E+10	1.06E+10	1.09E+10	1.13E+10	1.12E+10	1.04E+09	1.17E+10	1.19E+10	1.21E+10	1.23E+10
171	Last	3rd	H3	133	1.34E+09	1.49E+09	1.53E+09	1.59E+09	1.66E+09	1.65E+09	9.91E+07	1.72E+09	1.77E+09	1.82E+09	1.90E+09
238	1st	3rd	H1	72	3.12E+08	9.96E+09	1.05E+10	1.10E+10	1.18E+10	1.20E+10	2.70E+09	1.28E+10	1.47E+10	1.61E+10	2.21E+10
238	1st	3rd	H2	71	2.20E+08	8.75E+09	9.37E+09	1.02E+10	1.07E+10	1.08E+10	2.30E+09	1.15E+10	1.29E+10	1.42E+10	1.98E+10
238	1st	3rd	H3	67	1.25E+08	1.33E+09	1.42E+09	1.57E+09	1.69E+09	1.70E+09	3.59E+08	1.81E+09	2.07E+09	2.32E+09	2.86E+09
238	2nd	3rd	H1	73	2.14E+08	3.61E+08	6.32E+08	9.67E+08	1.22E+09	1.49E+09	9.99E+08	1.66E+09	3.08E+09	4.41E+09	4.78E+09
238	2nd	3rd	H2	72	5.55E+07	2.11E+08	2.90E+08	5.75E+08	1.09E+09	1.66E+09	1.50E+09	2.18E+09	4.22E+09	5.22E+09	5.57E+09
238	2nd	3rd	H3	68	7.47E+07	2.11E+08	2.24E+08	3.24E+08	5.63E+08	8.44E+08	6.50E+08	1.30E+09	1.88E+09	2.04E+09	2.44E+09
238	Last	3rd	H1	73	2.38E+09	2.75E+09	3.02E+09	3.56E+09	4.37E+09	4.76E+09	1.47E+09	6.11E+09	6.81E+09	7.14E+09	7.26E+09
238	Last	3rd	H2	73	4.04E+09	4.13E+09	4.61E+09	5.24E+09	6.07E+09	6.16E+09	1.28E+09	6.95E+09	7.73E+09	8.69E+09	9.45E+09
238	Last	3rd	H3	69	1.83E+09	1.86E+09	1.88E+09	1.97E+09	2.16E+09	2.14E+09	1.91E+08	2.31E+09	2.38E+09	2.43E+09	2.52E+09
235	1st	3rd	H1	85	4.73E+09	7.55E+09	9.20E+09	9.81E+09	1.10E+10	1.09E+10	1.71E+09	1.19E+10	1.31E+10	1.34E+10	1.40E+10
235	1st	3rd	H2	85	5.37E+09	8.46E+09	9.47E+09	1.06E+10	1.24E+10	1.24E+10	2.34E+09	1.41E+10	1.52E+10	1.65E+10	1.73E+10
235	1st	3rd	H3	85	1.03E+09	2.26E+09	2.29E+09	2.38E+09	2.61E+09	2.69E+09	4.52E+08	2.91E+09	3.44E+09	3.63E+09	3.73E+09
235	2nd	3rd	H1	86	1.04E+09	2.39E+09	2.73E+09	3.45E+09	4.86E+09	4.74E+09	1.59E+09	5.96E+09	6.70E+09	7.02E+09	8.43E+09
235	2nd	3rd	H2	86	1.00E+09	2.19E+09	2.29E+09	2.73E+09	3.61E+09	3.80E+09	1.33E+09	4.78E+09	5.64E+09	6.38E+09	6.90E+09
235	2nd	3rd	H3	86	1.93E+08	5.14E+08	6.31E+08	1.49E+09	1.96E+09	2.10E+09	1.02E+09	2.89E+09	3.48E+09	3.62E+09	4.29E+09

Table B.6. (continued)

Pile ID	Impact Time Series		Hydrophone	Number of Impacts	Sound Exposure Level (Pa ²)										
					Minimum	5 th	10 th	25 th	50 th (Median)	Average	st dev	75 th	90 th	95 th	Maximum
235	Last	3rd	H1	86	4.44E+09	5.33E+09	5.91E+09	7.68E+09	9.82E+09	9.54E+09	2.51E+09	1.17E+10	1.27E+10	1.28E+10	1.33E+10
235	Last	3rd	H2	86	5.04E+09	6.08E+09	6.32E+09	7.15E+09	8.74E+09	8.48E+09	1.49E+09	9.70E+09	1.02E+10	1.05E+10	1.08E+10
235	Last	3rd	H3	86	2.25E+09	2.41E+09	2.54E+09	2.78E+09	3.31E+09	3.30E+09	5.88E+08	3.79E+09	4.09E+09	4.18E+09	4.61E+09
237	1st	3rd	H1	122	5.02E+09	5.50E+09	5.68E+09	5.95E+09	6.45E+09	8.10E+09	3.63E+09	8.13E+09	1.59E+10	1.65E+10	1.79E+10
237	1st	3rd	H2	122	3.98E+09	4.52E+09	4.66E+09	5.01E+09	5.47E+09	6.07E+09	1.74E+09	6.33E+09	9.49E+09	1.03E+10	1.14E+10
237	1st	3rd	H3	121	1.08E+09	2.43E+09	2.57E+09	2.78E+09	2.92E+09	2.92E+09	3.61E+08	3.08E+09	3.36E+09	3.46E+09	3.73E+09
237	2nd	3rd	H1	123	2.77E+08	1.30E+09	2.80E+09	6.57E+09	7.30E+09	7.11E+09	2.39E+09	8.47E+09	9.75E+09	1.02E+10	1.10E+10
237	2nd	3rd	H2	123	1.42E+08	9.51E+08	1.58E+09	3.48E+09	3.86E+09	3.92E+09	1.51E+09	4.51E+09	5.32E+09	6.45E+09	9.70E+09
237	2nd	3rd	H3	122	9.31E+07	2.11E+08	5.44E+08	8.25E+08	1.72E+09	1.59E+09	8.29E+08	2.40E+09	2.54E+09	2.60E+09	3.24E+09
237	Last	3rd	H1	123	4.42E+09	4.73E+09	4.89E+09	5.48E+09	6.16E+09	6.33E+09	1.12E+09	7.16E+09	7.73E+09	8.20E+09	9.40E+09
237	Last	3rd	H2	123	4.87E+09	5.11E+09	5.27E+09	5.62E+09	6.22E+09	6.40E+09	1.07E+09	6.95E+09	7.91E+09	8.49E+09	9.76E+09
237	Last	3rd	H3	123	2.23E+09	2.54E+09	2.66E+09	2.88E+09	3.17E+09	3.18E+09	4.20E+08	3.49E+09	3.72E+09	3.90E+09	4.33E+09
50N	1st	3rd	H1	111	1.16E+09	7.45E+09	7.57E+09	8.08E+09	9.10E+09	8.87E+09	1.21E+09	9.80E+09	1.02E+10	1.03E+10	1.08E+10
50N	1st	3rd	H2	111	8.24E+08	6.11E+09	6.20E+09	6.51E+09	7.00E+09	6.97E+09	8.66E+08	7.44E+09	7.84E+09	8.24E+09	8.82E+09
50N	1st	3rd	H3	111	5.98E+08	3.35E+09	3.47E+09	3.59E+09	3.79E+09	3.79E+09	4.10E+08	4.02E+09	4.18E+09	4.27E+09	4.50E+09
50N	2nd	3rd	H1	111	2.18E+08	2.85E+09	4.89E+09	9.60E+09	1.10E+10	9.95E+09	3.19E+09	1.19E+10	1.26E+10	1.29E+10	1.38E+10
50N	2nd	3rd	H2	111	2.42E+08	3.15E+09	4.40E+09	8.08E+09	1.16E+10	1.01E+10	3.56E+09	1.28E+10	1.35E+10	1.38E+10	1.45E+10
50N	2nd	3rd	H3	112	4.16E+07	3.27E+09	9.62E+09	1.75E+10	2.00E+10	1.86E+10	6.10E+09	2.27E+10	2.50E+10	2.55E+10	2.73E+10
50N	Last	3rd	H1	112	8.91E+09	9.72E+09	1.00E+10	1.04E+10	1.09E+10	1.09E+10	7.76E+08	1.16E+10	1.20E+10	1.22E+10	1.24E+10
50N	Last	3rd	H2	112	1.04E+10	1.10E+10	1.13E+10	1.16E+10	1.24E+10	1.24E+10	9.00E+08	1.30E+10	1.35E+10	1.38E+10	1.46E+10
50N	Last	3rd	H3	112	1.45E+10	1.59E+10	1.72E+10	1.84E+10	1.95E+10	1.95E+10	1.88E+09	2.09E+10	2.19E+10	2.25E+10	2.32E+10
120N	1st	3rd	H1	50	2.31E+07	1.18E+09	8.98E+09	9.33E+09	9.67E+09	9.04E+09	2.39E+09	1.00E+10	1.03E+10	1.05E+10	1.07E+10
120N	1st	3rd	H2	50	6.02E+07	1.49E+09	9.74E+09	1.03E+10	1.07E+10	1.00E+10	2.63E+09	1.11E+10	1.14E+10	1.17E+10	1.23E+10
120N	1st	3rd	H3	50	1.24E+08	3.23E+09	1.58E+10	1.82E+10	2.03E+10	1.86E+10	4.99E+09	2.11E+10	2.16E+10	2.20E+10	2.29E+10
120N	2nd	3rd	H1	51	1.04E+09	4.04E+09	8.32E+09	1.16E+10	1.42E+10	1.49E+10	5.35E+09	1.91E+10	2.21E+10	2.23E+10	2.28E+10
120N	2nd	3rd	H2	51	8.84E+08	2.96E+09	4.90E+09	7.08E+09	8.79E+09	9.17E+09	3.34E+09	1.20E+10	1.33E+10	1.46E+10	1.54E+10
120N	2nd	3rd	H3	50	2.78E+08	9.47E+08	1.99E+09	2.85E+09	3.77E+09	3.80E+09	1.43E+09	5.09E+09	5.54E+09	5.81E+09	5.94E+09
120N	Last	3rd	H1	51	2.20E+10	2.26E+10	2.29E+10	2.41E+10	2.52E+10	2.56E+10	2.22E+09	2.63E+10	2.89E+10	3.02E+10	3.15E+10
120N	Last	3rd	H2	51	1.31E+10	1.33E+10	1.34E+10	1.38E+10	1.43E+10	1.44E+10	8.78E+08	1.48E+10	1.55E+10	1.62E+10	1.73E+10
120N	Last	3rd	H3	51	4.31E+09	4.58E+09	4.68E+09	4.83E+09	5.17E+09	5.24E+09	4.77E+08	5.67E+09	5.97E+09	6.11E+09	6.23E+09

B.39

Table B.6. (continued)

Pile ID	Impact Time Series		Hydrophone	Number of Impacts	Sound Exposure Level (Pa ²)										
					Minimum	5 th	10 th	25 th	50 th (Median)	Average	st dev	75 th	90 th	95 th	Maximum
240	1st	3rd	H1	98	8.43E+08	3.76E+09	2.52E+10	2.68E+10	2.91E+10	2.74E+10	8.17E+09	3.23E+10	3.39E+10	3.41E+10	3.47E+10
240	1st	3rd	H2	99	5.11E+08	2.24E+09	1.44E+10	1.48E+10	1.60E+10	1.47E+10	4.14E+09	1.66E+10	1.71E+10	1.73E+10	1.79E+10
240	1st	3rd	H3	98	4.18E+08	1.13E+09	4.83E+09	4.94E+09	5.23E+09	4.98E+09	1.20E+09	5.50E+09	5.74E+09	5.88E+09	6.08E+09
240	2nd	3rd	H1	99	1.17E+08	1.76E+09	2.77E+09	6.54E+09	8.34E+09	9.20E+09	4.73E+09	1.20E+10	1.64E+10	1.77E+10	1.97E+10
240	2nd	3rd	H2	99	4.17E+07	1.20E+09	2.02E+09	4.13E+09	6.15E+09	7.11E+09	4.21E+09	1.02E+10	1.38E+10	1.51E+10	1.56E+10
240	2nd	3rd	H3	99	4.96E+07	4.89E+08	7.81E+08	1.70E+09	2.39E+09	2.47E+09	1.16E+09	3.32E+09	4.22E+09	4.38E+09	4.77E+09
240	Last	3rd	H1	100	7.20E+09	7.83E+09	8.13E+09	8.69E+09	1.14E+10	1.16E+10	3.13E+09	1.40E+10	1.63E+10	1.77E+10	1.92E+10
240	Last	3rd	H2	100	7.02E+09	7.54E+09	8.04E+09	8.88E+09	1.19E+10	1.19E+10	3.13E+09	1.46E+10	1.64E+10	1.73E+10	1.90E+10
240	Last	3rd	H3	99	3.18E+09	3.60E+09	3.77E+09	4.02E+09	4.30E+09	4.34E+09	4.57E+08	4.71E+09	4.96E+09	5.13E+09	5.48E+09
182	1st	3rd	H1	15	5.52E+09	9.20E+09	9.63E+09	1.07E+10	1.30E+10	1.35E+10	3.40E+09	1.66E+10	1.85E+10	1.93E+10	2.17E+10
182	1st	3rd	H2	15	3.95E+07	6.14E+09	6.53E+09	6.91E+09	7.53E+09	7.46E+09	1.24E+09	8.13E+09	8.73E+09	9.24E+09	9.91E+09
182	1st	3rd	H3	15	8.13E+08	3.60E+09	3.71E+09	3.82E+09	4.01E+09	3.99E+09	4.26E+08	4.20E+09	4.36E+09	4.50E+09	4.94E+09
182	2nd	3rd	H1	15	1.23E+08	1.23E+08	1.75E+08	6.68E+08	1.64E+09	1.63E+09	1.15E+09	2.43E+09	3.57E+09	3.77E+09	3.77E+09
182	2nd	3rd	H2	15	9.20E+07	9.20E+07	1.26E+08	6.61E+08	1.79E+09	1.83E+09	1.36E+09	3.23E+09	3.70E+09	3.93E+09	3.93E+09
182	2nd	3rd	H3	15	6.34E+07	6.34E+07	6.55E+07	2.53E+08	6.29E+08	6.33E+08	4.44E+08	1.13E+09	1.19E+09	1.29E+09	1.29E+09
182	Last	3rd	H1	16	2.69E+09	2.69E+09	3.02E+09	5.44E+09	7.39E+09	6.50E+09	1.85E+09	7.56E+09	7.97E+09	8.02E+09	8.02E+09
182	Last	3rd	H2	16	2.28E+09	2.28E+09	2.66E+09	4.35E+09	6.74E+09	5.77E+09	1.74E+09	6.84E+09	6.95E+09	7.10E+09	7.10E+09
182	Last	3rd	H3	16	7.97E+08	7.97E+08	8.34E+08	1.14E+09	1.24E+09	1.24E+09	2.46E+08	1.42E+09	1.55E+09	1.58E+09	1.58E+09
177	1st	3rd	H1	9	7.34E+09	7.34E+09	7.54E+09	8.32E+09	8.69E+09	8.69E+09	7.29E+08	9.15E+09	9.51E+09	1.02E+10	1.02E+10
177	1st	3rd	H2	8	6.96E+09	6.96E+09	6.98E+09	7.62E+09	8.11E+09	8.05E+09	6.67E+08	8.31E+09	8.78E+09	9.56E+09	9.56E+09
177	1st	3rd	H3	6	1.21E+09	1.21E+09	1.23E+09	1.24E+09	1.35E+09	1.35E+09	1.05E+08	1.43E+09	1.51E+09	1.53E+09	1.53E+09
177	2nd	3rd	H1	9	2.03E+07	2.03E+07	2.03E+07	6.45E+07	9.96E+08	8.17E+08	6.06E+08	1.31E+09	1.48E+09	1.48E+09	1.48E+09
177	2nd	3rd	H2	9	2.76E+07	2.76E+07	2.76E+07	8.08E+08	1.00E+09	1.23E+09	9.01E+08	1.59E+09	3.02E+09	3.02E+09	3.02E+09
177	2nd	3rd	H3	7	1.83E+08	1.83E+08	1.83E+08	2.27E+08	2.45E+08	2.87E+08	1.10E+08	3.36E+08	4.87E+08	4.87E+08	4.87E+08
177	Last	3rd	H1	10	2.15E+08	2.15E+08	2.15E+08	4.82E+08	8.89E+08	1.41E+09	1.36E+09	2.14E+09	3.71E+09	3.71E+09	3.71E+09
177	Last	3rd	H2	9	1.71E+08	1.71E+08	1.71E+08	3.35E+08	4.55E+08	8.47E+08	8.94E+08	6.85E+08	2.73E+09	2.73E+09	2.73E+09
177	Last	3rd	H3	8	5.66E+07	5.66E+07	5.66E+07	6.92E+07	1.28E+08	2.51E+08	2.16E+08	4.39E+08	5.58E+08	5.58E+08	5.58E+08
174	1st	3rd	H1	17	5.65E+08	5.65E+08	5.73E+08	6.61E+08	1.18E+09	1.13E+09	4.08E+08	1.53E+09	1.61E+09	1.64E+09	1.64E+09
174	1st	3rd	H2	17	4.36E+08	4.36E+08	4.36E+08	5.53E+08	6.18E+08	6.22E+08	1.37E+08	7.08E+08	8.29E+08	8.29E+08	8.29E+08
174	1st	3rd	H3	16	7.80E+07	7.80E+07	7.80E+07	1.33E+08	1.51E+08	1.47E+08	3.56E+07	1.70E+08	1.90E+08	1.90E+08	1.90E+08

B.40

Table B.6. (continued)

Pile ID	Impact Time Series		Hydrophone	Number of Impacts	Sound Exposure Level (Pa ²)										
					Minimum	5 th	10 th	25 th	50 th (Median)	Average	st dev	75 th	90 th	95 th	Maximum
174	2nd	3rd	H1	18	2.71E+07	2.71E+07	1.95E+08	1.30E+09	1.54E+09	1.79E+09	1.09E+09	1.87E+09	3.13E+09	4.65E+09	4.65E+09
174	2nd	3rd	H2	18	2.82E+08	2.82E+08	1.10E+09	1.61E+09	2.18E+09	2.22E+09	1.06E+09	2.60E+09	3.15E+09	5.32E+09	5.32E+09
174	2nd	3rd	H3	17	1.69E+08	1.69E+08	2.77E+08	3.40E+08	4.21E+08	4.63E+08	1.93E+08	5.48E+08	7.54E+08	9.51E+08	9.51E+08
174	Last	3rd	H1	19	2.42E+08	2.42E+08	3.03E+08	5.53E+08	6.97E+08	6.85E+08	2.55E+08	7.65E+08	1.17E+09	1.19E+09	1.19E+09
174	Last	3rd	H2	18	3.30E+08	3.30E+08	6.51E+08	1.13E+09	1.33E+09	1.30E+09	4.55E+08	1.76E+09	1.84E+09	1.95E+09	1.95E+09
174	Last	3rd	H3	17	7.78E+07	7.78E+07	9.14E+07	1.34E+08	1.78E+08	1.95E+08	8.82E+07	1.99E+08	3.60E+08	4.04E+08	4.04E+08
181	1st	3rd	H1	16	6.19E+08	6.19E+08	9.81E+08	1.38E+09	2.16E+09	2.18E+09	8.48E+08	3.01E+09	3.20E+09	3.24E+09	3.24E+09
181	1st	3rd	H2	15	3.08E+08	3.08E+08	2.04E+09	2.34E+09	2.86E+09	2.83E+09	8.98E+08	3.50E+09	3.72E+09	4.48E+09	4.48E+09
181	1st	3rd	H3	14	1.62E+08	1.62E+08	1.75E+08	2.54E+08	3.21E+08	3.53E+08	1.37E+08	4.48E+08	6.00E+08	6.18E+08	6.18E+08
181	2nd	3rd	H1	16	1.73E+07	1.73E+07	1.45E+08	5.55E+08	1.82E+09	1.87E+09	1.42E+09	2.93E+09	3.80E+09	4.75E+09	4.75E+09
181	2nd	3rd	H2	16	1.43E+08	1.43E+08	1.44E+08	4.12E+08	1.07E+09	1.09E+09	7.61E+08	1.85E+09	2.18E+09	2.22E+09	2.22E+09
181	2nd	3rd	H3	15	6.33E+06	6.33E+06	6.06E+07	1.27E+08	3.72E+08	3.31E+08	2.00E+08	5.13E+08	5.33E+08	5.59E+08	5.59E+08
181	Last	3rd	H1	17	3.02E+08	3.02E+08	8.67E+08	1.16E+09	1.70E+09	1.52E+09	5.27E+08	1.90E+09	2.11E+09	2.15E+09	2.15E+09
181	Last	3rd	H2	16	4.23E+08	4.23E+08	4.45E+08	5.78E+08	8.07E+08	7.69E+08	1.97E+08	9.02E+08	1.00E+09	1.06E+09	1.06E+09
181	Last	3rd	H3	16	1.11E+08	1.11E+08	1.23E+08	1.40E+08	2.09E+08	1.92E+08	4.91E+07	2.37E+08	2.44E+08	2.50E+08	2.50E+08
167	1st	3rd	H1	33	6.97E+08	6.97E+08	2.31E+09	3.29E+09	4.19E+09	3.88E+09	1.26E+09	4.56E+09	5.26E+09	5.40E+09	5.40E+09
167	1st	3rd	H2	32	1.97E+08	1.97E+08	1.14E+09	1.60E+09	1.81E+09	1.67E+09	4.87E+08	1.91E+09	2.10E+09	2.15E+09	2.15E+09
167	1st	3rd	H3	21	2.78E+08	2.78E+08	2.93E+08	4.19E+08	5.20E+08	4.93E+08	1.23E+08	5.64E+08	6.51E+08	6.55E+08	6.55E+08
167	2nd	3rd	H1	34	1.07E+08	4.93E+08	6.93E+08	1.09E+09	4.40E+09	6.70E+09	6.57E+09	1.04E+10	1.83E+10	1.96E+10	2.17E+10
167	2nd	3rd	H2	33	1.46E+08	1.81E+08	1.95E+08	3.82E+08	1.23E+09	1.93E+09	1.90E+09	2.98E+09	5.15E+09	6.03E+09	6.39E+09
167	2nd	3rd	H3	22	2.56E+07	6.49E+07	7.66E+07	1.26E+08	2.60E+08	1.71E+09	5.93E+09	4.65E+08	9.29E+08	2.79E+09	2.75E+10
167	Last	3rd	H1	35	2.19E+09	2.64E+09	3.27E+09	3.92E+09	4.85E+09	5.13E+09	2.07E+09	5.82E+09	7.56E+09	7.77E+09	1.38E+10
167	Last	3rd	H2	34	3.27E+08	4.00E+08	5.09E+08	5.94E+08	7.16E+08	7.95E+08	3.34E+08	9.11E+08	1.13E+09	1.33E+09	2.16E+09
167	Last	3rd	H3	23	4.32E+07	6.58E+07	8.27E+07	1.24E+08	1.50E+08	1.43E+08	4.51E+07	1.71E+08	1.94E+08	2.04E+08	2.28E+08
178	1st	3rd	H1	17	3.97E+09	4.02E+09	4.17E+09	4.74E+09	5.86E+09	5.77E+09	1.17E+09	6.57E+09	7.66E+09	7.70E+09	8.13E+09
178	1st	3rd	H2	17	5.24E+08	6.06E+08	6.54E+08	7.56E+08	8.98E+08	8.75E+08	1.69E+08	9.94E+08	1.09E+09	1.11E+09	1.24E+09
178	1st	3rd	H3	16	8.58E+07	9.56E+07	1.12E+08	1.36E+08	1.51E+08	1.56E+08	3.77E+07	1.84E+08	2.00E+08	2.25E+08	2.26E+08
178	2nd	3rd	H1	18	5.50E+07	5.50E+07	9.77E+07	6.39E+08	1.91E+09	4.20E+09	4.42E+09	8.05E+09	9.54E+09	1.38E+10	1.38E+10
178	2nd	3rd	H2	17	1.87E+07	1.87E+07	1.58E+08	8.66E+08	1.70E+09	3.58E+09	3.44E+09	7.40E+09	8.01E+09	9.65E+09	9.65E+09
178	2nd	3rd	H3	17	3.97E+07	3.97E+07	1.12E+08	2.96E+08	3.79E+08	6.55E+08	4.93E+08	1.15E+09	1.25E+09	1.60E+09	1.60E+09

B.41

Table B.6. (continued)

Pile ID	Impact Time Series		Hydrophone	Number of Impacts	Sound Exposure Level (Pa ²)										
					Minimum	5 th	10 th	25 th	50 th (Median)	Average	st dev	75 th	90 th	95 th	Maximum
178	Last	3rd	H1	18	1.62E+09	1.62E+09	1.86E+09	4.80E+09	5.93E+09	5.50E+09	2.00E+09	7.30E+09	7.59E+09	7.77E+09	7.77E+09
178	Last	3rd	H2	18	1.80E+09	1.80E+09	2.44E+09	6.64E+09	9.29E+09	7.87E+09	3.25E+09	1.06E+10	1.11E+10	1.11E+10	1.11E+10
178	Last	3rd	H3	17	5.26E+08	5.26E+08	6.02E+08	1.00E+09	1.11E+09	1.05E+09	2.17E+08	1.19E+09	1.27E+09	1.31E+09	1.31E+09
244	1st	3rd	H1	17	6.46E+09	6.46E+09	6.47E+09	6.95E+09	7.16E+09	7.24E+09	4.81E+08	7.69E+09	7.80E+09	8.21E+09	8.21E+09
244	1st	3rd	H2	16	8.97E+09	8.97E+09	9.69E+09	1.05E+10	1.10E+10	1.10E+10	9.10E+08	1.15E+10	1.21E+10	1.28E+10	1.28E+10
244	1st	3rd	H3	16	7.00E+08	7.00E+08	8.23E+08	9.65E+08	1.04E+09	1.09E+09	2.16E+08	1.26E+09	1.40E+09	1.41E+09	1.41E+09
244	2nd	3rd	H1	18	2.37E+07	2.37E+07	2.50E+07	1.13E+09	4.24E+09	3.83E+09	2.80E+09	4.86E+09	7.93E+09	9.07E+09	9.07E+09
244	2nd	3rd	H2	17	6.06E+07	6.06E+07	7.54E+08	1.66E+09	1.92E+09	2.47E+09	1.80E+09	2.77E+09	5.64E+09	7.01E+09	7.01E+09
244	2nd	3rd	H3	16	2.26E+08	2.26E+08	3.08E+08	7.67E+08	9.12E+08	1.09E+09	6.36E+08	1.29E+09	1.99E+09	2.76E+09	2.76E+09
244	Last	3rd	H1	19	2.07E+08	2.07E+08	7.92E+08	1.56E+09	1.97E+09	2.98E+09	3.16E+09	2.52E+09	1.07E+10	1.21E+10	1.21E+10
244	Last	3rd	H2	18	2.05E+08	2.05E+08	4.89E+08	1.05E+09	1.21E+09	1.56E+09	1.43E+09	1.55E+09	2.28E+09	6.80E+09	6.80E+09
244	Last	3rd	H3	17	1.34E+08	1.34E+08	3.14E+08	3.63E+08	4.35E+08	5.65E+08	5.55E+08	5.02E+08	8.15E+08	2.58E+09	2.58E+09

APPENDIX C

**Plots Showing Root Mean Square Pressure,
Peak Positive Pressure, and Peak Negative
Pressure at Each Sampled Impact for Each
Pile**

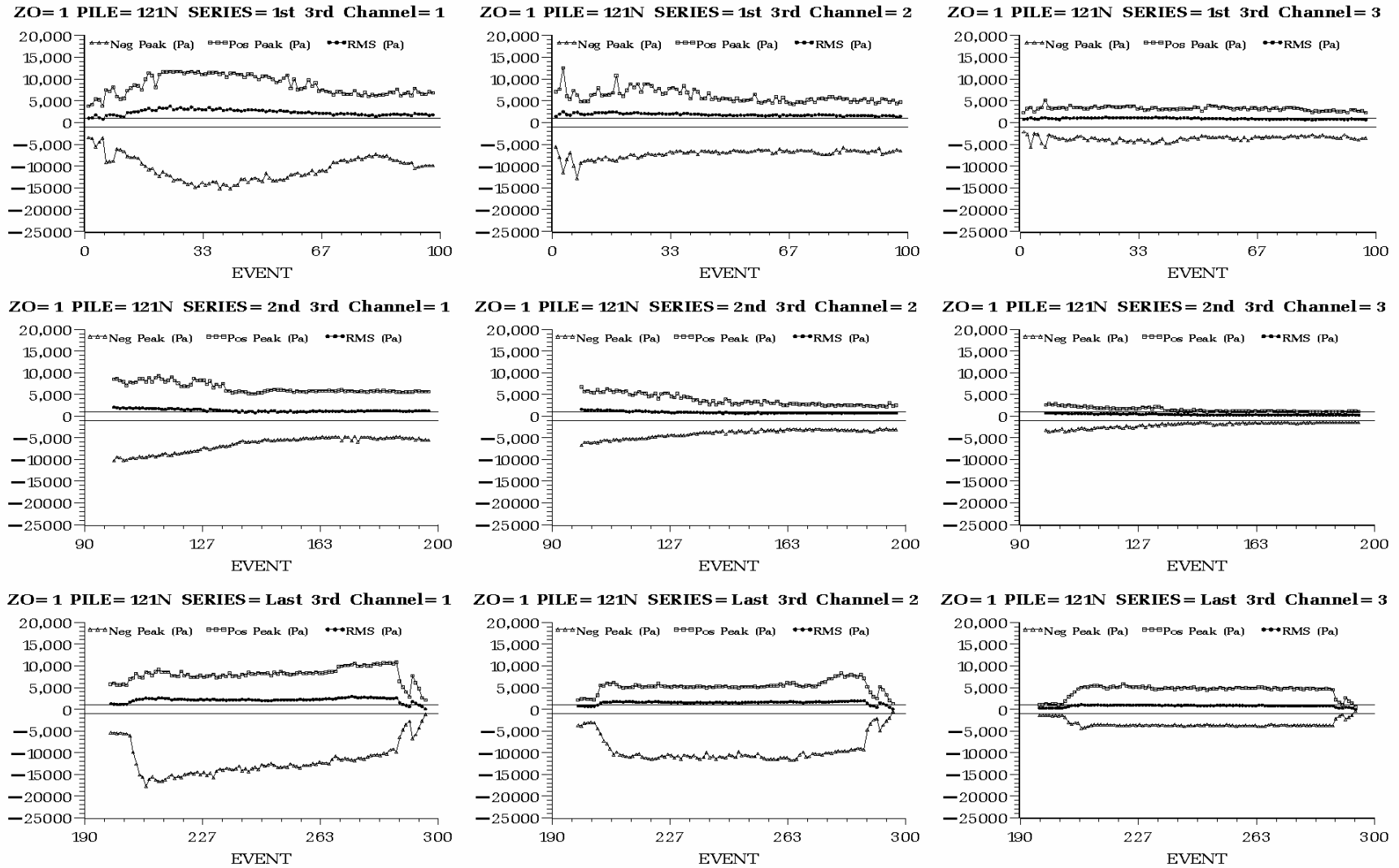

Figure C.1. Peak Positive, Peak Negative, and Root Mean Square Sound Pressure (Pa) of Each Impact at Plumb Pile 121N Driven in 42 ft Water with a Type II Confined Bubble Curtain in Place. Plots are arranged by hydrophone H1 (left) to H3 (right) and by impact series, each containing one third of the impacts, from first third (top) to last third (bottom).

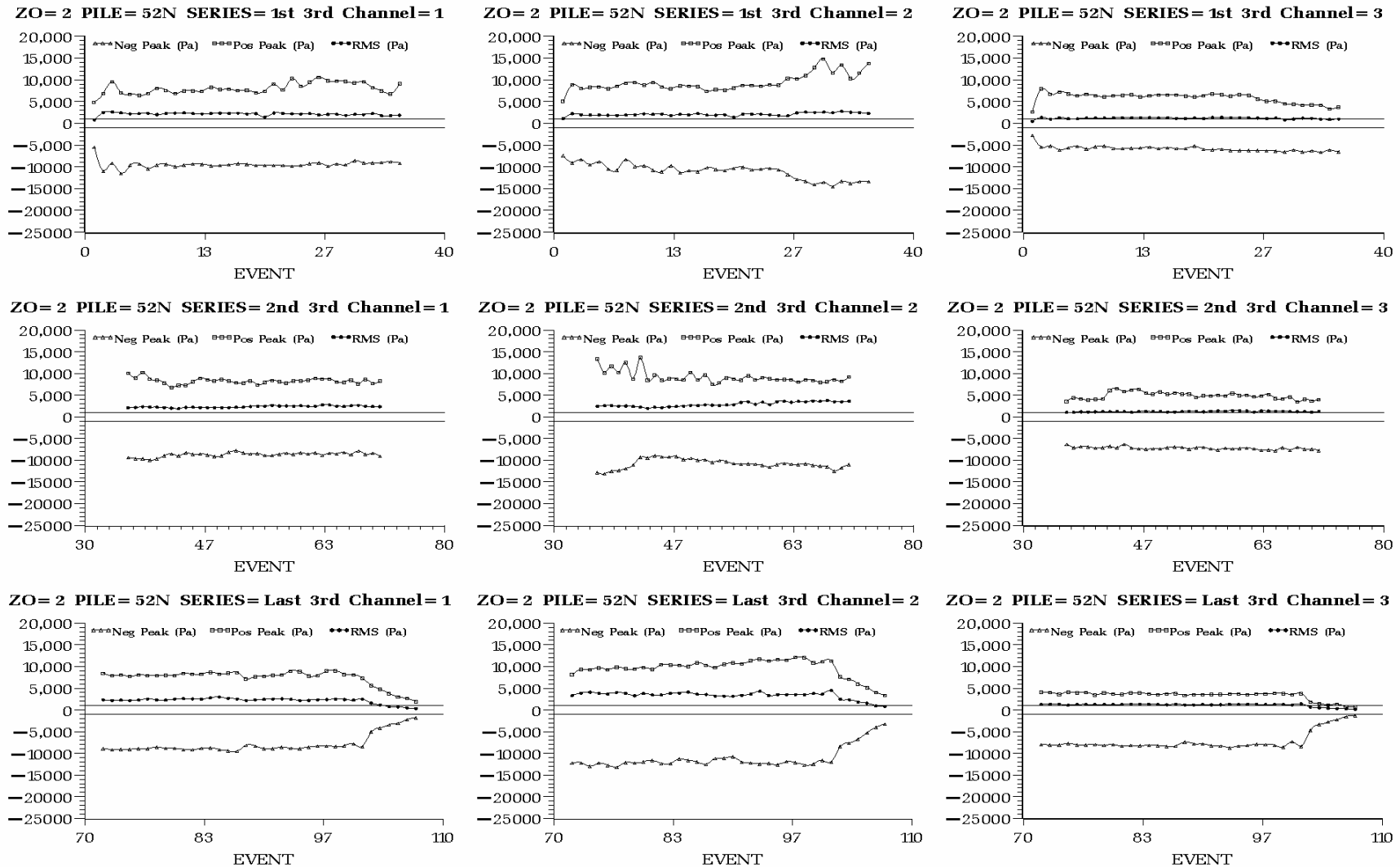

Figure C.2. Peak Positive, Peak Negative, and Root Mean Square Sound Pressure (Pa) of Each Impact at Plumb Pile 52N Driven in 40 ft Water with Type II Confined Bubble Curtain in Place. Plots are arranged by hydrophone H1 (left) to H3 (right) and by impact series, each containing one third of the impacts, from first third (top) to last third (bottom).

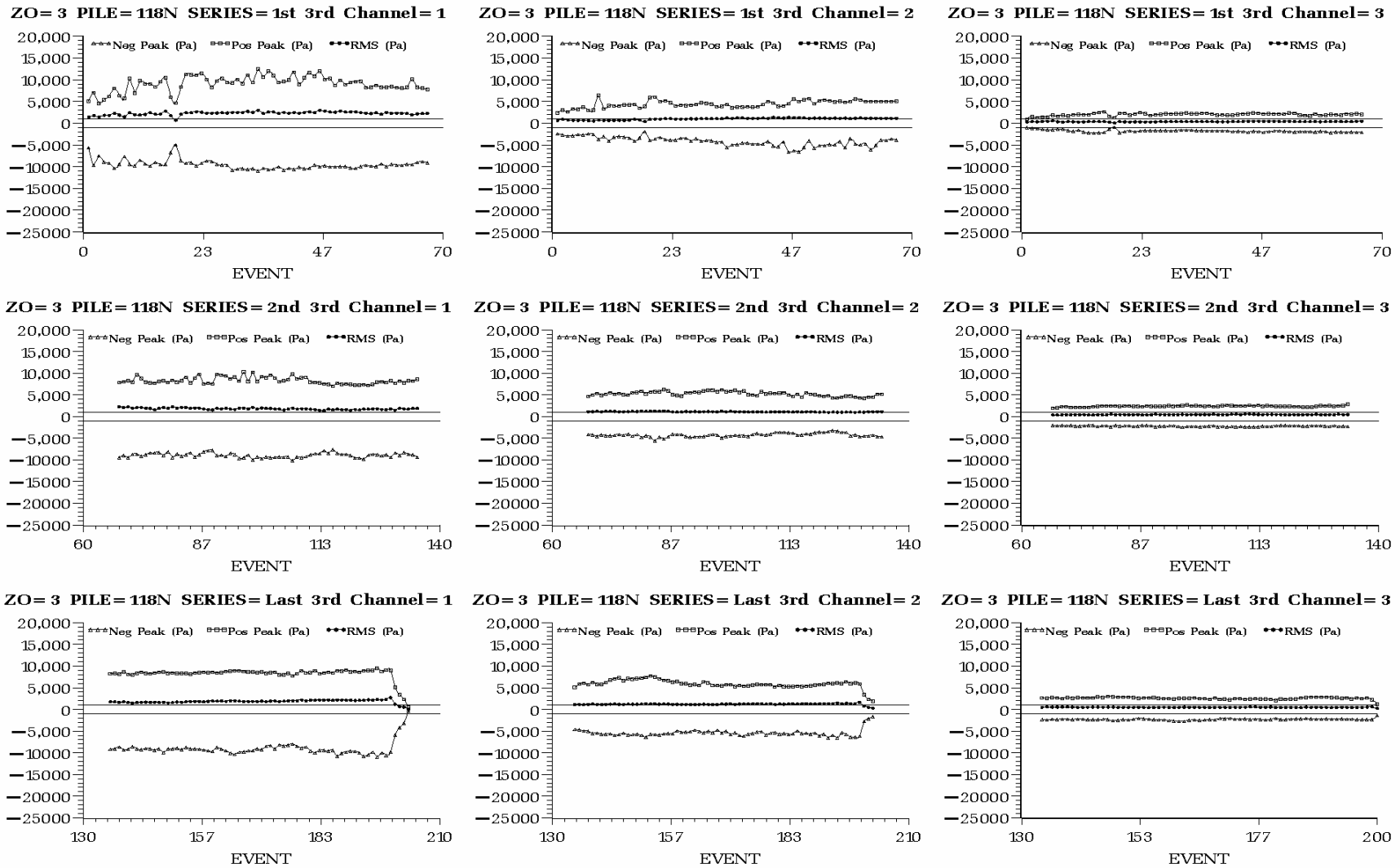

Figure C.3. Peak Positive, Peak Negative, and Root Mean Square Sound Pressure (Pa) of Each Impact at Plumb Pile 118N Driven in 39 ft of Water with Type II Confined Bubble Curtain in Place. Plots are arranged by hydrophone H1 (left) to H3 (right) and by impact series, each containing one third of the impacts, from first third (top) to last third (bottom).

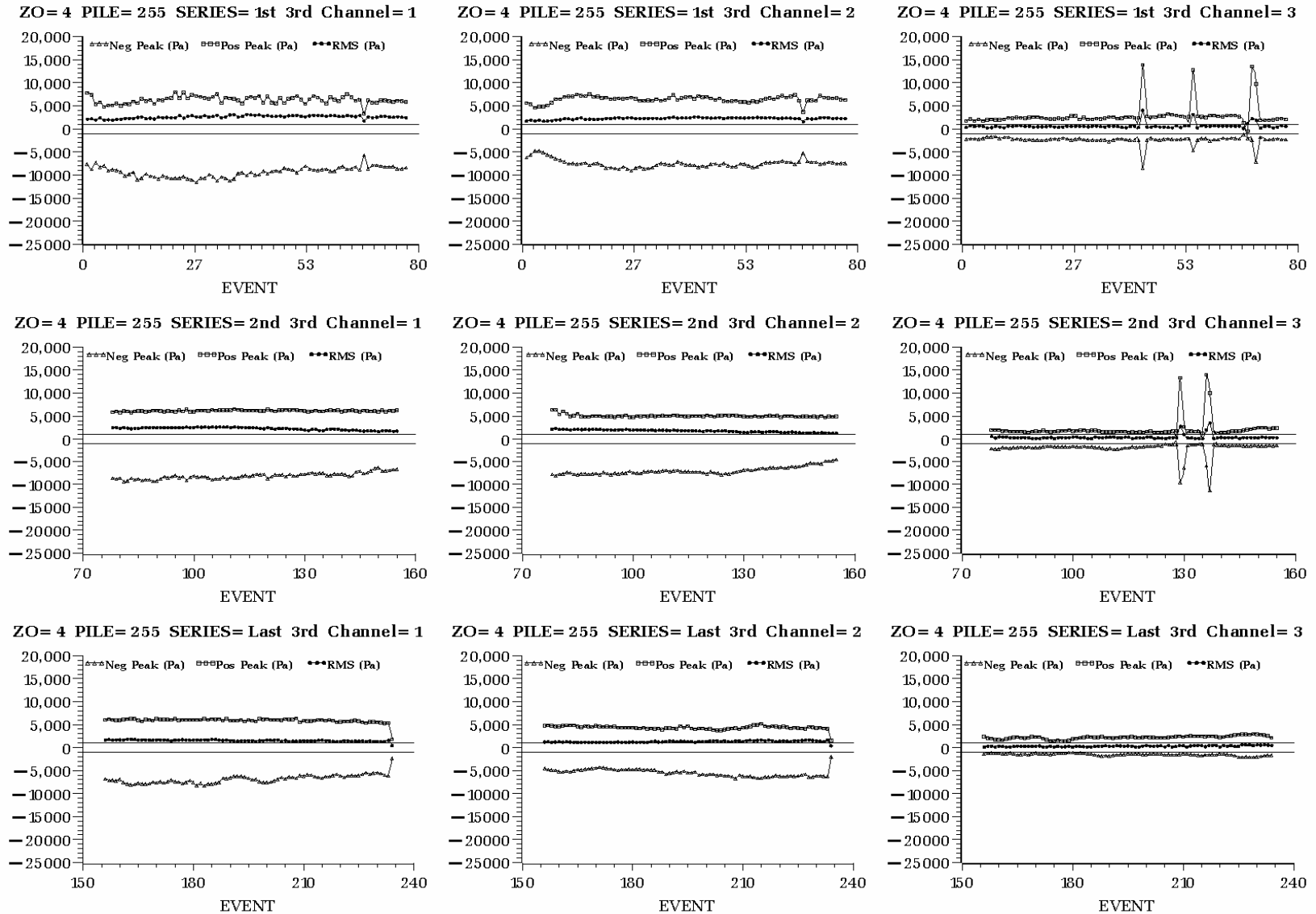

Figure C.4. Peak Positive, Peak Negative, and Root Mean Square Sound Pressure (Pa) of Each Impact at Plumb Pile 255 Driven in 33 ft of Water with Type II Confined Bubble Curtain in Place. Plots are arranged by hydrophone H1 (left) to H3 (right) and by impact series, each containing one third of the impacts, from first third (top) to last third (bottom).

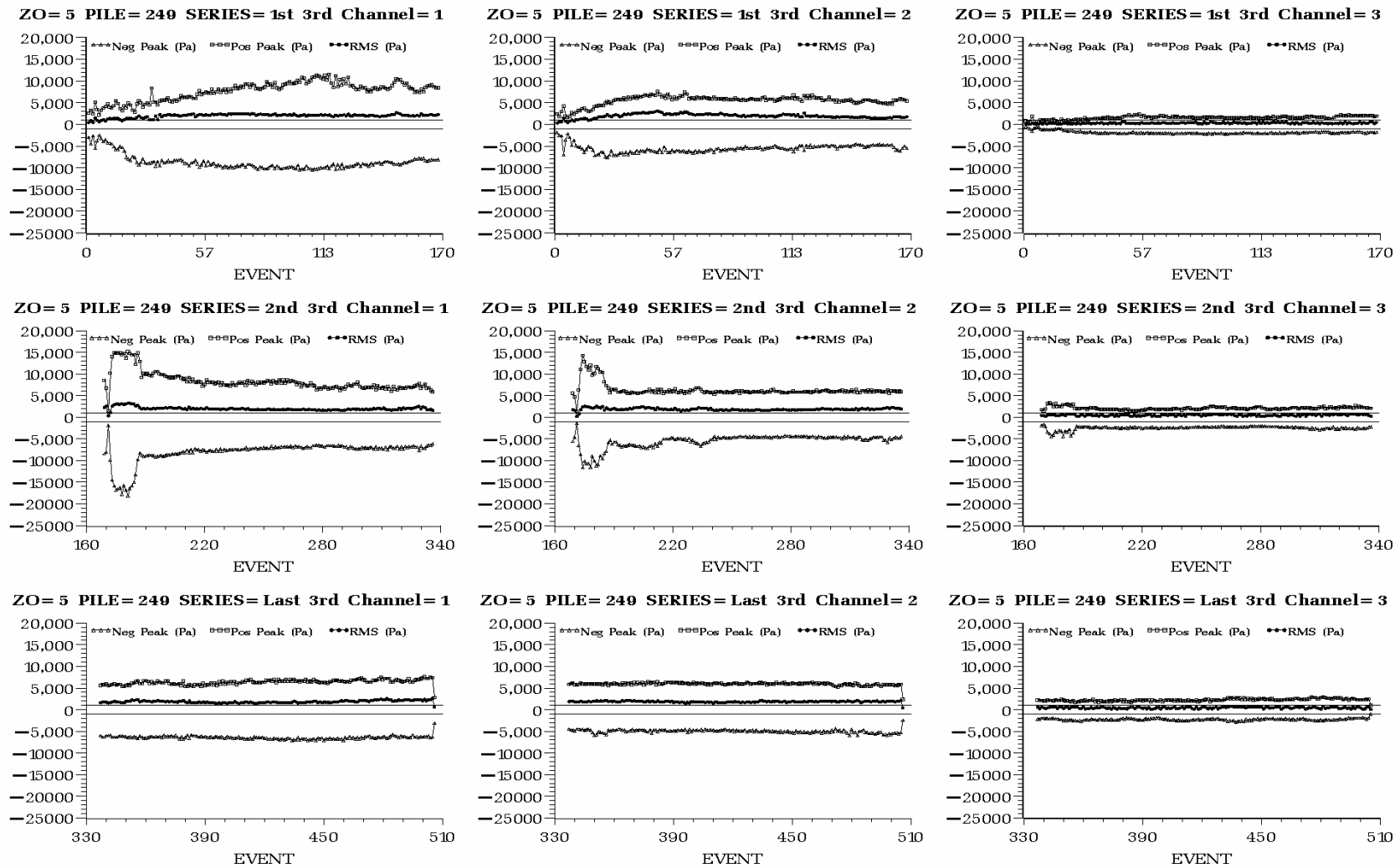

Figure C.5. Peak Positive, Peak Negative, and Root Mean Square Sound Pressure (Pa) of Each Impact on Plumb Pile 249 Driven at Hood Canal Bridge in 32 ft of Water with a Type II Confined Bubble Curtain in Place. Plots are arranged by hydrophone H1 (left) to H3 (right) and by impact series, each containing one third of the impacts, from first third (top) to last third (bottom).

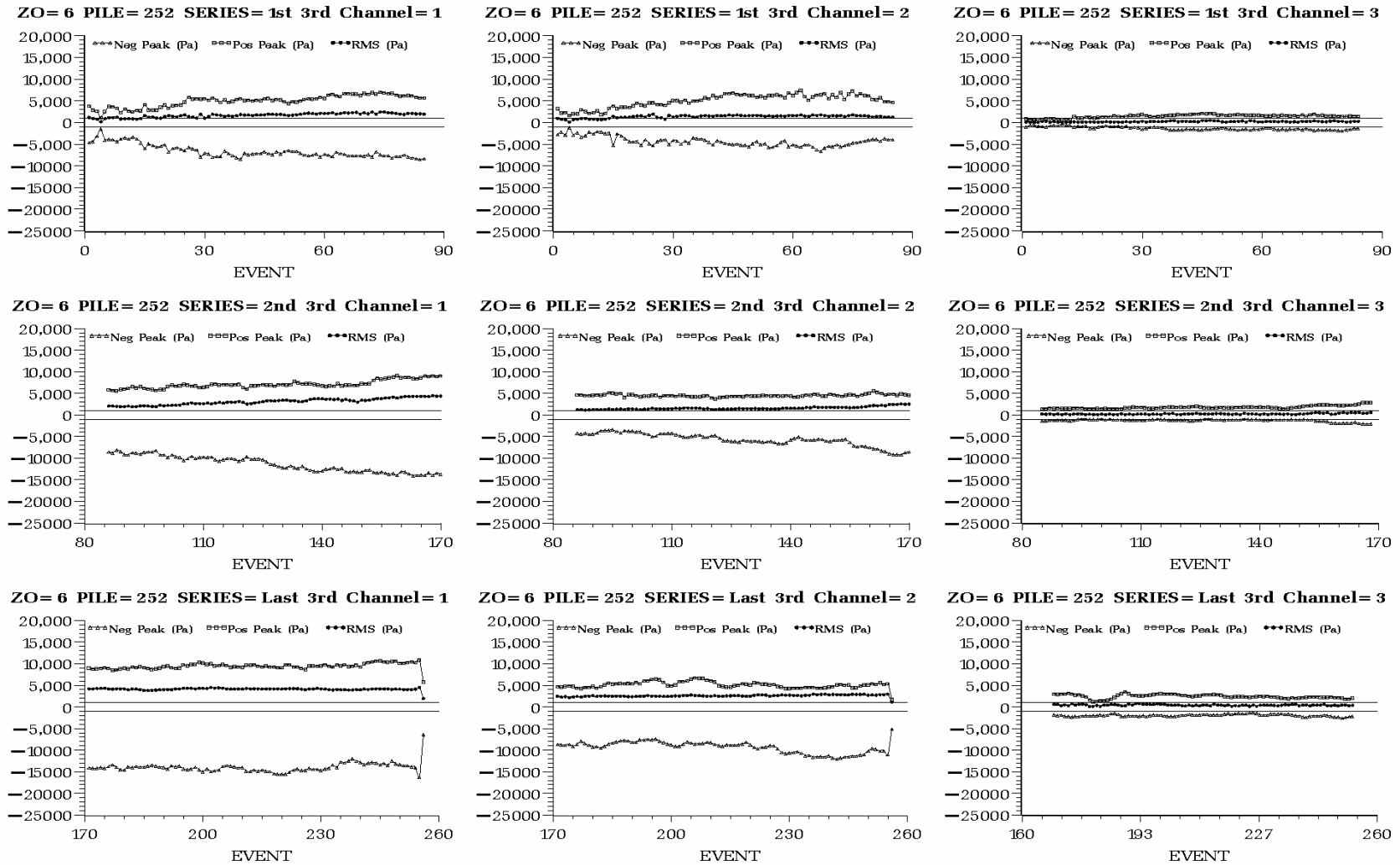

Figure C.6. Peak Positive, Peak Negative, and Root Mean Square Sound Pressure (Pa) of Each Impact on Plumb Pile 252 Driven at Hood Canal Bridge in 31 ft of Water with a Type II Confined Bubble Curtain in Place. Plots are arranged by hydrophone H1 (left) to H3 (right) and by impact series, each containing one third of the impacts, from first third (top) to last third (bottom).

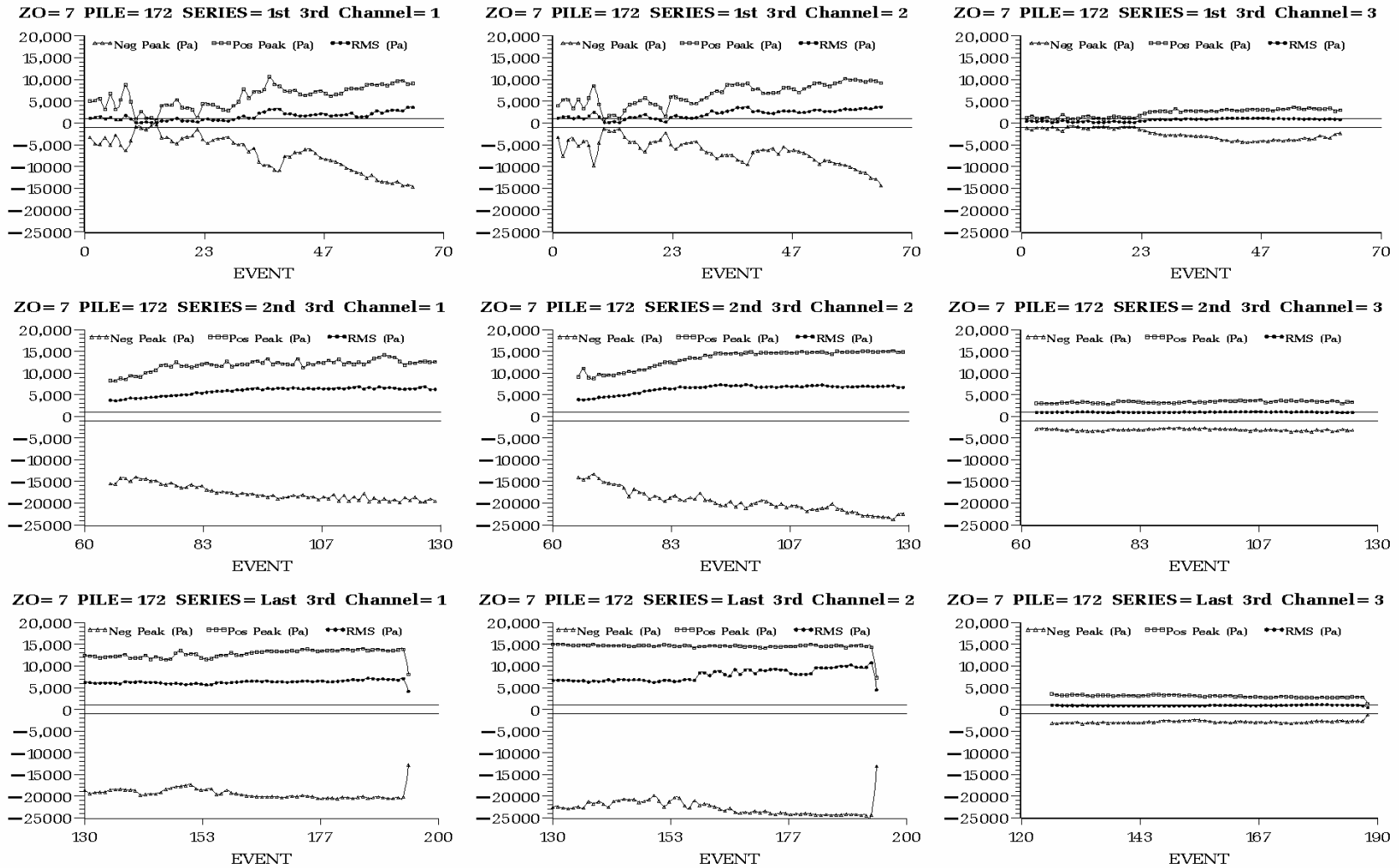

Figure C.7. Peak Positive, Peak Negative, and Root Mean Square Sound Pressure (Pa) of Each Impact on Plumb Pile 172 Driven at Hood Canal Bridge in 20 ft of Water with a Type II Confined Bubble Curtain in Place. Plots are arranged by hydrophone H1 (left) to H3 (right) and by impact series, each containing one third of the impacts, from first third (top) to last third (bottom).

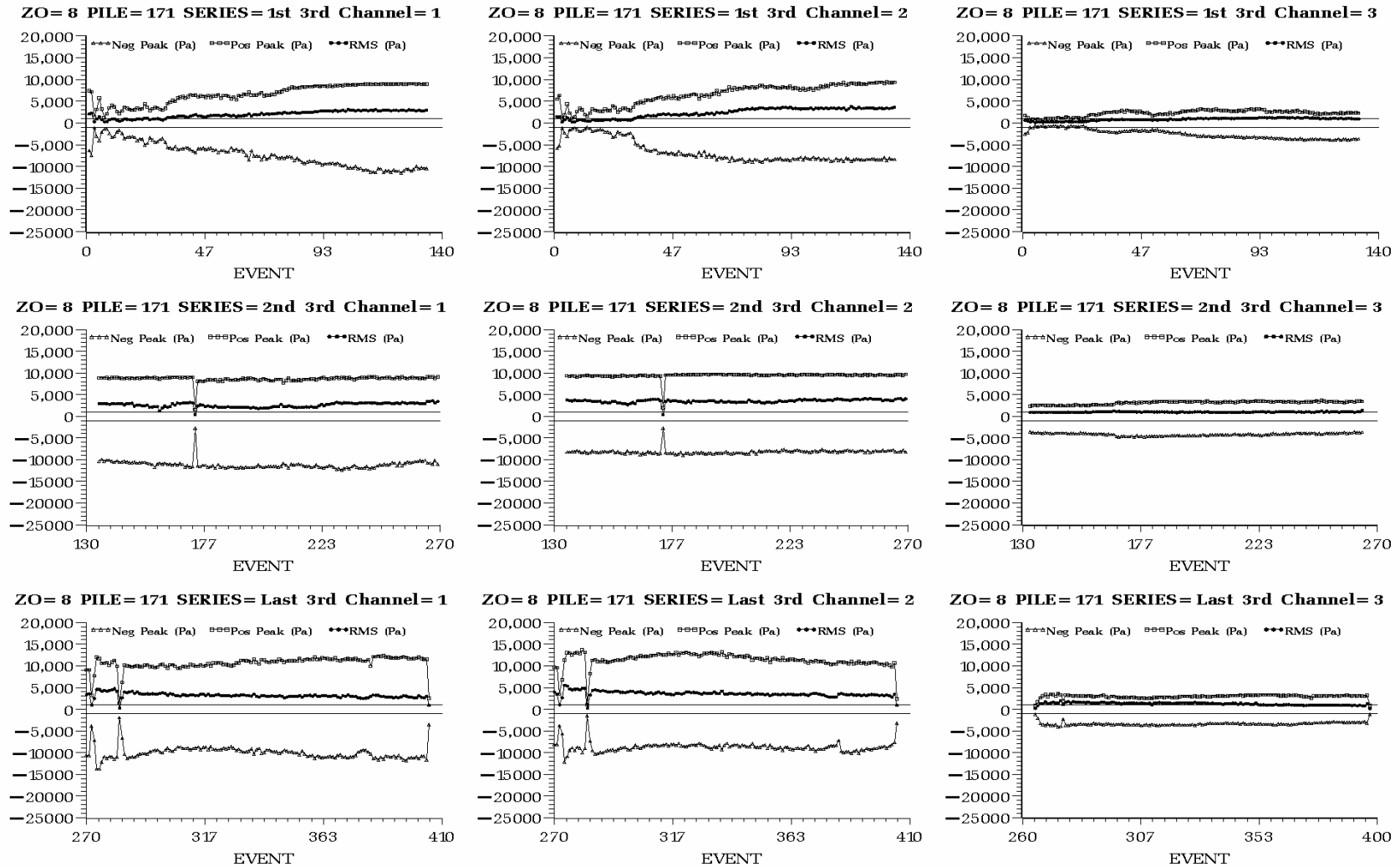

Figure C.8. Peak Positive, Peak Negative, and Root Mean Square Sound Pressure (Pa) of Each Impact on Plumb Pile 171 Driven at Hood Canal Bridge in 18 ft of Water with a Type II Confined Bubble Curtain in Place. Plots are arranged by hydrophone H1 (left) to H3 (right) and by impact series, each containing one third of the impacts, from first third (top) to last third (bottom).

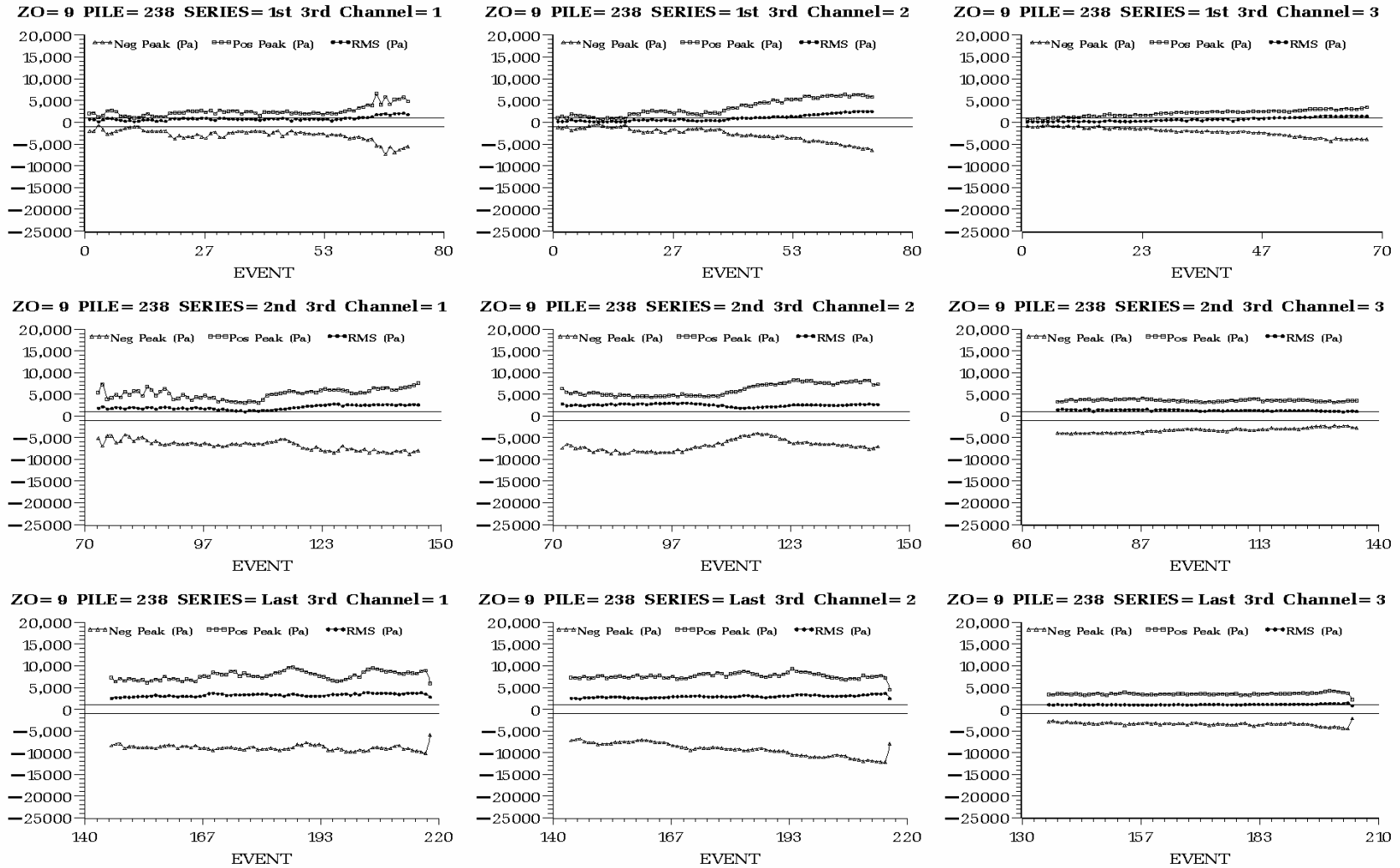

Figure C.9. Peak Positive, Peak Negative, and Root Mean Square Sound Pressure (Pa) of Each Impact on Plumb Pile 238 Driven at Hood Canal Bridge in 7 ft of Water with a Type II Confined Bubble Curtain in Place. Plots are arranged by hydrophone H1 (left) to H3 (right) and by impact series, each containing one third of the impacts, from first third (top) to last third (bottom).

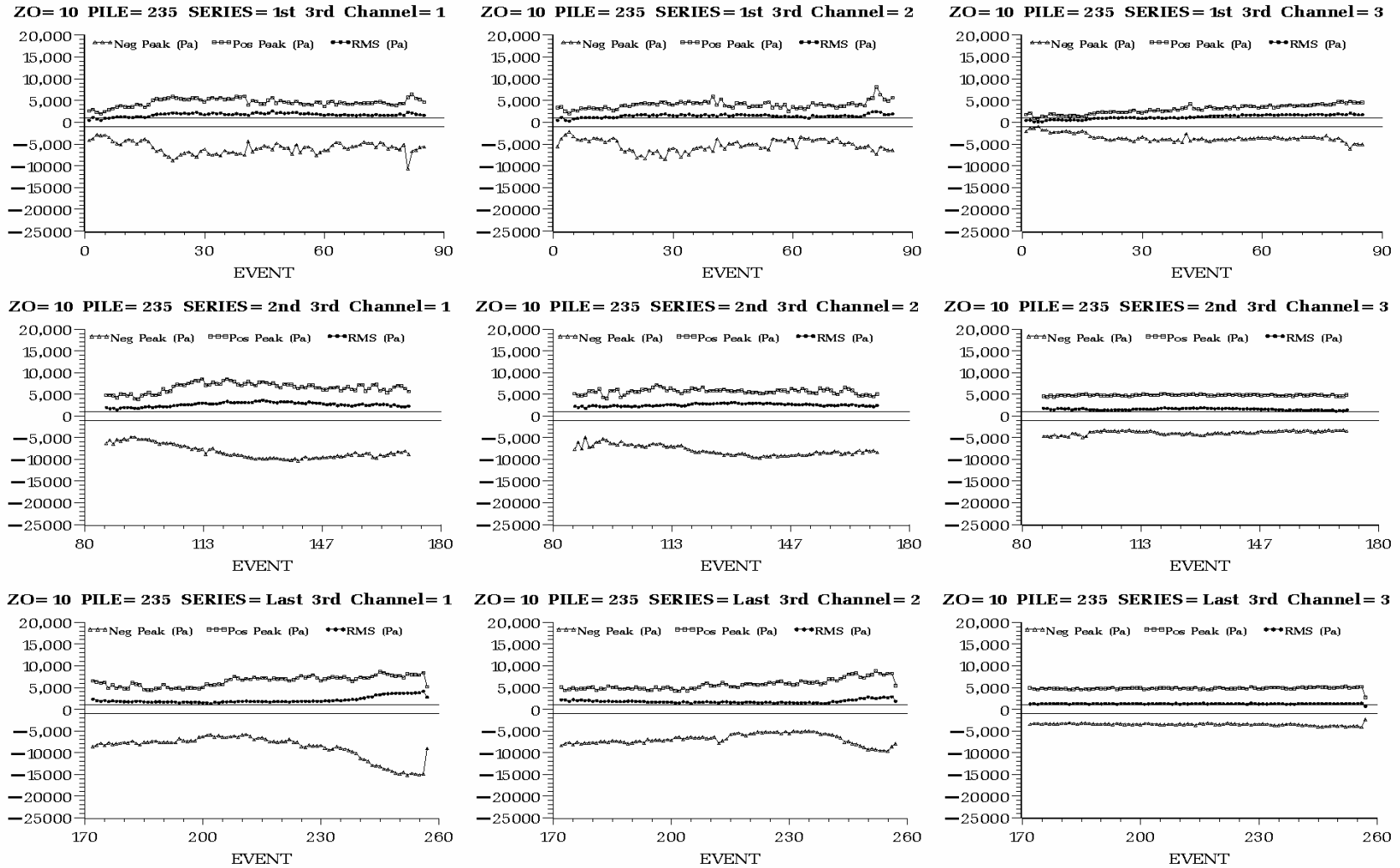

Figure C.10. Peak Positive, Peak Negative, and Root Mean Square Sound Pressure (Pa) of Each Impact on Plumb Pile 235 Driven at Hood Canal Bridge in 4.5 ft of Water with a Type II Confined Bubble Curtain in Place. Plots are arranged by hydrophone H1 (left) to H3 (right) and by impact series, each containing one third of the impacts, from first third (top) to last third (bottom).

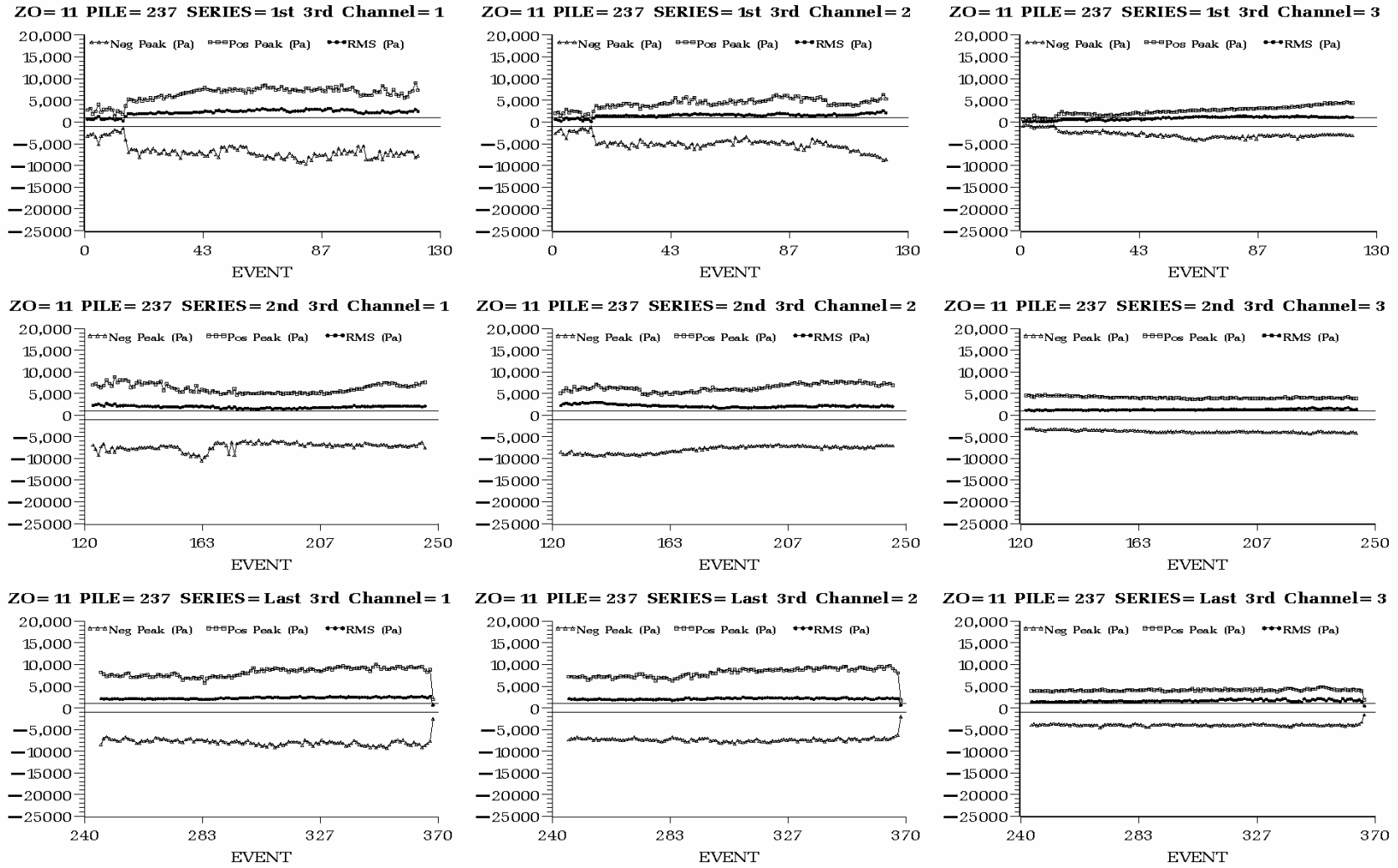

Figure C.11. Peak Positive, Peak Negative, and Root Mean Square Sound Pressure (Pa) of Each Impact on Plumb Pile 237 Driven at Hood Canal Bridge in 4 ft of Water with a Type II Confined Bubble Curtain in Place. Plots are arranged by hydrophone H1 (left) to H3 (right) and by impact series, each containing one third of the impacts, from first third (top) to last third (bottom).

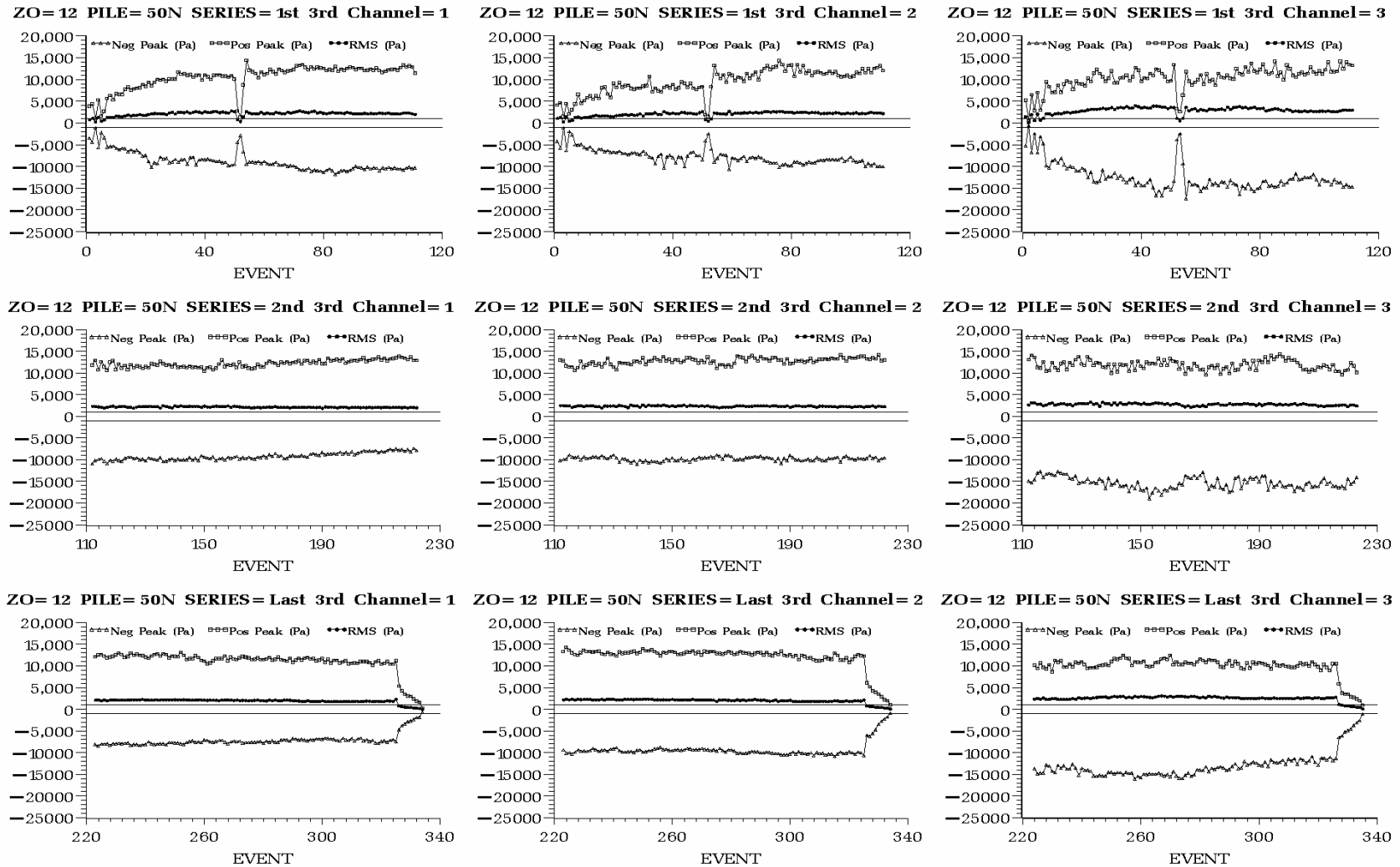

Figure C.12. Peak Positive, Peak Negative, and Root Mean Square Sound Pressure (Pa) of Each Impact on Plumb Pile 50N Driven at Hood Canal Bridge in 40 ft of Water with No Bubble Curtain in Place. Plots are arranged by hydrophone H1 (left) to H3 (right) and by impact series, each containing one third of the impacts, from first third (top) to last third (bottom).

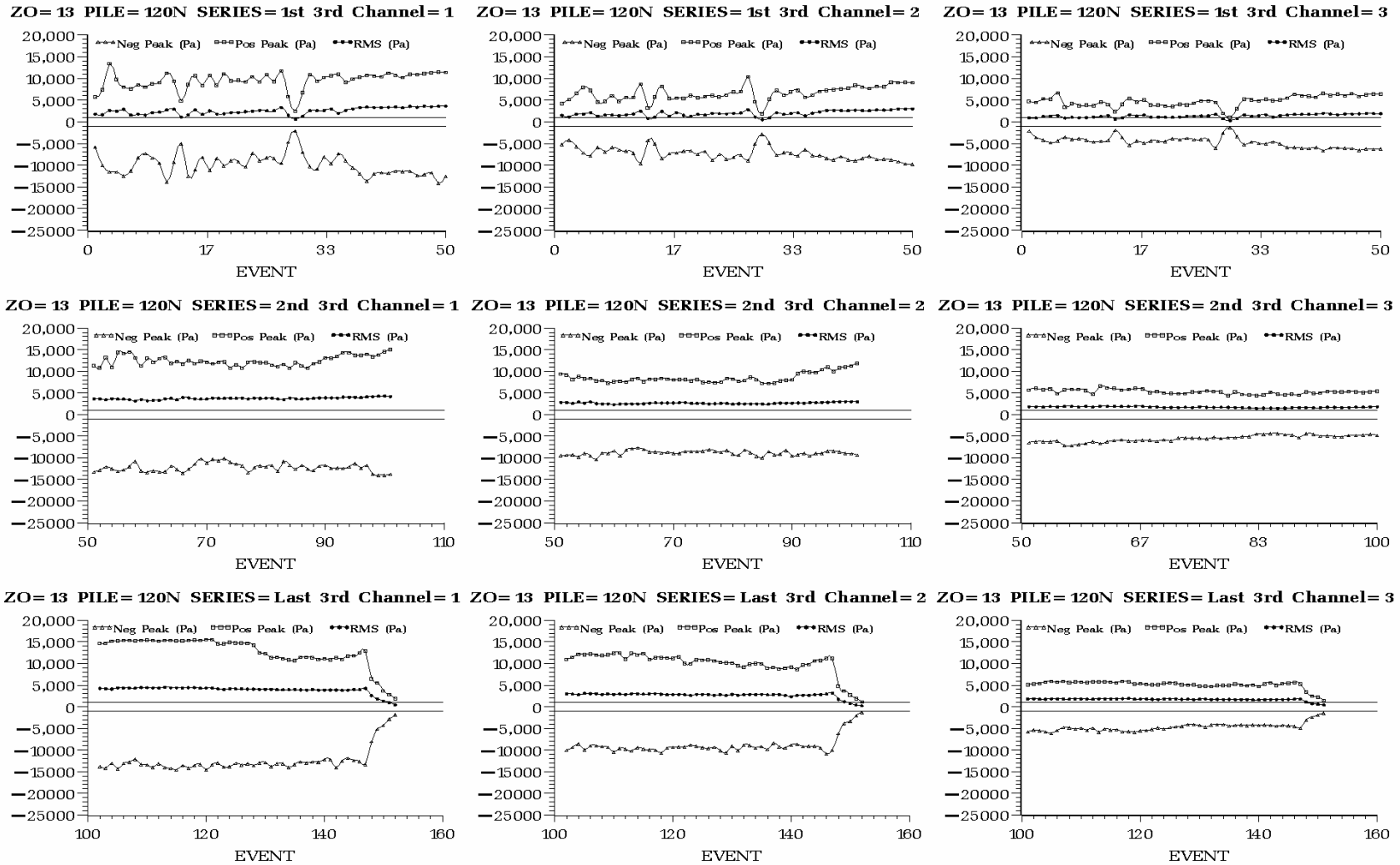

Figure C.13. Peak Positive, Peak Negative, and Root Mean Square Sound Pressure (Pa) of Each Impact on Plumb Pile 120N Driven at Hood Canal Bridge in 39 ft of Water with No Bubble Curtain in Place. Plots are arranged by hydrophone H1 (left) to H3 (right) and by impact series, each containing one third of the impacts, from first third (top) to last third (bottom).

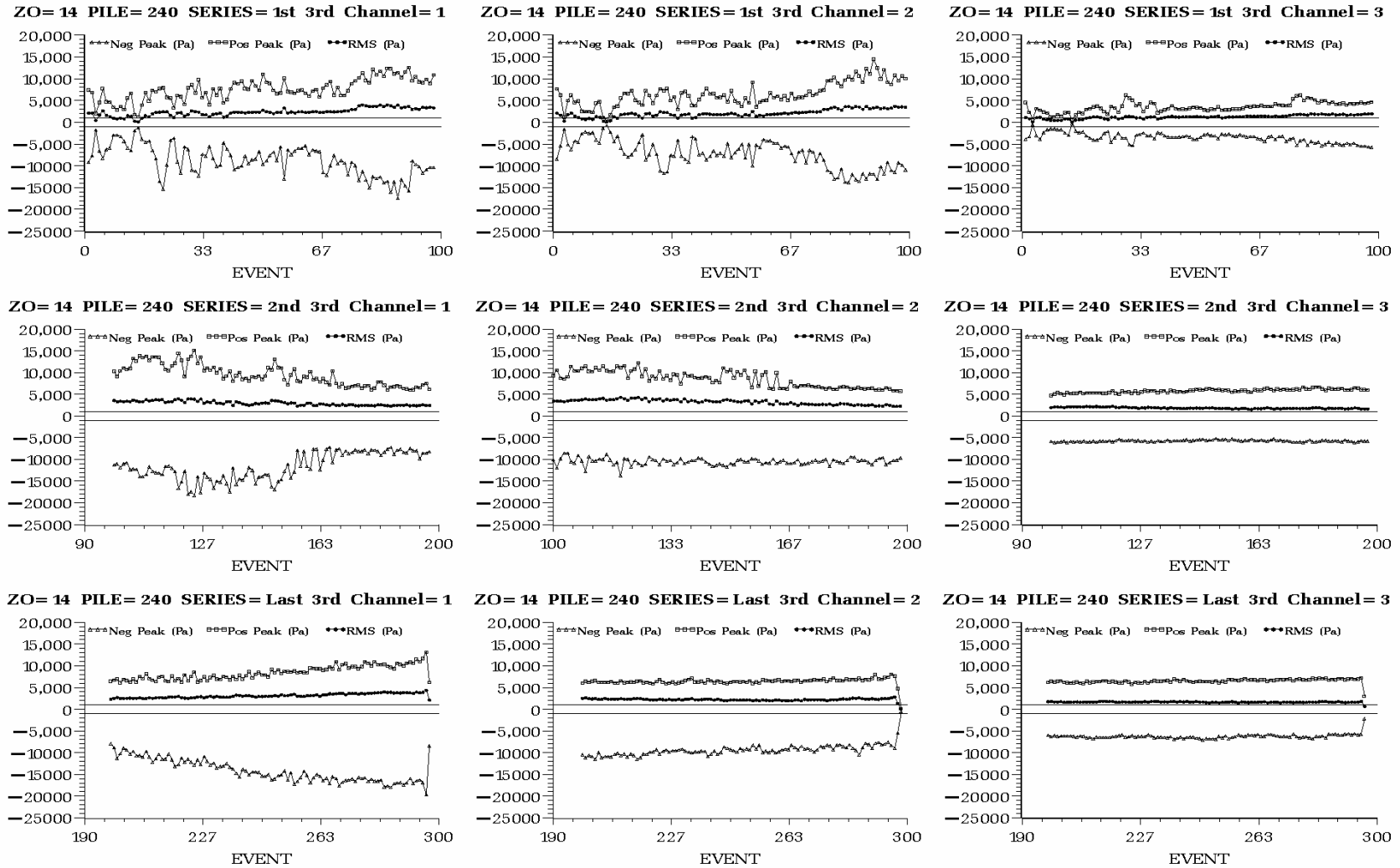

Figure C.14. Peak Positive, Peak Negative, and Root Mean Square Sound Pressure (Pa) of Each Impact on Plumb Pile 240 Driven at Hood Canal Bridge in 9 ft of Water with No Bubble Curtain in Place. Plots are arranged by hydrophone H1 (left) to H3 (right) and by impact series, each containing one third of the impacts, from first third (top) to last third (bottom).

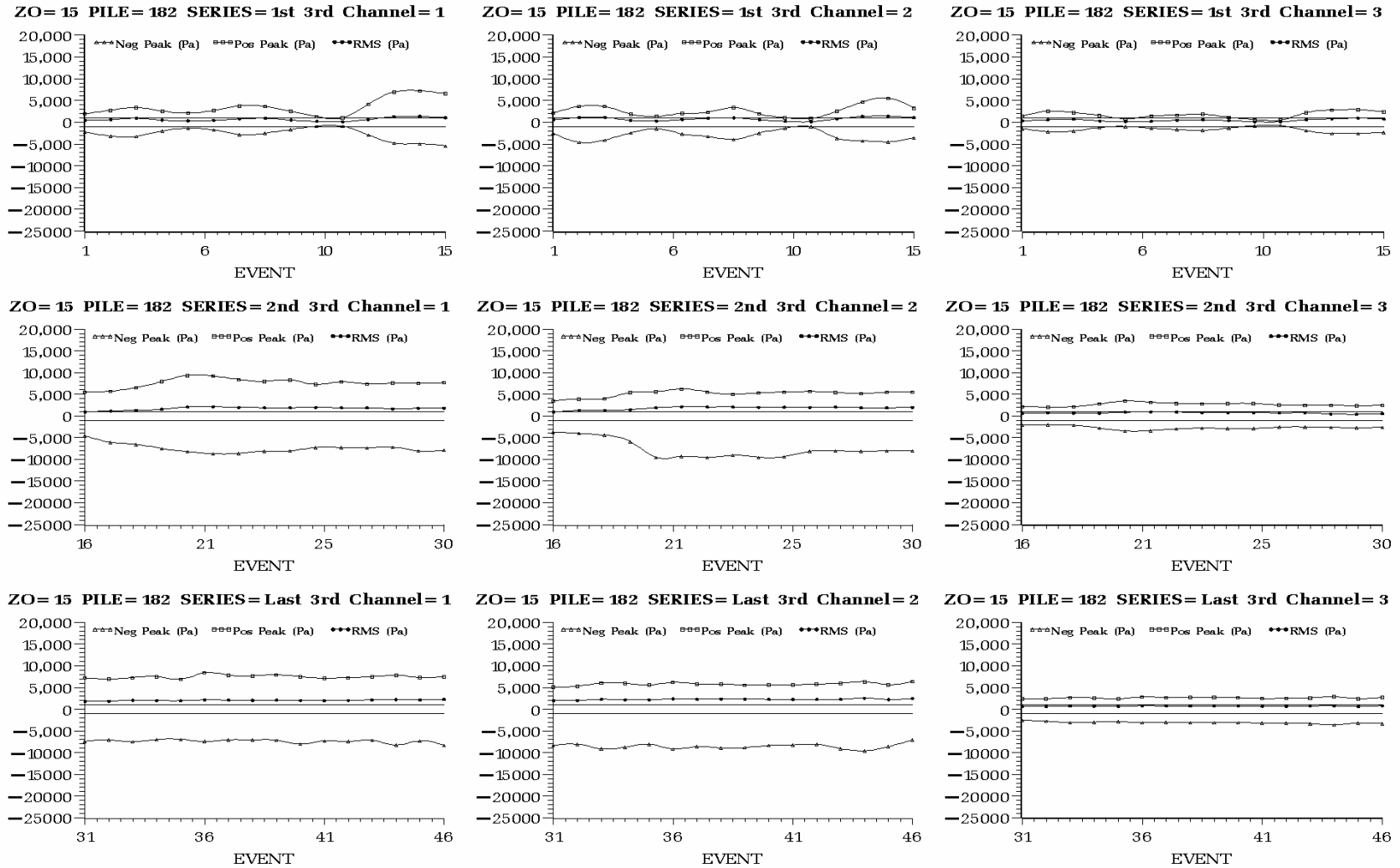

Figure C.15. Peak Positive, Peak Negative, and Root Mean Square Sound Pressure (Pa) of Each Impact on Batter Pile 182 Driven at Hood Canal Bridge in 41 ft of Water with a Type I Unconfined Bubble Curtain in Place. Plots are arranged by hydrophone H1 (left) to H3 (right) and by impact series, each containing one third of the impacts, from first third (top) to last third (bottom).

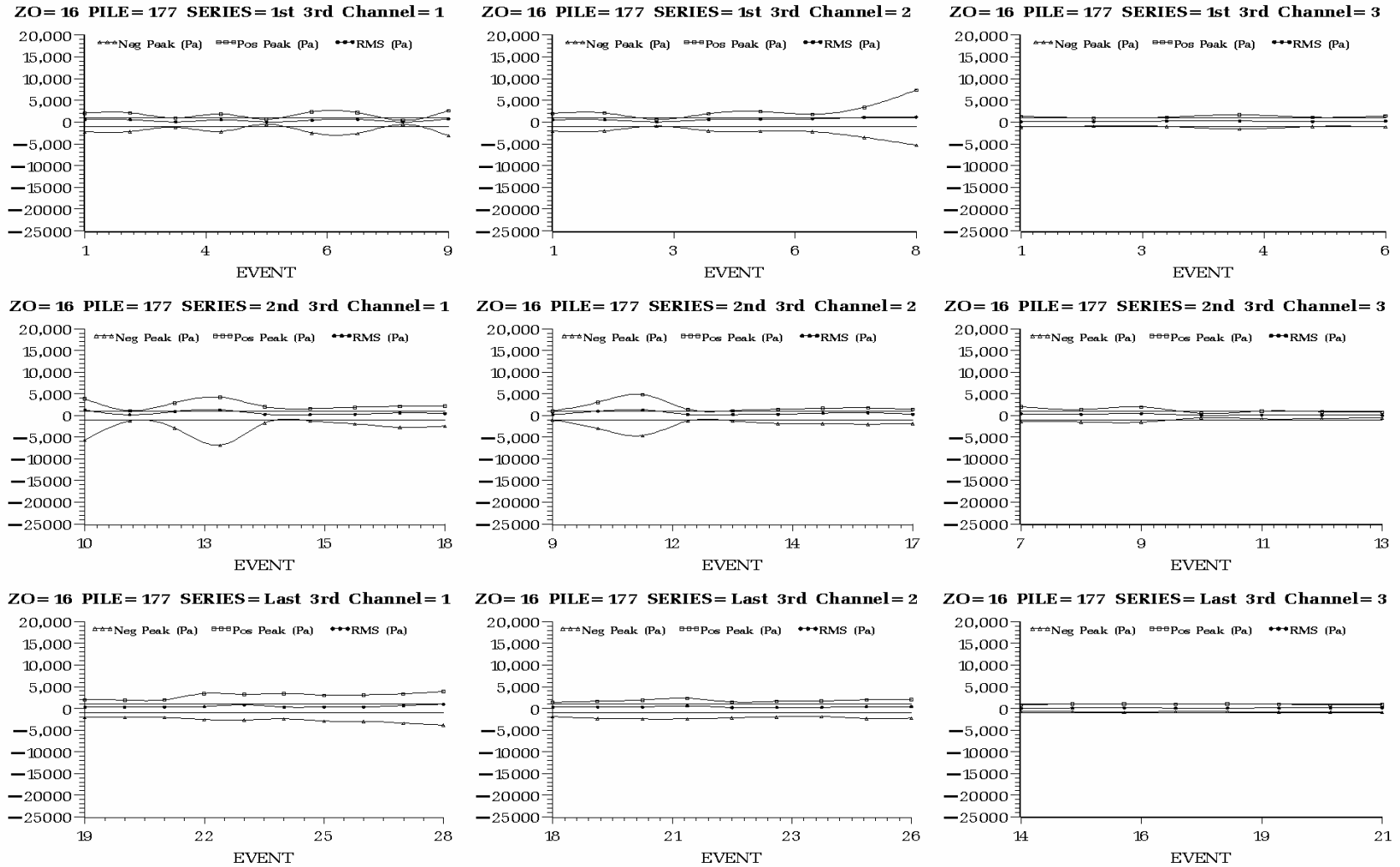

Figure C.16. Peak Positive, Peak Negative, and Root Mean Square Sound Pressure (Pa) of Each Impact on Batter Pile 177 Driven at Hood Canal Bridge in 37 ft of Water with a Type I Unconfined Bubble Curtain in Place. Plots are arranged by hydrophone H1 (left) to H3 (right) and by impact series, each containing one third of the impacts, from first third (top) to last third (bottom).

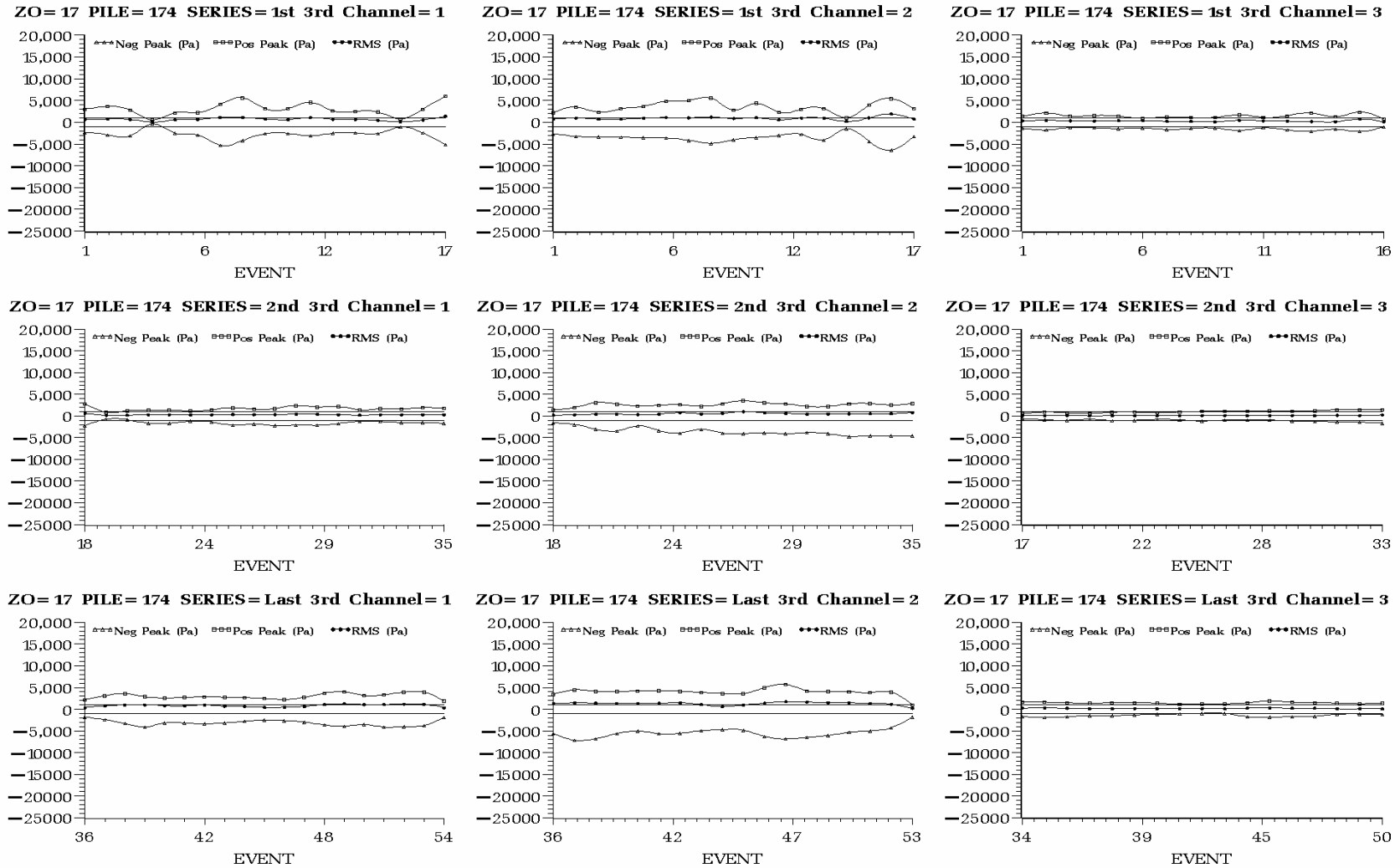

Figure C.17. Peak Positive, Peak Negative, and Root Mean Square Sound Pressure (Pa) of Each Impact on Batter Pile 174 Driven at Hood Canal Bridge in 29 ft of Water with a Type I Unconfined Bubble Curtain in Place. Plots are arranged by hydrophone H1 (left) to H3 (right) and by impact series, each containing one third of the impacts, from first third (top) to last third (bottom).

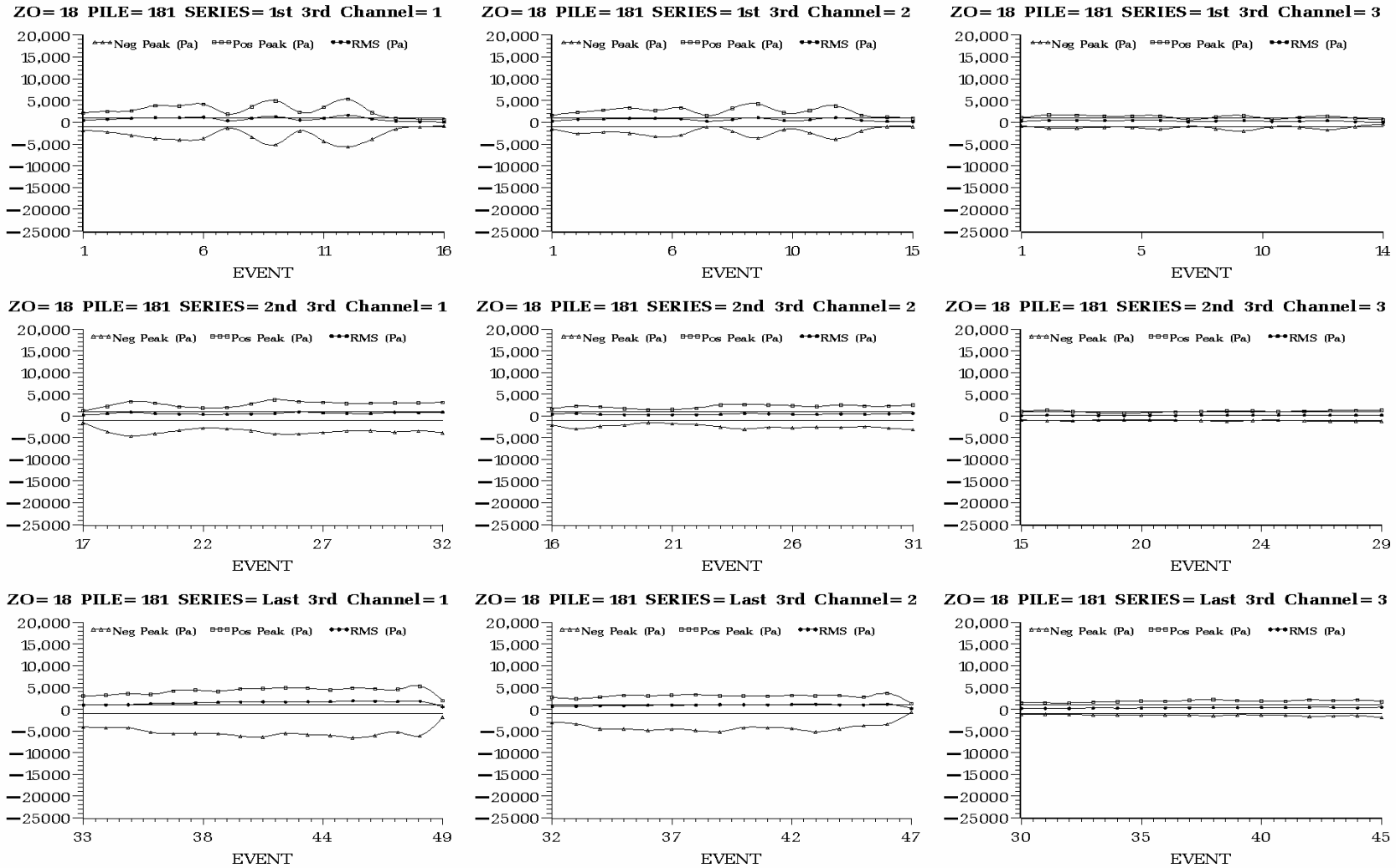

Figure C.18. Peak Positive, Peak Negative, and Root Mean Square Sound Pressure (Pa) of Each Impact on Batter Pile 181 Driven at Hood Canal Bridge in 33 ft of Water with a Type I Unconfined Bubble Curtain in Place. Plots are arranged by hydrophone H1 (left) to H3 (right) and by impact series, each containing one third of the impacts, from first third (top) to last third (bottom).

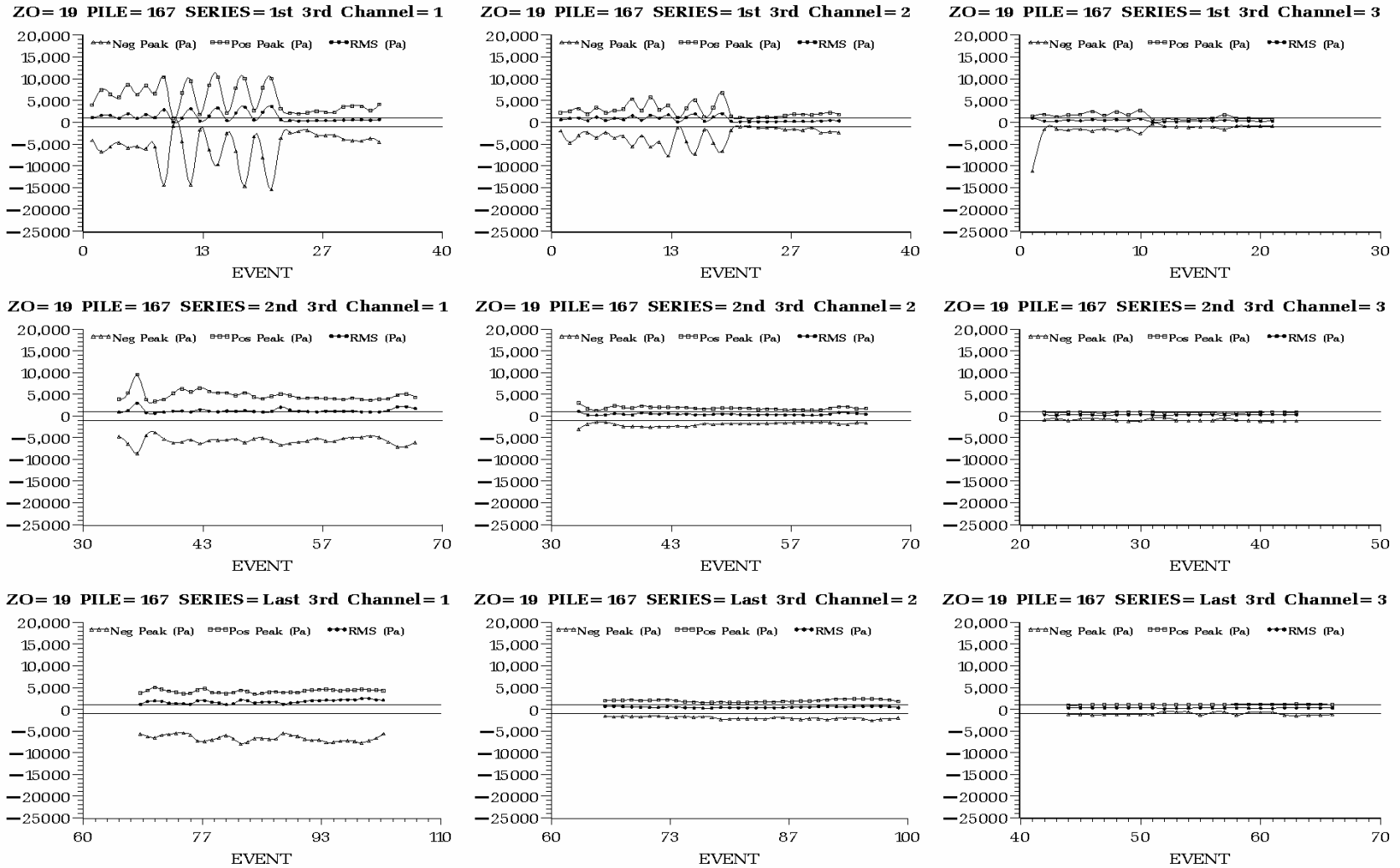

Figure C.19, Peak Positive, Peak Negative, and Root Mean Square Sound Pressure (Pa) of Each Impact on Batter Pile 167 Driven at Hood Canal Bridge in 7 ft of Water with a Type I Unconfined Bubble Curtain in Place. Plots are arranged by hydrophone H1 (left) to H3 (right) and by impact series, each containing one third of the impacts, from first third (top) to last third (bottom).

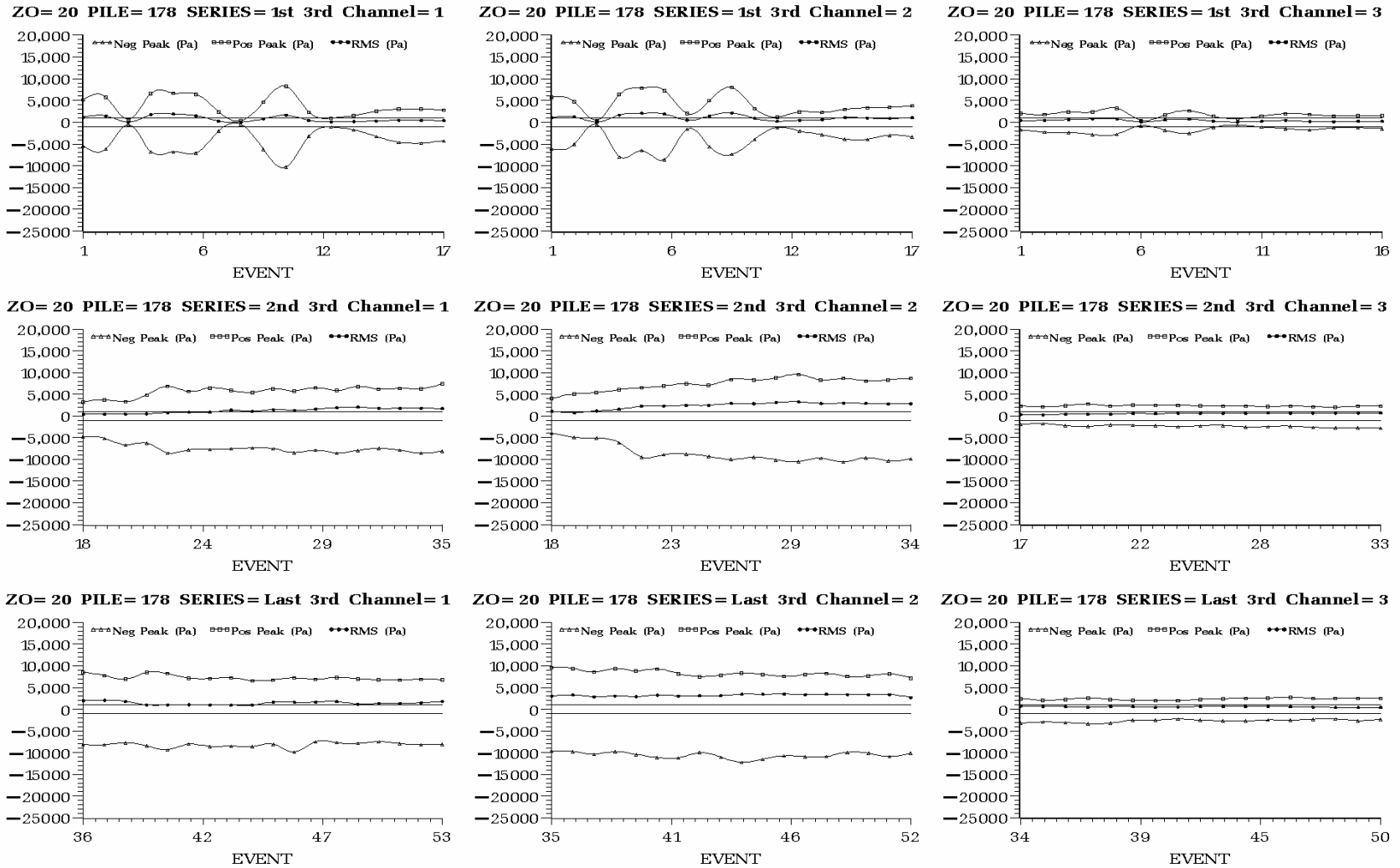

Figure C.20. Peak Positive, Peak Negative, and Root Mean Square Sound Pressure (Pa) of Each Impact on Batter Pile 178 Driven at Hood Canal Bridge in 37 ft of Water with No Bubble Curtain in Place. Plots are arranged by hydrophone H1 (left) to H3 (right) and by impact series, each containing one third of the impacts, from first third (top) to last third (bottom).

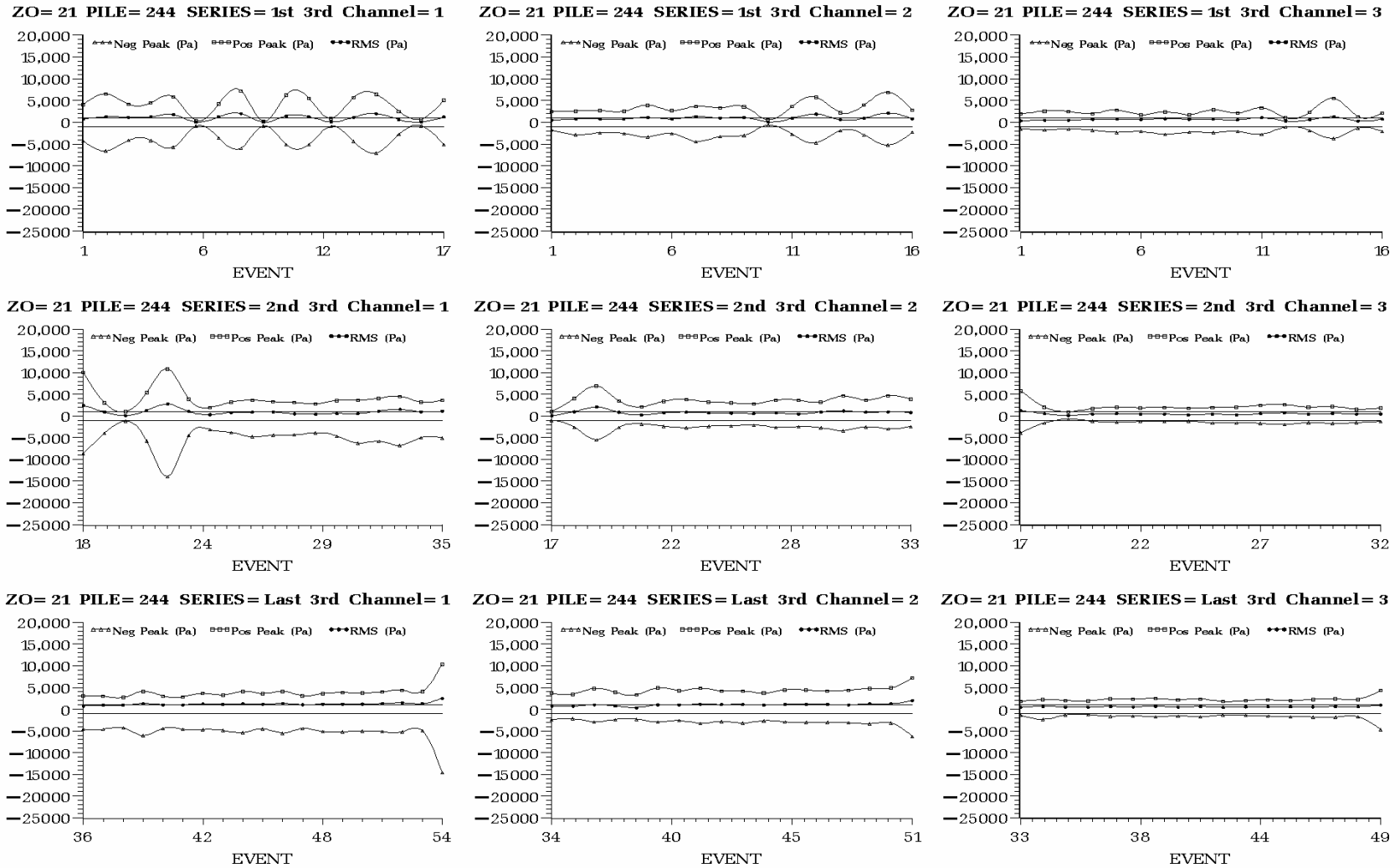

Figure C.21. Peak Positive, Peak Negative, and Root Mean Square Sound Pressure (Pa) of Each Impact on Batter Pile 244 Driven at Hood Canal Bridge in 20 ft of Water with No Bubble Curtain in Place. Plots are arranged by hydrophone H1 (left) to H3 (right) and by impact series, each containing one third of the impacts, from first third (top) to last third (bottom).

APPENDIX D

Distribution Plots of Root Mean Square Pressure, Peak Positive Pressure, and Peak Negative Pressure for Each Pile-Driving Event

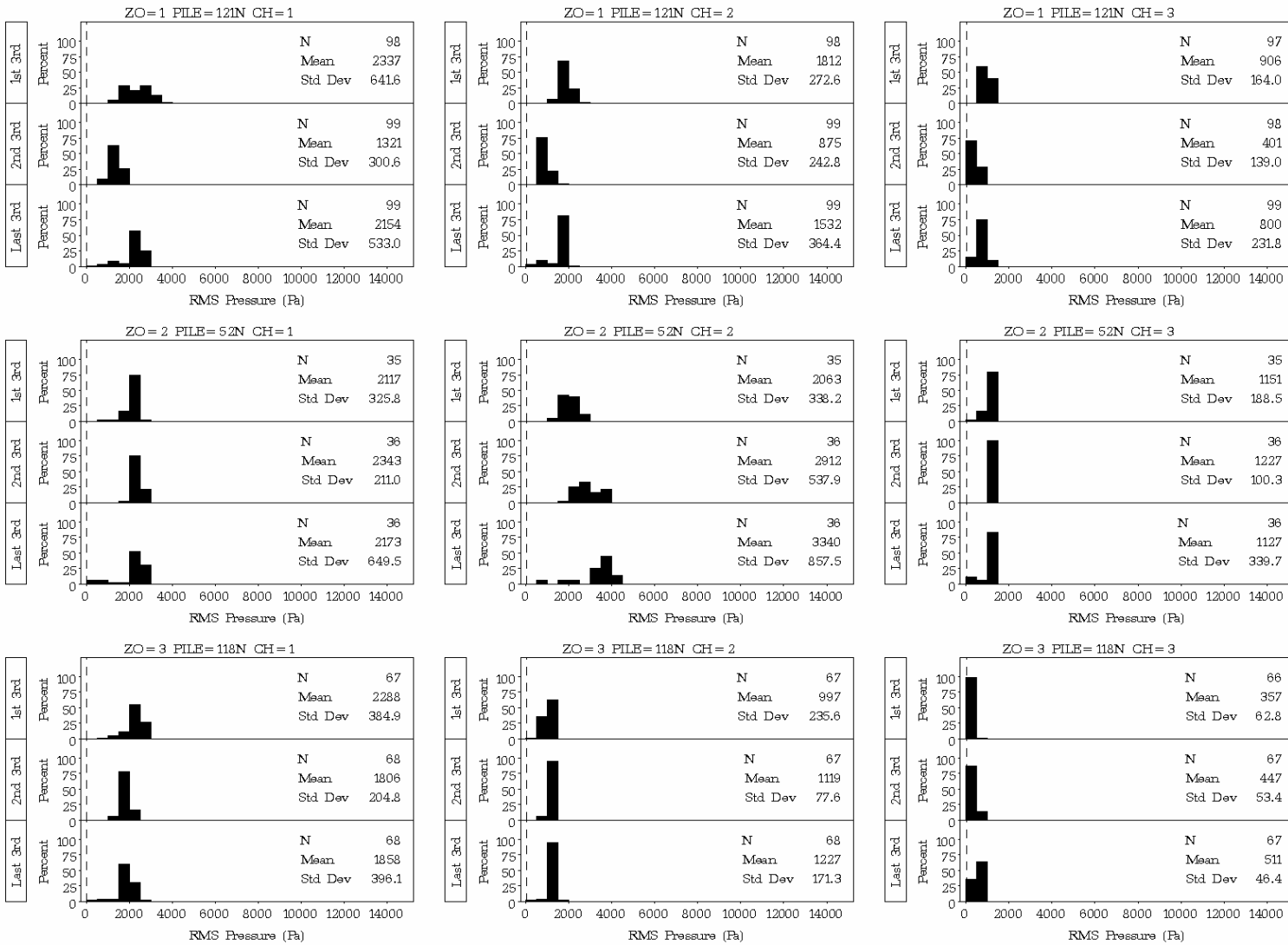

Figure D.1. Plots of Distribution Statistics on Root Mean Square Pressure for Impacts on Plumb Piles 121N, 52N, and 118N at the Hood Canal Bridge in 42 ft, 40 ft, and 39 ft of Water, Respectively, with Type II Confined Bubble Curtain in Place

Note: In the following figures, subplots are arranged in rows by pile and columns by increasing hydrophone channel. Within subplots, histograms are arranged from top to bottom by impact series (first third, second third, and last third of impacts). The variable ZO was used to sort the piles in order of decreasing wetted length of the pile and to separate batter from plumb piles.

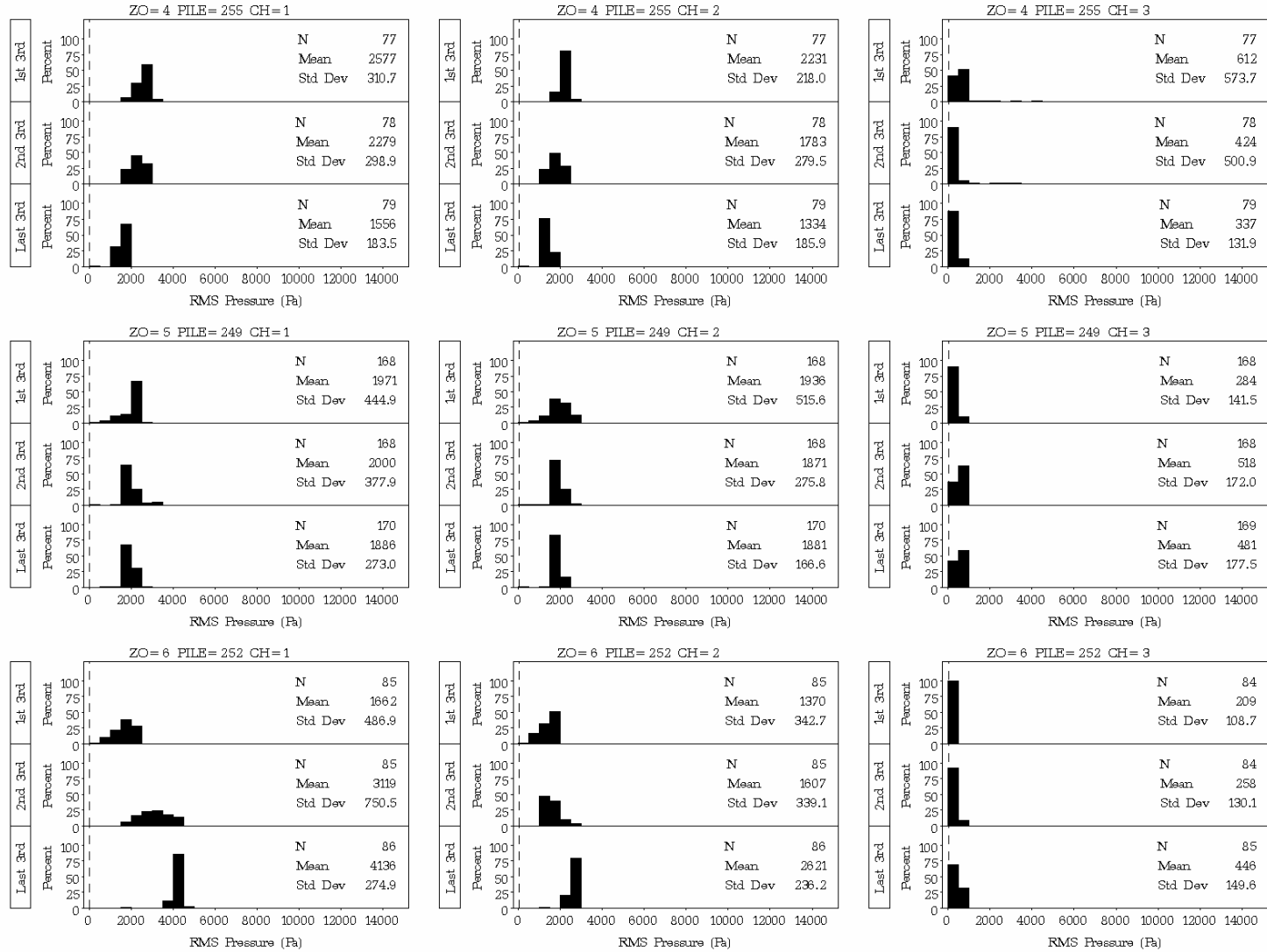

Figure D.2. Plots of Distribution Statistics on Root Mean Square Pressure for Impacts on Plumb Piles 255, 249, and 252 at the Hood Canal Bridge in 33 ft, 32 ft, and 31 ft of Water, Respectively, with Type II Confined Bubble Curtain in Place

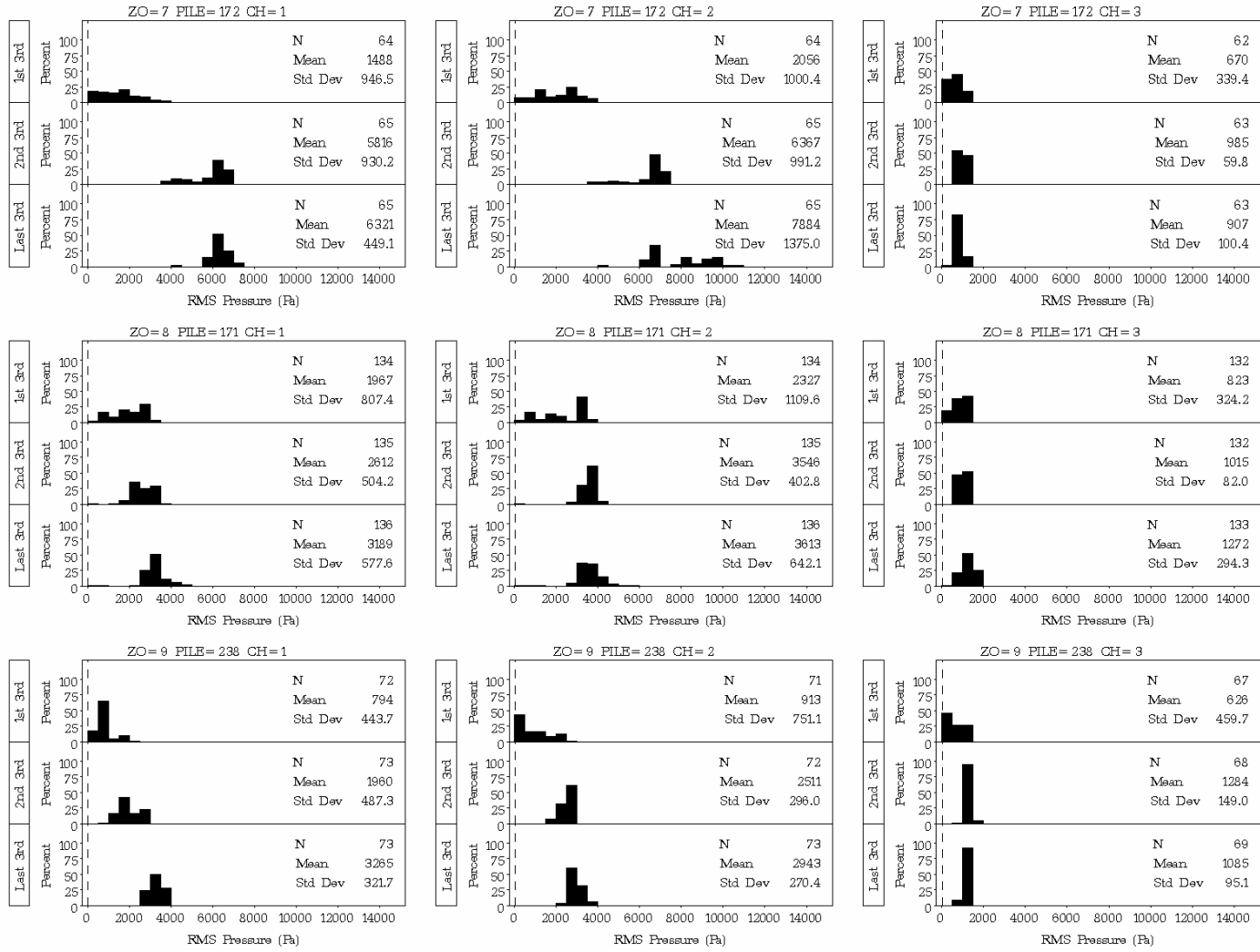

Figure D.3. Plots of Distribution Statistics on Root Mean Square Pressure for Impacts on Plumb Piles 172, 171, and 238 at the Hood Canal Bridge in 20 ft, 18 ft, and 7 ft of Water, Respectively, with Type II Confined Bubble Curtain in Place

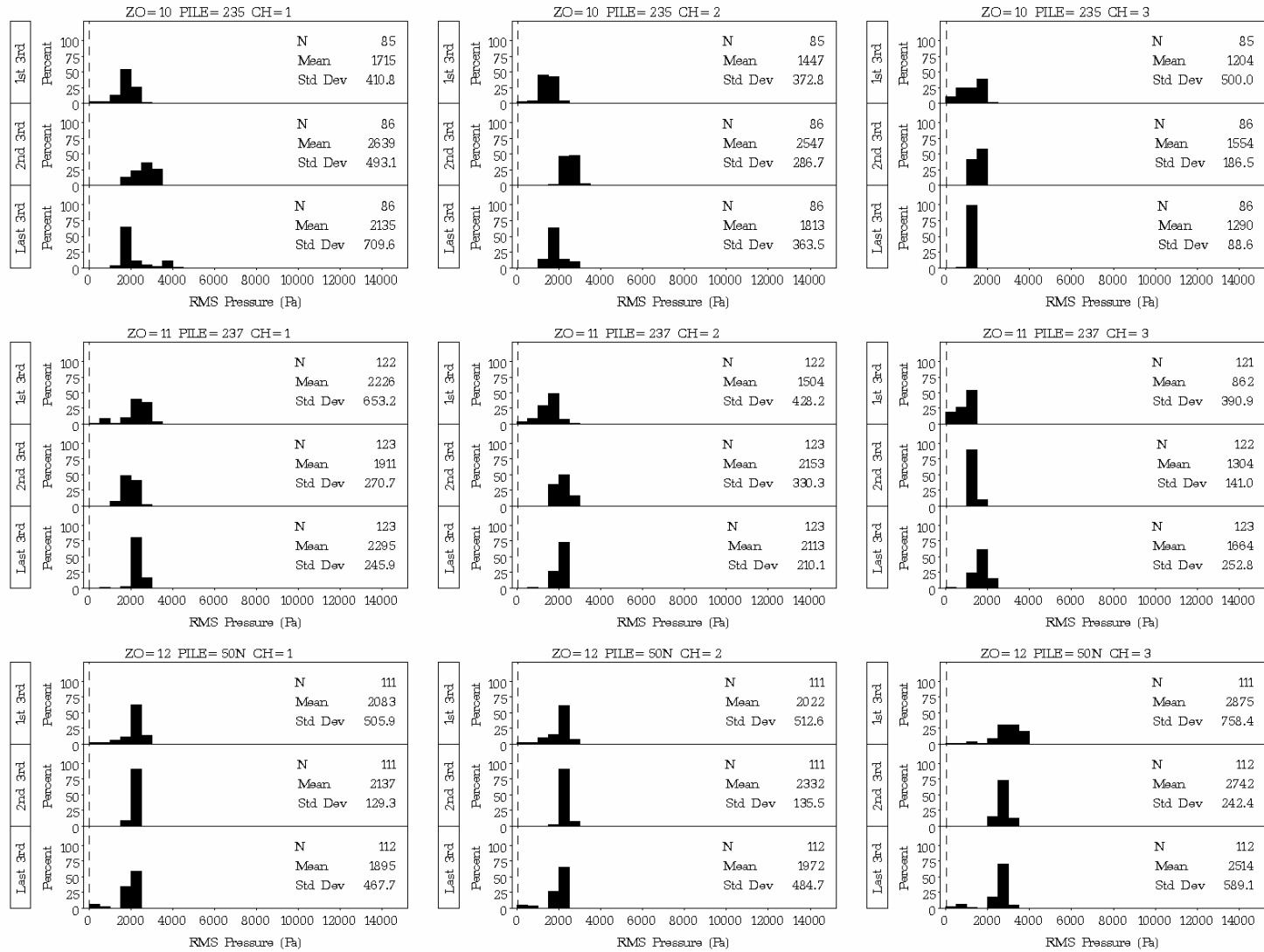

Figure D.4. Plots of Distribution Statistics on Root Mean Square Pressure for Impacts on Plumb Piles 235 and 237 in 4.5 ft and 4 ft of Water, Respectively, with a Type II Confined Bubble Curtain in Place, and at Plumb Pile 50N in 40 ft of Water with No Bubble Curtain in Place

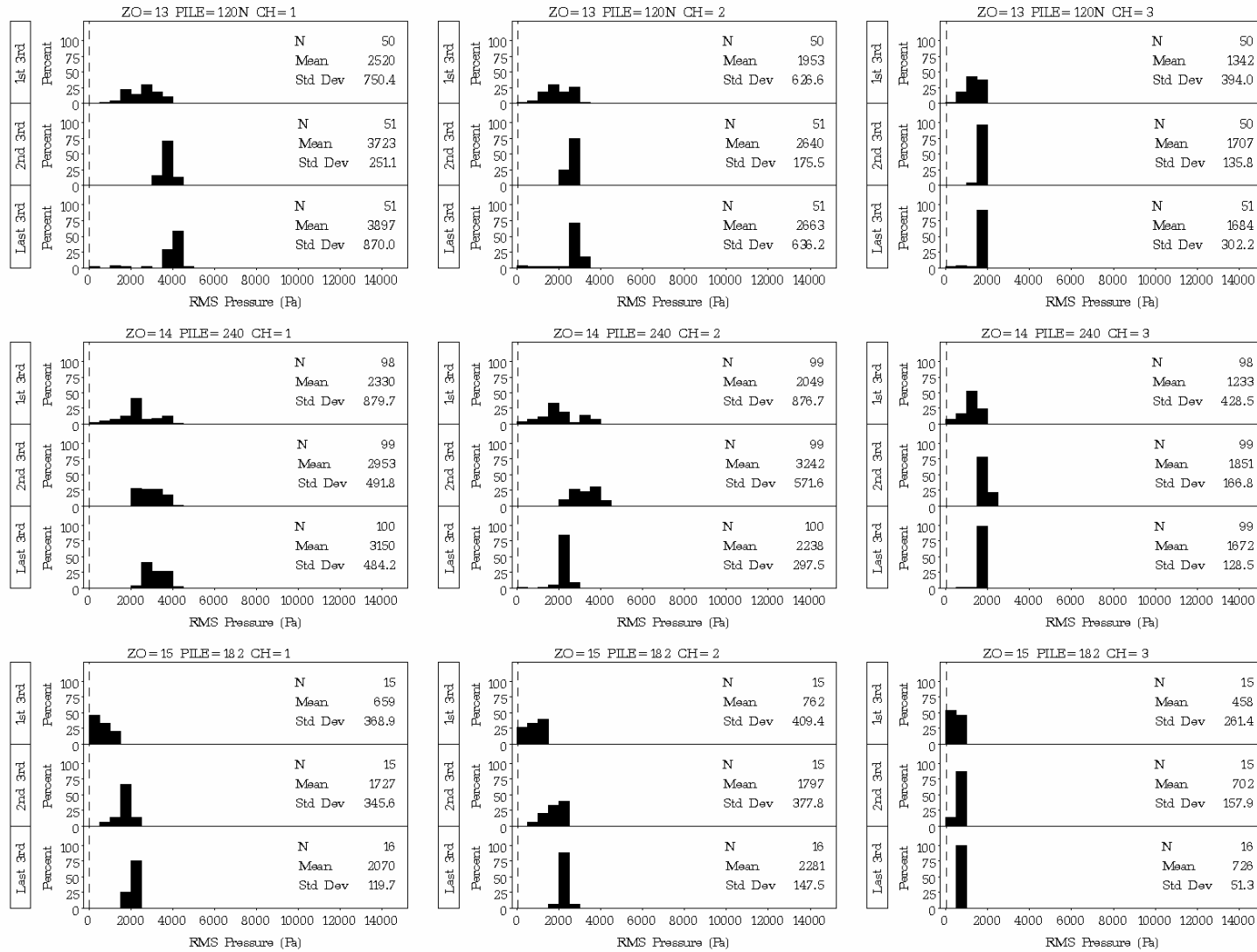

Figure D.5. Plots of Distribution Statistics on Root Mean Square Pressure for Impacts on Plumb Piles 120N and 240 in 39 ft and 9 ft of Water, Respectively, with No Bubble Curtain in Place, and on Batter Pile 182 in 41 ft of Water with No Bubble Curtain in Place

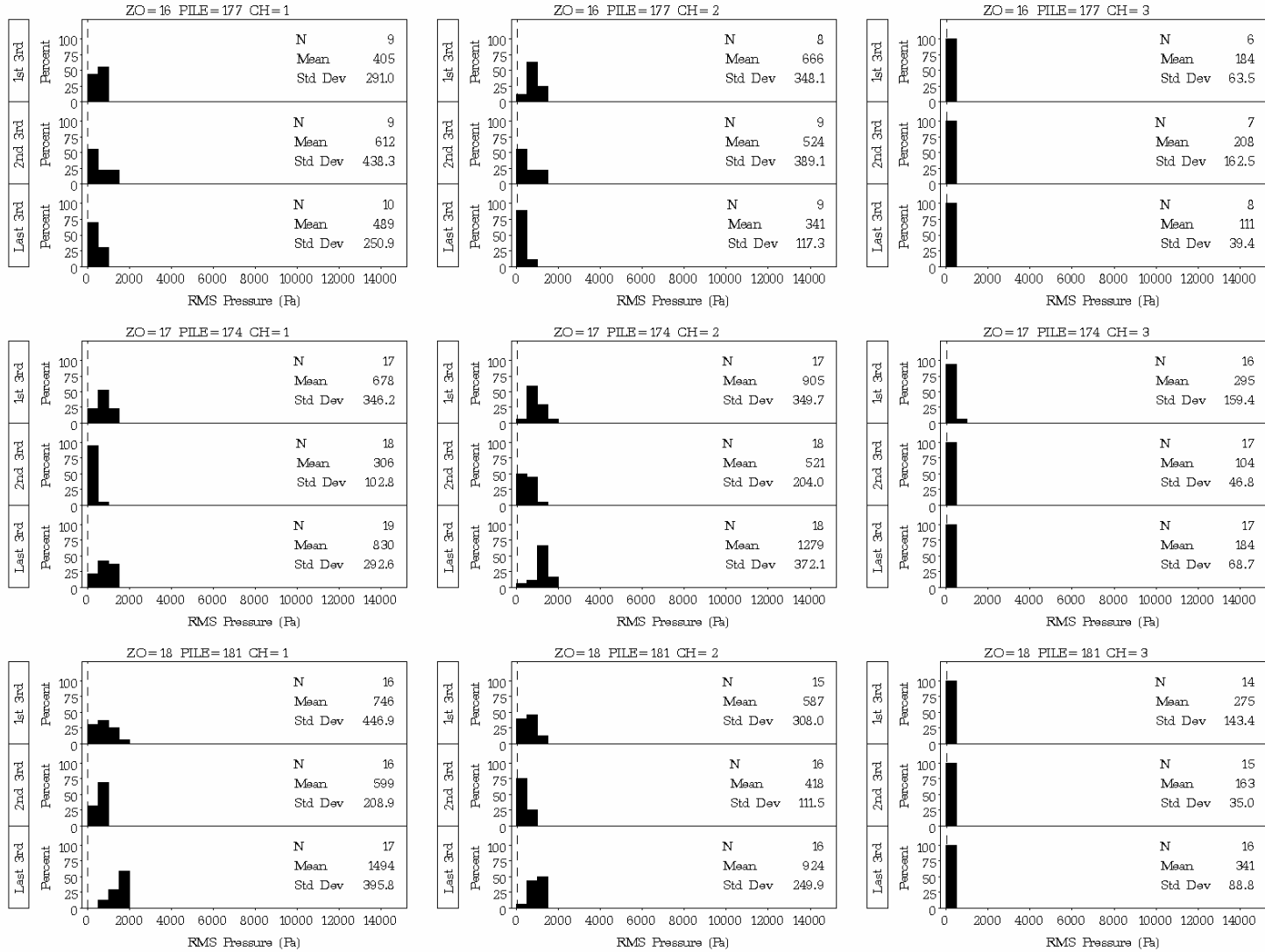

Figure D.6. Plots of Distribution Statistics on Root Mean Square Pressure for Impacts on Batter Piles 177, 174, and 181 at the Hood Canal Bridge in 37 ft, 29 ft, and 33 ft of Water, Respectively, with Type I Unconfined Bubble Curtain in Place

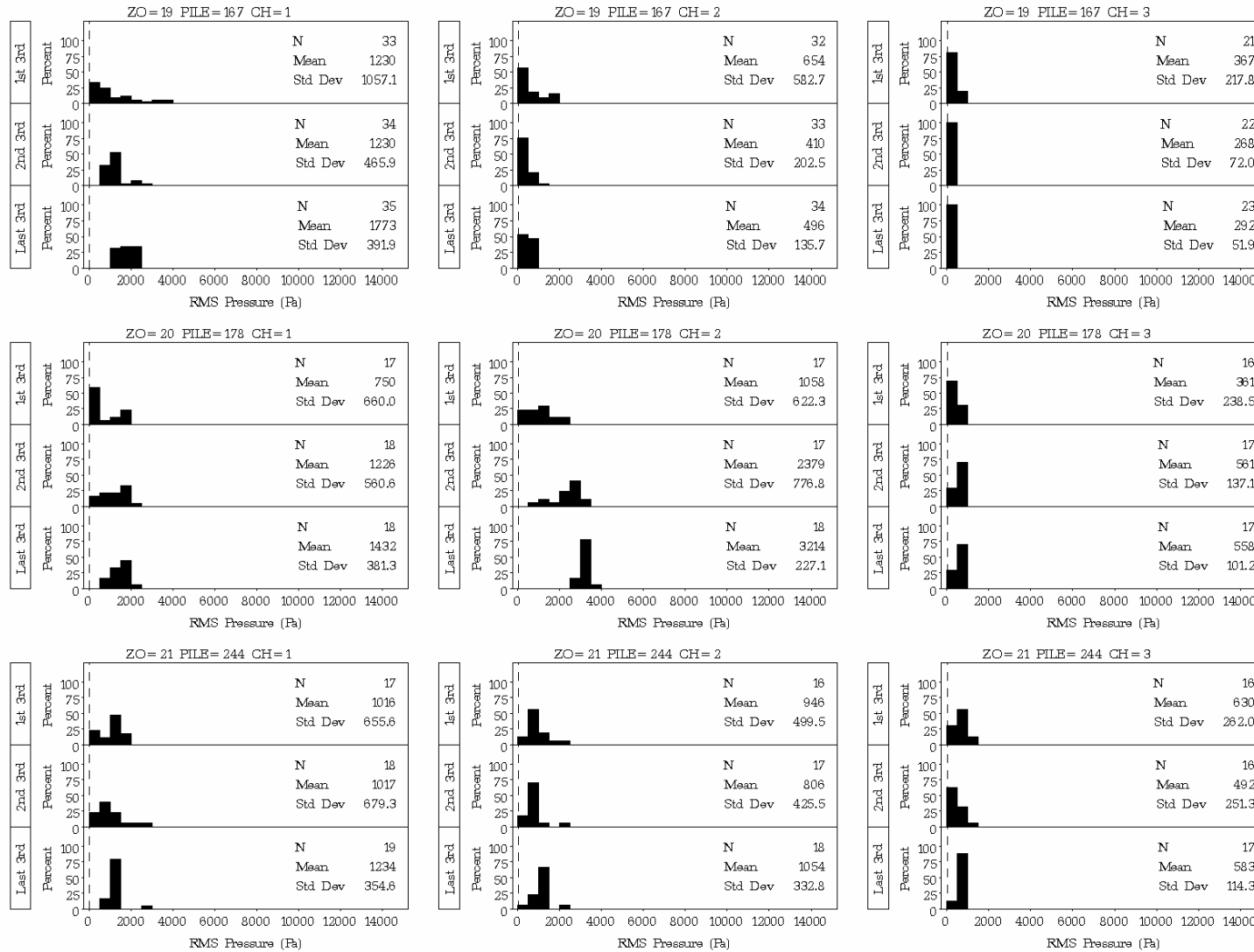

Figure D.7. Plots of Distribution Statistics on Root Mean Square Pressure for Impacts on Batter Piles 167, 178, and 244 at the Hood Canal Bridge. Batter pile 167 is in 7 ft of water with a Type I unconfined bubble curtain in place; batter piles 178 and 244 are in 37 ft and 20 ft of water, respectively, with no bubble curtains in place.

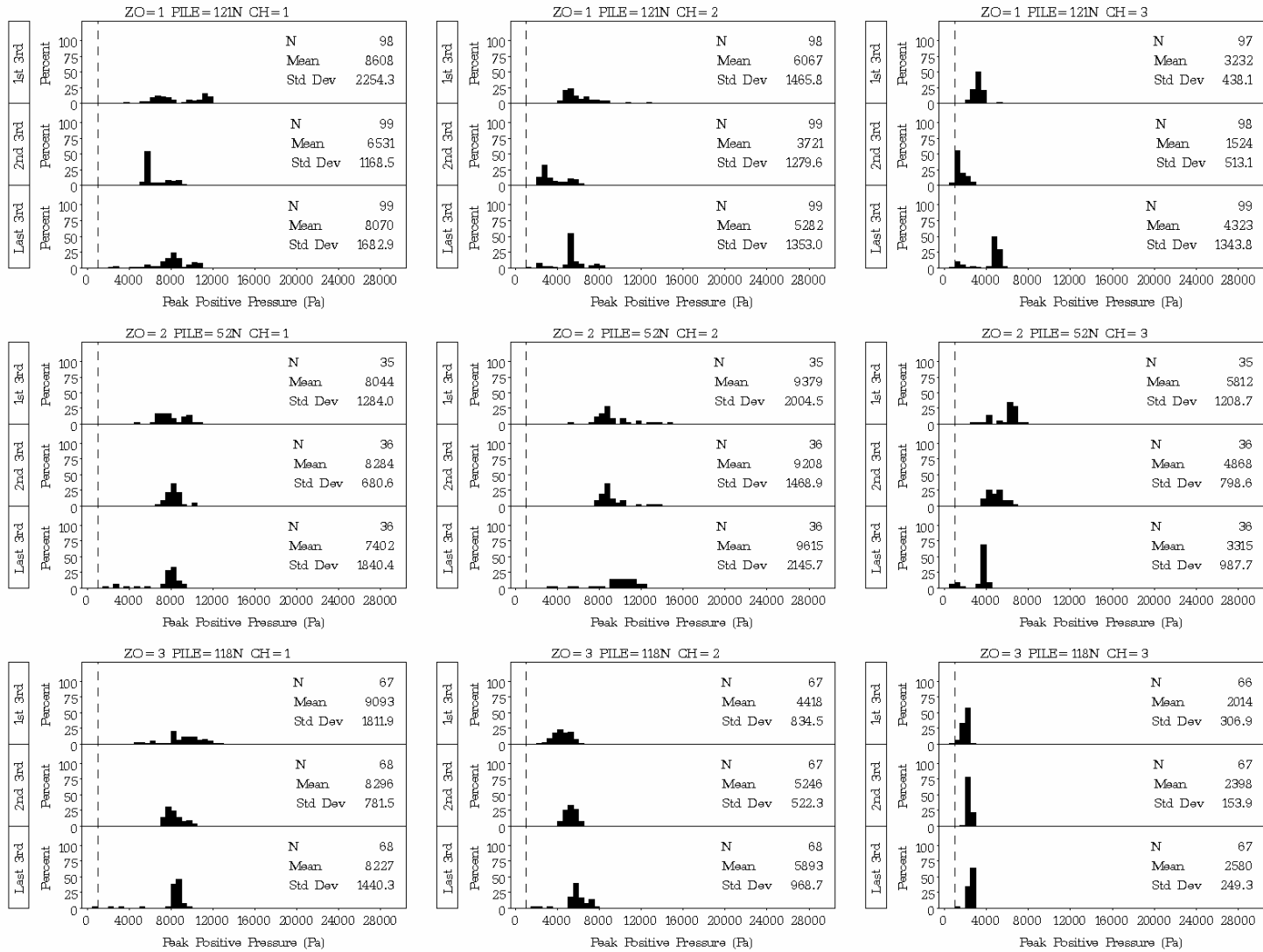

Figure D.8. Plots of Distribution Statistics on Peak Positive Pressure for Impacts on Plumb Piles 121N, 52N, and 118N at the Hood Canal Bridge in 42 ft, 40 ft, and 39 ft of Water, Respectively, with Type II Confined Bubble Curtain in Place

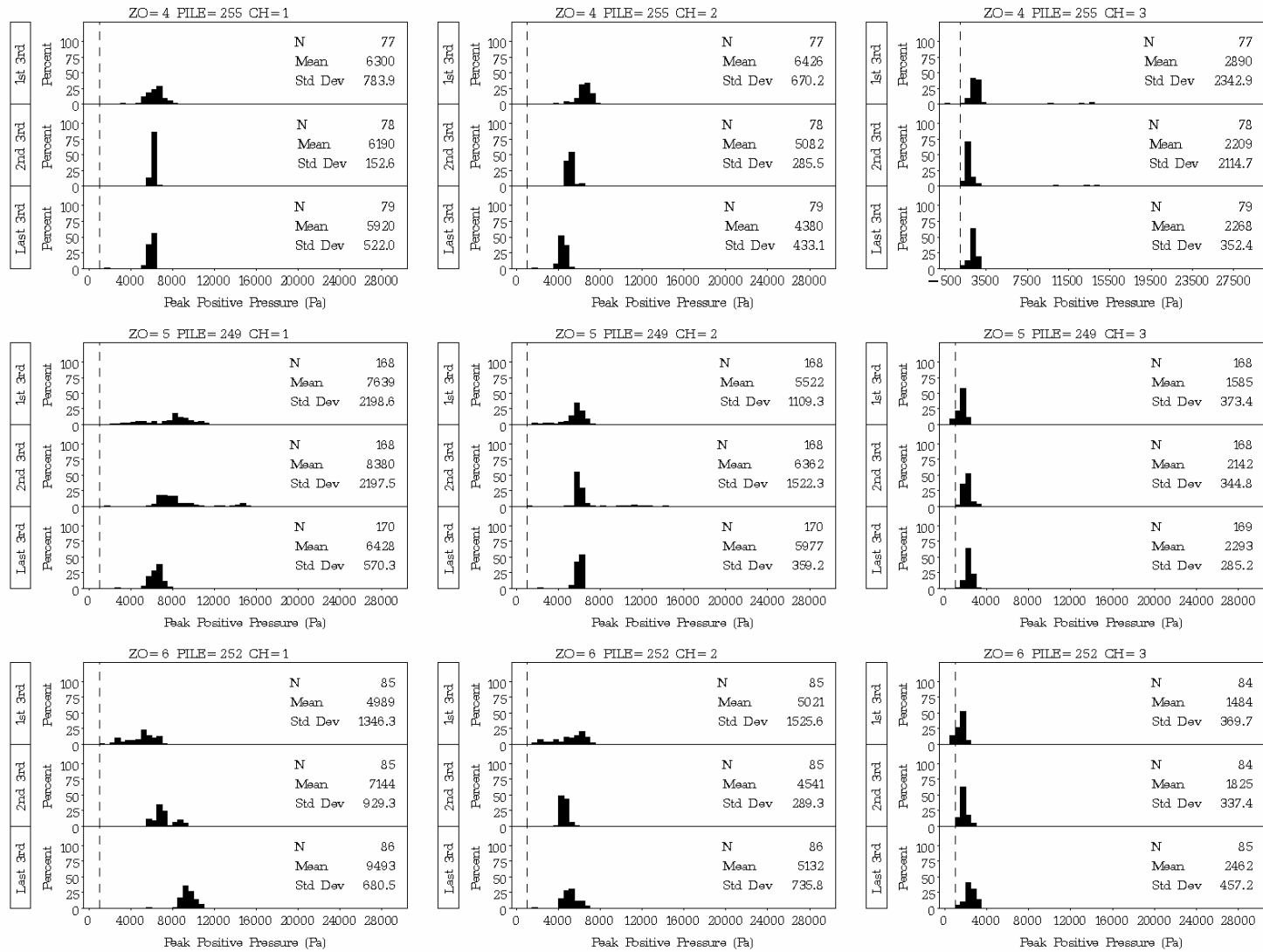

Figure D.9. Plots of Distribution Statistics on Peak Positive Pressure for Impacts on Plumb Piles 255, 249, and 252 at the Hood Canal Bridge in 33 ft, 32, ft, and 31 ft of Water, Respectively, with Type II Confined Bubble Curtain in Place

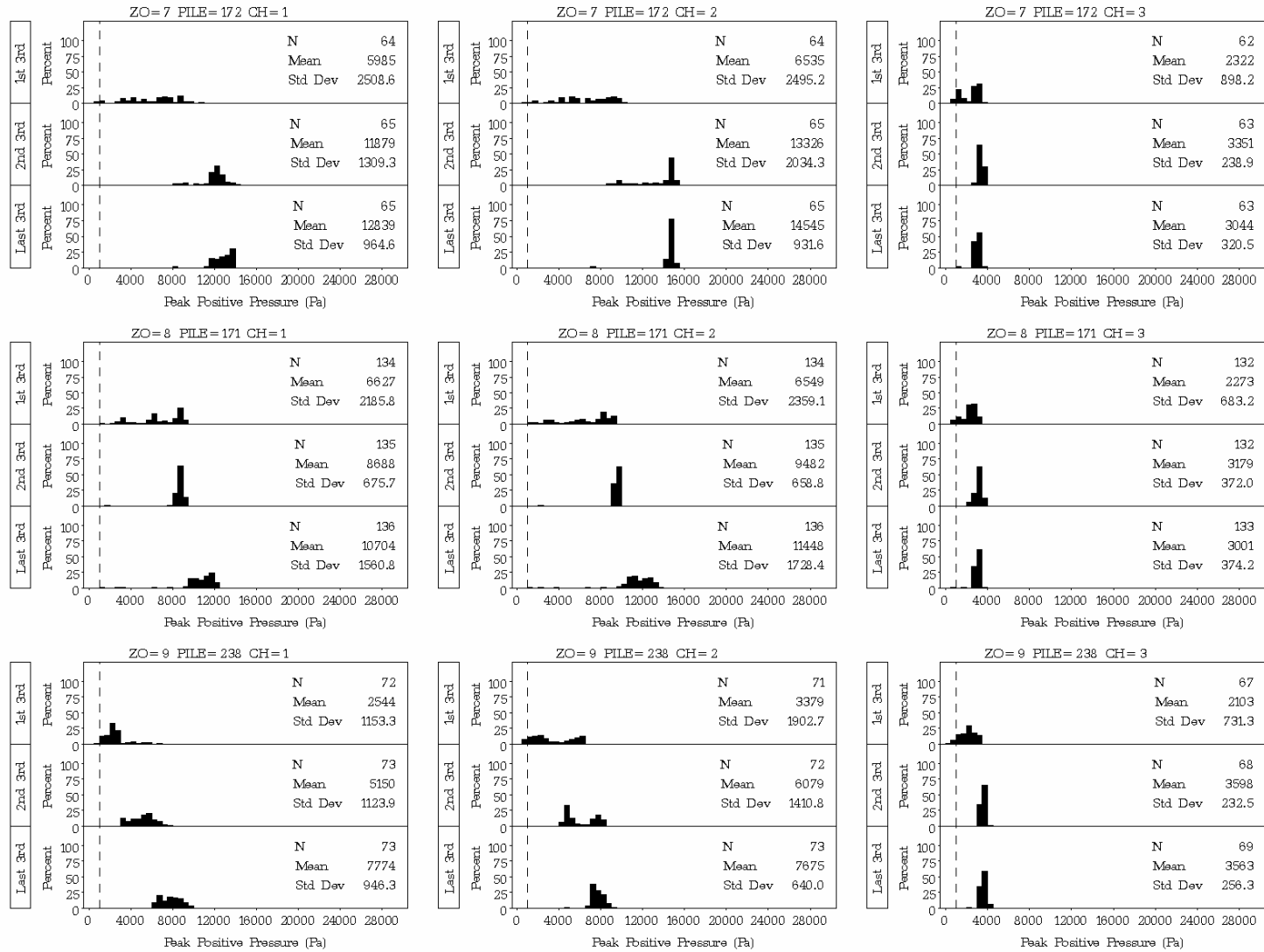

Figure D.10. Plots of Distribution Statistics on Peak Positive Pressure for Impacts on Plumb Piles 172, 171, and 238 at the Hood Canal Bridge in 20 ft, 18 ft, and 7 ft of Water, Respectively, with Type II Confined Bubble Curtain in Place

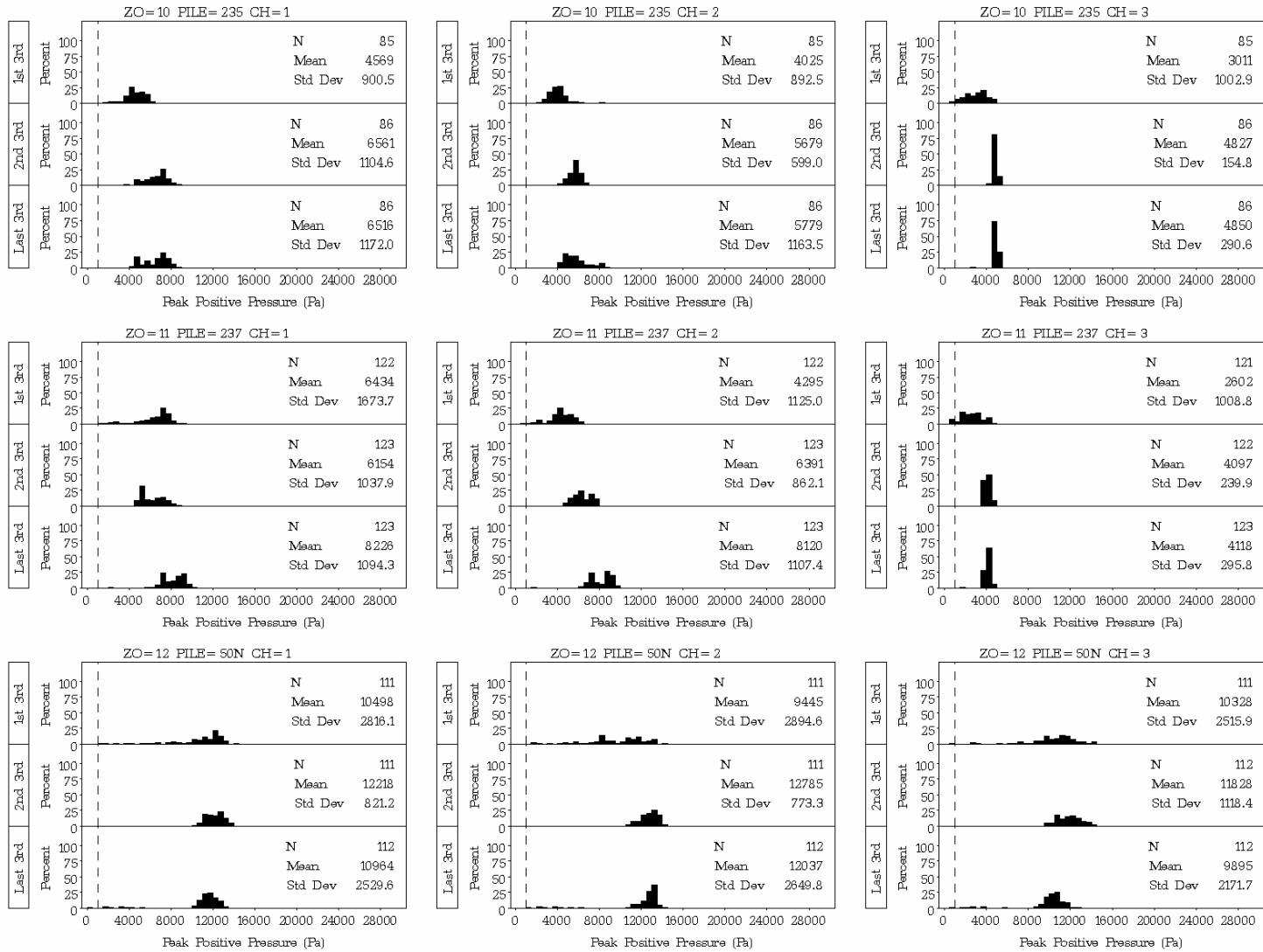

Figure D.11. Plots of Distribution Statistics on Peak Positive Pressure for Impacts on Plumb Piles 235 and 237 in 4.5 ft and 4 ft of Water, Respectively, with a Type II Confined Bubble Curtain in Place, and at Plumb Pile 50N in 40 ft of Water with No Bubble Curtain in Place

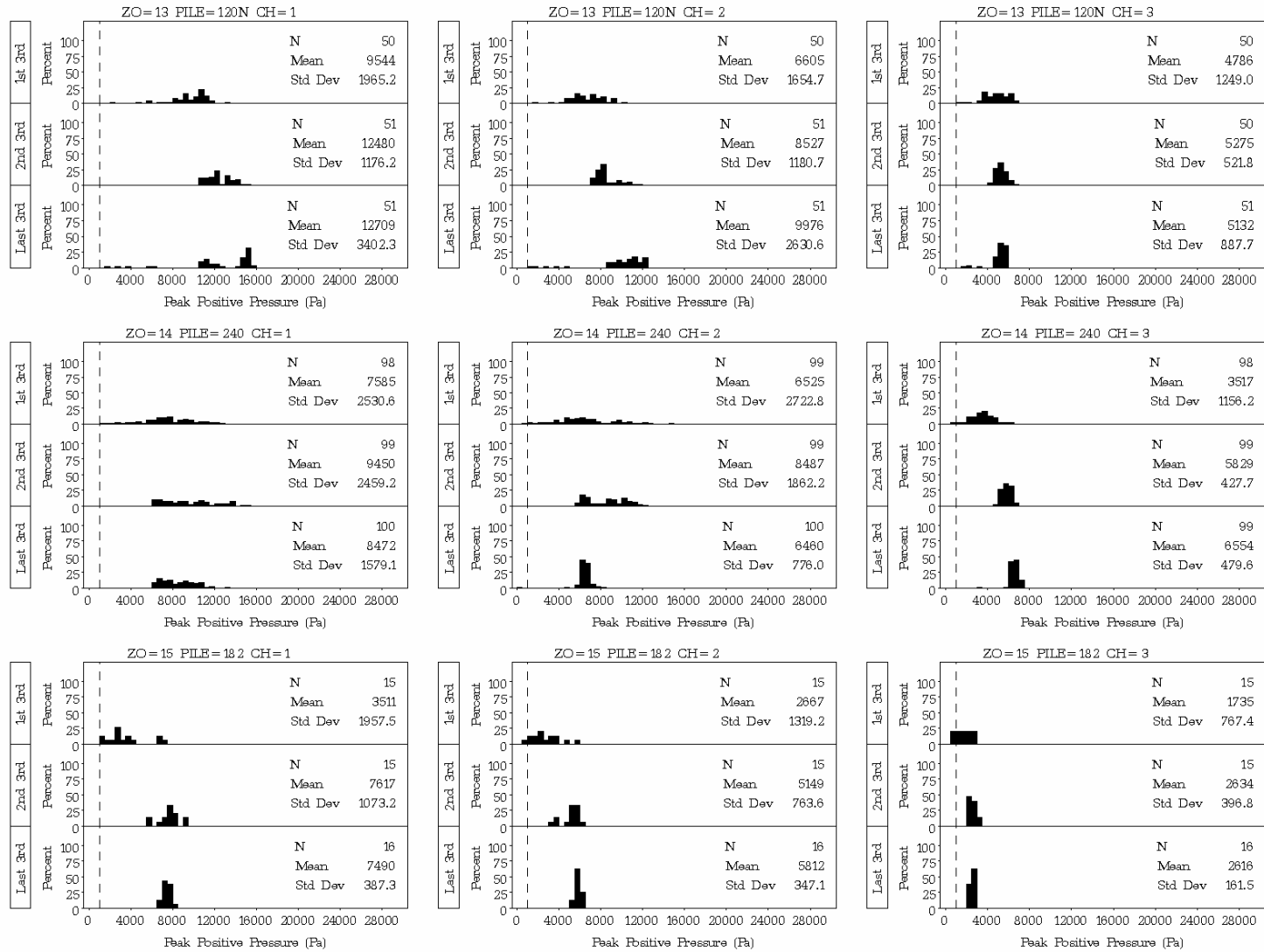

Figure D.12. Plots of Distribution Statistics on Peak Positive Pressure for Impacts on Plumb Piles 120N and 240 in 39 ft and 9 ft of Water, Respectively, with No Bubble Curtain in Place, and on Batter Pile 182 in 41 ft of Water with No Bubble Curtain in Place

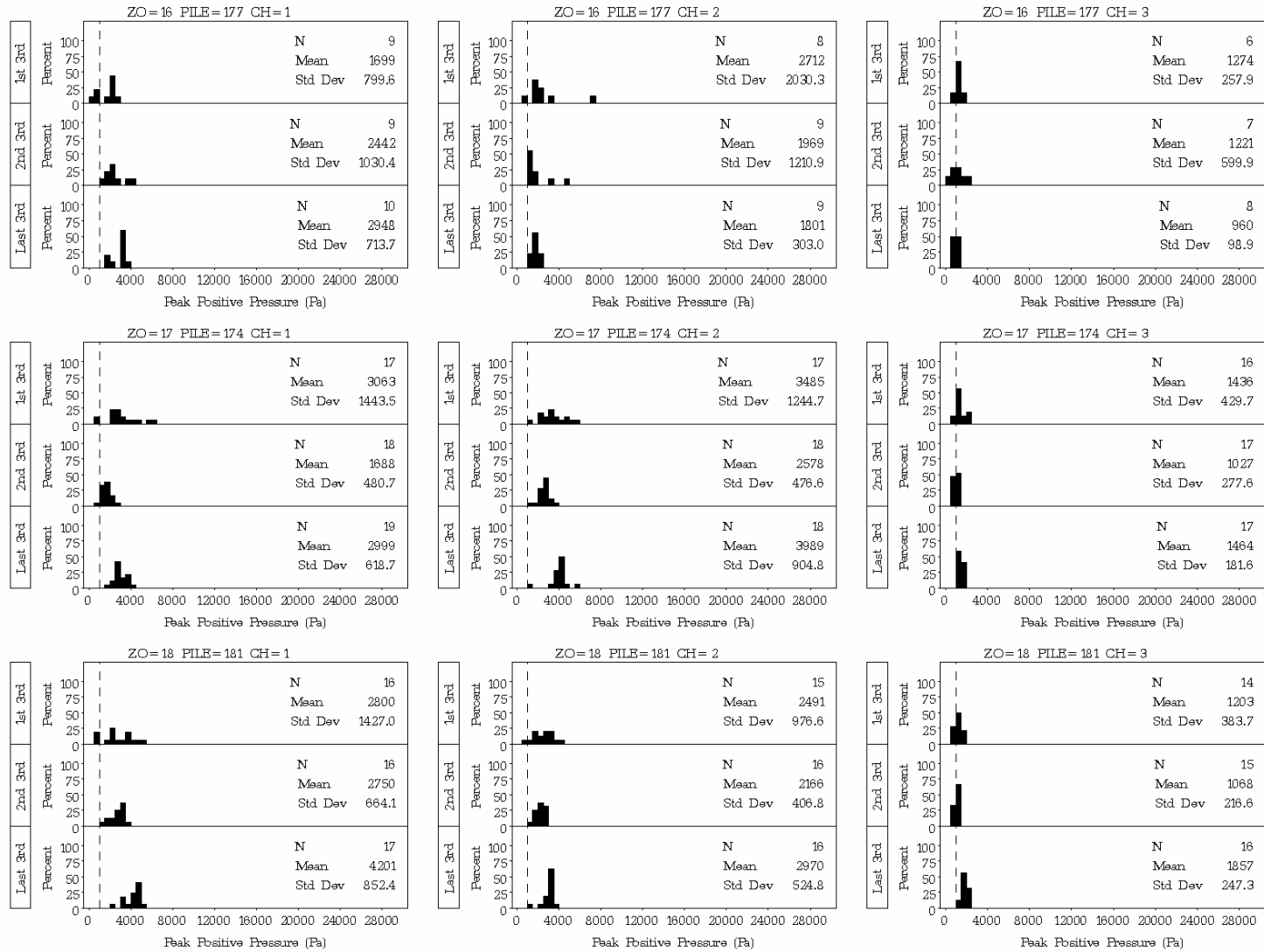

Figure D.13. Plots of Distribution Statistics on Peak Positive Pressure for Impacts on Batter Piles 177, 174, and 181 at the Hood Canal Bridge in 37 ft, 29 ft, and 33 ft of Water, Respectively, with Type I Unconfined Bubble Curtain in Place

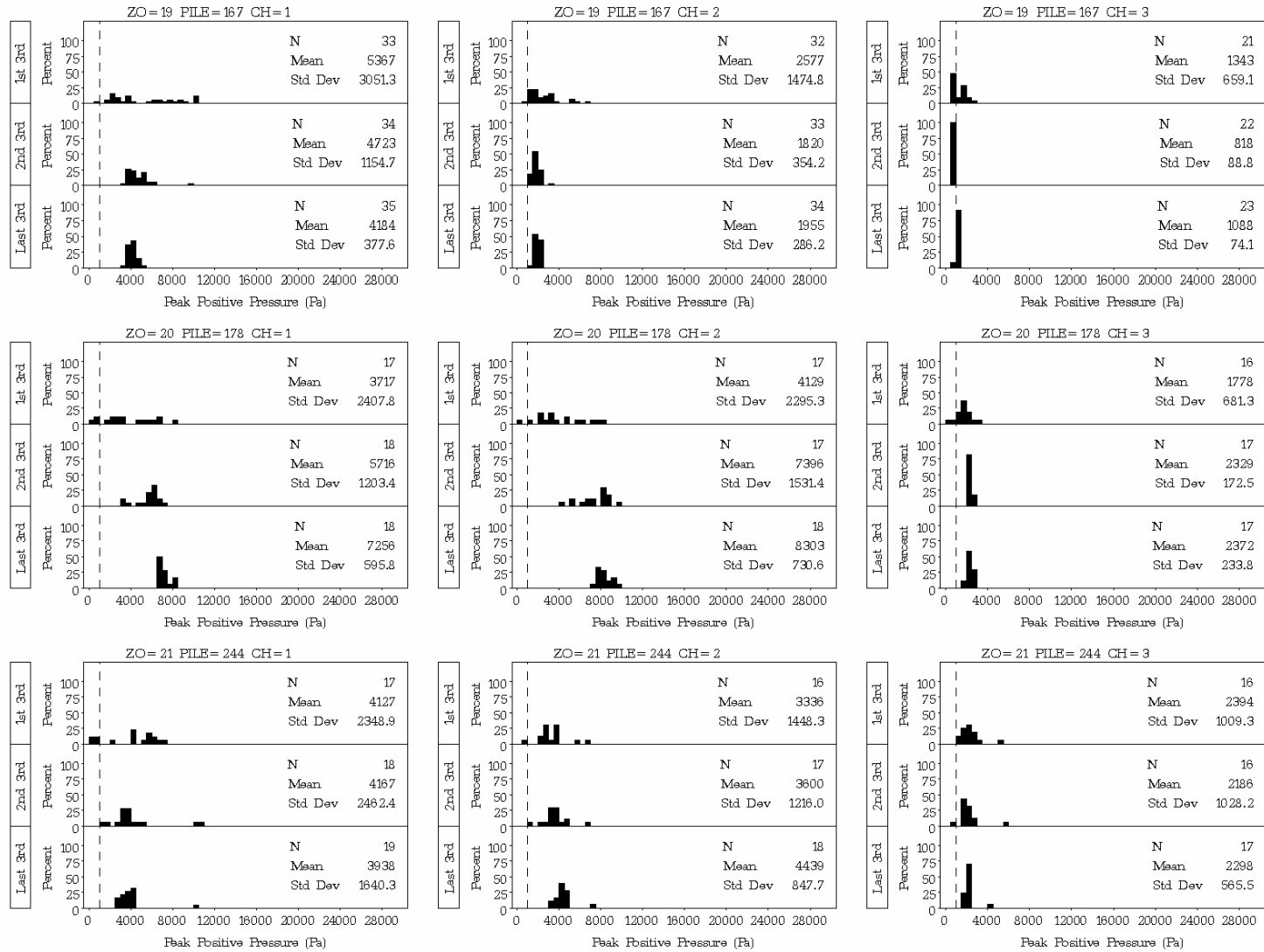

Figure D.14. Plots of Distribution Statistics on Peak Positive Pressure for Impacts on Piles Batter Piles 167, 178, and 244 at the Hood Canal Bridge. Batter pile 167 is in 7 ft of water with a Type I unconfined bubble curtain in place; batter piles 178 and 244 are in 37 ft and 20 ft of water, respectively, with no bubble curtains in place.

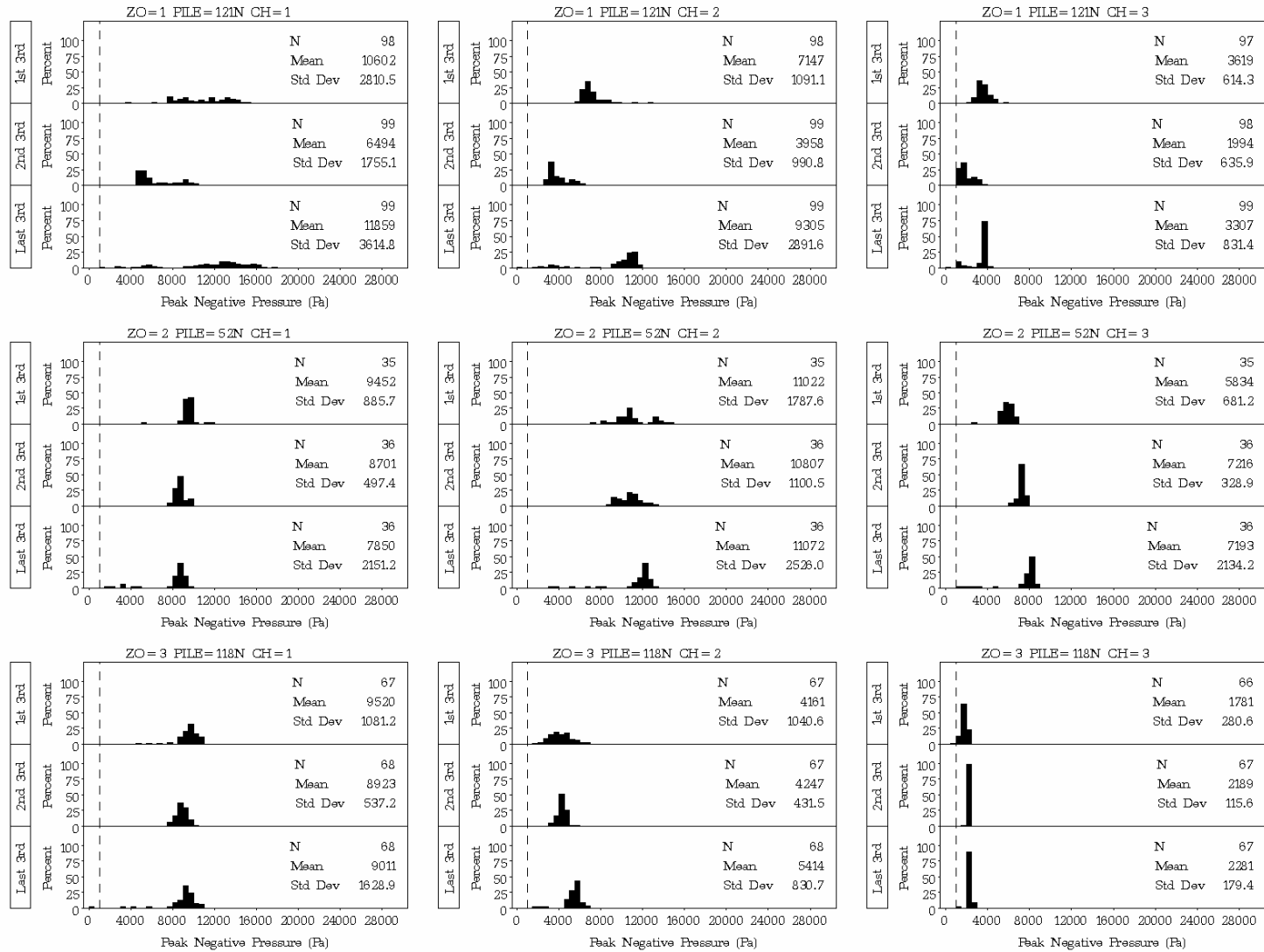

Figure D.15. Plots of Distribution Statistics on Peak Negative Pressure for Impacts on Plumb Piles 121N, 52N, and 118N at the Hood Canal Bridge in 42 ft, 40 ft, and 39 ft of Water, Respectively, with Type II Confined Bubble Curtain in Place

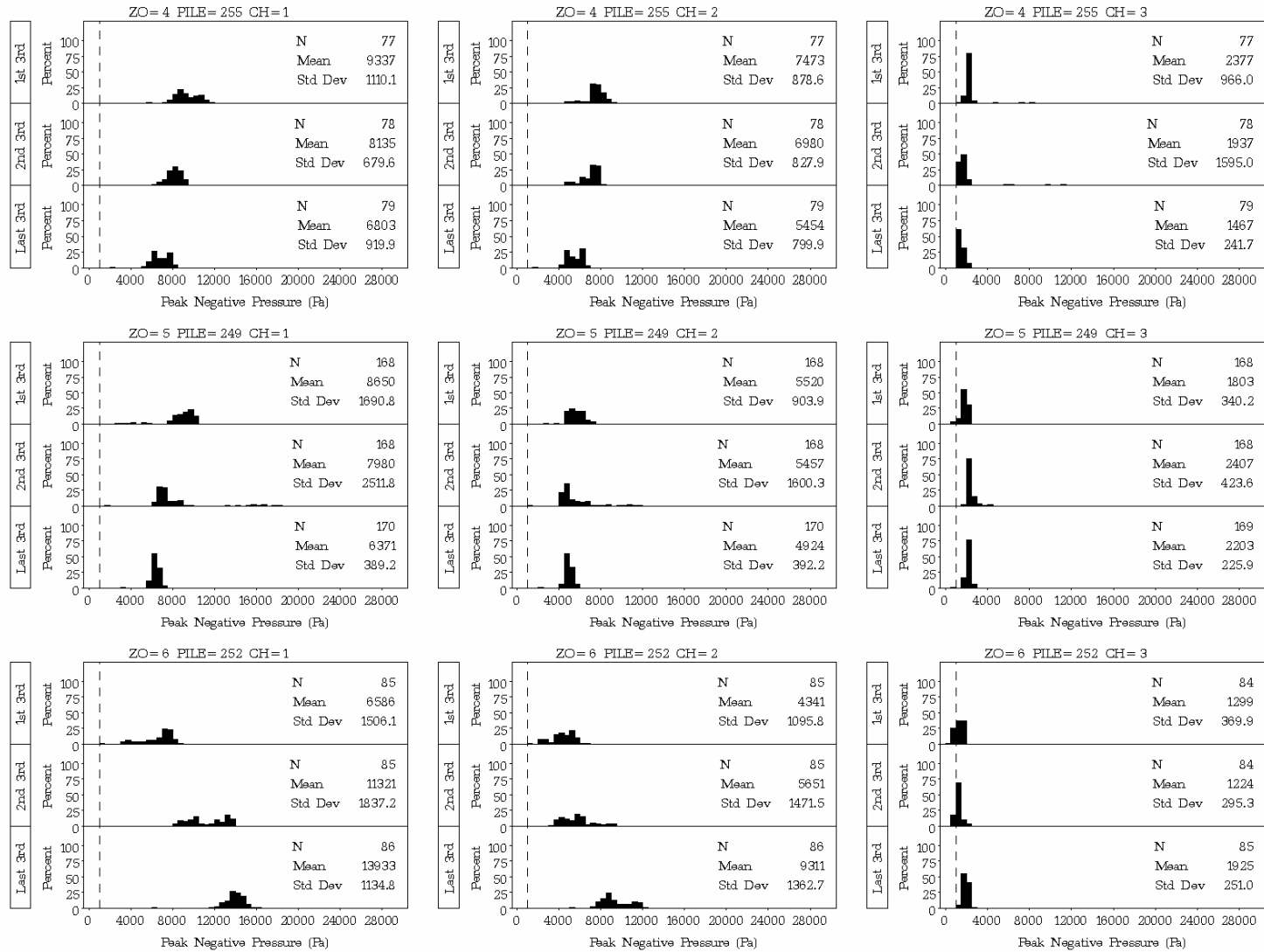

Figure D.16. Plots of Distribution Statistics on Peak Negative Pressure for Impacts on Plumb Piles 255, 249, and 252 at the Hood Canal Bridge in 33 ft, 32 ft, and 31 ft of Water, Respectively, with Type II Confined Bubble Curtain in Place

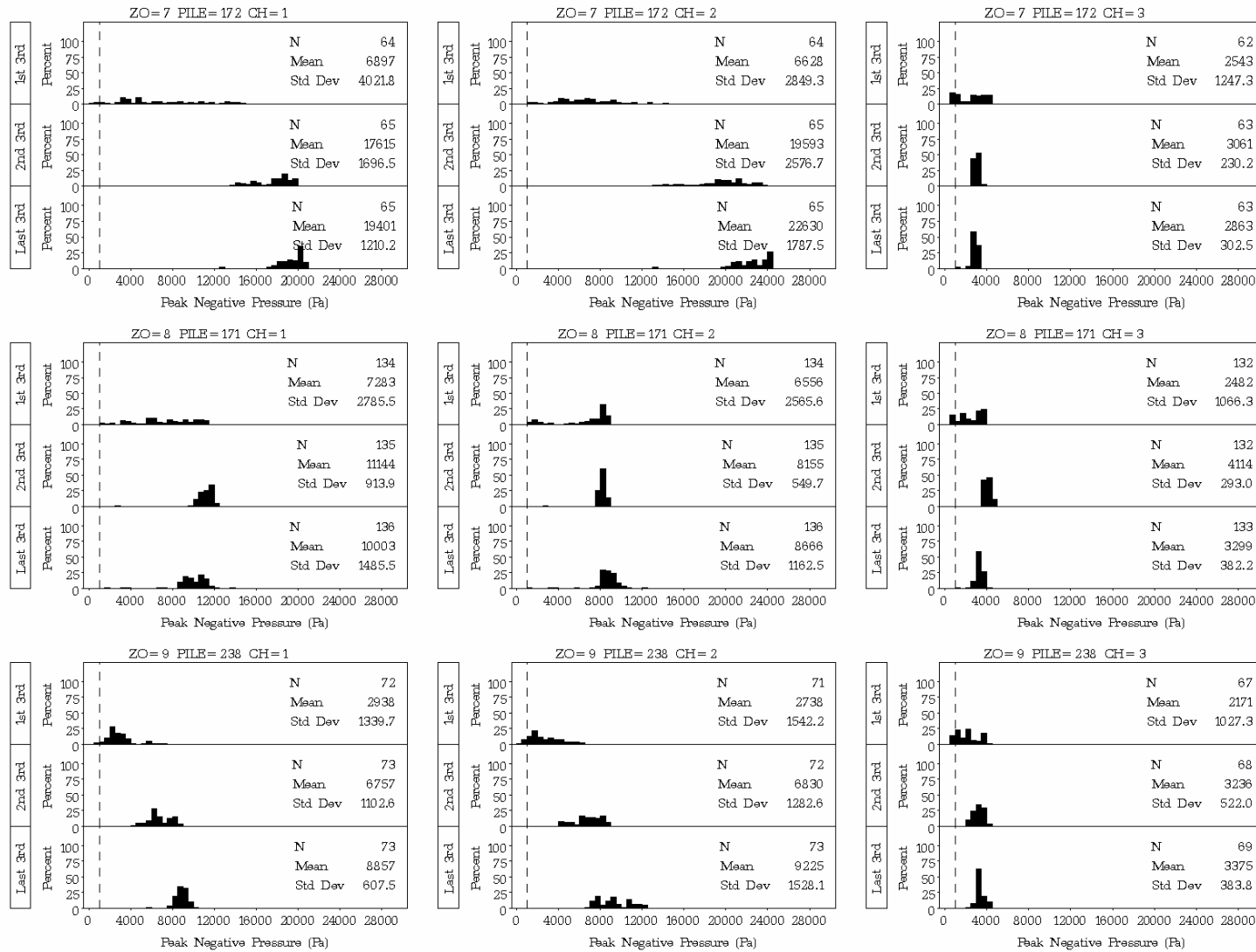

Figure D.17. Plots of Distribution Statistics on Peak Negative Pressure for Impacts on Plumb Piles 172, 171, and 238 at the Hood Canal Bridge in 20 ft, 18 ft, and 7 ft of Water, Respectively, with a Type II Confined Bubble Curtain in Place

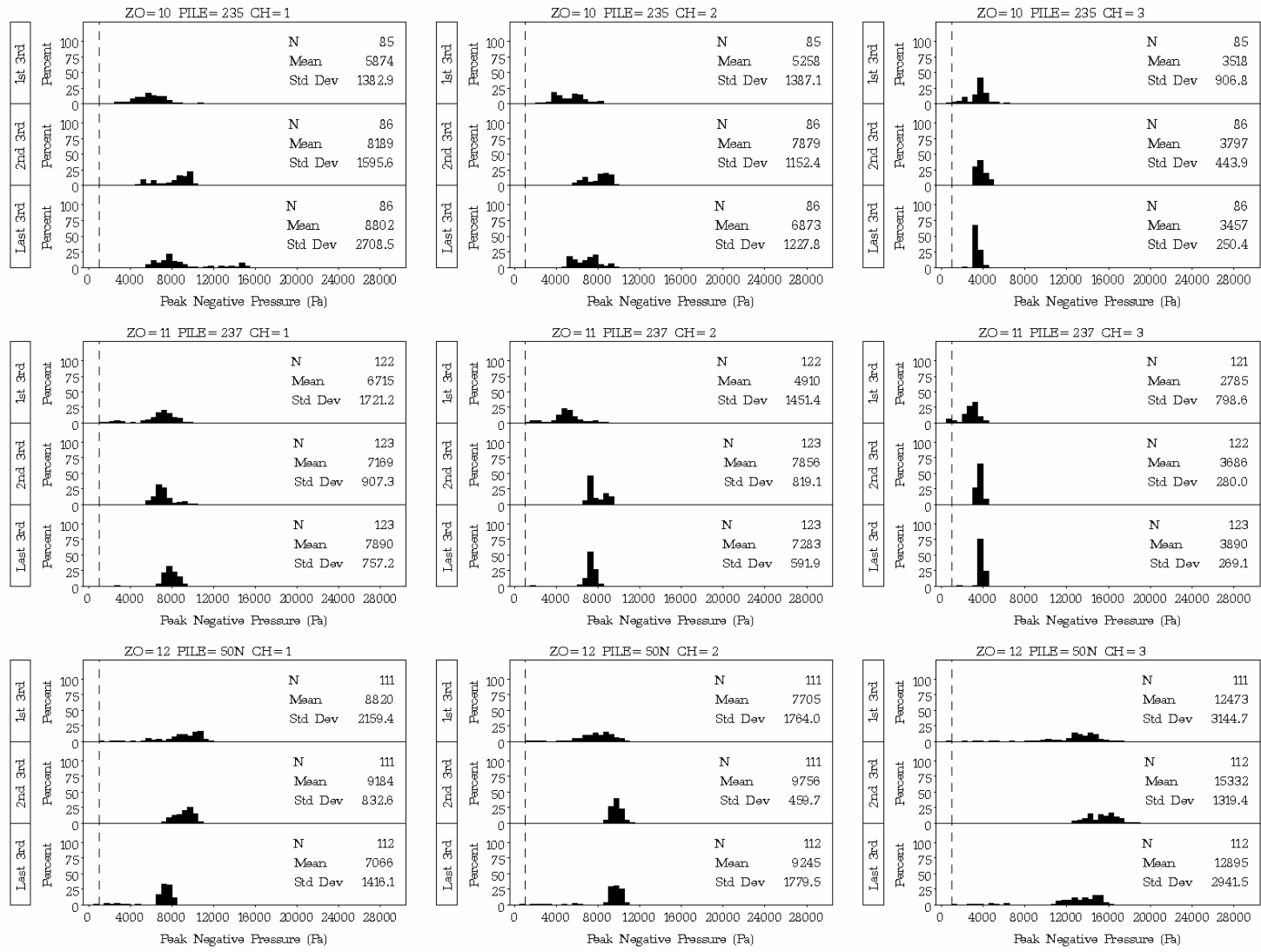

Figure D.18. Plots of Distribution Statistics on Peak Negative Pressure for Impacts on Plumb Piles 235 and 237 in 4.5 ft and 4 ft of Water, Respectively, with a Type II Confined Bubble Curtain in Place, and at Plumb Pile 50N in 40 ft of Water with No Bubble Curtain in Place

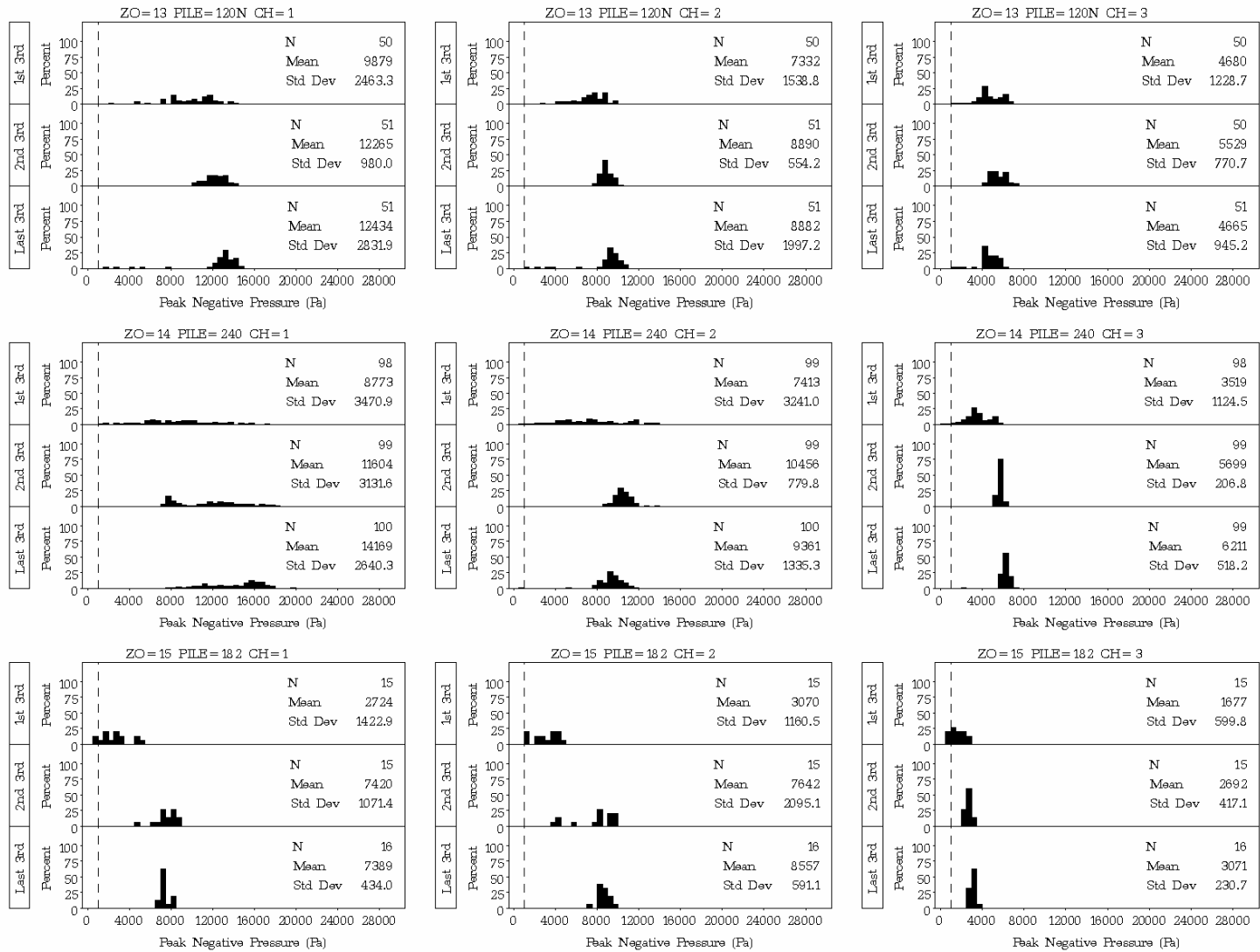

Figure D.19. Plots of Distribution Statistics on Peak Negative Pressure for Impacts on Plumb Piles 120N and 240 in 39 ft and 9 ft of Water, Respectively, with No Bubble Curtain in Place, and on Batter Pile 182 in 41 ft of Water with No Bubble Curtain in Place

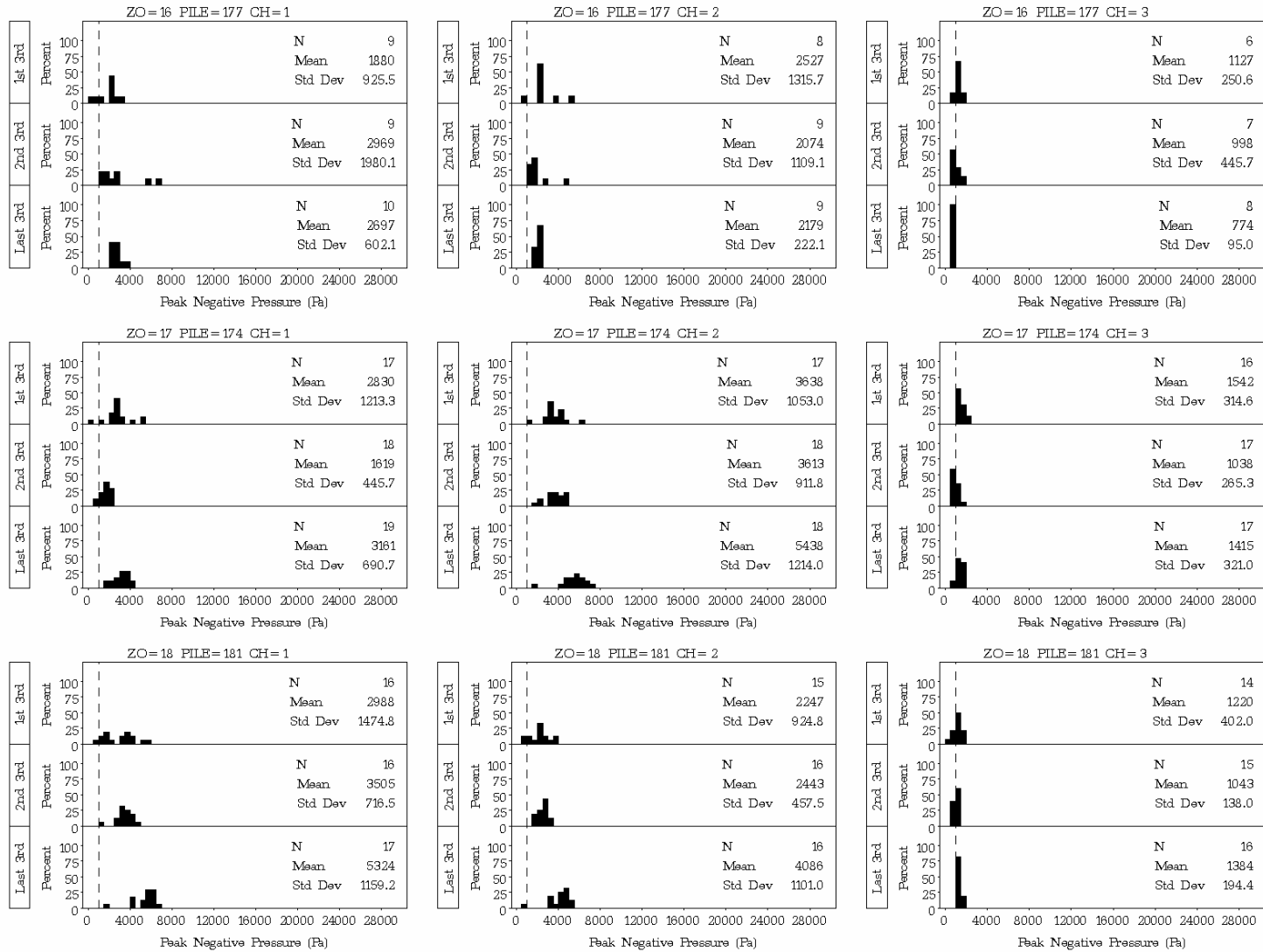

Figure D.20. Plots of Distribution Statistics on Peak Negative Pressure for Impacts on Batter Piles 177, 174, and 181 at the Hood Canal Bridge in 37 ft, 29 ft, and 33 ft of Water, Respectively, with Type I Unconfined Bubble Curtain in Place

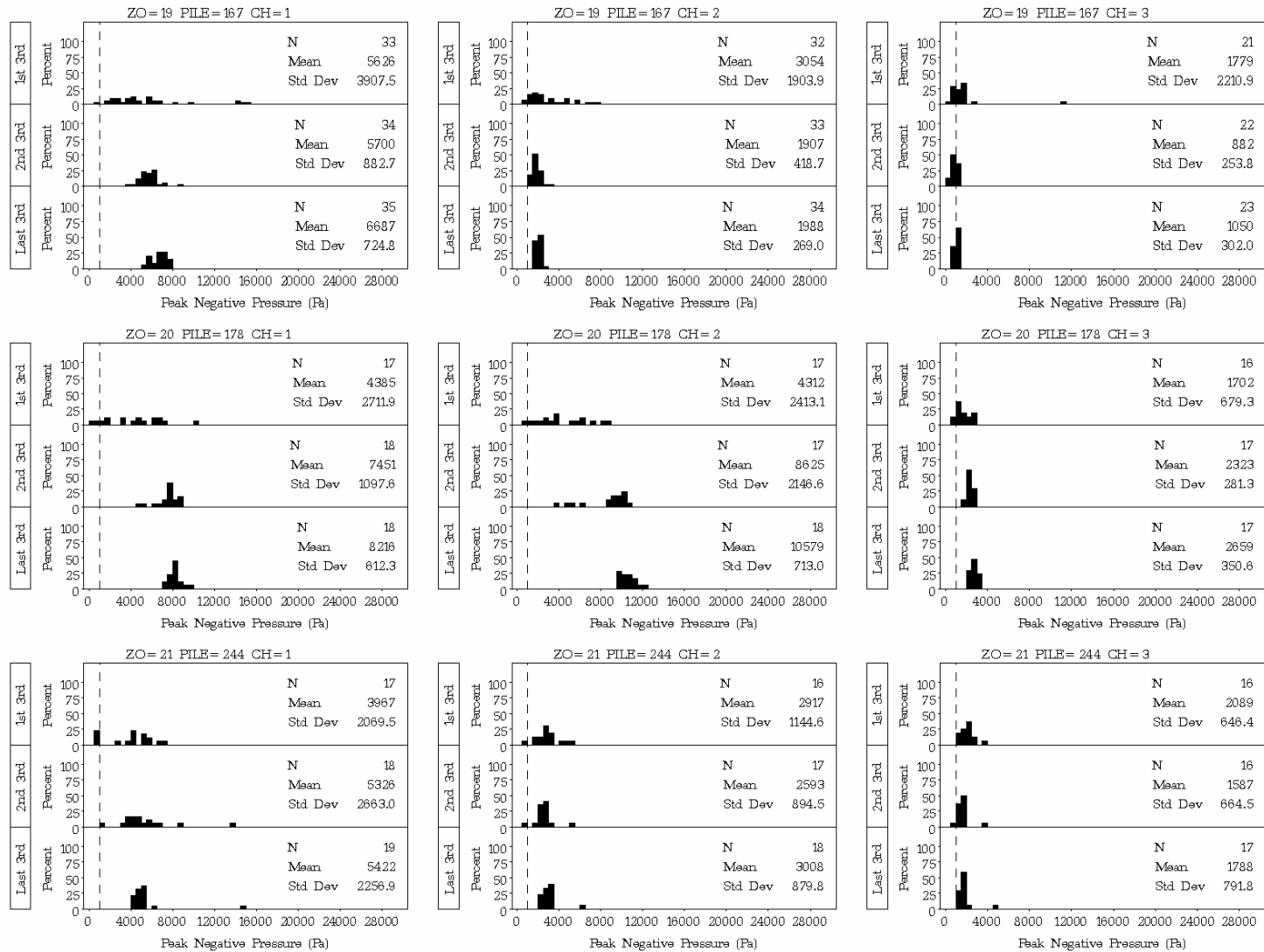

Figure D.21. Plots of Distribution Statistics on Peak Negative Pressure for Impacts on Batter Piles 167, 178, and 244 at the Hood Canal Bridge. Batter pile 167 is in 7 ft of water with a Type I unconfined bubble curtain in place; batter piles 178 and 244 are in 37 ft and 20 ft of water, respectively, with no bubble curtains in place.

APPENDIX E

**Plots of Spectral Density (Sound Energy) at
Each Hydrophone for Each Pile**

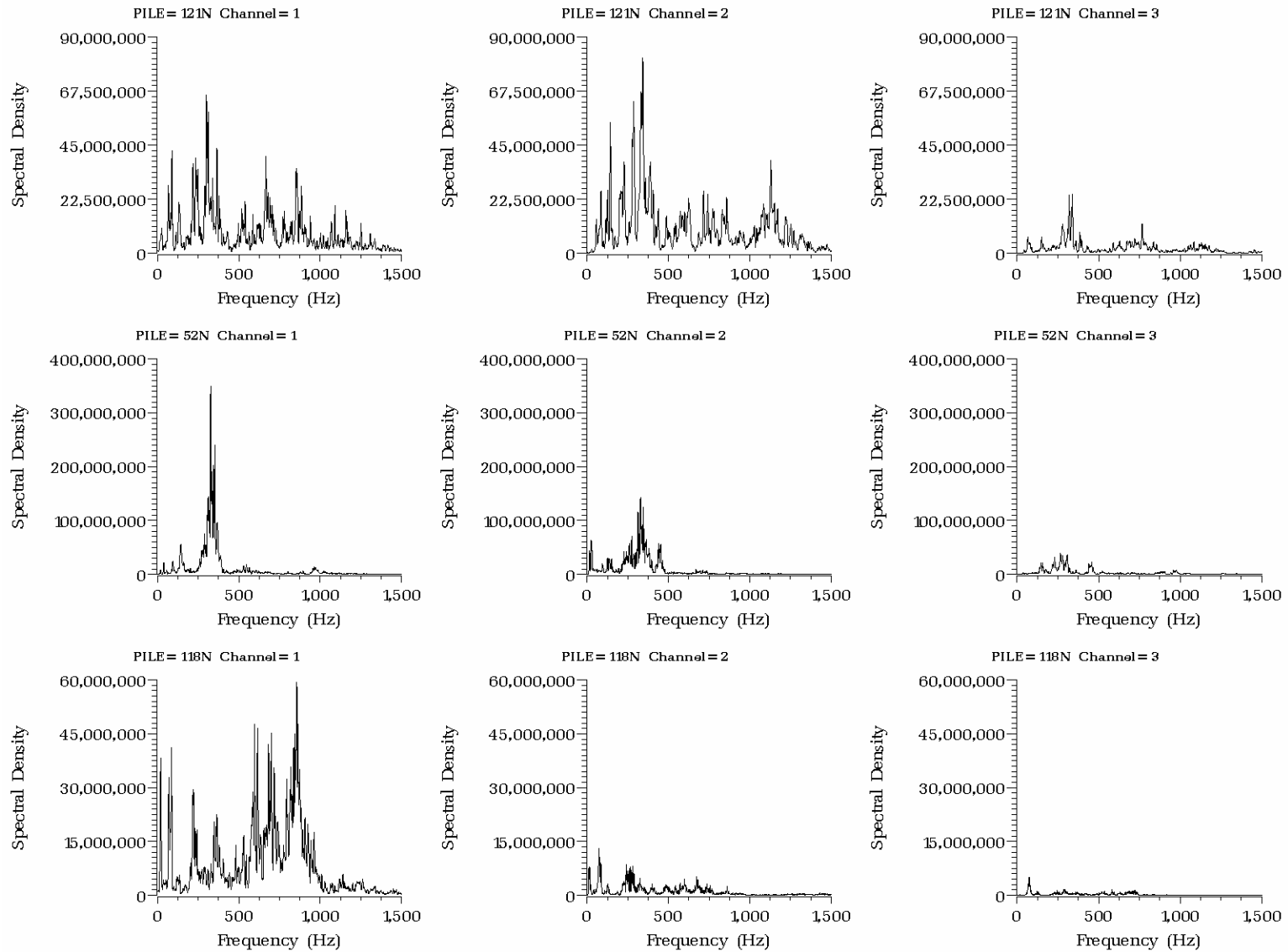

Figure E.1. Spectral Density (Pa^2/Hz) Versus Frequency (Hz) at Hydrophones H1 (left), H2 (center), and H3 (right) for the First 20 Impacts on Piles 121N, 52N, and 118N (all plumb piles driven with Type II confined bubble curtain in place)

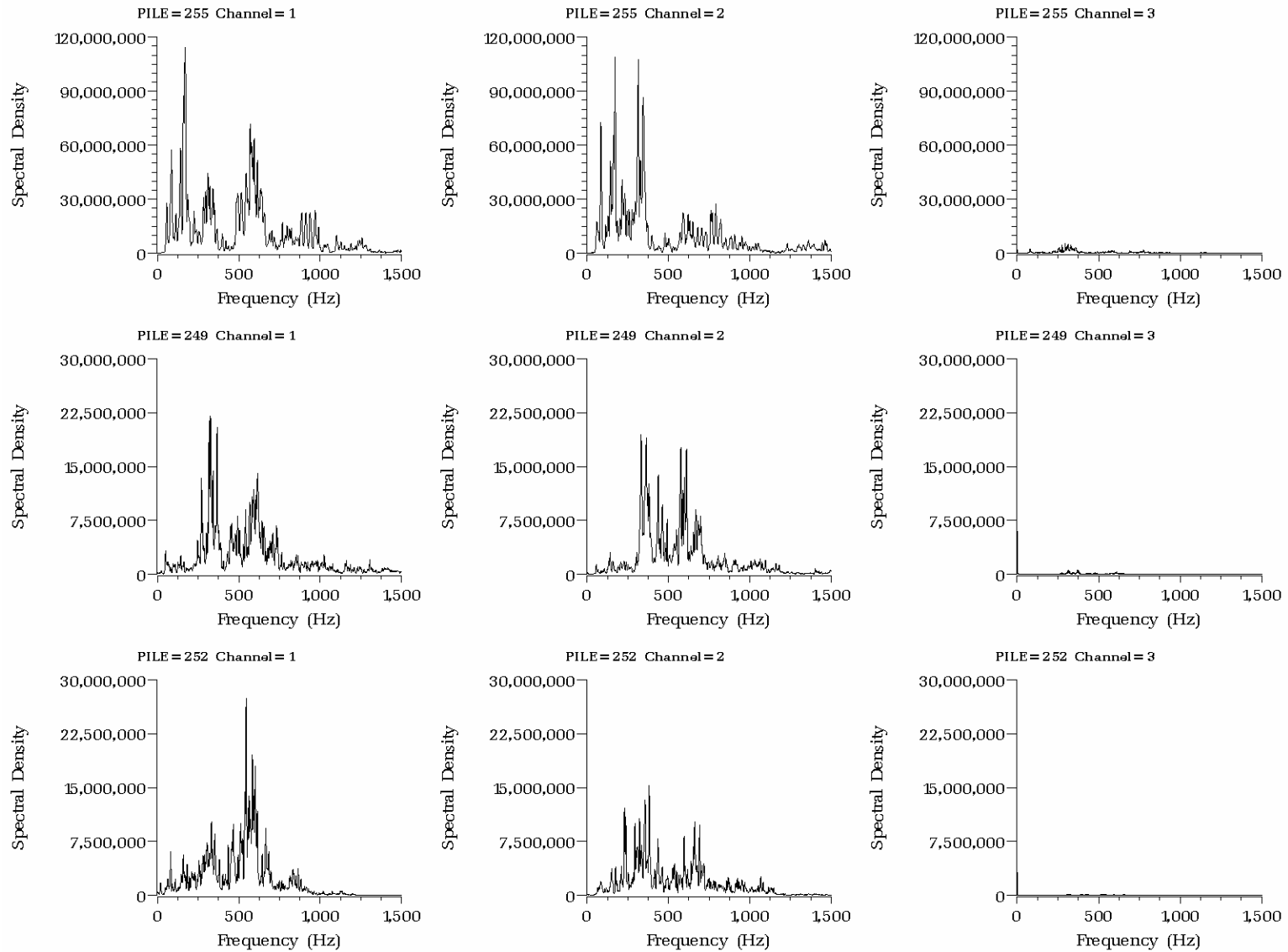

Figure E.2. Spectral Density (Pa²/Hz) Versus Frequency (Hz) at Hydrophones H1 (left), H2 (center), and H3 (right) for the First 20 Impacts on Piles 255, 249, and 252 (all plumb piles driven with Type II confined bubble curtain in place)

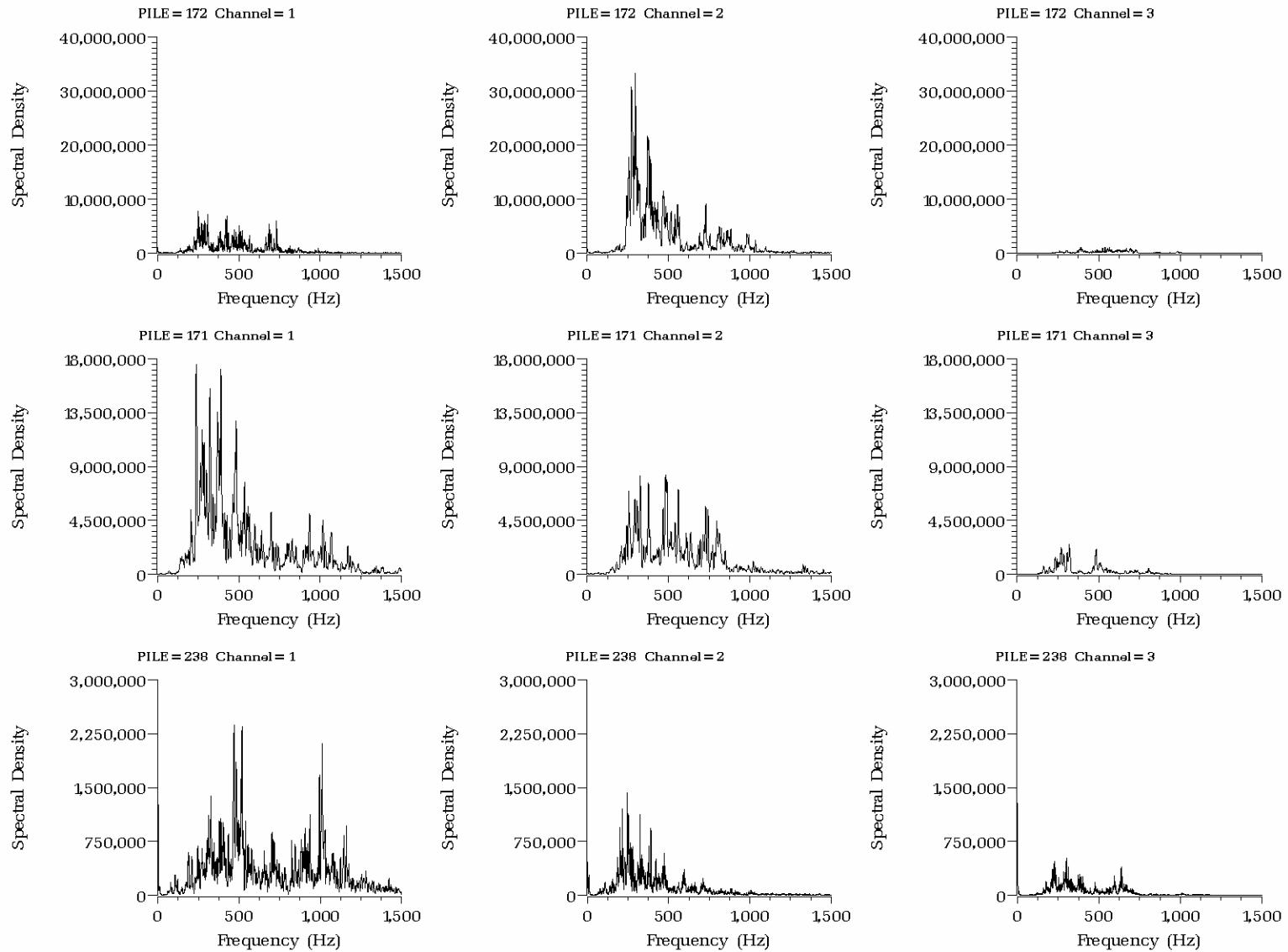

Figure E.3. Spectral Density (Pa²/Hz) Versus Frequency (Hz) at Hydrophones H1 (left), H2 (center), and H3 (right) for the First 20 Impacts on Piles 172, 171, and 238 (all plumb piles driven with Type II confined bubble curtain in place)

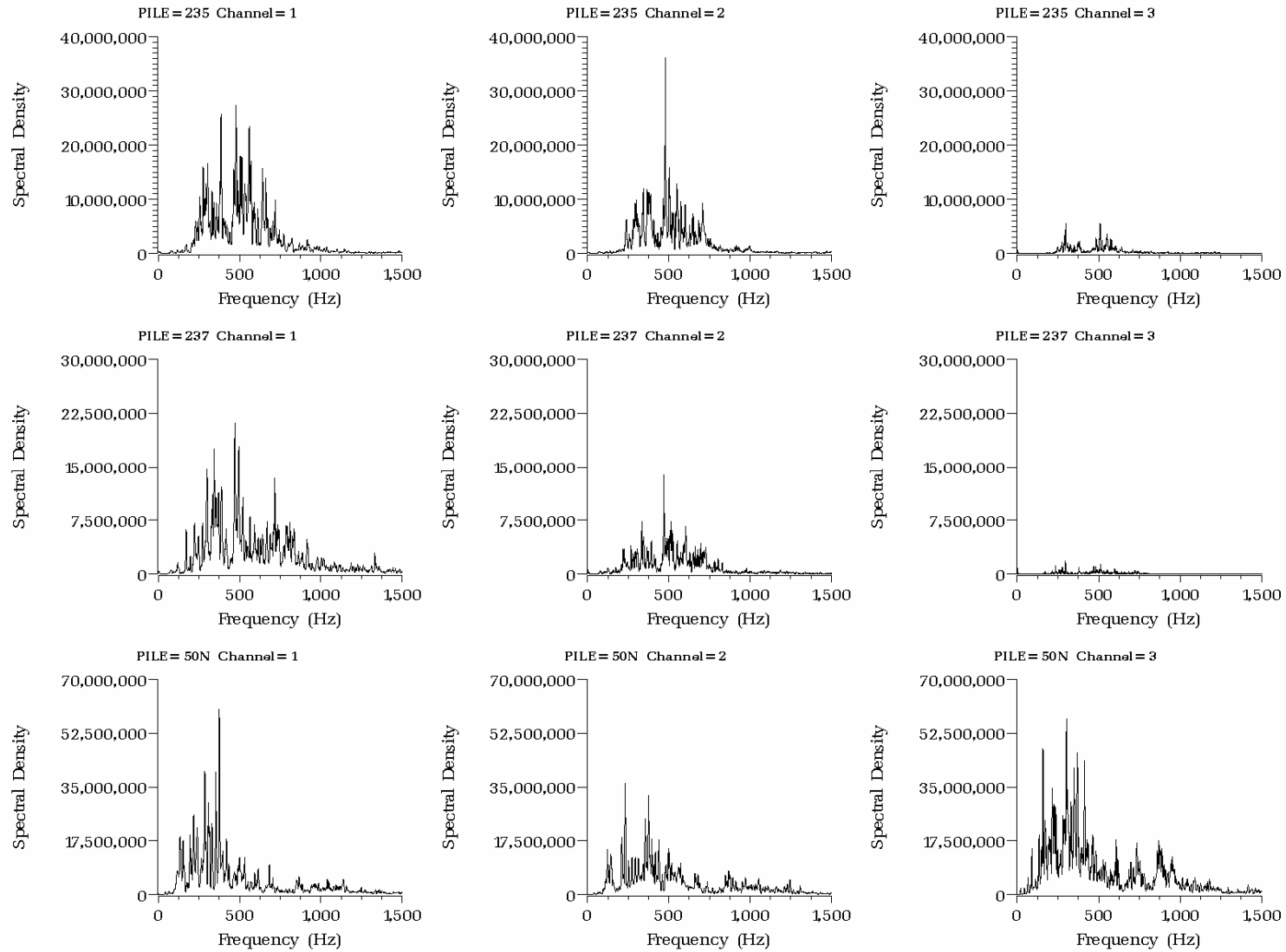

Figure E.4. Spectral Density (Pa²/Hz) Versus Frequency (Hz) at Hydrophones H1 (left), H2 (center), and H3 (right) for the First 20 Impacts on Piles 235, 237 (plumb piles driven with Type II confined bubble curtain in place), and 50N (plumb pile driven without bubble curtain)

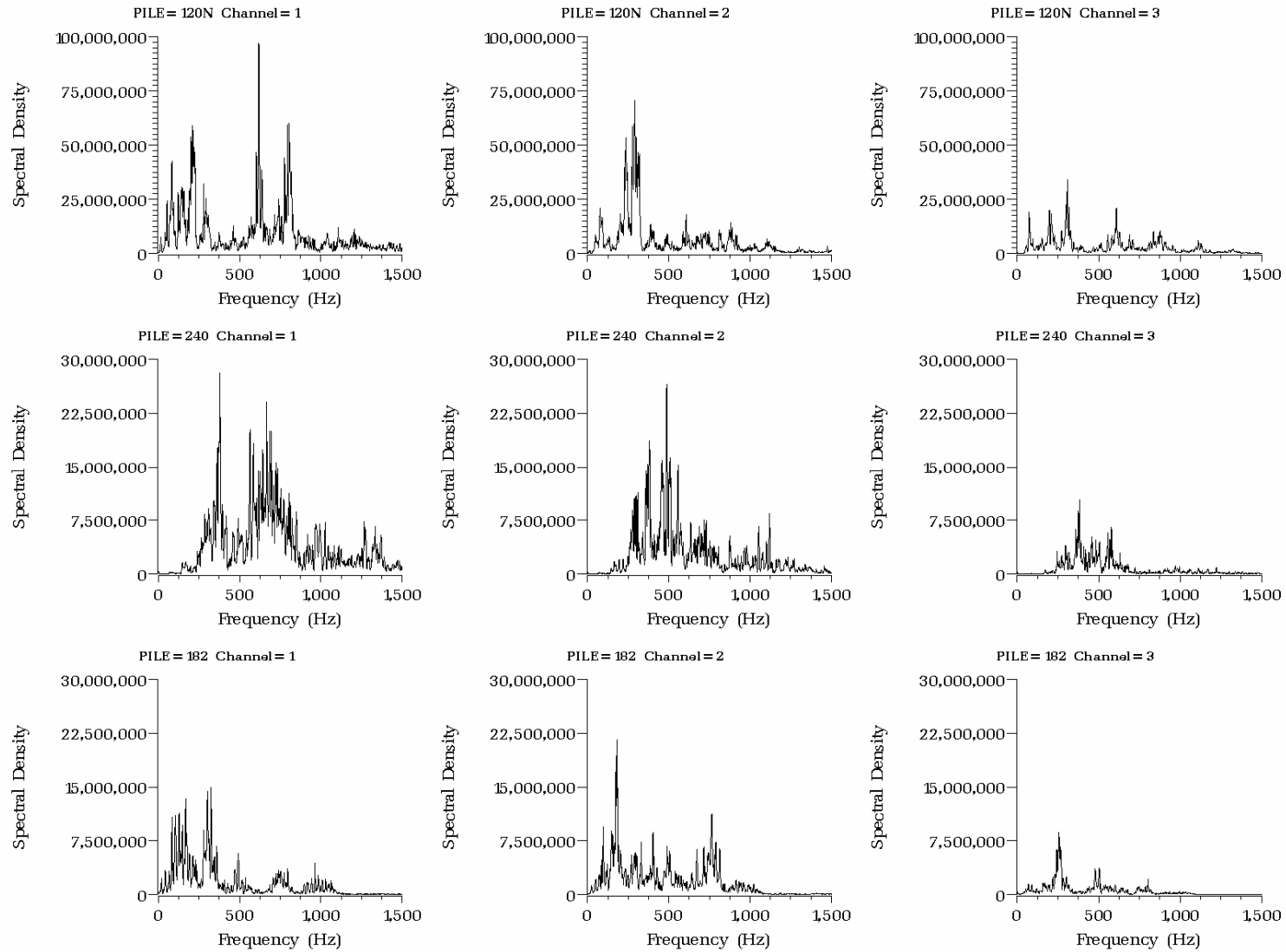

Figure E.5. Spectral Density (Pa²/Hz) versus Frequency (Hz) at Hydrophones H1 (left), H2 (center), and H3 (right) for the First 20 Impacts on Piles 120N, 240 (plumb piles driven without bubble curtain in place), and 182 (batter pile driven with Type I unconfined bubble curtain)

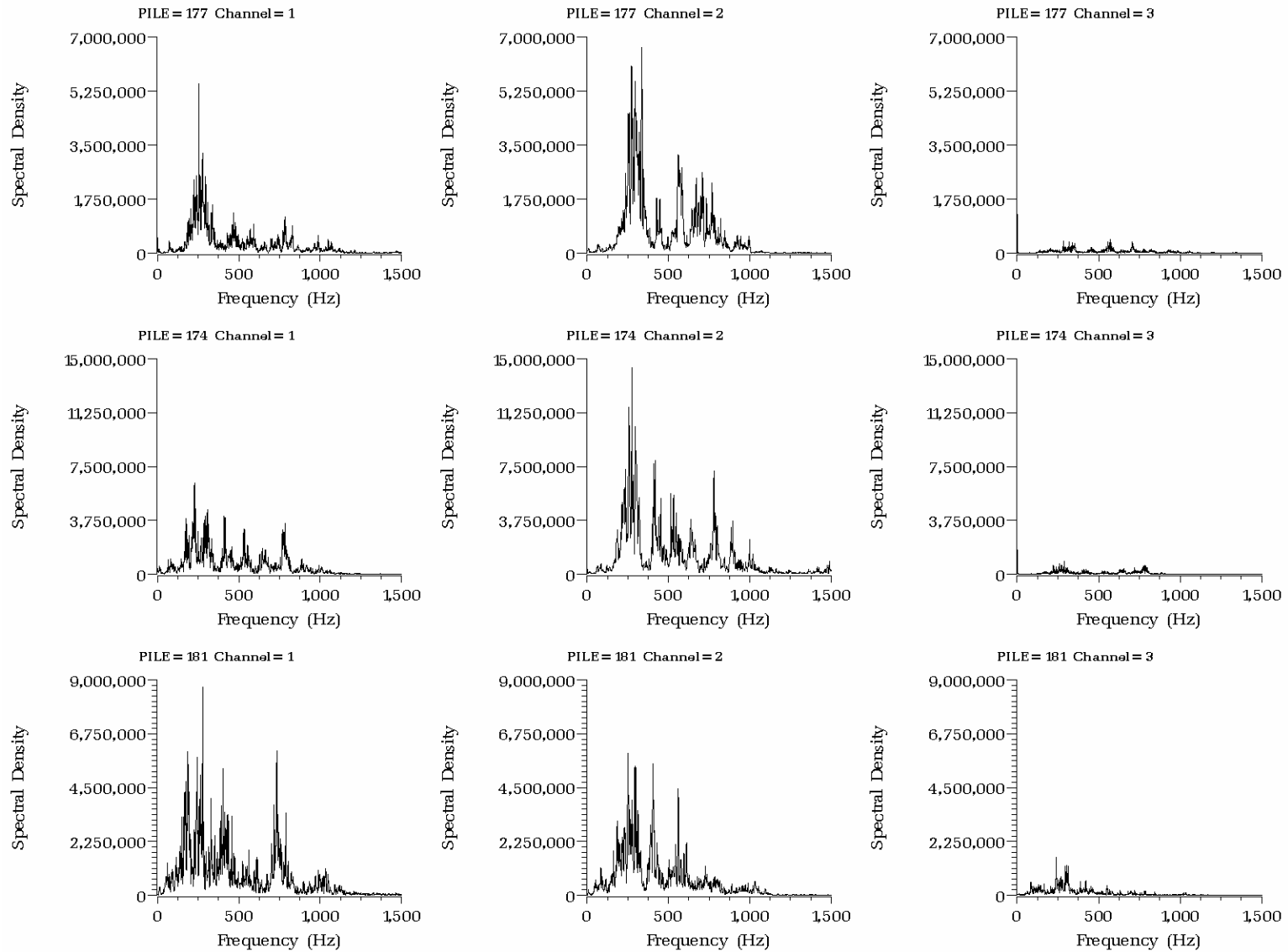

Figure E.6. Spectral Density (Pa²/Hz) versus Frequency (Hz) at Hydrophones H1 (left), H2 (center), and H3 (right) for the First 20 Impacts on Piles 177, 174, and 181 (all batter piles driven with Type I unconfined bubble curtain in place)

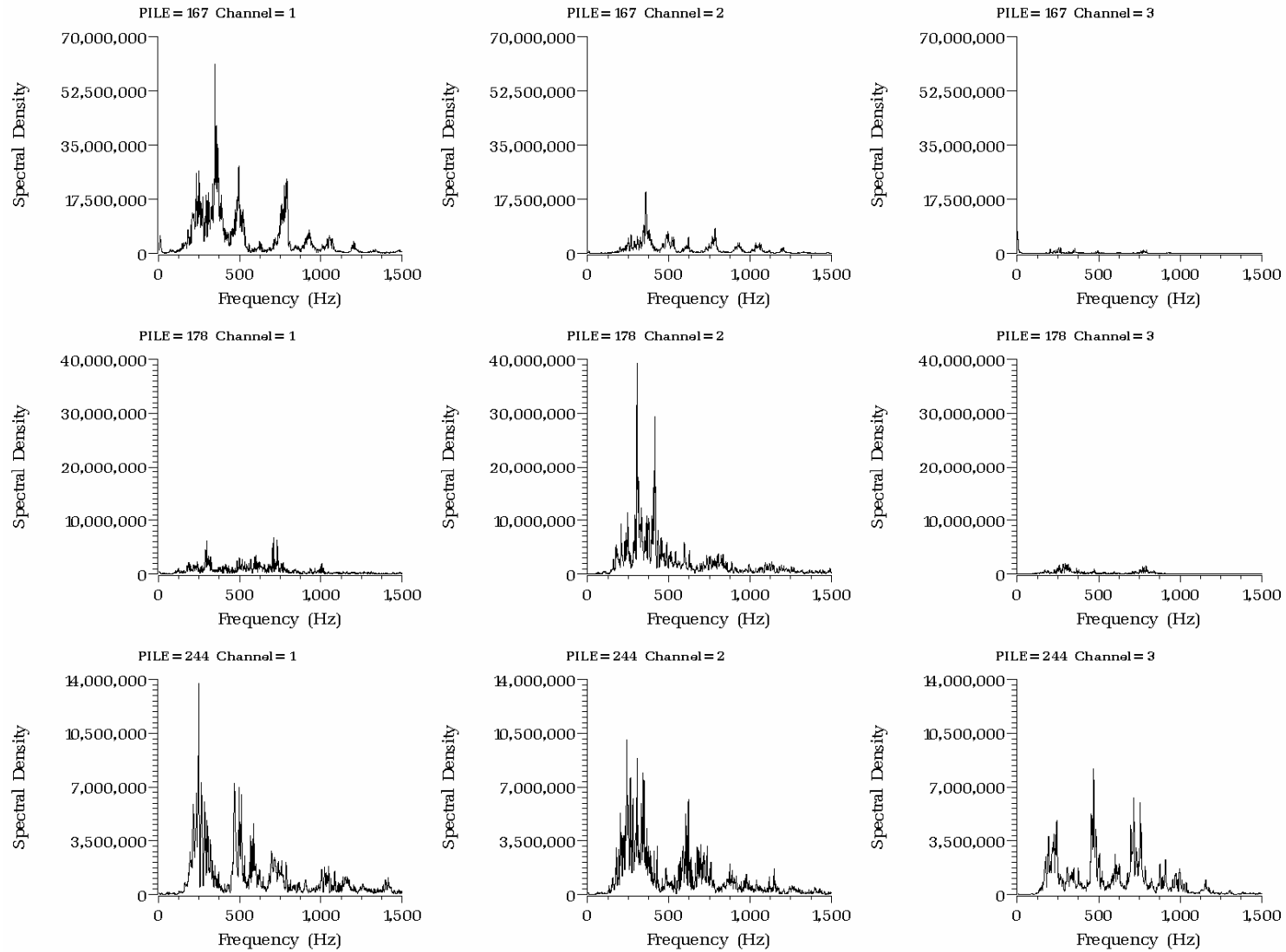

Figure E.7. Spectral Density (Pa²/Hz) versus Frequency (Hz) at Hydrophones H1 (left), H2 (center), and H3 (right) for the First 20 Impacts on Piles 167 (batter pile driven with Type I unconfined bubble curtain in place), and 178 and 244 (batter piles driven without bubble curtain)

APPENDIX F

Bubble Curtain Design and Specification Information

Bubble Curtain Type II

The Bubble curtain will be made out of an HDPE pipe sleeve that fits over the 24" pile and reaches from a point above water to the ground elevation below water. Sleeve diameter is to be determined based on information from Dr. John Stadler. Current thinking is around 34" OD +/- . Wall thickness is approximately 1 3/8". The HDPE sleeve will have a bubbler ring attached to the interior wall at the bottom. The bubbler ring will have 2 rows of 1/16" diameter holes spaced at 1 1/2" center to center per the perforation detail on Sheet G 21. This will be a steel tubular ring with an air supply fitting. The ring will have a steel pipe section welded on the bottom to not only provide weight but allow for some penetration into the subsoil. The HDPE sleeve will have centralizer spacers to hold a consistent space for bubble transfer around the pile. The diameter of this Sleeve will enable the removal up through the trestle installation template.

Equipment List

1. 1000 cfm @ 150 psi oil free compressor or larger
2. 50' of 3" diameter pneumatic hose
3. 200' of 2" diameter pneumatic hose
4. Primary manifold system, including valves, flow meters and pressure gauges
5. Bubbler ring with appropriate hole sizes and spacings
6. ~20' of 34" diameter HDPE (1 3/8" wall thickness)
7. 2 or 3 sets of spacers/centralizers
8. Seating ring

Air Pressure and Flow Requirements

Each bubbler ring requires approximately 320 scfm @ 100 psi. The compressor will deliver 1000 scfm @ 150 cfm. Air flow from the compressor to the ring assemblies must not be restricted so as to reduce the flow or pressure below required amount. The following is a compilation of the restrictions from the compressor to one ring using 1000 cfm from the compressor to the manifold and 400 cfm from the manifold to the ring assembly.

Item	PSI Drop
50' 3" hose	0.265
2.5" Gate Valve	0.104
Flow Meter	5.6
100' 2" hose	0.68
40 water depth (max)	17.8
 TOTAL DROP	 24.45 psi loss based on 400 scfm delivery to ring
 150 - 24.45 = 125.55 psi, well within the parameters	

Figure F.1. Contractor's Specifications for Confined Bubble Curtain used on Plum b Piles

WORK SHEET

Project Hood Canal Bridge
Type of Work TYPE 2 BRIDGE WEIR

Estimator G Davis
Date 10-9-03

SERIAL
Item No. 051
Sheet No. 1

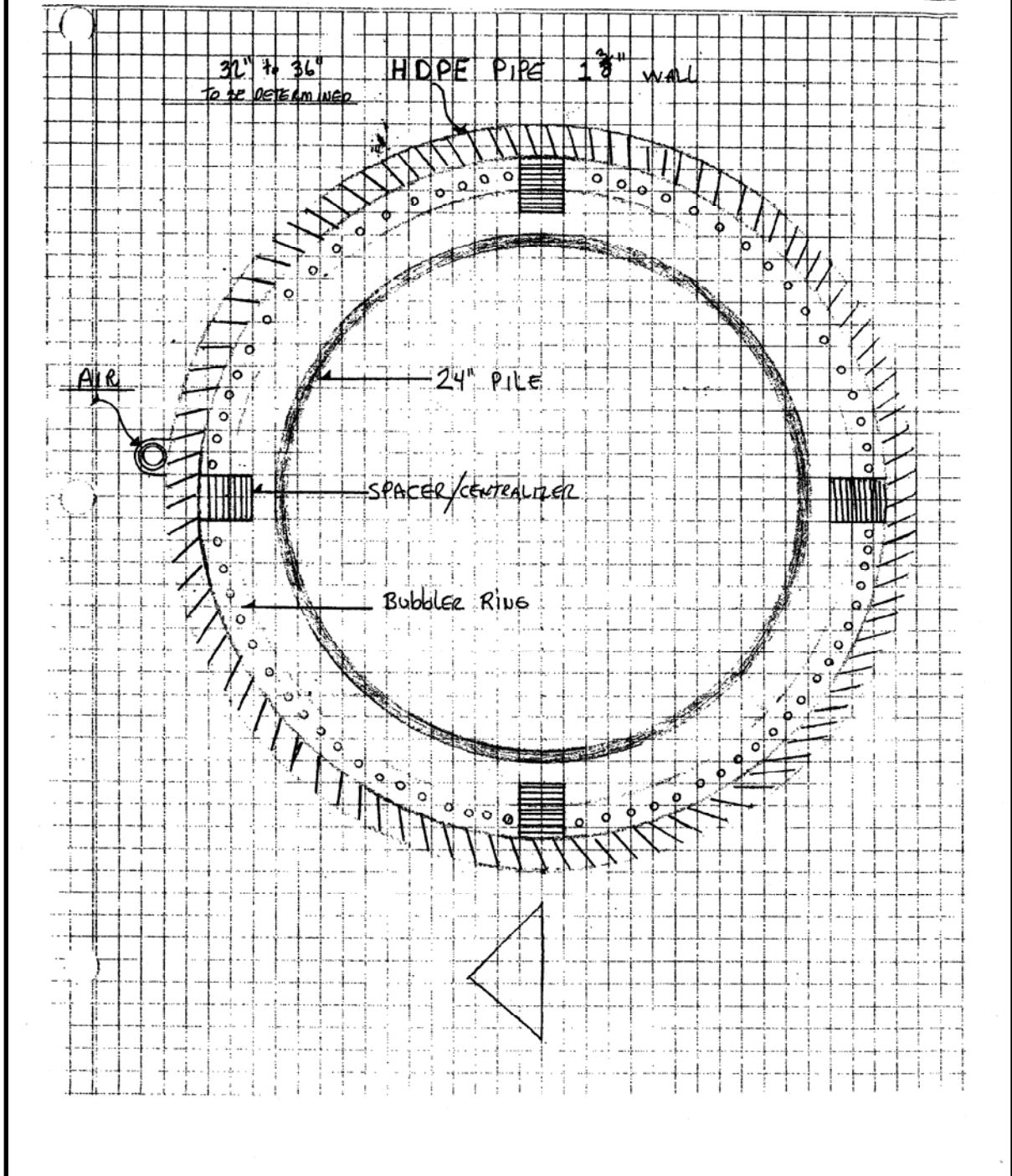

Figure F. 2. Contractor's Plan View Drawing of Bubble Ring for Confined Bubble Curtain used on Plumb Piles

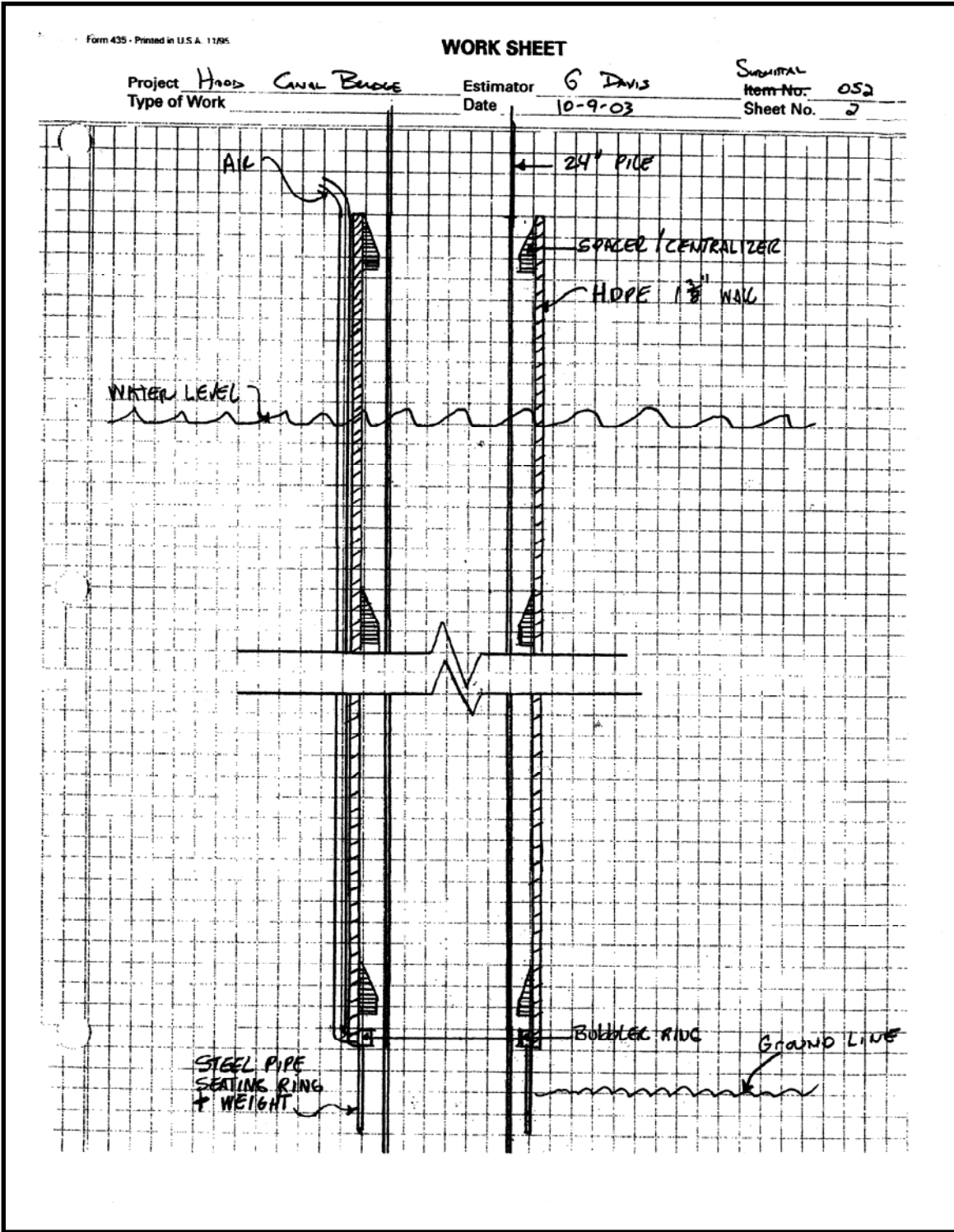

Figure F.3. Contractor's Side View Drawing of Bubble Ring for Confined Bubble Curtain used on Plumb Piles



Figure F.4. Type II Confined Bubble Curtain Sleeve Showing Air Supply Connection, Bubble Ring, Metal Extension to Contact Substrate

F.5



Figure F.5. Type II Confined Bubble Curtain Sleeve Deployed During Driving a Plumb Pile

**Hood Canal Bridge
Battered Pipe Pile Bubble Curtain**

Equipment List

1. 1000 cfm at 150 psi oil free compressor or larger
2. 50' of 3" diameter pneumatic hose
3. 200' of 2" diameter pneumatic hose
4. Primary manifold system, including valves, flow meters and pressure gauges
5. Secondary manifold rings
6. Linking hardware between rings
7. Multiple ring assembly
8. Steel base plate
9. Guide rings at bottom. May add more at mid-point if necessary.

Note: This alternative can have multiple layers of bubble curtains as deemed necessary.

Air Pressure and Flow Requirements

Each bubbler ring requires approximately 320 scfm @ 100 psi. The compressor will deliver 1000 scfm @ 150 cfm. Air flow from the compressor to the ring assemblies must not be restricted so as to reduce the flow or pressure below required amount. The following is a compilation of the restrictions from the compressor to one ring using 1000 cfm from the compressor to the manifold and 400 cfm from the manifold to the ring assembly.

Item	PSI Drop
50' 3" hose	0.265
2.5" Gate Valve	0.104
Flow Meter	5.6
100' 2" hose	0.68
40 water depth (max)	17.8
 TOTAL DROP	 24.45 psi loss based on 400 scfm delivery to ring

150 - 24.45 = 125.55 psi, well within the parameters

Operating Sequence for Battered Pile Bubble Curtain

System shall be assembled in such a way that there are no kinks or sharp bends in the hoses. The 3" hose shall be in line between the compressor and the primary manifold. The 2" hose shall be installed between the primary manifold and bubbler rings.

The bubble curtain system will be picked up by a crane or overhead lifting device to lower ring assembly to the mudline and retrieve when pile is driven. The air hoses will be placed either inside or adjacent to the alignment tubing. It will be set in place prior to the pile, and then the pile will be threaded through it to mudline and driven. Care will be taken to ensure no damage to assembly during pile placement.

The bubble curtains will follow the details provided on sheet G 22 of the contract drawings, unless otherwise noted. The holes in the bubbler will be 1/16" in diameter and either have 2 rows at 1 1/2" spacing or 1 row of 3/4" spacing.

Once air has been supplied to the primary manifold, and ring assembly is in place at mudline, air can be discharged to each bubbler individually and adjusted until optimum performance has been achieved. Removal of the ring assembly will occur after the pile has been driven to final depth. Since the rings do not fully encompass the pile it can be simply pulled away.

Figure F.6. Contractor's Specifications for Unconfined Bubble Curtain Used on Battered Piles

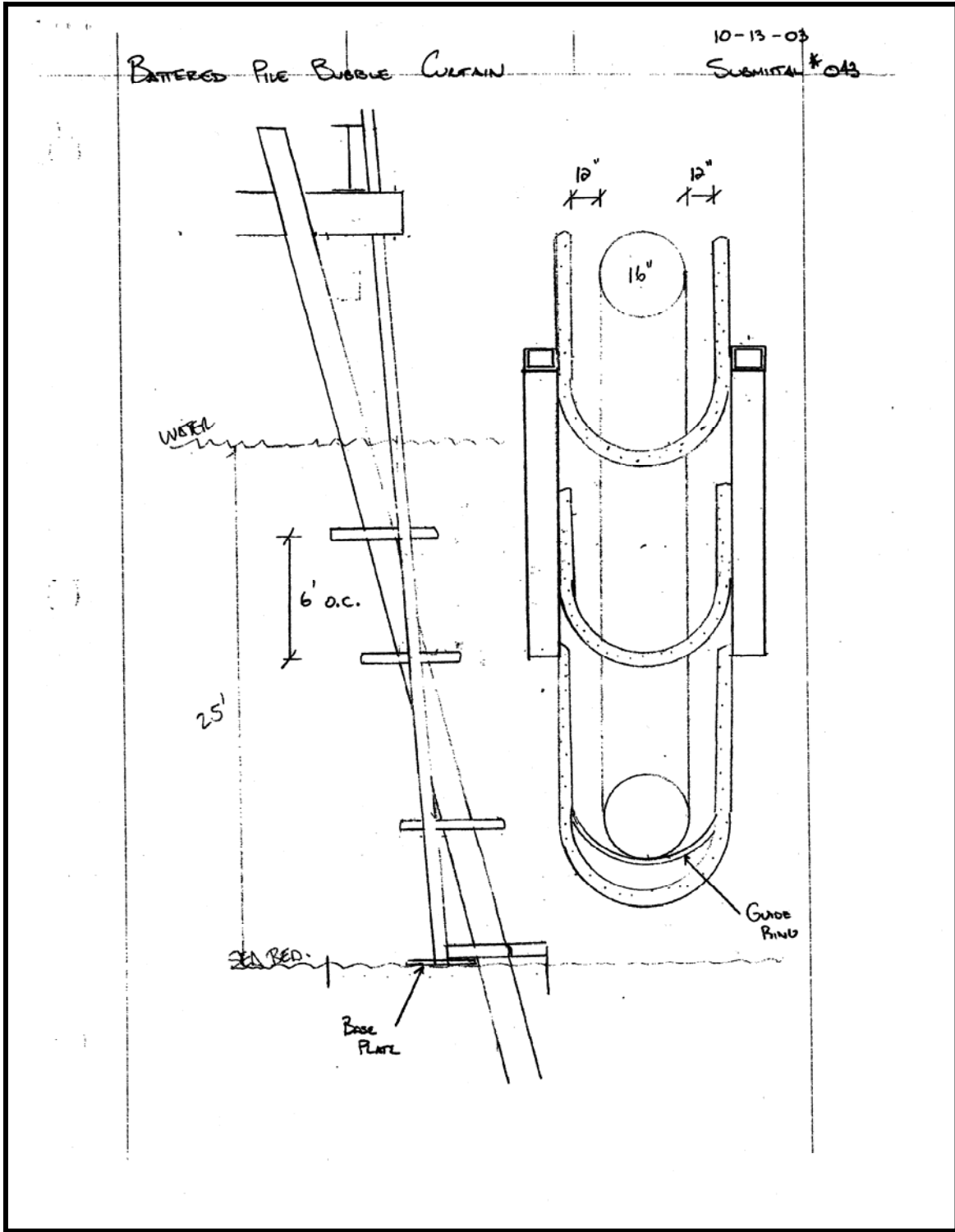

Figure F.7. Contractor's Side and Top View Drawings of Multiple Bubbler Unconfined Bubble Curtain Used on Battered Piles



Figure F 8. Type IU unconfined Bubble Curtain and Batter Pile, Pile and Bubble Curtain Lowered into Place, Air Connection to Bubble Rings, and Batter Pile Driving with Bubble Curtain in Place (hydrophone float visible at lower right)