

# 2022 Ramp & Roadway



Washington State Department of  
**Transportation**

**Northwest Region**  
Average Daily Volumes



## ***Table of Contents***

Summary Report.....	3
Legend.....	5
I-5.....	6
I-90.....	237
I-405.....	48
SR 18.....	64
SR 99.....	71
SR 167.....	76
SR 509.....	82
SR 518.....	86
SR 520.....	89
SR 522.....	95
SR 525.....	100
SR 526.....	102
SR 599.....	104
US 2.....	106
Appendix.....	108

# RAMP AND ROADWAY TRAFFIC VOLUME REPORT

## 2022 SUMMARY REPORT

---

During 2023, the Transportation Management Center (TMC) of the Northwest Region updated the 2022 Ramp and Roadway Volumes Report. Traffic counts were taken from January 2022 through December 2022 from vehicle detection loops.

The following interstate and state highways are included in this report:

- 1) I-5 from the Pierce County Line to the Stillaguamish River
- 2) SR-18 from I-5 to Issaquah-Hobart Road
- 3) I-90 from 4<sup>th</sup> Ave S in Seattle to High Point Road
- 4) SR-99 from SR-599 Pacific Hwy S to Ray St Seattle
- 5) SR-167 from the Pierce County Line to I-405
- 6) I-405 from I-5 in Tukwila to I-5 in Lynnwood
- 7) SR-509 from S 188<sup>th</sup> St to 1<sup>st</sup> Ave Bridge S
- 8) SR-518 from SR-509 to I-5
- 9) SR-520 from I-5 to SR-202 Redmond Way
- 10) SR-522 from 65<sup>th</sup> Ave NE to US-2
- 11) SR-525 from Alderwood Mall Blvd to SR-99 Pacific Hwy
- 12) SR-526 from Airport Rd to I-5
- 13) SR-599 from I-5 to SR-99 Pacific Hwy
- 14) US 2 from I-5 to Rice Rd

Average weekday volumes (AWD) were computed from Tuesday through Thursday data. AM and PM peaks correspond to the highest hourly volumes. If a peak occurred outside of 6:00 AM to 9:45 AM or 2:30 PM to 6:45 PM, it is indicated in the report with an asterisk (\*). The peak times for those locations were noted in the appendix.

NOTE: All roadway drawings are NOT drawn to scale.



## 2022 SUMMARY REPORT

---

Special thanks go to the Northwest Region Transportation Management Center engineers, technicians, and interns for their hard work in compiling and analyzing the data for this report.

An electronic copy of the ramp and roadway data sheets contained in this report is also posted on our website at the following address:

<https://wsdot.wa.gov/about/transportation-data/travel-data/ramp-roadway-report>

For more information on this report, please contact:

Transportation Management Center  
15710 Dayton Avenue North  
P.O. Box 330310  
Seattle, WA 98133-9710

Telephone: (206) 410-0006  
Fax: (206) 440-4804

# LEGEND

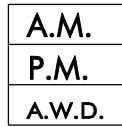

ramp volume

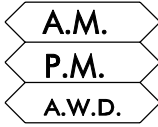

high-occupancy vehicle (HOV) lane volume



mainline volume  
(does not include HOV lane volume)

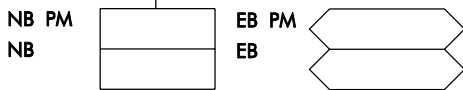
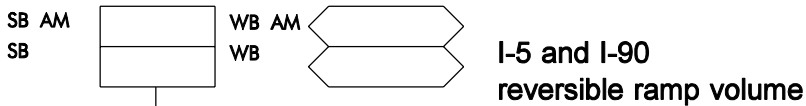
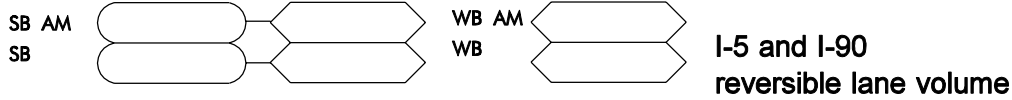

HOV facility



beginning or end of HOV facility



metered ramp shoulder



peak hour occurred outside of normal peak hour  
(6 to 9:45 AM or 2:30 to 6:45 PM; See Appendix)

S

speed data available at this location

T

data obtained from tube counters

A.M.

am peak hour volume

P.M.

pm peak hour volume

CONSTR

data not available due to construction

A.W.D.

average weekday volume

N.A.

data not available



Pierce County Line

S 375TH ST

Federal Way Weigh Station

Enchanted PKWY

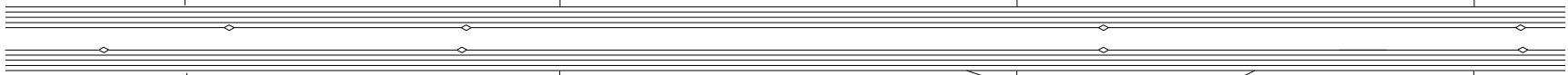
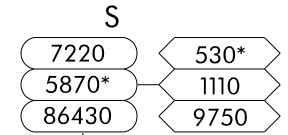
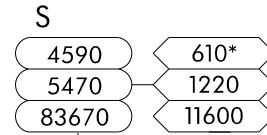
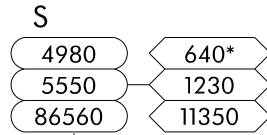
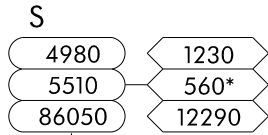

WEIGH STATION  
REST AREA

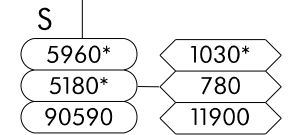
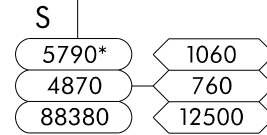
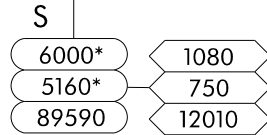
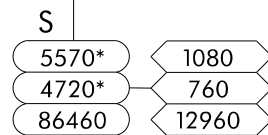
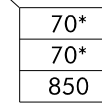
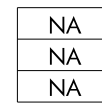

Washington State  
Department of Transportation



1  
OF  
31

EXIT 142A\B

SR 18

S 336TH ST S 329TH ST

EXIT 143

S 320TH ST

S 317TH ST  
PARK & RIDE  
DIRECT ACCESS

S 308TH ST

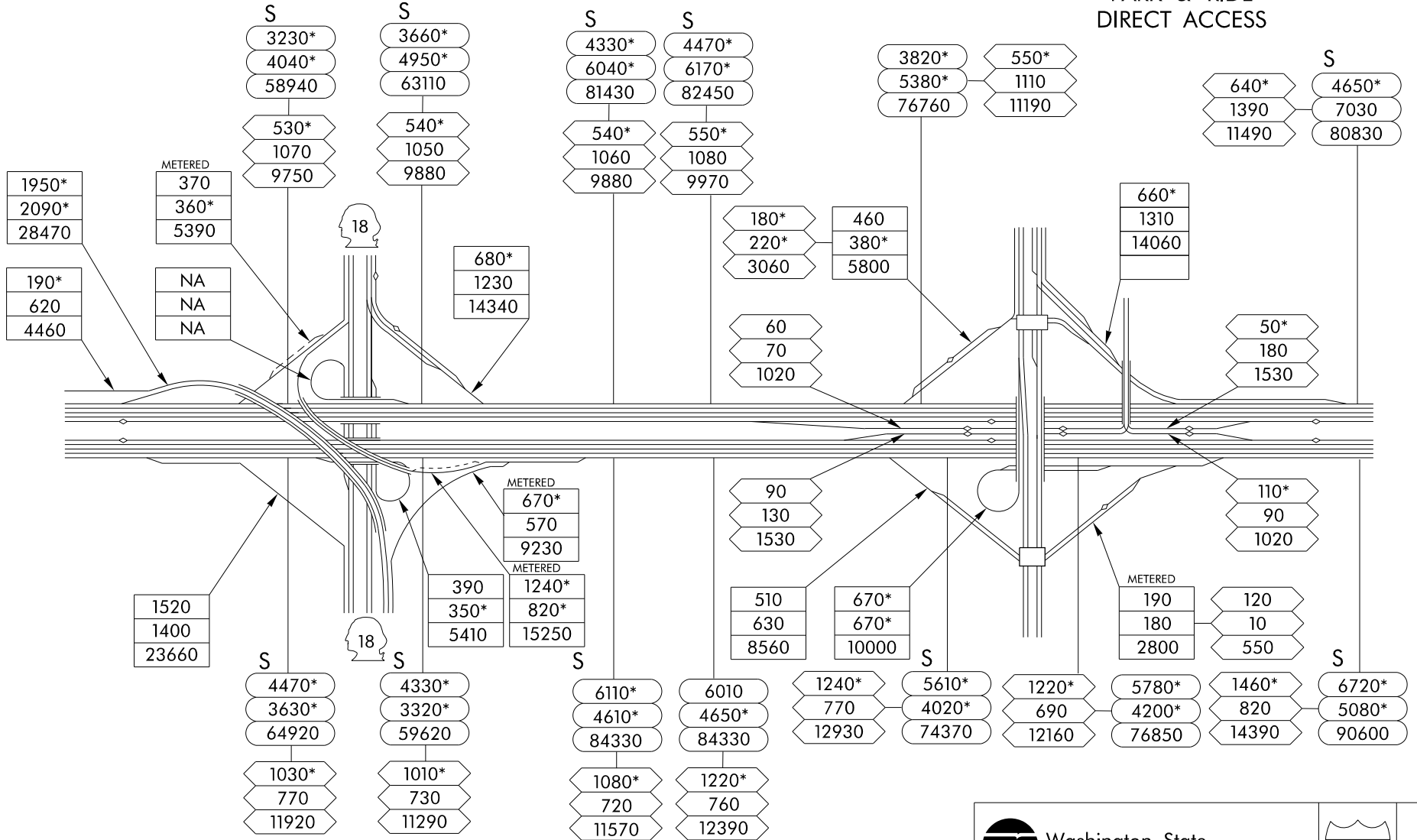

Washington State  
Department of Transportation



2  
OF  
31

S 298TH ST

S 289TH ST

S 280TH ST

EXIT 147

S 272ND ST

S 266TH ST

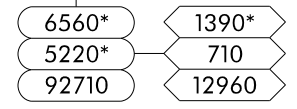
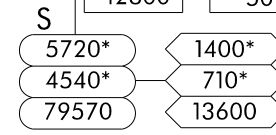
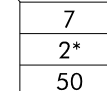
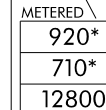
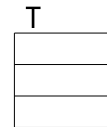
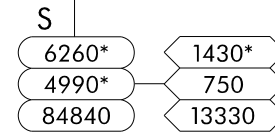
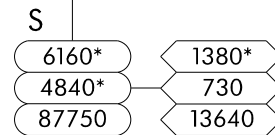
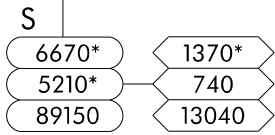
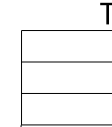
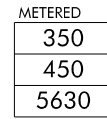
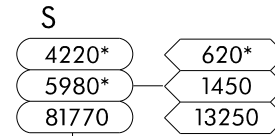
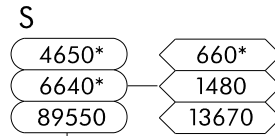
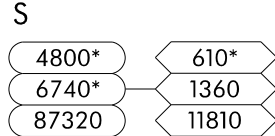
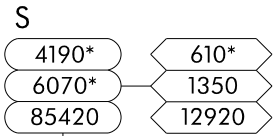

Washington State Department of Transportation



3 OF 31

S 260TH ST

S 252ND ST

S 243RD ST

EXIT 149A/B

SR 516

S 216TH ST



S

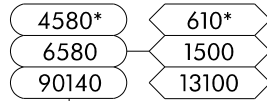
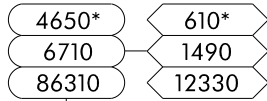

S

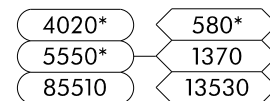
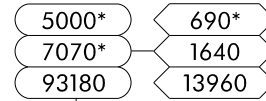

S

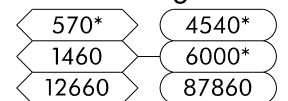

METERED

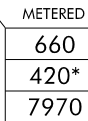
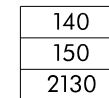
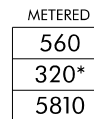
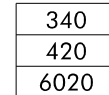
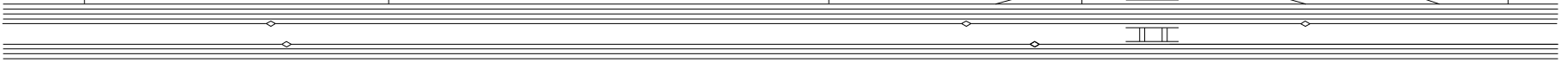
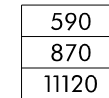
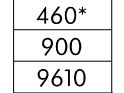

S

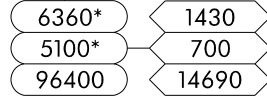
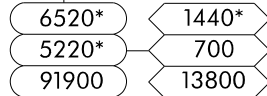

S

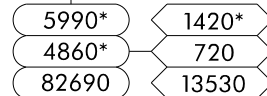
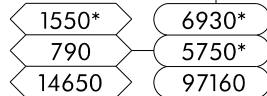

S

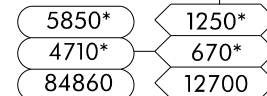

S

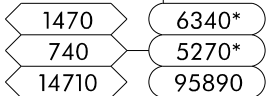



**EXIT 151**  
S 200TH ST  
MILITARY RD

**EXIT 152**  
S 188TH ST  
ORILLIA RD

S 183RD ST

S 178TH ST

4650*	570*
5930*	1520
86350	12700

520*	4500*
1470	5650*
11960	83040

530*	5380*
1480	7000*
11630	97150

5330*	500*
6910*	1320
99240	11160

METERED

280*	310
650	350
4730	5310

METERED

460*	230	460
880	290	470
9840	3990	6160

300	590
300	460
5010	7010

550	770
490	1000
8800	12550

6430*	1460
5330*	740
93280	14280

S

1470	6210*
630	5150*
13600	94850

S

1550	7190
650	6280
12930	106450

6660	1360
5730*	580
101960	11850



Washington State  
Department of Transportation



5  
OF  
31

S 172ND ST

EXIT 154A  
KLIICKITAT DR  
SOUTHCENTER PKWY

EXIT 154A/B  
SR 518  
I-405

EXIT 154B  
S 154TH ST  
SOUTHCENTER BLVD



S

5040*	400*
6850*	1180
96620	9400

4370*
6670*
90280

1310*	360*
1640	690
24820	8100

4160*	700*
6340*	1440
95030	15900

METERED

1010*	210*
1270*	530
16800	8170

S

1060
480
9140



850	1070*
830*	1440
15560	19800

710*
970
10570

KLIICKITAT DR

SOUTHCENTER PKWY

S

380*
860
7430

T

990	1600*
970	1250
15890	22250

430
180
2910



930*	1780*
960*	1320*
15880	24490

METERED

530*	30
760	60
9410	660

6740	1260
5770*	540
107090	10720

4540
2990*
64100

7480	1070
5450*	480
118400	9200



Washington State  
Department of Transportation



6  
OF  
31



S 144TH ST

EXIT 156  
SR 599

EXIT 156  
INTERURBAN  
AVE

S 129TH ST



S

5890*	680*
8200*	1350*
98950	12280

5300*	4480*
7270*	5920*
98370	84930

4470*	590*
5930*	1130*
95180	11620

S

4690*	640*
6280*	1280
87110	12660

580*
1100*
11400

630*
1210*
12210



530*
850*
10010

160*
360
3640

230*
440
4390

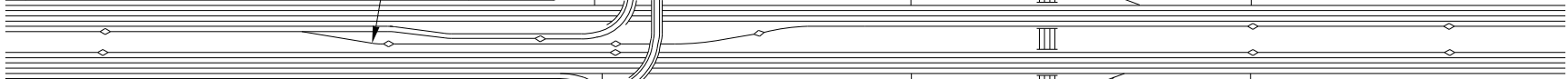

2250
1510
27560

80
80
1190

METERED	370
	370
	5140

S

7720	1010
5950*	590*
108600	10510

5600	1050
4470*	620*
81000	11060

5620	1120
4510*	670*
80790	11770

S

5940	1150
4790*	710*
83090	11860



Washington State  
Department of Transportation



7  
OF  
31

EXIT 157

SR 900  
M L KING JR WAY S

EXIT 158

S BOEING  
ACCESS RD

S NORFOLK ST

S BENEFIT ST

S THISTLE ST

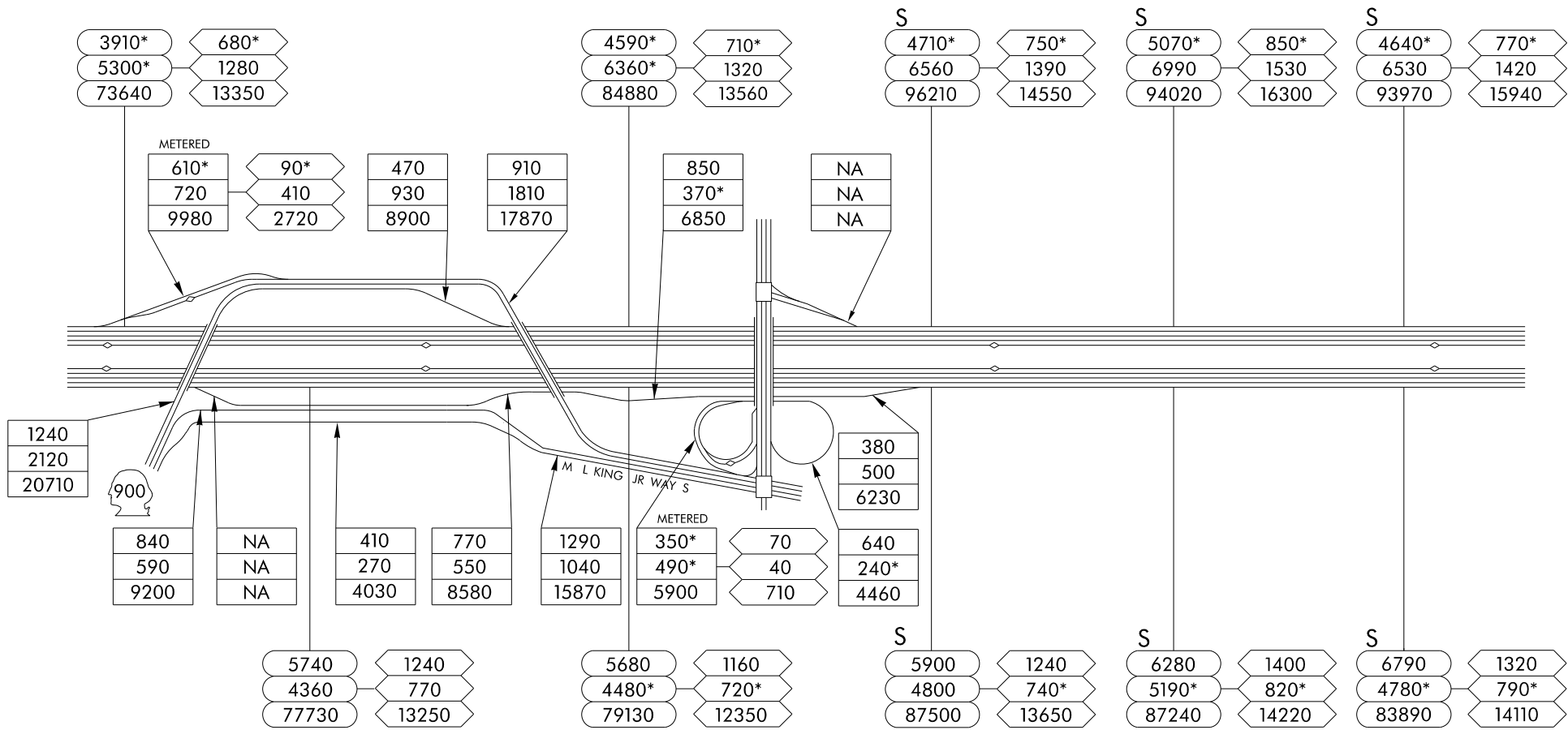

EXIT 161

EXIT 162

S HOLDEN ST

S HOLLY ST

ALBRO PL  
SWIFT AVE S

CORSON AVE S  
S MICHIGAN ST

S PEARL ST

S OREGON ST

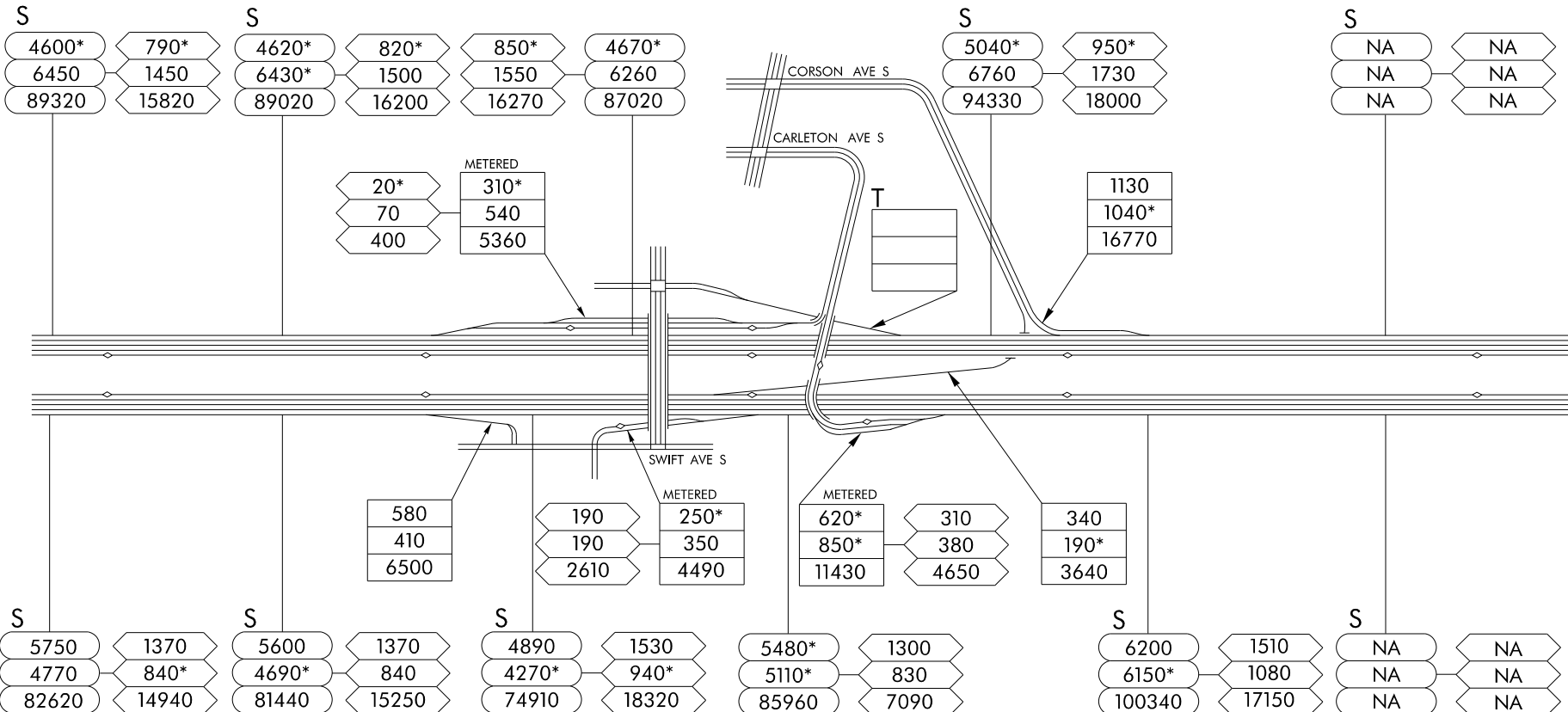

EXIT 163/163A

EXIT 163B

S SPOKANE ST  
COLUMBIAN WY  
WEST SEATTLE BRIDGE

S FOREST ST

S HOLGATE ST

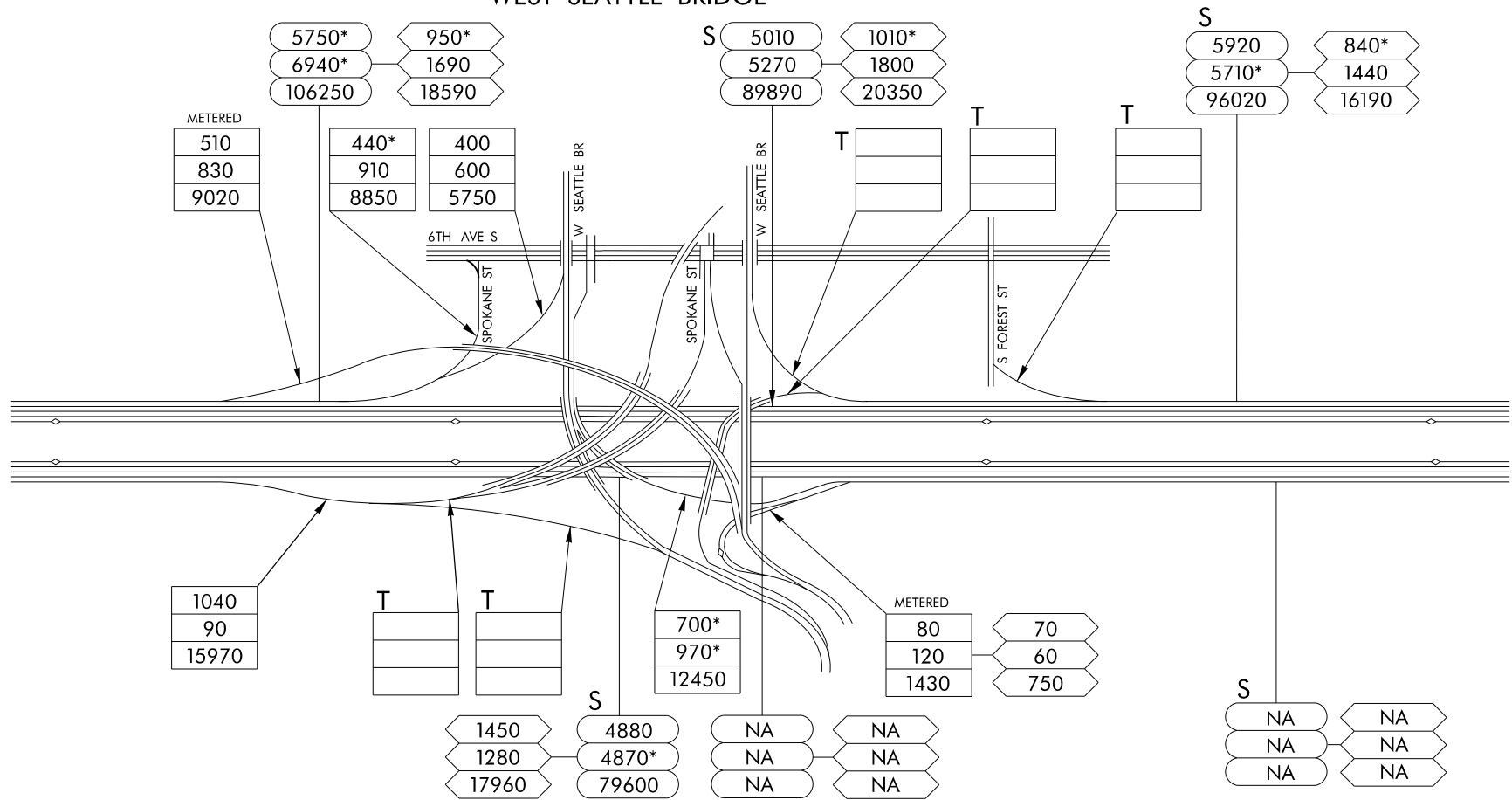

**EXIT 164A**  
COLLECTOR-DISTRIBUTOR

**EXIT 164B**  
4TH AVE S DEARBORN ST

**YESLER WAY** **JAMES ST**

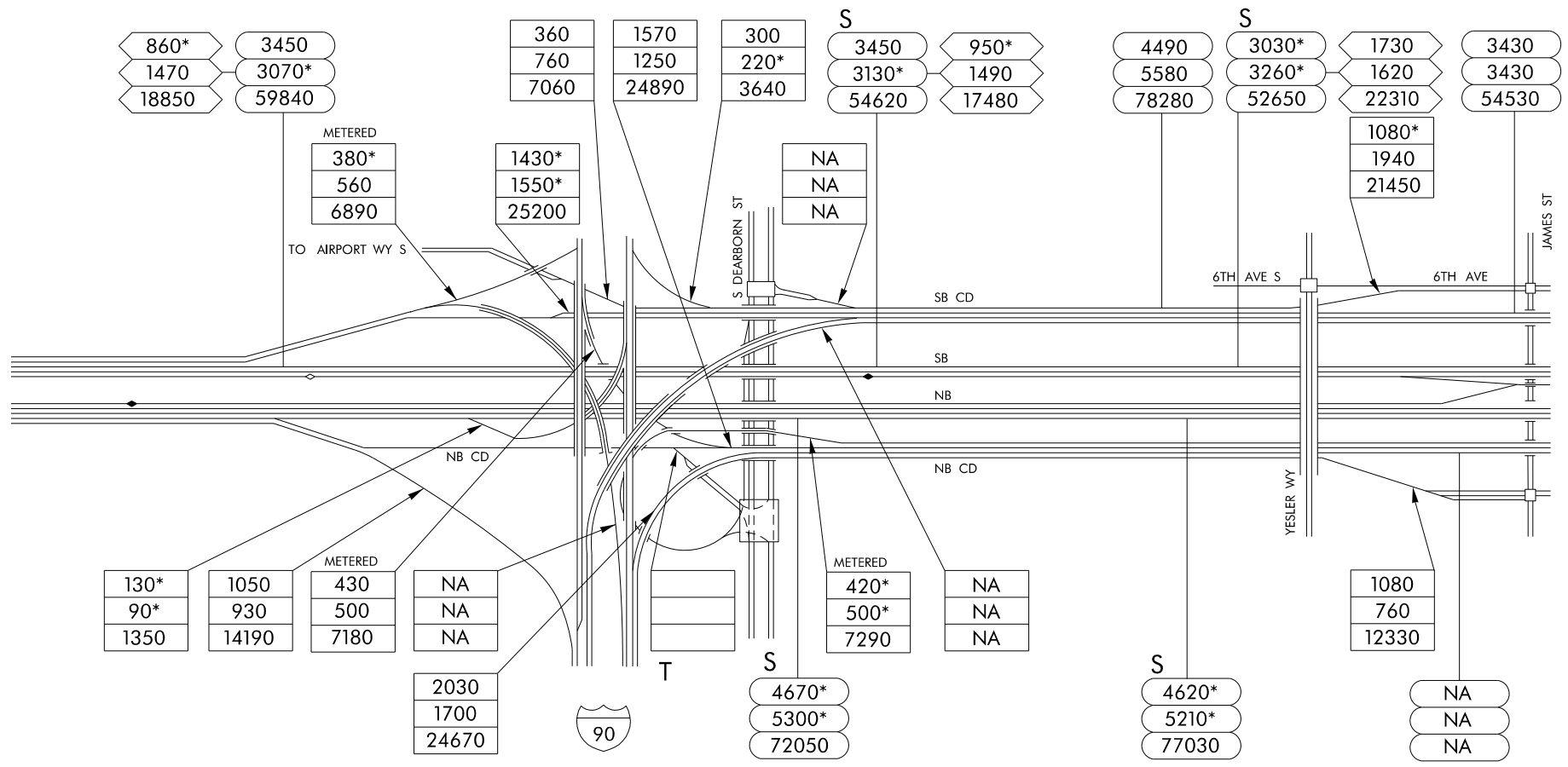

\* es16466\_MMN\_Stn includes only lanes 1 and 2 for metering purposes.  
\*\_MN\_Stn includes only lanes 3 and 4.

CHERRY ST

MADISON ST

UNIVERSITY ST

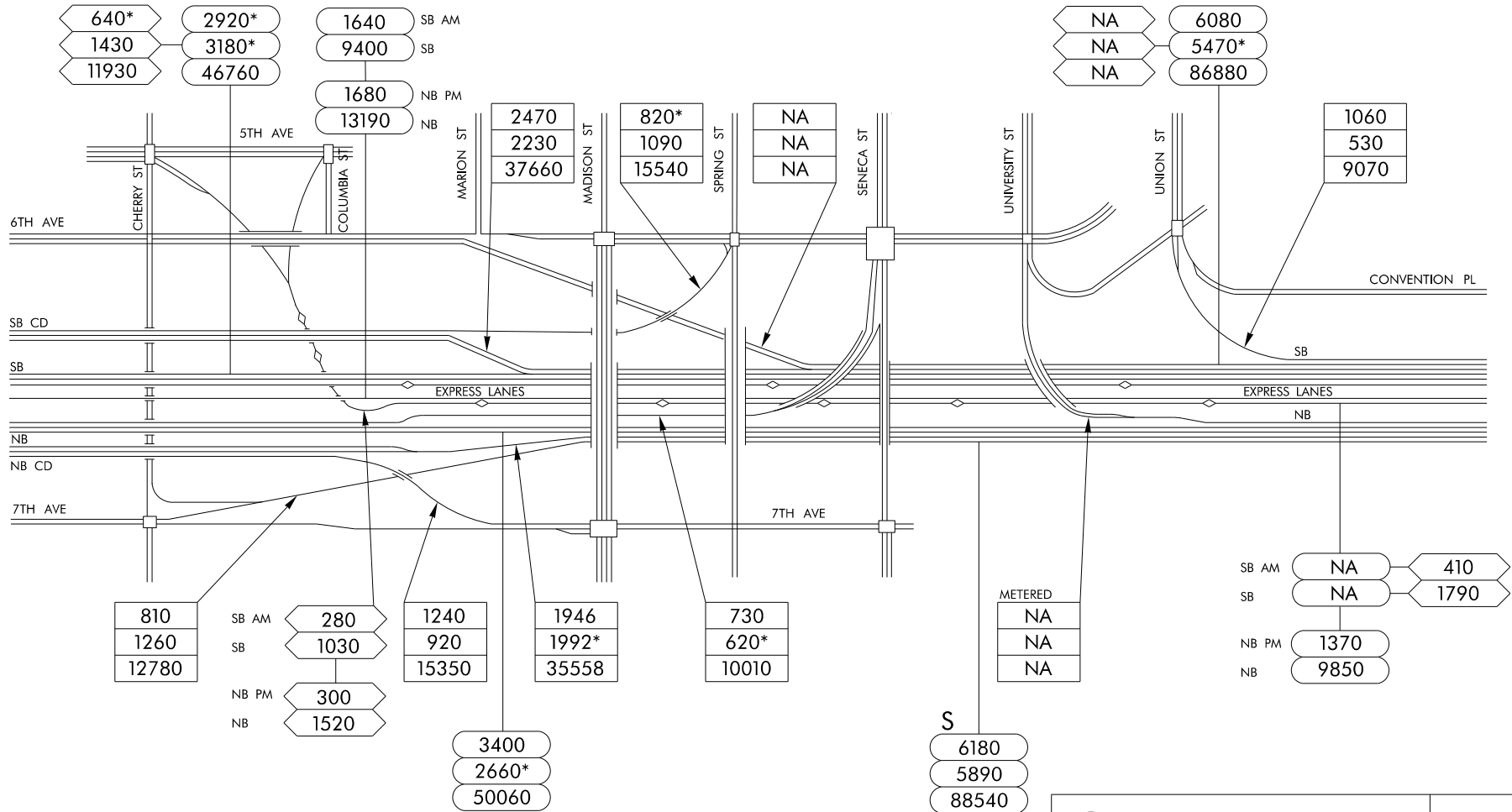

Washington State Department of Transportation



12 OF 31

EXIT 166  
STEWART ST

EXIT 167  
MERCER ST

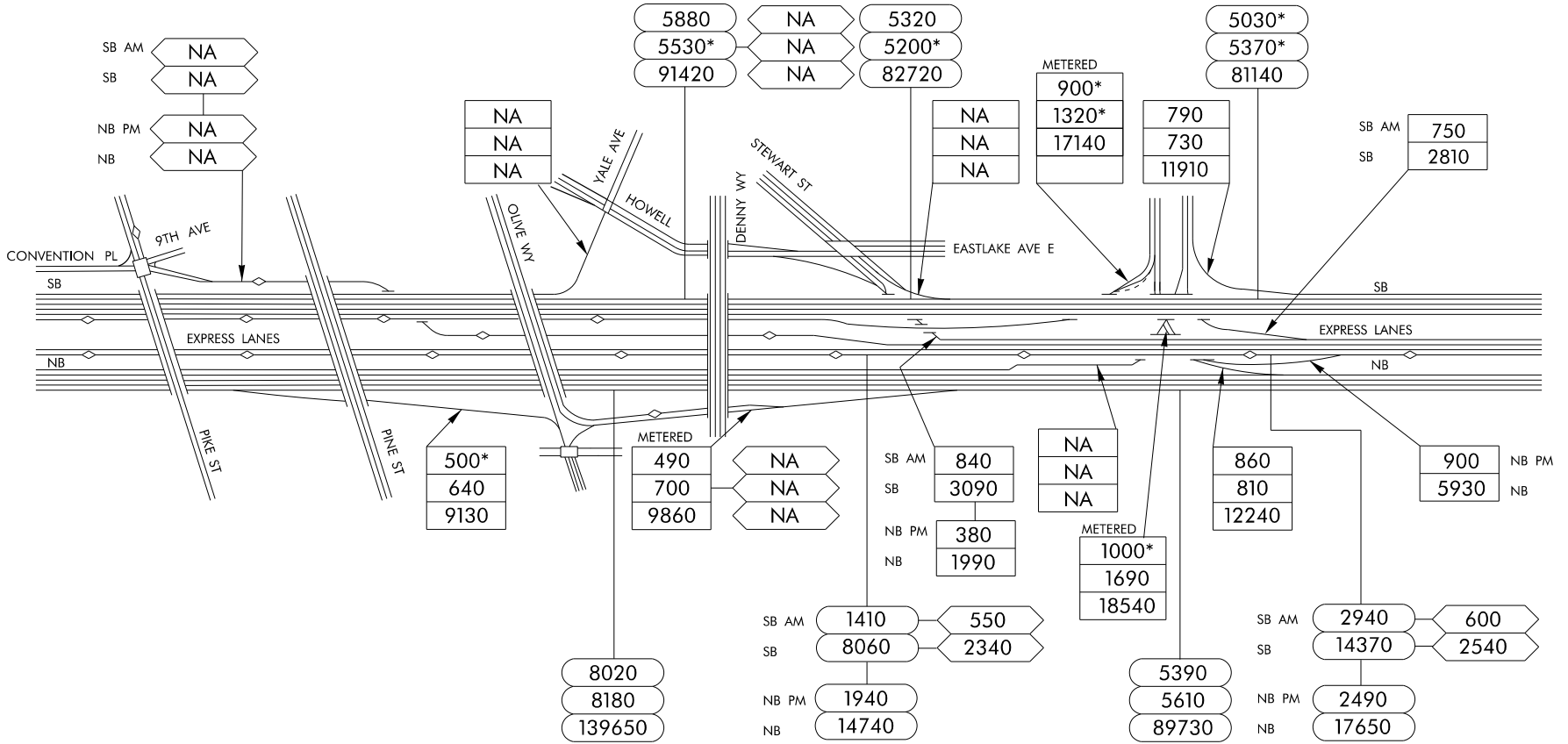



E GALER ST

EXIT 168A  
BOYLSTON AVE  
LAKEVIEW BLVD

EXIT 168B  
ROANOKE ST  
SR 520

EXIT 168A  
HARVARD AVE  
ROANOKE ST

SHIP CANAL  
BRIDGE

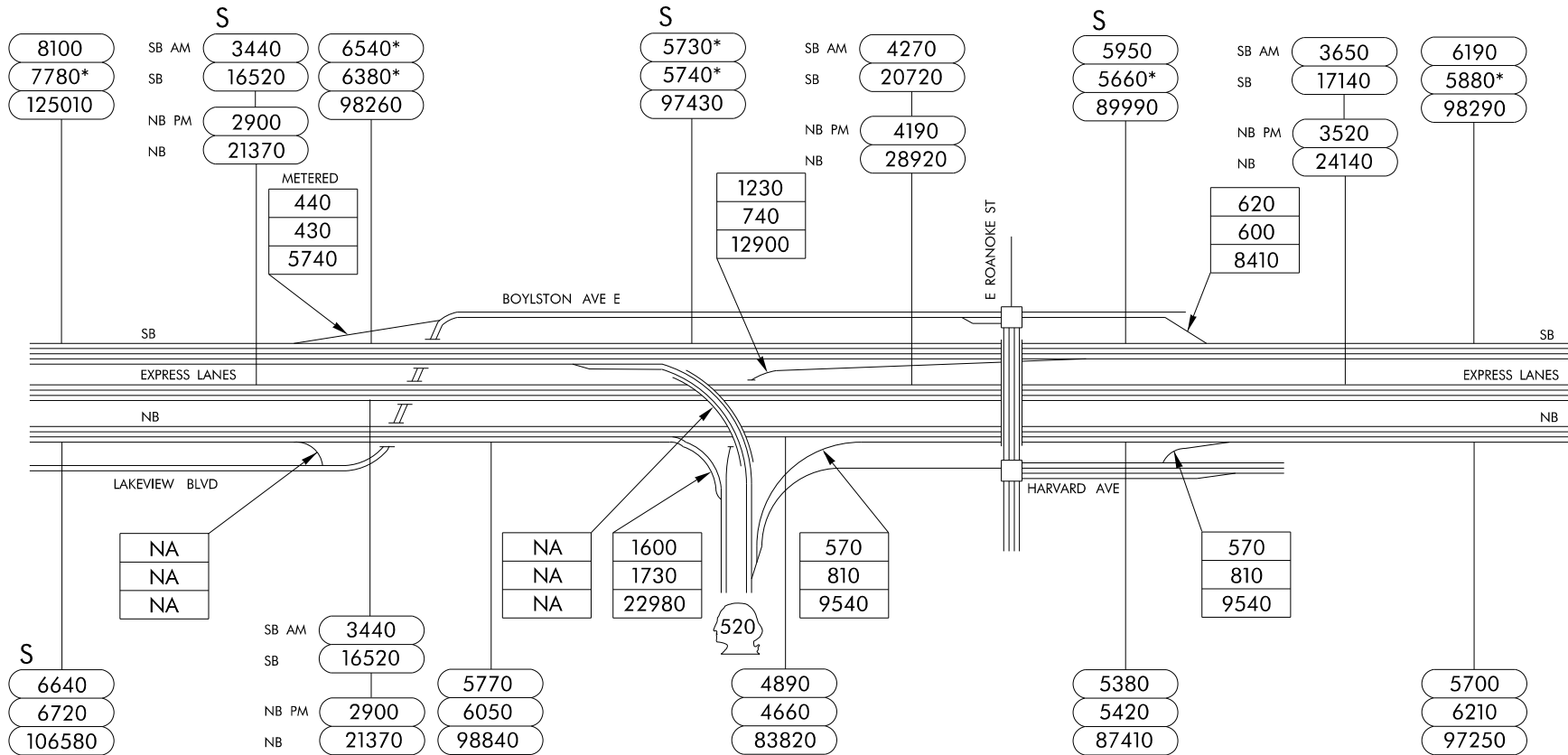



NE 42ND ST

EXIT 169  
NE 45TH ST  
NE 50TH ST

RAVENNA BLVD

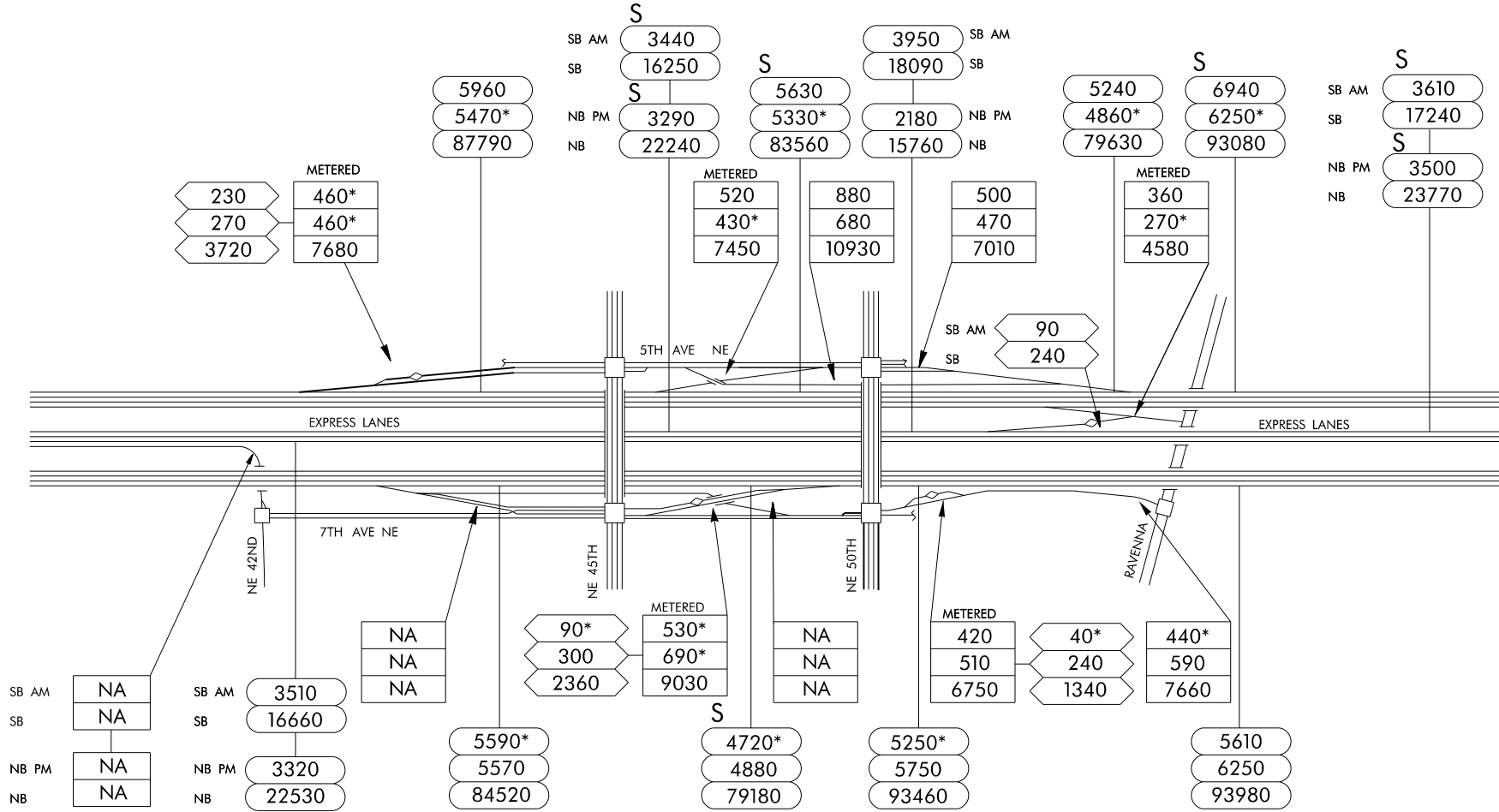

**EXIT 171**  
NE 70TH ST  
LAKE CITY WY

**EXIT 172**  
NE 80TH ST  
NE 85TH ST

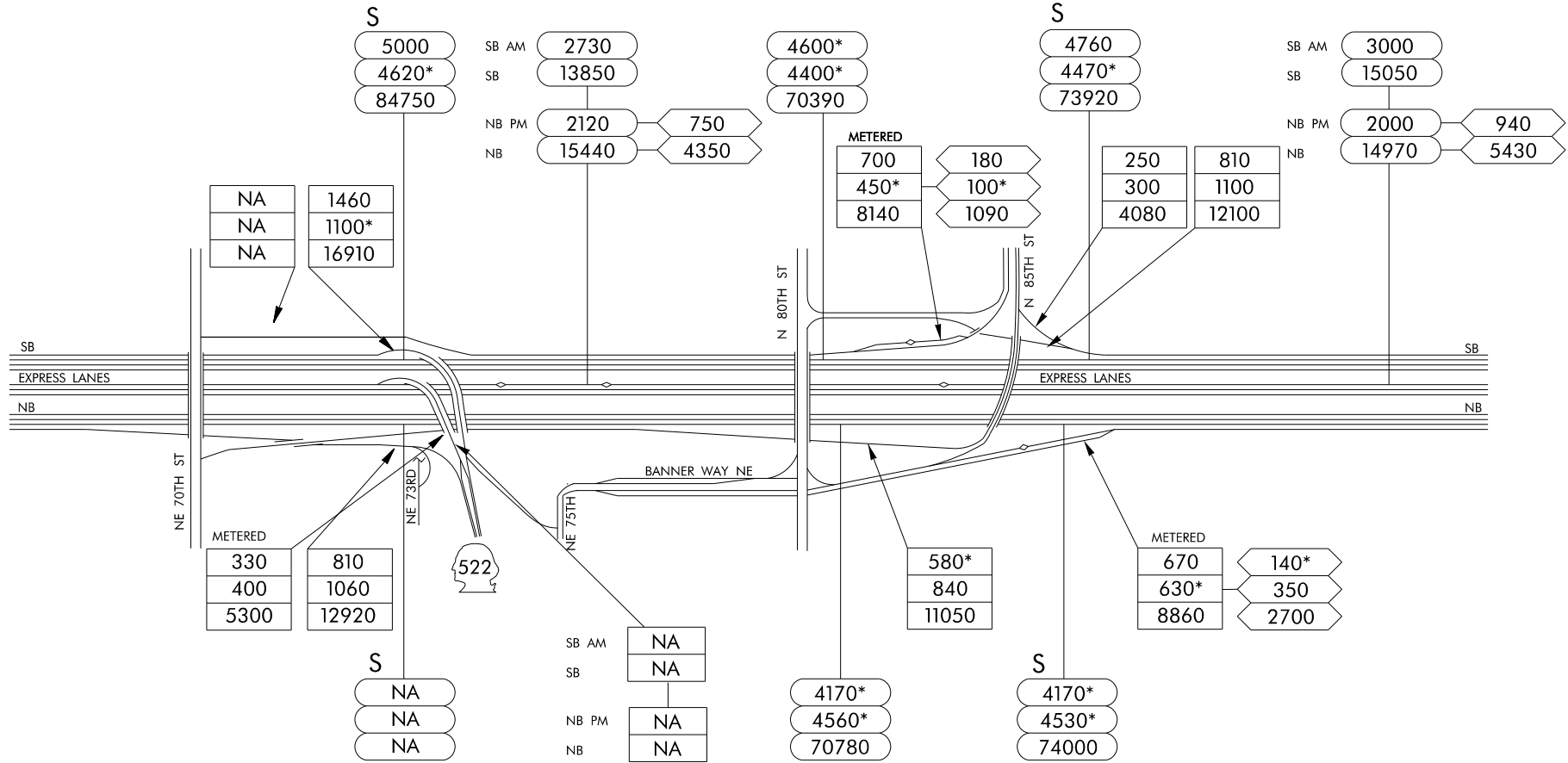

NE 92ND ST



EXIT 173

NE NORTHGATE WY

NE 120TH ST

EXIT 174

NE 130TH ST

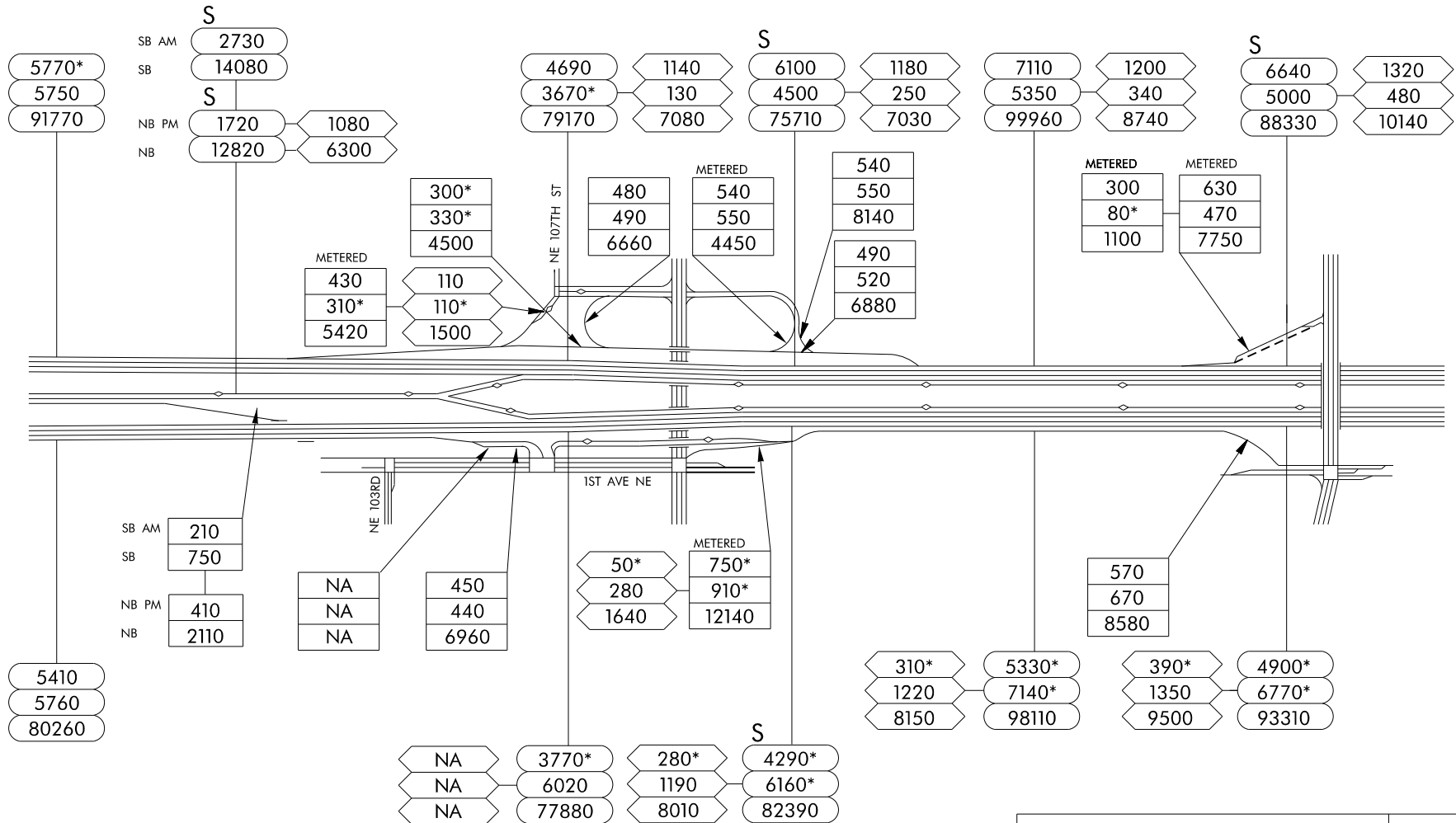

EXIT 175

EXIT 176

NE 137TH ST

SR 523  
NE 145TH ST

NE 155TH ST

METRO  
NORTH BASE

NE 175TH ST

8120	1310
5870	580
98720	10530

S

5100	1370
3960	680
79560	13880

5470	1440
4650	770
80730	13610

S

5710	1530
4960	820
81520	13830

1420	5000	1470	5290
800	4280	810	4740
13770	73710	13670	78420

METERED

510
450
7200

1260
620
12180

523

460*
910
11450

5
4*
60

METRO ONLY

40*
30*
370

METRO ONLY

40*
40*
390

300
90
2090

390*
520
6480

5TH AVE NE

650
950
11590

S

5
4*
50

METERED

480*
550*
7080

60*
230
1700

METRO ONLY

30
30
400

METRO ONLY

NA
NA
NA

EXIT TO  
NE 175TH  
ONLY

480*
760
9320

METERED

460
630*
7170

30*
250
1300

4750*	NA
6310*	NA
91070	NA

4110*	370*
5440*	1320
74200	9460

4680*	370*
6050	1350
85040	9860

S

4870*	400*
6240*	1490
90370	10310

NA	NA
NA	NA
NA	NA



Washington State  
Department of Transportation



18  
OF  
31

NE 195TH ST

EXIT 177  
SR 104  
NE 205TH ST



EXIT 178  
236TH ST SW

228TH ST SW 220TH ST SW

EXIT 179

213TH ST SW

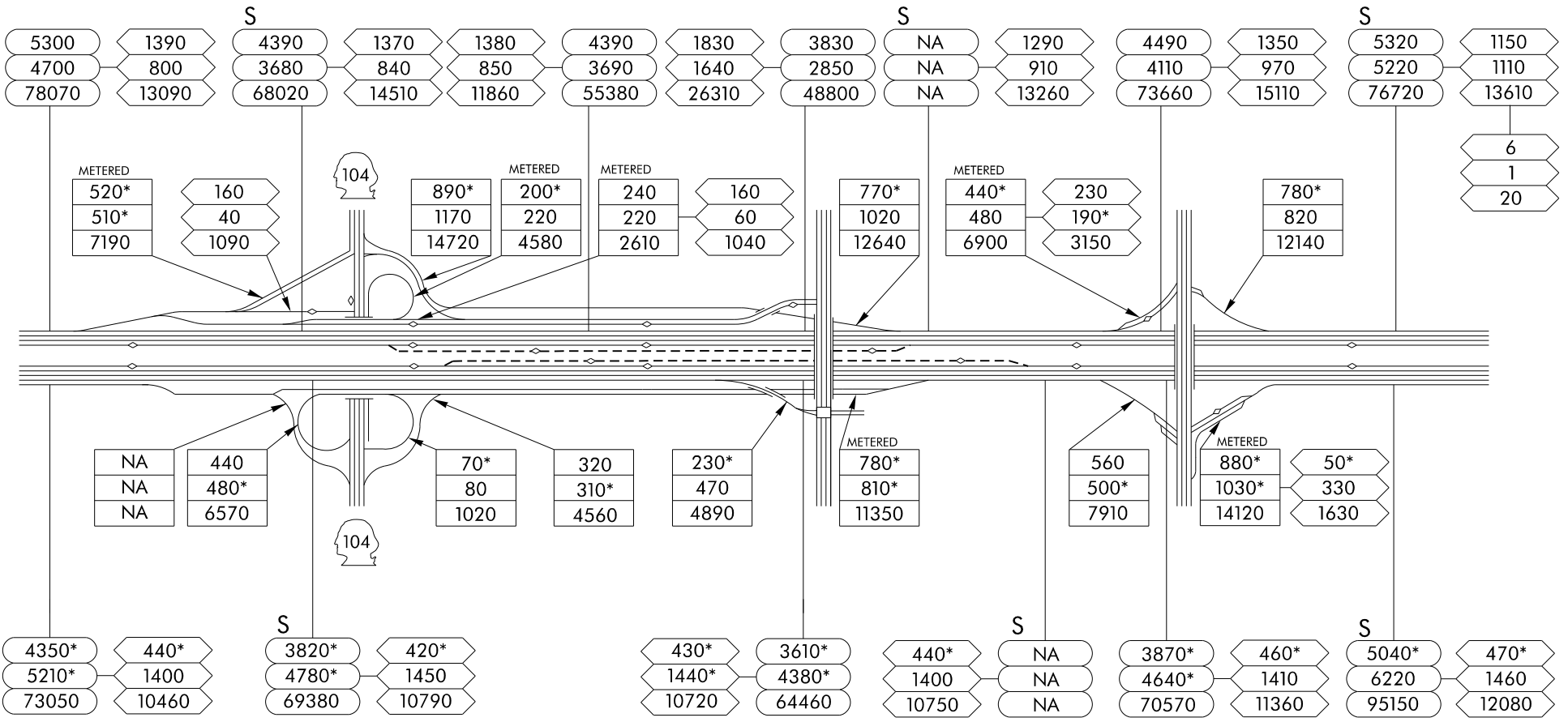

208TH ST SW

LYNNWOOD  
PARK & RIDE  
DIRECT ACCESS

EXIT 181A

44TH AVE W

EXIT 181/181B

ALDERWOOD MALL PKWY  
196TH ST SW

28TH AVE W

EXIT 182

I-405  
SR 525

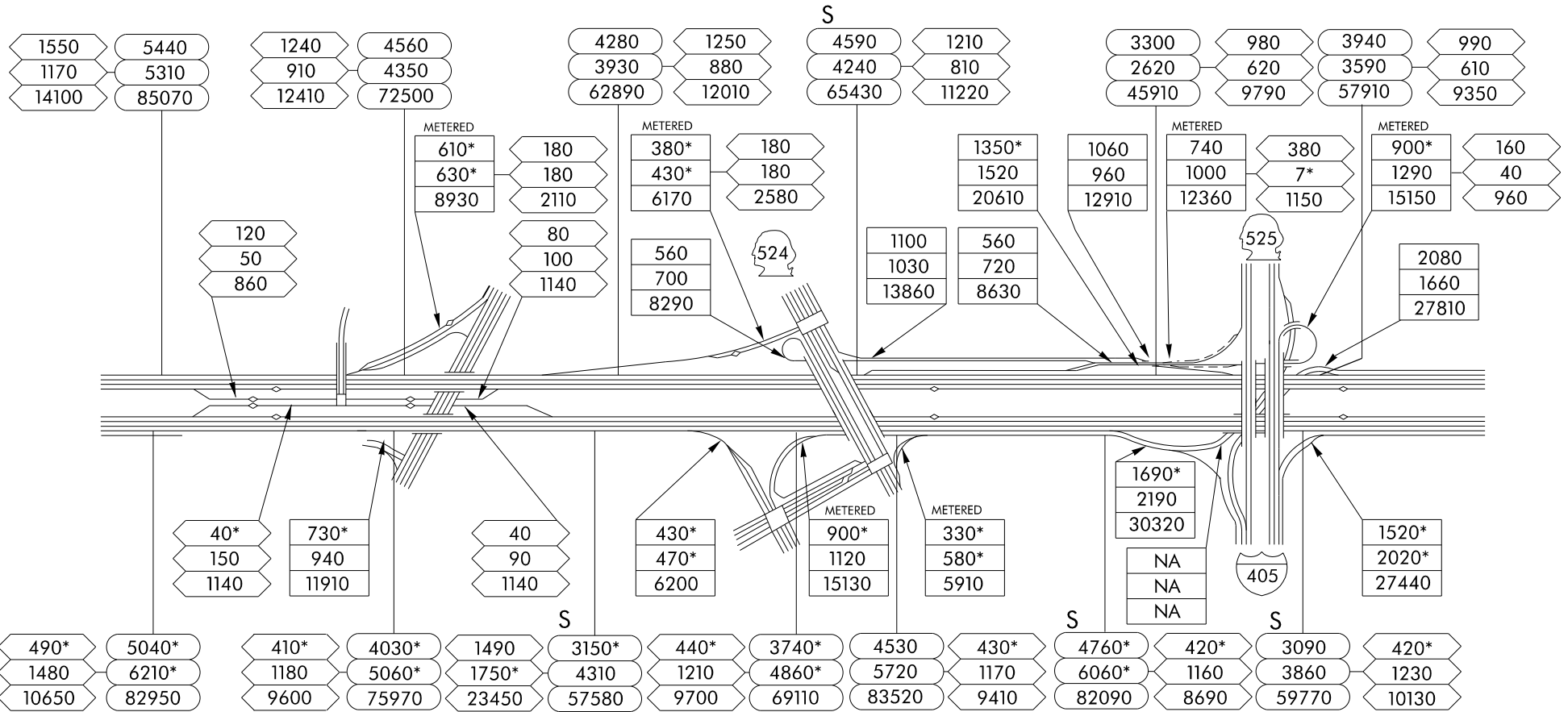

EXIT 183



175TH ST SW

164TH ST SW

ASHWAY  
PARK & RIDE  
DIRECT ACCESS

156TH ST SW

148TH ST SW

140TH ST SW

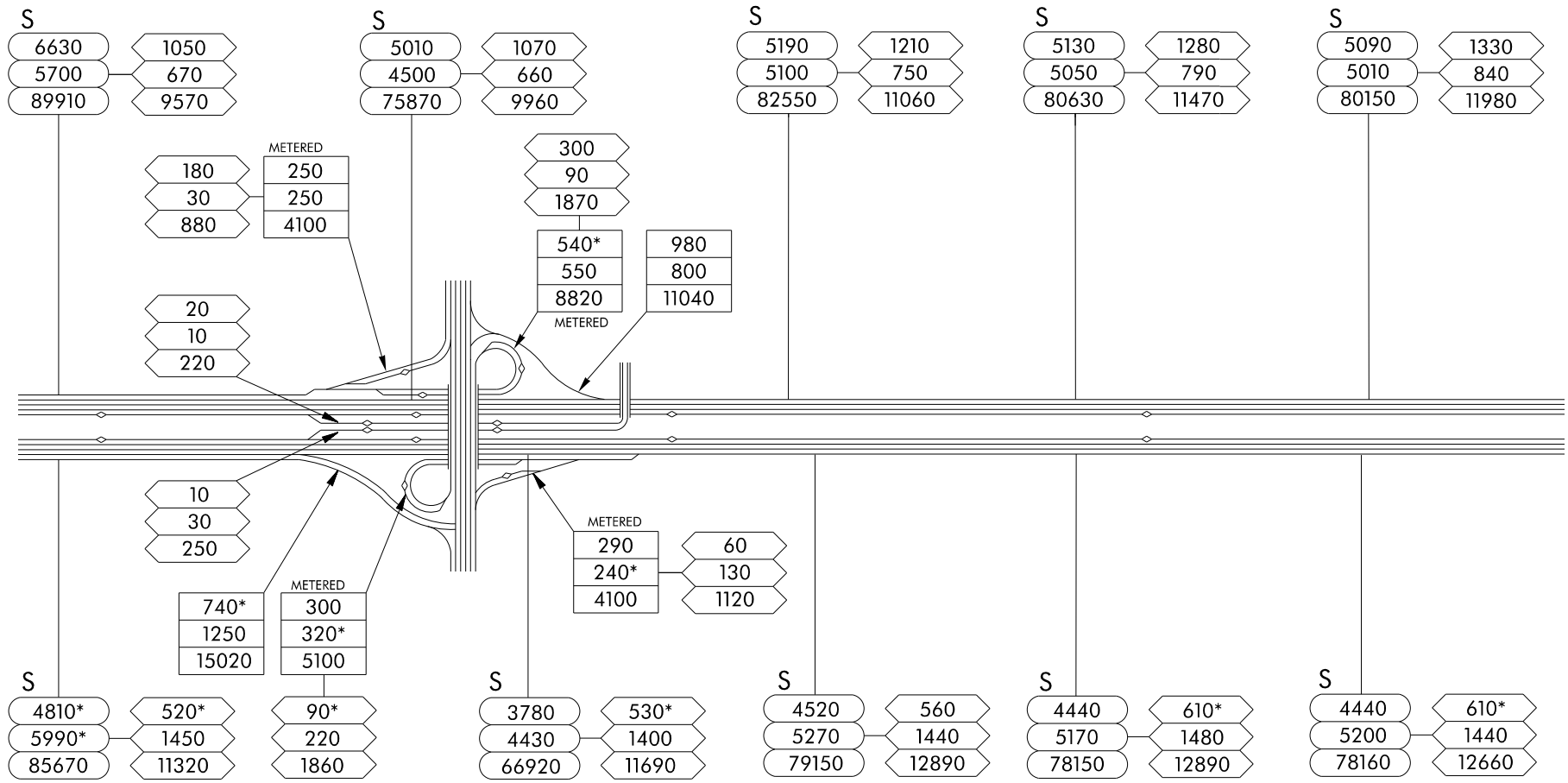

EXIT 186

SR 96



134TH ST SW

128TH ST SW

122ND ST SE

118TH ST SE

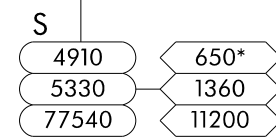
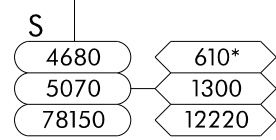
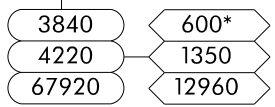
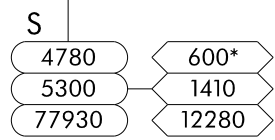
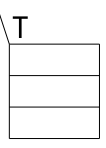
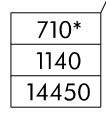
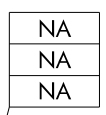
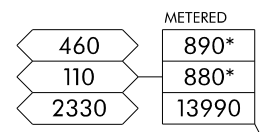
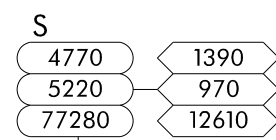
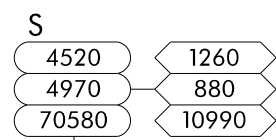
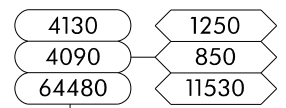
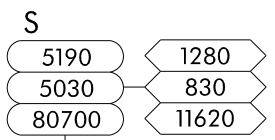



112TH ST SE  
PARK & RIDE

106TH ST SE

EVERETT MALL  
WAY

EXIT 189

SR 526  
SR 99, SR 527



77TH ST SE

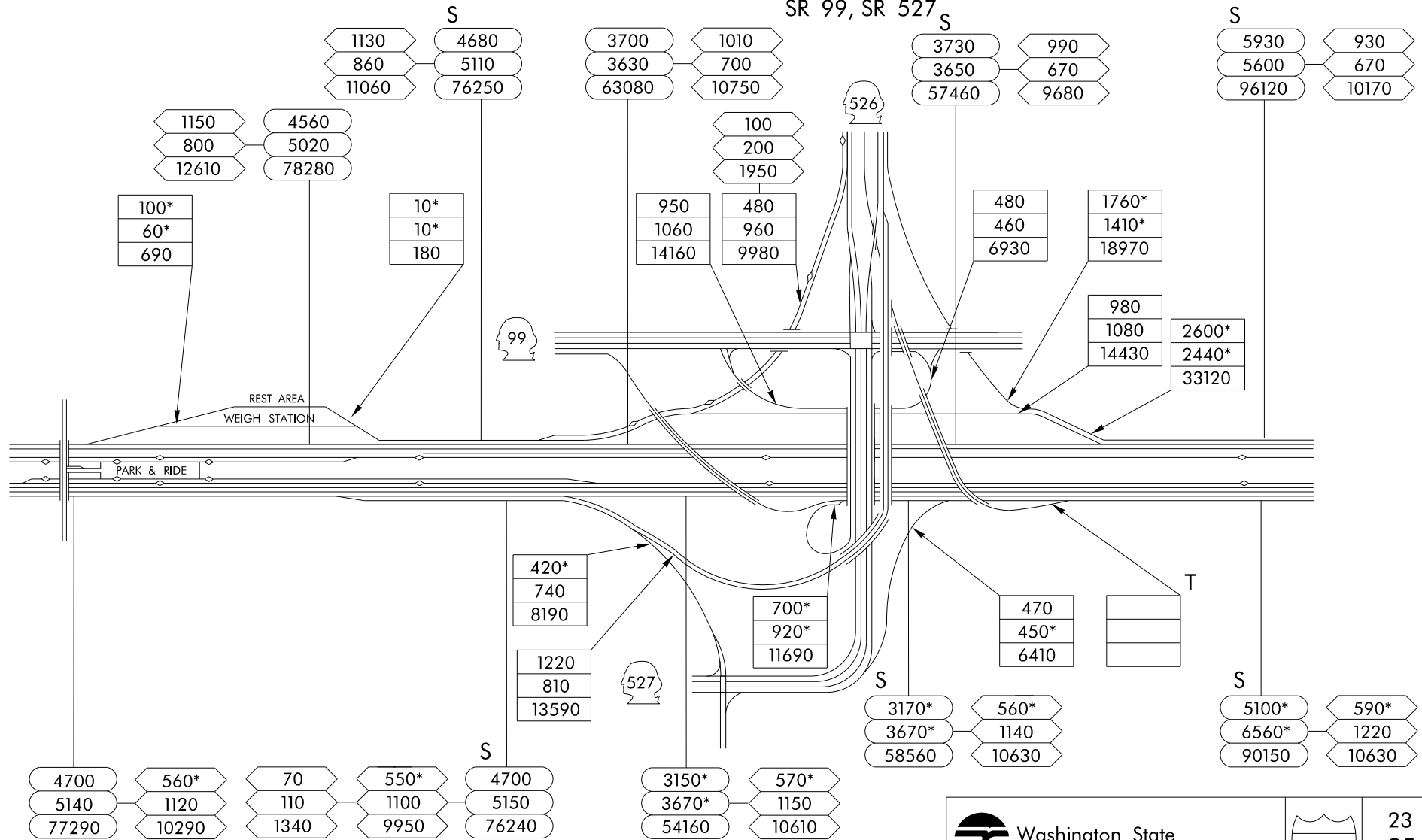

Washington State  
Department of Transportation



23  
OF  
31

73RD ST SE

S

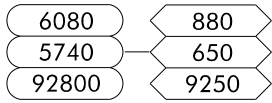

LEXINGTON AVE SE

S

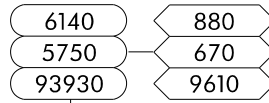

LINCOLN ST



S

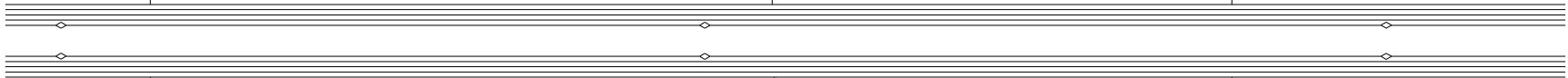
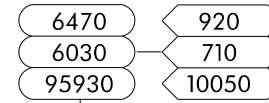

S

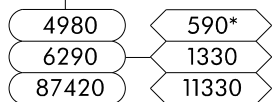

S

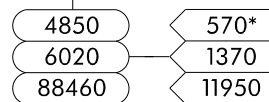

S

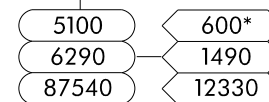

Washington State  
Department of Transportation



24  
OF  
31



49TH ST SE

EXIT 192  
41ST ST SE

36TH ST SE

EXIT 193  
PACIFIC AVE

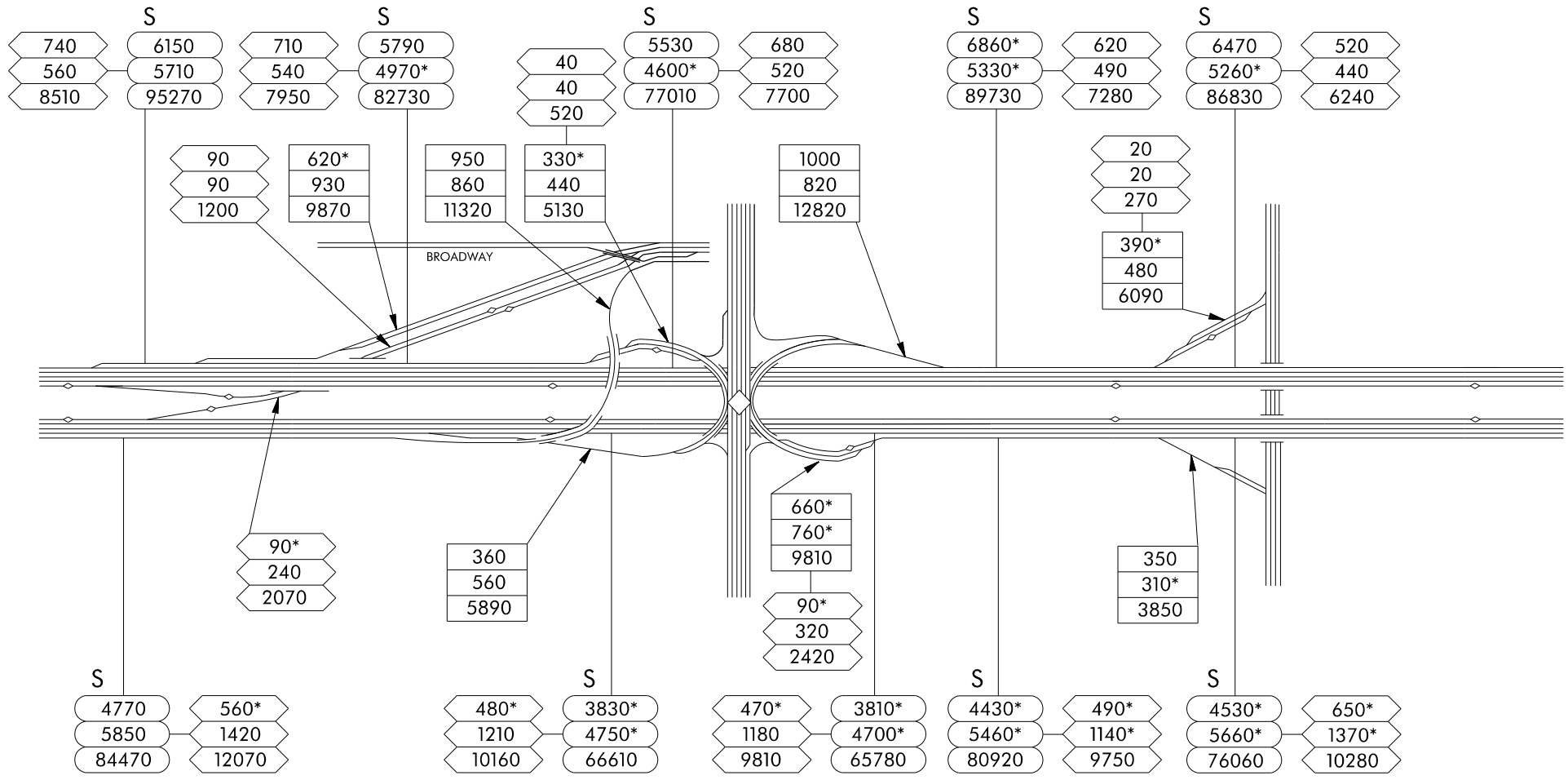



EXIT 194  
US 2  
EVERETT AVE

EXIT 195  
MARINE VIEW DR

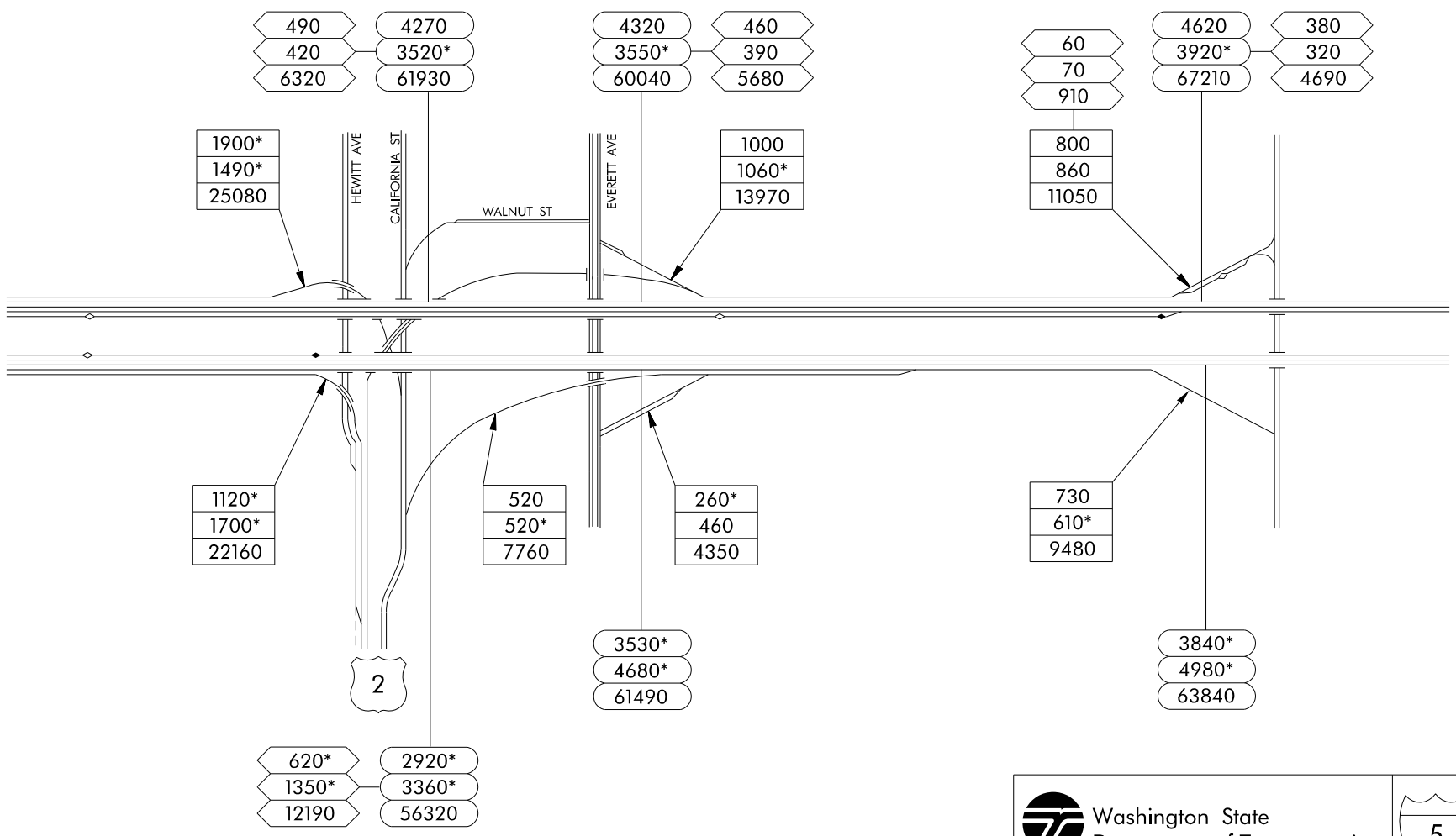

EXIT 198  
SR 529

EXIT 199  
SR 528  
4TH ST

70TH ST NE

79TH ST NE

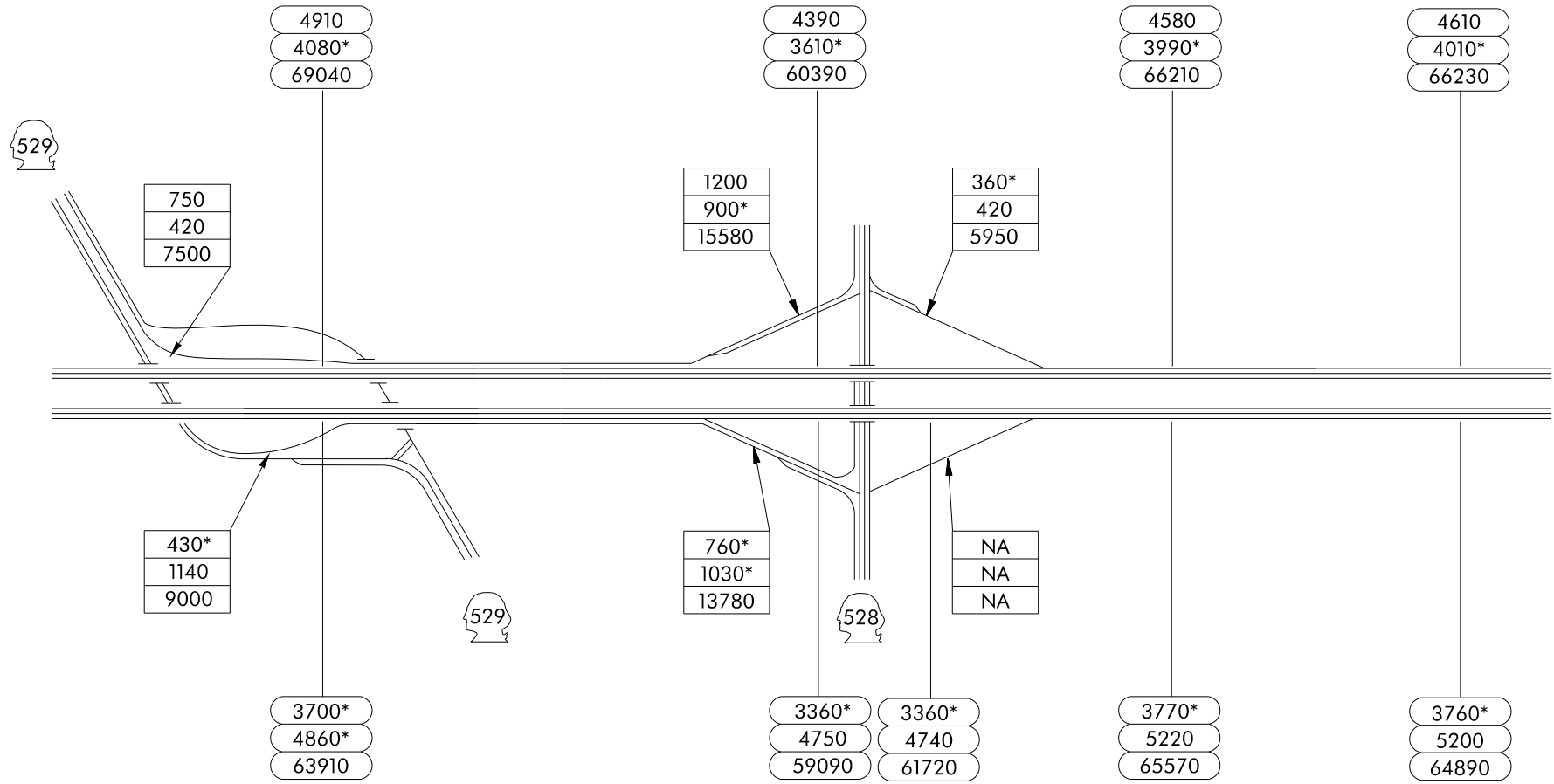

Washington State  
Department of Transportation



27  
OF  
31

EXIT 200

88TH ST NE  
QUIL CEDA WAY

98TH ST NE

105TH ST NE

EXIT 202

116TH ST NE

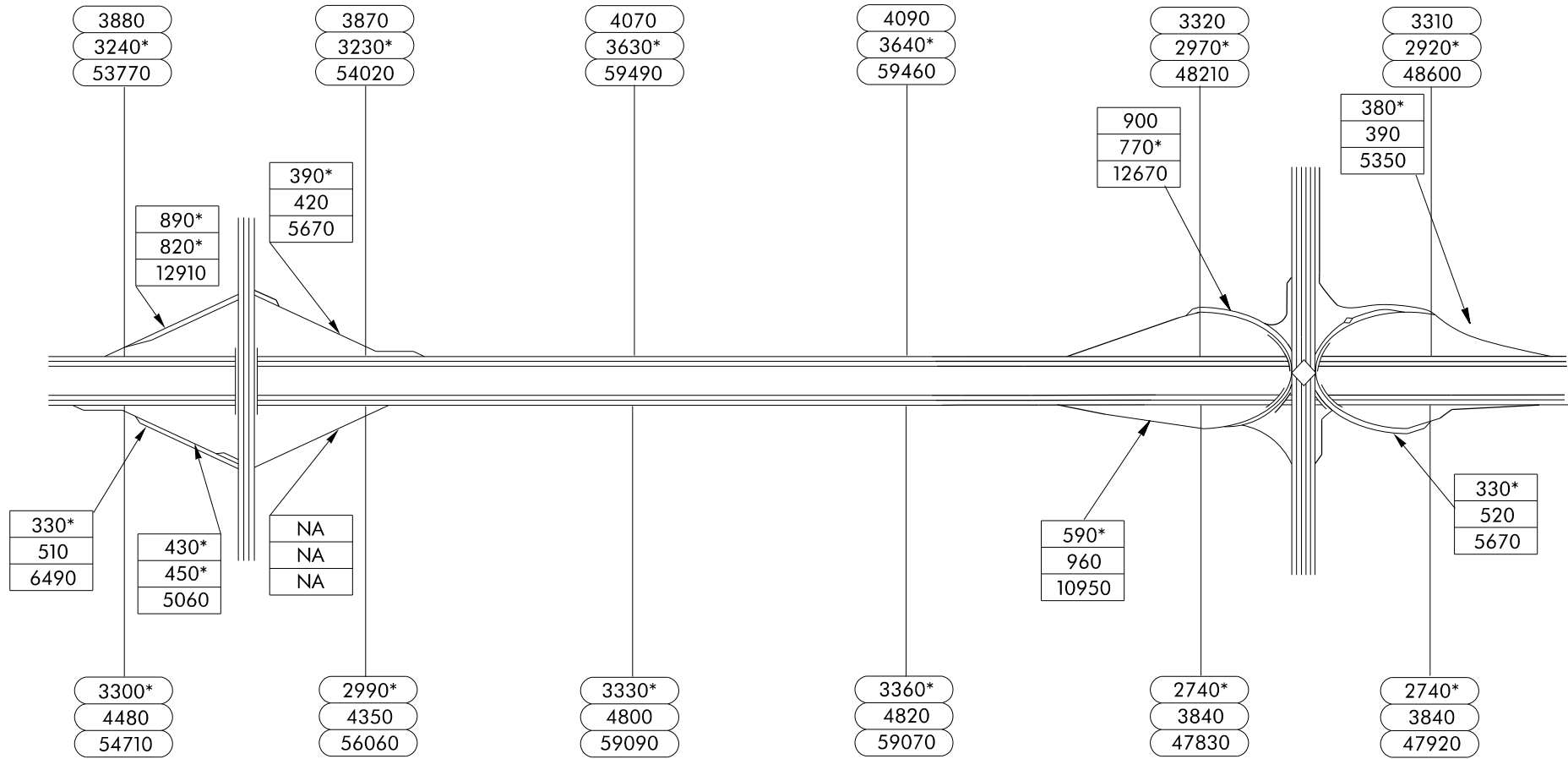

Washington State  
Department of Transportation



28  
OF  
31



127TH ST NE

136TH ST NE

144TH ST NE

152ND ST NE

160TH ST NE

3540  
3300\*  
53500

3540  
3300\*  
53330

3460  
3230\*  
52850

3540  
3300\*  
52900

3640  
3390\*  
54090

3080\*  
4380  
53500

3050\*  
4360  
53840

3110\*  
4440  
54440

3120\*  
4420  
54550

3110\*  
4460  
49120



Washington State  
Department of Transportation



29  
OF  
31

EXIT 206

SR 531  
172ND ST NE  
(SMOKEY PT)

180TH ST NE

189TH PL NE

200TH ST NE



2580  
2300\*  
38110

NA  
NA  
NA

7\*  
9  
110

460\*  
520\*  
7310



90  
70  
1070

600  
530  
7980

540\*  
560  
7980

2940  
2780\*  
45460

80\*  
70\*  
900

2970  
2760  
44570

REST AREA

2990  
2820\*  
45320

970\*  
1310\*  
16480



530\*  
770  
8420

110\*  
110\*  
1360

REST AREA

2070\*  
3070  
36910

2610\*  
3850  
45300

2480\*  
3750  
44540

2590\*  
3840  
45210



Washington State  
Department of Transportation



30  
OF  
31



204TH ST NE

EXIT 208  
SR 530  
PIONEER HWY

STILLAGUAMISH  
RIVER

236TH ST NE



3000  
2830\*  
45800

2490  
2410  
38420

2460  
2400  
38310

2860  
2820  
43470

2540  
2490  
38840

530  
520  
470\*  
7560  
370  
380  
5050

290  
290  
4710

450\*  
620\*  
7480  
340  
500  
5200

270\*  
450  
4970

2600\*  
3830  
45190

2140\*  
3230  
37620

2130\*  
3210  
37830

2450\*  
3780  
43040

2140\*  
3250  
37160



Washington State  
Department of Transportation



31  
OF  
31



EXIT 2B\2C

I-5

S NORMAN ST

S

4400  
4170  
51150

1860  
1890  
26710

NA  
NA  
NA

2030  
1700  
24670

300  
220\*  
3640

METERED  
430  
500  
7180

S DEARBORN ST

850  
780  
9720

S ATLANTIC ST

METERED  
380\*  
560  
6890

1200  
1580  
17130

NA  
NA  
NA

130\*  
90\*  
1350

1050  
930  
14190

S  
4170  
4830  
60740

2030  
2480  
27280

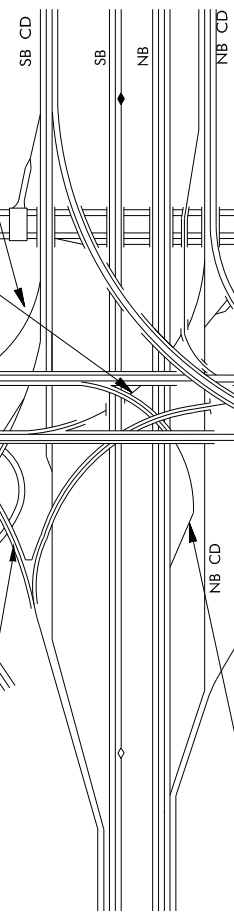

EXIT 3A\ 3B  
RAINIER AVE S

23RD AVE S

35TH AVE S

WEST HIGHRISE  
S

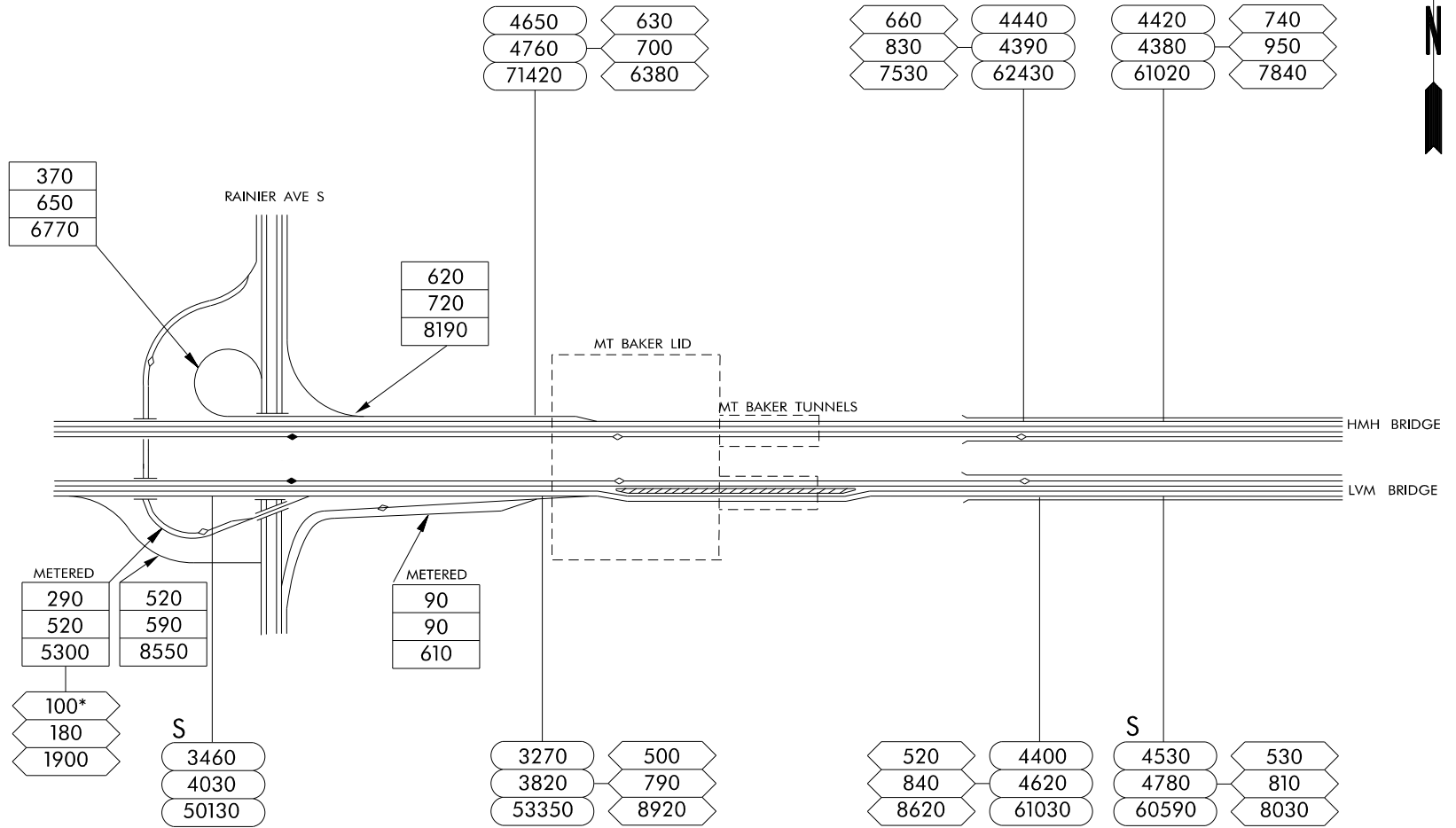

Washington State  
Department of Transportation

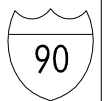

2  
OF  
11



MIDSPAN

EAST HIGHRISE

EXIT 6A  
W MERCER WY

76TH AVE SE

77TH AVE SE

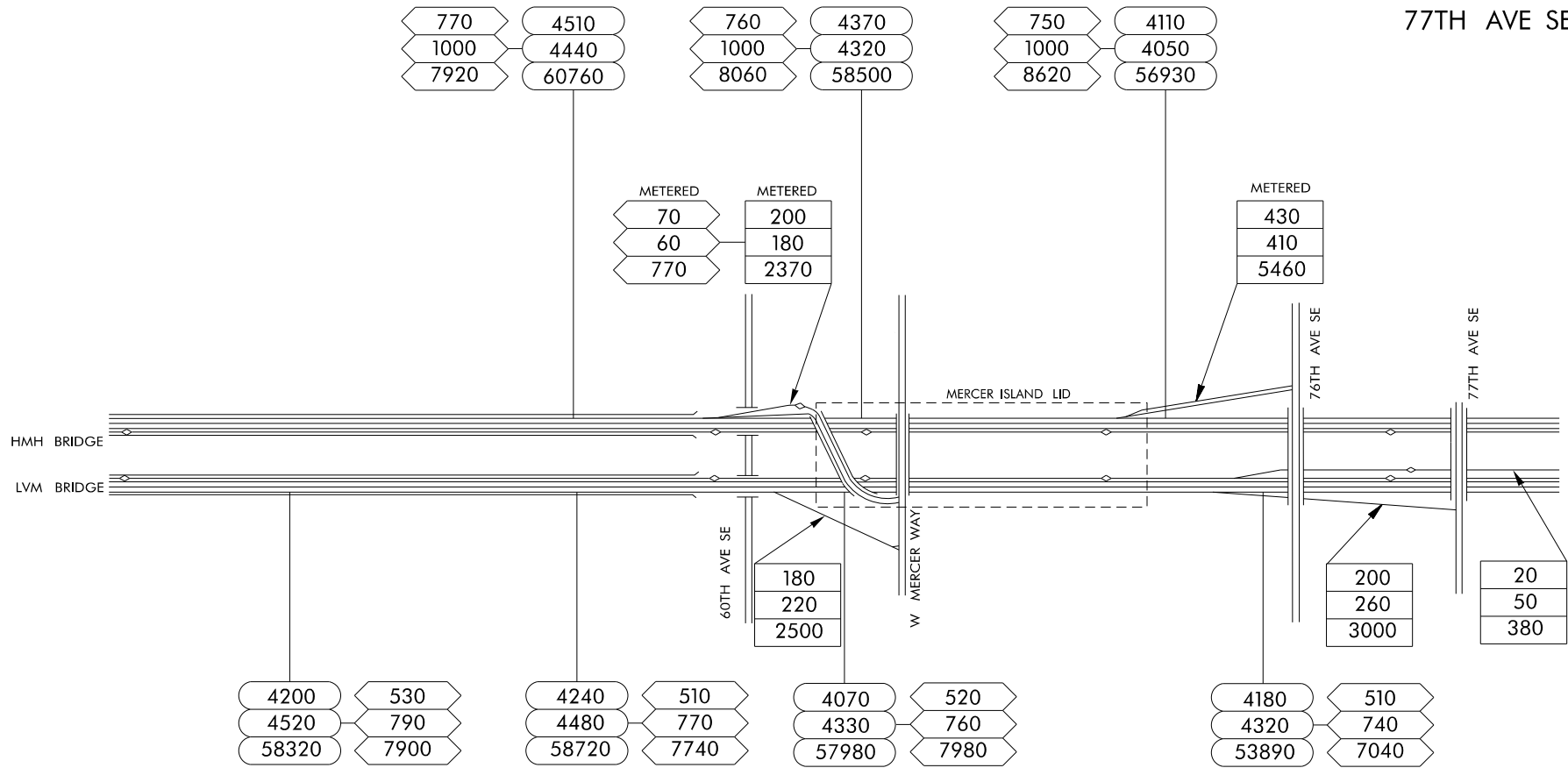



EXIT 7\7B  
ISL CREST WY

SHOREWOOD  
DRIVE

EXIT 8  
E MERCER WY

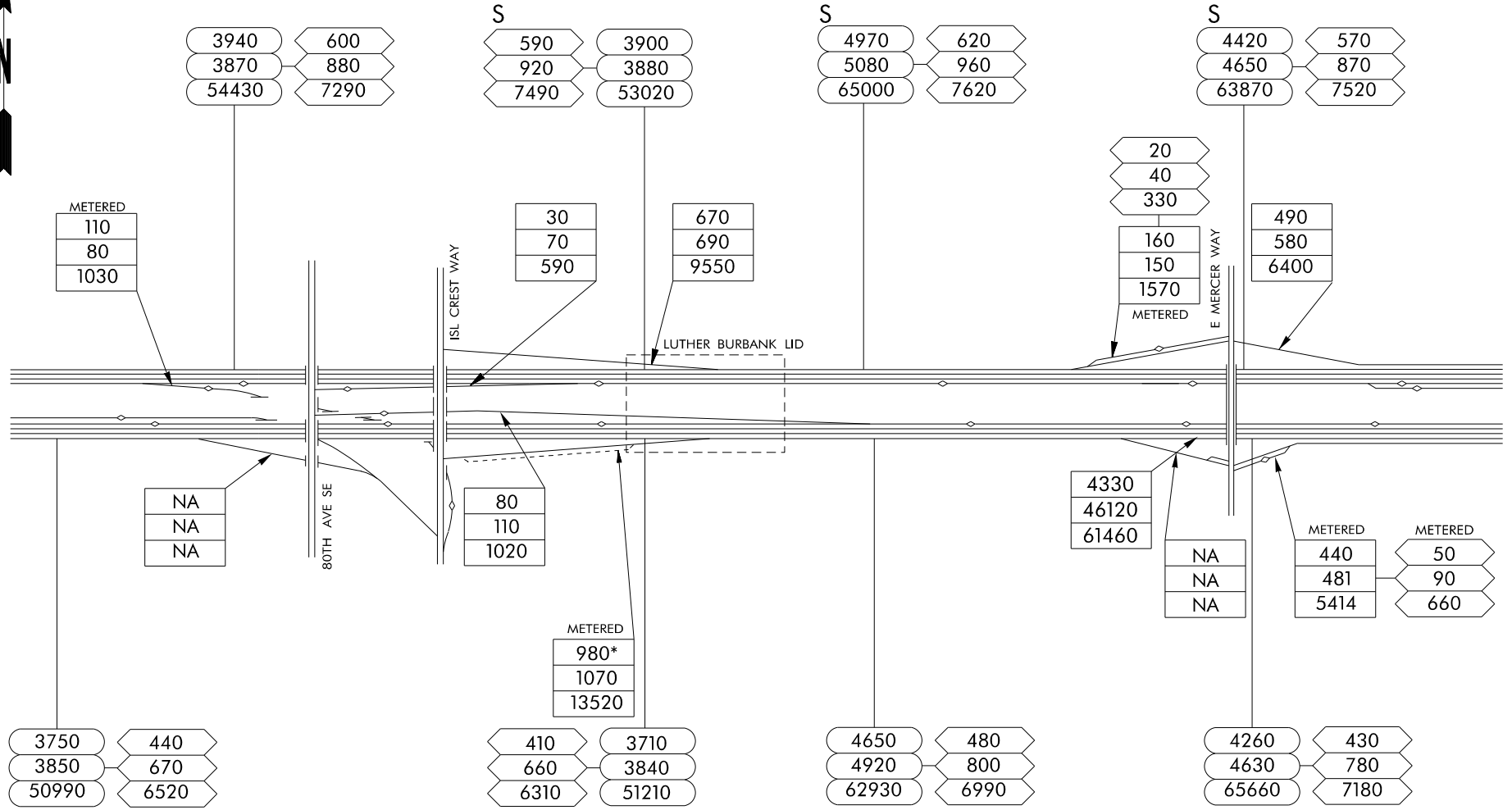

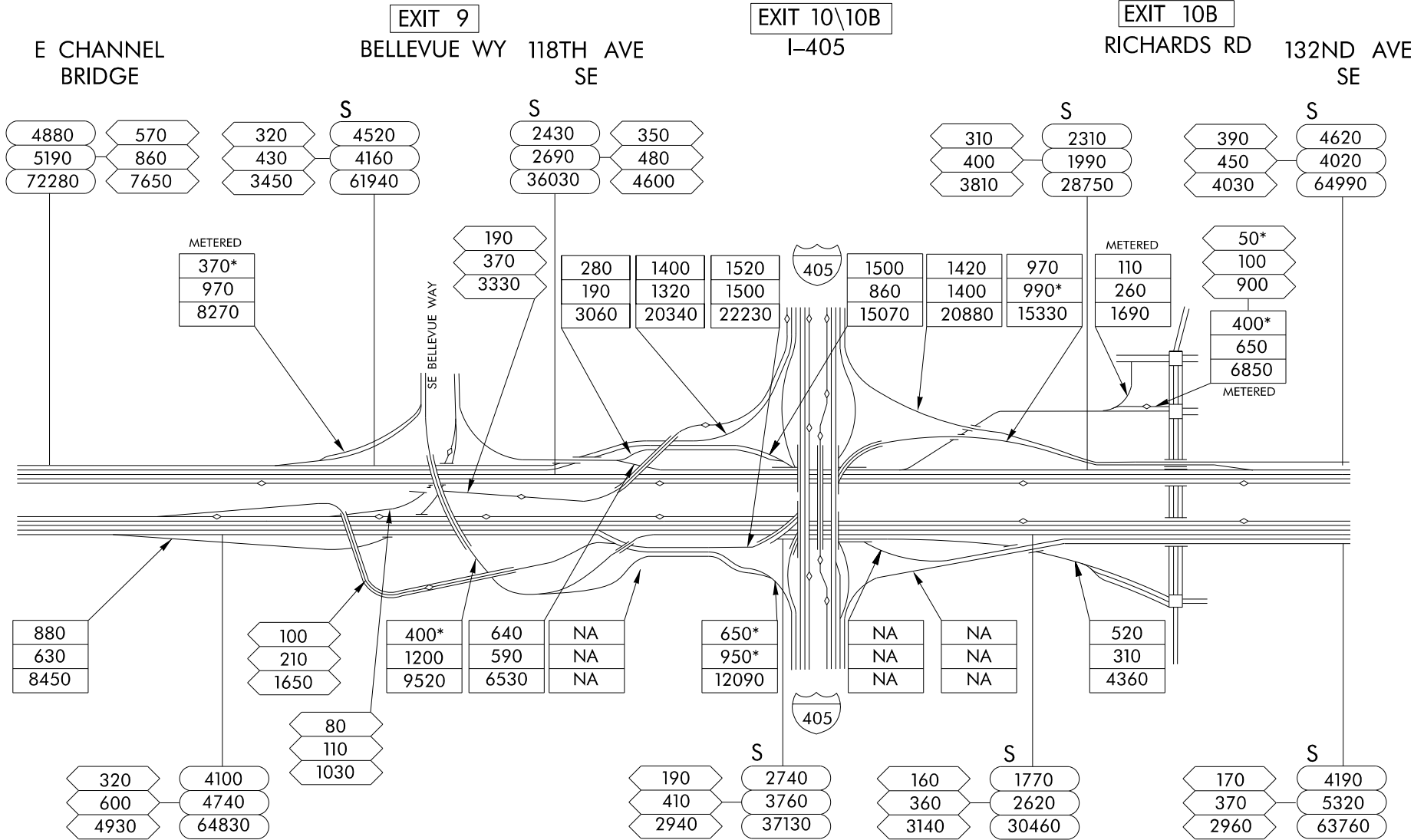

142ND PL SE  
PARK & RIDE  
DIRECT ACCESS

EXIT 11A\B  
148TH AVE SE  
150TH AVE SE

EXIT 11  
161ST AVE SE  
S

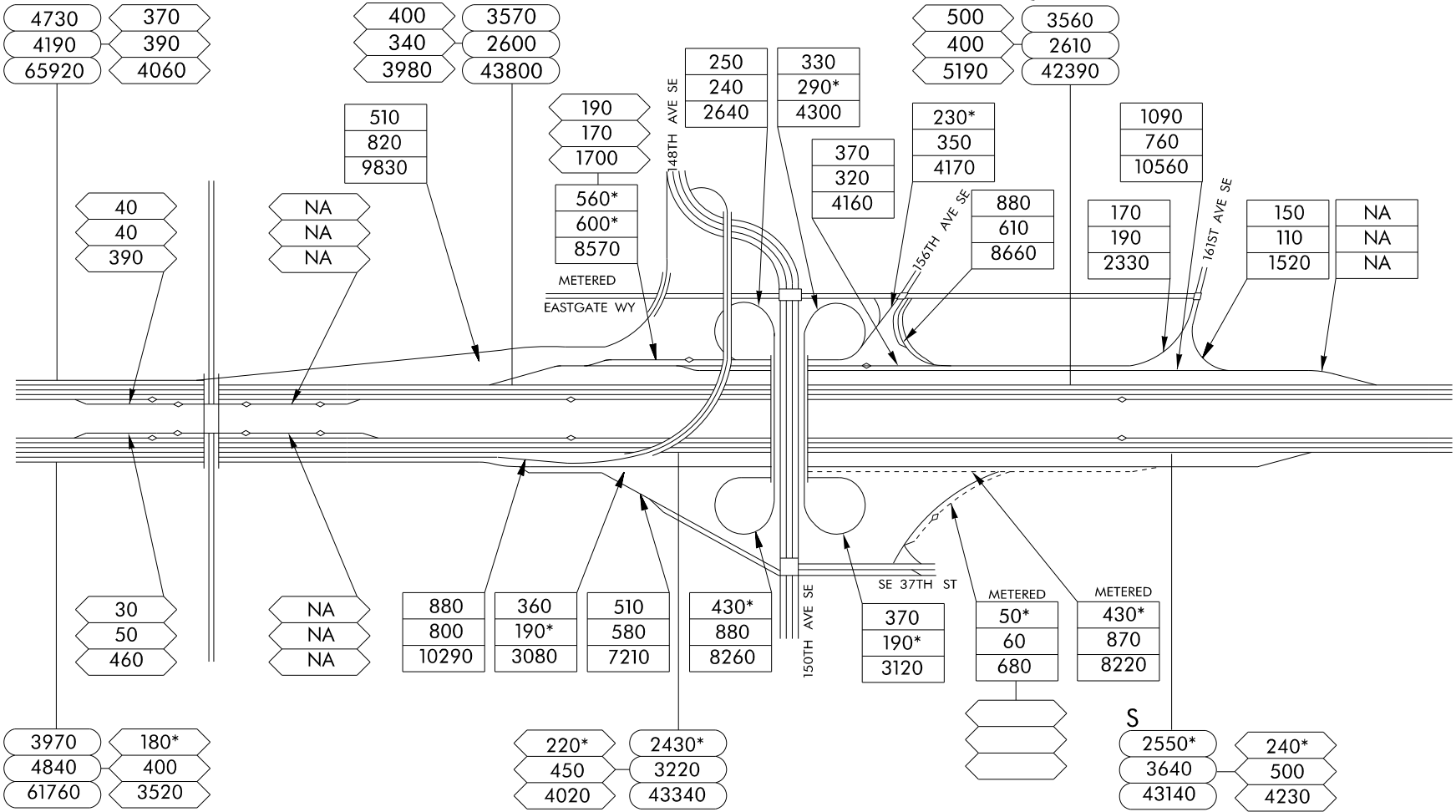



164TH AVE SE

169TH AVE SE

EXIT 13  
W LAKE SAMMAMISH PKWY  
NEWPORT WAY

193RD AVE SE

4650	590
3650	430
53500	5340

NA	2420
NA	2690
NA	36020

580	3580	3780	660
470	2920	3080	510
6470	46340	46110	6760

4020	620
3490	530
52670	6920

720
420
6490

METERED

390
540
5480

380
670
6480

400
540
5670

4190*	240*
5720	530
78360	4490

230*	3230*
510	4740
4410	56070

240*	2830*	3010*	320*
460	4050	4370	530
4190	47870	51300	5210

3120*	330*
4690	640
60630	5670



Washington State  
Department of Transportation



7  
OF  
11





200TH AVE SE

EXIT 15  
SR 900  
RENTON-  
ISSAQUAH RD SE

12TH AVE NW

EXIT 17  
FRONT ST  
& E LAKE SAMM

EXIT 18  
E SUNSET WY  
& HIGHLANDS DR NE

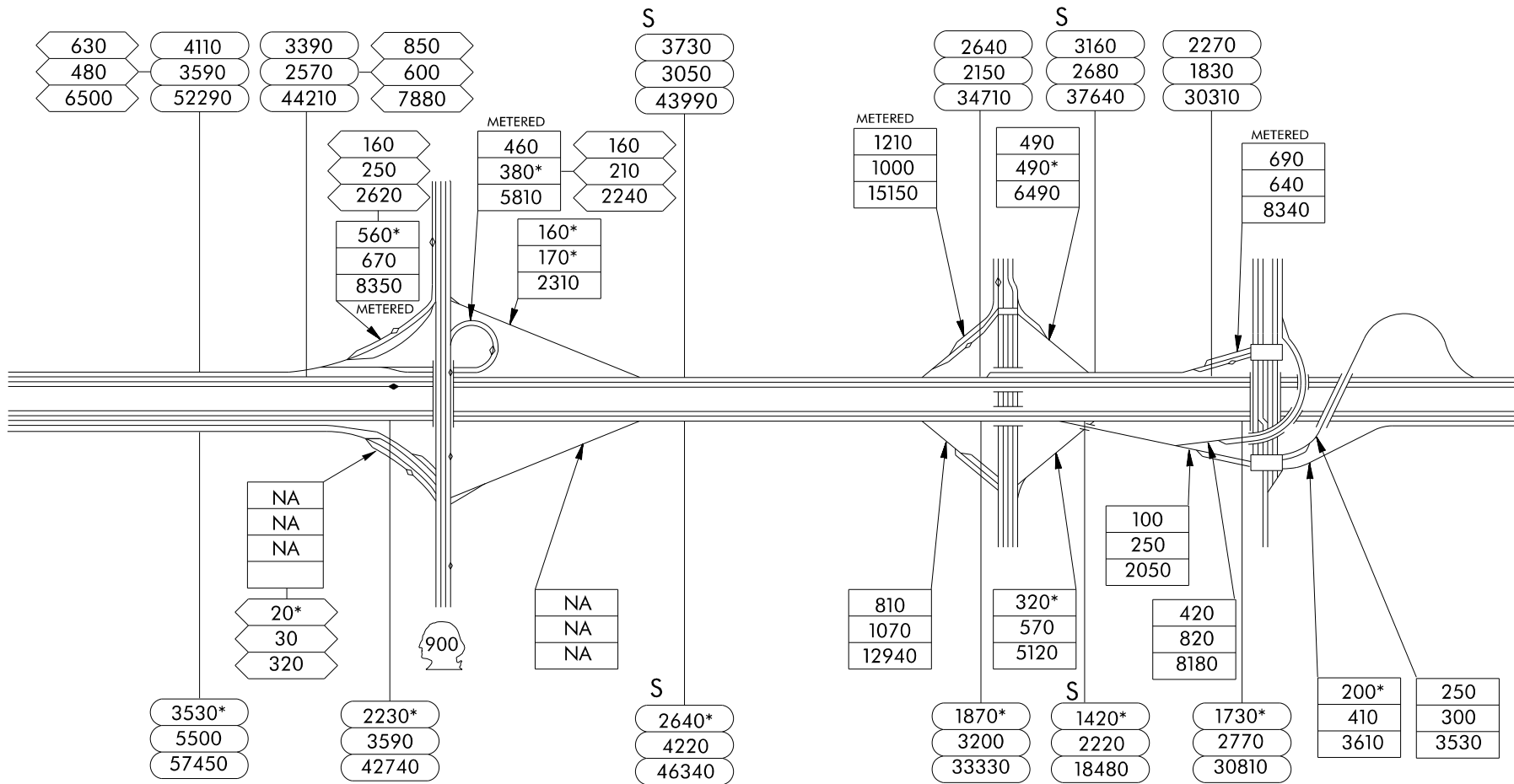



246TH AVE SE

256TH AVE SE

EXIT 20  
HIGH POINT WAY  
270TH AVE SE

S  
2650  
1870  
27650

S  
2590  
2140  
29780

S  
1940\*  
3200  
31840

S  
1960\*  
3230  
32350

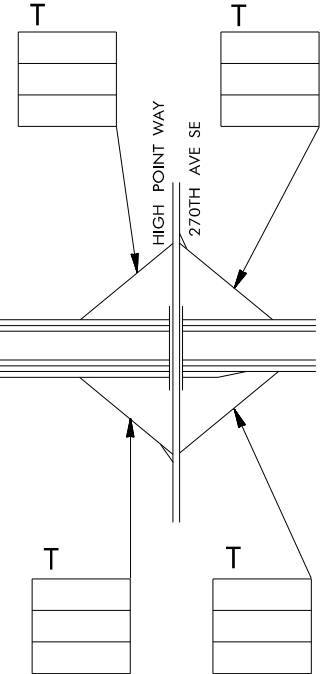

EXIT 22  
PRESTON-  
FALL CITY RD

EXIT 25  
SR 18

EXIT 27  
SE NORTH BEND WAY

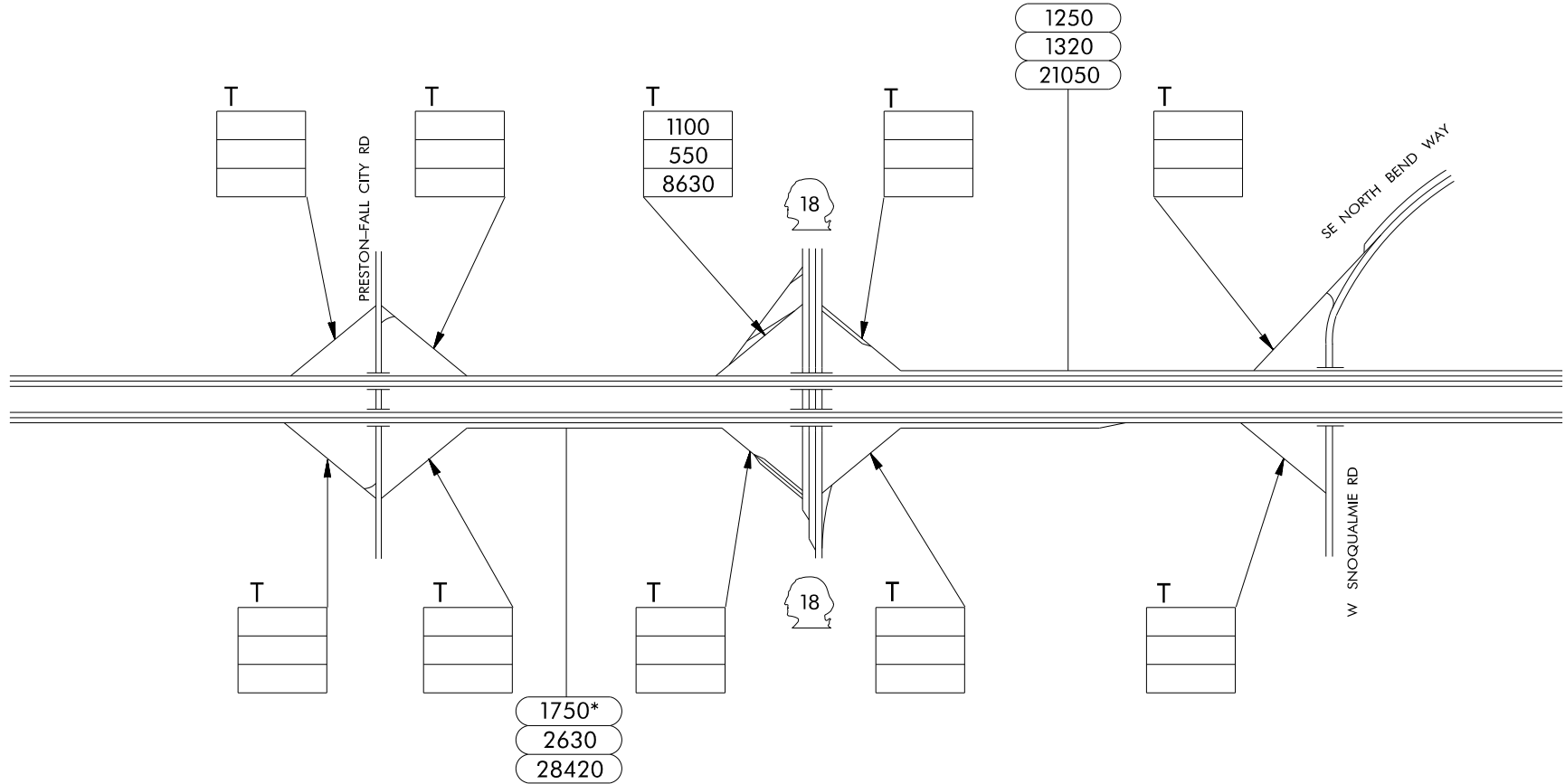

EXIT 31

SR 202

EXIT 32

436TH AVE SE

EXIT 34

EDGEWICK ROAD

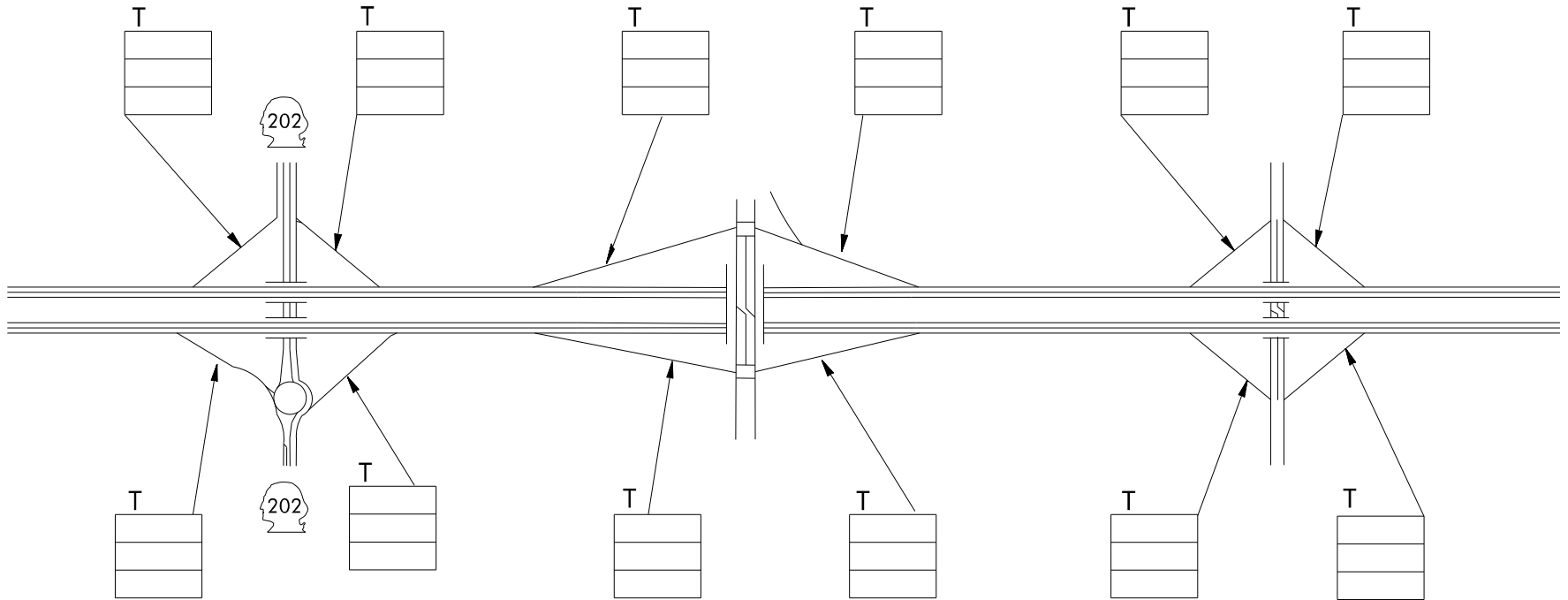

Washington State  
Department of Transportation



11  
OF  
11



EXIT 1

I-5  
(TUKWILA)

ANDOVER PARK W

INTERURBAN AVE S

SR 181  
WEST VALLEY HWY

LONGACRES DR SW

2730	430	4490
3020*	310	4450*
49000	3970	81190

4130	590
3970*	580
71350	7490

4530	670
4340*	660
73070	8750

530*	30
760	60
9410	660



1780*	340*
1320*	380
24490	4790

990
970
15890

430
180
2910

METERED

300*
420
5190

520*
550
7790

SOUTHCENTER BLVD



1310*
1640
24820



1560	1600*
1670*	1250
29890	22250

420*
680*
7840

METERED

320*
520
5870

360*
690
8100

4400	460*
4670*	960
79010	10320

960
830*
12510



3670*	510*
4110	1190
70740	12610

S

3970*	500*
4710	1110
76090	12030



Washington State  
Department of Transportation



1  
OF  
16

POWELL AVE SW

EXIT 2  
SR 167  
RAINIER AVE S / VALLEY FWY

TALBOT RD  
SR 515

S 9TH ST



560	2620
590*	2290*
9200	42520

650	4640
640	4400*
9060	76580

540	4320
610	3850*
8620	66340

3700	860	4680	850
3510*	1320	4420*	1370
54900	16920	71090	17490

230	660
180	670*
2120	10650

1250
1240*
181810



1730*
1370*
25370

150
140*
2140

350*
800
9660

610
880
11260

1470*
1620
28170

740
660
10140

210*
400
3680



730*
400
7590

230*
420
3970

1230*
1240*
15380

METERED
560*
550*
8310

330
130
1800

500*	1870*
930	2610
11170	37250

700
630
9820

610	2090*
910	3040
12140	42000

480*	3870*
1000	4740
11440	75500

3180*	1190*	3510*	1250
4260	1270	4750	1230
58840	18520	66750	18520



Washington State  
Department of Transportation



2  
OF  
16

EXIT 4

SR 169  
MAPLE VALLEY RD

EXIT 4

SR 900  
SUNSET BLVD

EXIT 5

SR 900  
NE PARK DR



NE 24TH ST

S

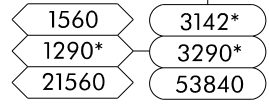
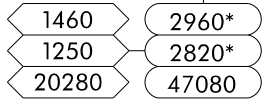
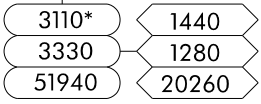
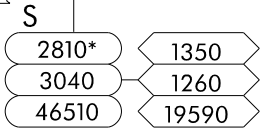
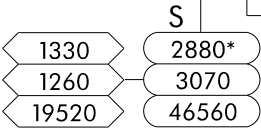
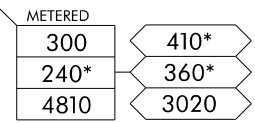
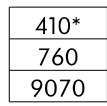
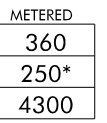
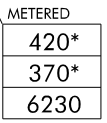
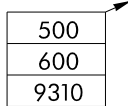
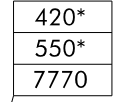
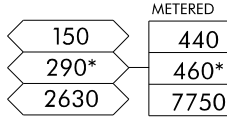
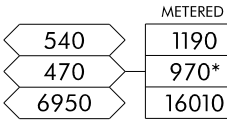
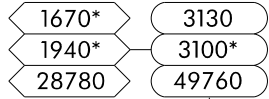
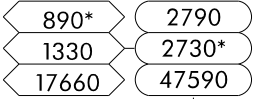
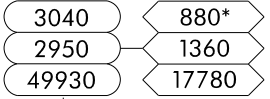
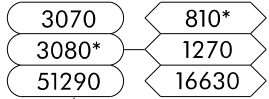

Washington State  
Department of Transportation



3  
OF  
16

EXIT 6

NE 30TH ST

EXIT 7

NE 37TH ST  
KENNYDALE HILL

NE 44TH ST

SE 72ND ST

SE 64TH ST

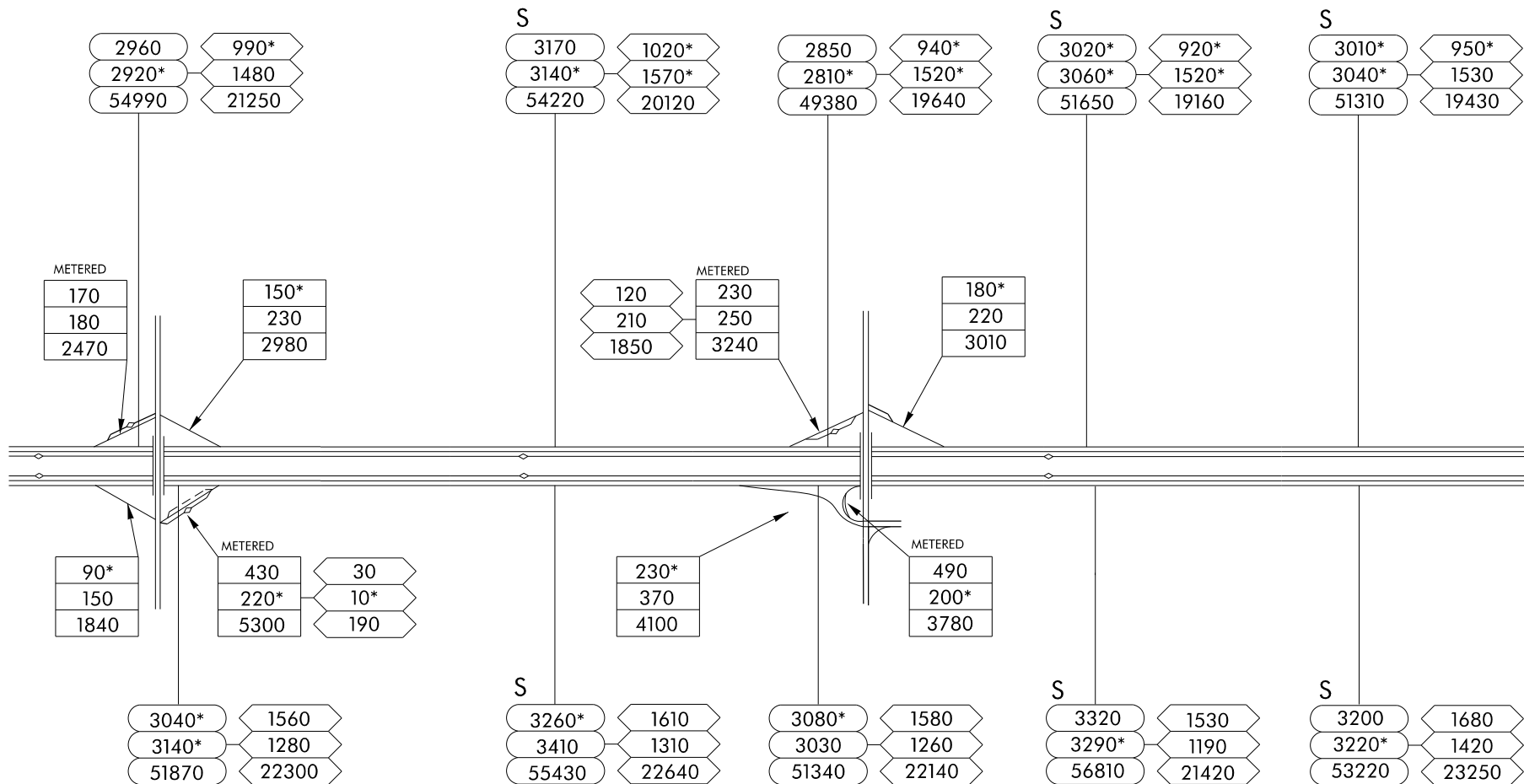

Washington State  
Department of Transportation



4  
OF  
16





SE 59TH ST

S

2960	890*
2940*	1440*
51190	18530

EXIT 9

SE 52ND ST  
112TH AVE SE

3020*	940*
3020*	1560*
50260	18850

SE 47TH ST

S

3260*	960*
3260*	1610*
54060	19670

EXIT 10

COAL CREEK PKWY

S

800*	3040*
1500*	3050*
17430	49550

METERED

60	170*
50*	200*
850	2640

METERED

290*	60	670*
700	60*	920*
6710	850	11400

50*
60
820

METERED

570	220
250*	30
5050	850

980
1180
4700

1370
940
15600

S

3180	1280
3230*	1020
57560	18310

S

1390	3380
1110	3350*
19240	57640

S

4160	1220
3760	950
65260	16620

S

1080	4000
800	3620
14560	61930



Washington State  
Department of Transportation



5  
OF  
16



SE 39TH ST

EXIT 11

I-90

SE 24TH ST

SE 17TH ST

S

2440*	570*
2490*	1230*
36650	13260

2460*	550*
2550*	1210*
36890	12860

S

4870*	210	550*	5000*	130	490*
5080*	560	1170*	5330*	660*	1110*
76750	4410	12310	79070	4110	11150

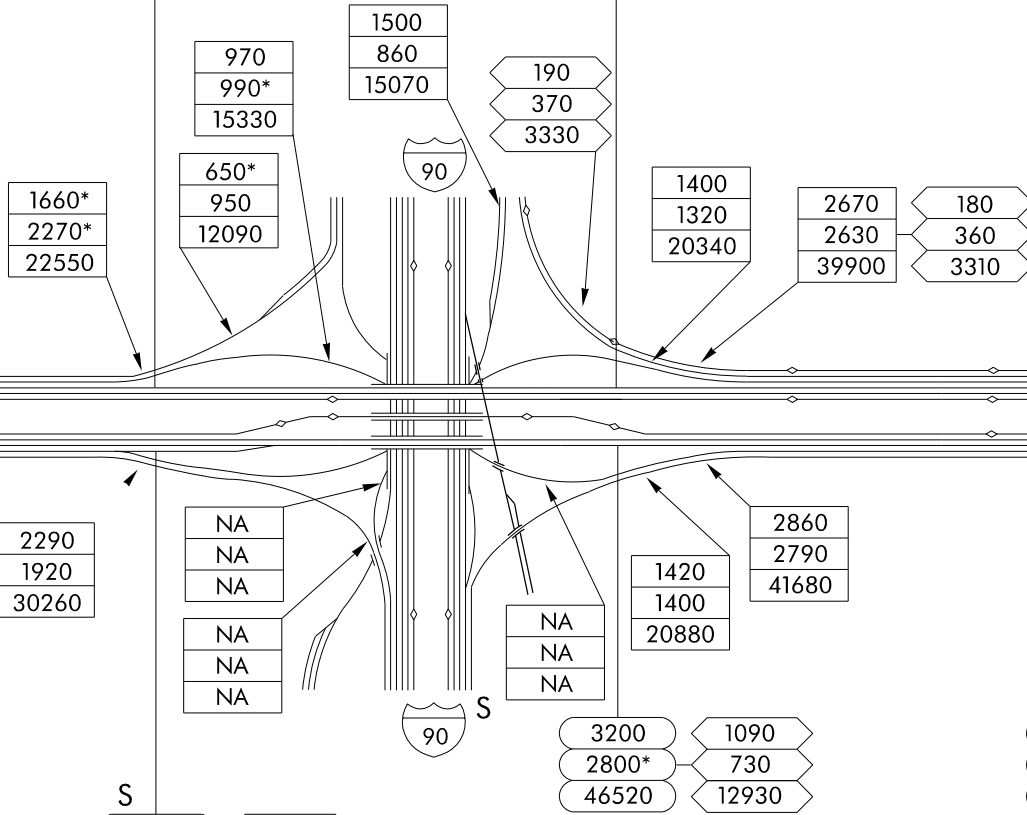

2290
1920
30260

NA
NA
NA

NA
NA
NA

S

90

1420
1400
20880

2860
2790
41680

3200	1090
2800*	730
46520	12930

S

3180	1080
2780*	720
48030	13300

S

5960	1140
5260*	810
87790	13410

S

6010	1160
5580*	790
89050	12150

EXIT 12

SE 8TH ST

MAIN ST

S

4650	530
5040*	1030*
75920	10750

METERED

260*	30*
360	210
4270	1170

660
660
7650

220
190
2950

650
400*
5820

116th Ave SE

METERED

NA	180
NA	140
NA	1710

S

5140	930
5020*	750
80760	10310

S

4430	690
4390*	690
69600	8700



Washington State  
Department of Transportation



7  
OF  
16

EXIT 13A  
NE 4TH ST

HOV ONLY EXIT  
NE 6TH ST

EXIT 13B  
NE 8TH ST

NE 10TH ST

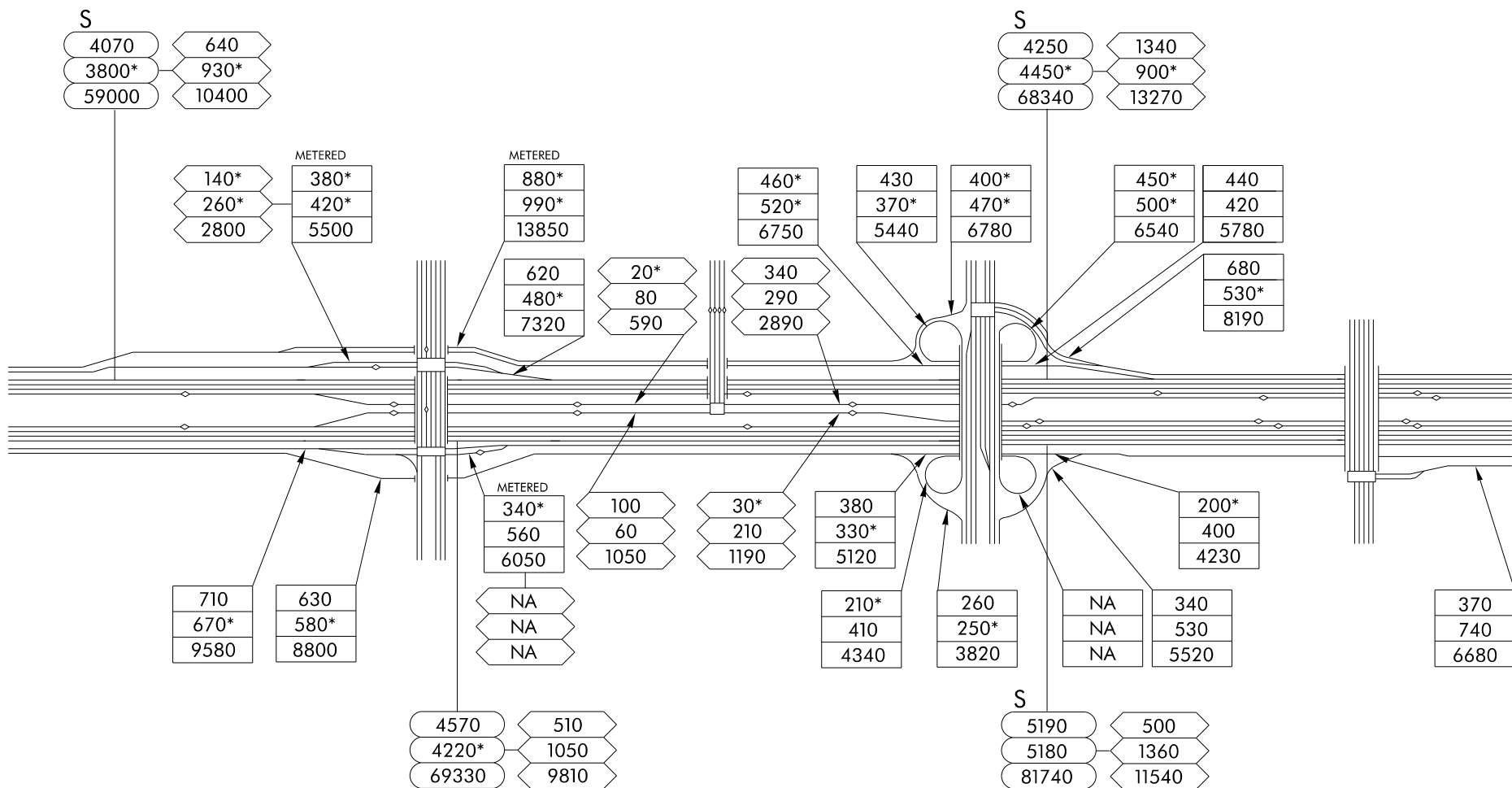



EXIT 14

NE 14TH ST

SR 520  
(NORTHUP)

NE 28TH ST

NE 37TH ST

NE 46TH ST

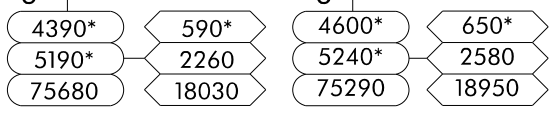
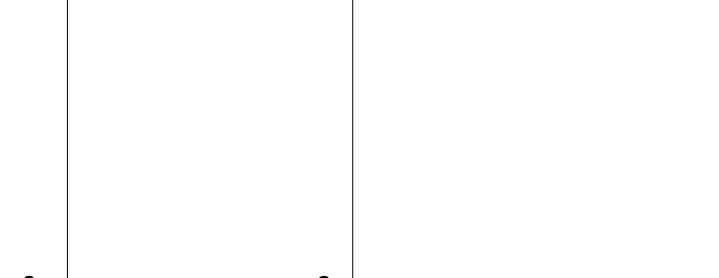
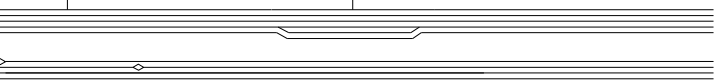
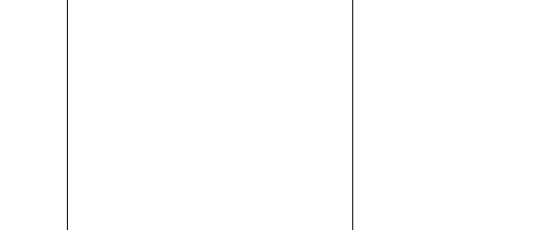
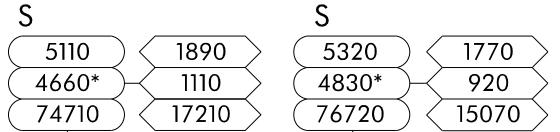
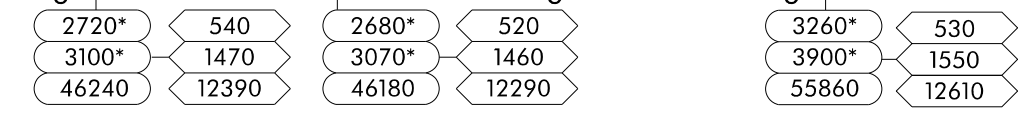
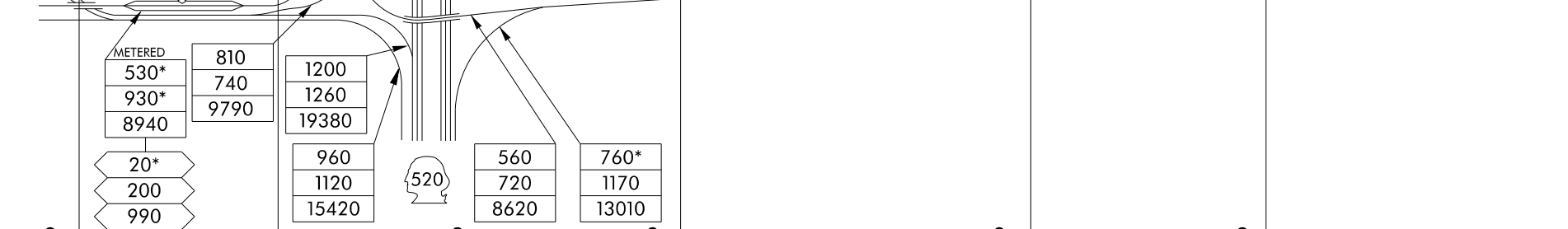
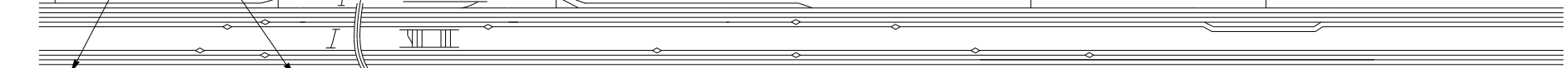
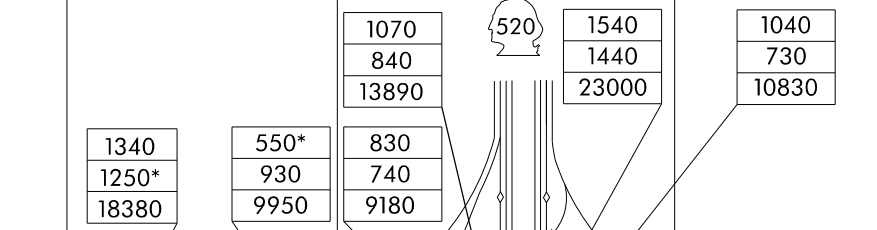
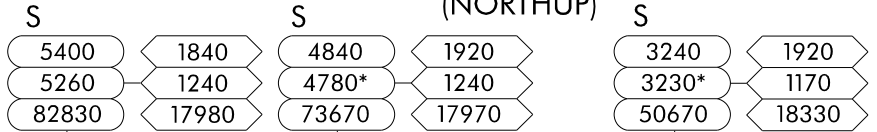

NE 57TH ST

EXIT 17  
NE 70TH PL

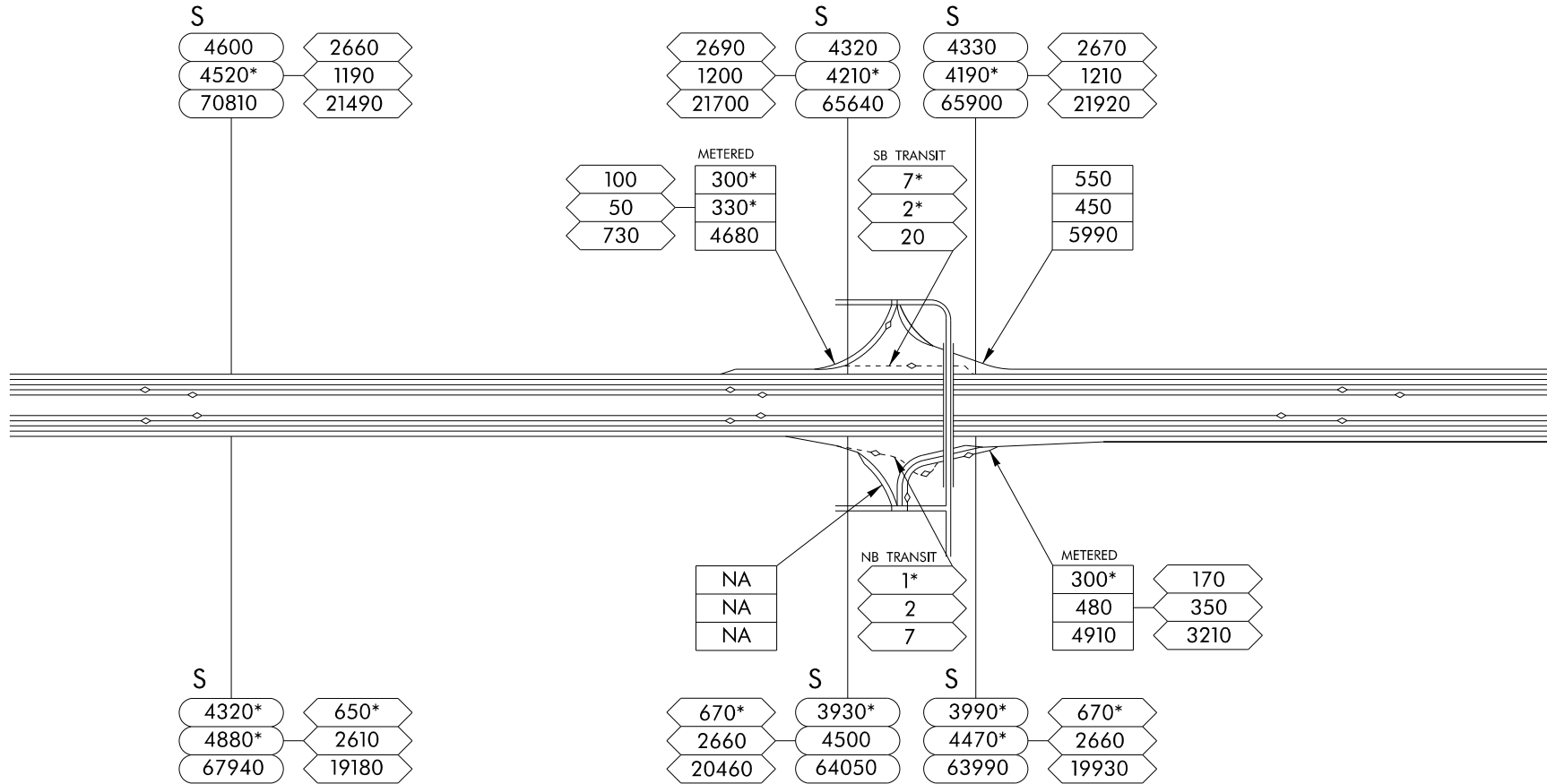



EXIT 18  
NE 85TH ST

NE 97TH ST

NE 106TH ST

S

4190	2630
3800*	1190
61120	21570

50
20
340

540
510
8280

350*
410
5410

390
430
5540

METERED
360*
380*
5020

370*
400*
5280

METERED

550
510
8310

S

4190	2650
3780*	1200
60910	21720

S

5380	2860
5000*	1270
77580	22430

S

4350	2750
3950*	1160
70880	24090



410
380
5420

380*
470
5980

METERED
350*
430*
5500

270*
270*
3990

METERED
390*
430*
6220

410
360*
5270

S

3650*	670*
4290*	2710
60790	20450

40*
200
1460

S

3650*	660*
4250*	2700
63340	21160

4740*	720*
5500*	3040
76220	21930

S

4420*	680*
5090*	2680
74230	21020



Washington State  
Department of Transportation



11  
OF  
16

EXIT 20A  
NE 116TH ST

EXIT 20\20B  
NE 124TH ST  
TOTEM LAKE BLVD

NE 128TH ST

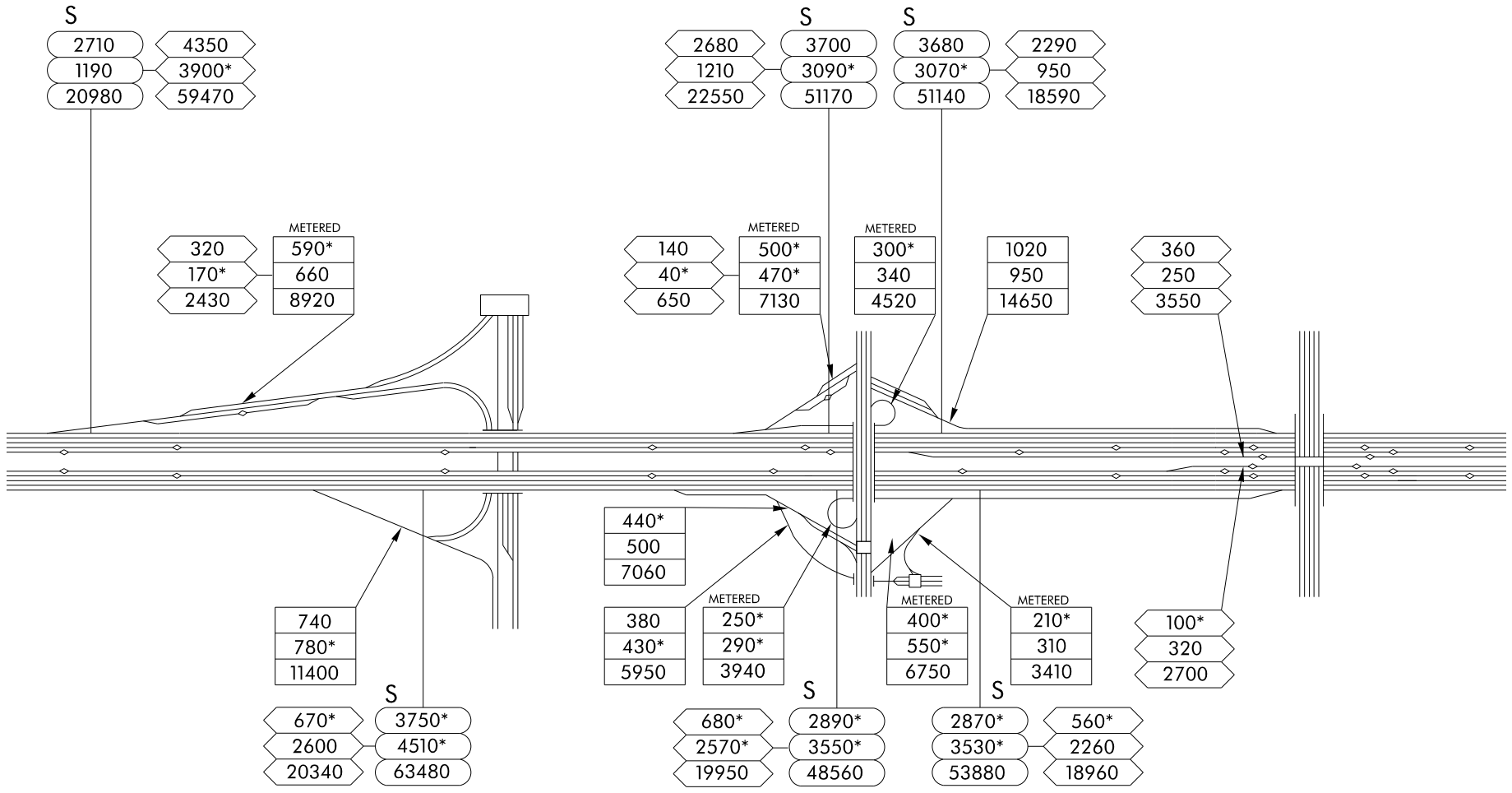



NE 132ND ST    NE 140TH ST    NE 144TH ST

EXIT 22  
NE 160TH ST  
JUANITA-WOODINVILLE WY NE

S	4730	2570	4720	2560	5130	2480
	4060*	1130	4000*	1150	4350*	1150*
	65760	21420	66040	21680	69900	20940

S	4430	1350	4960	1540
	3670*	600	3990*	780*
	65460	22410	57450	14110

METERED	550	180
	320*	90
	5330	1340

600*
940
10900

4
6
60

280
160*
2810

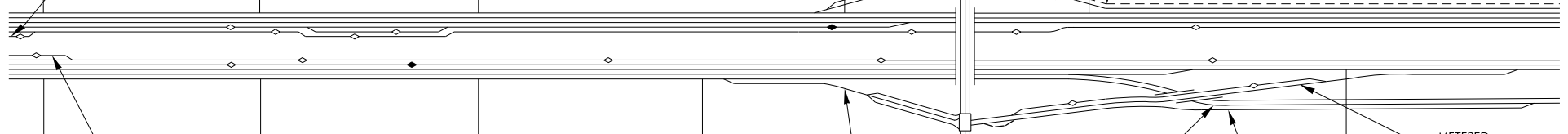

140*
340
2700

1600*
2270*
27200

340
470
5300

METERED	460
	410
	5890

30
210
1080

300*
450
5560

S	4190*	720*	3750*	710*	4390*	360*	4140*	340*
	5560*	2670	4650*	2610	5940	1530	5550	1450
	69020	19740	66000	21160	76550	10890	74190	10530

S	2210*	330*
	2990	1480
	43940	11490

EXIT 23  
SR 522  
(WOODINVILLE)

EXIT 24  
NE 195TH ST  
BEARDSLEE BLVD

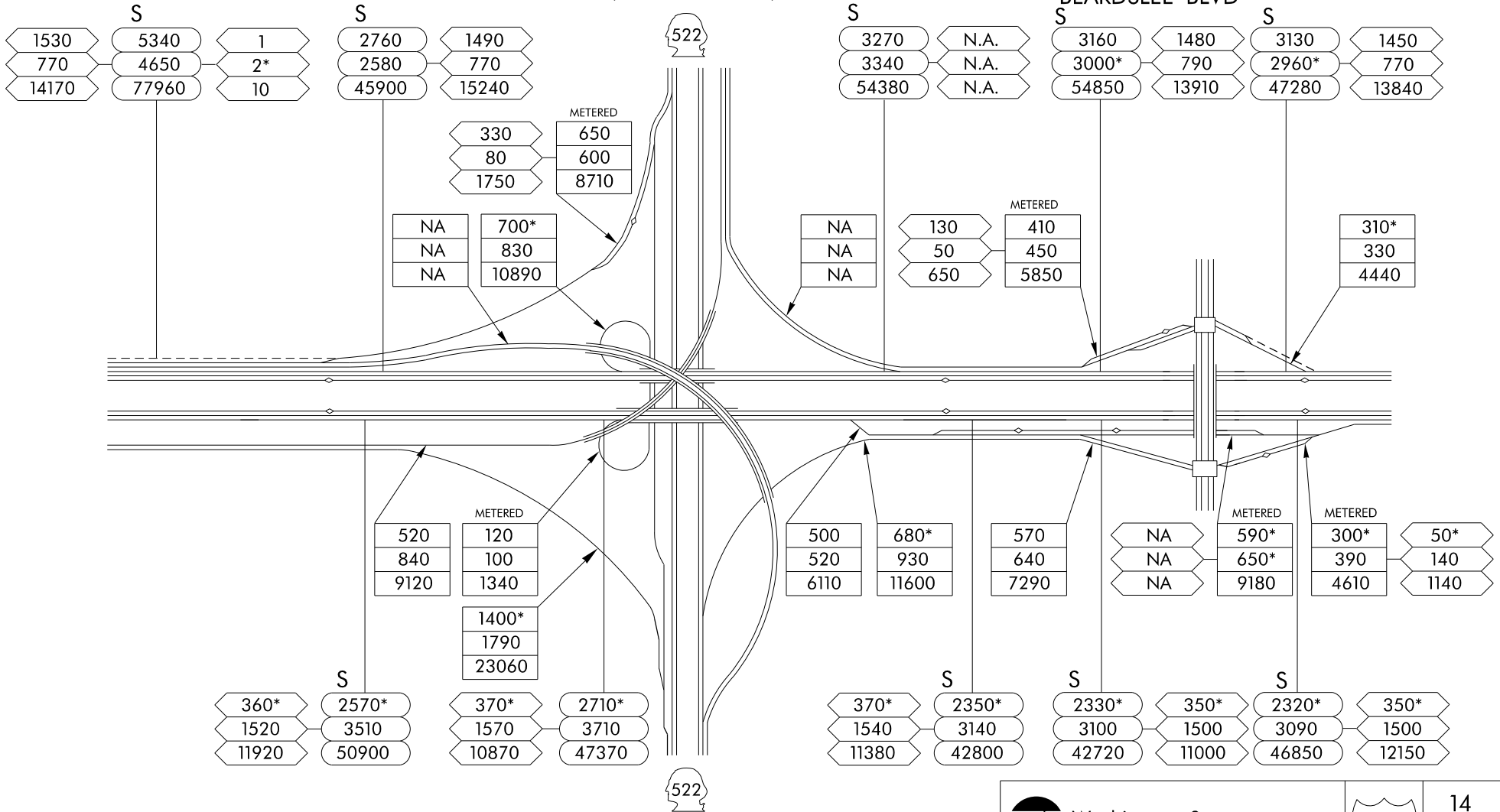

EXIT 26

SR 527

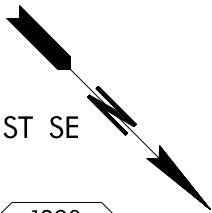

242ND ST SE

236TH ST SE

230TH ST SE

BOTHELL - EVERETT HWY

216TH ST SE

S

3610	1690
3450*	960*
52540	16100

S

3400	1440
3230*	780*
54370	14440

S

3500*	1440
34120*	780*
53010	13480

S

2510	1260
2300*	670*
40330	12460

S

2540	1250
2330*	650*
37260	11210

S

3110	1290
3220	650*
46490	10450

METERED

570*	10
540	4
7650	70

METERED

470*
430
6870
210
240
3690
310
250*
4020

METERED

NA
NA
NA

350
350
5510
140*
180
2390

METERED

250*	20*
380	80
4580	510

S

3780*	360*
5230	1540
63790	10530

S

3260*	330*
4460	1340
59030	10180

S

3250*	330*
4420	1340
53010	9130

S

2260*	330*
2900	1320
40110	10100

S

2270*	340*
2900	1330
38220	9860

S

2940*	330*
3230*	1310
48090	10150



Washington State  
Department of Transportation



15  
OF  
16

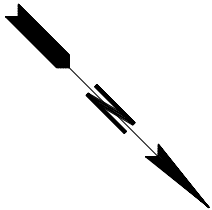

208TH ST SE

200TH ST SE

DAMSON RD

FILBERT RD  
SR 524

I-5  
(Lynnwood)

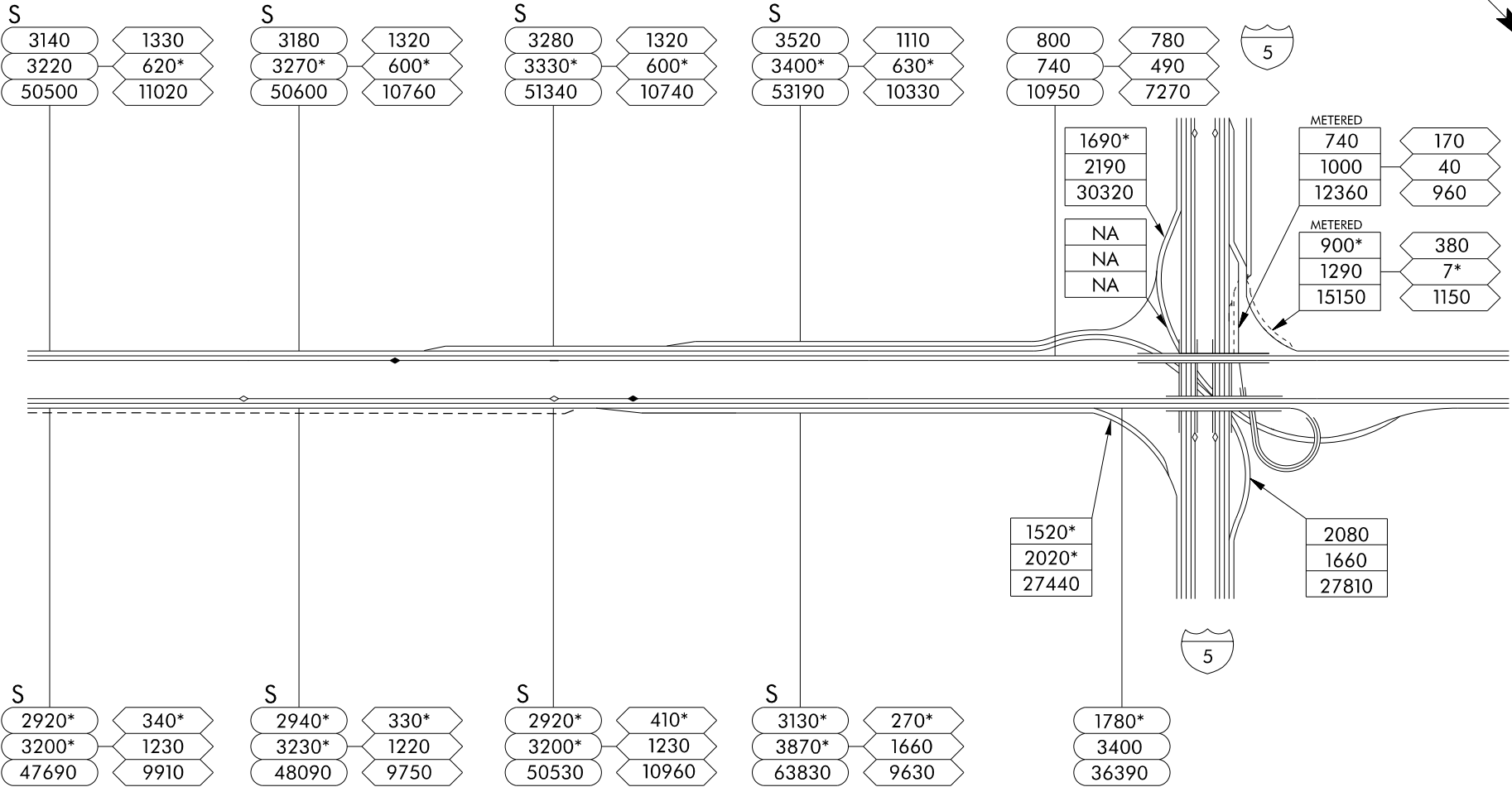

Washington State  
Department of Transportation



16  
OF  
16



I-5

WEYERHAEUSER WAY S  
32ND AVE S

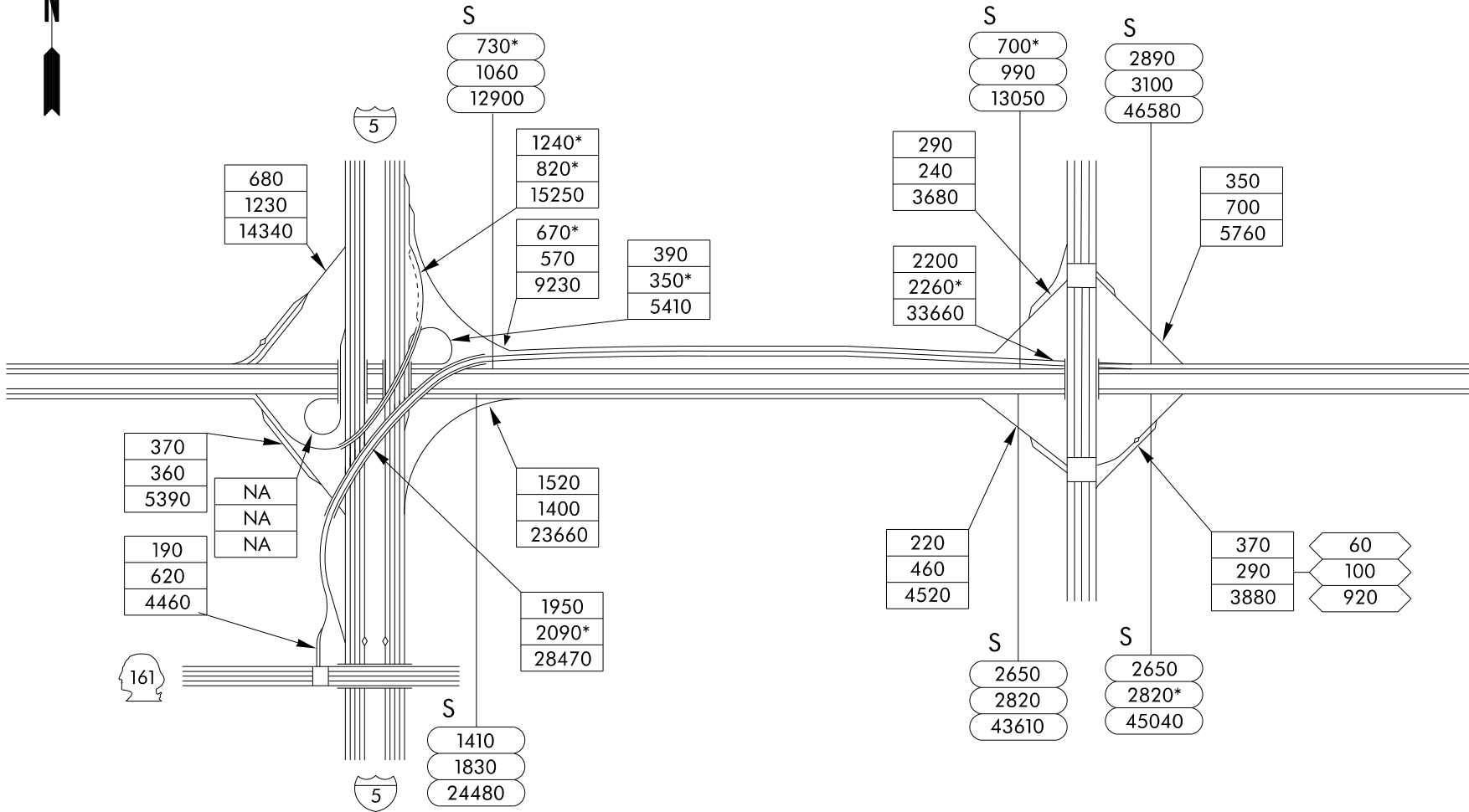

Washington State  
Department of Transportation



1  
OF  
7



WEST VALLEY SR 167  
HWY

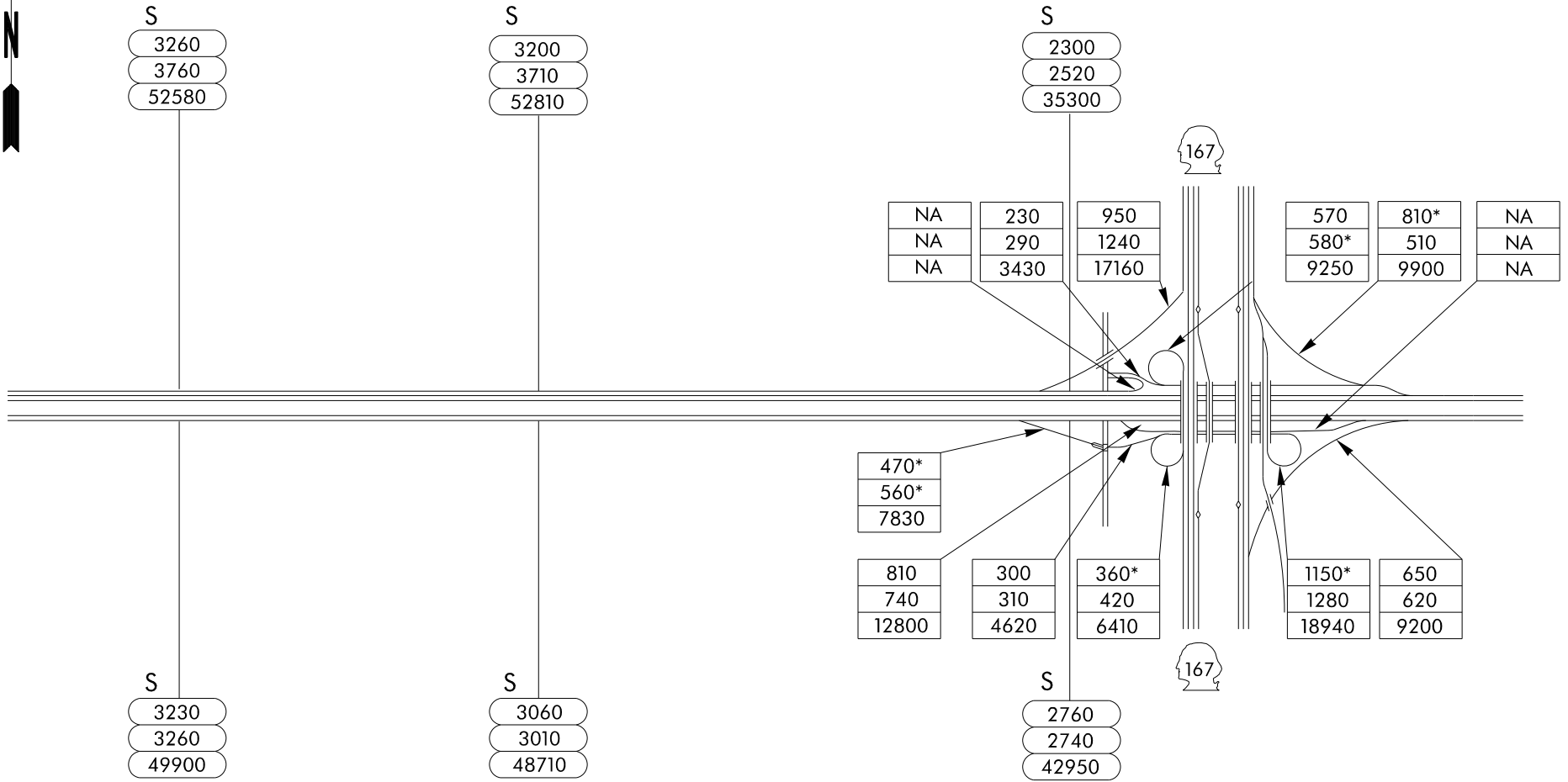

Washington State  
Department of Transportation



2  
OF  
7



"C" ST

"A" ST

AUBURN WY  
SR 164

"V" ST

S  
2560  
2640  
40150

300  
330  
4130

940  
730  
12190

NA  
NA  
NA

S  
1700  
1920  
26480



860  
800  
14240

300  
550  
5830

S  
2010  
2530  
29250

130\*  
280  
2740

560  
530  
8360

NA  
NA  
NA

470  
400  
5690

S  
2500  
2860  
41740



S  
NA  
NA  
NA

S  
2080  
2270  
27920



Washington State  
Department of Transportation



3  
OF  
7

AUBURN-  
BLACK DIAMOND RD

SE 304TH ST

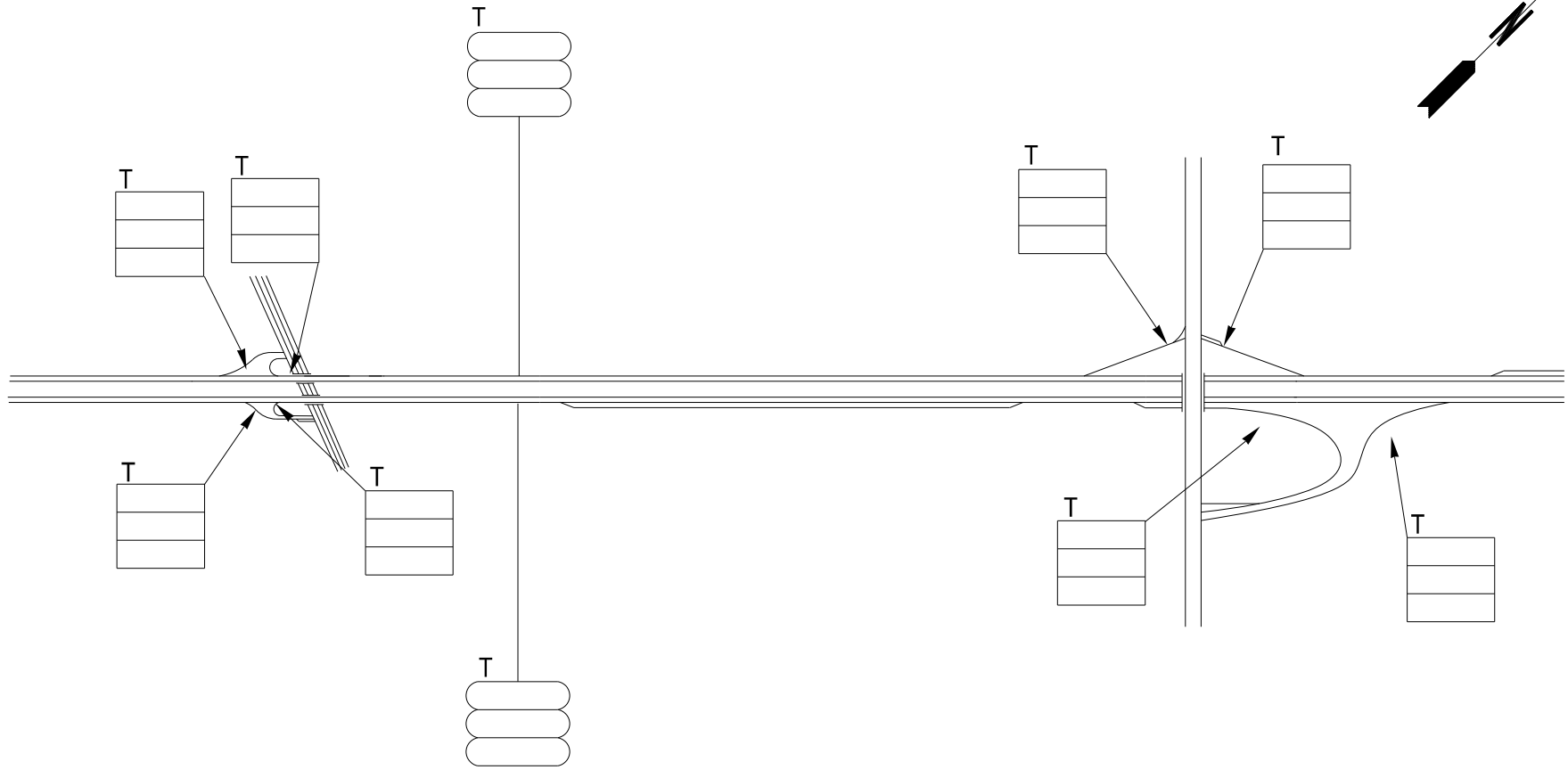

Washington State  
Department of Transportation



18

4  
OF  
7



SE 272ND ST  
SR 516

180 AVE SE

SE 256TH ST

SE 252ND ST

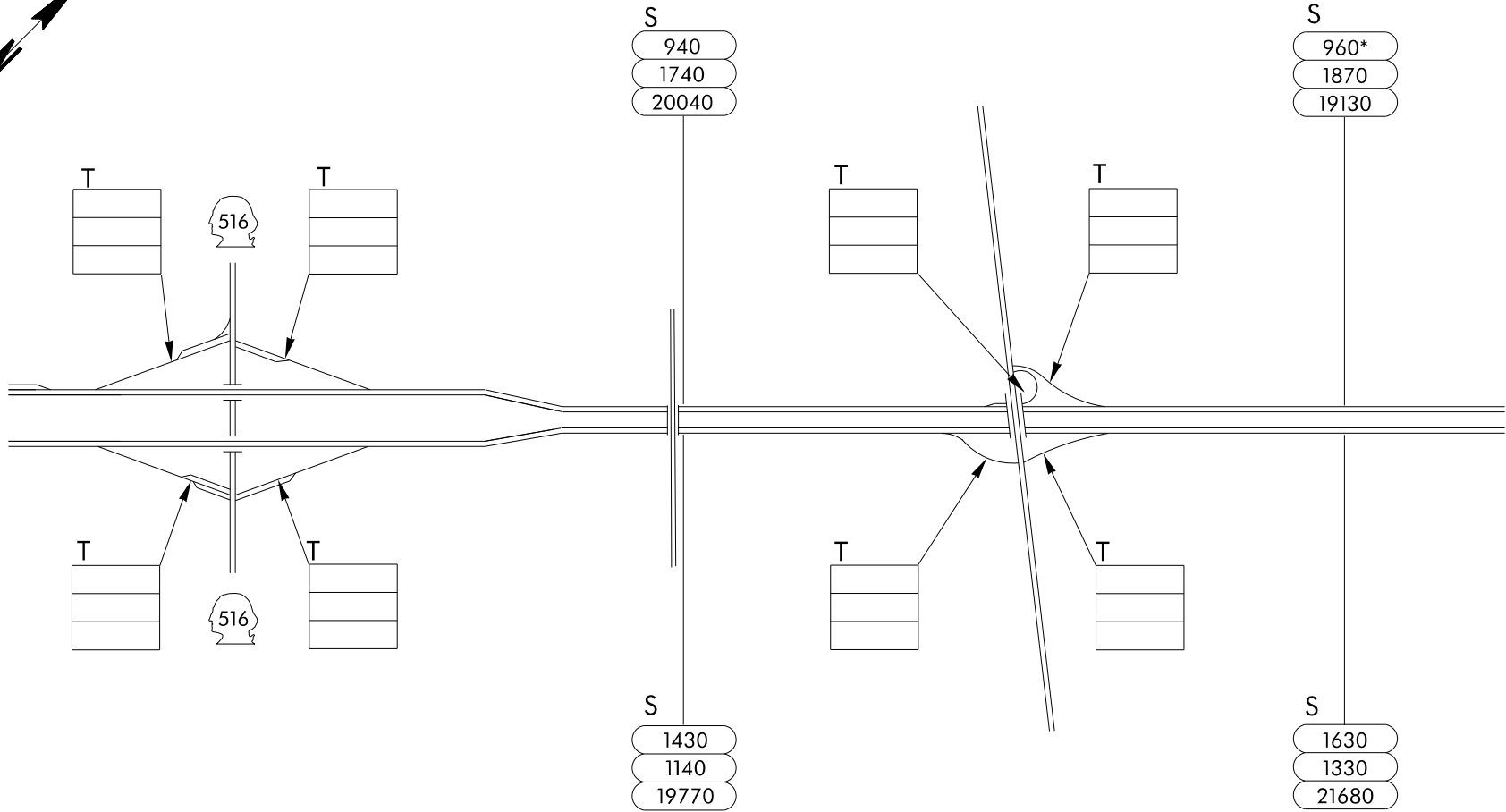
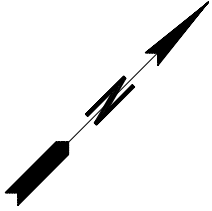

Washington State  
Department of Transportation



5  
OF  
7

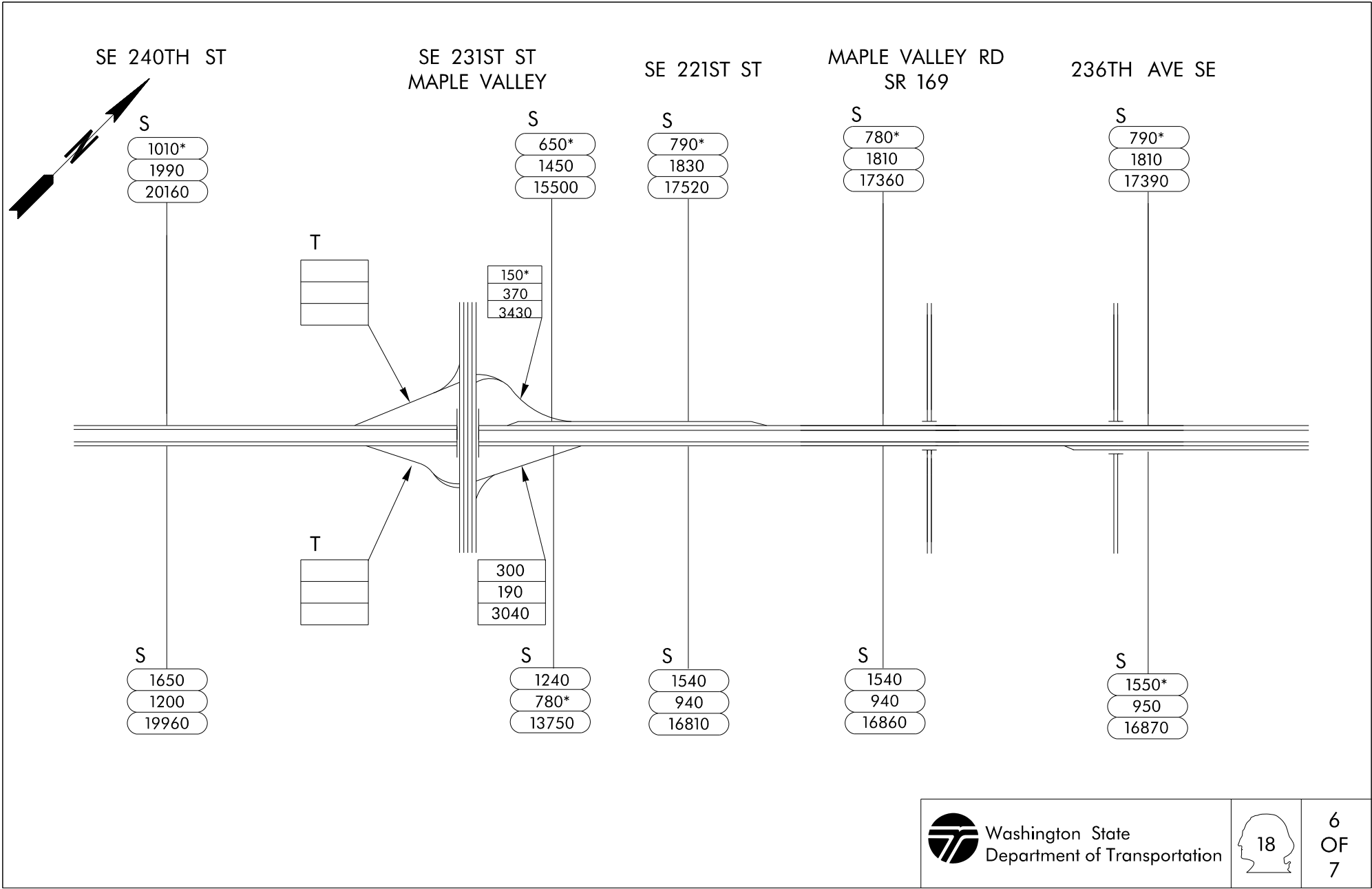

244TH AVE SE

SE 200TH ST

ISSAQUAH-HOBART RD

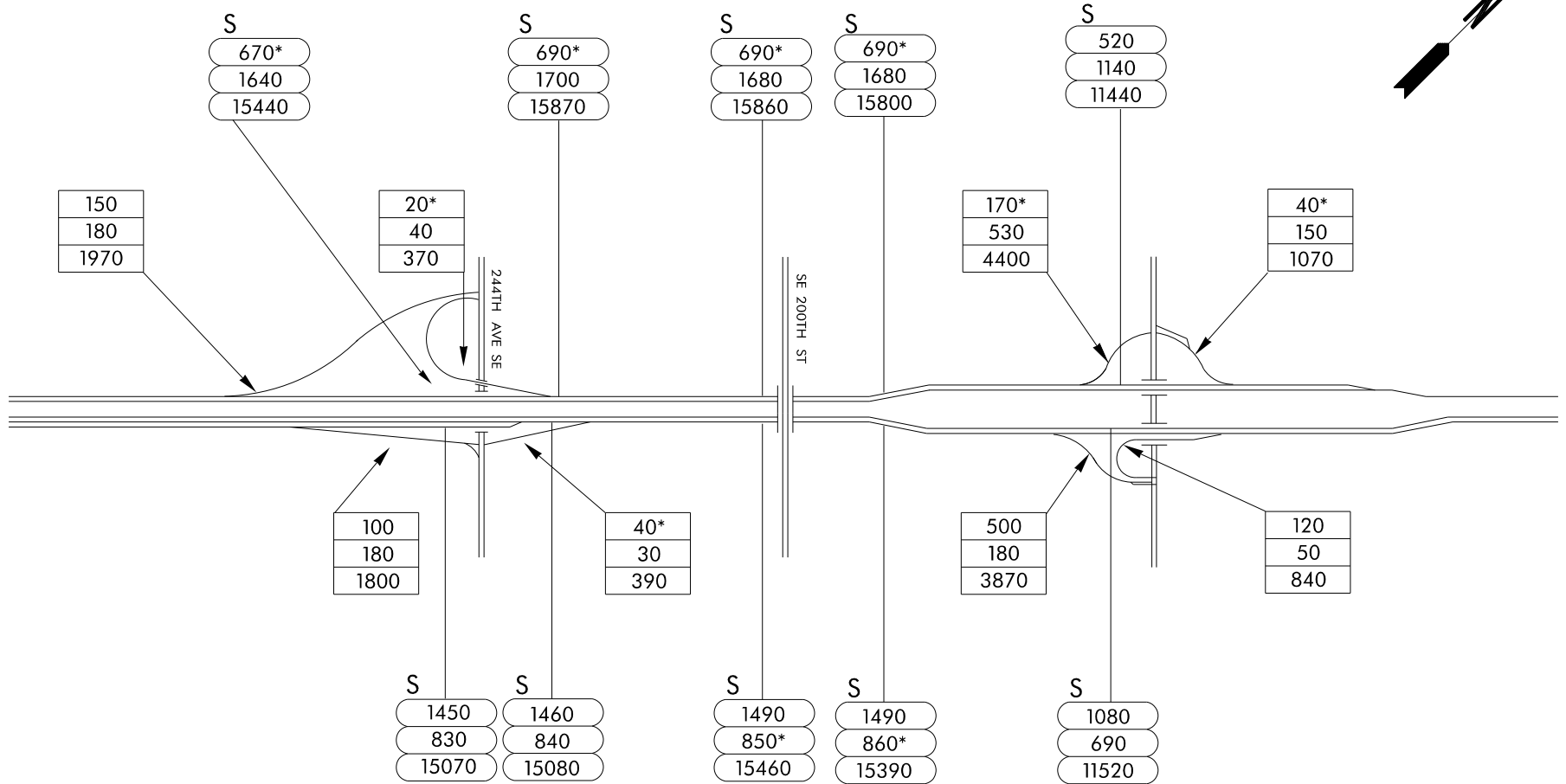
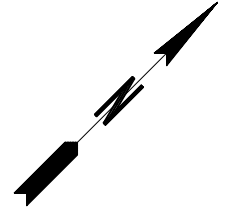

Washington State  
Department of Transportation



18

7  
OF  
7



SR 599  
TUKWILLA INTERNATIONAL BLVD

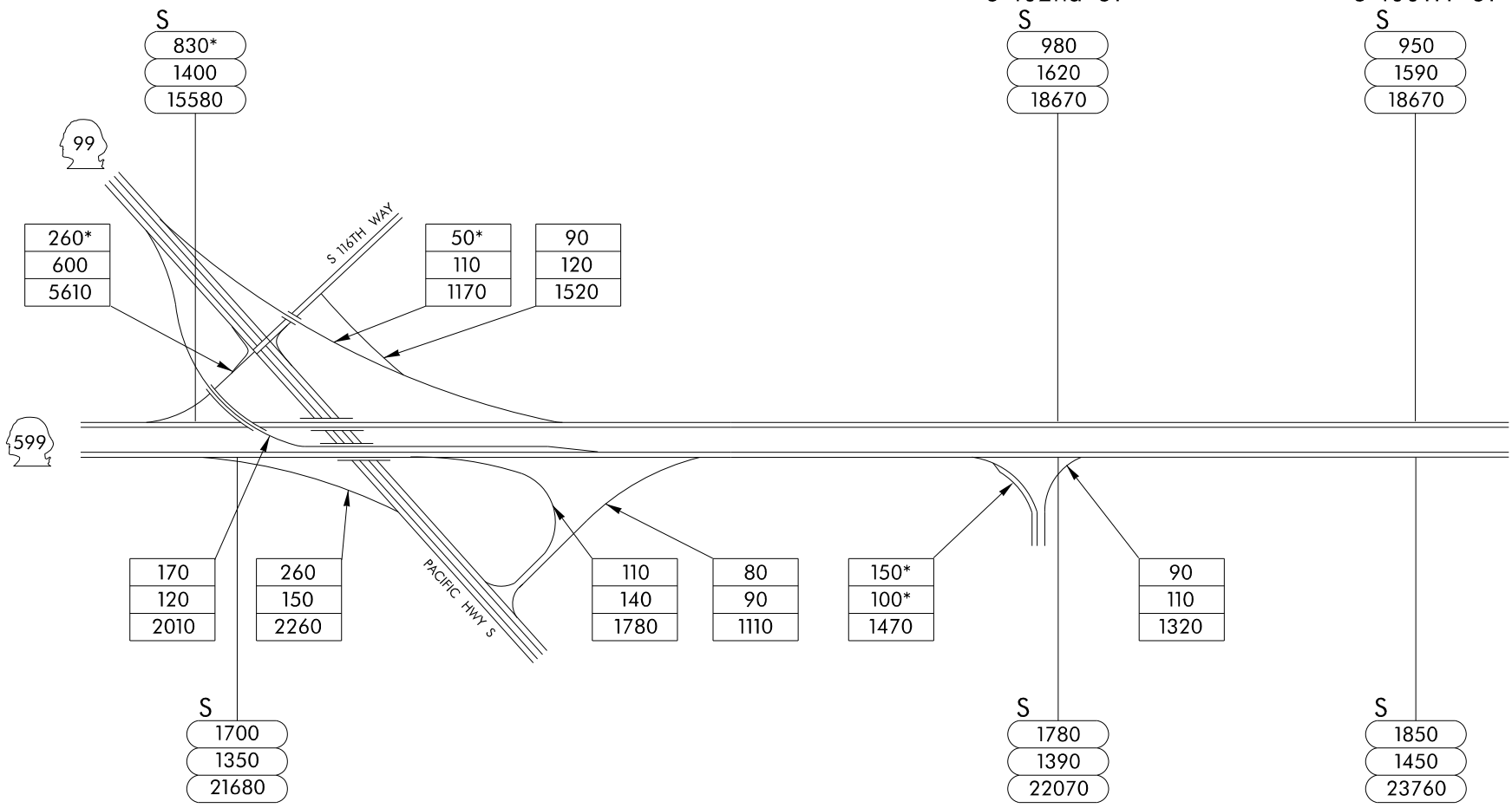



DES MOINES MEMORIAL DR  
14TH AVE S

S CLOVERDALE ST

S KENYON ST

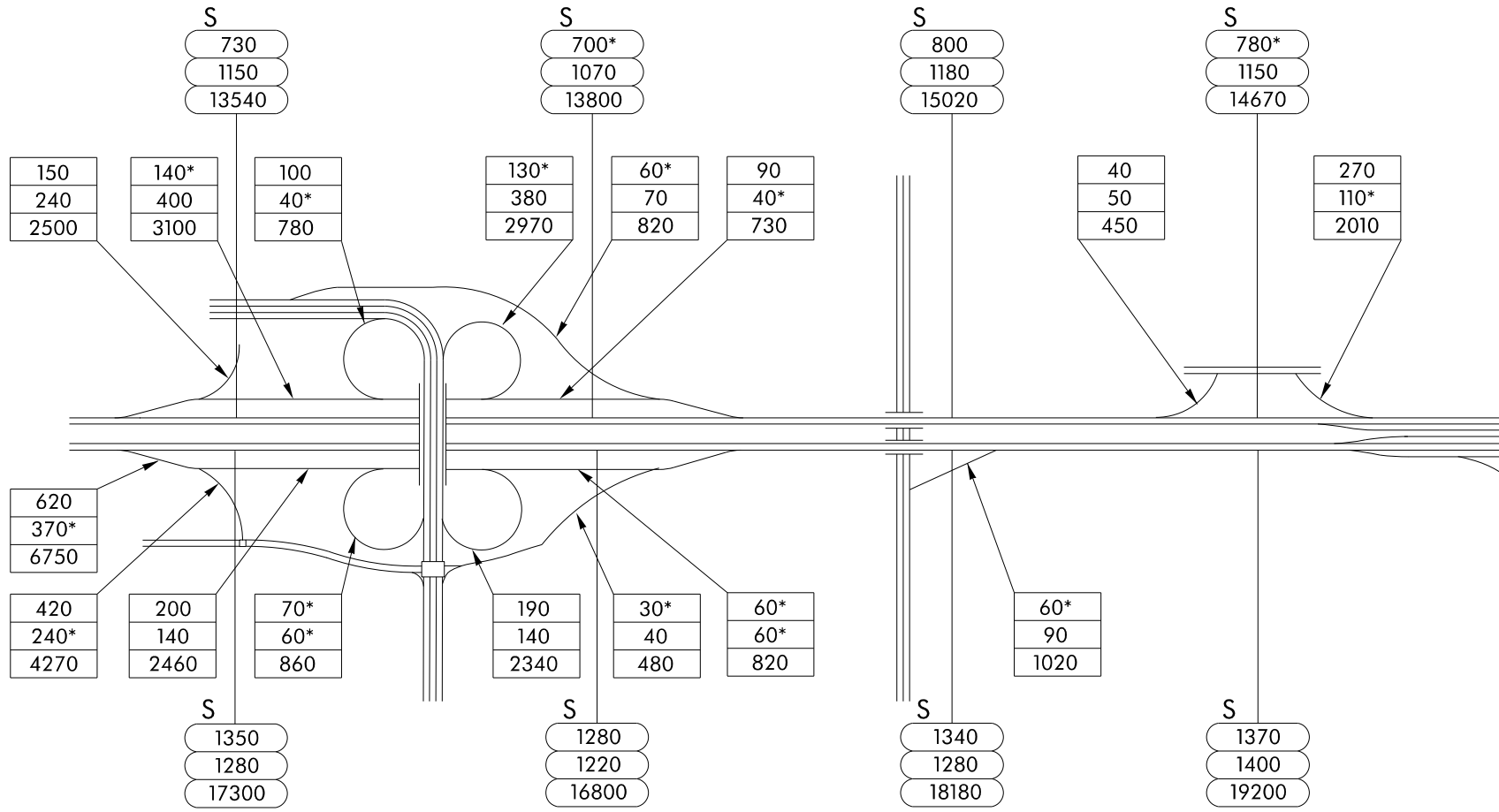

SR 509  
S HOLDEN ST



1ST AVE BRIDGE S

1190*	150*
2790	960
27430	5670

270
340
3940

920*
1360
16480

509

99

280*
390
5050

99

1530
1550
21780

2410	1080
1590	170
28520	5360



Washington State  
Department of Transportation

99

3  
OF  
5



S LANDER ST

ROYAL BROUGHAM

ER 2

ER 6

S  
 1210  
 2760  
 26540

S  
 710  
 1670  
 14660

S  
 1320  
 2390  
 19640

S  
 1310  
 2380  
 21770

500  
 1100  
 11880

SR 99 Tunnel

1140  
 750  
 12160

600  
 630  
 5770

S  
 2740  
 2000  
 29590

S  
 1760  
 1310  
 17090

S  
 2190  
 1860  
 22110

S  
 2180  
 1860  
 22070



Washington State  
Department of Transportation



4  
OF  
5



ER 10

- S
- 1310
- 2380
- 21700

ER 14

- S
- 1310
- 2380
- 21700

MERCER ST

- S
- 1190
- 2010
- 20420

COMSTOCK ST

- S
- 2140
- 2490
- 27500

SR 99 Tunnel

- 1120
- 980
- 12220

- 170
- 470
- 3930

- 660
- 390
- 5520

- 400\*
- 1040
- 8800

- S
- 1310
- 2380
- 22050

- S
- 2160
- 1840
- 19840

- S
- 1510
- 1450
- 18300

- S
- 1880
- 2770
- 27650



Washington State  
Department of Transportation



5  
OF  
5





Ellingson Rd

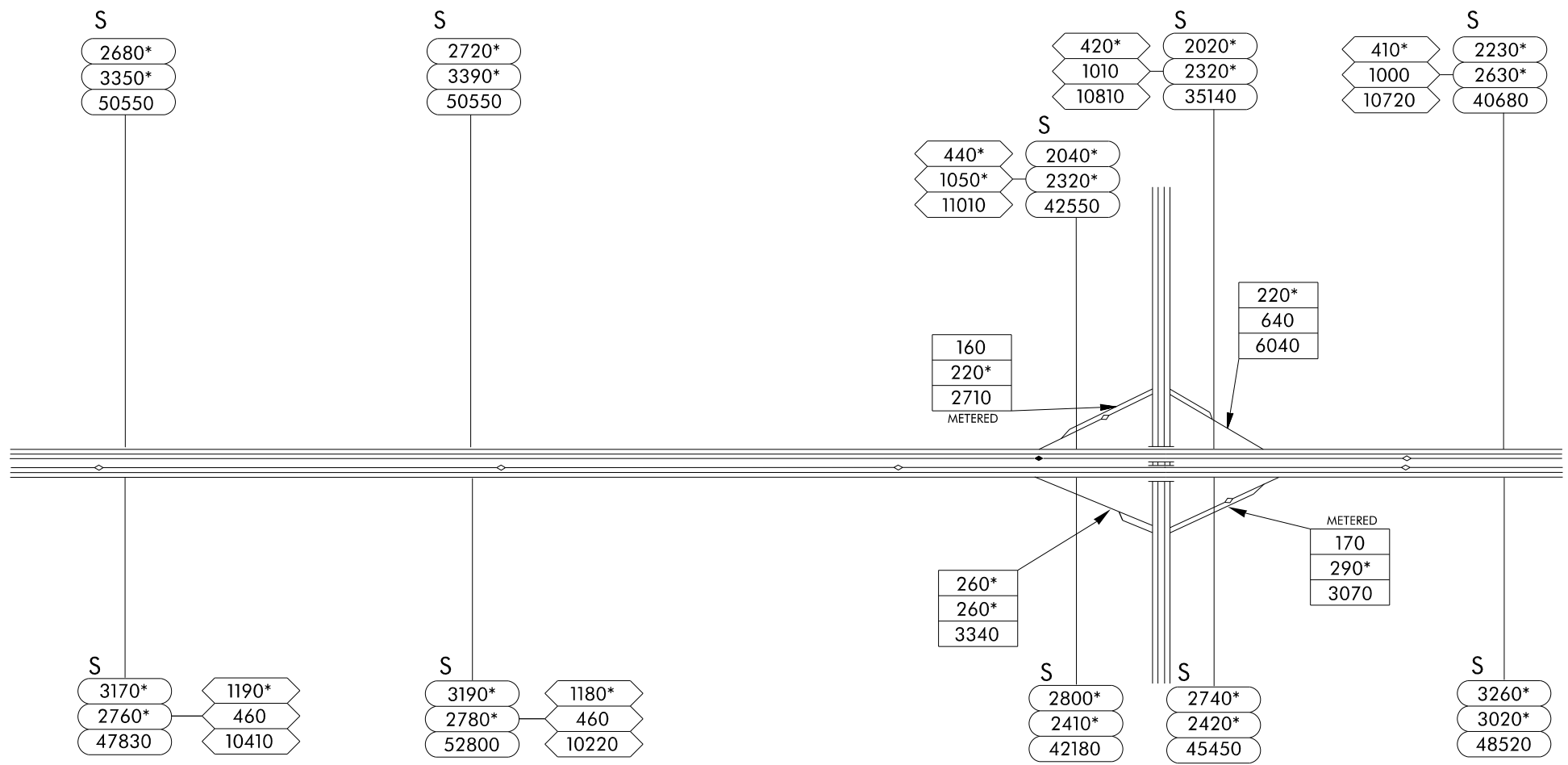

7TH Ave N

15TH ST SW

SR 18

S

S

15TH ST NW

S

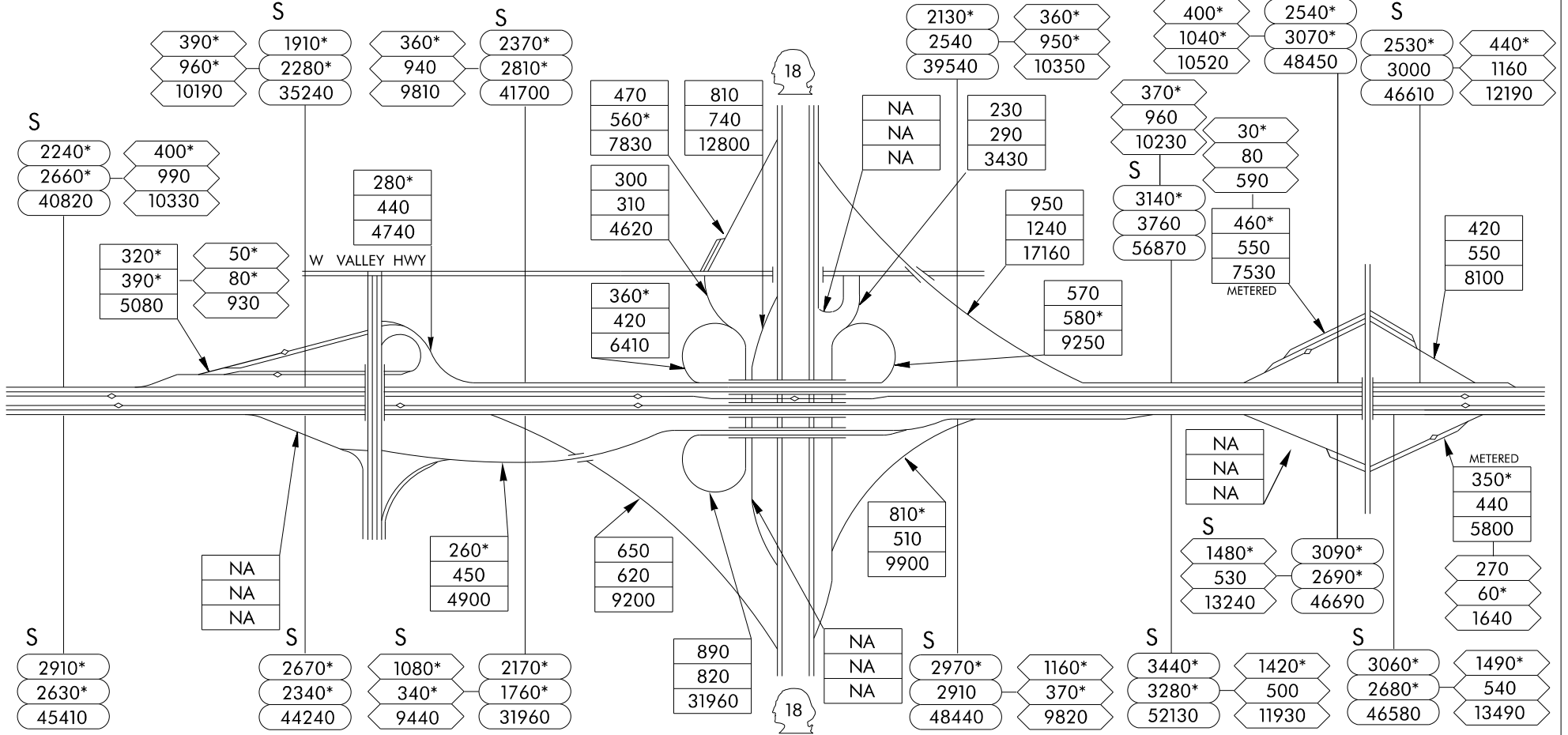



Emerald Downs

34TH ST NW

37TH ST NW

S 277TH ST

S 269TH ST

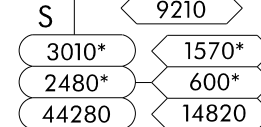
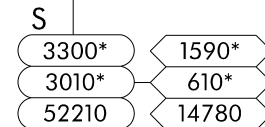
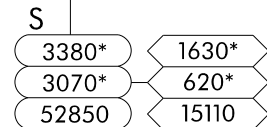
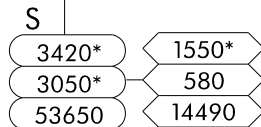
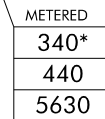
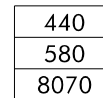
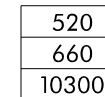
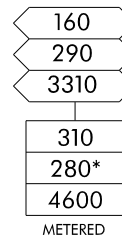
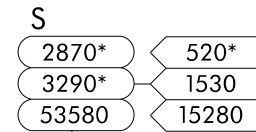
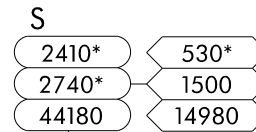
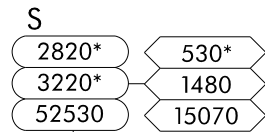
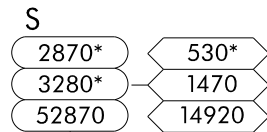
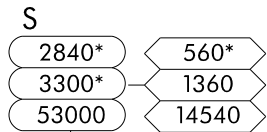

Washington State Department of Transportation



167

3 OF 6



GREEN RIVER

SR 516 WILLIS ST

JAMES ST

4TH AVE

84TH AVE S CENTRAL AVE

S

2870*	530*
3320*	1600
52850	15460

S

2270*	520*
2640*	1530
42100	15130

S

2670*	570*
3070*	1540
47830	15560

S

NA	NA
NA	NA
NA	NA

S

NA	NA
NA	NA
NA	NA

NA
NA
NA

610*
620*
10280

METERED



350*
430
6240

METERED

NA
NA
NA

560*
680
10780

880
800
13510



METERED
230
290
4020
210
90*
1970

NA
NA
NA

METERED
530*
560
8870
430
190*
3130

S

3500*	1570*
3020*	640*
53520	15020

S

2770*	1500*
2310*	620*
41290	14600

S

3090*	1610*
2680*	680*
46920	14950

S

NA	NA
NA	NA
NA	NA

S

2610*	1480*
2310*	650*
40620	14380



Washington State Department of Transportation



167

4 OF 6



S 222ND ST

S 212TH ST

S 204TH ST

S 194TH ST

S

2780*	520*
3220*	1390
45970	12890

S

1570*	340*
2090	1070
30920	11050

S

2860*	530*
3230*	1470
47710	13680

S

2900*	600*
3300*	1570
52400	15940

S

2860*	530*
3270*	1550
53340	15340

70*
200
1390
NA
NA
NA
METERED

470
460
6960

NA
NA
NA

METERED

440*
520
7260

S

3260*	1490*
3010*	700*
48790	13870

S

2760*	1500*
2510*	700*
42620	14800

S

3030*	1500*
2910*	730*
49370	15540

S

3110*	1490*
2980*	630
49900	14340

S

3050*	1470*
2930*	720*
45080	13650



Washington State  
Department of Transportation



167

5  
OF  
6

S 180TH ST

SW 41ST ST

S 34TH ST

S 23RD ST



S	2510	480*
	2770*	1440
	50740	14040

S	3160	460*
	3500	1340
	63810	13110

S	3200	450*
	3630	1240
	57620	12390

90*
310
2280

390*
400*
6200
METERED

690*
700
10570

1470*
1620
28170

210*
400
3680

1450*
1630
28070

METERED
660
670*
10650
230
180
2120

E VALLEY HWY



350*
810
9680

720*
390
7560

710
630
9820

1060*
1030
15280

730*
400
7590

350*
800
9660

150
140*
2140

1730*
1370*
25370



NA
NA
NA

METERED
380*
450
6050
160
170
2370

S	2570*	1420*
	2260*	710*
	46650	16030

S	2760*	NA
	2750*	NA
	50550	NA

S	4150*
	3510*
	61060

350*
810
9680

S	2350
	2140*
	38220



Washington State Department of Transportation



6 OF 6

S 188TH ST

S 160TH ST

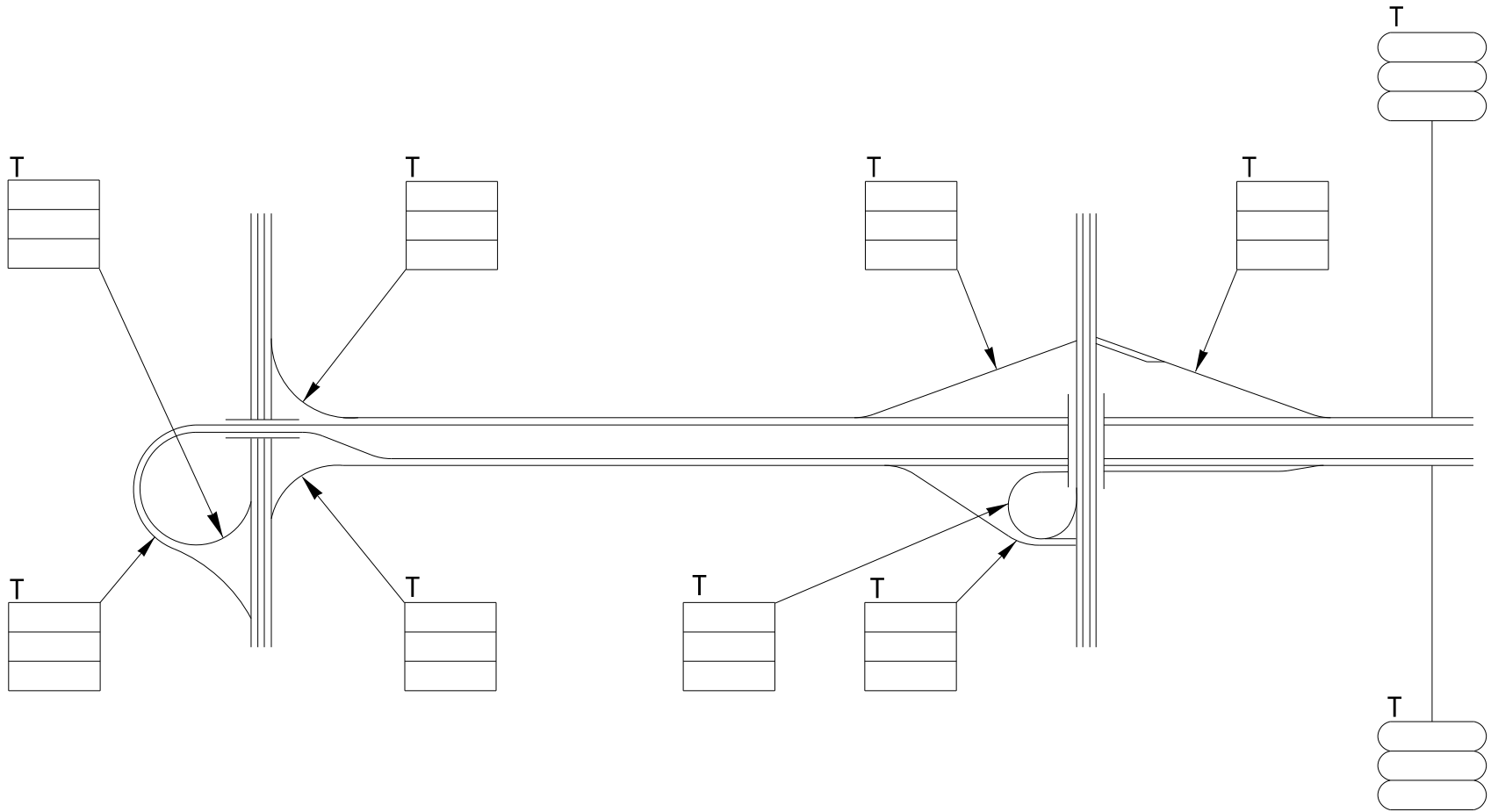

Washington State  
Department of Transportation



509

1  
OF  
4

SR 518  
SW 148TH ST

SW 146TH ST

SW 128TH ST

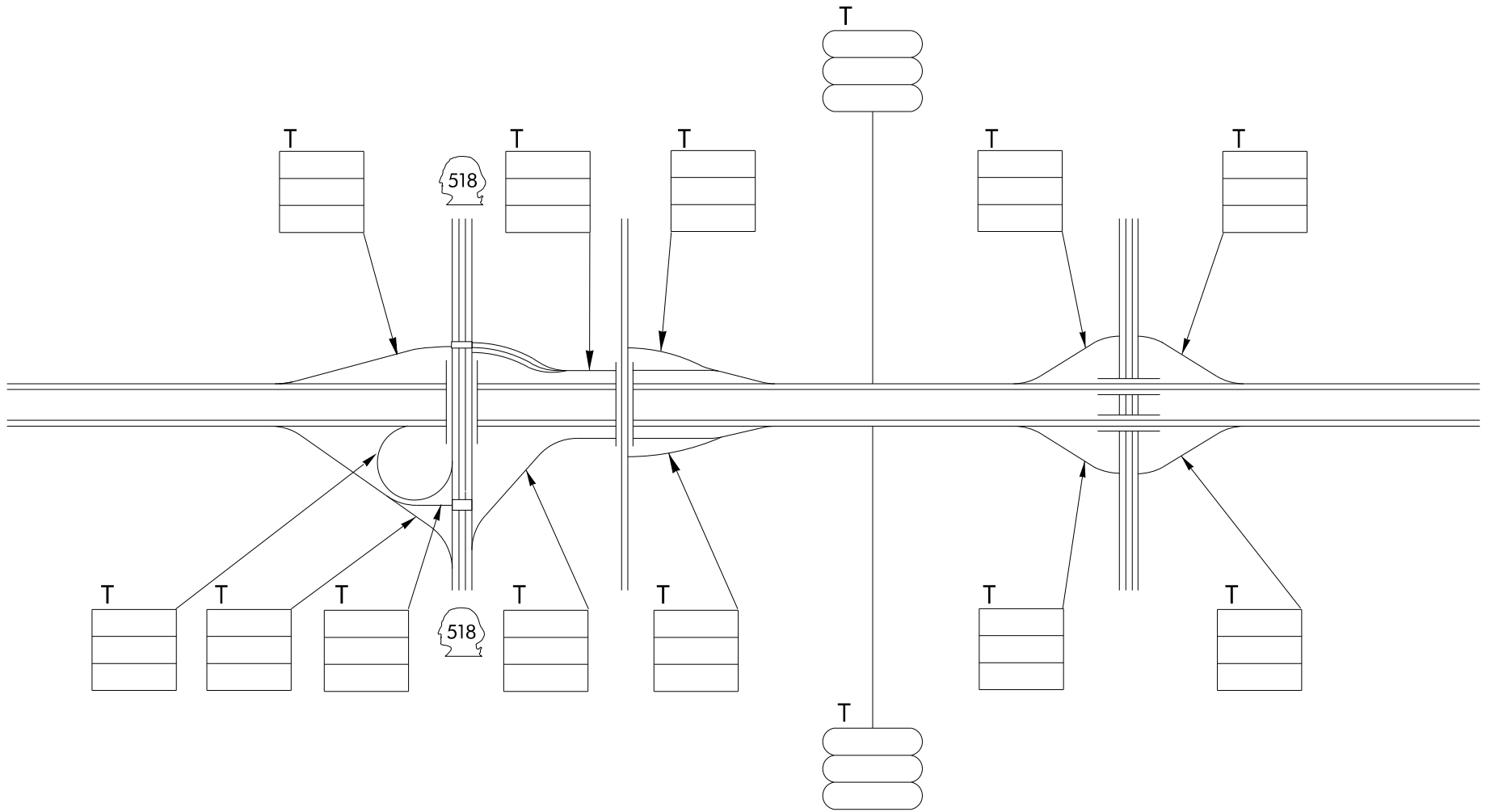



GLENDALE WAY S  
5TH AVE S /S 112TH ST

1ST AVE S  
S CLOVERDALE ST

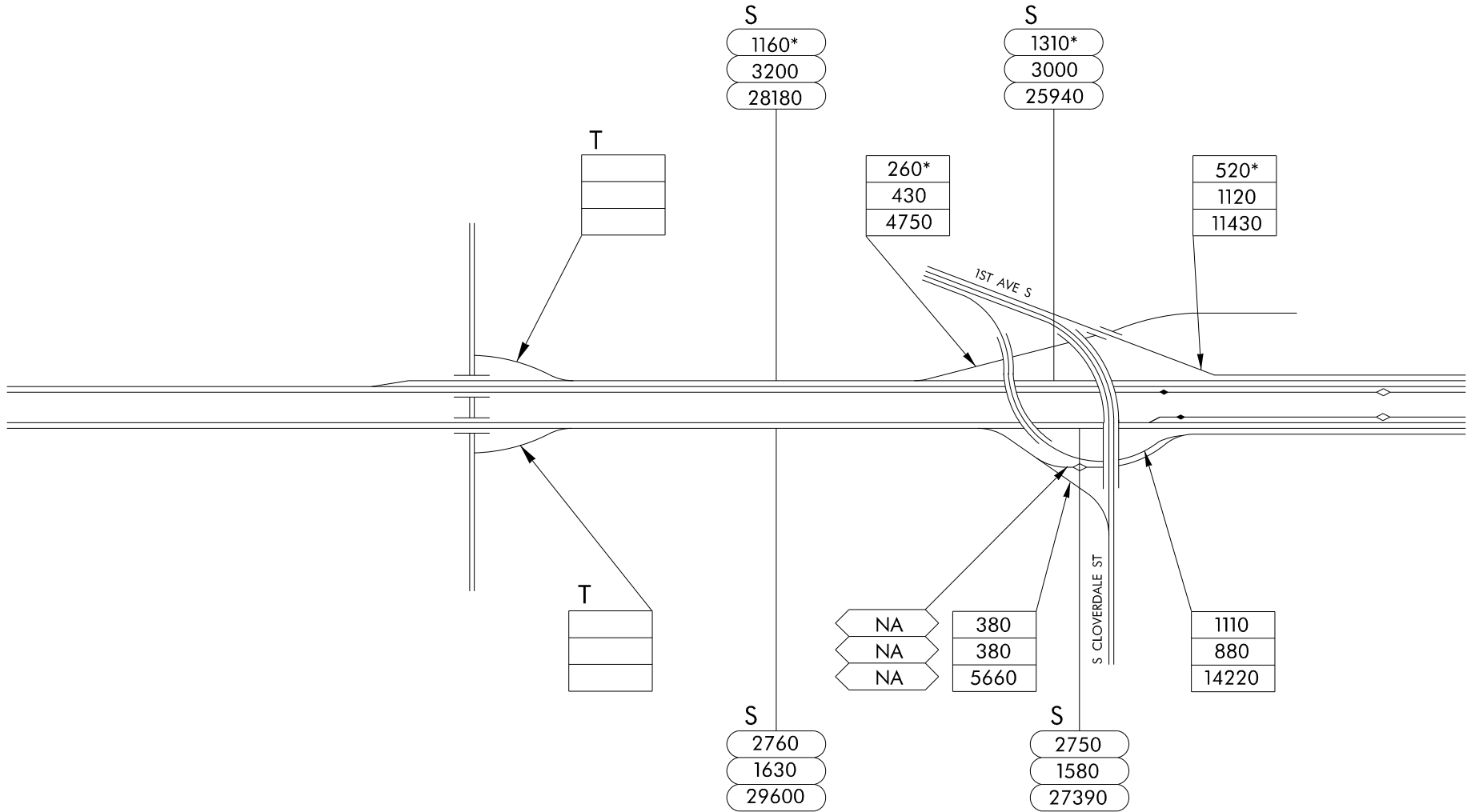

Washington State  
Department of Transportation



3  
OF  
4

SR 509  
S HOLDEN ST



1ST AVE BRIDGE S

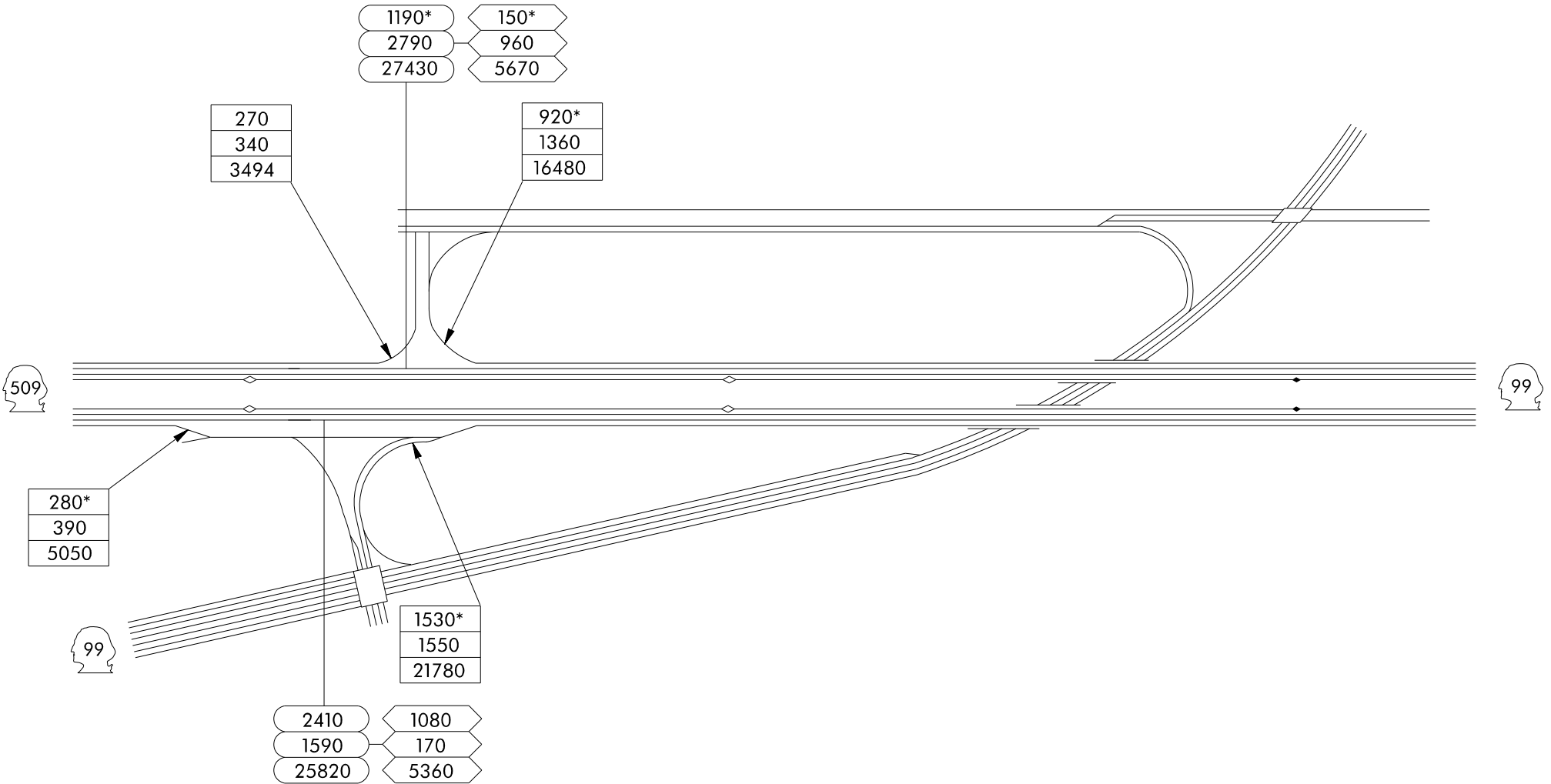

Washington State  
Department of Transportation



4  
OF  
4

1ST AVE S

SR 509

DES MOINES  
MEMORIAL DR S

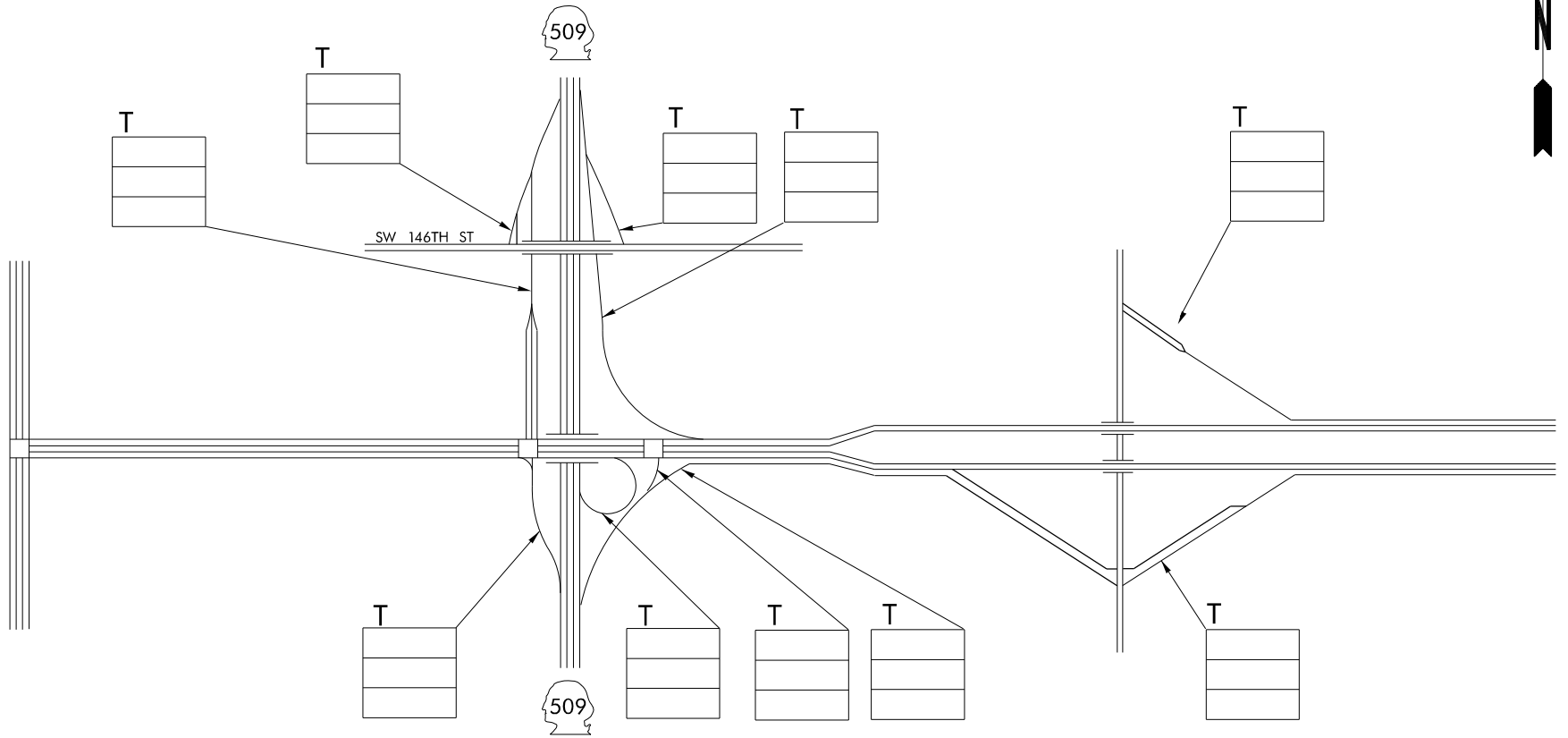

Washington State  
Department of Transportation



1  
OF  
3

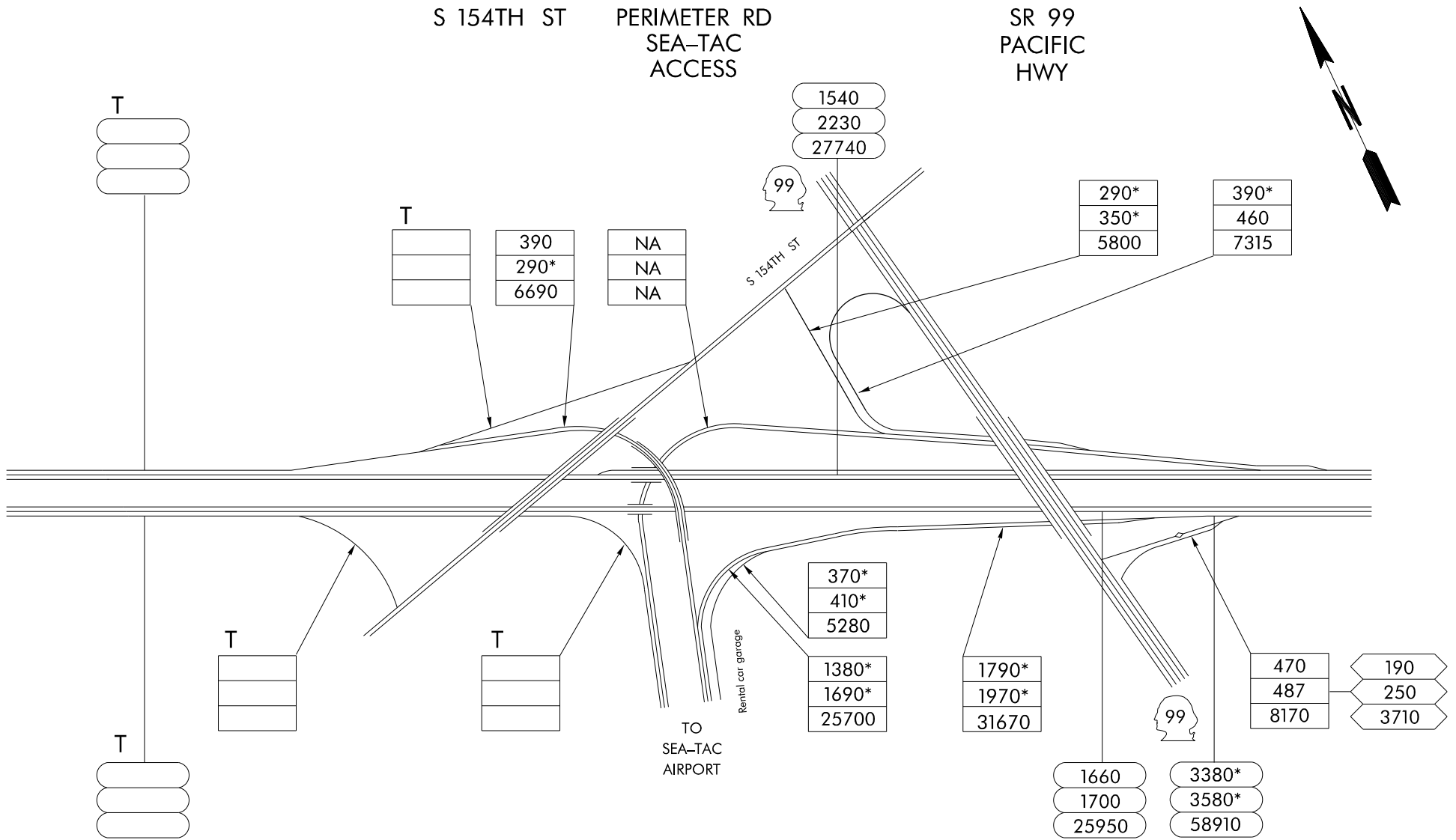

42nd AVE S

51ST AVE S

I-5



4130\*  
4560\*  
69410

3520  
3500  
61680

450\*  
700  
7890

930\*  
960\*  
15880

850  
830\*  
15560

1070\*  
1440\*  
19800



2730  
3020\*  
48950

990  
970  
15890

530\*  
590  
7150



1560  
1670\*  
29894

4480\*  
4630\*  
76710

3780\*  
3930\*  
64800



Washington State  
Department of Transportation



3  
OF  
3

I-5  
E ROANOKE ST

SR 513  
MONTLAKE  
BLVD E

LAKE  
WASHINGTON  
BLVD E

EVERGREEN  
POINT  
FLOATING  
BRIDGE

EVERGREEN  
POINT RD

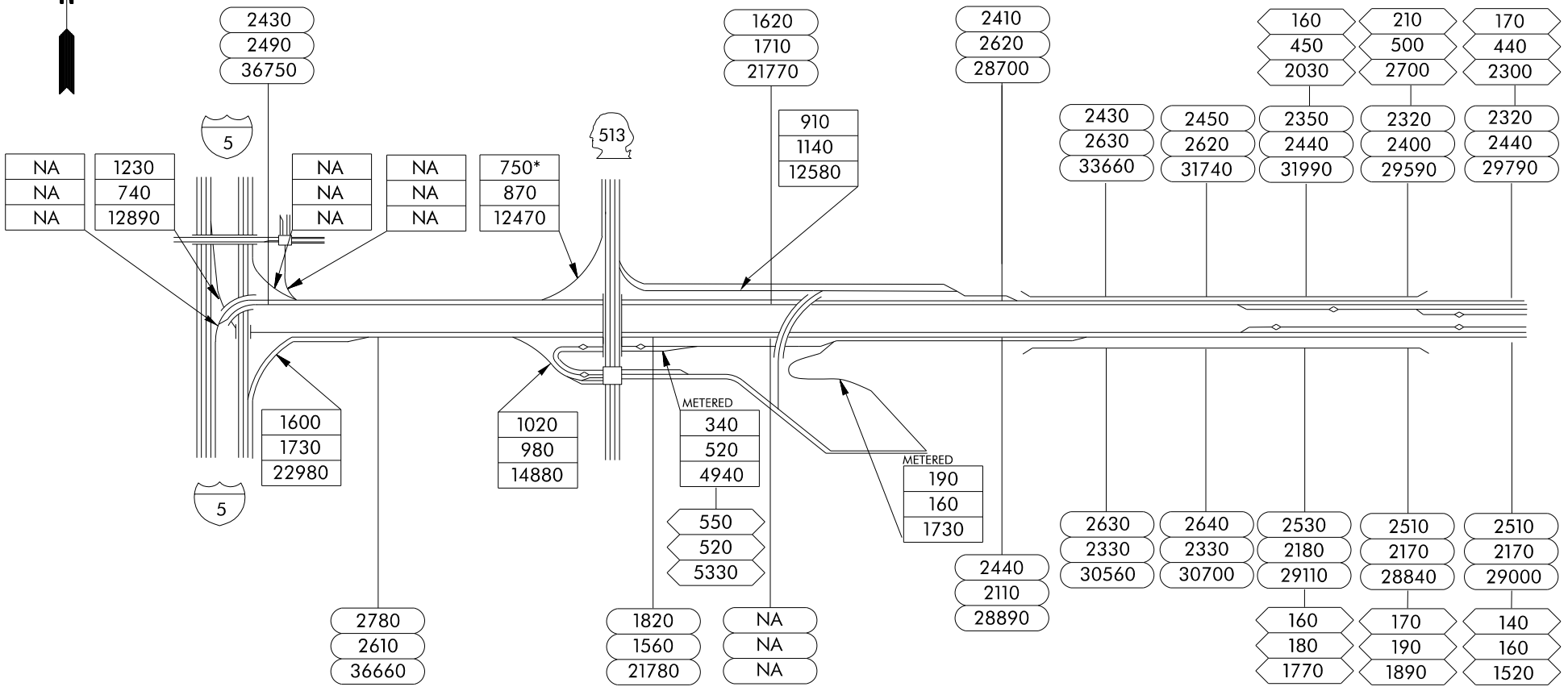

84TH AVE NE

85TH AVE NE

88TH AVE NE

91ST AVE NE

92ND AVE NE

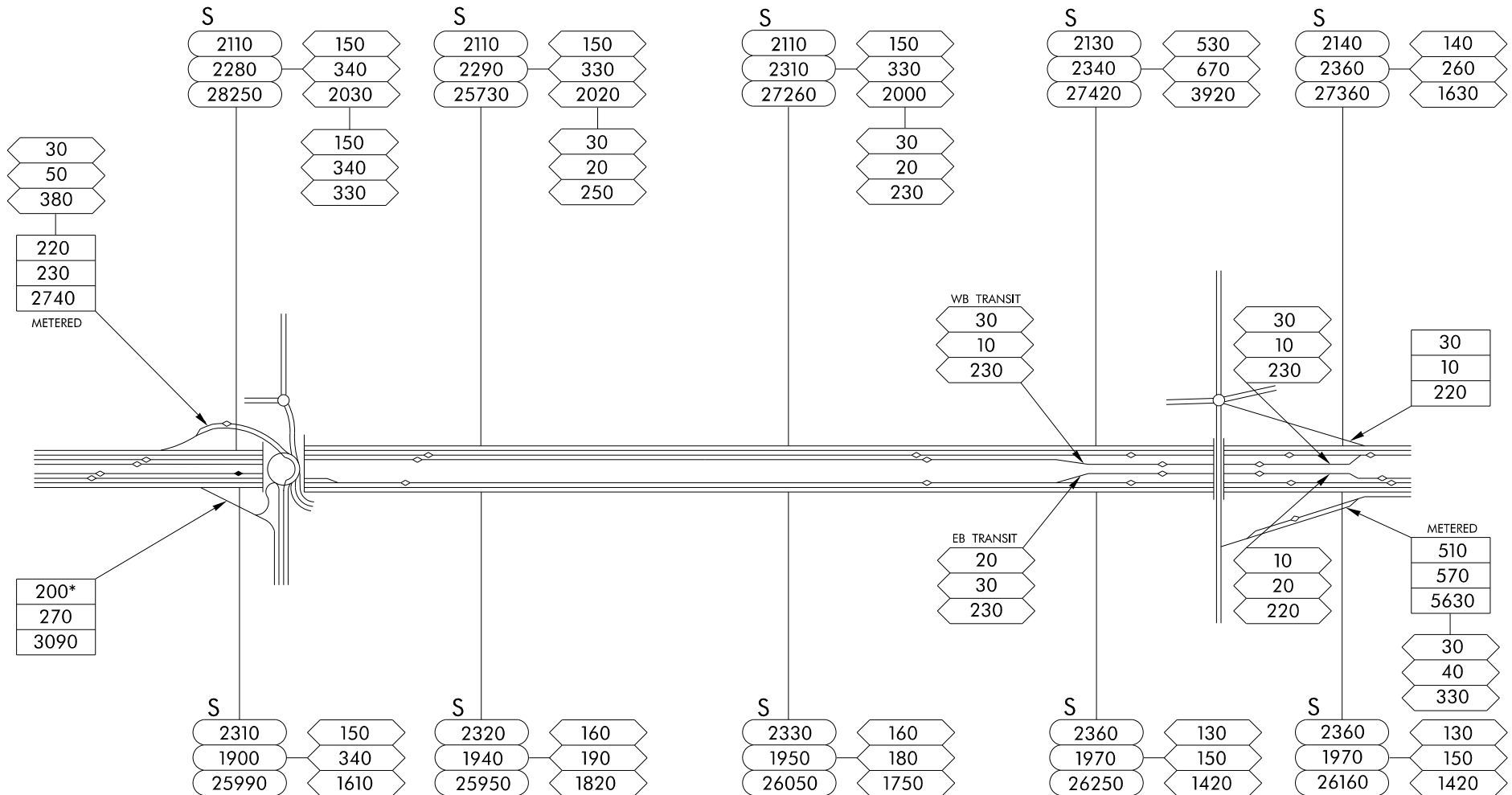

Washington State Department of Transportation



520

2 OF 6

98TH AVE NE

104TH AVE NE  
BELLEVUE WAY

108TH AVE NE 109TH AVE NE

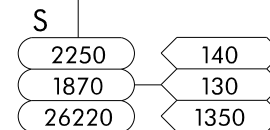
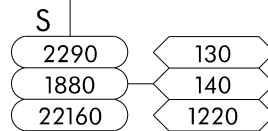
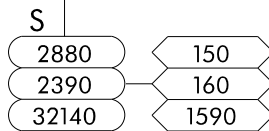
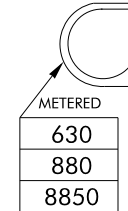
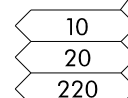
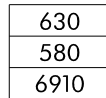
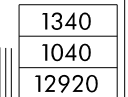
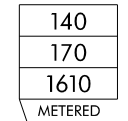
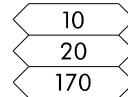
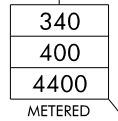
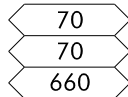
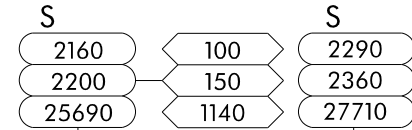
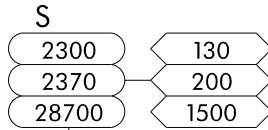
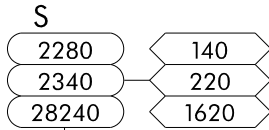

Washington State  
Department of Transportation



520

3  
OF  
6



I-405

124TH AVE NE  
NORTHUP WAY

130TH AVE NE

140TH AVE NE

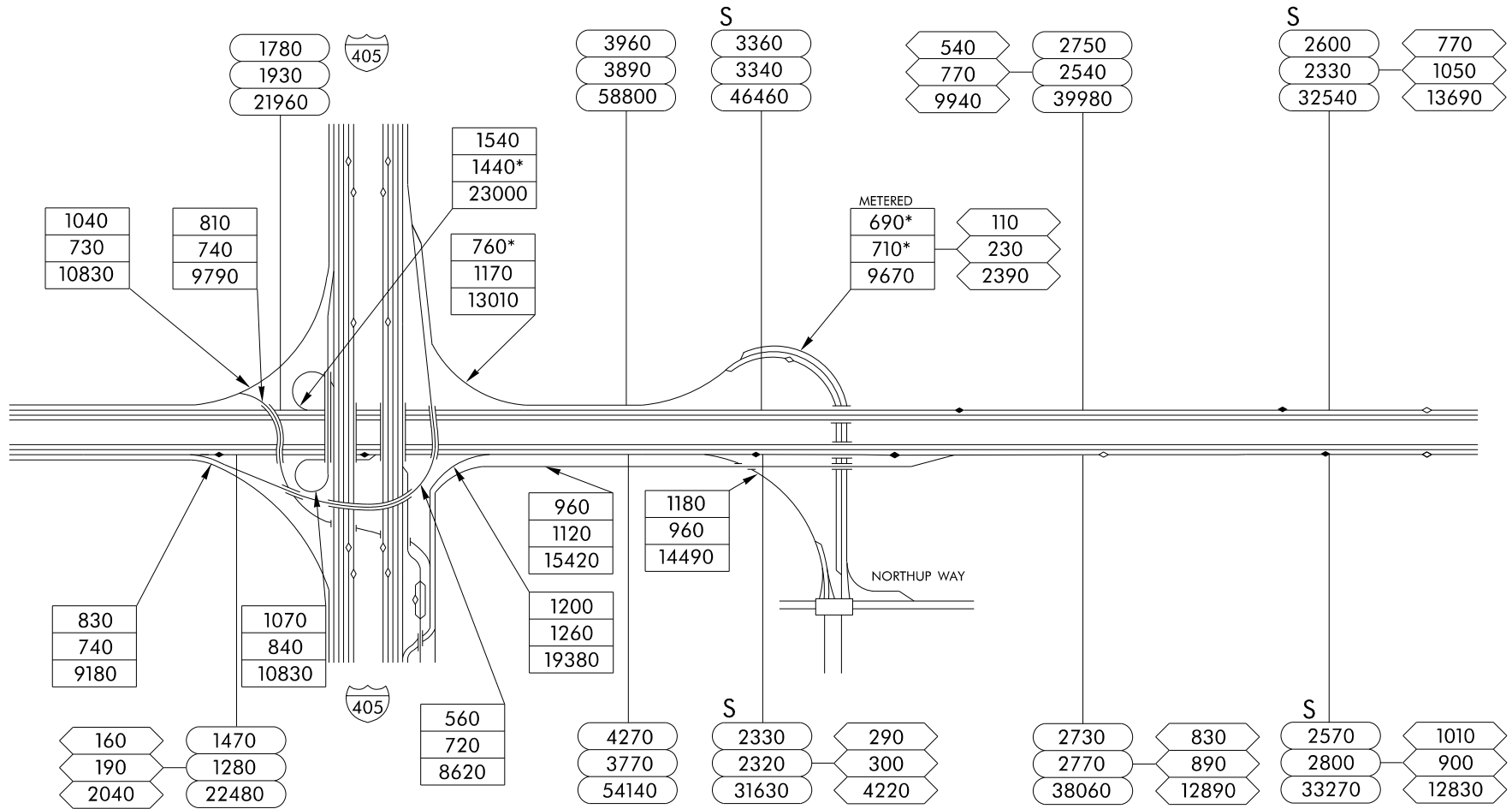

Washington State  
Department of Transportation



520

4  
OF  
6

148TH AVE NE

NE 36TH ST

NE 40TH ST

NE 51ST ST

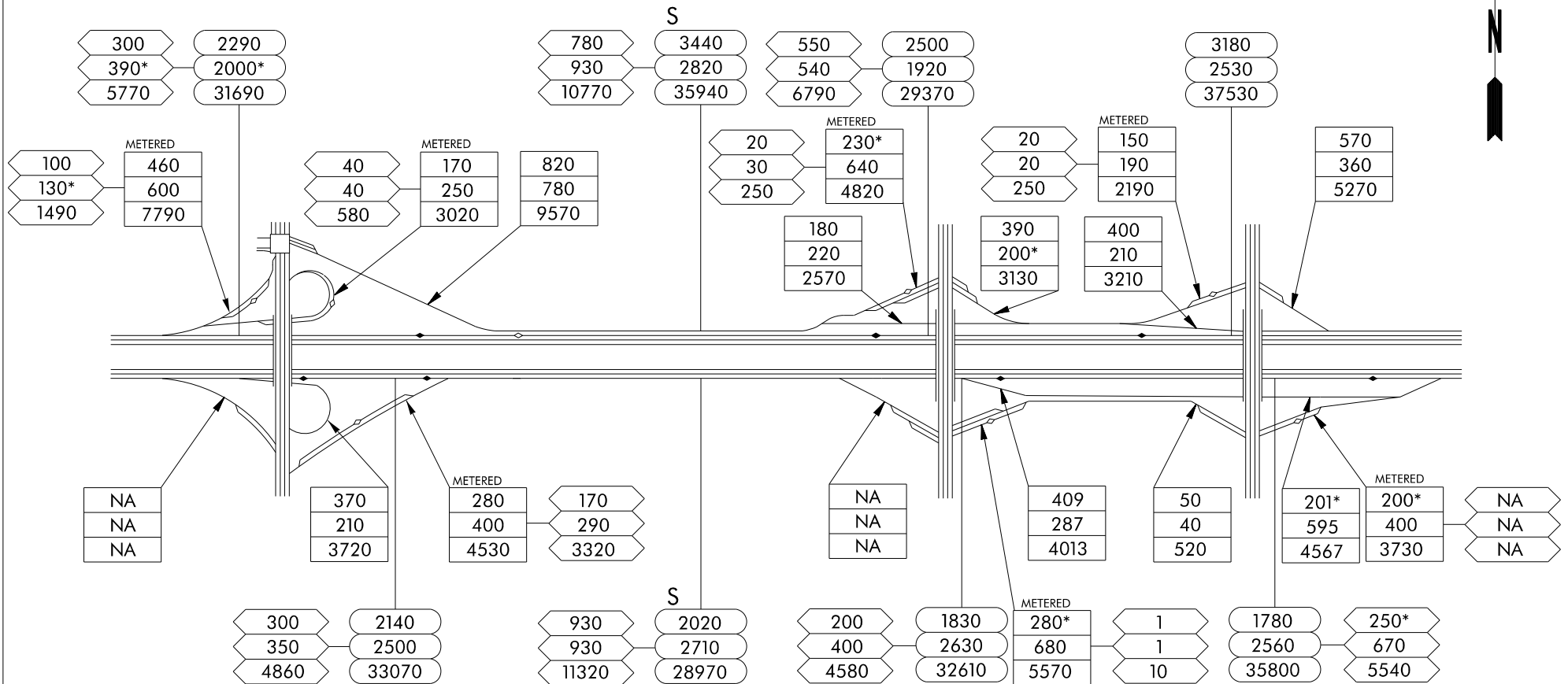

NE 60TH ST

W LAKE  
SAMMAMISH  
PKWY NE  
S

MARYMOOR  
PARK

SR 202  
REDMOND  
WAY

NE 76TH ST



S  
4250  
3150  
46470

3240  
2170  
37270

140  
120  
1390  
1000  
1070  
13890

METERED

3170  
2130  
28480

380  
430  
5200

370  
270  
3210  
1020  
860  
12010

METERED

NA  
NA  
NA  
280  
300\*  
4030

METERED

S  
1750  
1130  
19450

202

S  
1720  
1140  
14330

640\*  
850  
9860

430  
500  
6060

940\*  
1500  
16980

202

90\*  
110  
1200

S  
2470\*  
4120  
40410

S  
1760\*  
3200  
33720

S  
1740  
3170  
30220

S  
1250  
1930  
21100

S  
1240  
1930  
21100

68th Ave NE

83rd PL NE



840  
960  
13320

1120  
1380  
16670

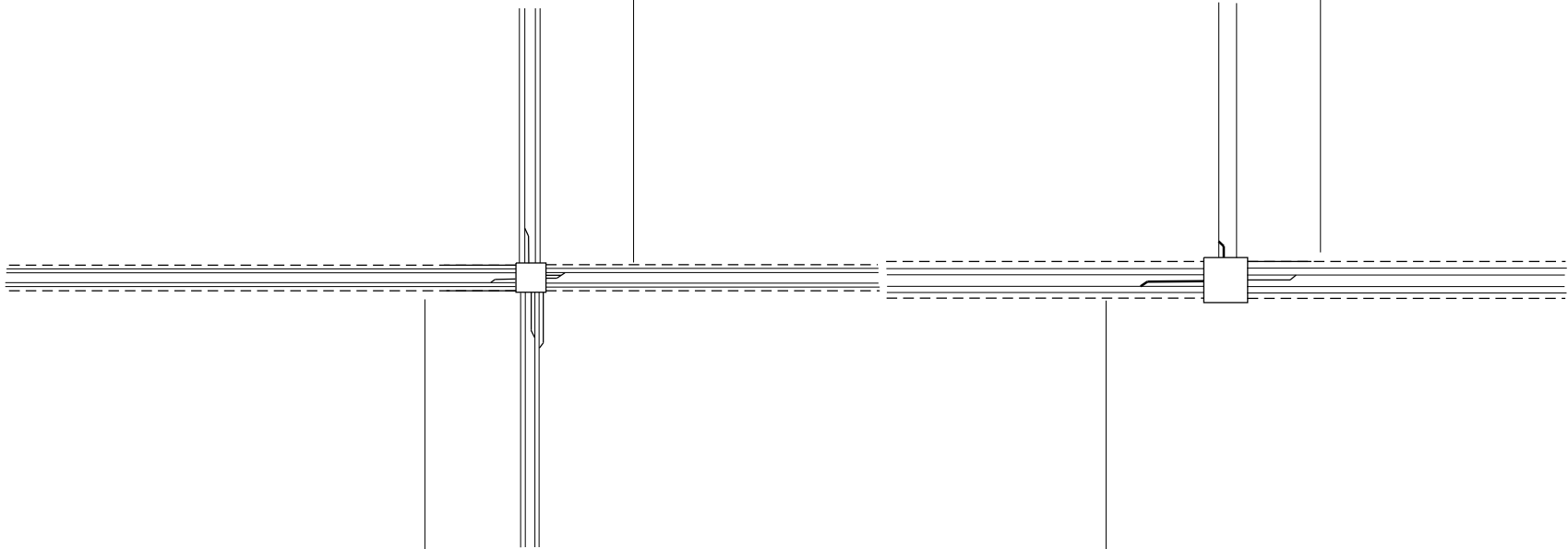

1590  
1630  
22050

1490  
1370  
17990



Washington State  
Department of Transportation



1  
OF  
5

132ND AVE NE  
SR 202



I-405

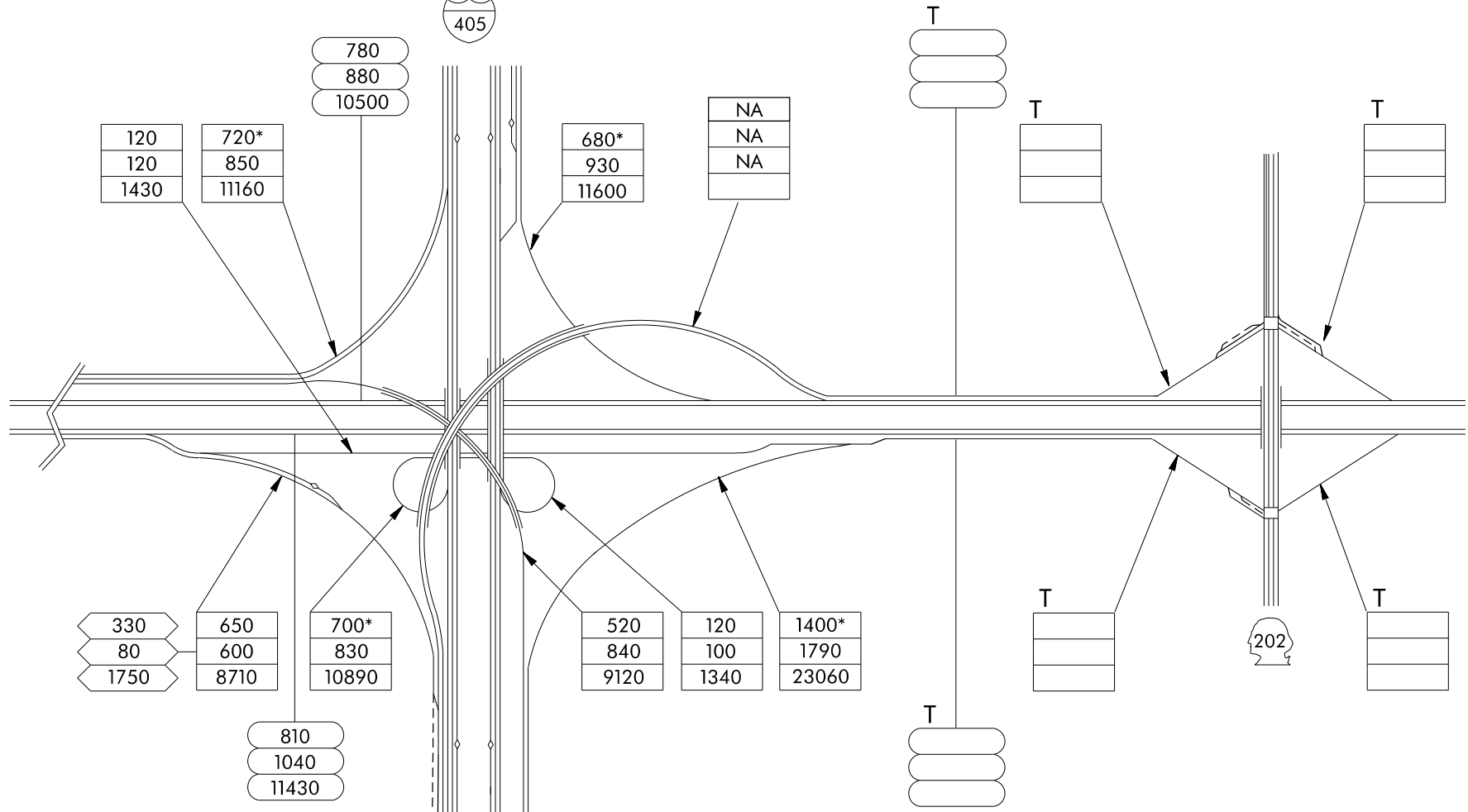

Washington State  
Department of Transportation



522

2  
OF  
5

NE 195TH ST

SR 9  
WOODINVILLE CUT-OFF

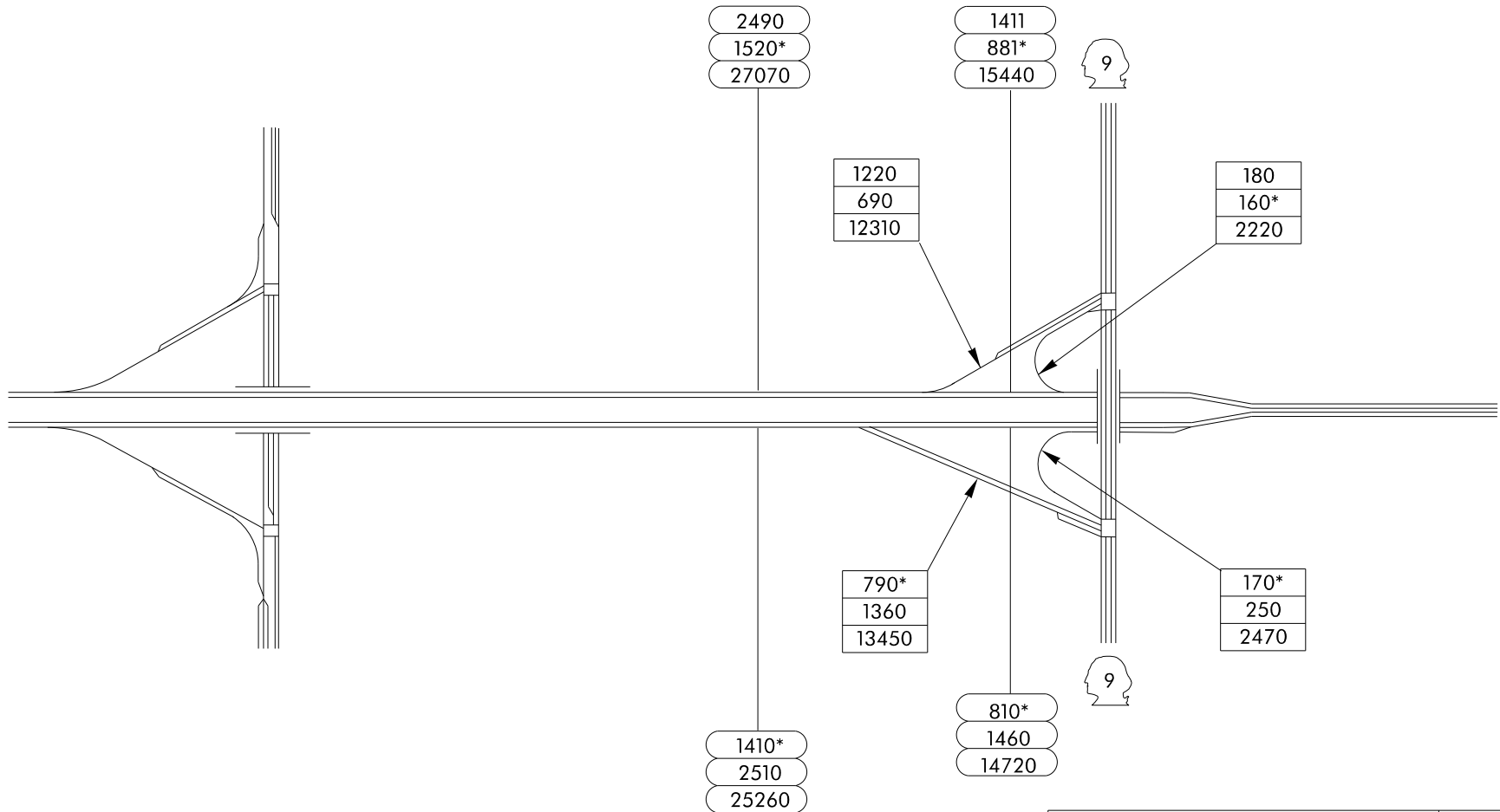

Washington State  
Department of Transportation



3  
OF  
5

Paradise Lake Rd

Echo Lake Rd  
Fales Rd

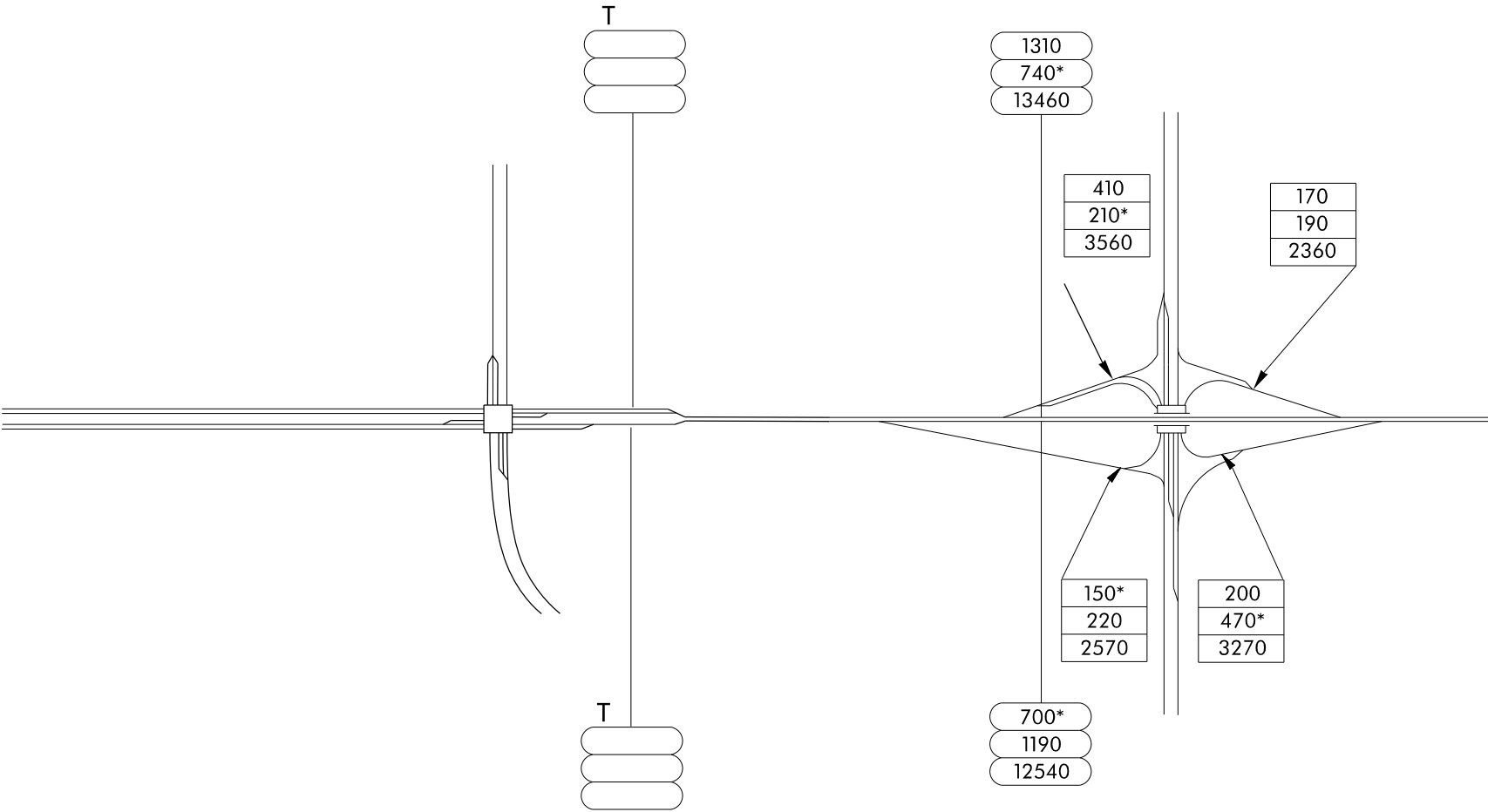

Washington State  
Department of Transportation



522

4  
OF  
5

Snohomish River Bridge

W Main St

US 2

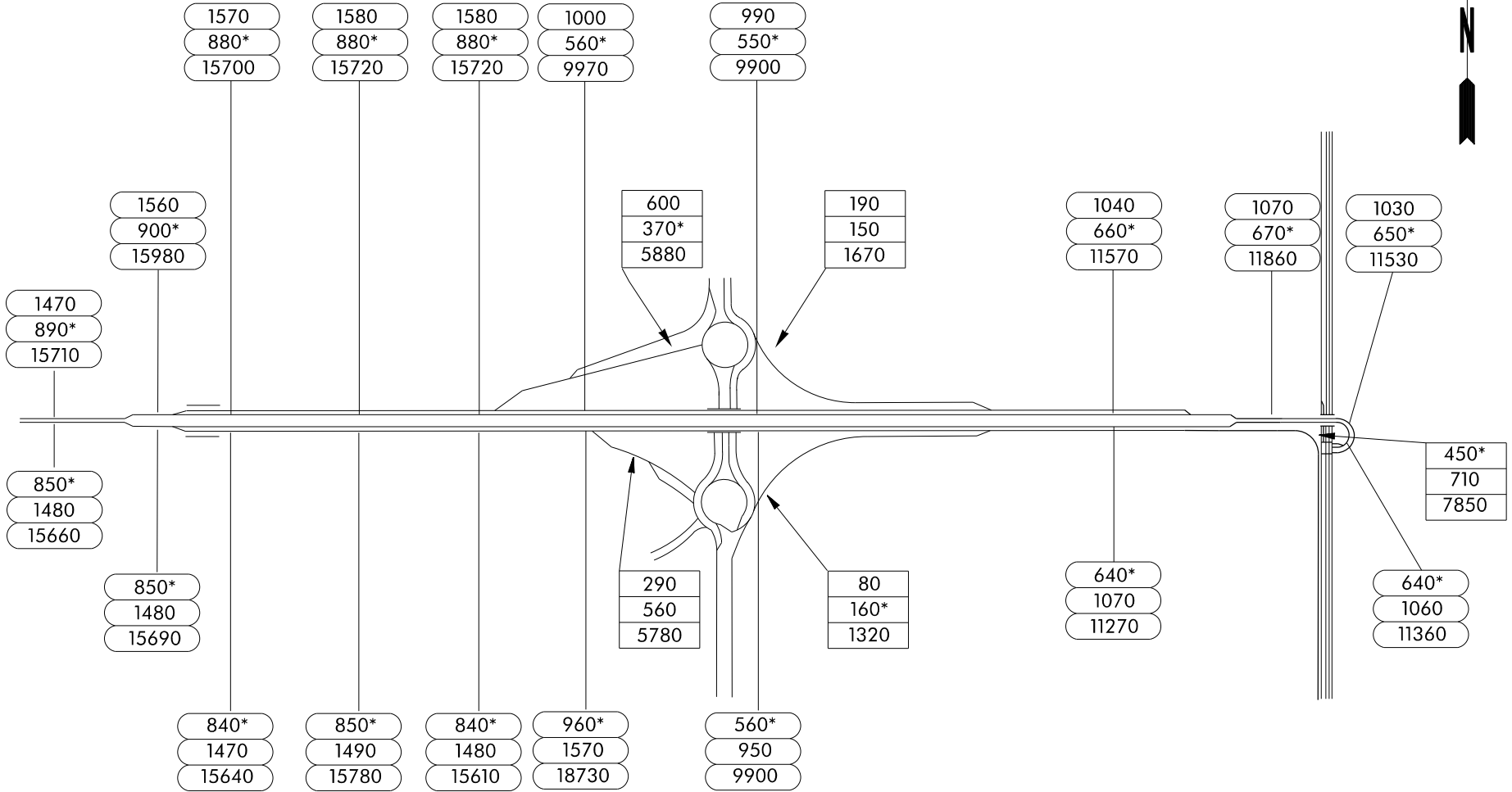

Washington State  
Department of Transportation



522

5  
OF  
5





ALDERWOOD  
MALL PKWY

164TH ST SW

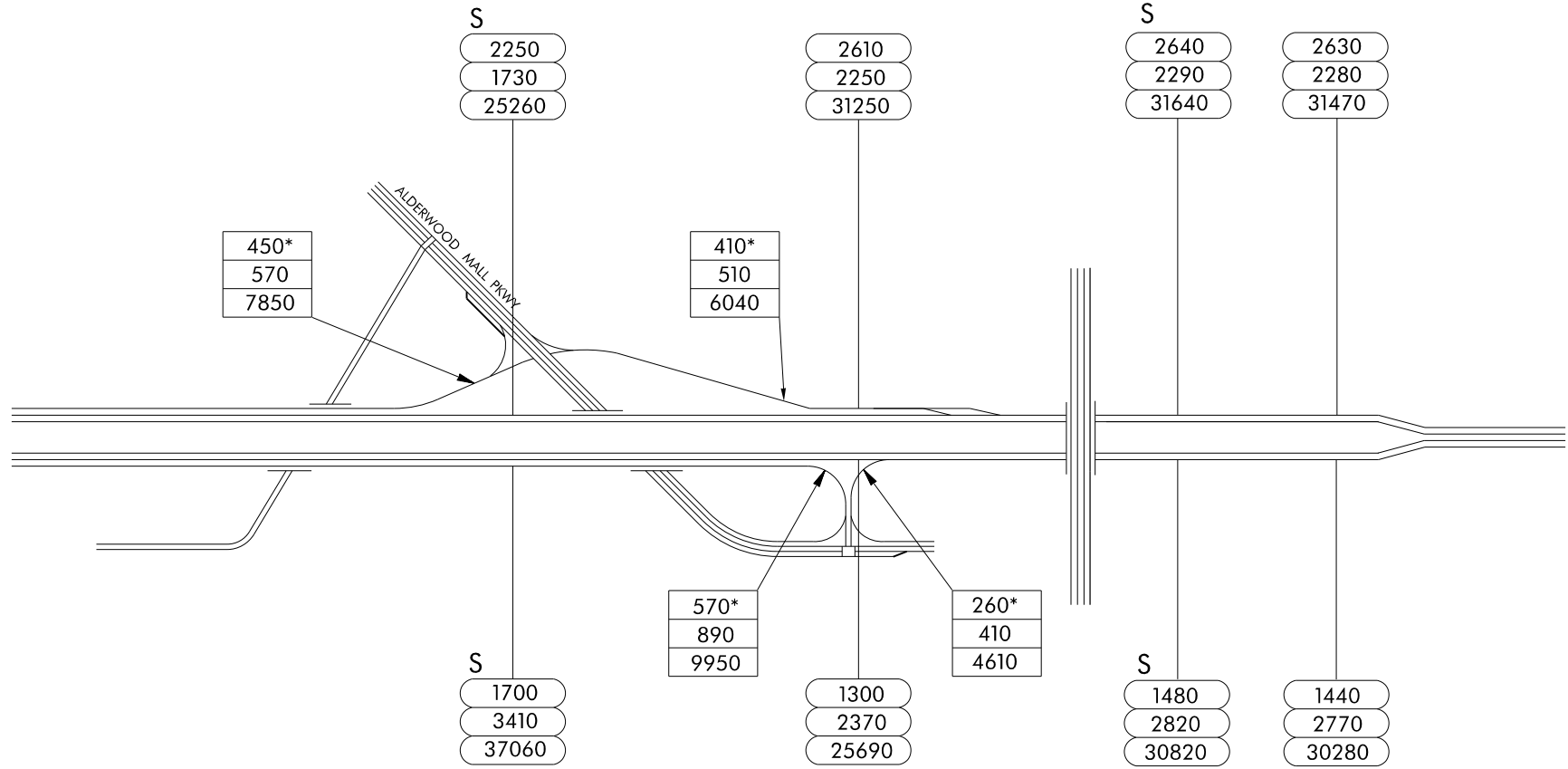

Washington State  
Department of Transportation



1  
OF  
2



SR 99  
PACIFIC HWY

LINCOLN WAY

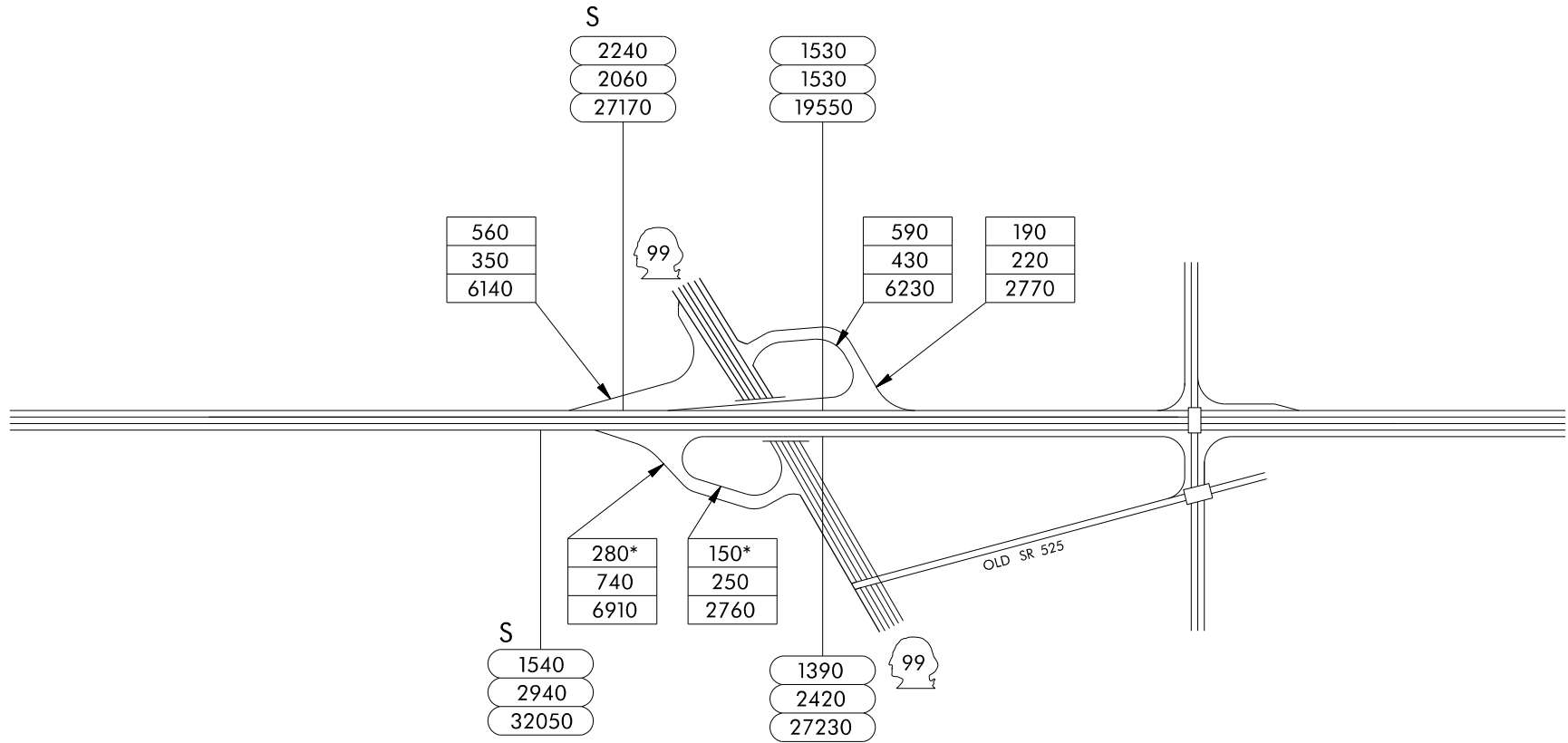

Washington State  
Department of Transportation



2  
OF  
2

AIRPORT RD

SEAWAY BLVD  
20TH AVE W

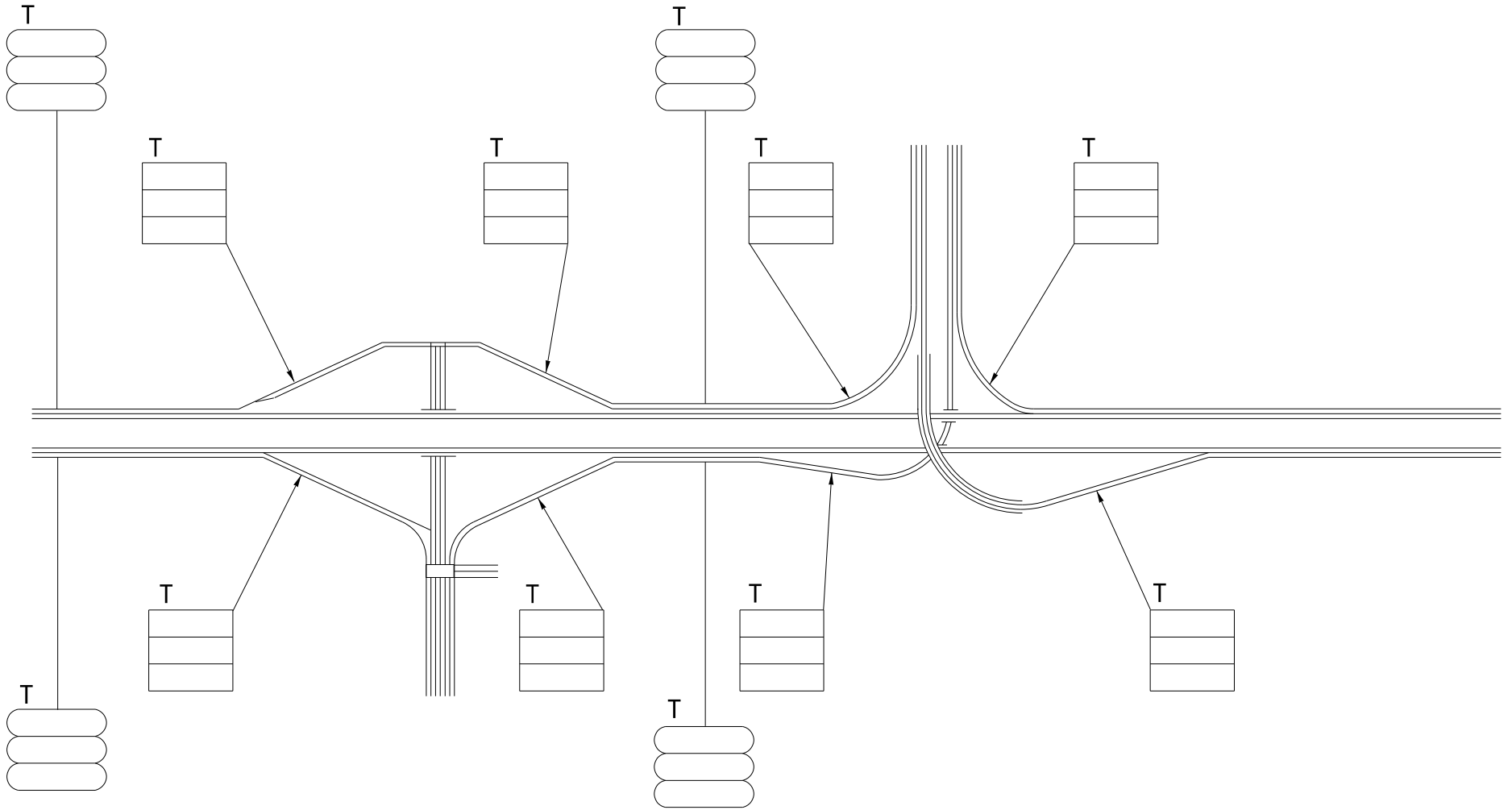

Washington State  
Department of Transportation



526

1  
OF  
2

EVERGREEN WY

I-5

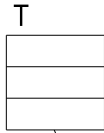
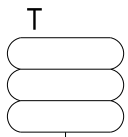

3000  
1860\*  
26170

900  
1200  
15570

1220  
810\*  
13590

1760  
1410\*  
18970



NA  
NA  
NA

NA  
NA  
NA

100  
200  
1950

480  
960  
9980

950\*  
2970  
24300

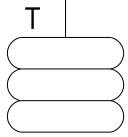

Washington State  
Department of Transportation



2  
OF  
2

I-5

S 133RD ST

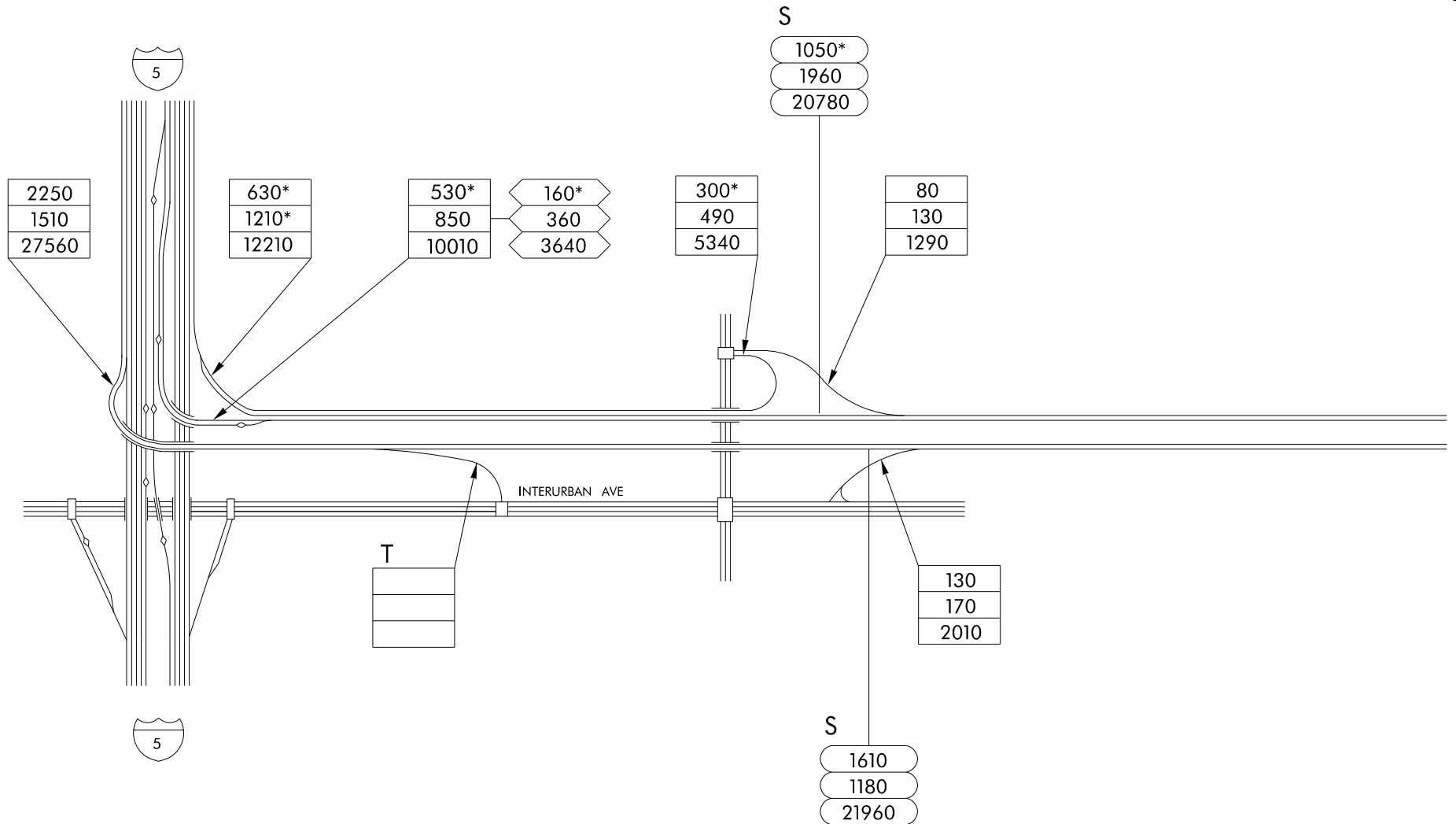
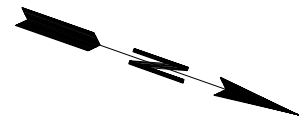

Washington State  
Department of Transportation



599

1  
OF  
2

METRO BUS BARN

SR 99  
TUKWILA INTERNATIONAL BLVD

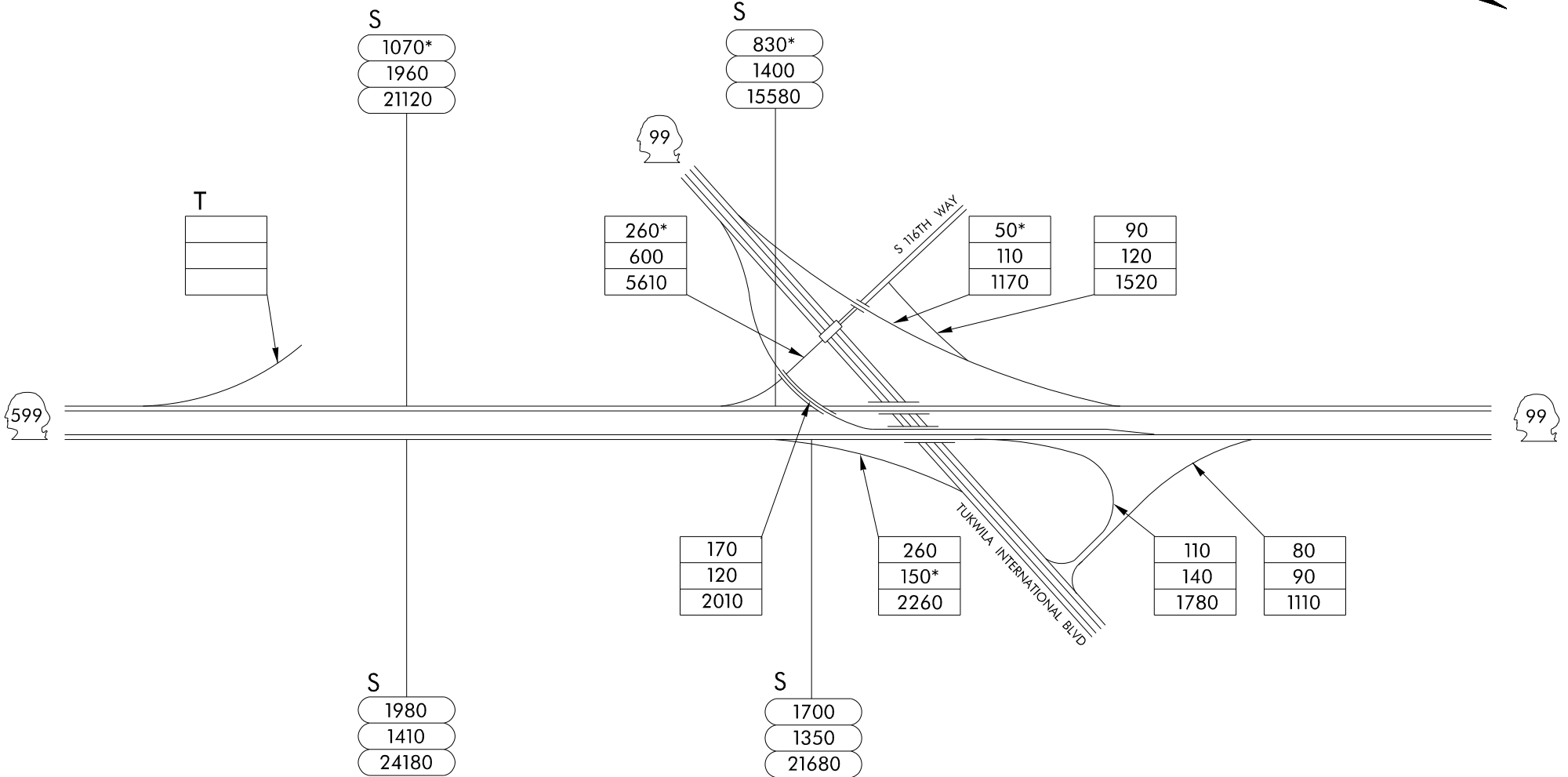
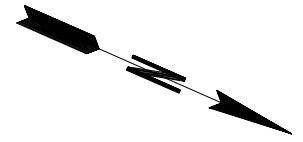

Washington State  
Department of Transportation



2  
OF  
2

Bickford Ave

S

950
940
12660

S

1140
900
13140

SR 9 S

640
840
9950



380*
780
7140

400
240*
4010

170*
310
3050

400
480
6220

30*
60
470

260
360
4350

250
170
2800

S

830
990
12820

S

970
1130
16020

S

660
700
9510



Washington State Department of Transportation



1 OF 2

SR 522

Rice Rd

S  
850\*  
950  
13450

S  
470  
460\*  
6800

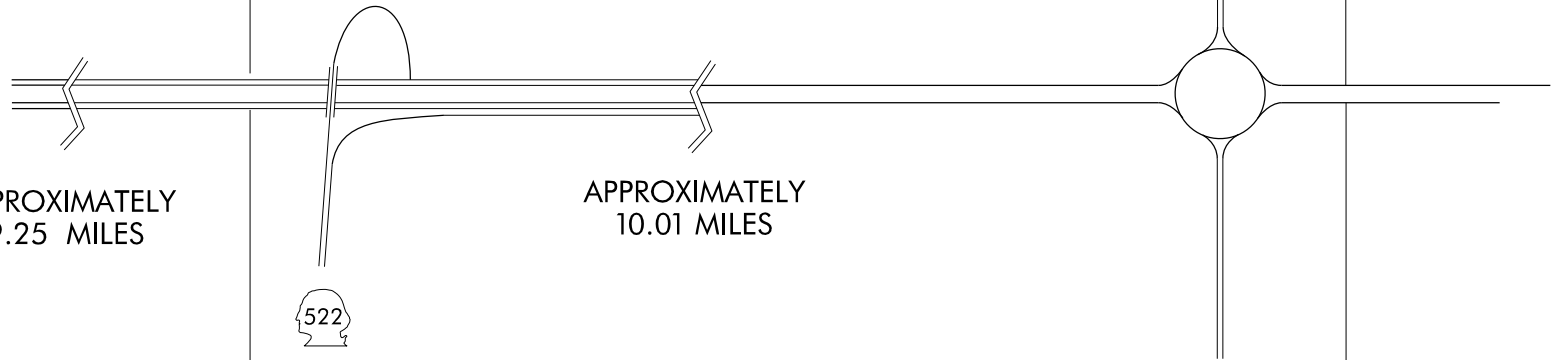

APPROXIMATELY  
9.25 MILES

APPROXIMATELY  
10.01 MILES

S  
920\*  
1160  
14140

S  
440\*  
650  
7020



## APPENDIX

For this 2022 traffic volume summary report, the standard AM and PM peak periods are defined as 6:00 to 9:45 AM and 2:30 to 6:45 PM, respectively. Listed below are the ramp, collector distributor (CD), and mainline stations in which the AM and/or PM peak hourly volumes began outside the above peak periods. They are arranged by types and directions.

Route	Sheet No.	Location	AM	PM
US 2	1 of 2	002es00360:_MW_O_1	11:00 AM	-
		002es00411:_ME_O_1	11:00 AM	-
		002es00504:_MW_O_1	-	1:00 PM
		002es00504:_MW_X_1	11:00 AM	-
	2 of 2	002es01429:_MW_Stn	11:00 AM	-
		002es01429:_ME_Stn	11:00 AM	-
		002es02430:_MW__1	-	1:00 PM
		002es02430:_ME__1	11:00 AM	-
I-5	1 of 32	005es13969:_MN_Stn	5:00 AM	1:00 PM
		005es13969:_MSH_5	11:00 AM	-
		005es14015:_MN_Stn	5:00 AM	1:00 PM
		005es14015:_MSH_5	11:00 AM	-
		005es14064:_MN_Stn	5:00 AM	-
		005es14064:_MSH_5	11:00 AM	-
		005es14064:_MN_O_1	10:00 AM	12:00 PM
		005es14126:_MN_Stn	5:00 AM	1:00 PM
		005es14126:_MNH_5	5:00 AM	-
		005es14126:_MS_Stn	-	2:00 PM
	005es14126:_MSH_5	11:00 AM	-	
	2 of 32	005es14150:_MS_O_1	11:00 AM	-
		005es14150:_MS_O_2	-	1:00 PM
		005es14150:AMW_X_1	11:00 AM	-
		005es14176:_MN_Stn	5:00 AM	1:00 PM
		005es14176:_MNH_5	5:00 AM	-
		005es14176:MMS_Stn	11:00 AM	2:00 PM
		005es14176:_MSH_5	11:00 AM	-
		005es14221:MMN_Stn	5:00 AM	1:00 PM
		005es14221:_MNH_5	5:00 AM	-
		005es14221:_MN_P_1	5:00 AM	1:00 PM
		005es14221:_MN_X_1	-	1:00 PM
		005es14221:_MS_Stn	11:00 AM	2:00 PM
		005es14221:_MSH_5	11:00 AM	-
		005es14221:_MS_X_1	11:00 AM	-
		005es14277:_MN_Stn	11:00 AM	1:00 PM
005es14277:_MNH_5		5:00 AM	-	
005es14277:_MS_Stn	11:00 AM	2:00 PM		
005es14277:_MSH_5	11:00 AM	-		
005es14321:_MN_Stn	5:00 AM	1:00 PM		

	005es14321:_MNH_5	5:00 AM	-
	005es14321:_MS_Stn	11:00 AM	2:00 PM
	005es14321:_MSH_5	11:00 AM	-
	005es14364:_MN_Stn	5:00 AM	1:00 PM
	005es14364:_MNH_5	5:00 AM	-
	005es14364:MMS_Stn	11:00 AM	2:00 PM
	005es14364:_MSHStn	11:00 AM	-
	005es14364:_MSHP_1	11:00 AM	7:00 PM
	005es14364:_MS_P_2	-	2:00 PM
	005es14398:MMN_Stn	5:00 AM	1:00 PM
	005es14398:_MNH_5	5:00 AM	-
	005es14398:_MN_P_2	11:00 AM	-
	005es14398:_MN_P_3	-	2:00 PM
	005es14460:_MN_Stn	5:00 AM	1:00 PM
	005es14460:_MNH_5	5:00 AM	-
	005es14460:_MS_Stn	11:00 AM	-
	005es14460:_MSH_5	11:00 AM	-
3 of 31	005es14522:_MN_Stn	5:00 AM	1:00 PM
	005es14522:_MNH_5	5:00 AM	-
	005es14522:_MS_Stn	11:00 AM	-
	005es14575:_MN_Stn	11:00 AM	1:00 PM
	005es14575:_MNH_5	5:00 AM	-
	005es14575:_MS_Stn	11:00 AM	2:00 PM
	005es14575:_MSH_5	11:00 AM	-
	005es14630:_MN_Stn	5:00 AM	1:00 PM
	005es14630:_MNH_5	5:00 AM	-
	005es14630:_MS_Stn	11:00 AM	-
	005es14630:_MSH_5	11:00 AM	-
	005es14676:MMS_Stn	11:00 AM	2:00 PM
	005es14676:_MSH_5	11:00 AM	-
	005es14701:MMN_Stn	5:00 AM	1:00 PM
	005es14701:_MNH_5	5:00 AM	-
	005es14701:_MNBD_1	-	1:00 PM
	005es14701:_MN_P_2	5:00 AM	1:00 PM
	005es14727:DMN_Stn	5:00 AM	1:00 PM
4 of 31	005es14771:_MN_Stn	5:00 AM	1:00 PM
	005es14771:_MNH_5	5:00 AM	-
	005es14771:_MS_Stn	11:00 AM	-
	005es14771:_MSH_5	11:00 AM	-
	005es14807:_MN_Stn	5:00 AM	1:00 PM
	005es14807:_MS_Stn	11:00 AM	-
	005es14807:_MSH_5	11:00 AM	-
	005es14868:_MN_Stn	5:00 AM	1:00 PM
	005es14868:_MNH_5	5:00 AM	-
	005es14868:_MS_Stn	11:00 AM	2:00 PM
	005es14868:_MSH_5	11:00 AM	-

	005es14905:MMS_Stn	11:00 AM	2:00 PM
	005es14905:_MSH__5	11:00 AM	-
	005es14905:_MS_P_1	11:00 AM	-
	005es14905:_MSBD_1	10:00 AM	2:00 PM
	005es14906:MMN_Stn	5:00 AM	1:00 PM
	005es14906:_MNH__5	5:00 AM	-
	005es14906:_MN_P_1	-	1:00 PM
	005es14937:MMN_Stn	5:00 AM	1:00 PM
	005es14937:_MNH__5	5:00 AM	-
	005es14937:_MN_P_1	-	1:00 PM
	005es15036:_MN_Stn	5:00 AM	1:00 PM
	005es15036:_MS_Stn	11:00 AM	2:00 PM
	005es15036:_MSH__5	11:00 AM	-
5 of 31	005es15125:_MN_Stn	5:00 AM	1:00 PM
	005es15125:MMS_Stn	11:00 AM	2:00 PM
	005es15125:_MSH__5	11:00 AM	-
	005es15125:_MS_P_2	11:00 AM	-
	005es15214:_MN_Stn	5:00 AM	1:00 PM
	005es15214:MMS_Stn	11:00 AM	2:00 PM
	005es15214:_MSH__5	11:00 AM	-
	005es15214:_MS_P_2	11:00 AM	-
	005es15280:_MS_Stn	11:00 AM	2:00 PM
	005es15280:_MSH__6	11:00 AM	-
	005es15315:_MN_Stn	-	1:00 PM
	005es15315:_MS_Stn	11:00 AM	2:00 PM
	005es15315:_MSH__6	11:00 AM	-
6 of 31	005es15348:_MN_Stn	-	1:00 PM
	005es15348:_MS_Stn	11:00 AM	2:00 PM
	005es15348:_MSH__7	11:00 AM	-
	005es15410:MMS_Stn	11:00 AM	2:00 PM
	005es15410:_MS_P_2	11:00 AM	1:00 PM
	005es15465:_MN_Stn	-	1:00 PM
	005es15465:_MN_O_2	11:00 AM	1:00 PM
	005es15465:_MS_Stn	11:00 AM	2:00 PM
	005es15465:_MSH__6	11:00 AM	-
	005es15465:_MS_X_1	11:00 AM	-
	005es15465:_MS_X_2	-	12:00 PM
	005es15480:MMN_Stn	-	1:00 PM
	005es15480:_MN_P_1	11:00 AM	-
7 of 31	005es15531:_MN_Stn	-	1:00 PM
	005es15531:_MNH__6	-	1:00 PM
	005es15531:_MS_Stn	11:00 AM	2:00 PM
	005es15531:_MSH__7	11:00 AM	2:00 PM
	005es15569:_MN_Stn	-	1:00 PM
	005es15569:_MNH__5	-	1:00 PM
	005es15569:MMS_Stn	11:00 AM	2:00 PM

	005es15569:_MSH__6	11:00 AM	2:00 PM
	005es15587:MMS_Stn	11:00 AM	2:00 PM
	005es15587:_MS_P_1	11:00 AM	2:00 PM
	005es15608:MMN_Stn	-	1:00 PM
	005es15608:_MNH__5	-	1:00 PM
	005es15608:_MS_Stn	11:00 AM	2:00 PM
	005es15608:_MSH__5	11:00 AM	2:00 PM
	005es15608:_MS_X_1	11:00 AM	-
	005es15652:_MN_Stn	-	1:00 PM
	005es15652:_MNH__5	-	1:00 PM
	005es15652:_MS_Stn	11:00 AM	2:00 PM
	005es15652:_MSH__5	11:00 AM	-
8 of 31	005es15723:MMS_Stn	11:00 AM	2:00 PM
	005es15723:_MSH__5	11:00 AM	-
	005es15723:_MS_P_1	11:00 AM	1:00 PM
	005es15792:MMN_Stn	-	1:00 PM
	005es15792:_MNH__5	-	1:00 PM
	005es15792:_MN_P_1	11:00 AM	2:00 PM
	005es15792:_MN_X_1	-	1:00 PM
	005es15792:_CN_X_1	-	1:00 PM
	005es15792:_MS_Stn	11:00 AM	2:00 PM
	005es15792:_MSH__5	11:00 AM	-
	005es15845:_MNH__5	-	1:00 PM
	005es15845:_MS_Stn	11:00 AM	-
	005es15845:_MSH__5	11:00 AM	-
	005es15892:_MN_Stn	-	1:00 PM
	005es15892:_MNH__5	-	1:00 PM
	005es15892:_MS_Stn	11:00 AM	-
	005es15892:_MSH__5	11:00 AM	-
	005es15957:_MN_Stn	-	2:00 PM
	005es15957:_MNH__5	-	1:00 PM
	005es15957:_MS_Stn	11:00 AM	-
	005es15957:_MSH__5	11:00 AM	-
9 of 31	005es15996:_MNH__5	-	1:00 PM
	005es15996:_MS_Stn	11:00 AM	-
	005es15996:_MSH__5	11:00 AM	-
	005es16064:_MN_Stn	-	1:00 PM
	005es16064:_MNH__5	-	1:00 PM
	005es16064:_MS_Stn	11:00 AM	2:00 PM
	005es16064:_MSH__5	11:00 AM	-
	005es16107:MMS_Stn	11:00 AM	-
	005es16107:_MSH__5	11:00 AM	-
	005es16107:_MS_P_1	11:00 AM	-
	005es16107:_MSHP_2	11:00 AM	-
	005es16120:MMN_Stn	-	1:00 PM
	005es16120:_MNH__5	-	1:00 PM

	005es16120:_MN_P_1	11:00 AM	-
	005es16147:MMN_Stn	5:00 AM	1:00 PM
	005es16147:_MN_P_1	11:00 AM	2:00 PM
	005es16147:_MN_X_1	-	12:00 PM
	005es16186:_MN_Stn	-	1:00 PM
	005es16186:_MS_Stn	11:00 AM	-
	005es16186:_MSH_5	11:00 AM	-
	005es16186:_MS_X_1	-	12:00 PM
10 of 31	005es16272:MMS_Stn	11:00 AM	2:00 PM
	005es16272:_MSH_5	11:00 AM	-
	005es16272:_MS_O_1	11:00 AM	-
	005es16302:_MN_Stn	-	1:00 PM
	005es16302:_MN_O_1	11:00 AM	2:00 PM
	005es16302:_MSH_4	11:00 AM	-
	005es16396:_MS_Stn	-	1:00 PM
	005es16396:_MSH_5	10:00 AM	-
11 of 31	005es16429:MMS_Stn	-	1:00 PM
	005es16429:_MSH_3	10:00 AM	-
	005es16429:_MS_P_2	11:00 AM	2:00 PM
	005es16429:_CS_X_1	-	12:00 PM
	005es16442:_MS_P_1	11:00 AM	-
	005es16466:MMN_Stn	5:00 AM	-
	005es16466:_MN_Stn	-	1:00 PM
	005es16466:_CN_P_2	11:00 AM	2:00 PM
	005es16466:_MS_Stn	-	1:00 PM
	005es16466:_MSH_3	10:00 AM	-
	005es16513:_MN_Stn	11:00 AM	2:00 PM
	005es16513:_MS_Stn	11:00 AM	1:00 PM
	005es16513:_CS_O_1	11:00 AM	-
12 of 31	005es16551:_MN_Stn	-	12:00 PM
	005es16551:_MN_O_2	-	9:00 PM
	005es16551:_MN_X_1	-	1:00 PM
	005es16551:_MS_Stn	11:00 AM	1:00 PM
	005es16551:_MSH_3	11:00 AM	-
	005es16551:_CS_O_1	11:00 AM	-
	005es16583:_MS_Stn	-	12:00 PM
13 of 31	005es16640:_MN_X_1	11:00 AM	-
	005es16640:_MS_Stn	-	12:00 PM
	005es16661:MMS_Stn	-	12:00 PM
	005es16661:_MS_P_1	11:00 AM	2:00PM
	005es16661:_MS_P_2	-	7:00 PM
	005es16701:_MS_Stn	11:00 AM	12:00 PM
14 of 31	005es16732:_MS_Stn	-	12:00 PM
	005es16756:MMS_Stn	11:00 AM	12:00 PM
	005es16802:_MS_Stn	11:00 AM	12:00 PM
	005es16831:_MS_Stn	-	12:00 PM

	005es16885:_MS_Stn	-	12:00 PM
15 of 31	005es16919:_MS_P_2	10:00 AM	8:00 PM
	005es16919:MMS_Stn	-	12:00 PM
	005es16920:_MN_Stn	10:00 AM	-
	005es16942:MMS_Stn	-	12:00 PM
	005es16942:_MS_P_1	-	7:00 PM
	005es16944:MMN_Stn	10:00 AM	-
	005es16944:_MN_P_1	11:00 AM	2:00 PM
	005es16944:_MNHP_1	11:00 AM	-
	005es16977:MMN_Stn	10:00 AM	-
	005es16977:_MNHP_1	11:00 AM	-
	005es16990:MMS_Stn	-	12:00 PM
	005es16990:_MS_P_1	-	12:00 PM
	005es17025:_MN_X_1	11:00 AM	-
	005es17025:_MS_Stn	-	12:00 PM
16 of 31	005es17075:_MS_Stn	-	12:00 PM
	005es17075:_MS_P_1	-	12:00 PM
	005es17131:_MN_Stn	10:00 AM	2:00 PM
	005es17131:_MN_X_1	11:00 AM	-
	005es17131:MMS_Stn	11:00 AM	12:00 PM
	005es17131:_MS_P_2	-	9:00 PM
	005es17131:_MSVP_1	-	12:00 PM
	005es17162:_MS_Stn	-	12:00 PM
	005es17163:MMN_Stn	10:00 AM	2:00 PM
005es17163:_MN_P_1	-	1:00 PM	
005es17163:_MNHP_1	11:00 AM	-	
17 of 31	005es17215:_MS_Stn	11:00 AM	-
	005es17264:_MN_Stn	11:00 AM	-
	005es17264:UMS_Stn	-	2:00 PM
	005es17264:_CS__1	11:00 AM	12:00 PM
	005es17264:_CS_P_1	-	12:00 PM
	005es17264:_CSHP_2	-	12:00 PM
	005es17289:MMN_Stn	11:00 AM	2:00 PM
	005es17289:_MNH_5	11:00 AM	-
	005es17289:_MN_P_2	11:00 AM	2:00 PM
	005es17289:_MNHP_2	11:00 AM	-
	005es17328:_MN_Stn	11:00 AM	2:00 PM
	005es17328:_MNH_6	11:00 AM	-
	005es17375:_MN_Stn	11:00 AM	2:00 PM
005es17375:_MNH_5	11:00 AM	-	
18 of 31	005es17416:_MN_Stn	11:00 AM	2:00 PM
	005es17458:MMN_Stn	11:00 AM	2:00 PM
	005es17458:_MNH_5	11:00 AM	-
	005es17458:_MN_P_2	11:00 AM	1:00 PM
	005es17458:_MNHP_1	11:00 AM	-
	005es17458:_CNHX_1	-	12:00 PM

	005es17508:_MN_Stn	11:00 AM	-
	005es17508:_MNH_5	11:00 AM	-
	005es17551:_MN_Stn	12:00 PM	2:00 PM
	005es17551:_MNH_5	11:00 AM	-
	005es17551:_MS_P_2	5:00 AM	2:00 PM
	005es17551:_MS_X_1	5:00 AM	2:00 PM
	005es17601:_MS_X_1	11:00 AM	-
	005es17627:_MN_P_2	-	1:00 PM
	005es17627:_MNHP_2	11:00 AM	-
	005es17627:_MN_X_1	11:00 AM	-
19 of 31	005es17722:_MN_Stn	11:00 AM	2:00 PM
	005es17722:_MNH_5	11:00 AM	-
	005es17774:_MN_Stn	11:00 AM	2:00 PM
	005es17774:_MNH_4	11:00 AM	-
	005es17774:_CN_O_1	-	12:00 PM
	005es17774:_CN_O_2	12:00 PM	12:00 PM
	005es17774:_CN_X_2	11:00 AM	-
	005es17775:_MS_P_1	10:00 AM	-
	005es17826:MMN_Stn	11:00 AM	2:00 PM
	005es17826:_MNH_4	11:00 AM	-
	005es17826:_MN_P_2	11:00 AM	12:00 PM
	005es17826:_MN_X_1	11:00 AM	-
	005es17826:_MS_X_1	11:00 AM	-
	005es17875:_MNH_4	11:00 AM	-
	005es17926:_MS_P_1	11:00 AM	-
	005es17926:_MSHP_1	-	1:00 PM
	005es17926:_MS_X_1	11:00 AM	-
	005es17927:MMN_Stn	11:00 AM	2:00 PM
	005es17927:_MNH_4	11:00 AM	-
	005es17927:_MN_P_2	11:00 AM	1:00 PM
	005es17927:_MNHP_3	11:00 AM	-
	005es17976:_MN_Stn	11:00 AM	2:00 PM
	005es17976:_MNH_5	11:00 AM	-
20 of 31	005es18017:_MN_Stn	11:00 AM	2:00 PM
	005es18017:_MNH_5	11:00 AM	-
	005es18066:_MN_Stn	11:00 AM	2:00 PM
	005es18066:_MNH_4	11:00 AM	-
	005es18066:_MN_X_2	11:00 AM	-
	005es18066:_MNHX_1	11:00 AM	-
	005es18106:_MS_P_1	11:00 AM	2:00 PM
	005es18115:_MN_Stn	11:00 AM	-
	005es18115:_MNHStn	-	2:00 PM
	005es18115:_MN_X_1	11:00 AM	12:00 PM
	005es18156:MMN_Stn	11:00 AM	2:00 PM
	005es18156:_MNH_4	11:00 AM	-
	005es18156:_MN_P_1	11:00 AM	-

	005es18170:_MNH_5	11:00 AM	-
	005es18170:_MN_P_1	11:00 AM	1:00 PM
	005es18204:_MN_Stn	11:00 AM	2:00 PM
	005es18204:_MNH_5	11:00 AM	-
	005es18204:_MN_X_1	11:00 AM	-
	005es18204:_MS_O_2	11:00 AM	-
	005es18211:_MS_P_3	11:00 AM	-
	005es18264:_MNH_4	11:00 AM	-
	005es18264:_MN_O_2	11:00 AM	1:00 PM
21 of 31	005es18322:_MN_Stn	11:00 AM	2:00 PM
	005es18322:_MNH_5	11:00 AM	-
	005es18382:_MS_P_3	11:00 AM	-
	005es18406:_MNH_4	11:00 AM	-
	005es18406:_MN_P_1	-	1:00 PM
	005es18507:_MNH_4	11:00 AM	-
	005es18548:_MNH_4	11:00 AM	-
22 of 31	005es18577:_MNH_4	11:00 AM	-
	005es18635:_MN_X_1	11:00 AM	-
	005es18707:_MNH_4	11:00 AM	-
	005es18739:_MNH_4	12:00 PM	-
23 of 31	005es18789:_MS_O_1	10:00 AM	12:00 PM
	005es18789:_MS_O_2	10:00 AM	12:00 PM
	005es18797:_MNH_4	11:00 AM	-
	005es18846:_MNH_5	11:00 AM	-
	005es18900:_MN_Stn	11:00 AM	2:00 PM
	005es18900:_MNH_4	11:00 AM	-
	005es18900:_MN_X_1	11:00 AM	-
	005es18931:_MN_P_2	11:00 AM	1:00 PM
	005es18932:MMN_Stn	11:00 AM	2:00 PM
	005es18932:_MNH_4	11:00 AM	-
	005es18944:_CS_X_1	5:00 AM	1:00 PM
	005es18998:_MN_Stn	11:00 AM	2:00 PM
	005es18998:_MNH_5	11:00 AM	-
24 of 31	005es19040:_MNH_5	11:00 AM	-
	005es19090:_MNH_5	11:00 AM	-
	005es19139:_MNH_5	11:00 AM	-
25 of 31	005es19188:_MNH_5	11:00 AM	-
	005es19226:MMS_Stn	-	1:00 PM
	005es19226:_MS_P_1	11:00 AM	-
	005es19255:MMS_Stn	-	1:00 PM
	005es19255:_MS_P_1	11:00 AM	-
	005es19277:MMN_Stn	11:00 AM	1:00 PM
	005es19277:_MNH_4	11:00 AM	-
	005es19277:_MN_P_2	11:00 AM	12:00 PM
	005es19277:_MNHP_2	11:00 AM	1:00 PM
	005es19303:_MN_Stn	11:00 AM	2:00 PM



	005es19303:_MNH_5	11:00 AM	2:00 PM
	005es19303:_MS_Stn	-	1:00 PM
	005es19352:_MN_Stn	11:00 AM	2:00 PM
	005es19352:_MNH_5	11:00 AM	2:00 PM
	005es19352:_MN_X_1	-	12:00 PM
	005es19352:MMS_Stn	-	1:00 PM
	005es19352:_MS_P_1	11:00 AM	-
26 of 31	005es19388:_MN_Stn	11:00 AM	2:00 PM
	005es19388:_MNH_4	11:00 AM	2:00 PM
	005es19388:_MN_X_1	11:00 AM	2:00 PM
	005es19388:_MS_Stn	-	1:00 PM
	005es19388:_MS_O_1	5:00 AM	1:00 PM
	005es19416:MMN_Stn	11:00 AM	2:00 PM
	005es19416:_MN_P_1	11:00 AM	-
	005es19416:_MS_Stn	-	1:00 PM
	005es19416:_MS_X_1	-	12:00 PM
	005es19417:_MN_P_1	-	12:00 PM
	005es19469:_MN_Stn	11:00 AM	2:00 PM
	005es19469:_MN_X_1	-	12:00 PM
	005es19469:MMS_Stn	-	1:00 PM
27 of 31	005es19843:_MN_Stn	11:00 AM	2:00 PM
	005es19843:_MN_O_1	11:00 AM	-
	005es19843:_MS_Stn	-	1:00 PM
	005es19900:_MN_Stn	11:00 AM	-
	005es19900:_MN_X_1	11:00 AM	2:00 PM
	005es19900:_MS_Stn	-	1:00 PM
	005es19900:_MS_O_2	-	2:00 PM
	005es19928:_MN_Stn	11:00 AM	-
	005es19928:_MS_X_1	11:00 AM	-
	005es19968:_MN_Stn	11:00 AM	-
	005es19968:_MS_Stn	-	1:00 PM
	005es20020:_MN_Stn	11:00 AM	-
	005es20020:_MS_Stn	-	1:00 PM
28 of 31	005es20066:_MN_Stn	11:00 AM	-
	005es20066:_MN_X_1	11:00 AM	-
	005es20066:_MN_X_2	11:00 AM	12:00 PM
	005es20066:MMS_Stn	-	1:00 PM
	005es20066:_MS_P_1	11:00 AM	2:00 PM
	005es20088:_MN_Stn	11:00 AM	-
	005es20088:_MS_Stn	-	1:00 PM
	005es20088:_MS_X_1	11:00 AM	-
	005es20137:_MN_Stn	11:00 AM	-
	005es20137:_MS_Stn	-	1:00 PM
	005es20182:_MN_Stn	11:00 AM	-
	005es20182:_MS_Stn	-	1:00 PM
	005es20234:_MN_Stn	11:00 AM	-

		005es20234:_MN_X_1	11:00 AM	-
		005es20234:MMS_Stn	-	1:00 PM
		005es20234:_MS_P_2	-	1:00 PM
		005es20259:_MN_Stn	11:00 AM	-
		005es20259:_MN_O_1	11:00 AM	-
		005es20259:_MS_Stn	-	1:00 PM
		005es20259:_MS_X_1	11:00 AM	-
	29 of 31	005es20313:_MN_Stn	11:00 AM	-
		005es20313:_MS_Stn	-	1:00 PM
		005es20369:_MN_Stn	11:00 AM	-
		005es20369:_MS_Stn	-	1:00 PM
		005es20424:_MN_Stn	11:00 AM	-
		005es20424:_MS_Stn	-	1:00 PM
		005es20478:_MN_Stn	11:00 AM	-
		005es20478:_MS_Stn	-	1:00 PM
		005es20533:_MN_Stn	11:00 AM	-
		005es20533:_MS_Stn	-	1:00 PM
	30 of 31	005es20587:_MN_Stn	11:00 AM	-
		005es20587:_MN_X_1	11:00 AM	2:00 PM
		005es20587:_MN_O_1	11:00 AM	-
		005es20587:MMS_Stn	-	1:00 PM
		005es20587:_MSHP_1	11:00 AM	-
		005es20587:_MS_P_1	11:00 AM	1:00 PM
		005es20667:_MN_Stn	11:00 AM	-
		005es20667:_MS_Stn	-	1:00 PM
		005es20720:_MN_Stn	11:00 AM	-
		005es20720:_MN_X_1	11:00 AM	12:00 PM
		005es20720:_MS_O_1	10:00 AM	12:00 PM
		005es20778:_MN_Stn	11:00 AM	-
		005es20778:_MS_Stn	-	1:00 PM
	31 of 31	005es20820:_MN_Stn	11:00 AM	-
		005es20820:_MS_Stn	-	1:00 PM
		005es20855:_MN_Stn	11:00 AM	-
		005es20855:_MN_X_1	11:00 AM	2:00 PM
		005es20855:_MS_O_1	-	1:00 PM
		005es20877:_MN_Stn	11:00 AM	-
		005es20933:_MN_Stn	11:00 AM	-
		005es21029:_MN_Stn	11:00 AM	-
		005es21029:_MN_X_1	11:00 AM	-
I-90	1 of 11	090es00261:_MW_O_1	5:00 AM	12:00 PM
	2 of 11	090es00341:_MEHP_2	11:00 AM	-
	4 of 11	090es00720:_ME_P_2	11:00 AM	-
	5 of 11	090es00912:_ME_O_1	11:00 AM	-
		090es00912:_MW_P_1	11:00 AM	-
		090es00961:_CE_X_1	11:00 AM	2:00 PM
		090es00996:_MW_P_2	11:00 AM	-

		090es00996:_MWHP_2	11:00 AM	-
		090es00996:_MW_X_2	-	12:00 PM
6 of 11		090es01090:_MEH_6	11:00 AM	-
		090es01143:_ME_Stn	11:00 AM	-
		090es01143:_MEH_4	11:00 AM	-
		090es01143:_CE__1	-	12:00 PM
		090es01143:_CE_O_1	11:00 AM	-
		090es01143:_MW_P_1	11:00 AM	12:00 PM
		090es01143:_CW_O_1	-	12:00 PM
		090es01143:_CW_O_2	11:00 AM	-
		090es01181:MME_Stn	11:00 AM	-
		090es01181:_MEH_4	11:00 AM	-
		090es01181:_ME_P_1	11:00 AM	-
		090es01181:_ME_P_2	11:00 AM	-
		090es01181:_CE_X_1	-	12:00 PM
7 of 11		090es01243:_ME_Stn	11:00 AM	-
		090es01243:_MEH_5	11:00 AM	-
		090es01289:_ME_Stn	11:00 AM	-
		090es01289:_MEH_5	11:00 AM	-
		090es01341:_ME_Stn	11:00 AM	-
		090es01341:_MEH_4	11:00 AM	-
		090es01397:_ME_Stn	11:00 AM	-
		090es01397:_MEH_4	11:00 AM	-
		090es01467:_ME_Stn	11:00 AM	-
		090es01467:_MEH_4	11:00 AM	-
8 of 11		090es01513:_ME_Stn	11:00 AM	-
		090es01577:_ME_Stn	11:00 AM	-
		090es01577:_MEHX_1	10:00 AM	-
		090es01577:_MW_P_1	11:00 AM	-
		090es01577:_MW_P_3	-	12:00 PM
		090es01577:_MW_X_1	11:00 AM	12:00 PM
		090es01635:_ME_Stn	11:00 AM	-
		090es01696:_ME_Stn	11:00 AM	-
		090es01748:_ME_Stn	11:00 AM	-
		090es01748:_ME_O_1	11:00 AM	-
		090es01790:_ME_Stn	11:00 AM	-
		090es01790:_ME_O_1	11:00 AM	-
9 of 11		090es01880:_ME_Stn	11:00 AM	-
		090es01941:_ME_Stn	11:00 AM	-
10 of 11		090es02481:_ME_Stn	11:00 AM	
SR 99	1 of 5	099es02316:_MS_X_2	11:00 AM	-
		099es02375:_MN_X_1	5:00 AM	1:00 PM
	2 of 5	099es02465:_MN_X_1	-	1:00 PM
		099es02465:_CN_O_1	11:00 AM	12:00 PM
		099es02465:_CN_X_1	5:00 AM	1:00 PM
		099es02465:_CS__1	11:00 AM	2:00 PM

		099es02465:_CS_X_1	-	1:00 PM
		099es02494:_CN_O_1	11:00 AM	-
		099es02494:_CN__1	11:00 AM	12:00 PM
		099es02494:_MS_Stn	11:00 AM	-
		099es02494:_CS__1	-	1:00 PM
		099es02494:_CS_O_1	11:00 AM	2:00 PM
		099es02494:_CS_X_1	11:00 AM	-
		099es02545:_MN_O_1	11:00 AM	-
		099es02585:_MS_Stn	11:00 AM	-
		099es02585:_MS_X_1	-	12:00 PM
	4 of 5	099es03271:_MN_O_1	11:00 AM	-
SR 167	1 of 6	167es01127:_MN_Stn	5:00 AM	1:00 PM
		167es01127:_MNH__3	5:00 AM	-
		167es01127:_MS_Stn	11:00 AM	1:00 PM
		167es01169:_MN_Stn	5:00 AM	1:00 PM
		167es01169:_MNH__3	5:00 AM	-
		167es01169:_MS_Stn	11:00 AM	1:00 PM
		167es01215:_MN_Stn	5:00 AM	1:00 PM
		167es01215:_MN_X_1	5:00 AM	1:00 PM
		167es01215:MMS_Stn	11:00 AM	1:00 PM
		167es01215:_MSH__3	11:00 AM	2:00 PM
		167es01215:_MS_P_1	-	1:00 PM
		167es01245:MMN_Stn	5:00 AM	1:00 PM
		167es01245:_MN_P_1	-	2:00 PM
		167es01245:_MS_Stn	11:00 AM	1:00 PM
		167es01245:_MSH__3	11:00 AM	2:00 PM
		167es01245:_MS_X_1	11:00 AM	-
		167es01287:_MN_Stn	5:00 AM	1:00 PM
		167es01287:_MS_Stn	11:00 AM	1:00 PM
		167es01287:_MSH__3	11:00 AM	2:00 PM
	2 of 6	167es01327:_MN_Stn	5:00 AM	1:00 PM
		167es01327:_MS_Stn	11:00 AM	1:00 PM
		167es01327:_MSH__3	11:00 AM	2:00 PM
		167es01375:_MN_Stn	5:00 AM	1:00 PM
		167es01375:MMS_Stn	11:00 AM	1:00 PM
		167es01375:_MSH__3	11:00 AM	2:00 PM
		167es01375:_MSHP_1	11:00 AM	2:00 PM
		167es01375:_MSHP_4	11:00 AM	8:00 PM
		167es01375:_MS_P_2	-	12:00 PM
		167es01375:_MS_P_3	11:00 AM	8:00 PM
		167es01375:_MS_X_1	11:00 AM	-
		167es01431:_MN_Stn	5:00 AM	1:00 PM
		167es01431:_MNH__3	5:00 AM	1:00 PM
		167es01431:_MN_O_2	11:00 AM	2:00 PM
		167es01431:_MS_Stn	11:00 AM	1:00 PM
		167es01431:_MSH__4	11:00 AM	2:00 PM

	167es01431:_MS_X_1	11:00 AM	2:00 PM
	167es01476:_MN_Stn	5:00 AM	2:00 PM
	167es01476:_MNH_4	5:00 AM	1:00 PM
	167es01476:_MN_O_1	5:00 AM	2:00 PM
	167es01476:_MS_Stn	11:00 AM	2:00 PM
	167es01476:_MSH_3	11:00 AM	2:00 PM
	167es01535:_MN_Stn	5:00 AM	2:00 PM
	167es01535:_MNH_3	5:00 AM	-
	167es01535:_MS_Stn	11:00 AM	2:00 PM
	167es01535:_MSH_4	11:00 AM	2:00 PM
	167es01565:_MN_Stn	5:00 AM	1:00 PM
	167es01565:_MNH_3	5:00 AM	-
	167es01565:MMS_Stn	11:00 AM	2:00 PM
	167es01565:_MSH_4	11:00 AM	2:00 PM
	167es01565:_MS_P_1	11:00 AM	-
	167es01565:_MS_P_2	11:00 AM	-
	167es01565:_MSHP_2	11:00 AM	-
	167es01586:MMN_Stn	12:00 PM	-
	167es01586:_MNH_3	12:00 PM	-
	167es01586:_MN_P_1	11:00 AM	-
	167es01586:_MNHP_1	-	2:00 PM
	167es01586:_MS_Stn	11:00 AM	2:00 PM
	167es01586:_MSH_4	11:00 AM	-
3 of 6	167es01628:_MN_Stn	5:00 AM	1:00 PM
	167es01628:_MNH_3	5:00 AM	-
	167es01628:_MS_Stn	11:00 AM	2:00 PM
	167es01628:_MSH_3	11:00 AM	-
	167es01687:_MN_Stn	5:00 AM	2:00 PM
	167es01687:_MNH_3	5:00 AM	1:00 PM
	167es01687:_MS_Stn	11:00 AM	2:00 PM
	167es01687:_MSH_3	11:00 AM	-
	167es01738:_MN_Stn	5:00 AM	2:00 PM
	167es01738:_MNH_3	5:00 AM	1:00 PM
	167es01738:_MS_Stn	11:00 AM	1:00 PM
	167es01738:_MSH_3	11:00 AM	-
	167es01784:MMS_Stn	11:00 AM	1:00 PM
	167es01784:_MSH_3	11:00 AM	-
	167es01784:_MS_P_1	-	1:00 PM
	167es01799:MMN_Stn	5:00 AM	1:00 PM
	167es01799:_MNH_3	5:00 AM	1:00 PM
	167es01799:_MNHP_1	-	1:00 PM
	167es01799:_MN_P_1	11:00 AM	-
	167es01849:_MN_Stn	5:00 AM	1:00 PM
	167es01849:_MNH_3	-	1:00 PM
	167es01849:_MS_Stn	11:00 AM	1:00 PM
	167es01849:_MSH_3	11:00 AM	-

4 of 6	167es01901:_MN_Stn	5:00 AM	1:00 PM
	167es01901:_MNH_3	5:00 AM	1:00 PM
	167es01901:_MS_Stn	11:00 AM	1:00 PM
	167es01901:_MSH_3	11:00 AM	-
	167es01948:MMS_Stn	11:00 AM	1:00 PM
	167es01948:_MSH_3	11:00 AM	-
	167es01948:_MS_P_1	-	7:00 PM
	167es01948:_MS_P_2	11:00 AM	12:00 PM
	167es01948:_MS_X_1	11:00 AM	-
	167es01974:MMN_Stn	5:00 AM	1:00 PM
	167es01974:_MNH_3	5:00 AM	1:00 PM
	167es01974:_MNHP_1	-	12:00 PM
	167es02019:_MN_Stn	5:00 AM	1:00 PM
	167es02019:_MNH_3	5:00 AM	1:00 PM
	167es02019:_MS_Stn	11:00 AM	1:00 PM
	167es02019:_MSH_3	11:00 AM	-
	167es02139:MMN_Stn	5:00 AM	2:00 PM
	167es02139:_MNH_3	5:00 AM	1:00 PM
	167es02139:_MNHP_1	-	1:00 PM
	167es02139:_MN_P_1	11:00 AM	-
167es02139:_MS_X_1	11:00 AM	-	
5 of 6	167es02189:_MN_Stn	5:00 AM	1:00 PM
	167es02189:_MNH_3	5:00 AM	1:00 PM
	167es02189:_MS_Stn	11:00 AM	1:00 PM
	167es02189:_MSH_3	11:00 AM	-
	167es02226:MMS_Stn	11:00 AM	2:00 PM
	167es02226:_MSH_3	11:00 AM	-
	167es02226:_MSHP_1	11:00 AM	-
	167es02234:MMN_Stn	5:00 AM	1:00 PM
	167es02234:_MNH_3	5:00 AM	1:00 PM
	167es02234:_MN_P_1	11:00 AM	-
	167es02293:_MN_Stn	5:00 AM	1:00 PM
	167es02293:_MNH_3	5:00 AM	1:00 PM
	167es02293:_MS_Stn	11:00 AM	1:00 PM
	167es02293:_MSH_3	11:00 AM	-
	167es02342:_MN_Stn	5:00 AM	1:00 PM
	167es02342:_MNH_3	5:00 AM	1:00 PM
	167es02342:_MS_Stn	11:00 AM	1:00 PM
	167es02342:_MSH_3	11:00 AM	-
	167es02390:_MN_Stn	5:00 AM	1:00 PM
	167es02390:_MNH_3	5:00 AM	1:00 PM
167es02390:_MS_Stn	11:00 AM	1:00 PM	
167es02390:_MSH_3	11:00 AM	-	
6 of 6	167es02445:MMS_Stn	-	1:00 PM
	167es02445:_MSH_3	11:00 AM	-
	167es02445:_MSHP_1	11:00 AM	2:00 PM

		167es02445:_MS_P_1	11:00 AM	12:00 PM
		167es02445:_MS_X_1	11:00 AM	-
		167es02461:MMN_Stn	5:00 AM	1:00 PM
		167es02461:_MNH_3	5:00 AM	1:00 PM
		167es02461:_MN_P_1	11:00 AM	-
		167es02507:_MN_Stn	5:00 AM	1:00 PM
		167es02507:_MS_Stn	-	2:00 PM
		167es02507:_MSH_4	11:00 AM	-
		167es02562:_MN_Stn	5:00 AM	1:00 PM
		167es02562:_MS_Stn	-	2:00 PM
		167es02562:_MSH_4	11:00 AM	-
		167es02614:_MN_Stn	-	1:00 PM
		167es02614:_MNHX_1	5:00 AM	-
		167es02614:_MN_X_2	5:00 AM	2:00 PM
		167es02614:_MS_Stn	11:00 AM	2:00 PM
		167es02614:_MSHO_2	11:00 AM	-
		167es02614:_MS_O_1	11:00 AM	-
I-405	1 of 16	405es00011:_MN__1	-	1:00 PM
		405es00011:_MNH_O_1	11:00 AM	-
		405es00011:_MN_O_1	11:00 AM	2:00 PM
		405es00011:_MN_O_2	5:00 AM	-
		405es00011:_MS_Stn	-	2:00 PM
		405es00011:_MS_X_1	11:00 AM	-
		405es00011:_MS_X_2	5:00 AM	1:00 PM
		405es00044:_MN_Stn	-	2:00 PM
		405es00044:_MNH_4	11:00 AM	-
		405es00044:_MN_O_1	11:00 AM	-
		405es00044:_MS_Stn	-	1:00 PM
		405es00086:MMS_Stn	-	1:00 PM
		405es00086:_MS_P_1	11:00 AM	-
		405es00086:_MS_P_2	11:00 AM	-
		405es00086:_MS_X_1	11:00 AM	-
		405es00092:MMN_Stn	11:00 AM	-
		405es00092:_MNH_4	11:00 AM	-
		405es00092:_MN_P_1	11:00 AM	-
		405es00092:_MN_P_2	11:00 AM	-
		405es00092:_MN_X_1	-	2:00 PM
		405es00139:_MN_Stn	11:00 AM	-
		405es00139:_MNH_4	11:00 AM	-
		405es00139:_MS_Stn	-	1:00 PM
	2 of 16	405es00171:_MN_Stn	11:00 AM	-
		405es00171:_MNH_4	11:00 AM	-
		405es00171:_MS_Stn	-	1:00 PM
		405es00221:_MN_Stn	11:00 AM	-
		405es00221:_MNH_3	10:00 AM	-
		405es00221:_CN_O_1	11:00 AM	-

	405es00221:_CN_X_1	11:00 AM	-
	405es00221:MMS_Stn	-	1:00 PM
	405es00221:_MS_P_1	-	1:00 PM
	405es00221:_MS_P_2	-	1:00 PM
	405es00221:_MS_O_1	5:00 AM	1:00 PM
	405es00221:_MS_X_1	-	12:00 PM
	405es00221:_MS_X_2	-	2:00 PM
	405es00268:MMN_Stn	11:00 AM	-
	405es00268:_MNHO_2	5:00 AM	-
	405es00268:_MN_O_1	11:00 AM	-
	405es00268:_MN_P_2	5:00 AM	1:00 PM
	405es00268:_MS_Stn	-	1:00 PM
	405es00268:_MSH_3	-	2:00 PM
	405es00268:_MSHX_2	11:00 AM	-
	405es00294:MMN_Stn	5:00 AM	-
	405es00294:_MNH_4	5:00 AM	-
	405es00294:_MN_P_1	5:00 AM	1:00 PM
	405es00294:_MN_P_2	5:00 AM	-
	405es00294:_MS_Stn	-	1:00 PM
	405es00342:_MN_Stn	11:00 AM	-
	405es00342:_MS_Stn	-	2:00 PM
3 of 16	405es00391:_MN_Stn	5:00 AM	-
	405es00391:_MN_X_1	11:00 AM	-
	405es00391:MMS_Stn	-	2:00 PM
	405es00391:_MSH_3	11:00 AM	-
	405es00391:_MS_P_1	-	2:00 PM
	405es00391:_MS_P_2	-	1:00 PM
	405es00412:MMN_Stn	5:00 AM	-
	405es00412:_MN_P_1	5:00 AM	12:00 PM
	405es00473:MMN_Stn	5:00 AM	-
	405es00473:_MN_P_1	-	2:00 PM
	405es00473:_MS_Stn	2:00 PM	-
	405es00473:_MSH_3	11:00 AM	-
	405es00473:_MS_X_1	11:00 AM	-
	405es00532:MMS_Stn	-	12:00 PM
	405es00532:_MSH_3	11:00 AM	-
	405es00532:_MSHP_1	-	2:00 PM
	405es00532:_MS_X_1	-	1:00 PM
	405es00532:_MS_X_2	11:00 AM	7:00 PM
	405es00532:_MS_P_1	1:00 PM	-
	405es00536:MMN_Stn	5:00 AM	2:00 PM
	405es00536:_MNHP_1	-	2:00 PM
	405es00536:_MN_P_1	-	2:00 PM
	405es00536:_MN_X_1	11:00 AM	-
	405es00608:_MN_Stn	5:00 AM	2:00 PM
	405es00608:_MS_Stn	-	12:00 PM



	405es00608:_MSH_3	11:00 AM	2:00 PM
4 of 16	405es00646:MMS_Stn	-	12:00 PM
	405es00646:_MSH_3	11:00 AM	-
	405es00646:_MS_X_1	11:00 AM	-
	405es00656:MMN_Stn	5:00 AM	2:00 PM
	405es00656:_MNHP_1	-	2:00 PM
	405es00656:_MN_P_1	-	2:00 PM
	405es00656:_MN_X_1	11:00 AM	-
	405es00700:_MN_Stn	5:00 AM	-
	405es00700:_MS_Stn	-	12:00 PM
	405es00700:_MSH_3	11:00 AM	2:00 PM
	405es00740:MMS_Stn	-	12:00 PM
	405es00740:_MSH_3	11:00 AM	2:00 PM
	405es00740:_MS_X_1	11:00 AM	-
	405es00745:MMN_Stn	5:00 AM	2:00 PM
	405es00745:_MN_O_1	-	12:00 PM
	405es00745:_MN_P_1	-	2:00 PM
	405es00745:_MN_P_2	-	12:00 PM
	405es00745:_MN_X_1	11:00 AM	-
	405es00803:_MN_Stn	-	2:00 PM
	405es00803:_MS_Stn	11:00 AM	12:00 PM
	405es00803:_MSH_3	11:00 AM	2:00 PM
	405es00840:_MN_Stn	-	2:00 PM
	405es00840:_MS_Stn	11:00 AM	12:00 PM
	405es00840:_MSH_3	11:00 AM	2:00 PM
5 of 16	405es00890:_MN_Stn	-	2:00 PM
	405es00890:_MS_Stn	-	12:00 PM
	405es00890:_MSH_3	11:00 AM	2:00 PM
	405es00921:MMS_Stn	11:00 AM	12:00 PM
	405es00921:_MSH_3	11:00 AM	2:00 PM
	405es00921:_MN_X_1	11:00 AM	-
	405es00921:_MS_P_2	-	12:00 PM
	405es00936:MMN_Stn	-	2:00 PM
	405es00936:_MN_P_3	-	12:00 PM
	405es00936:_MS_X_1	11:00 AM	7:00 PM
	405es00975:_MS_Stn	11:00 AM	12:00 PM
	405es00975:_MSH_3	11:00 AM	2:00 PM
	405es01013:_MN_X_1	11:00 AM	-
	405es01013:MMS_Stn	11:00 AM	12:00 PM
	405es01013:_MSH_3	11:00 AM	2:00 PM
	405es01013:_MS_P_1	11:00 AM	-
	405es01013:_MS_P_2	11:00 AM	-
	405es01031:_MS_X_1	-	12:00 PM
	405es01031:_MS_X_2	11:00 AM	-
	405es01031:_MS_X_3	11:00 AM	7:00 PM
6 of 16	405es01079:_MN_Stn	-	2:00 PM

	405es01079:_MS_Stn	11:00 AM	12:00 PM
	405es01079:_MSH__3	11:00 AM	2:00 PM
	405es01079:_MS_O_1	11:00 AM	-
	405es01079:_MS_O_2	-	12:00 PM
	405es01128:_MN_Stn	-	2:00 PM
	405es01128:_MS_Stn	11:00 AM	12:00 PM
	405es01128:_MSH__3	11:00 AM	2:00 PM
	405es01178:_MN_Stn	-	2:00 PM
	405es01178:_MS_Stn	11:00 AM	12:00 PM
	405es01178:_MSH__6	11:00 AM	2:00 PM
	405es01228:_MN_Stn	-	2:00 PM
	405es01229:_MS_Stn	11:00 AM	12:00 PM
	405es01229:_MSH__6	11:00 AM	2:00 PM
7 of 16	405es01272:MMS_Stn	-	1:00 PM
	405es01272:_MSH__5	-	2:00 PM
	405es01272:_MSHP_1	11:00 AM	-
	405es01272:_MS_P_1	11:00 AM	-
	405es01272:_MS_P_2	11:00 AM	-
	405es01290:MMN_Stn	-	2:00 PM
	405es01290:_MN_X_2	-	12:00 PM
	405es01331:_MN_Stn	-	2:00 PM
8 of 16	405es01333:MMS_Stn	-	1:00 PM
	405es01333:_MSH__4	-	2:00 PM
	405es01333:_MS_P_1	11:00 AM	2:00 PM
	405es01333:_MS_P_2	11:00 AM	2:00 PM
	405es01333:_MS_P_3	11:00 AM	12:00 PM
	405es01333:_MSHP_4	11:00 AM	2:00 PM
	405es01333:_MS_X_1	-	12:00 PM
	405es01333:_CS_O_1	11:00 AM	2:00 PM
	405es01333:_CS_X_1	-	12:00 PM
	405es01333:_CS_X_3	-	12:00 PM
	405es01333:_MSRA_1	11:00 AM	2:00 PM
	405es01333:_MSRA_2	11:00 AM	2:00 PM
	405es01360:MMN_Stn	-	2:00 PM
	405es01360:_MN_P_1	11:00 AM	-
	405es01360:_MN_X_1	-	12:00 PM
	405es01360:_MN_X_2	-	12:00 PM
	405es01360:_MSHO_1	11:00 AM	-
	405es01392:_MNH__6	11:00 AM	-
	405es01392:_MNHO_1	11:00 AM	-
	405es01392:_CN_O_1	11:00 AM	-
	405es01392:_CN_O_2	11:00 AM	-
	405es01392:_CN_X_1	-	12:00 PM
	405es01392:_CN__1	-	12:00 PM
	405es01392:DCN__1	11:00 AM	-
	405es01392:_MS_Stn	-	2:00 PM

	405es01392:_MSH__4	-	2:00 PM
9 of 16	405es01360:_MN_X_1	-	12:00 PM
	405es01360:_MN_X_2	-	12:00 PM
	405es01427:_MN_Stn	11:00 AM	2:00 PM
	405es01427:_MS_Stn	-	1:00 PM
	405es01427:_MSH__5	-	2:00 PM
	405es01463:MMN_Stn	11:00 AM	2:00 PM
	405es01463:_MN_P_1	11:00 AM	-
	405es01463:_MN_P_2	11:00 AM	2:00 PM
	405es01463:_MNHStn	11:00 AM	-
	405es01463:_MN_M_1	11:00 AM	-
	405es01465:_MS_Stn	-	1:00 PM
	405es01508:_MN_Stn	11:00 AM	2:00 PM
	405es01508:_MN_O_1	11:00 AM	2:00 PM
	405es01508:_MS_Stn	-	1:00 PM
	405es01563:_MN_Stn	11:00 AM	2:00 PM
	405es01563:_MNHStn	11:00 AM	-
	405es01563:_MS_Stn	-	12:00 PM
	405es01612:_MN_Stn	11:00 AM	2:00 PM
	405es01612:_MNHStn	11:00 AM	-
	405es01612:_MS_Stn	-	12:00 PM
10 of 16	405es01667:_MN_Stn	11:00 AM	2:00 PM
	405es01667:_MNHStn	11:00 AM	-
	405es01667:_MS_Stn	-	12:00 PM
	405es01723:_MN_Stn	11:00 AM	12:00 PM
	405es01723:_MNHStn	11:00 AM	-
	405es01723:_MNBX_3	4:00 AM	-
	405es01723:MMS_Stn	12:00 PM	-
	405es01723:_MS_P_1	11:00 AM	2:00 PM
	405es01723:_CSB__1	5:00 AM	1:00 PM
	405es01749:MMN_Stn	11:00 AM	2:00 PM
	405es01749:_MNHStn	11:00 AM	-
	405es01749:_MN_P_2	11:00 AM	-
405es01749:_MS_Stn	12:00 PM	-	
11 of 16	405es01799:_MN_Stn	11:00 AM	2:00 PM
	405es01799:_MNHStn	11:00 AM	-
	405es01799:_CN_X_1	11:00 AM	12:00 PM
	405es01799:MMS_Stn	-	12:00 PM
	405es01799:_CS_P_1	11:00 AM	2:00 PM
	405es01799:_CS_P_2	11:00 AM	-
	405es01799:_CS__1	11:00 AM	2:00 PM
	405es01823:MMN_Stn	11:00 AM	2:00 PM
	405es01823:_MNHStn	11:00 AM	-
	405es01823:_CNHP_2	11:00 AM	-
	405es01823:_CN_P_1	11:00 AM	2:00 PM
405es01823:_CN_P_2	11:00 AM	7:00 PM	

	405es01823:_CN_X_1	-	12:00 PM
	405es01823:_MS_Stn	-	12:00 PM
	405es01870:_MN_Stn	11:00 AM	2:00 PM
	405es01870:_MNHStn	11:00 AM	-
	405es01870:_MS_Stn	-	12:00 PM
	405es01921:_MN_Stn	11:00 AM	2:00 PM
	405es01921:_MNHStn	11:00 AM	-
	405es01921:_MS_Stn	-	12:00 PM
12 of 16	405es01971:_MN_Stn	11:00 AM	2:00 PM
	405es01971:_MNHStn	11:00 AM	-
	405es01971:_MN_X_1	-	1:00 PM
	405es01972:MMS_Stn	-	12:00 PM
	405es01972:_MSHP_2	-	12:00 PM
	405es01972:_MS_P_1	11:00 AM	-
	405es01972:_MS_P_2	11:00 AM	-
	405es02022:_MN_Stn	11:00 AM	2:00 PM
	405es02022:_MNHStn	11:00 AM	2:00 PM
	405es02022:MMS_Stn	-	12:00 PM
	405es02022:_MSHP_2	-	12:00 PM
	405es02022:_MS_P_1	11:00 AM	-
	405es02022:_MS_P_2	-	12:00 PM
	405es02022:_MS_P_3	11:00 AM	-
	405es02047:MMN_Stn	11:00 AM	2:00 PM
	405es02047:_MNHStn	11:00 AM	-
	405es02047:_MNHX_3	11:00 AM	-
	405es02047:_MN_P_1	11:00 AM	-
	405es02047:_MN_P_2	11:00 AM	2:00 PM
	405es02047:_MN_P_3	11:00 AM	1:00 PM
	405es02047:_MN_X_1	-	1:00 PM
	405es02047:_MN_X_2	11:00 AM	-
	405es02047:_MS_Stn	-	12:00 PM
13 of 16	405es02093:_MN_Stn	11:00 AM	2:00 PM
	405es02093:_MNHStn	11:00 AM	-
	405es02093:_MS_Stn	-	12:00 PM
	405es02093:_MSHX_1	-	1:00 PM
	405es02136:_MN_Stn	11:00 AM	2:00 PM
	405es02136:_MNHStn	11:00 AM	-
	405es02136:_MS_Stn	-	12:00 PM
	405es02183:_MN_Stn	11:00 AM	-
	405es02183:_MNH__5	11:00 AM	-
	405es02183:_MS_Stn	-	12:00 PM
	405es02183:_MSHStn	-	2:00 PM
	405es02231:_MN_Stn	11:00 AM	-
	405es02231:_MNH__5	11:00 AM	-
	405es02231:MMS_Stn	-	12:00 PM
	405es02231:_MS_P_1	-	12:00 PM

	405es02273:_MN_X_1	11:00 AM	2:00 PM
	405es02273:_MN_X_2	11:00 AM	-
	405es02273:_MS_Stn	-	2:00 PM
	405es02273:_MSH_4	-	2:00 PM
	405es02273:_MS_X_2	11:00 AM	-
	405es02301:MMN_Stn	11:00 AM	-
	405es02301:_MNH_3	11:00 AM	-
	405es02301:_MN_X_1	11:00 AM	-
14 of 16	405es02301:_MSB_1	-	10:00 PM
	405es02351:_MN_Stn	11:00 AM	-
	405es02351:_MNH_3	11:00 AM	-
	405es02351:_CN_X_1	11:00 AM	-
	405es02351:MMS_O_2	-	12:00 PM
	405es02369:MMN_Stn	11:00 AM	-
	405es02369:_MNH_3	11:00 AM	-
	405es02369:_MS_X_1	11:00 AM	-
	405es02393:_MN_Stn	11:00 AM	-
	405es02393:_MNH_3	11:00 AM	-
	405es02393:_CN_O_1	11:00 AM	-
	405es02393:_MS_X_2	11:00 AM	-
	405es02439:_MN_Stn	11:00 AM	-
	405es02439:_MNH_3	11:00 AM	-
	405es02439:MMS_Stn	-	2:00 PM
	405es02465:MMN_Stn	11:00 AM	-
	405es02465:_MNH_3	11:00 AM	-
	405es02465:_MNHP_1	11:00 AM	-
	405es02465:_MN_P_1	11:00 AM	-
	405es02465:_MS_Stn	-	2:00 PM
	405es02465:_MS_X_1	10:00 AM	-
	405es02468:_MN_P_1	11:00 AM	2:00 PM
15 of 16	405es02517:_MN_Stn	11:00 AM	-
	405es02517:_MNH_4	11:00 AM	-
	405es02517:_MS_Stn	-	2:00 PM
	405es02517:_MSH_3	-	2:00 PM
	405es02556:_MS_Stn	-	2:00 PM
	405es02556:_MSH_3	-	2:00 PM
	405es02568:_MN_Stn	11:00 AM	-
	405es02568:_MNH_4	11:00 AM	-
	405es02616:_MN_Stn	11:00 AM	-
	405es02616:_MNH_4	11:00 AM	-
	405es02616:_MS_Stn	-	2:00 PM
	405es02616:_MSH_3	-	2:00 PM
	405es02662:_MN_Stn	11:00 AM	-
	405es02662:_MNH_3	11:00 AM	-
	405es02662:MMS_Stn	-	2:00 PM
	405es02662:_MSH_3	-	2:00 PM

		405es02662:_MS_P_1	11:00 AM	-
		405es02662:_MSHP_1	-	2:00 PM
		405es02663:_MS_P_2	11:00 AM	-
		405es02687:_MNHP_1	11:00 AM	-
		405es02687:_MN_P_1	11:00 AM	-
		405es02688:MMN_Stn	11:00 AM	-
		405es02688:_MNH_3	11:00 AM	-
		405es02688:_MNHP_1	11:00 AM	-
		405es02688:_MS_Stn	-	2:00 PM
		405es02688:_MSH_3	-	2:00 PM
		405es02744:_MN_Stn	11:00 AM	1:00 PM
		405es02744:_MNH_3	11:00 AM	-
		405es02744:_MSH_3	-	2:00 PM
	16 of 16	405es02796:_MN_Stn	11:00 AM	1:00 PM
		405es02796:_MNH_3	11:00 AM	-
		405es02796:_MSH_3	-	2:00 PM
		405es02853:_MN_Stn	11:00 AM	1:00 PM
		405es02853:_MNH_3	11:00 AM	-
		405es02853:_MS_Stn	-	2:00 PM
		405es02853:_MSH_3	-	2:00 PM
		405es02898:_MN_Stn	11:00 AM	1:00 PM
		405es02898:_MNH_3	11:00 AM	-
		405es02898:_MS_Stn	-	2:00 PM
		405es02898:_MSH_4	-	2:00 PM
		405es02953:_MN_Stn	11:00 AM	2:00 PM
		405es02953:_MNH_4	11:00 AM	-
		405es02953:_MS_Stn	-	2:00 PM
		405es02953:_MSH_5	-	2:00 PM
		405es03006:_MN_Stn	11:00 AM	-
SR 509	3 of 4	509es02902:_MS_Stn	11:00 AM	-
		509es02947:_MS_Stn	11:00 AM	-
		509es02947:_MS_O_1	11:00 AM	-
		509es02947:_MS_X_1	11:00 AM	-
	4 of 4	509es02976:_MN_X_1	11:00 AM	-
		509es02976:_MN_O_1	11:00 AM	-
		509es02976:_MS_Stn	11:00 AM	-
		509es02976:_MSH_3	11:00 AM	-
		509es02976:_MS_X_1	11:00 AM	-
SR 518	2 of 3	518es00228:MME_Stn	11:00 AM	8:00 PM
		518es00228:_ME_P_2	11:00 AM	12:00 PM
		518es00228:_ME_X_2	-	10:00 PM
		518es00247:_ME_O_2	11:00 AM	9:00 PM
		518es00247:_ME_O_3	11:00 AM	8:00 PM
		518es00247:_MW_X_1	11:00 AM	-
		518es00247:_MW_X_2	11:00 AM	1:00 PM
		518es00247:_MW_X_3	5:00 AM	8:00 PM

		518es00247:_MW_X_4	-	1:00 PM
		518es00267:MME_Stn	11:00 AM	1:00 PM
		518es00267:_ME_P_2	-	12:00 PM
	3 of 3	518es00300:_ME_Stn	11:00 AM	1:00 PM
		518es00341:_ME_Stn	11:00 AM	1:00 PM
		518es00341:_ME_X_1	11:00 AM	-
		518es00341:_MW_O_1	11:00 AM	-
SR 520	1 of 6	520es00104:_MW_O_1	11:00 AM	-
	2 of 6	520es00448:_ME_X_1	11:00 AM	-
	4 of 6	520es00684:_MW_X_2	-	7:00 PM
		520es00746:_MW_P_1	11:00 AM	-
		520es00746:_MW_P_1	-	12:00 PM
	5 of 6	520es00911:_MWH_P_4	-	2:00 PM
520es00911:_MWH_1		-	2:00 PM	
520es00911:MMW_Stn		-	2:00 PM	
520es01001:_CW_P_2		11:00 AM	-	
520es01031:_CE_P_2		11:00 AM	-	
6 of 6	520es01299:_ME_O_1	11:00 AM	-	
	520es01265:_MW_P_1	-	2:00 PM	
SR 522	3 of 5	522es01326:_MW_Stn	-	12:00 PM
		522es01400:_MW_Stn	-	12:00 PM
		522es01400:_MW_X_1	-	12:00 PM
		522es01400:_ME_O_1	11:00 AM	-
		522es01400:_ME_Stn	11:00 AM	-
		522es01400:_ME_X_1	11:00 AM	-
		522es01326:_ME_Stn	11:00 AM	-
	4 of 5	522es01840:UMW_Stn	-	12:00 PM
		522es01840:_MW_P_1	-	12:00 PM
		522es01840:UME_Stn	11:00 AM	-
		522es01895:_ME_X_1	11:00 AM	-
		522es01895:_ME_P_1	3:00 AM	-
	5 of 5	522es02030:UMW_Stn	-	2:00 PM
		522es02086:_MW_Stn	-	2:00 PM
		522es02135:_MW_Stn	-	2:00 PM
		522es02187:_MW_Stn	-	2:00 PM
		522es02237:_MW_Stn	-	2:00 PM
		522es02289:_MW_Stn	-	2:00 PM
		522es02289:_MW_O_1	-	2:00 PM
		522es02333:_MW_Stn	-	12:00 PM
		522es02381:_MW_Stn	-	12:00 PM
522es02432:_MW_Stn		-	12:00 PM	
522es02474:_MW__1		-	12:00 PM	
522es02432:_ME_X_1		11:00 AM	-	
522es02432:_ME_Stn		11:00 AM	-	
522es02381:_ME_Stn		11:00 AM	-	
522es02333:_ME_O_1	-	2:00 PM		

		522es02333:_ME_Stn	11:00 AM	-
		522es02289:_ME_Stn	11:00 AM	-
		522es02237:_ME_Stn	11:00 AM	-
		522es02187:_ME_Stn	11:00 AM	-
		522es02135:_ME_Stn	11:00 AM	-
		522es02086:_ME_Stn	11:00 AM	-
		522es02030:UME_Stn	11:00 AM	-
SR 525	1 of 2	525es00056:_MS_O_1	11:00 AM	-
		525es00096:_MN_O_1	11:00 AM	-
		525es00096:_MN_X_1	11:00 AM	-
	2 of 2	525es00252:_MN_O_1	11:00 AM	-
		525es00252:_MN_X_1	11:00 AM	-
SR 526	2 of 2	526es00357:_ME_Stn	11:00 AM	2:00 PM
		526es00357:_MW_Stn	5:00 AM	1:00 PM
SR 599	1 of 2	599es00045:_MS_O_1	11:00 AM	2:00 PM
		599es00045:_MS_Stn	11:00 AM	2:00 PM
	2 of 2	599es00045:_MS_Stn	11:00 AM	2:00 PM
		599es00169:_MN_X_1	-	1:00 PM
		599es00169:_MS_O_1	11:00 AM	2:00 PM
		599es00169:_MS_Stn	11:00 AM	2:00 PM